

ROGERS LABS, INC.

4405 West 259th Terrace
Louisburg, KS 66053
Phone / Fax (913) 837-3214

CFR47, PART 15C - Intentional Radiators
CFR47 Paragraph 15.247 and
Industry Canada RSS-247 Issue 2 and RSS-GEN Issue 5
Application For Grant of Certification

Model: A04117

2402-2480 MHz (DTS)
Broadband Digital Transmission System

FCC ID: IPH-04117

IC: 1792A-04117

Garmin International, Inc.

1200 East 151st Street
Olathe, KS 66062

FCC Designation: US5305
ISED Registration: 3041A-1

Test Report Number: 200924

Test Date: September 24, 2020

Authorized Signatory: *Scot D. Rogers*
Scot D. Rogers

This report shall not be reproduced except in full, without the written approval of the laboratory.
This report must not be used by the client to claim product certification, approval, or endorsement by NVLAP, NIST, or any agency of the U.S. Government.

Rogers Labs, Inc.	Garmin International, Inc.	SN's: 3342384349 / 3342384330
4405 West 259 th Terrace	Model: A04117	FCC ID: IPH-04117
Louisburg, KS 66053	Test: 200924	IC: 1792A-04117
Phone/Fax: (913) 837-3214	Test to: CFR47 15C, RSS-Gen RSS-247	Date: November 23, 2020
Revision 1	File: A04117 DTS TstRpt 200924	Page 1 of 66

Table of Contents

TABLE OF CONTENTS.....	2
REVISIONS.....	4
EXECUTIVE SUMMARY	5
OPINION / INTERPRETATION OF RESULTS	5
EQUIPMENT TESTED.....	8
Equipment Function	9
Equipment Configuration.....	10
APPLICATION FOR CERTIFICATION.....	11
APPLICABLE STANDARDS & TEST PROCEDURES	12
TESTING PROCEDURES	12
AC Line Conducted Emission Test Procedure	12
Radiated Emission Test Procedure.....	12
Antenna Port Conducted Emission Test Procedure.....	13
Diagram 1 Test arrangement for Conducted emissions	14
Diagram 2 Test arrangement for radiated emissions of tabletop equipment.....	15
Diagram 3 Test arrangement for radiated emissions tested on Open Area Test Site (OATS).....	16
Diagram 4 Test arrangement for Antenna Port Conducted emissions	17
TEST SITE LOCATIONS	17
UNITS OF MEASUREMENTS	18
ENVIRONMENTAL CONDITIONS.....	18
STATEMENT OF MODIFICATIONS AND DEVIATIONS	18
INTENTIONAL RADIATORS.....	19
Antenna Requirements	19

Restricted Bands of Operation.....19

Table 1 Harmonic Radiated Emissions in Restricted Bands Mode 420

Table 2 Harmonic Radiated Emissions in Restricted Bands Mode 521

Table 3 Harmonic Radiated Emissions in Restricted Bands Mode 622

Table 4 Harmonic Radiated Emissions in Restricted Bands Mode 723

Summary of Results for Radiated Emissions in Restricted Bands23

AC Line Conducted EMI Procedure24

Figure 1 AC Line Conducted emissions of EUT line 1 (EUT – Computer).....25

Figure 2 AC Line Conducted emissions of EUT line 2 (EUT – Computer).....26

Table 5 AC Line Conducted Emissions Data L1 (EUT – Computer).....27

Table 6 AC Line Conducted Emissions Data L2 (EUT – Computer).....27

Summary of Results for AC Line Conducted Emissions Results.....28

General Radiated Emissions Procedure.....28

Table 7 General Radiated Emissions Data29

Summary of Results for General Radiated Emissions29

Operation in the Band 2400 – 2483.5 MHz.....30

Figure 3 Plot of Transmitter Operation in 2402-2480 MHz Mode 4 BLE31

Figure 4 Plot of Transmitter Operation in 2412-2462 MHz Mode 5 802.11b32

Figure 5 Plot of Transmitter Operation in 2412-2462 MHz Mode 6 802.11g33

Figure 6 Plot of Transmitter Operation in 2412-2462 MHz Mode 7 802.11n34

Figure 7 Plot of Transmitter Emissions Low Band Edge Mode 4 BLE.....35

Figure 8 Plot of Transmitter Emissions Low Band Edge Mode 5 802.11b36

Figure 9 Plot of Transmitter Emissions Low Band Edge Mode 6 802.11g37

Figure 10 Plot of Transmitter Emissions Low Band Edge Mode 7 802.11n38

Figure 11 Plot of Transmitter Emissions High Band Edge Mode 4 BLE39

Figure 12 Plot of Transmitter Emissions High Band Edge Mode 5 802.11b.....40

Figure 13 Plot of Transmitter Emissions High Band Edge Mode 6 802.11g.....41

Figure 14 Plot of Transmitter Emissions High Band Edge Mode 7 802.11n.....42

Figure 15 Plot of 6-dB Occupied Bandwidth Mode 4 BLE.....43

Figure 16 Plot of 99% Occupied Bandwidth Mode 4 BLE44

Figure 17 Plot of 6-dB Occupied Bandwidth Mode 5 802.11b45

Figure 18 Plot of 99% Occupied Bandwidth Mode 5 802.11b46

Figure 19 Plot of 6-dB Occupied Bandwidth Mode 6 802.11g47

Figure 20 Plot of 99% Occupied Bandwidth Mode 7 802.11g48

Figure 21 Plot of 6-dB Occupied Bandwidth Mode 8 802.11n49

Figure 22 Plot of 99% Occupied Bandwidth Mode 9 802.11n50

Figure 23 Plot of Transmitter Power Spectral Density Mode 4 BLE51

Figure 24 Plot of Transmitter Power Spectral Density Mode 5 802.11b52

Figure 25 Plot of Transmitter Power Spectral Density Mode 6 802.11g53

Figure 26 Plot of Transmitter Power Spectral Density Mode 7 802.11n54

Transmitter Emissions Data.....55

Table 8 Transmitter Radiated Emissions Mode 4 BLE55

Table 9 Transmitter Radiated Emissions Mode 5 802.11b56

Table 10 Transmitter Radiated Emissions Mode 6 802.11g57

Table 11 Transmitter Radiated Emissions Mode 7 802.11n58

Table 12 Transmitter Antenna Port Conducted Data modes 4, 5, 6, and 7.....59

Summary of Results for Transmitter Radiated Emissions of Intentional Radiator60

ANNEX..... 61

Annex A Measurement Uncertainty Calculations.....62

Annex B Test Equipment.....63

Annex C Rogers Qualifications65

Annex D Laboratory Certificate of Accreditation.....66

Revisions

Revision 1 Issued November 23, 2020

Executive Summary

The following information is submitted for consideration in obtaining Grant of Certification for License Exempt Digital Transmission System Intentional Radiator operating under Code of Federal Regulations Title 47 (CFR47) Part 15C paragraph 15.247, Industry Canada RSS-247 Issue 2, and RSS-GEN Issue 5, operation in the 2400 – 2483.5 MHz band.

Name of Applicant: Garmin International, Inc.
 1200 East 151st Street
 Olathe, KS 66062

M/N: A04117

FCC ID: IPH-04117 IC: 1792A-04117

Frequency Range: operation in the 2402-2480 MHz band

Operational communication modes

Mode	Power (Watts)	99% OBW (kHz)	6-dB OBW (kHz)
Mode 4, BLE (GMSK)	0.002	1,034	728
Mode 5 802.11b (CCK, DSSS)	0.062	13,510	9,519
Mode 6 802.11g (OFDM)	0.062	17,388	16,426
Mode 7 802.11n (MCS)	0.059	18,349	17,308

This report addresses EUT Operations as Digital Transmission System using transmitter modulations in modes 4, 5, 6, and 7.

Opinion / Interpretation of Results

Tests Performed	Margin (dB)	Results
Emissions 15.205, RSS-GEN, RSS-247	-6.8	Complies
Emissions as per 47CFR 15.207, RSS-GEN 8.8	-17.4	Complies
Radiated Emissions 47 CFR 15.209, RSS-GEN 8.9	-12.7	Complies
Harmonic Emissions per CFR47 15.247, RSS-247	-1.4	Complies
Power Spectral Density per CFR47 15.247, RSS-247	-12.6	Complies

Tests performed include

47CFR

15.247 (a) (2) Systems using digital modulation techniques may operate in the 902-928 MHz, 2400-2483.5 MHz, and 5725-5850 MHz bands. The minimum 6 dB bandwidth shall be at least 500 kHz.

(b) The maximum peak conducted output power of the intentional radiator shall not exceed the following:

(3) For systems using digital modulation in the 902-928 MHz, 2400-2483.5 MHz, and 5725-5850 MHz bands: 1 Watt. As an alternative to a peak power measurement, compliance with the one-Watt limit can be based on a measurement of the maximum conducted output power. Maximum Conducted Output Power is defined as the total transmit power delivered to all antennas and antenna elements averaged across all symbols in the signaling alphabet when the transmitter is operating at its maximum power control level. Power must be summed across all antennas and antenna elements. The average must not include any time intervals during which the transmitter is off or is transmitting at a reduced power level. If multiple modes of operation are possible (e.g., alternative modulation methods), the *maximum conducted output power* is the highest total transmit power occurring in any mode.

(d) In any 100 kHz bandwidth outside the frequency band in which the spread spectrum or digitally modulated intentional radiator is operating, the radio frequency power that is produced by the intentional radiator shall be at least 20 dB below that in the 100 kHz bandwidth within the band that contains the highest level of the desired power, based on either an RF conducted or a radiated measurement, provided the transmitter demonstrates compliance with the peak conducted power limits. If the transmitter complies with the conducted power limits based on the use of RMS averaging over a time interval, as permitted under paragraph (b)(3) of this section, the attenuation required under this paragraph shall be 30 dB instead of 20 dB. Attenuation below the general limits specified in §15.209(a) is not required. In addition, radiated emissions which fall in the restricted bands, as defined in §15.205(a), must also comply with the radiated emission limits specified in §15.209(a) (see §15.205(c)).

(e) For digitally modulated systems, the power spectral density conducted from the intentional radiator to the antenna shall not be greater than 8 dBm in any 3 kHz band during any time interval of continuous transmission. This power spectral density shall be determined in accordance with the provisions of paragraph (b) of this section. The same method of determining the conducted output power shall be used to determine the power spectral density.

5.2 Digital transmission systems

DTSs include systems that employ digital modulation techniques resulting in spectral characteristics similar to direct sequence systems. The following applies to the bands 902-928 MHz and 2400-2483.5 MHz

a) The minimum 6 dB bandwidth shall be 500 kHz.

b) The transmitter power spectral density conducted from the transmitter to the antenna shall not be greater than 8 dBm in any 3 kHz band during any time interval of continuous transmission. This power spectral density shall be determined in accordance with the provisions of section 5.4(d), (i.e. the power spectral density shall be determined using the same method as is used to determine the conducted output power).

5.4 Transmitter output power and equivalent isotropically radiated power (e.i.r.p.) requirements

d) For DTSs employing digital modulation techniques operating in the bands 902-928 MHz and 2400-2483.5 MHz, the maximum peak conducted output power shall not exceed 1 W. The e.i.r.p. shall not exceed 4 W, except as provided in section 5.4(e).

5.5 Unwanted emissions

In any 100 kHz bandwidth outside the frequency band in which the spread spectrum or digitally modulated device is operating, the RF power that is produced shall be at least 20 dB below that in the 100 kHz bandwidth within the band that contains the highest level of the desired power, based on either an RF conducted or a radiated measurement, provided that the transmitter demonstrates compliance with the peak conducted power limits. If the transmitter complies with the conducted power limits based on the use of root-mean-square averaging over a time interval, as permitted under section 5.4(d), the attenuation required shall be 30 dB instead of 20 dB. Attenuation below the general field strength limits specified in RSS-Gen is not required.

Equipment Tested

Model: A04117

Garmin International, Inc.
1200 East 151st Street
Olathe, KS 66062

Garmin Corporation
No.68, Zhangshu 2nd Rd.
Xizhi Dist., New Taipei City 221, Taiwan, R.O.C.

<u>Equipment</u>	<u>Model / PN</u>	<u>Serial Number</u>
EUT	A04117	3342384349
EUT2	A04117	3342384330
Micro USB cable	320-00559-01	N/A
1.5 m USB/power cable	320-1325-00	N/A
Dual USB Power Adapter (CLA)	013-00797-01	N/A
4m power cable	320-01325-10	N/A
8m power cable	320-01325-20	N/A
Parking mode cable	320-00845-04	N/A
Quick power Adapter (QPA)	320-01425-10	N/A
DC Power Supply	BK 1745	209C13
Laptop Computer	Latitude 7480	EFSPSN2
USB Printer	Dell 0N5819	5D1SL61

Operational communication modes

Mode	Transmitter Operation
1	BT BR (GFSK)
2	BT 2EDR ($\pi/4$ -DQPSK)
3	BT 3EDR (8DPSK)
4	BT BLE (GMSK)
5	802.11b (CCK/DSSS)
6	802.11g (OFDM)
7	802.11n (MCS)

Software: 0.23, Sheet metal - Dipole (-0.3 dBi)

Test results in this report relate only to the items tested and operating in modes 4-7. Worst-case configuration data recorded in this report.

Rogers Labs, Inc.
4405 West 259th Terrace
Louisburg, KS 66053
Phone/Fax: (913) 837-3214
Revision 1

Garmin International, Inc.
Model: A04117
Test: 200924
Test to: CFR47 15C, RSS-Gen RSS-247
File: A04117 DTS TstRpt 200924

SN's: 3342384349 / 3342384330
FCC ID: IPH-04117
IC: 1792A-04117
Date: November 23, 2020
Page 8 of 66

Equipment Function

The EUT is a mobile mounted digital recording device incorporating wireless data transfer. The device incorporates camera sensor and associated circuitry to record images within the lens view angle. The design provides a single connection point for use with the authorized Micro USB interface cable options and a single Micro SD memory card slot. The device offers no other interface options than those presented below in the configuration diagrams. The transmitter provides wireless communication capability across the 2402-2480 MHz frequency band. The design provides wireless communications with compatible Bluetooth® (BT) Basic Rate, 2EDR, 3EDR and Low Energy (BLE), as well as 802.11b/g/n (Wi-Fi) equipment. The product operates from internal battery or external direct current power provided over the micro USB interface port. Power is provided through compatible USB interface cable options and power sources. The design utilizes internal fixed antenna system and offers no provision for antenna replacement or modification. Two samples were provided for testing, one representative of production design, and the other modified for testing purposes replacing the integral antenna with a RF connection port. The test samples were provided with test software (version 0.49) providing test personnel the ability to enable transmitter functions on defined modulations and channels. The test software enabled near 100% transmit duty cycle for testing purposes. The antenna modification offered testing facility the ability to connect test equipment to the temporary antenna port for antenna port conducted emission testing. For testing purposes, the EUT received powered from internal battery as well as external direct current sources (CPU-USB port or DC power supply) and configured to operate in available modes. The EUT was arranged as described by the manufacturer emulating typical user configurations for testing purposes. As requested by the manufacturer and required by regulations, the equipment was tested for compliance using the available configurations with the worst-case data presented. This report documents the performed testing and results for applicable configurations and product modes of operation. Test results in this report relate only to the products described in this report.

Equipment Configuration

- 1) Unit connected to (and powered by) CLA through USB cable

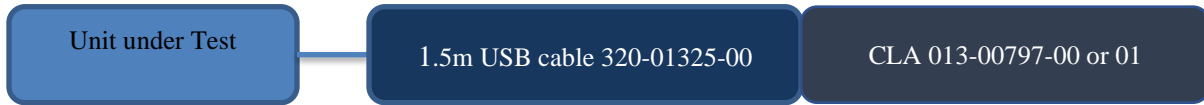

- 2) Unit connected to (and powered by) CLA through USB cable

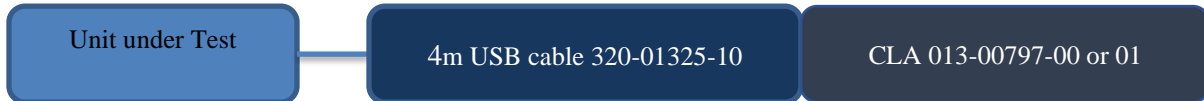

- 3) Unit connected to (and powered by) CLA through USB cable

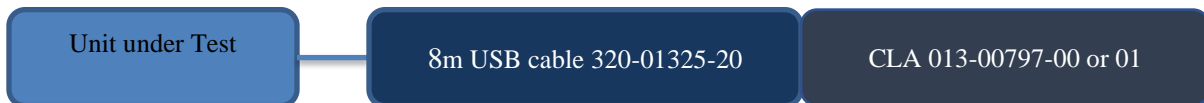

- 4) Unit connected to (and powered by) Computer through USB cable

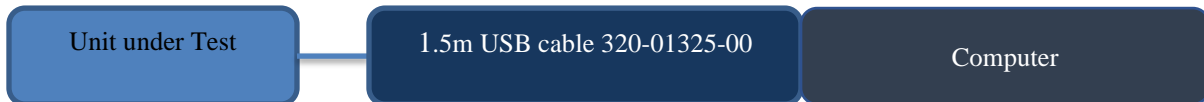

- 5) Unit connected to (and powered by) QPA through USB cable

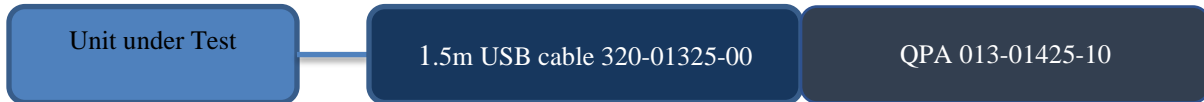

- 6) Unit connected to (and powered by) QPA through USB cable

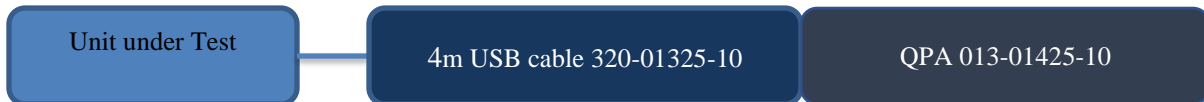

- 7) Unit connected to (and powered by) QPA through USB cable

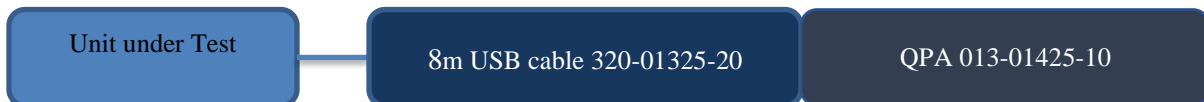

- 8) Unit connected to (and powered by) Surveillance Mode Cable



Application for Certification

- (1) Manufacturer: Garmin International, Inc.
1200 East 151st Street
Olathe, KS 66062
- (2) Identification: M/N: A04117
FCC ID: IPH-04117 IC: 1792A-04117
- (3) Instruction Book:
Refer to Exhibit for Instruction Manual.
- (4) Description of Circuit Functions:
Refer to Exhibit of Operational Description.
- (5) Block Diagram with Frequencies:
Refer to Exhibit of Operational Description.
- (6) Report of Measurements:
Report of measurements follows in this Report.
- (7) Photographs: Construction, Component Placement, etc.:
Refer to Exhibit for photographs of equipment.
- (8) List of Peripheral Equipment Necessary for operation. The equipment operates from internal battery power or external direct current power provided from authorized sources. The EUT offers interface port for power and communications as presented in this filing.
- (9) Transition Provisions of CFR47 15.37 are not requested.
- (10) Not Applicable. The unit is not a scanning receiver.
- (11) Not Applicable. The EUT does not operate in the 59 – 64 GHz frequency band.
- (12) The equipment is not software defined and this section is not applicable.
- (13) Applications for certification of U-NII devices in the 5.15-5.35 GHz and the 5.47-5.85 GHz bands must include a high-level operational description of the security procedures that control the radio frequency operating parameters and ensure that unauthorized modifications cannot be made. This requirement is not applicable to his DTS device.
- (14) Contain at least one drawing or photograph showing the test set-up for each of the required types of tests applicable to the device for which certification is requested. These drawings or photographs must show enough detail to confirm other information contained in the test report. Any photographs used must be focused originals without glare or dark spots and must clearly show the test configuration used. This information is provided in this report and Test Setup Exhibits provided with the application filing.

Applicable Standards & Test Procedures

The following information is submitted in accordance with the eCFR Code of Federal Regulations Title 47 (47CFR), dated September 24, 2020: Part 2, Subpart J, Part 15C Paragraph 15.247, Industry Canada RSS-247 Issue 2, and RSS-GEN Issue 5. Test procedures used are the established Methods of Measurement of Radio-Noise Emissions as described in ANSI C63.10-2013. This report documents compliance for the EUT operations as Digital Transmission Systems operation.

Testing Procedures

AC Line Conducted Emission Test Procedure

Testing for the AC line-conducted emissions was performed as defined in ANSI C63.4-2014. The test setup, including the EUT, was arranged in the test configurations as presented during testing. The test configuration was placed on a 1 x 1.5-meter bench, 0.8 meters high located in a screen room. The power lines of the system were isolated from the power source using a standard LISN with a 50- μ Hy choke. EMI was coupled to the spectrum analyzer through a 0.1 μ F capacitor internal to the LISN. The LISN was positioned on the floor beneath the wooden bench supporting the EUT. The power lines and cables were draped over the back edge of the table. Refer to diagram one showing typical test arrangement and photographs in exhibits for EUT placement used during testing.

Radiated Emission Test Procedure

Radiated emissions testing was performed as required in CFR47 15C, RSS-247 Issue 2 and specified in ANSI C63.10-2013. The EUT was placed on a rotating 0.9 x 1.2-meter platform, elevated as required above the ground plane at a distance of 3 meters from the FSM antenna. EMI energy was maximized by equipment placement permitting orientation in three orthogonal axes, raising, and lowering the FSM antenna, changing the antenna polarization, and by rotating the turntable. Each emission was maximized before data was taken and recorded. The frequency spectrum from 9 kHz to 25,000 MHz was searched for emissions during preliminary investigation. Refer to diagrams two and three showing typical test setup. Refer to photographs in the test setup exhibits for specific EUT placement during testing.



Antenna Port Conducted Emission Test Procedure

The EUT was assembled as required for operation placed on a benchtop. This configuration provided the ability to connect test equipment to the provided test antenna port. Antenna Port conducted emissions testing was performed presented in the regulations and specified in ANSI C63.10-2013. Testing was completed on a laboratory bench in a shielded room. The active antenna port of the device was connected to appropriate attenuation and the spectrum analyzer. Refer to diagram four showing typical test arrangement and photographs in the test setup exhibits for specific EUT placement during testing.

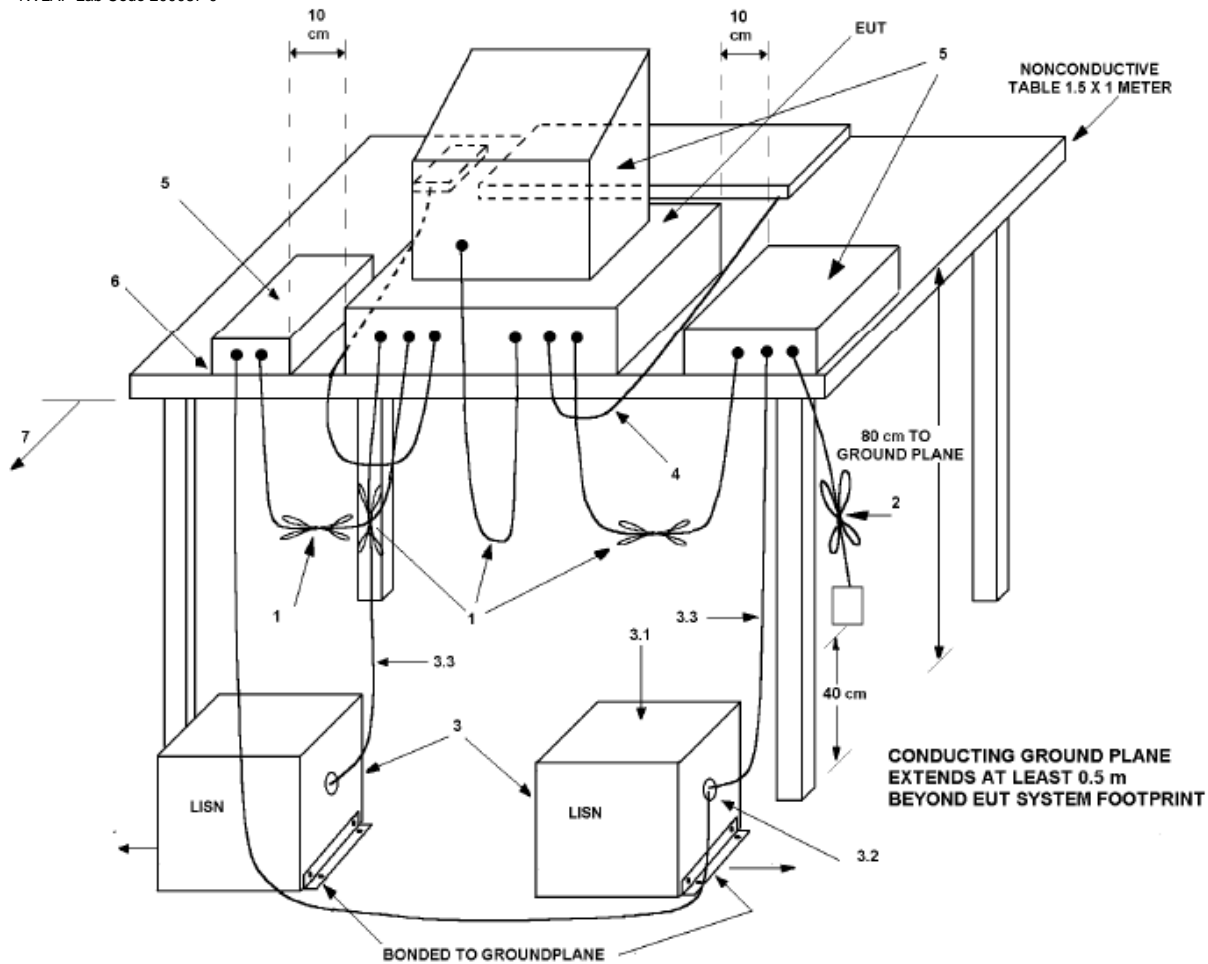

1. Interconnecting cables that hang closer than 40 cm to the ground plane were folded back and forth in the center forming a bundle 30 cm to 40 cm long.
2. Input/Output (I/O) cables that are not connected to a peripheral shall be bundled in the center. The end of the cable may be terminated, if required, using the correct terminating impedance. The overall length shall not exceed 1 m.
3. EUT connected to one LISN. Unused LISN measuring port connectors are terminated into 50 Ω loads. LISN is placed on top of and bonded to reference ground plane.
 - 3.1 All other equipment powered from additional LISN(s).
 - 3.2 Multiple outlet strips can be used for multiple power cords of non-EUT equipment.
 - 3.3 LISN is positioned at least 80 cm from nearest part of EUT chassis.
4. Cables of hand-operated devices, such as keyboards, mice, and so on, shall be placed as for normal use.
5. Non-EUT components of EUT system being tested.
6. Rear of EUT, including peripherals, shall all be aligned and flush with rear of tabletop.
7. Rear of tabletop shall be 40 cm removed from a vertical conducting plane that is bonded to the ground plane (see 5.2.2 for options).

Diagram 1 Test arrangement for Conducted emissions

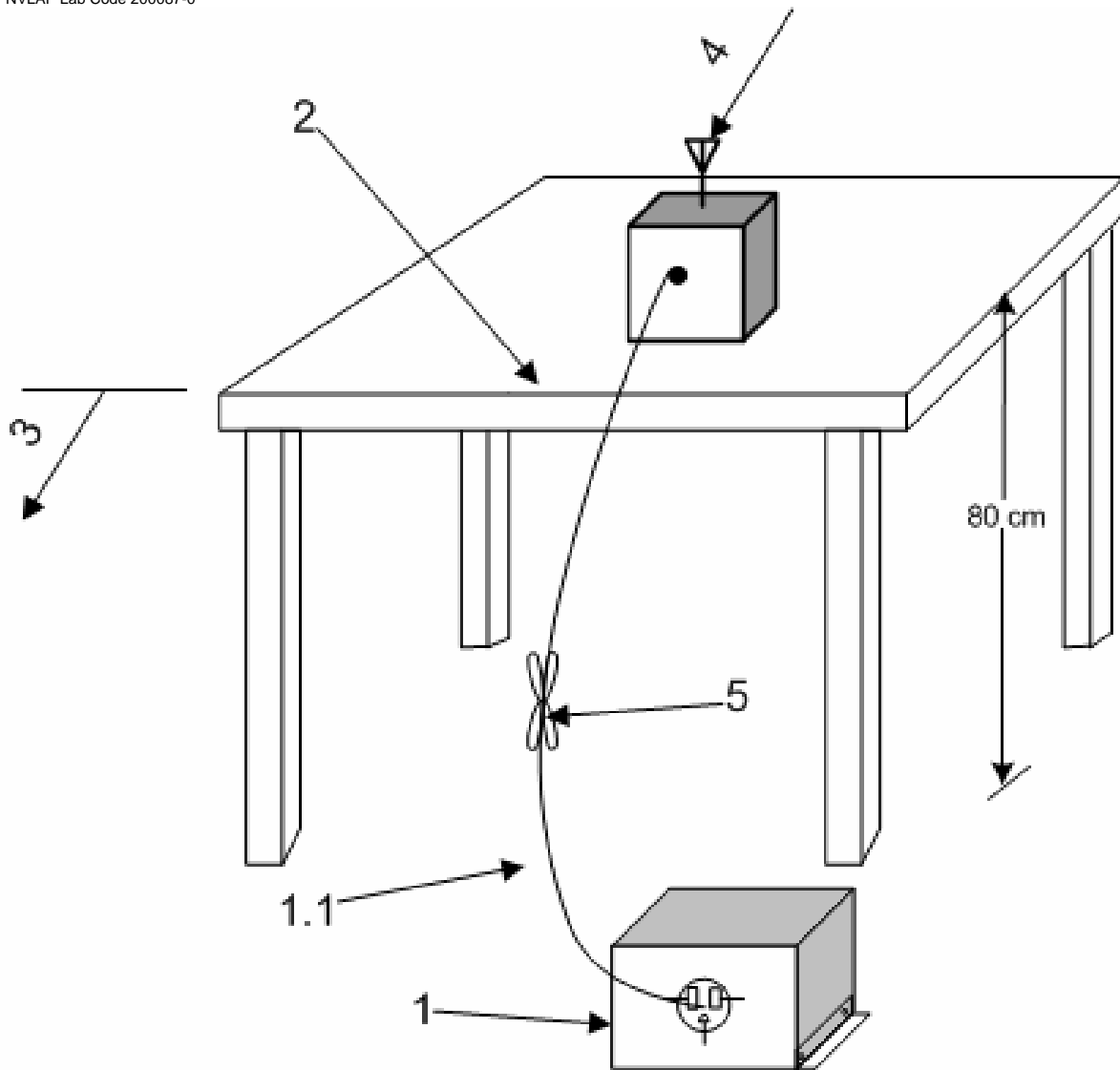

1—A LISN is optional for radiated measurements between 30 MHz and 1000 MHz but not allowed for measurements below 30 MHz and above 1000 MHz (see 6.3.1). If used, then connect EUT to one LISN. Unused LISN measuring port connectors shall be terminated in 50 Ω loads. The LISN may be placed on top of, or immediately beneath, the reference ground plane (see 6.2.2 and 6.2.3.2).

1.1—LISN spaced at least 80 cm from the nearest part of the EUT chassis.

2—Antenna can be integral or detachable, depending on the EUT (see 6.3.1).

3—Interconnecting cables that hang closer than 40 cm to the ground plane shall be folded back and forth in the center forming a bundle 30 cm to 40 cm long (see 6.3.1).

4—For emission measurements at or below 1 GHz, the table height shall be 80 cm. For emission measurements above 1 GHz, the table height shall be 1.5 m for measurements, except as otherwise specified (see 6.3.1 and 6.6.3.1).

Diagram 2 Test arrangement for radiated emissions of tabletop equipment

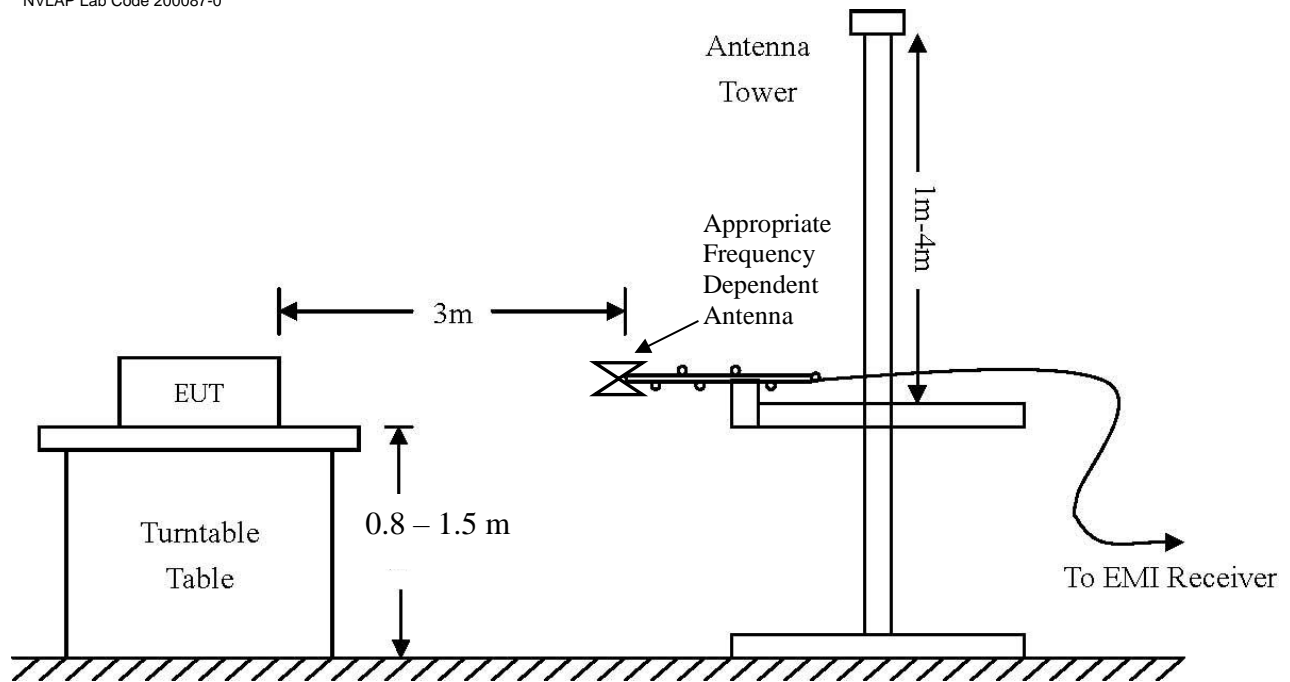

AC Line Conducted Emissions (0.150 -30 MHz)		
RBW	AVG. BW	Detector Function
9 kHz	30 kHz	Peak / Quasi Peak
Emissions (30-1000 MHz)		
RBW	AVG. BW	Detector Function
120 kHz	300 kHz	Peak / Quasi Peak
Emissions (Above 1000 MHz)		
RBW	Video BW	Detector Function
100 kHz	100 kHz	Peak
1 MHz	1 MHz	Peak / Average

Diagram 3 Test arrangement for radiated emissions tested on Open Area Test Site (OATS)

Spectrum Analyzer

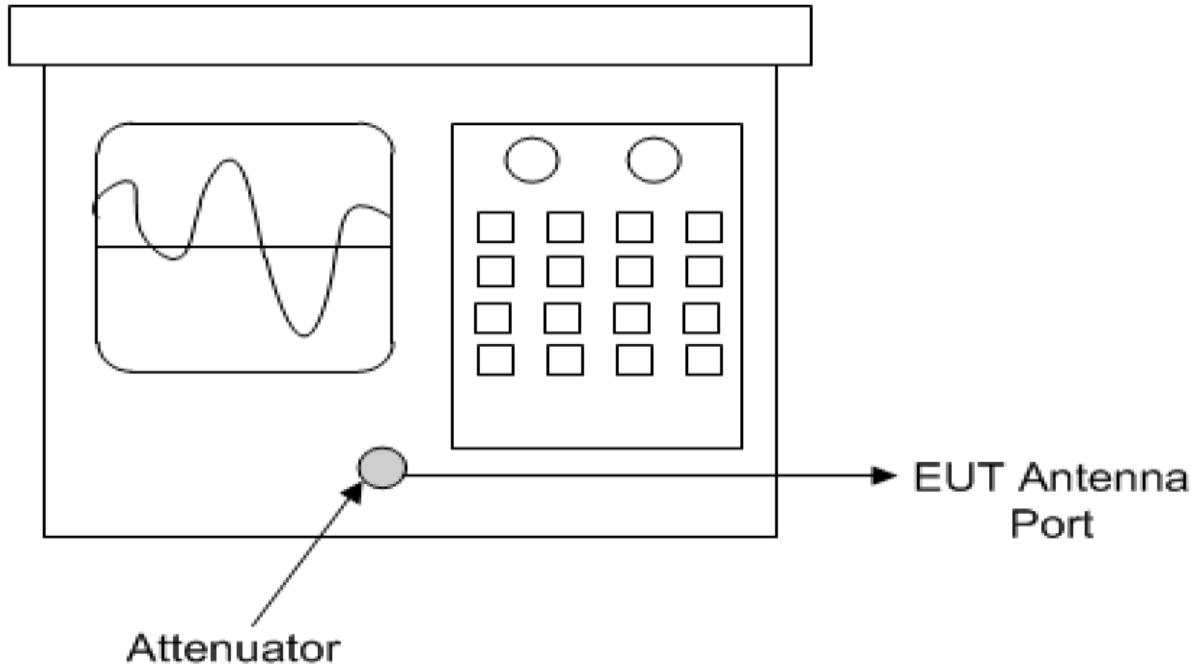

Diagram 4 Test arrangement for Antenna Port Conducted emissions

Test Site Locations

- Conducted EMI AC line conducted emissions testing performed in a shielded screen room located at Rogers Labs, Inc., 4405 West 259th Terrace, Louisburg, KS
- Antenna port Antenna port conducted emissions testing was performed in a shielded screen room located at Rogers Labs, Inc., 4405 West 259th Terrace, Louisburg, KS
- Radiated EMI The radiated emissions tests were performed at the 3 meters, Open Area Test Site (OATS) located at Rogers Labs, Inc., 4405 West 259th Terrace, Louisburg, KS

Registered Site information: FCC Site: US5305, ISED: 3041A, CAB Identifier: US0096

NVLAP Accreditation Lab code 200087-0

Units of Measurements

Conducted EMI Data presented in dB μ V; dB referenced to one microvolt

Antenna port Conducted Data is in dBm; dB referenced to one milliwatt

Radiated EMI Data presented in dB μ V/m; dB referenced to one microvolt per meter

Note: Radiated limit may be expressed for measurement in dB μ V/m when the measurement is taken at a distance of 3 or 10 meters. Data taken for this report was taken at distance of 3 meters.

Sample calculation demonstrates corrected field strength reading for Open Area Test Site using the measurement reading and correcting for receive antenna factor, cable and test system losses, and amplifier gains.

Sample Calculation:

RFS = Radiated Field Strength, FSM = Field Strength Measured

A.F. = Receive antenna factor, Losses = attenuators/cable losses, Gain = amplification gains

RFS (dB μ V/m @ 3m) = FSM (dB μ V) + A.F. (dB/m) + Losses (dB) - Gain (dB)

Environmental Conditions

Ambient Temperature 22.7° C

Relative Humidity 44 %

Atmospheric Pressure 1016.1 mb

Statement of Modifications and Deviations

No modifications to the EUT were required for the unit to demonstrate compliance with CFR47 Part 15C, RSS-247 Issue 2, and RSS-GEN Issue 5 emission requirements. There were no deviations to the specifications.

Intentional Radiators

The following information is submitted in support demonstration of compliance with the requirements of CFR47, Paragraph 15 Subpart C, paragraph 15.247, Industry Canada RSS-247 Issue 2, and RSS-GEN Issue 5.

Antenna Requirements

The EUT incorporates integral antenna system and offers no provision for connection to alternate antenna system. The antenna connection point complies with the unique antenna connection requirements. There are no deviations or exceptions to the specification.

Restricted Bands of Operation

Spurious emissions falling in the restricted frequency bands of operation were measured at the OATS. The EUT utilizes frequency, determining circuitry, which generates harmonics falling in the restricted bands. Emissions were investigated at the OATS, using appropriate antennas or pyramidal horns, amplification stages, and a spectrum analyzer. Peak and average amplitudes of frequencies above 1000 MHz were compared to the required limits with worst-case data presented below. Test procedures of ANSI C63.10-2013 were used during testing. No other significant emission was observed which fell into the restricted bands of operation. Computed emission values consider the received radiated field strength, receive antenna correction factor, amplifier gain stage, and test system cable losses.

Table 1 Harmonic Radiated Emissions in Restricted Bands Mode 4

Frequency in MHz	Horizontal Peak (dB μ V/m)	Horizontal Average (dB μ V/m)	Vertical Peak (dB μ V/m)	Vertical Average (dB μ V/m)	Limit @ 3m (dB μ V/m)	Horizontal Margin (dB)	Vertical Margin (dB)
2390.0	44.4	30.7	44.3	30.7	54.0	-23.3	-23.3
2483.5	47.0	31.3	44.9	31.3	54.0	-22.7	-22.7
4804.0	49.7	36.2	49.3	36.3	54.0	-17.8	-17.7
4884.0	49.7	36.2	49.8	36.1	54.0	-17.8	-17.9
4960.0	49.9	36.2	49.5	36.2	54.0	-17.8	-17.8
7206.0	53.2	40.3	53.2	40.3	54.0	-13.7	-13.7
7326.0	53.1	40.4	54.0	40.4	54.0	-13.6	-13.6
7440.0	53.8	40.5	53.2	40.5	54.0	-13.5	-13.5
12010.0	60.7	46.7	59.3	46.7	54.0	-7.3	-7.3
12210.0	60.6	47.1	60.4	47.1	54.0	-6.9	-6.9
12400.0	60.0	47.1	59.5	47.0	54.0	-6.9	-7.0

Other emissions present had amplitudes at least 20 dB below the limit. Peak and Quasi-Peak amplitude emissions are recorded for frequency below 1000 MHz. Peak and Average amplitude emissions are recorded for frequency range above 1000 MHz.

Table 2 Harmonic Radiated Emissions in Restricted Bands Mode 5

Frequency in MHz	Horizontal Peak (dBµV/m)	Horizontal Average (dBµV/m)	Vertical Peak (dBµV/m)	Vertical Average (dBµV/m)	Limit @ 3m (dBµV/m)	Horizontal Margin (dB)	Vertical Margin (dB)
2390.0	51.5	35.6	46.6	32.2	54.0	-18.4	-21.8
2483.5	50.6	35.7	47.7	32.8	54.0	-18.3	-21.2
4824.0	49.4	35.9	51.2	36.0	54.0	-18.1	-18.0
4874.0	49.5	36.0	49.4	36.0	54.0	-18.0	-18.0
4924.0	49.0	36.2	49.4	36.1	54.0	-17.8	-17.9
7236.0	53.3	40.2	53.2	40.2	54.0	-13.8	-13.8
7311.0	53.7	40.2	53.3	40.2	54.0	-13.8	-13.8
7386.0	52.9	40.3	53.6	40.4	54.0	-13.7	-13.6
12060.0	59.0	45.9	58.5	45.9	54.0	-8.1	-8.1
12185.0	59.9	46.9	60.1	46.9	54.0	-7.1	-7.1
12310.0	59.9	47.1	59.7	47.1	54.0	-6.9	-6.9

Other emissions present had amplitudes at least 20 dB below the limit. Peak and Quasi-Peak amplitude emissions are recorded for frequency below 1000 MHz. Peak and Average amplitude emissions are recorded for frequency range above 1000 MHz.

Table 3 Harmonic Radiated Emissions in Restricted Bands Mode 6

Frequency in MHz	Horizontal Peak (dB μ V/m)	Horizontal Average (dB μ V/m)	Vertical Peak (dB μ V/m)	Vertical Average (dB μ V/m)	Limit @ 3m (dB μ V/m)	Horizontal Margin (dB)	Vertical Margin (dB)
2390.0	63.0	39.5	66.4	41.4	54.0	-14.5	-12.6
2483.5	60.6	39.2	63.5	41.5	54.0	-14.8	-12.5
4824.0	52.4	36.1	51.5	36.0	54.0	-17.9	-18.0
4874.0	50.1	36.7	54.4	39.4	54.0	-17.3	-14.6
4924.0	50.4	36.6	50.1	36.5	54.0	-17.4	-17.5
7236.0	53.0	40.1	53.0	40.1	54.0	-13.9	-13.9
7311.0	53.1	40.4	54.3	40.9	54.0	-13.6	-13.1
7386.0	52.9	40.4	53.2	40.4	54.0	-13.6	-13.6
12060.0	59.2	45.8	59.3	45.8	54.0	-8.2	-8.2
12185.0	60.4	46.9	60.3	46.9	54.0	-7.1	-7.1
12310.0	60.2	47.2	60.0	47.2	54.0	-6.8	-6.8

Other emissions present had amplitudes at least 20 dB below the limit. Peak and Quasi-Peak amplitude emissions are recorded for frequency below 1000 MHz. Peak and Average amplitude emissions are recorded for frequency range above 1000 MHz.

Table 4 Harmonic Radiated Emissions in Restricted Bands Mode 7

Frequency in MHz	Horizontal Peak (dB μ V/m)	Horizontal Average (dB μ V/m)	Vertical Peak (dB μ V/m)	Vertical Average (dB μ V/m)	Limit @ 3m (dB μ V/m)	Horizontal Margin (dB)	Vertical Margin (dB)
2390.0	63.9	39.4	68.4	43.7	54.0	-14.6	-10.3
2483.5	61.2	39.3	66.7	43.3	54.0	-14.7	-10.7
4824.0	51.1	37.0	49.2	36.0	54.0	-17.0	-18.0
4874.0	49.8	36.6	50.8	36.8	54.0	-17.4	-17.2
4924.0	49.4	36.2	49.6	36.5	54.0	-17.8	-17.5
7236.0	53.5	40.3	52.8	40.1	54.0	-13.7	-13.9
7311.0	53.5	40.4	53.1	40.2	54.0	-13.6	-13.8
7386.0	53.1	40.3	53.6	40.3	54.0	-13.7	-13.7
12060.0	59.2	45.7	58.9	45.8	54.0	-8.3	-8.2
12185.0	59.8	46.9	59.9	46.9	54.0	-7.1	-7.1
12310.0	60.6	47.2	60.2	47.2	54.0	-6.8	-6.8

Other emissions present had amplitudes at least 20 dB below the limit. Peak and Quasi-Peak amplitude emissions are recorded for frequency below 1000 MHz. Peak and Average amplitude emissions are recorded for frequency range above 1000 MHz.

Summary of Results for Radiated Emissions in Restricted Bands

The EUT demonstrated compliance with the radiated emissions requirements of CFR47 Paragraph 15, Subpart 15C, RSS-247 Issue 2, and RSS-GEN Issue 5 emission requirements. The EUT worst-case operations demonstrated a minimum radiated emission margin of -6.8 dB below the requirements in restricted frequency bands. Peak, Quasi-peak, and average amplitudes were checked for compliance with the regulations. Worst-case emissions are reported with other emissions found in the restricted frequency bands at least 20 dB below the requirements.

AC Line Conducted EMI Procedure

The EUT was arranged in typical equipment configurations operating from AC power adapter. Testing was performed with the EUT placed on a 1 x 1.5-meter wooden bench 80 cm above the conducting ground plane, floor of a screen room. The bench was positioned 40 cm away from the wall of the screen room. The LISN was positioned on the floor of the screen room 80-cm from the rear of the EUT. Testing for the AC line-conducted emissions were the procedures of ANSI C63.10-2013 paragraph 6. The AC power adapter for the CPU providing power to the EUT was connected to the LISN for AC line-conducted emissions testing. A second LISN was positioned on the floor of the screen room 80-cm from the rear of the supporting equipment of the EUT. All power cords except those providing power to the EUT were then powered from the second LISN. EMI was coupled to the spectrum analyzer through a 0.1 μ F capacitor, internal to the LISN. Power line conducted emissions testing was carried out individually for each current carrying conductor of the EUT. The excess length of lead between the system and the LISN receptacle was folded back and forth to form a bundle not exceeding 40 cm in length. The screen room, conducting ground plane, analyzer, and LISN were bonded together to the protective earth ground. Preliminary testing was performed to identify the frequencies of each of the emissions, which demonstrated the highest amplitudes. The cables were repositioned to obtain maximum amplitude of measured EMI level. Once the worst-case configuration was identified, plots were made of the EMI from 0.15 MHz to 30 MHz then data was recorded with maximum conducted emissions levels.

Refer to figures one and two for plots of the EUT – USB Computer interface configuration #4 AC Line conducted emissions.

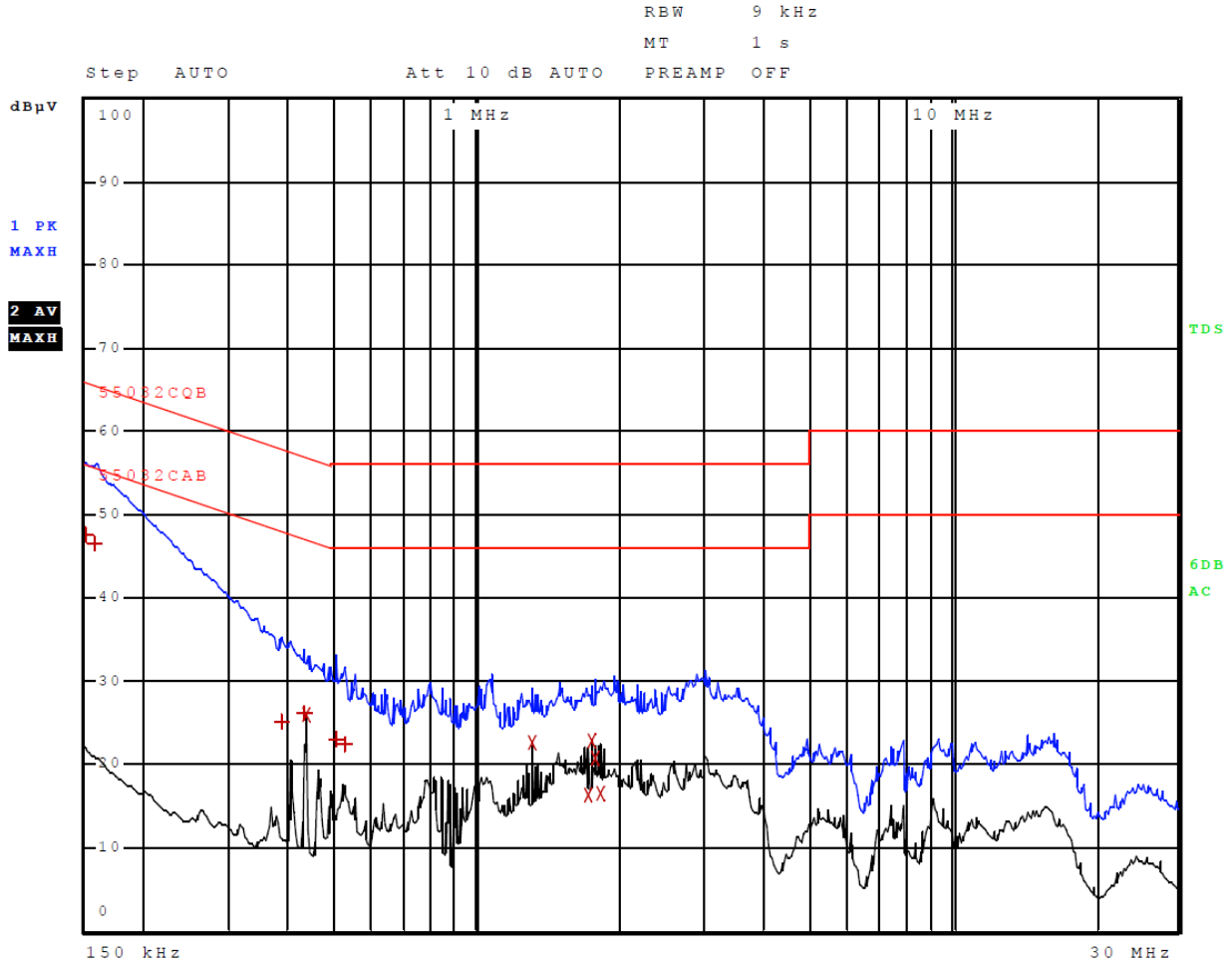

Figure 1 AC Line Conducted emissions of EUT line 1 (EUT – Computer)

RBW 9 kHz
 MT 1 s
 Step AUTO Att 10 dB AUTO PREAMP OFF

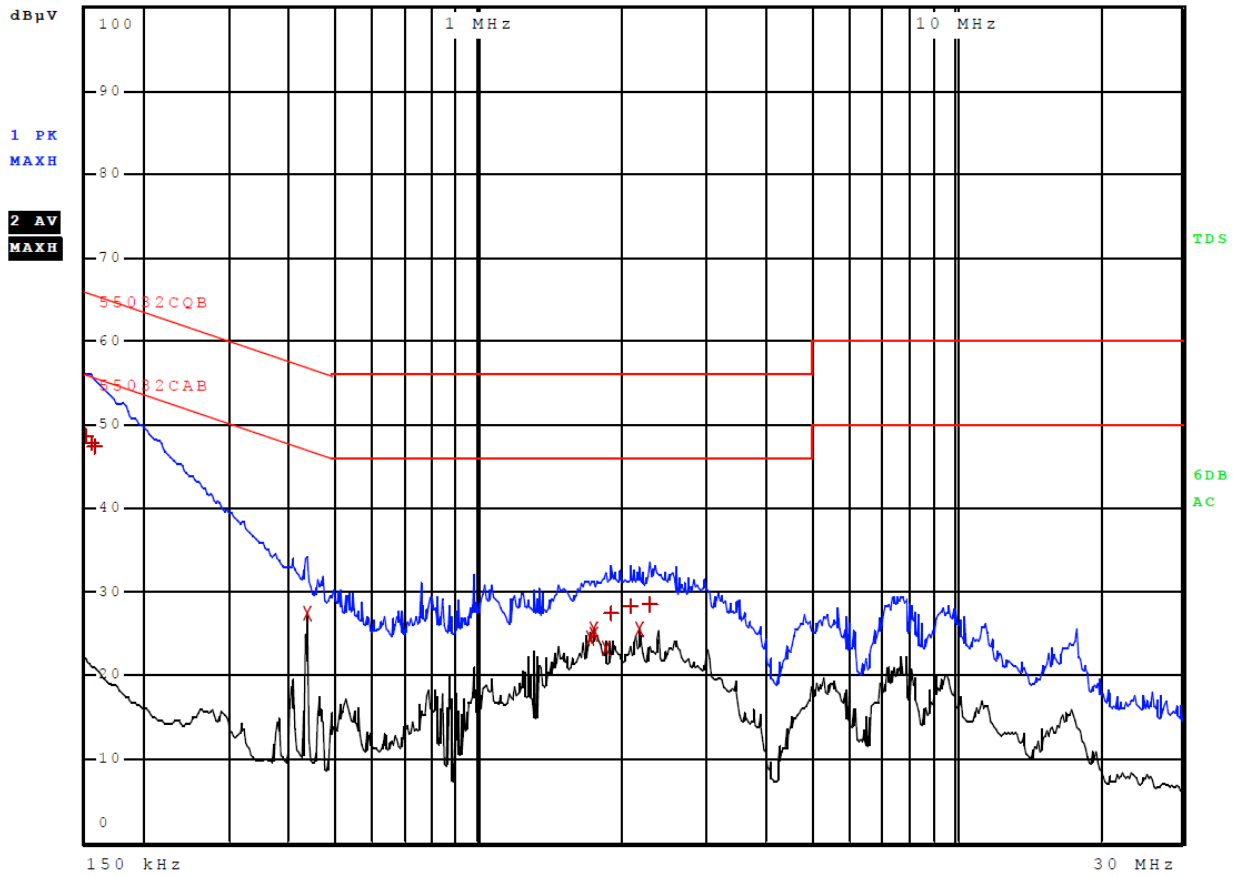

Figure 2 AC Line Conducted emissions of EUT line 2 (EUT – Computer)

Table 5 AC Line Conducted Emissions Data L1 (EUT – Computer)

Trace	Frequency	Level (dBµV)	Detector	Delta Limit/dB
1	150.000000000 kHz	47.48	Quasi Peak	-18.52
1	158.000000000 kHz	46.53	Quasi Peak	-19.04
1	386.000000000 kHz	25.09	Quasi Peak	-33.06
1	430.000000000 kHz	26.19	Quasi Peak	-31.07
2	434.000000000 kHz	25.92	Average	-21.25
1	502.000000000 kHz	23.08	Quasi Peak	-32.92
1	522.000000000 kHz	22.38	Quasi Peak	-33.62
2	1.302000000 MHz	22.56	Average	-23.44
2	1.710000000 MHz	16.34	Average	-29.66
2	1.738000000 MHz	22.70	Average	-23.30
2	1.770000000 MHz	20.68	Average	-25.32
2	1.814000000 MHz	16.44	Average	-29.56

Other emissions present had amplitudes at least 20 dB below the limit.

Table 6 AC Line Conducted Emissions Data L2 (EUT – Computer)

Trace	Frequency	Level (dBµV)	Detector	Delta Limit/dB
1	150.000000000 kHz	48.57	Quasi Peak	-17.43
1	154.000000000 kHz	47.83	Quasi Peak	-17.95
1	158.000000000 kHz	47.31	Quasi Peak	-18.26
2	434.000000000 kHz	27.31	Average	-19.86
2	1.706000000 MHz	24.56	Average	-21.44
2	1.734000000 MHz	25.52	Average	-20.48
2	1.738000000 MHz	24.86	Average	-21.14
2	1.850000000 MHz	23.13	Average	-22.87
1	1.890000000 MHz	27.43	Quasi Peak	-28.57
1	2.082000000 MHz	28.34	Quasi Peak	-27.66
2	2.170000000 MHz	25.49	Average	-20.51
1	2.278000000 MHz	28.53	Quasi Peak	-27.47

Other emissions present had amplitudes at least 20 dB below the limit.



Summary of Results for AC Line Conducted Emissions Results

The EUT demonstrated compliance with the AC Line Conducted Emissions requirements of 47CFR Part 15C and other applicable emissions requirements. The EUT – computer configuration worst-case configuration demonstrated a minimum margin of -17.4 dB below the requirement. Other emissions were present with amplitudes at least 20 dB below the limit and worst-case amplitudes recorded.

General Radiated Emissions Procedure

The EUT was arranged in a typical equipment configuration and operated through all available mode during testing. Preliminary testing was performed in a screen room with the EUT positioned 1 meter from the FSM. Radiated emissions measurements were performed to identify the frequencies, which produced the highest emissions. Each radiated emission was then maximized at the OATS location before final radiated measurements were performed. Final data was taken with the EUT located on the OATS at 3 meters distance between the EUT and the receiving antenna. The frequency spectrum from 9 kHz to 25,000 MHz was searched for general radiated emissions. Measured emission levels were maximized by EUT placement on the table, rotating the turntable through 360 degrees, varying the antenna height between 1 and 4 meters above the ground plane and changing antenna position between horizontal and vertical polarization. Antennas used were Loop from 9 kHz to 30 MHz, Broadband Biconical from 30 to 200 MHz, Biconilog from 30 to 1000 MHz, Log Periodic from 200 MHz to 1 GHz and or double Ridge or pyramidal horns and mixers above 1 GHz, notch filters and appropriate amplifiers and external mixers were utilized.

Table 7 General Radiated Emissions Data

Frequency (MHz)	Horizontal Peak (dBµV/m)	Horizontal Quasi-Peak (dBµV/m)	Vertical Peak (dBµV/m)	Vertical Quasi-Peak (dBµV/m)	Limit @ 3m (dBµV/m)	Horizontal Margin (dB)	Vertical Margin (dB)
78.7	30.8	27.3	29.1	23.2	78.7	30.8	27.3
128.0	28.9	20.4	25.7	20.6	128.0	28.9	20.4
157.6	26.0	20.8	24.3	19.7	157.6	26.0	20.8
173.6	24.3	14.9	21.1	16.0	173.6	24.3	14.9
192.2	22.2	18.1	24.4	20.0	192.2	22.2	18.1
210.8	25.2	15.2	22.9	18.3	210.8	25.2	15.2

Other emissions present had amplitudes at least 20 dB below the limit. Peak and Quasi-Peak amplitude emissions are recorded for frequency range below 1000 MHz. Peak and Average amplitude emissions are recorded for frequency range above 1000 MHz.

Summary of Results for General Radiated Emissions

The EUT demonstrated compliance with the radiated emissions requirements of CFR47 Paragraph 15.209, RSS-247 Issue 2 and RSS-GEN Issue 5 emission requirements. The EUT demonstrated a minimum margin of -12.7 dB below the requirements. Other emissions were present with amplitudes at least 20 dB below the Limits.

Operation in the Band 2400 – 2483.5 MHz

Test procedures of ANSI C63.10-2013 paragraph 6, and KDB 558074 v05r02 were used during transmitter testing. Test sample #2 was provided for testing antenna port conducted emissions. This sample was modified by replacing the internal antenna with a 50-ohm antenna port connector and attenuator for testing purposes. The transmitter peak and average power was measured at the antenna port using a wideband RF power meter as described in ANSI C63.10-2013 and KDB 558074. Average power measured did not include any time intervals during which the transmitter was off or transmitting at a reduced power level. The Power Spectral Density (PSD) was measured as required in ANSI C63.10-2013 and KDB 558074. DTS Emission bandwidth was measured as required in ANSI C63.10-2013 and KDB 558074. The amplitude of each harmonic and general radiated emission was measured on the OATS at distance of 3 meters from the FSM antenna (radiated emission testing was performed on sample #1 representative of production equipment with integral antenna). The EUT was positioned on supporting turntable elevated as required above the ground plane, at a distance of 3 meters from the FSM antenna. Radiated emission investigations were performed from 9 kHz to 25,000 MHz. Each radiated emission was maximized by varying the FSM antenna height and polarization, and by rotating the turntable. The worst-case amplitude of each emission was then recorded from the analyzer display. The peak and quasi-peak amplitude of frequencies below 1000 MHz were measured using a spectrum analyzer. The peak and average amplitude of frequencies above 1000 MHz were measured using a spectrum analyzer. A Loop antenna was used for measuring emissions from 0.009 to 30 MHz, Biconilog Antenna for 30 to 1000 MHz, Double-Ridge, and/or Pyramidal Horn Antennas from 1 GHz to 25 GHz. Radiated Emissions were measured in dB μ V/m @ 3 meters. Plots were taken of transmitter performance (using sample #2) for reference in this and other documentation displaying compliance with the specifications.

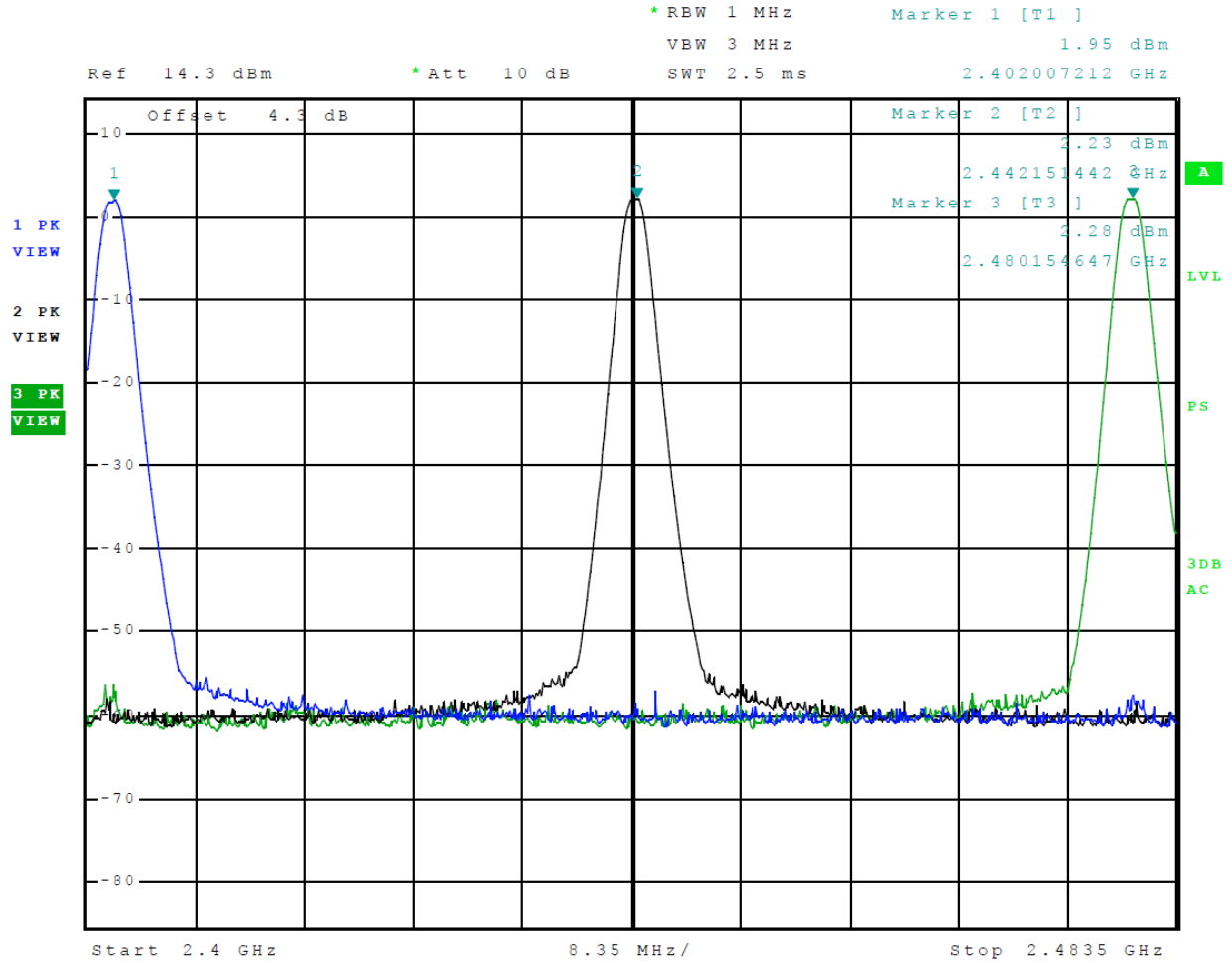

Figure 3 Plot of Transmitter Operation in 2402-2480 MHz Mode 4 BLE

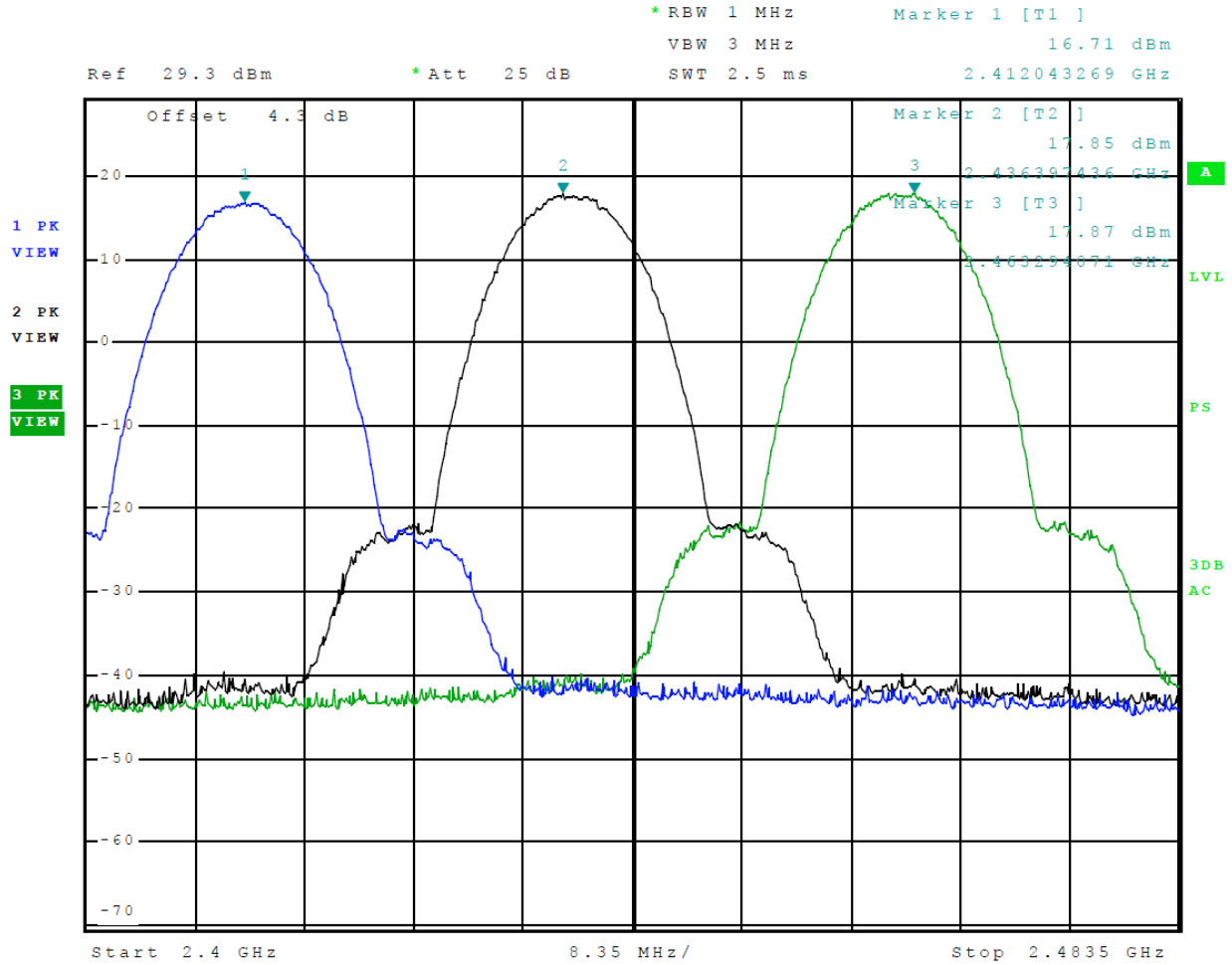

Figure 4 Plot of Transmitter Operation in 2412-2462 MHz Mode 5 802.11b

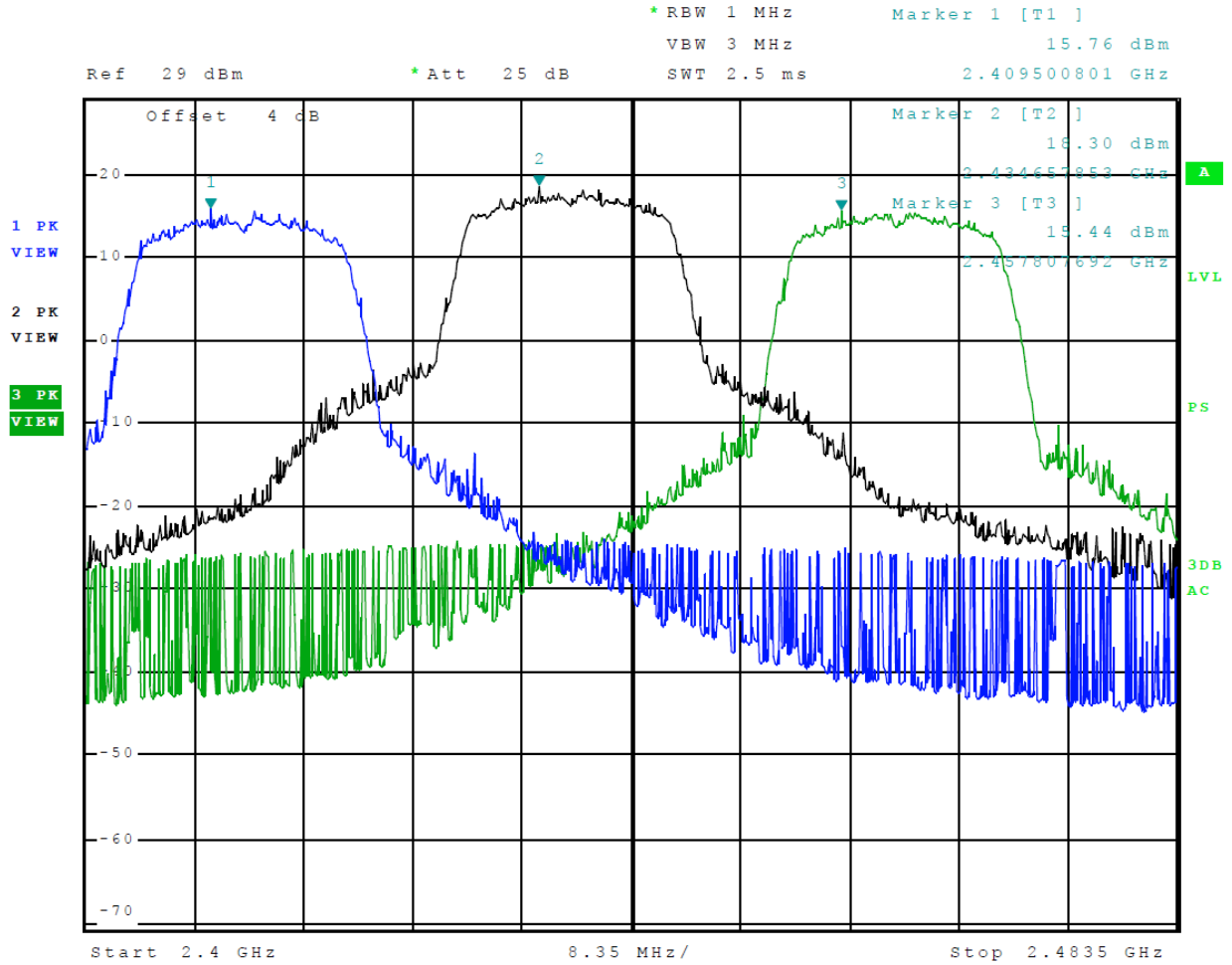

Figure 5 Plot of Transmitter Operation in 2412-2462 MHz Mode 6 802.11g

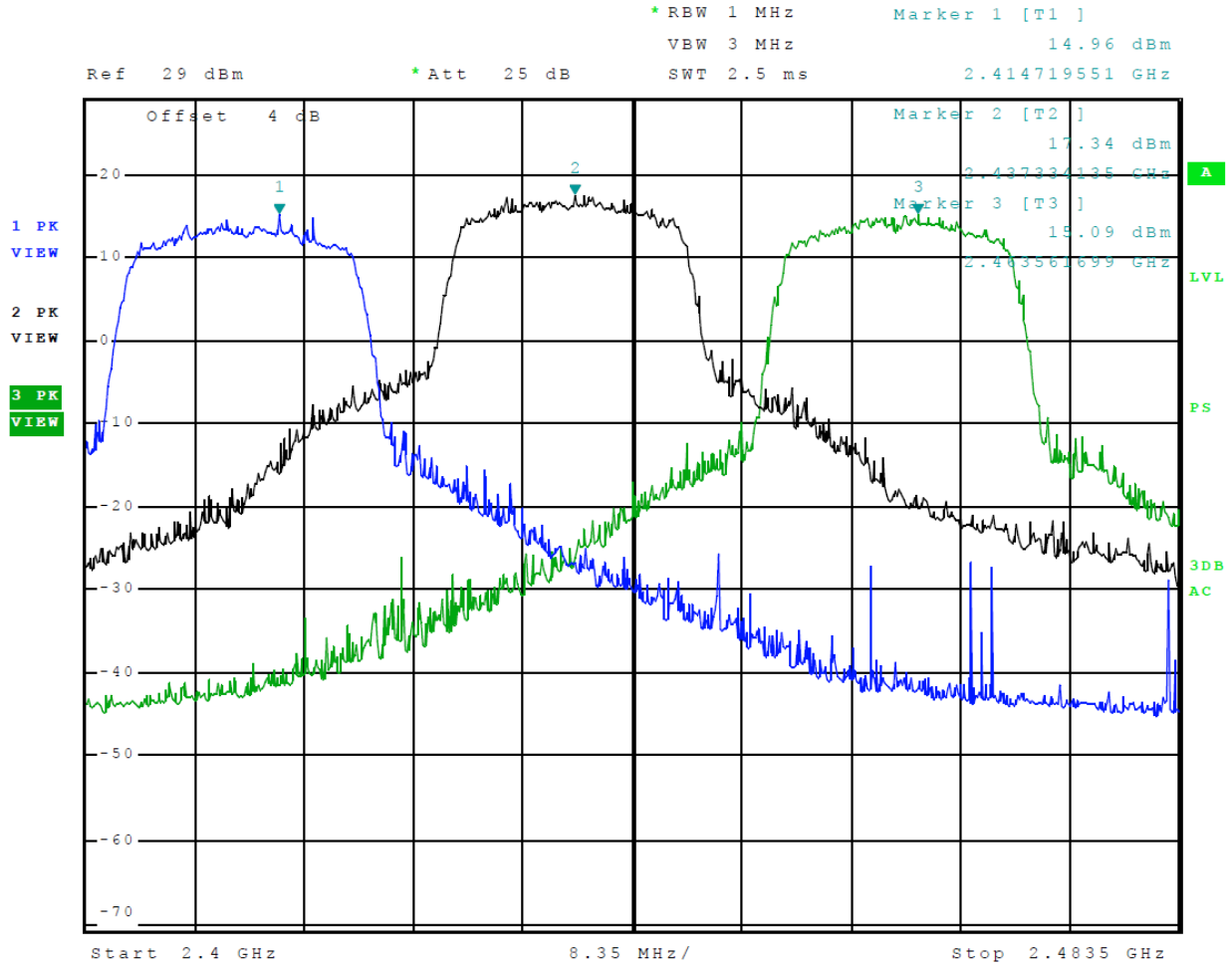

Figure 6 Plot of Transmitter Operation in 2412-2462 MHz Mode 7 802.11n

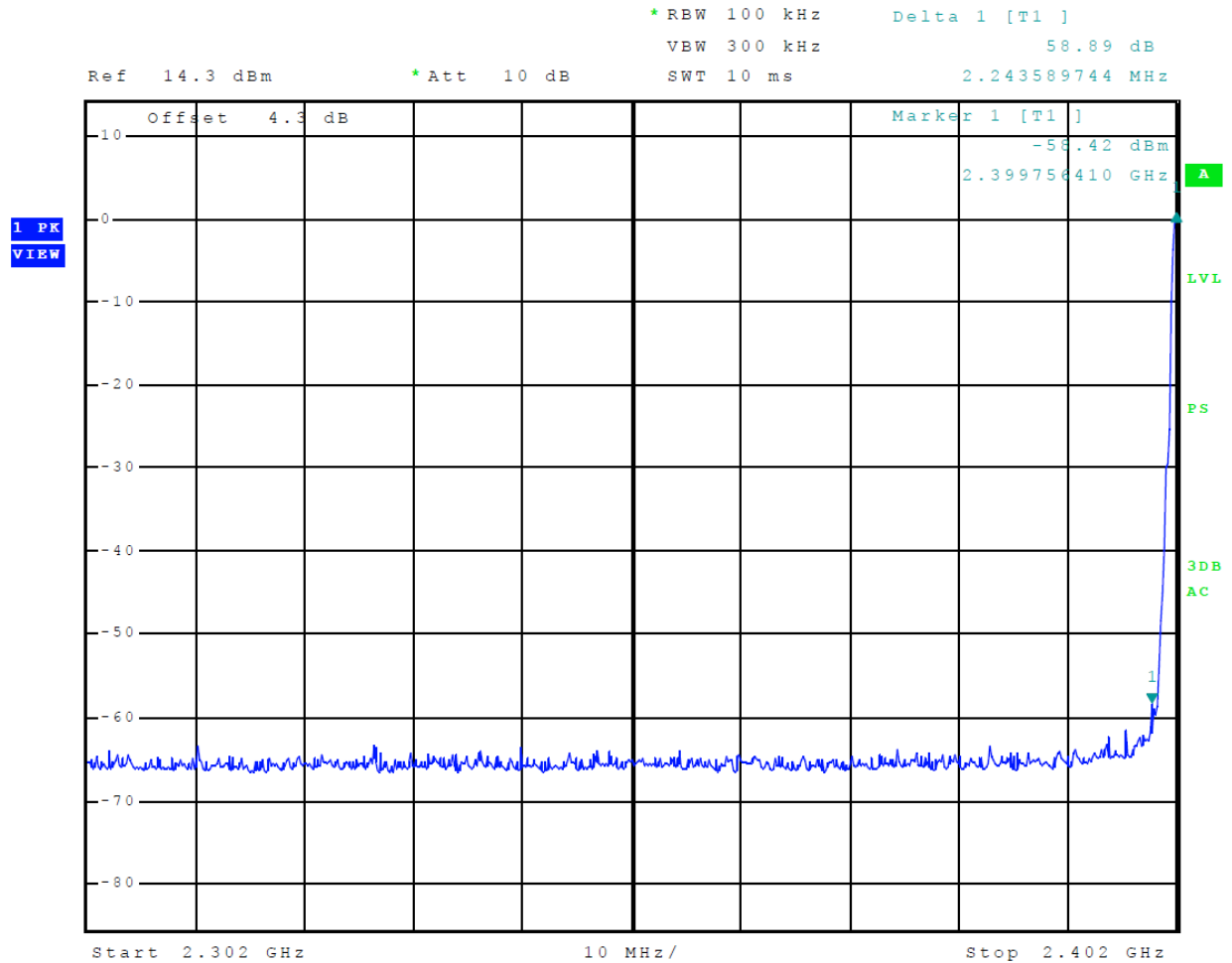

Figure 7 Plot of Transmitter Emissions Low Band Edge Mode 4 BLE

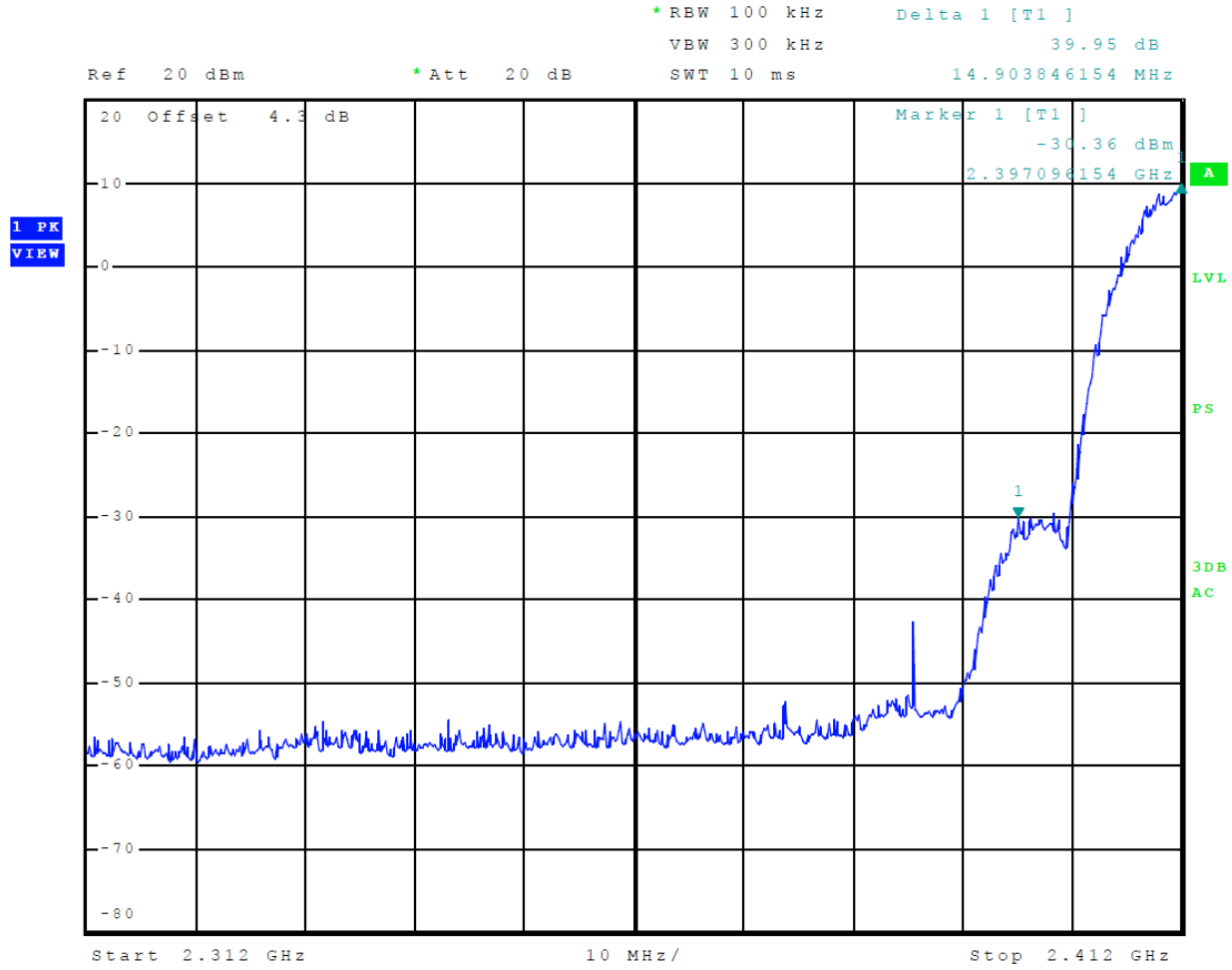

Figure 8 Plot of Transmitter Emissions Low Band Edge Mode 5 802.11b

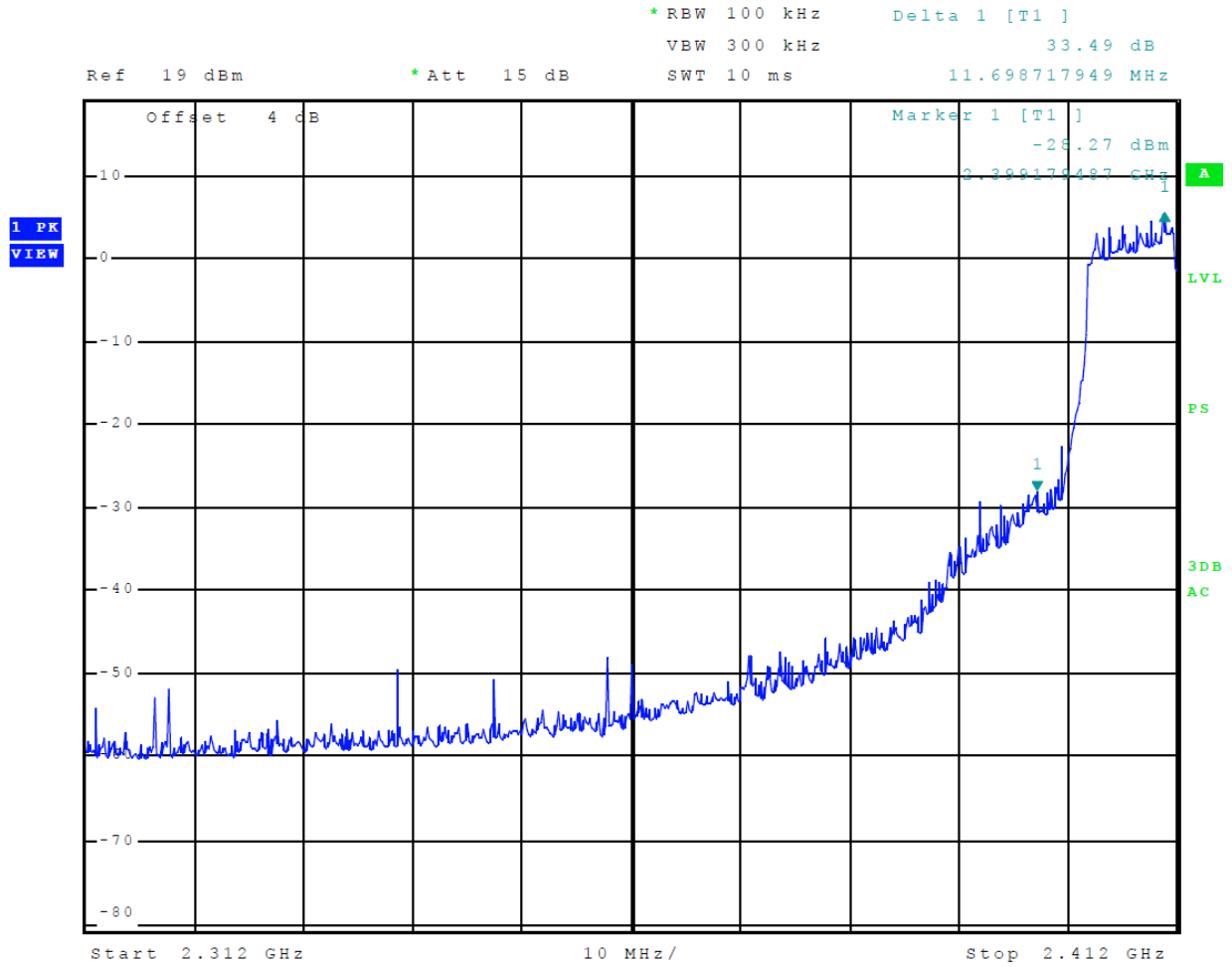

Figure 9 Plot of Transmitter Emissions Low Band Edge Mode 6 802.11g

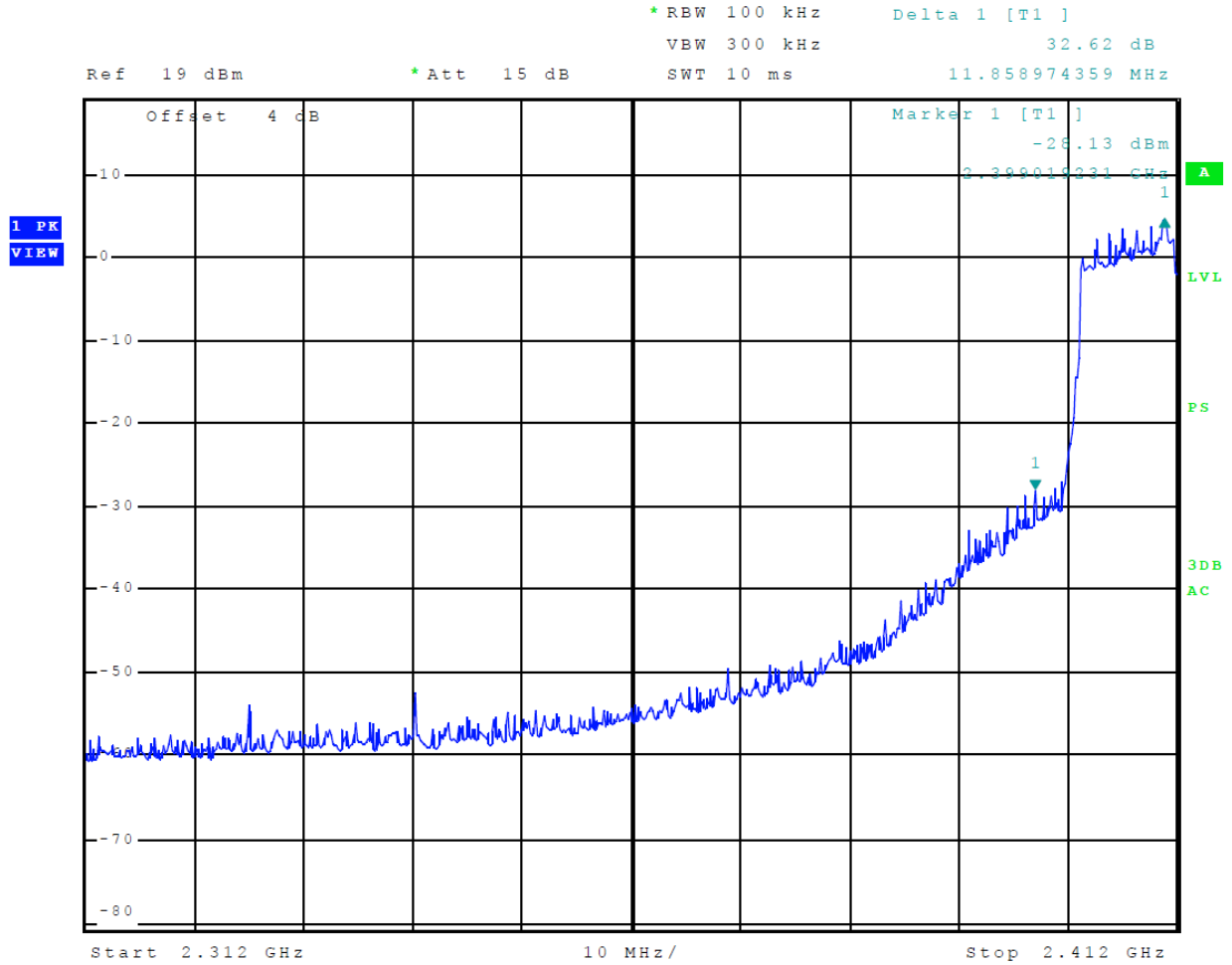

Figure 10 Plot of Transmitter Emissions Low Band Edge Mode 7 802.11n

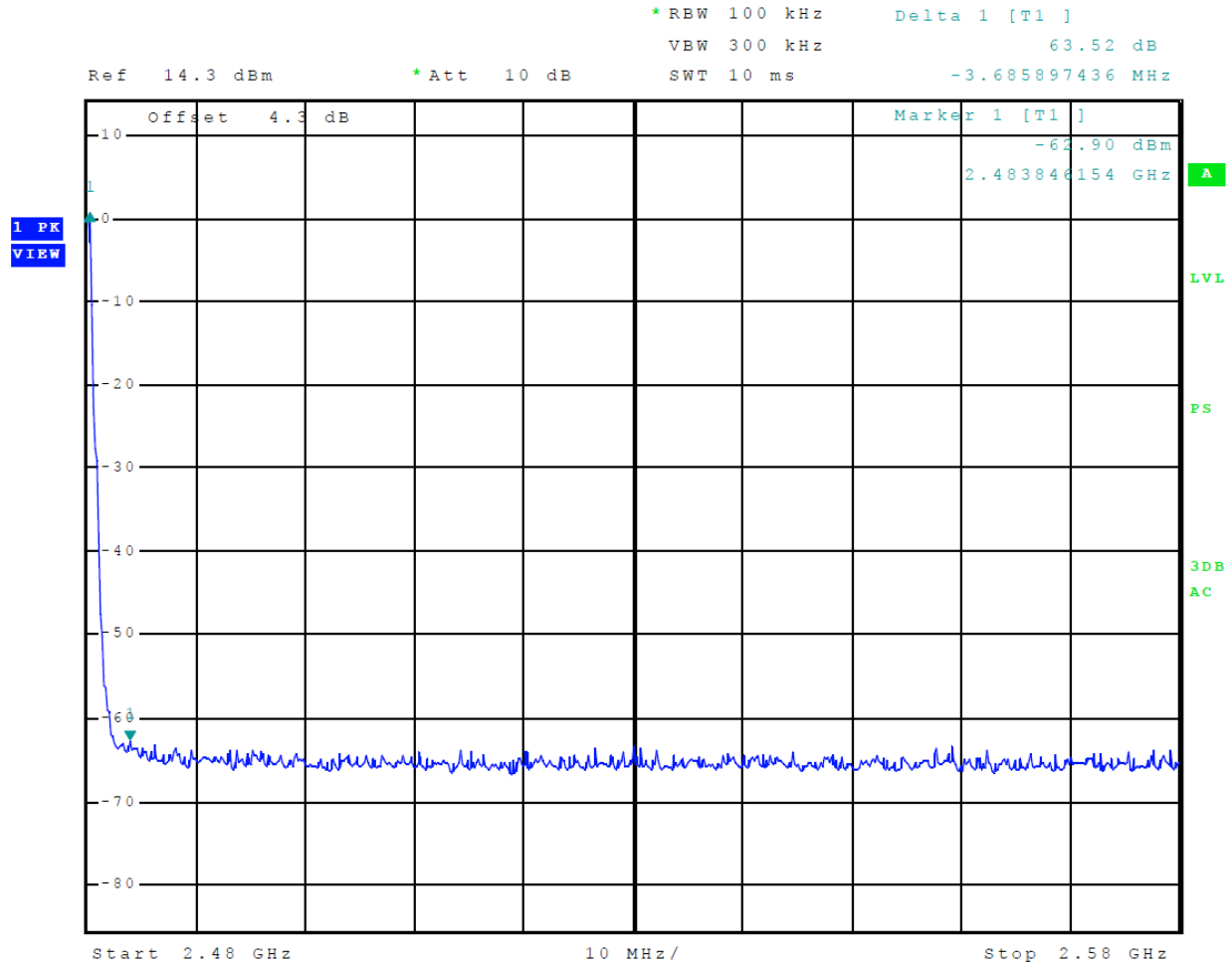

Figure 11 Plot of Transmitter Emissions High Band Edge Mode 4 BLE

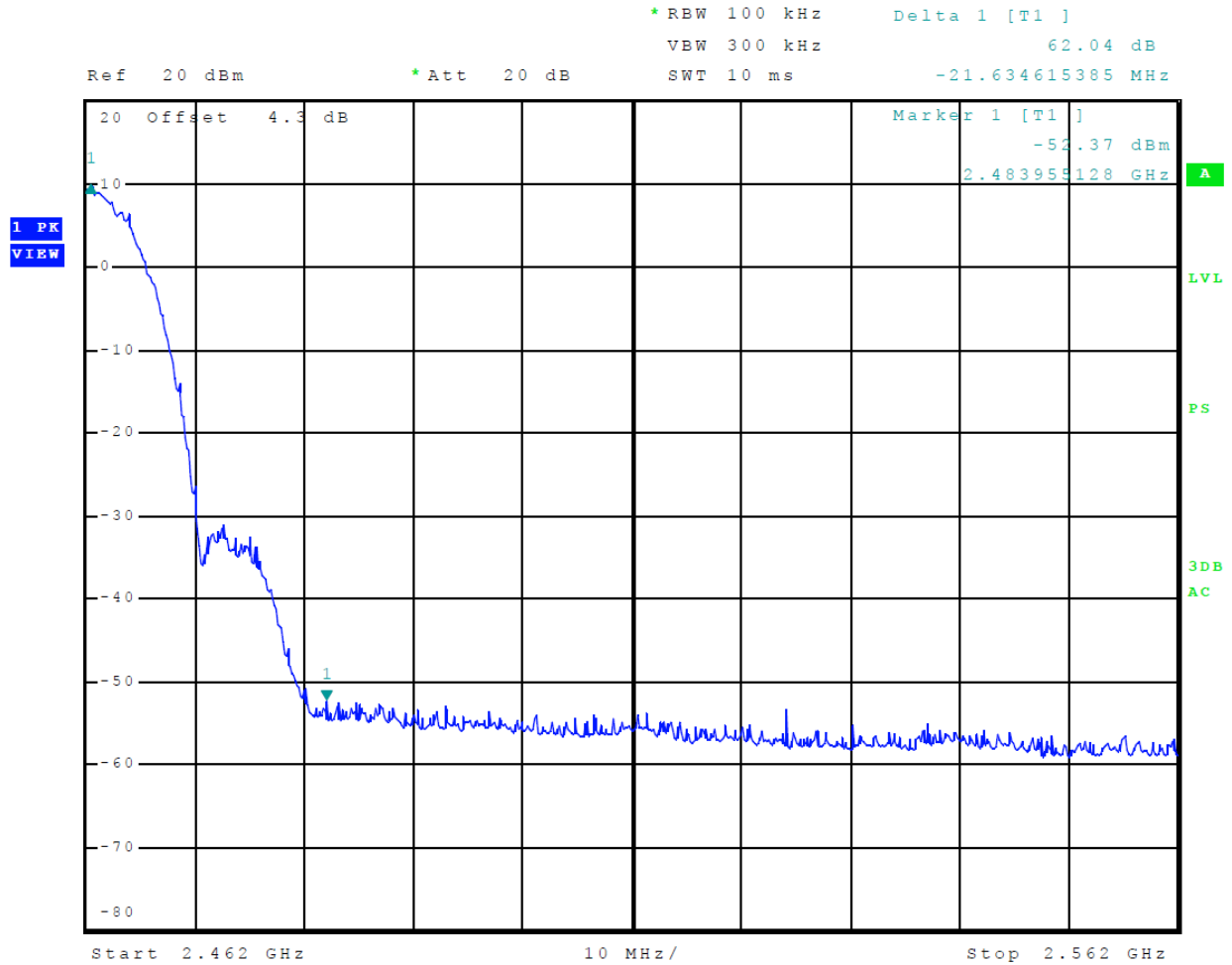

Figure 12 Plot of Transmitter Emissions High Band Edge Mode 5 802.11b

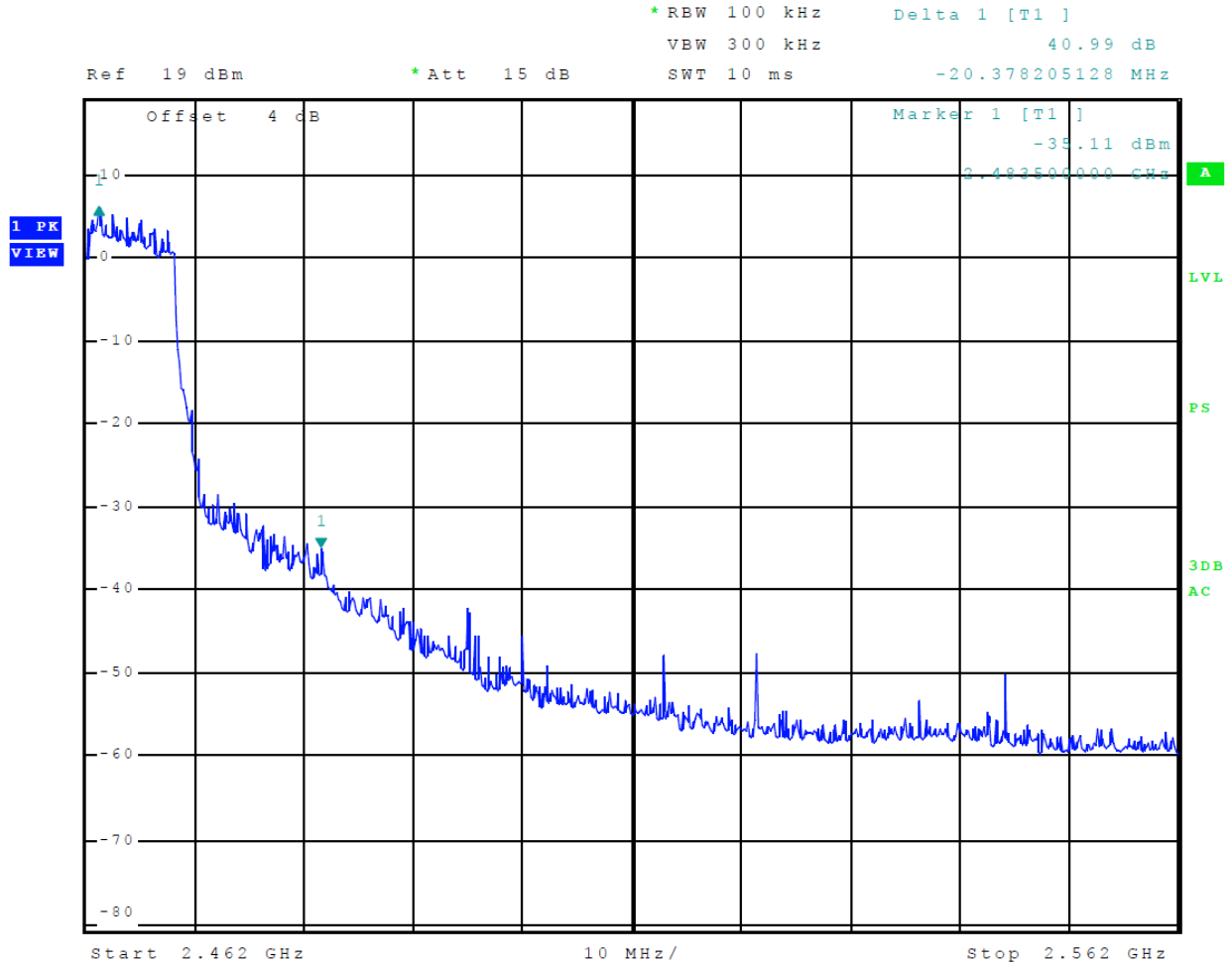

Figure 13 Plot of Transmitter Emissions High Band Edge Mode 6 802.11g

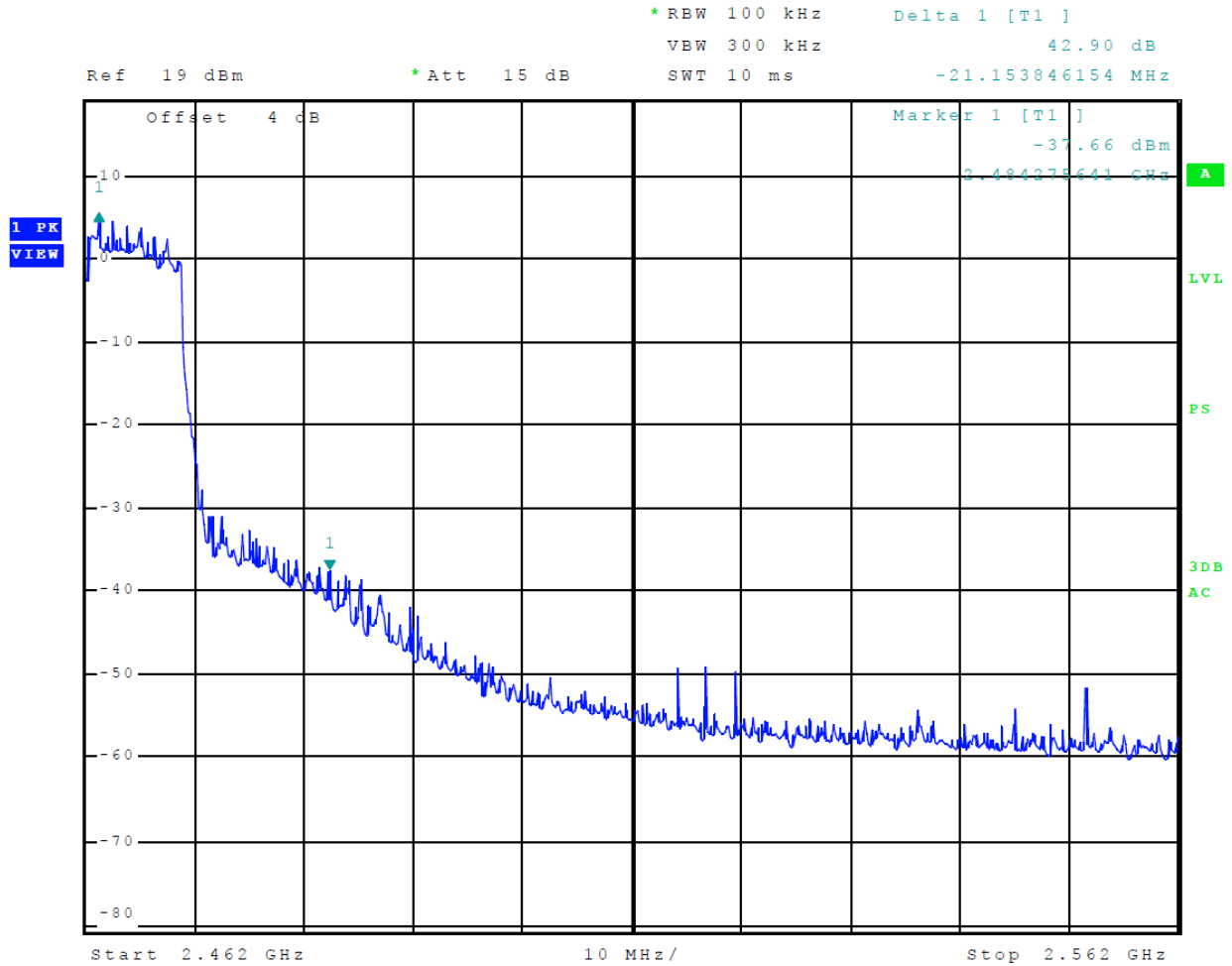

Figure 14 Plot of Transmitter Emissions High Band Edge Mode 7 802.11n

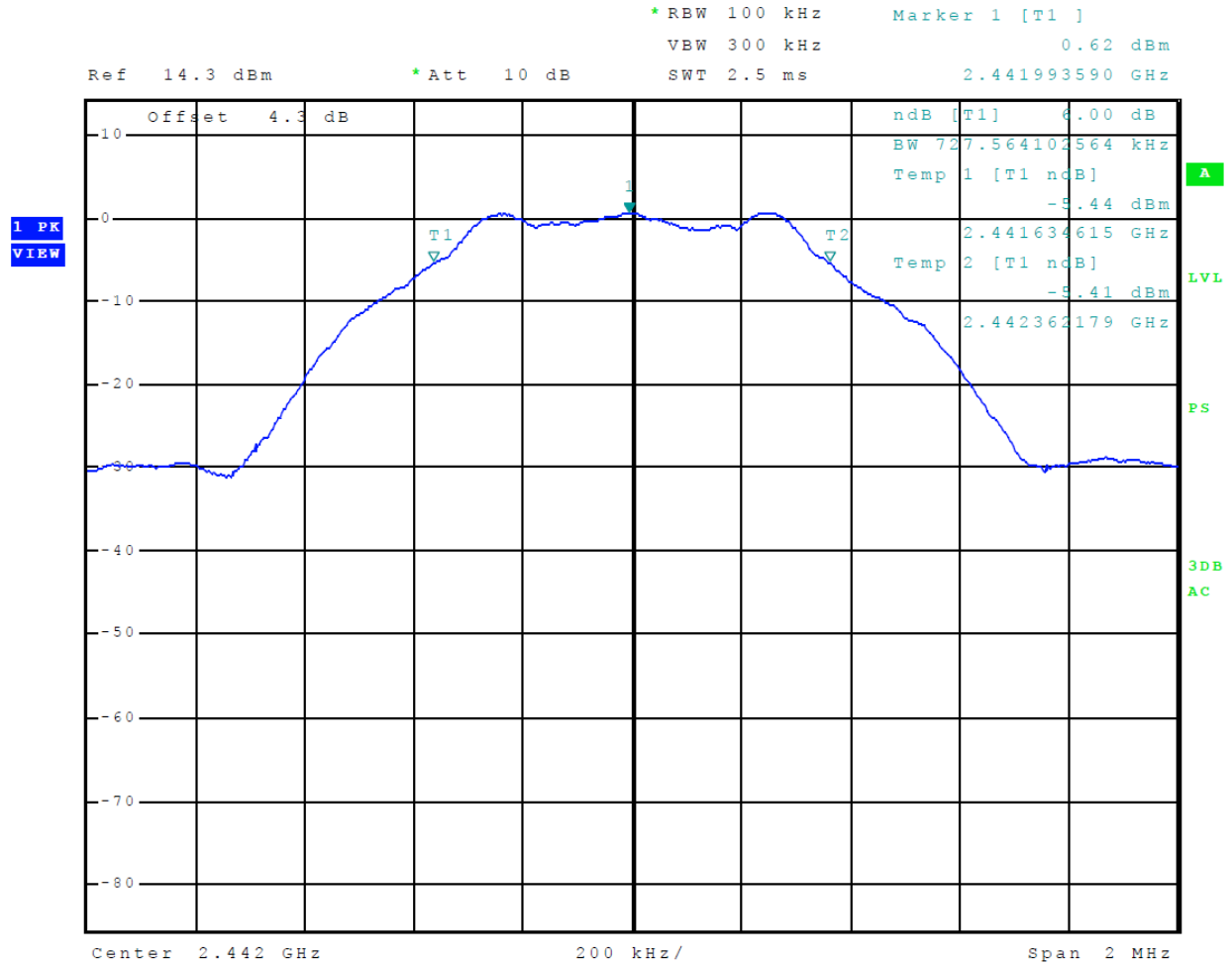

Figure 15 Plot of 6-dB Occupied Bandwidth Mode 4 BLE

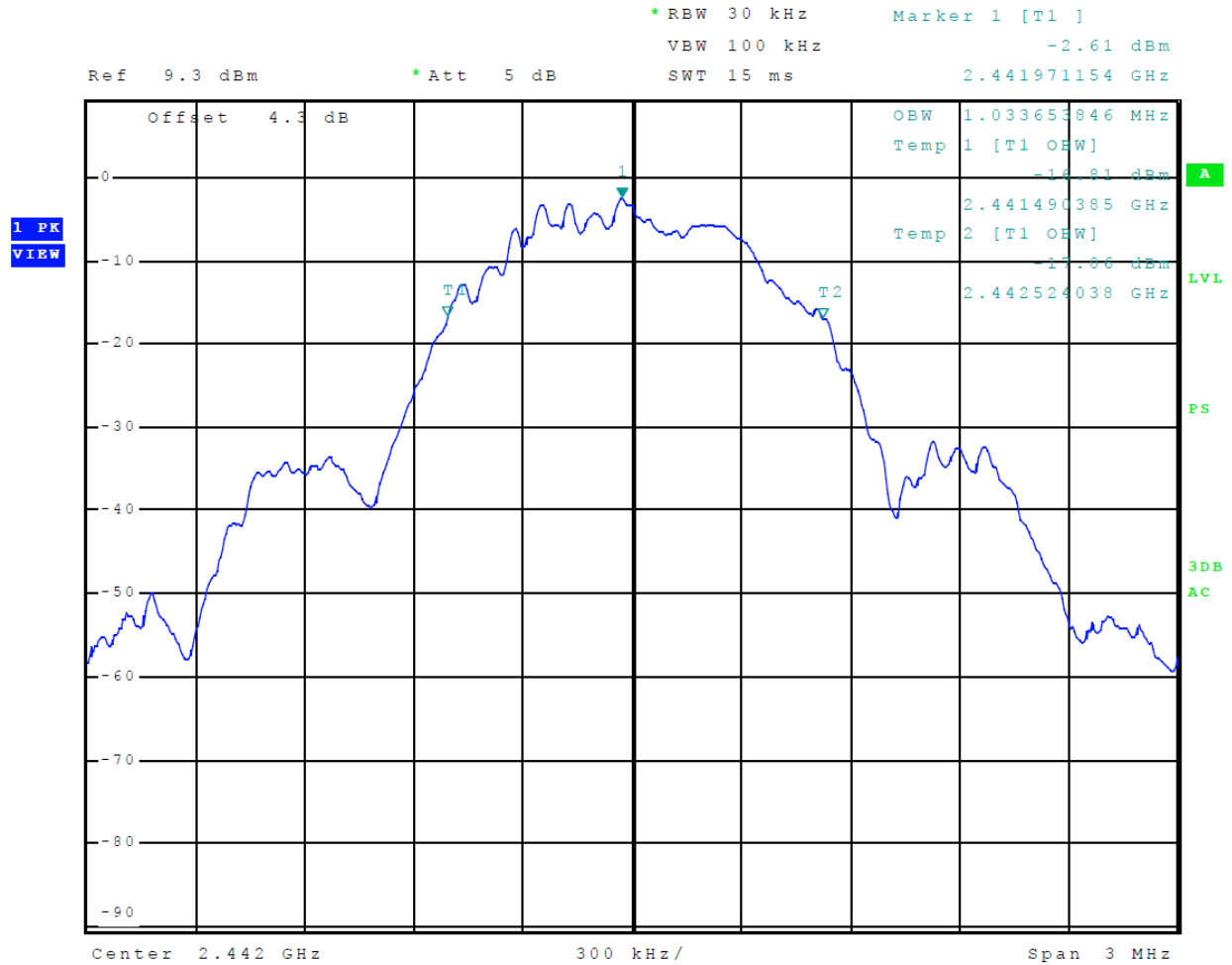

Figure 16 Plot of 99% Occupied Bandwidth Mode 4 BLE

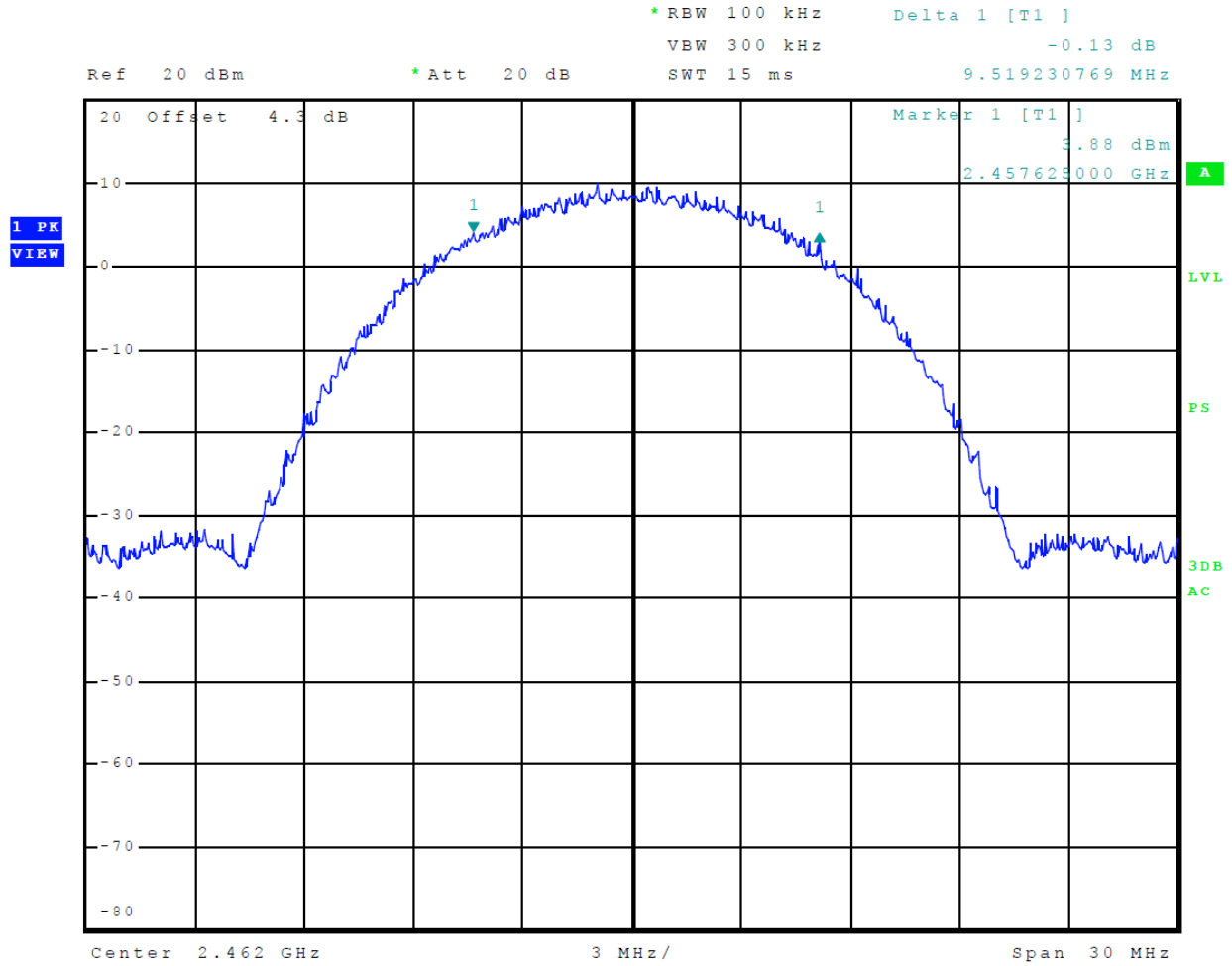

Figure 17 Plot of 6-dB Occupied Bandwidth Mode 5 802.11b

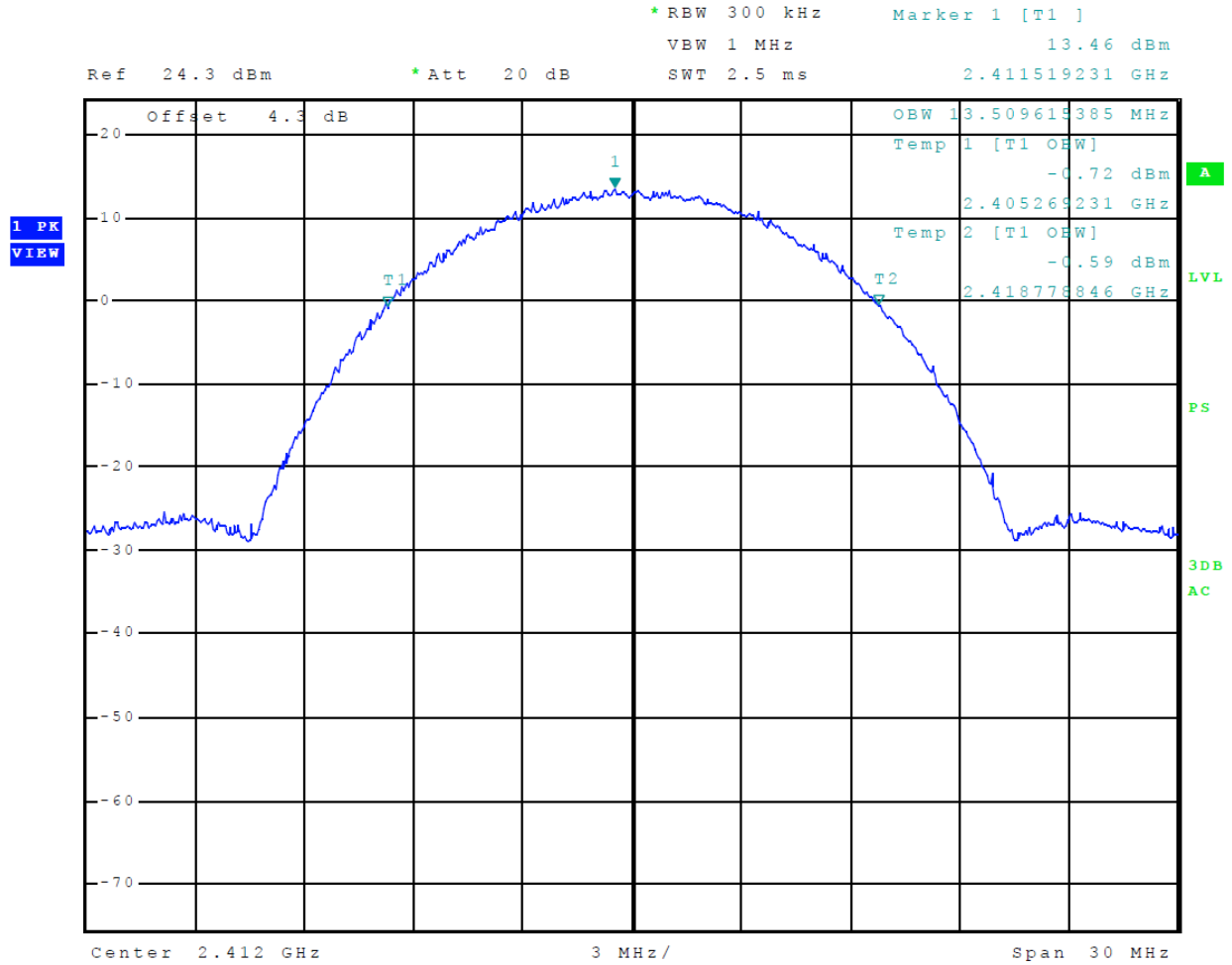

Figure 18 Plot of 99% Occupied Bandwidth Mode 5 802.11b

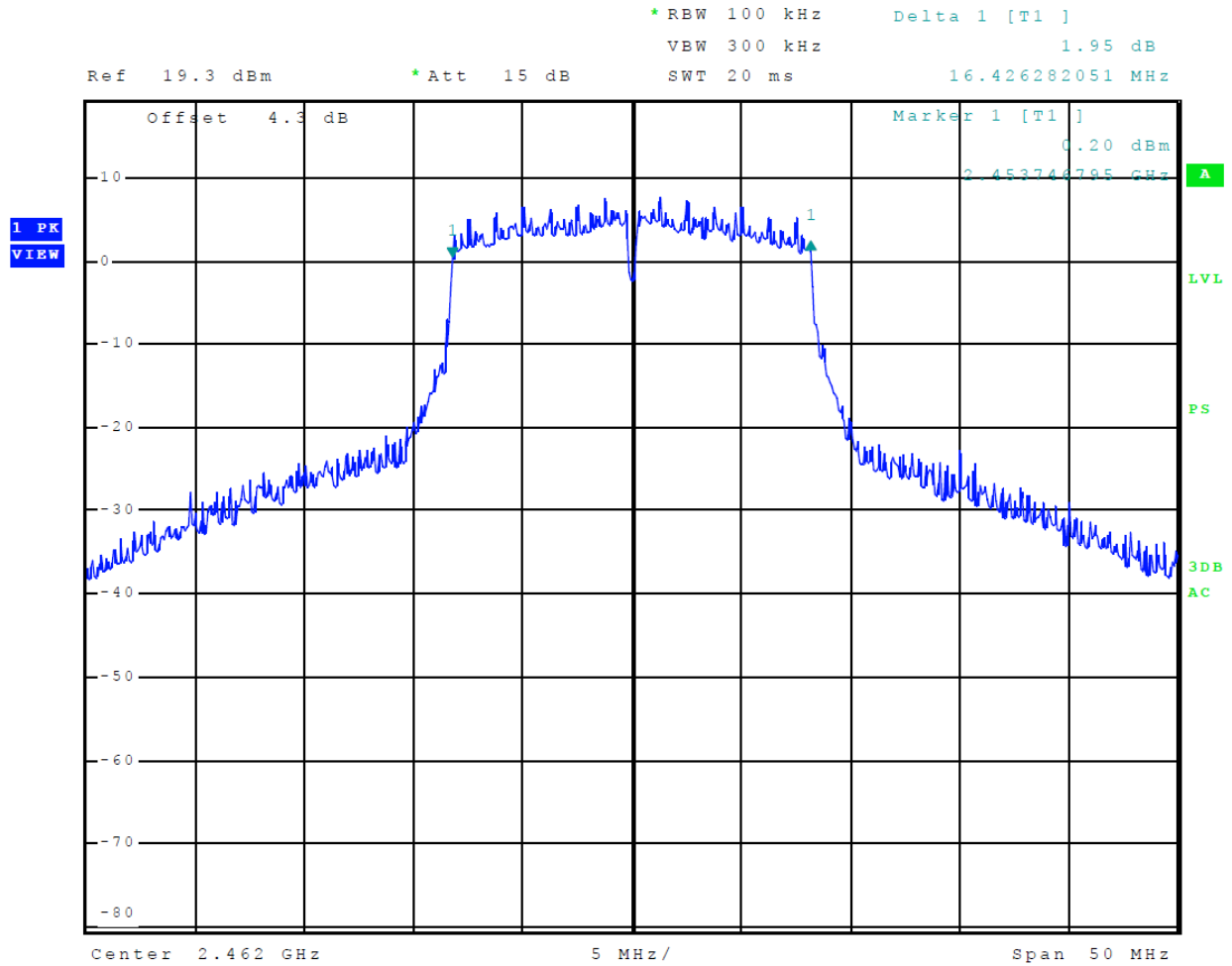

Figure 19 Plot of 6-dB Occupied Bandwidth Mode 6 802.11g

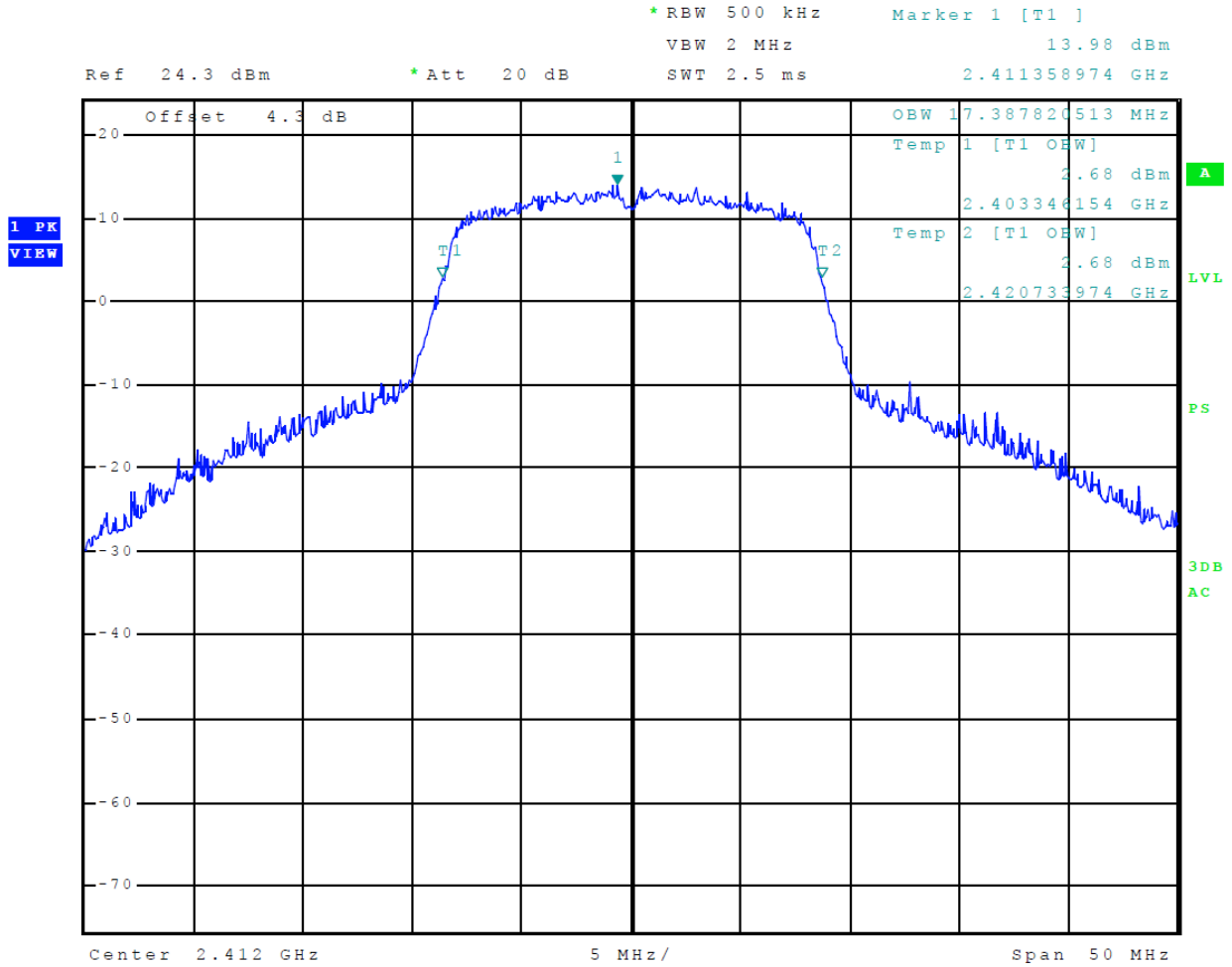

Figure 20 Plot of 99% Occupied Bandwidth Mode 7 802.11g

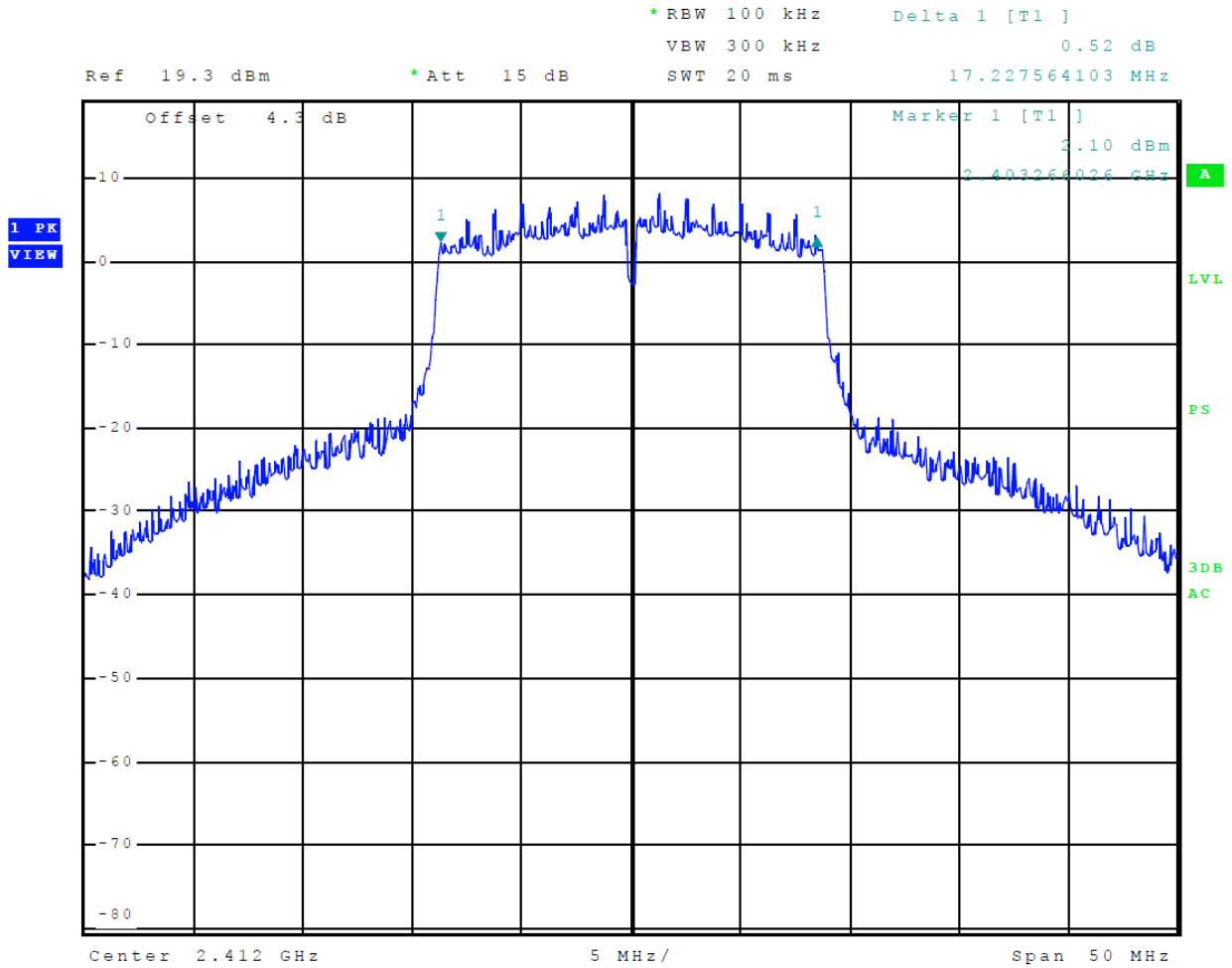

Figure 21 Plot of 6-dB Occupied Bandwidth Mode 8 802.11n

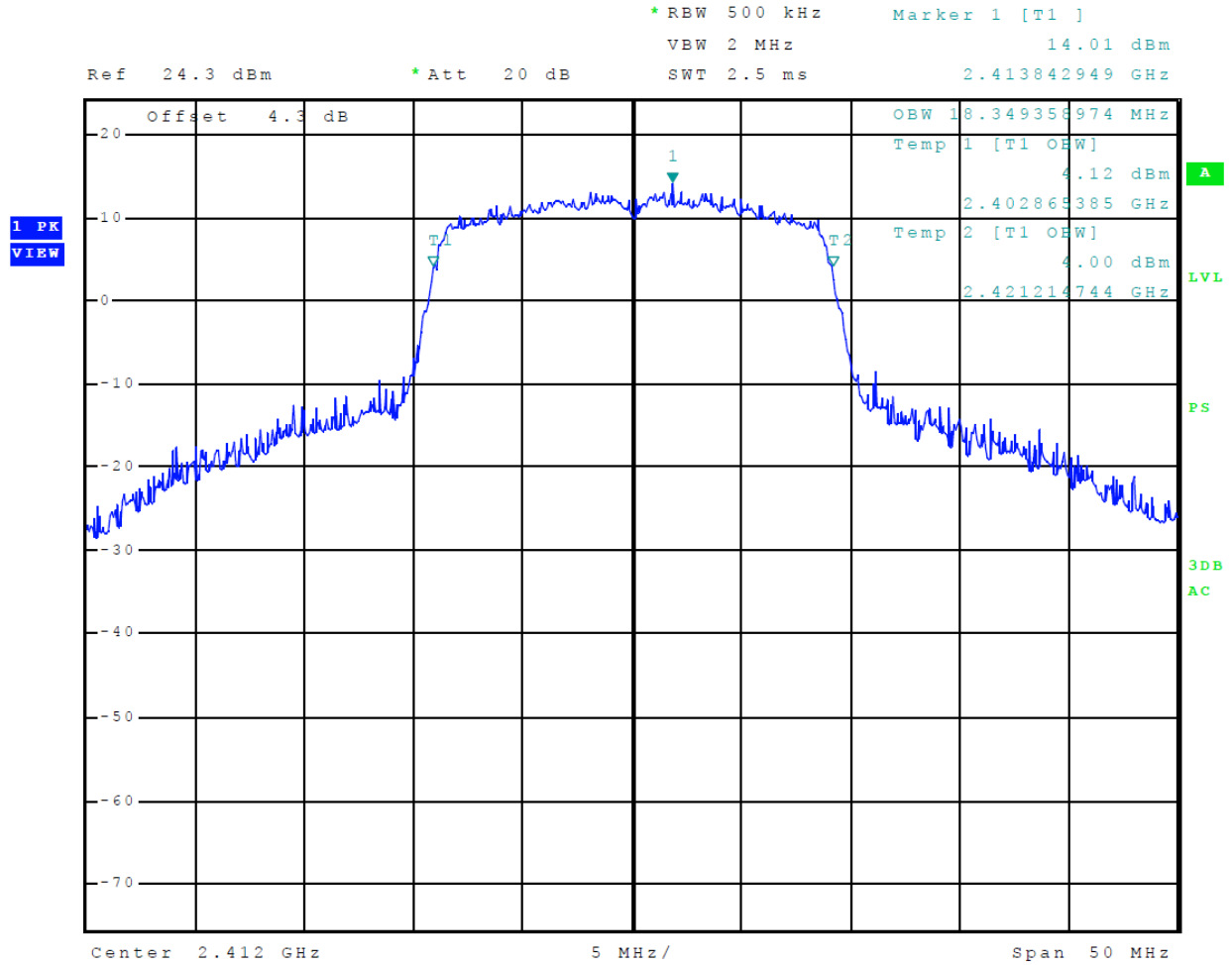

Figure 22 Plot of 99% Occupied Bandwidth Mode 9 802.11n

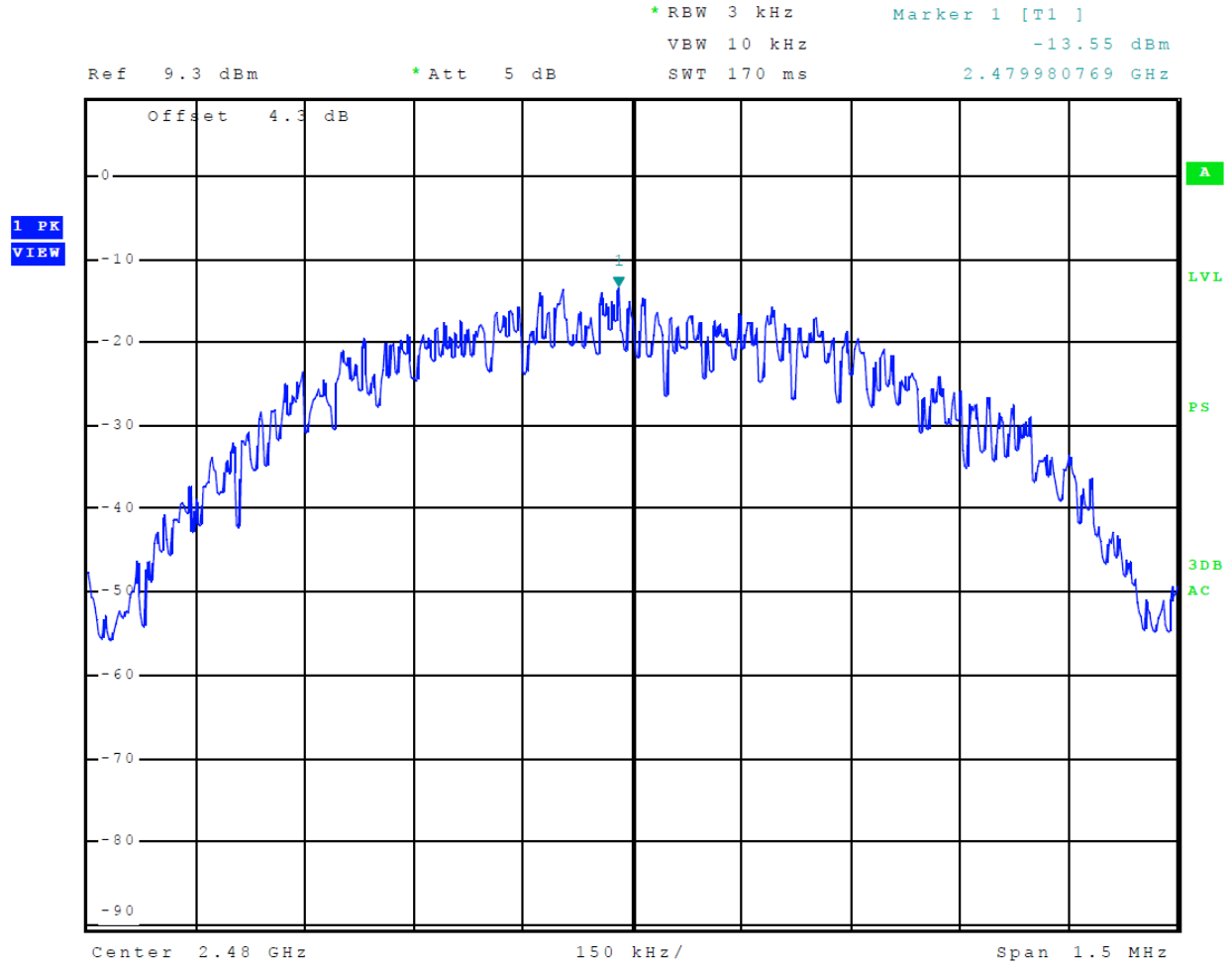

Figure 23 Plot of Transmitter Power Spectral Density Mode 4 BLE

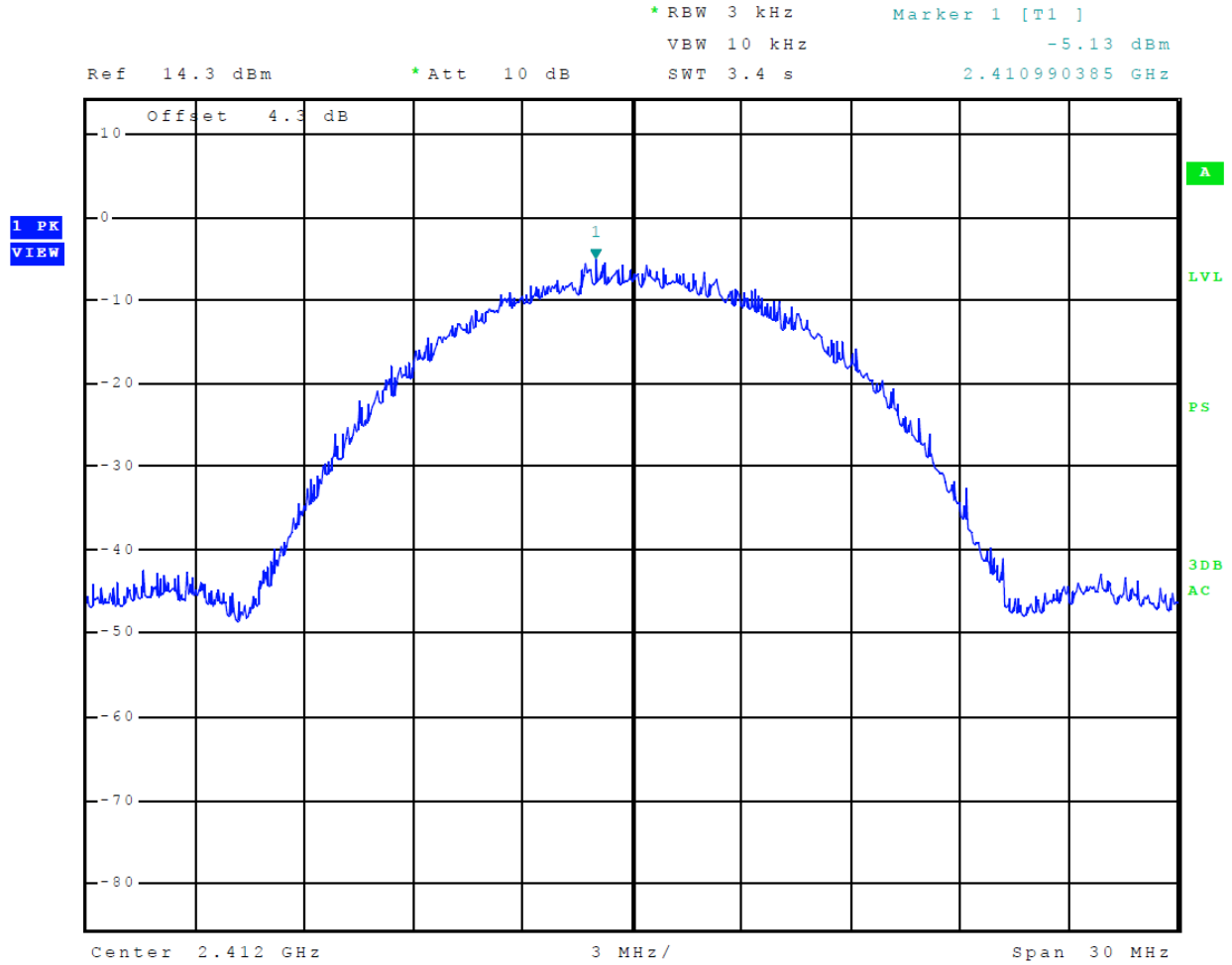

Figure 24 Plot of Transmitter Power Spectral Density Mode 5 802.11b

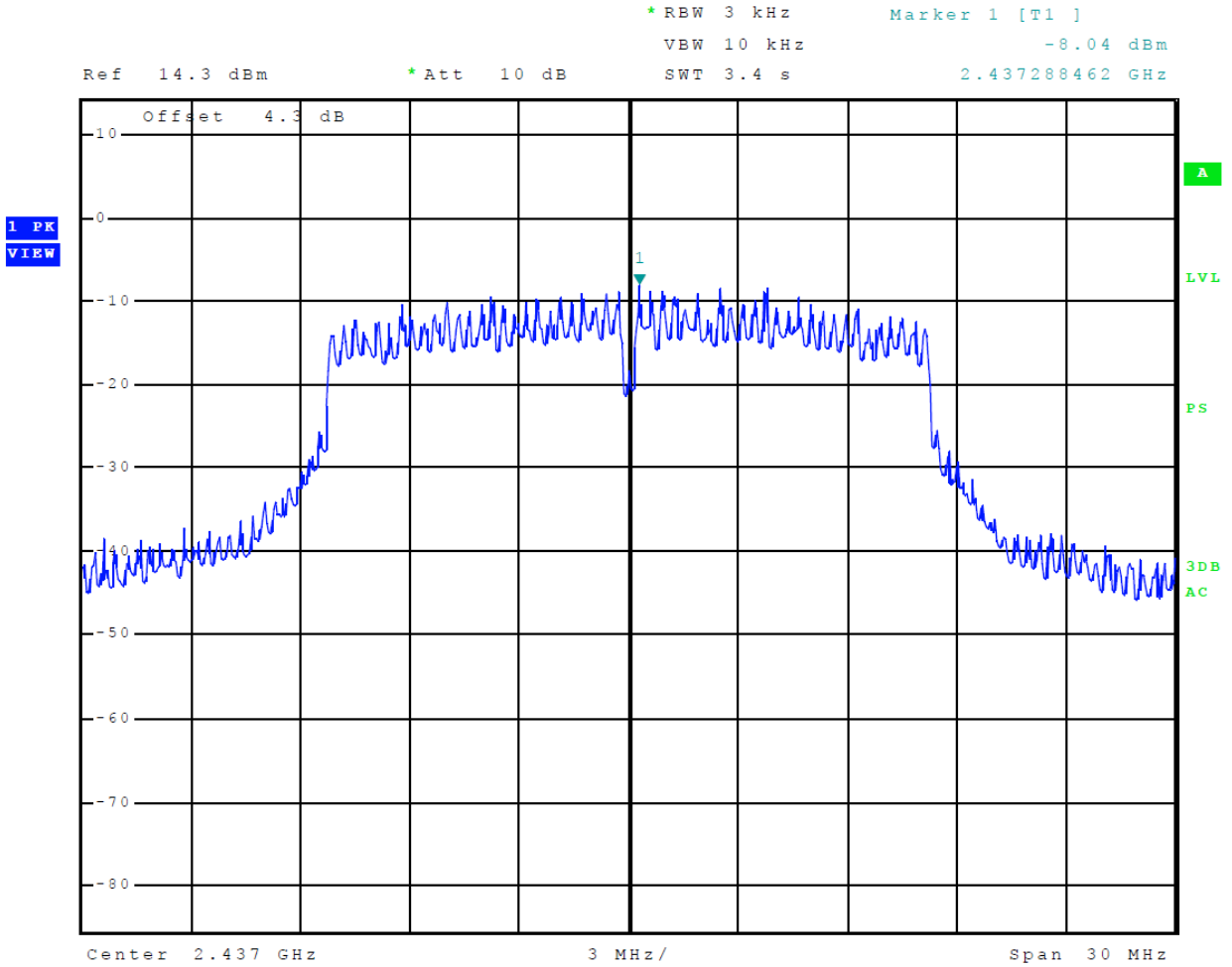

Figure 25 Plot of Transmitter Power Spectral Density Mode 6 802.11g

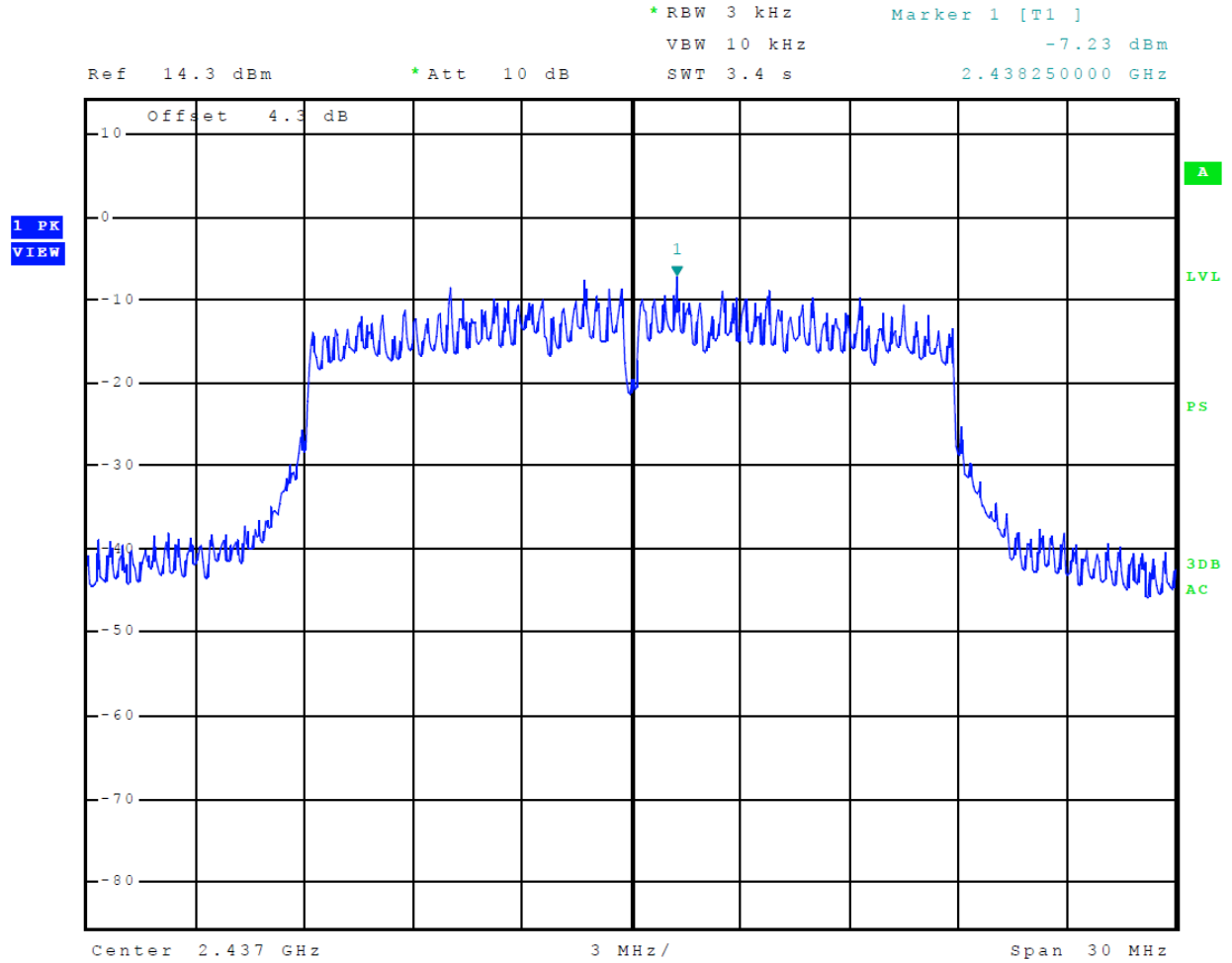

Figure 26 Plot of Transmitter Power Spectral Density Mode 7 802.11n

Transmitter Emissions Data

Table 8 Transmitter Radiated Emissions Mode 4 BLE

Frequency in MHz	Horizontal Peak (dBµV/m)	Horizontal Average (dBµV/m)	Vertical Peak (dBµV/m)	Vertical Average (dBµV/m)	Limit @ 3m (dBµV/m)	Horizontal Margin (dB)	Vertical Margin (dB)
2402.0	--	--	--	--	--	--	--
4804.0	49.7	36.2	49.3	36.3	54.0	-17.8	-17.7
7206.0	53.2	40.3	53.2	40.3	54.0	-13.7	-13.7
9608.0	56.0	43.0	55.6	42.9	54.0	-11.0	-11.1
12010.0	60.7	46.7	59.3	46.7	54.0	-7.3	-7.3
14412.0	62.2	49.3	62.0	49.3	54.0	-4.7	-4.7
16814.0	64.6	51.8	64.8	51.8	54.0	-2.2	-2.2
2442.0	--	--	--	--	--	--	--
4884.0	49.7	36.2	49.8	36.1	54.0	-17.8	-17.9
7326.0	53.1	40.4	54.0	40.4	54.0	-13.6	-13.6
9768.0	55.5	43.0	56.3	43.1	54.0	-11.0	-10.9
12210.0	60.6	47.1	60.4	47.1	54.0	-6.9	-6.9
14652.0	62.0	49.3	62.5	49.3	54.0	-4.7	-4.7
17094.0	64.1	51.6	64.7	51.6	54.0	-2.4	-2.4
2480.0	--	--	--	--	--	--	--
4960.0	49.9	36.2	49.5	36.2	54.0	-17.8	-17.8
7440.0	53.8	40.5	53.2	40.5	54.0	-13.5	-13.5
9920.0	56.1	43.0	56.9	43.0	54.0	-11.0	-11.0
12400.0	60.0	47.1	59.5	47.0	54.0	-6.9	-7.0
14880.0	62.1	48.9	61.9	48.9	54.0	-5.1	-5.1
17360.0	64.7	51.5	64.6	51.6	54.0	-2.5	-2.4

Other emissions present had amplitudes at least 20 dB below the limit. Peak and Quasi-Peak amplitude emissions are recorded for frequency below 1000 MHz. Peak and Average amplitude emissions are recorded for frequency range above 1000 MHz.

Table 9 Transmitter Radiated Emissions Mode 5 802.11b

Frequency in MHz	Horizontal Peak (dBµV/m)	Horizontal Average (dBµV/m)	Vertical Peak (dBµV/m)	Vertical Average (dBµV/m)	Limit @ 3m (dBµV/m)	Horizontal Margin (dB)	Vertical Margin (dB)
2412.0	--	--	--	--	--	--	--
4824.0	49.4	35.9	51.2	36.0	54.0	-18.1	-18.0
7236.0	53.3	40.2	53.2	40.2	54.0	-13.8	-13.8
9648.0	56.7	43.5	56.4	43.7	54.0	-10.5	-10.3
12060.0	59.0	45.9	58.5	45.9	54.0	-8.1	-8.1
14472.0	62.1	49.0	61.5	49.0	54.0	-5.0	-5.0
16884.0	64.2	51.5	64.1	51.5	54.0	-2.5	-2.5
2437.0	--	--	--	--	--	--	--
4874.0	49.5	36.0	49.4	36.0	54.0	-18.0	-18.0
7311.0	53.7	40.2	53.3	40.2	54.0	-13.8	-13.8
9748.0	55.8	43.1	56.9	43.1	54.0	-10.9	-10.9
12185.0	59.9	46.9	60.1	46.9	54.0	-7.1	-7.1
14622.0	62.5	49.5	62.1	49.5	54.0	-4.5	-4.5
17059.0	65.7	52.5	65.0	52.5	54.0	-1.5	-1.5
2462.0	--	--	--	--	--	--	--
4924.0	49.0	36.2	49.4	36.1	54.0	-17.8	-17.9
7386.0	52.9	40.3	53.6	40.4	54.0	-13.7	-13.6
9848.0	56.2	43.7	56.4	43.6	54.0	-10.3	-10.4
12310.0	59.9	47.1	59.7	47.1	54.0	-6.9	-6.9
14772.0	62.8	49.6	62.5	49.6	54.0	-4.4	-4.4
17234.0	64.2	51.2	64.5	51.2	54.0	-2.8	-2.8

Other emissions present had amplitudes at least 20 dB below the limit. Peak and Quasi-Peak amplitude emissions are recorded for frequency below 1000 MHz. Peak and Average amplitude emissions are recorded for frequency range above 1000 MHz.

Table 10 Transmitter Radiated Emissions Mode 6 802.11g

Frequency in MHz	Horizontal Peak (dBμV/m)	Horizontal Average (dBμV/m)	Vertical Peak (dBμV/m)	Vertical Average (dBμV/m)	Limit @ 3m (dBμV/m)	Horizontal Margin (dB)	Vertical Margin (dB)
2412.0	--	--	--	--	--	--	--
4824.0	52.4	36.1	51.5	36.0	54.0	-17.9	-18.0
7236.0	53.0	40.1	53.0	40.1	54.0	-13.9	-13.9
9648.0	56.4	43.5	56.6	43.4	54.0	-10.5	-10.6
12060.0	59.2	45.8	59.3	45.8	54.0	-8.2	-8.2
14472.0	61.8	49.1	62.1	49.1	54.0	-4.9	-4.9
16884.0	64.5	51.5	64.4	51.5	54.0	-2.5	-2.5
2437.0	--	--	--	--	--	--	--
4874.0	50.1	36.7	54.4	39.4	54.0	-17.3	-14.6
7311.0	53.1	40.4	54.3	40.9	54.0	-13.6	-13.1
9748.0	55.7	43.2	56.2	43.2	54.0	-10.8	-10.8
12185.0	60.4	46.9	60.3	46.9	54.0	-7.1	-7.1
14622.0	62.9	49.5	63.0	49.6	54.0	-4.5	-4.4
17059.0	65.5	52.5	65.4	52.5	54.0	-1.5	-1.5
2462.0	--	--	--	--	--	--	--
4924.0	50.4	36.6	50.1	36.5	54.0	-17.4	-17.5
7386.0	52.9	40.4	53.2	40.4	54.0	-13.6	-13.6
9848.0	56.6	43.5	56.1	43.4	54.0	-10.5	-10.6
12310.0	60.2	47.2	60.0	47.2	54.0	-6.8	-6.8
14772.0	62.6	49.6	62.2	49.6	54.0	-4.4	-4.4
17234.0	63.9	51.2	64.3	51.2	54.0	-2.8	-2.8

Other emissions present had amplitudes at least 20 dB below the limit. Peak and Quasi-Peak amplitude emissions are recorded for frequency below 1000 MHz. Peak and Average amplitude emissions are recorded for frequency range above 1000 MHz.

Table 11 Transmitter Radiated Emissions Mode 7 802.11n

Frequency in MHz	Horizontal Peak (dBµV/m)	Horizontal Average (dBµV/m)	Vertical Peak (dBµV/m)	Vertical Average (dBµV/m)	Limit @ 3m (dBµV/m)	Horizontal Margin (dB)	Vertical Margin (dB)
2412.0	--	--	--	--	--	--	--
4824.0	51.1	37.0	49.2	36.0	54.0	-17.0	-18.0
7236.0	53.5	40.3	52.8	40.1	54.0	-13.7	-13.9
9648.0	56.8	43.5	56.0	43.4	54.0	-10.5	-10.6
12060.0	59.2	45.7	58.9	45.8	54.0	-8.3	-8.2
14472.0	61.9	49.0	62.3	49.1	54.0	-5.0	-4.9
16884.0	64.8	51.6	64.9	51.8	54.0	-2.4	-2.2
2437.0	--	--	--	--	--	--	--
4874.0	49.8	36.6	50.8	36.8	54.0	-17.4	-17.2
7311.0	53.5	40.4	53.1	40.2	54.0	-13.6	-13.8
9748.0	56.1	43.3	55.9	43.2	54.0	-10.7	-10.8
12185.0	59.8	46.9	59.9	46.9	54.0	-7.1	-7.1
14622.0	62.7	49.6	62.6	49.6	54.0	-4.4	-4.4
17059.0	65.5	52.5	65.7	52.6	54.0	-1.5	-1.4
2462.0	--	--	--	--	--	--	--
4924.0	49.4	36.2	49.6	36.5	54.0	-17.8	-17.5
7386.0	53.1	40.3	53.6	40.3	54.0	-13.7	-13.7
9848.0	56.5	43.6	56.0	43.7	54.0	-10.4	-10.3
12310.0	60.6	47.2	60.2	47.2	54.0	-6.8	-6.8
14772.0	62.8	49.6	62.0	49.6	54.0	-4.4	-4.4
17234.0	64.9	51.3	64.0	51.2	54.0	-2.7	-2.8

Other emissions present had amplitudes at least 20 dB below the limit. Peak and Quasi-Peak amplitude emissions are recorded for frequency below 1000 MHz. Peak and Average amplitude emissions are recorded for frequency range above 1000 MHz.

Table 12 Transmitter Antenna Port Conducted Data modes 4, 5, 6, and 7

Frequency MHz	Antenna Port Average Output Power (Watts)	99% Occupied Bandwidth (kHz)	6-dB Occupied Bandwidth (kHz)	Peak Power Spectral Density (dBm)
Mode 4 BLE				
2402	0.002	1,028.8	721.2	-14.0
2442	0.002	1,033.7	727.6	-13.8
2480	0.002	1,033.7	727.6	-13.6
Mode 5 802.11b				
2412	0.058	13,509.6	9,182.7	-4.6
2437	0.062	13,461.5	9,375.0	-5.3
2462	0.065	13,413.5	9,519.2	-4.9
Mode 6 802.11g				
2412	0.039	17,387.8	16,426.3	-9.5
2437	0.062	17,227.6	16,346.2	-8.0
2462	0.043	17,387.8	16,426.3	-9.6
Mode 7 802.11n				
2412	0.038	18,349.4	17,227.6	-11.3
2437	0.059	18,189.1	17,307.7	-7.2
2462	0.041	18,349.4	17,227.6	-10.5

Summary of Results for Transmitter Radiated Emissions of Intentional Radiator

The EUT demonstrated compliance with the radiated and conducted emission requirements of CFR47 Subpart 15C Paragraph 15.247, RSS-247 Issue 2 and RSS-GEN Issue 5 emission requirements for Digital Transmission Systems. Highest average output power measured at the antenna port was 0.062 Watts. The highest peak power spectral density measured at the antenna port presented a minimum margin of -12.6 dB below the requirements. The EUT demonstrated a minimum margin of -1.4 dB below the harmonic emissions requirements. There were no other significantly measurable emissions in the restricted bands other than those recorded in this report. Other emissions were present with amplitudes at least 20 dB below the requirements. There were no other deviations or exceptions to the requirements.



Annex

- Annex A Measurement Uncertainty Calculations
- Annex B Test Equipment
- Annex C Rogers Qualifications
- Annex D Rogers Labs Certificate of Accreditation

Annex A Measurement Uncertainty Calculations

The measurement uncertainty was calculated for all measurements listed in this test report according To CISPR 16-4. Result of measurement uncertainty calculations are recorded below. Component and process variability of production devices similar to those tested may result in additional deviations. The manufacturer has the sole responsibility of continued compliance.

Measurement	Expanded Measurement Uncertainty $U_{(lab)}$
3 Meter Horizontal 0.009-1000 MHz Measurements	4.16
3 Meter Vertical 0.009-1000 MHz Measurements	4.33
3 Meter Measurements 1-18 GHz	5.14
3 Meter Measurements 18-40 GHz	5.16
10 Meter Horizontal Measurements 0.009-1000 MHz	4.15
10 Meter Vertical Measurements 0.009-1000 MHz	4.32
AC Line Conducted	1.75
Antenna Port Conducted power	1.17
Frequency Stability	1.00E-11
Temperature	1.6°C
Humidity	3%

Annex B Test Equipment

<u>Equipment</u>	<u>Manufacturer</u>	<u>Model (SN)</u>	<u>Band</u>	<u>Cal Date(m/d/y)</u>	<u>Due</u>
<input type="checkbox"/> LISN	FCC	FCC-LISN-50-25-10(1PA) (160611)	.15-30MHz	4/21/2020	4/21/2021
<input type="checkbox"/> LISN	Compliance Design	FCC-LISN-2.Mod.cd,(126)	.15-30MHz	10/14/2019	10/14/2020
<input checked="" type="checkbox"/> Cable	Huber & Suhner Inc.	Sucoflex102ea(L10M)(303073)	9kHz-40 GHz	10/14/2019	10/14/2020
<input type="checkbox"/> Cable	Huber & Suhner Inc.	Sucoflex102ea(1.5M)(303069)	9kHz-40 GHz	10/14/2019	10/14/2020
<input checked="" type="checkbox"/> Cable	Huber & Suhner Inc.	Sucoflex102ea(1.5M)(303070)	9kHz-40 GHz	10/14/2019	10/14/2020
<input type="checkbox"/> Cable	Belden	RG-58 (L1-CAT3-11509)	9kHz-30 MHz	10/14/2019	10/14/2020
<input type="checkbox"/> Cable	Belden	RG-58 (L2-CAT3-11509)	9kHz-30 MHz	10/14/2019	10/14/2020
<input checked="" type="checkbox"/> Antenna	Com Power	AL-130 (121055)	.001-30 MHz	10/14/2019	10/14/2020
<input type="checkbox"/> Antenna:	EMCO	6509	.001-30 MHz	10/16/2018	10/16/2020
<input type="checkbox"/> Antenna	ARA	BCD-235-B (169)	20-350MHz	10/14/2019	10/14/2020
<input type="checkbox"/> Antenna:	Schwarzbeck Model:	BBA 9106/VHBB 9124 (9124-627)		4/21/2020	4/21/2021
<input checked="" type="checkbox"/> Antenna	Sunol	JB-6 (A100709)	30-1000 MHz	10/14/2019	10/14/2020
<input type="checkbox"/> Antenna	ETS-Lindgren	3147 (40582)	200-1000MHz	10/14/2019	10/14/2020
<input type="checkbox"/> Antenna:	Schwarzbeck Model:	VULP 9118 A (VULP 9118 A-534)		4/21/2020	4/21/2021
<input checked="" type="checkbox"/> Antenna	ETS-Lindgren	3117 (200389)	1-18 GHz	4/21/2020	4/23/2022
<input type="checkbox"/> Antenna	Com Power	AH-118 (10110)	1-18 GHz	10/14/2019	10/14/2020
<input checked="" type="checkbox"/> Antenna	Com Power	AH-840 (101046)	18-40 GHz	4/21/2020	4/21/2021
<input checked="" type="checkbox"/> Analyzer	Rohde & Schwarz	ESU40 (100108)	20Hz-40GHz	5/15/2020	5/15/2021
<input checked="" type="checkbox"/> Analyzer	Rohde & Schwarz	ESW44 (101534)	20Hz-44GHz	1/27/2020	1/27/2021
<input type="checkbox"/> Analyzer	Rohde & Schwarz	FS-Z60, 90, 140, and 220	40GHz-220GHz	12/22/2017	12/22/2027
<input checked="" type="checkbox"/> Amplifier	Com-Power	PA-010 (171003)	100Hz-30MHz	10/14/2019	10/14/2020
<input checked="" type="checkbox"/> Amplifier	Com-Power	CPPA-102 (01254)	1-1000 MHz	10/14/2019	10/14/2020
<input checked="" type="checkbox"/> Amplifier	Com-Power	PAM-118A (551014)	0.5-18 GHz	10/14/2019	10/14/2020
<input checked="" type="checkbox"/> Amplifier	Com-Power	PAM-840A (461328)	18-40 GHz	10/14/2019	10/14/2020
<input checked="" type="checkbox"/> Power Meter	Agilent	N1911A with N1921A	0.05-40 GHz	4/21/2020	4/21/2021
<input type="checkbox"/> Generator	Rohde & Schwarz	SMB100A6 (100150)	20Hz-6 GHz	4/21/2020	4/21/2021
<input type="checkbox"/> Generator	Rohde & Schwarz	SMBV100A6 (260771)	20Hz-6 GHz	4/21/2020	4/21/2021
<input type="checkbox"/> RF Filter	Micro-Tronics	BRC50722 (009).9G notch	30-18000 MHz	4/21/2020	4/21/2021
<input type="checkbox"/> RF Filter	Micro-Tronics	HPM50114 (017)1.5G HPF	30-18000 MHz	4/21/2020	4/21/2021
<input checked="" type="checkbox"/> RF Filter	Micro-Tronics	HPM50117 (063) 3G HPF	30-18000 MHz	4/21/2020	4/21/2021
<input type="checkbox"/> RF Filter	Micro-Tronics	HPM50105 (059) 6G HPF	30-18000 MHz	4/21/2020	4/21/2021
<input type="checkbox"/> RF Filter	Micro-Tronics	BRM50702 (172) 2G notch	30-18000 MHz	4/21/2020	4/21/2021
<input type="checkbox"/> RF Filter	Micro-Tronics	BRC50703 (G102) 5G notch	30-18000 MHz	4/21/2020	4/21/2021
<input type="checkbox"/> RF Filter	Micro-Tronics	BRC50705 (024) 5G notch	30-18000 MHz	4/21/2020	4/21/2021
<input type="checkbox"/> Attenuator	Fairview	SA6NFN100W-40 (1625)	30-18000 MHz	4/21/2020	4/18/2021
<input checked="" type="checkbox"/> Attenuator	Mini-Circuits	VAT-3W2+ (1436)	30-6000 MHz	4/21/2020	4/21/2021
<input type="checkbox"/> Attenuator	Mini-Circuits	VAT-3W2+ (1445)	30-6000 MHz	4/21/2020	4/21/2021
<input type="checkbox"/> Attenuator	Mini-Circuits	VAT-3W2+ (1735)	30-6000 MHz	4/21/2020	4/21/2021
<input type="checkbox"/> Attenuator	Mini-Circuits	VAT-6W2+ (1438)	30-6000 MHz	4/21/2020	4/21/2021
<input type="checkbox"/> Attenuator	Mini-Circuits	VAT-6W2+ (1736)	30-6000 MHz	4/21/2020	4/21/2021
<input checked="" type="checkbox"/> Weather station	Davis	6312 (A81120N075)		11/4/2019	11/4/2020

Rogers Labs, Inc.
4405 West 259th Terrace
Louisburg, KS 66053
Phone/Fax: (913) 837-3214
Revision 1

Garmin International, Inc.
Model: A04117
Test: 200924
Test to: CFR47 15C, RSS-Gen RSS-247
File: A04117 DTS TstRpt 200924

SN's: 3342384349 / 3342384330
FCC ID: IPH-04117
IC: 1792A-04117
Date: November 23, 2020
Page 63 of 66



List of Test Equipment

	Calibration	Date (m/d/y)	Due
<input type="checkbox"/> Frequency Counter: Leader LDC-825 (8060153		4/21/2020	4/21/2021
<input type="checkbox"/> LISN: Com-Power Model LI-220A		10/14/2019	10/14/2020
<input type="checkbox"/> LISN: Com-Power Model LI-550C		10/14/2019	10/14/2020
<input type="checkbox"/> ISN: Com-Power Model ISN T-8		4/21/2020	4/21/2021
<input type="checkbox"/> LISN: Fischer Custom Communications Model: FCC-LISN-50-16-2-08		4/21/2020	4/21/2021
<input type="checkbox"/> Cable Huber & Suhner Inc. Sucoflex102ea(1.5M)(303070) 9kHz-40 GHz		10/14/2019	10/14/2020
<input type="checkbox"/> Cable Huber & Suhner Inc. Sucoflex102ea(1.5M)(303072) 9kHz-40 GHz		10/14/2019	10/14/2020
<input type="checkbox"/> Cable Huber & Suhner Inc. Sucoflex102ea(L4M)(281184) 9kHz-40 GHz		10/14/2019	10/14/2020
<input type="checkbox"/> Cable Huber & Suhner Inc. Sucoflex102ea(L10M)(317546)9kHz-40 GHz		10/14/2019	10/14/2020
<input type="checkbox"/> Cable Time Microwave 4M-750HF290-750 (4M) 9kHz-24 GHz		10/14/2019	10/14/2020
<input type="checkbox"/> RF Filter Micro-Tronics BRC17663 (001) 9.3-9.5 notch 30-1800 MHz		4/21/2020	4/21/2021
<input type="checkbox"/> RF Filter Micro-Tronics BRC19565 (001) 9.2-9.6 notch 30-1800 MHz		10/16/2018	4/21/2021
<input type="checkbox"/> Analyzer HP 8562A (3051A05950) 9kHz-125GHz		4/21/2020	4/21/2021
<input type="checkbox"/> Analyzer HP External Mixers11571, 11970 25GHz-110GHz		4/18/2015	4/18/2025
<input type="checkbox"/> Analyzer HP 8591EM (3628A00871)		4/21/2020	4/21/2021
<input type="checkbox"/> Antenna: Solar 9229-1 & 9230-1		2/22/2020	2/22/2021
<input type="checkbox"/> CDN: Com-Power Model CDN325E		10/14/2019	10/14/2020
<input type="checkbox"/> Injection Clamp Luthi Model EM101		10/14/2019	10/14/2020
<input type="checkbox"/> Oscilloscope Scope: Tektronix MDO 4104		2/22/2020	2/22/2021
<input type="checkbox"/> EMC Transient Generator HVT TR 3000		2/22/2020	2/22/2021
<input type="checkbox"/> AC Power Source (Ametech, California Instruments)		2/22/2020	2/22/2021
<input type="checkbox"/> Field Intensity Meter: EFM-018		2/22/2020	2/22/2021
<input type="checkbox"/> ESD Simulator: MZ-15		2/22/2020	2/22/2021
<input type="checkbox"/> R.F. Power Amp ACS 230-50W			not required
<input type="checkbox"/> R.F. Power Amp EIN Model: A301			not required
<input type="checkbox"/> R.F. Power Amp A.R. Model: 10W 1010M7			not required
<input type="checkbox"/> R.F. Power Amp A.R. Model: 50U1000			not required
<input checked="" type="checkbox"/> Shielded Room			not required

Rogers Labs, Inc.
 4405 West 259th Terrace
 Louisburg, KS 66053
 Phone/Fax: (913) 837-3214
 Revision 1

Garmin International, Inc.
 Model: A04117
 Test: 200924
 Test to: CFR47 15C, RSS-Gen RSS-247
 File: A04117 DTS TstRpt 200924

SN's: 3342384349 / 3342384330
 FCC ID: IPH-04117
 IC: 1792A-04117
 Date: November 23, 2020
 Page 64 of 66



Annex C Rogers Qualifications

Scot D. Rogers, Engineer

Rogers Labs, Inc.

Mr. Rogers has approximately 35 years’ experience in the field of electronics. Working experience includes six years working in the automated controls industry and 6 years working with the design, development and testing of radio communications and electronic equipment.

Positions Held:

- Systems Engineer: A/C Controls Mfg. Co., Inc. 6 Years
- Electrical Engineer: Rogers Consulting Labs, Inc. 5 Years
- Electrical Engineer: Rogers Labs, Inc. Current

Educational Background:

- Bachelor of Science Degree in Electrical Engineering from Kansas State University
- Bachelor of Science Degree in Business Administration Kansas State University
- Several Specialized Training courses and seminars pertaining to Microprocessors and Software programming

Rogers Labs, Inc.
 4405 West 259th Terrace
 Louisburg, KS 66053
 Phone/Fax: (913) 837-3214
 Revision 1

Garmin International, Inc.
 Model: A04117
 Test: 200924
 Test to: CFR47 15C, RSS-Gen RSS-247
 File: A04117 DTS TstRpt 200924

SN’s: 3342384349 / 3342384330
 FCC ID: IPH-04117
 IC: 1792A-04117
 Date: November 23, 2020
 Page 65 of 66

Annex D Laboratory Certificate of Accreditation

United States Department of Commerce
National Institute of Standards and Technology



Certificate of Accreditation to ISO/IEC 17025:2017

NVLAP LAB CODE: 200087-0

Rogers Labs, Inc.
Louisburg, KS

*is accredited by the National Voluntary Laboratory Accreditation Program for specific services,
listed on the Scope of Accreditation, for:*

Electromagnetic Compatibility & Telecommunications

*This laboratory is accredited in accordance with the recognized International Standard ISO/IEC 17025:2017.
This accreditation demonstrates technical competence for a defined scope and the operation of a laboratory quality
management system (refer to joint ISO-ILAC-IAF Communiqué dated January 2009).*

2020-02-25 through 2021-03-31
Effective Dates

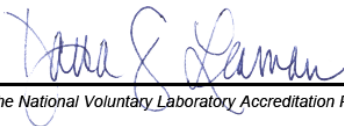

For the National Voluntary Laboratory Accreditation Program

Rogers Labs, Inc.
4405 West 259th Terrace
Louisburg, KS 66053
Phone/Fax: (913) 837-3214
Revision 1

Garmin International, Inc.
Model: A04117
Test: 200924
Test to: CFR47 15C, RSS-Gen RSS-247
File: A04117 DTS TstRpt 200924

SN's: 3342384349 / 3342384330
FCC ID: IPH-04117
IC: 1792A-04117
Date: November 23, 2020
Page 66 of 66