

FCC Test Report

FCC ID : IPH-03942
Equipment : Marine Stereo
Model No. : A03942
Brand Name : FUSION
Applicant : Garmin International, Inc.
Address : 1200 E. 151st Street Olathe, KS 66062 United States
Standard : 47 CFR FCC Part 15.247
Received Date : Oct. 27, 2020
Tested Date : Nov. 04 ~ Nov. 12, 2020

We, International Certification Corporation, would like to declare that the tested sample has been evaluated and in compliance with the requirement of the above standards. The test results contained in this report refer exclusively to the product. It may be duplicated completely for legal use with the approval of the applicant. It shall not be reproduced except in full without the written approval of our laboratory.

Reviewed by:



Along Chen / Assistant Manager

Approved by:



Gary Chang / Manager



Table of Contents

1	GENERAL DESCRIPTION	5
1.1	Information.....	5
1.2	Local Support Equipment List	8
1.3	Test Setup Chart	9
1.4	The Equipment List	10
1.5	Test Standards	11
1.6	Reference Guidance	11
1.7	Deviation from Test Standard and Measurement Procedure.....	11
1.8	Measurement Uncertainty	11
2	TEST CONFIGURATION.....	12
2.1	Testing Facility	12
2.2	The Worst Test Modes and Channel Details	12
3	TRANSMITTER TEST RESULTS	13
3.1	Unwanted Emissions into Restricted Frequency Bands	13
3.2	Unwanted Emissions into Non-Restricted Frequency Bands	30
3.3	Conducted Output Power	38
3.4	Number of Hopping Frequency	41
3.5	20dB and Occupied Bandwidth.....	45
3.6	Channel Separation.....	52
3.7	Number of Dwell Time.....	57
4	TEST LABORATORY INFORMATION	63

Release Record

Report No.	Version	Description	Issued Date
FR002701AD	Rev. 01	Initial issue	Mar. 17, 2021

Summary of Test Results

FCC Rules	Test Items	Measured	Result
15.207	Conducted Emissions	Note ¹	N/A
15.247(d) 15.209	Radiated Emissions	[dBuV/m at 3m]: 45.25MHz 38.99 (Margin -1.01dB) - QP	Pass
15.247(d)	Band Edge	Meet the requirement of limit	Pass
15.247(b)(1)	Conducted Output Power	Power [dBm]: 10.87	Pass
15.247(a)(1)(iii)	Number of Hopping Channels	Meet the requirement of limit	Pass
15.247(a)(1)	Hopping Channel Separation	Meet the requirement of limit	Pass
15.247(a)(1)(iii)	Dwell Time	Meet the requirement of limit	Pass
15.203	Antenna Requirement	Meet the requirement of limit	Pass

N/A means Not Applicable.

Note¹: The EUT consumes DC power, so the test is not required.

Declaration of Conformity:

The test results with all measurement uncertainty excluded are presented in accordance with the regulation limits or requirements declared by manufacturers.

Comments and Explanations:

The declared of product specification for EUT presented in the report are provided by the manufacturer, and the manufacturer takes all the responsibilities for the accuracy of product specification.

1 General Description

1.1 Information

1.1.1 Specification of the Equipment under Test (EUT)

RF General Information				
Frequency Range (MHz)	Bluetooth Mode	Ch. Frequency (MHz)	Channel Number	Data Rate
2400-2483.5	BR V4.2	2402-2480	0-78 [79]	1 Mbps
2400-2483.5	EDR V4.2	2402-2480	0-78 [79]	2 Mbps
2400-2483.5	EDR V4.2	2402-2480	0-78 [79]	3 Mbps

Note 1: RF output power specifies that Maximum Peak Conducted Output Power.
 Note 2: Bluetooth BR uses a GFSK.
 Note 3: Bluetooth EDR uses a combination of $\pi/4$ -DQPSK and 8DPSK.

1.1.2 Antenna Details

Ant. No.	Type	Connector	Gain (dBi)	Remarks
1	PIFA	N/A	1.72	---

1.1.3 Power Supply Type of Equipment under Test (EUT)

Power Supply Type	12Vdc
--------------------------	-------

1.1.4 Accessories

Accessories		
No.	Equipment	Description
1	Power cable	Brand: FUSION Model: Ca Assy, A Port, PWR/SPKR W/O IGTN & Telemute, FusConn Power Line: 0.2m non-shielded without core
2	Audio cable (x2)	Brand: FUSION Model: Ca Assy, B Port, RCA, Zone 1 L/R/S, Aux, FusConn Line: 0.2m shielded without core

1.1.5 Channel List

Frequency band (MHz)				2400~2483.5			
Channel	Frequency (MHz)	Channel	Frequency (MHz)	Channel	Frequency (MHz)	Channel	Frequency (MHz)
0	2402	20	2422	40	2442	60	2462
1	2403	21	2423	41	2443	61	2463
2	2404	22	2424	42	2444	62	2464
3	2405	23	2425	43	2445	63	2465
4	2406	24	2426	44	2446	64	2466
5	2407	25	2427	45	2447	65	2467
6	2408	26	2428	46	2448	66	2468
7	2409	27	2429	47	2449	67	2469
8	2410	28	2430	48	2450	68	2470
9	2411	29	2431	49	2451	69	2471
10	2412	30	2432	50	2452	70	2472
11	2413	31	2433	51	2453	71	2473
12	2414	32	2434	52	2454	72	2474
13	2415	33	2435	53	2455	73	2475
14	2416	34	2436	54	2456	74	2476
15	2417	35	2437	55	2457	75	2477
16	2418	36	2438	56	2458	76	2478
17	2419	37	2439	57	2459	77	2479
18	2420	38	2440	58	2460	78	2480
19	2421	39	2441	59	2461	---	---

1.1.6 Test Tool and Duty Cycle

Test Tool	north_iop_gui, v0.2	
Modulation Mode	Duty Cycle Of Test Signal (%)	Duty Factor (dB)
DH5	78.46%	1.05
3DH5	79.31%	1.01

1.1.7 Power Index of Test Tool

Modulation Mode	Test Frequency (MHz)		
	2402	2441	2480
GFSK/1Mbps	Default	Default	Default
$\pi/4$ -DQPSK /2Mbps	Default	Default	Default
8DPSK/3Mbps	Default	Default	Default

1.2 Local Support Equipment List

Support Equipment List					
No.	Equipment	Brand	Model	FCC ID	Remarks
1	AM/FM ANT	Techbrands	AR-3250	---	Provided by applicant.
2	USB Dongle	Strontium	Pollex 4 G	---	Provided by applicant.
3	power cable	FUSION	842716	---	Provided by applicant.
4	Speaker load (x2)	FUSION	L25J4R0E	---	Provided by applicant.
5	Audio cable (AUX In) (x2)	FUSION	H810KFZA	---	Provided by applicant.
6	Audio cable (AUX In) (x2)	FUSION	H810KFZA	---	Provided by applicant.
7	Audio cable (Line Out) (x6)	FUSION	H810KFZA	---	Provided by applicant.
8	Audio cable (Line Out) (x6)	FUSION	H810KFZA	---	Provided by applicant.
9	Audio load (x16)	---	---	---	Provided by applicant.
10	Battery	YUASA	38B19R	---	---
11	USB cable	FUSION	FUC200	---	Provided by applicant.

1.3 Test Setup Chart

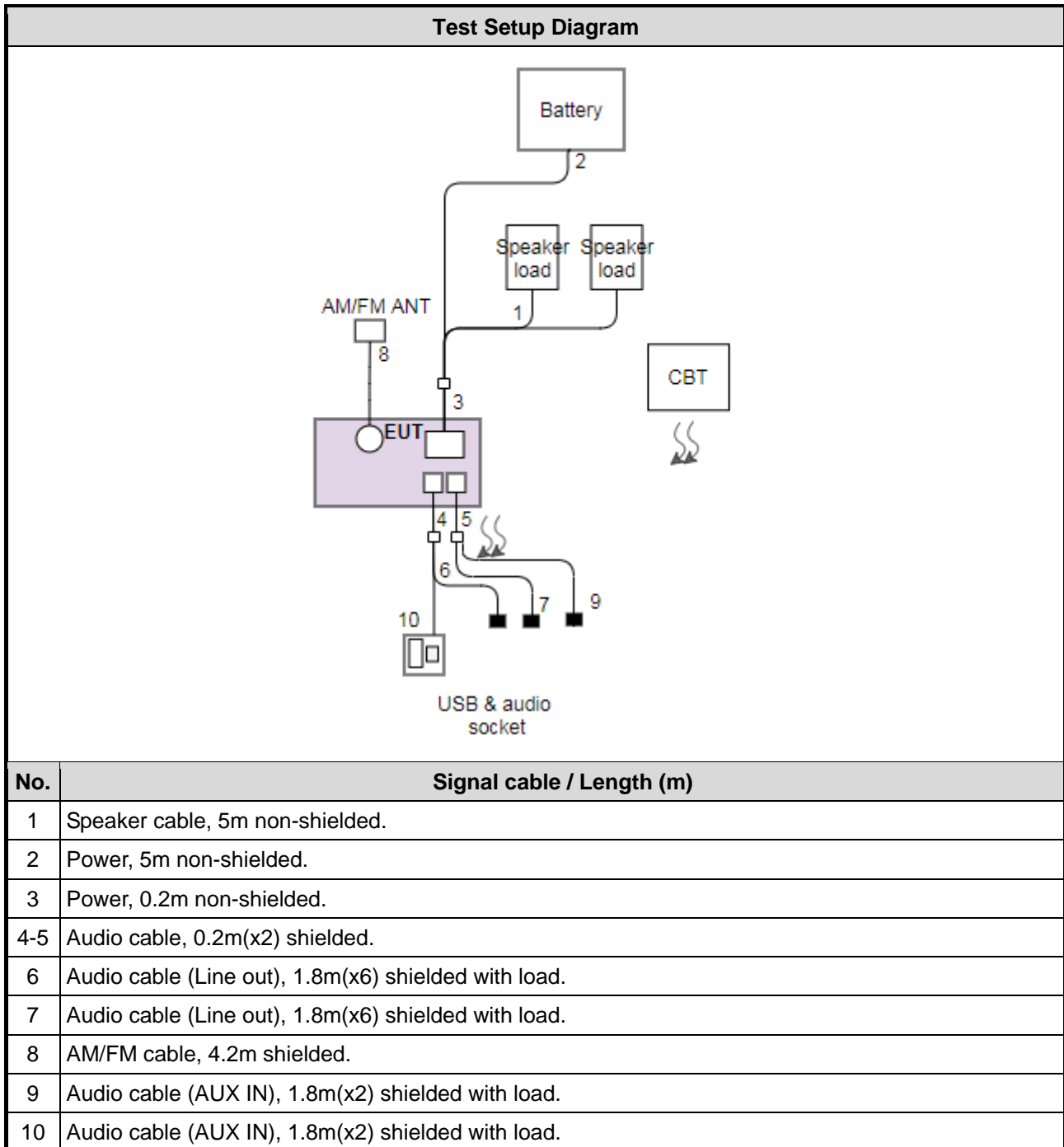

Note: AM/FM ANT and USB dongle & audio load & CBT are placed on testing table. The others are on remote testing area

1.4 The Equipment List

Test Item	Radiated Emission				
Test Site	966 chamber1 / (03CH01-WS)				
Tested Date	Nov. 04 ~ Nov. 10, 2020				
Instrument	Brand	Model No.	Serial No.	Calibration Date	Calibration Until
Spectrum Analyzer	R&S	FSV40	101499	Jan. 09, 2020	Jan. 08, 2021
Receiver	R&S	ESR3	101657	Feb. 14, 2020	Feb. 13, 2021
Bilog Antenna	SCHWARZBECK	VULB9168	VULB9168-685	Apr. 29, 2020	Apr. 28, 2021
Horn Antenna 1G-18G	SCHWARZBECK	BBHA 9120 D	BBHA 9120 D 1206	Dec. 27, 2019	Dec. 26, 2020
Horn Antenna 18G-40G	SCHWARZBECK	BBHA 9170	BBHA 9170517	Nov. 15, 2019	Nov. 14, 2020
Loop Antenna	R&S	HFH2-Z2	100330	Nov. 13, 2019	Nov. 12, 2020
Loop Antenna Cable	KOAX KABEL	101354-BW	101354-BW	Oct. 06, 2020	Oct. 05, 2021
Preamplifier	EMC	EMC02325	980187	Aug. 05, 2020	Aug. 04, 2021
Preamplifier	Agilent	83017A	MY39501309	Sep. 02, 2020	Sep. 01, 2021
Preamplifier	EMC	EMC184045B	980192	Jul. 21, 2020	Jul. 20, 2021
RF cable-3M	HUBER+SUHNER	SUCOFLEX104	MY22620/4	Sep. 26, 2020	Sep. 25, 2021
RF cable-8M	EMC	EMC104-SM-SM-80 00	181107	Sep. 26, 2020	Sep. 25, 2021
RF cable-1M	HUBER+SUHNER	SUCOFLEX104	MY22624/4	Sep. 26, 2020	Sep. 25, 2021
LF cable-0.8M	EMC	EMC8D-NM-NM-800	EMC8D-NM-NM-800 -001	Sep. 26, 2020	Sep. 25, 2021
LF cable-3M	EMC	EMC8D-NM-NM-300 0	131103	Sep. 26, 2020	Sep. 25, 2021
LF cable-13M	EMC	EMC8D-NM-NM-130 00	131104	Sep. 26, 2020	Sep. 25, 2021
Measurement Software	AUDIX	e3	6.120210g	NA	NA

Note: Calibration Interval of instruments listed above is one year.

Test Item	RF Conducted				
Test Site	(TH01-WS)				
Tested Date	Nov. 12, 2020				
Instrument	Brand	Model No.	Serial No.	Calibration Date	Calibration Until
Spectrum Analyzer	R&S	FSV40	101063	Apr. 30, 2020	Apr. 29, 2021
Power Meter	Anritsu	ML2495A	1241002	Nov. 04, 2020	Nov. 03, 2021
Power Sensor	Anritsu	MA2411B	1207366	Nov. 04, 2020	Nov. 03, 2021
DC POWER SOURCE	GW INSTRUK	GPC-6030D	GES855395	Nov. 09, 2020	Nov. 08, 2021
Measurement Software	Sporton	Sporton_1	1.3.30	NA	NA

Note: Calibration Interval of instruments listed above is one year.

1.5 Test Standards

47 CFR FCC Part 15.247

ANSI C63.10-2013

1.6 Reference Guidance

FCC KDB 558074 D01 15.247 Meas Guidance v05r02

1.7 Deviation from Test Standard and Measurement Procedure

None

1.8 Measurement Uncertainty

The measurement uncertainties given below are based on a 95% confidence level (based on a coverage factor ($k=2$)).

Measurement Uncertainty	
Parameters	Uncertainty
Bandwidth	± 34.130 Hz
Conducted power	± 0.808 dB
Power density	± 0.583 dB
Conducted emission	± 2.715 dB
Radiated emission ≤ 1 GHz	± 3.96 dB
Radiated emission > 1 GHz	± 4.51 dB
Time	$\pm 0.1\%$

2 Test Configuration

2.1 Testing Facility

Test Laboratory	International Certification Corporation
Test Site	TH01-WS
Address of Test Site	No.3-1, Lane 6, Wen San 3rd St., Kwei Shan Dist., Tao Yuan City 33381, Taiwan (R.O.C.)
Test Site	03CH03-WS
Address of Test Site	No.14-1, Lane 19, Wen San 3rd St., Kwei Shan Dist., Tao Yuan City 333, Taiwan (R.O.C.)

- FCC Designation No.: TW0009
- FCC site registration No.: 207696
- ISED#: 10807A
- CAB identifier: TW2732

2.2 The Worst Test Modes and Channel Details

Test item	Mode	Test Frequency (MHz)	Data Rate (Mbps)	Test Configuration
Radiated Emissions ≤ 1GHz	GFSK	2402	1Mbps	---
Radiated Emissions > 1GHz	GFSK 8DPSK	2402, 2441, 2480 2402, 2441, 2480	1Mbps 3Mbps	---
Conducted Output Power	GFSK π/4 DQPSK 8DPSK	2402, 2441, 2480 2402, 2441, 2480 2402, 2441, 2480	1Mbps 2Mbps 3Mbps	---
Number of Hopping Channels	GFSK π/4 DQPSK 8DPSK	2402~2480 2402~2480 2402~2480	1Mbps 2Mbps 3Mbps	---
Hopping Channel Separation 20dB and Occupied bandwidth	GFSK π/4 DQPSK 8DPSK	2402, 2441, 2480 2402, 2441, 2480 2402, 2441, 2480	1Mbps 2Mbps 3Mbps	---
Dwell Time	GFSK π/4 DQPSK 8DPSK	2441 2441 2441	1Mbps 2Mbps 3Mbps	---

3 Transmitter Test Results

3.1 Unwanted Emissions into Restricted Frequency Bands

3.1.1 Limit of Unwanted Emissions into Restricted Frequency Bands

Restricted Band Emissions Limit			
Frequency Range (MHz)	Field Strength (uV/m)	Field Strength (dBuV/m)	Measure Distance (m)
0.009~0.490	2400/F(kHz)	48.5 - 13.8	300
0.490~1.705	24000/F(kHz)	33.8 - 23	30
1.705~30.0	30	29	30
30~88	100	40	3
88~216	150	43.5	3
216~960	200	46	3
Above 960	500	54	3

Note 1:
Qusai-Peak value is measured for frequency below 1GHz except for 9–90 kHz, 110–490 kHz frequency band. Peak and average value are measured for frequency above 1GHz. The limit on average radio frequency emission is as above table. The limit on peak radio frequency emissions is 20 dB above the maximum permitted average emission limit

Note 2:
Measurements may be performed at a distance other than what is specified provided. When performing measurements at a distance other than that specified, the results shall be extrapolated to the specified distance using an extrapolation factor as below, Frequency at or above 30 MHz: 20 dB/decade Frequency below 30 MHz: 40 dB/decade.

3.1.2 Test Procedures

1. Measurement is made at a semi-anechoic chamber that incorporates a turntable allowing a EUT rotation of 360°. A continuously-rotating, remotely-controlled turntable is installed at the test site to support the EUT and facilitate determination of the direction of maximum radiation for each EUT emission frequency. The EUT is placed at test table. For emissions testing at or below 1 GHz, the table height is 80 cm above the reference ground plane. For emission measurements above 1 GHz, the table height is 1.5 m
2. Measurement is made with the antenna positioned in both the horizontal and vertical planes of polarization. The measurement antenna is varied in height (1m ~ 4m) above the reference ground plane to obtain the maximum signal strength. Distance between EUT and antenna is 3 m.
3. This investigation is performed with the EUT rotated 360°, the antenna height scanned between 1 m and 4 m, and the antenna rotated to repeat the measurements for both the horizontal and vertical antenna polarizations.

Note:

1. 120kHz measurement bandwidth of test receiver and Quasi-peak detector is for radiated emission below 1GHz.
2. Radiated emission above 1GHz / Peak value
RBW=1MHz, VBW=3MHz and Peak detector
Radiated emission above 1GHz / Average value for harmonics
The average value is: Average = Peak value + 20log(Duty cycle) Where the duty factor is calculated from following formula for DH5 packet type which has worst duty factor:
3.
$$20\log(\text{Duty cycle}) = 20\log \frac{1\text{s} / 1600 * 5}{100\text{ ms}} = -30.1\text{dB}$$
4. Radiated emission above 1GHz / Average value for other emissions
RBW=1MHz, VBW=1/T and Peak detector

3.1.3 Test Setup

Radiated Emissions below 1 GHz



Radiated Emissions above 1 GHz

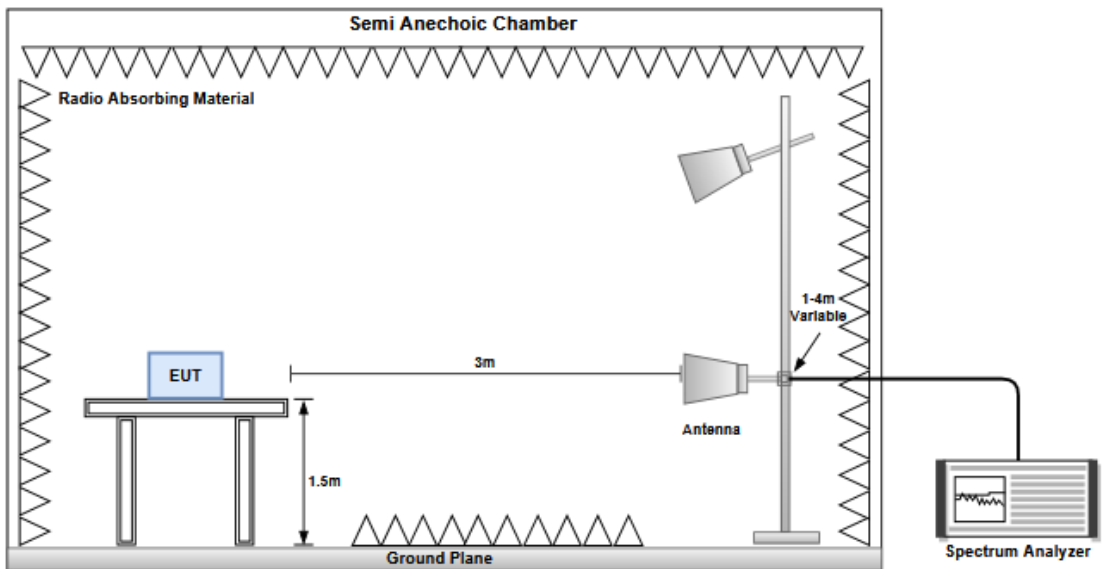

3.1.4 Transmitter Radiated Unwanted Emissions (Below 1GHz)

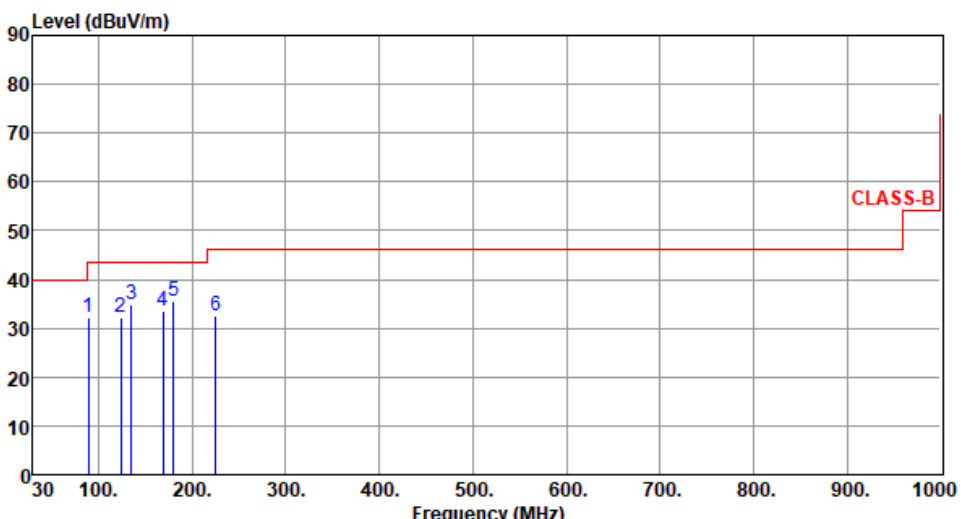
Modulation	GFSK	Test Freq. (MHz)	2402																																																																
Polarization	Horizontal																																																																		
Test By : Akun Chung Temperature(°C): 23 Humidity(%): 67																																																																			
																																																																			
	<table border="1"> <thead> <tr> <th>Freq. MHz</th> <th>Emission level dBuV/m</th> <th>Limit dBuV/m</th> <th>Margin dB</th> <th>SA reading dBuV</th> <th>Factor dB</th> <th>Remark</th> <th>ANT High cm</th> <th>Turn Table deg</th> </tr> </thead> <tbody> <tr> <td>1</td> <td>89.25</td> <td>32.36</td> <td>43.50</td> <td>-11.14</td> <td>47.21</td> <td>-14.85</td> <td>---</td> <td>---</td> </tr> <tr> <td>2</td> <td>124.22</td> <td>32.25</td> <td>43.50</td> <td>-11.25</td> <td>43.05</td> <td>-10.80</td> <td>---</td> <td>---</td> </tr> <tr> <td>3</td> <td>135.44</td> <td>34.87</td> <td>43.50</td> <td>-8.63</td> <td>44.42</td> <td>-9.55</td> <td>---</td> <td>---</td> </tr> <tr> <td>4</td> <td>168.52</td> <td>33.59</td> <td>43.50</td> <td>-9.91</td> <td>42.74</td> <td>-9.15</td> <td>---</td> <td>---</td> </tr> <tr> <td>5</td> <td>180.33</td> <td>35.63</td> <td>43.50</td> <td>-7.87</td> <td>46.10</td> <td>-10.47</td> <td>---</td> <td>---</td> </tr> <tr> <td>6</td> <td>224.85</td> <td>32.63</td> <td>46.00</td> <td>-13.37</td> <td>45.08</td> <td>-12.45</td> <td>---</td> <td>---</td> </tr> </tbody> </table>	Freq. MHz	Emission level dBuV/m	Limit dBuV/m	Margin dB	SA reading dBuV	Factor dB	Remark	ANT High cm	Turn Table deg	1	89.25	32.36	43.50	-11.14	47.21	-14.85	---	---	2	124.22	32.25	43.50	-11.25	43.05	-10.80	---	---	3	135.44	34.87	43.50	-8.63	44.42	-9.55	---	---	4	168.52	33.59	43.50	-9.91	42.74	-9.15	---	---	5	180.33	35.63	43.50	-7.87	46.10	-10.47	---	---	6	224.85	32.63	46.00	-13.37	45.08	-12.45	---	---			
Freq. MHz	Emission level dBuV/m	Limit dBuV/m	Margin dB	SA reading dBuV	Factor dB	Remark	ANT High cm	Turn Table deg																																																											
1	89.25	32.36	43.50	-11.14	47.21	-14.85	---	---																																																											
2	124.22	32.25	43.50	-11.25	43.05	-10.80	---	---																																																											
3	135.44	34.87	43.50	-8.63	44.42	-9.55	---	---																																																											
4	168.52	33.59	43.50	-9.91	42.74	-9.15	---	---																																																											
5	180.33	35.63	43.50	-7.87	46.10	-10.47	---	---																																																											
6	224.85	32.63	46.00	-13.37	45.08	-12.45	---	---																																																											
Note 1: Emission Level (dBuV/m) = SA Reading (dBuV/m) + Factor* (dB) *Factor includes antenna factor , cable loss and amplifier gain Note 2: Margin (dB) = Emission level (dBuV/m) – Limit (dBuV/m). Note 3: All spurious emissions below 30MHz are more than 20 dB below the limit.																																																																			

Modulation	GFSK	Test Freq. (MHz)	2402
Polarization	Vertical		

Test By : Akun Chung Temperature(°C): 23 Humidity(%): 67

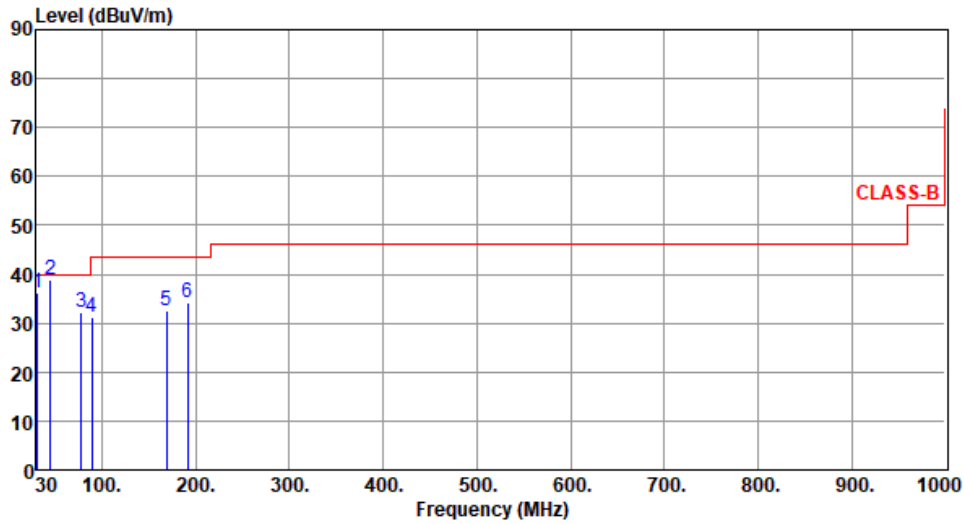

	Freq. MHz	Emission level dBuV/m	Limit dBuV/m	Margin dB	SA reading dBuV	Factor dB	Remark	ANT High cm	Turn Table deg
1	30.87	36.22	40.00	-3.78	46.32	-10.10	Peak	---	---
2	45.25	38.99	40.00	-1.01	47.79	-8.80	QP	100	264
3	77.74	32.32	40.00	-7.68	45.25	-12.93	Peak	---	---
4	89.04	31.06	43.50	-12.44	45.91	-14.85	Peak	---	---
5	168.65	32.42	43.50	-11.08	41.59	-9.17	Peak	---	---
6	191.82	34.24	43.50	-9.26	46.17	-11.93	Peak	---	---

Note 1: Emission Level (dBuV/m) = SA Reading (dBuV/m) + Factor* (dB)

*Factor includes antenna factor , cable loss and amplifier gain

Note 2: Margin (dB) = Emission level (dBuV/m) – Limit (dBuV/m).

Note 3: All spurious emissions below 30MHz are more than 20 dB below the limit.

3.1.5 Transmitter Radiated Unwanted Emissions (Above 1GHz) for GFSK

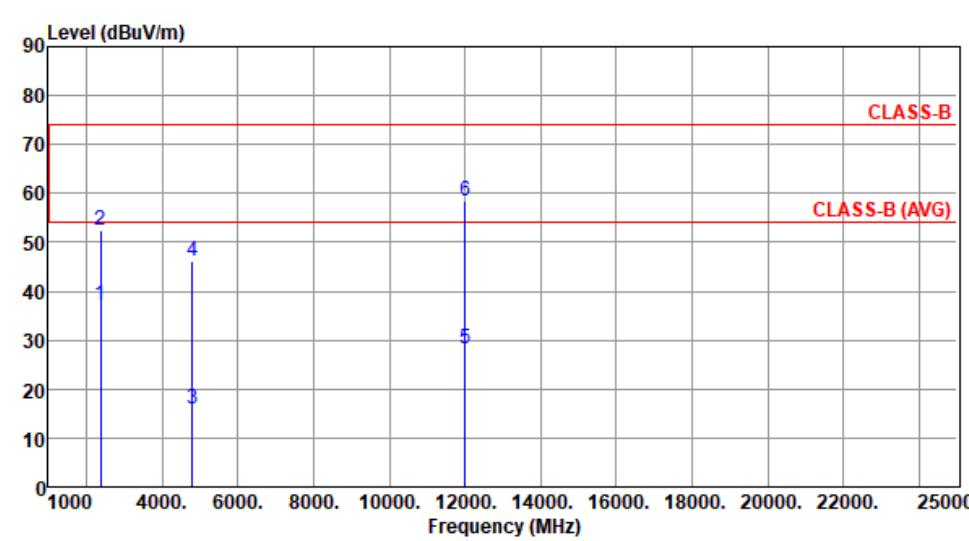
Modulation	GFSK	Test Freq. (MHz)	2402						
Polarization	Horizontal								
Test By : BRAD WU Temperature(°C): 23 Humidity(%): 66									
									
	Freq.	Emission level	Limit	Margin	SA reading	Factor	Remark	ANT High	Turn Table
	MHz	dBuV/m	dBuV/m	dB	dBuV	dB		cm	deg
1	2390.00	37.28	54.00	-16.72	39.12	-1.84	Average	321	228
2	2390.00	52.46	74.00	-21.54	54.30	-1.84	Peak	321	228
3	4804.00	16.05	54.00	-37.95	11.04	5.01	Average	100	3
4	4804.00	46.15	74.00	-27.85	41.14	5.01	Peak	100	3
5	12010.00	28.19	54.00	-25.81	13.69	14.50	Average	100	34
6	12010.00	58.29	74.00	-15.71	43.79	14.50	Peak	100	34

Note 1: Emission Level (dBuV/m) = SA Reading (dBuV/m) + Factor* (dB)
*Factor includes antenna factor , cable loss and amplifier gain
Note 2: Margin (dB) = Emission level (dBuV/m) – Limit (dBuV/m).

Modulation	GFSK	Test Freq. (MHz)	2402
Polarization	Vertical		

Test By :BRAD WU Temperature(°C):23 Humidity(%):66

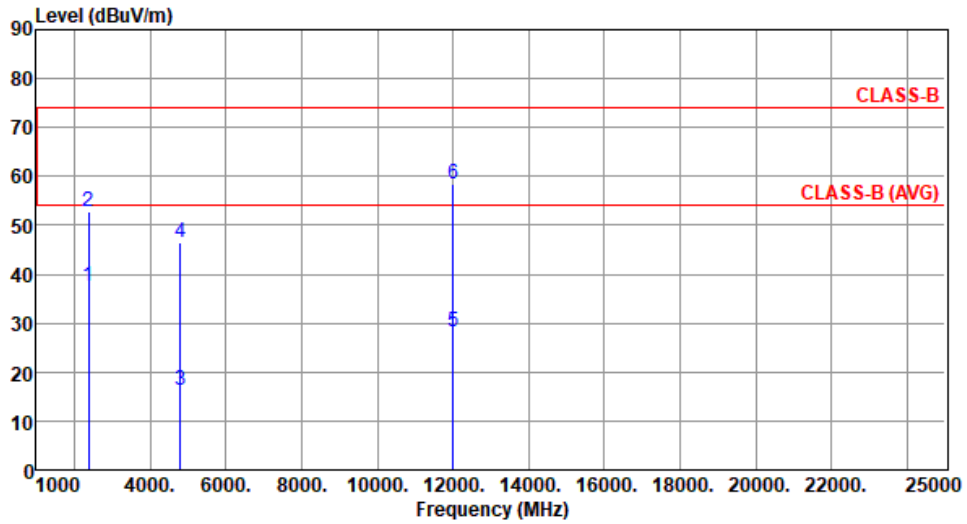

	Freq. MHz	Emission level dBuV/m	Limit dBuV/m	Margin dB	SA reading dBuV	Factor dB	Remark	ANT High cm	Turn Table deg
1	2390.00	37.41	54.00	-16.59	39.25	-1.84	Average	191	8
2	2390.00	52.81	74.00	-21.19	54.65	-1.84	Peak	191	8
3	4804.00	16.35	54.00	-37.65	11.34	5.01	Average	100	306
4	4804.00	46.45	74.00	-27.55	41.44	5.01	Peak	100	306
5	12010.00	28.33	54.00	-25.67	13.83	14.50	Average	100	24
6	12010.00	58.43	74.00	-15.57	43.93	14.50	Peak	100	24

Note 1: Emission Level (dBuV/m) = SA Reading (dBuV/m) + Factor* (dB)

*Factor includes antenna factor , cable loss and amplifier gain

Note 2: Margin (dB) = Emission level (dBuV/m) – Limit (dBuV/m).

Modulation	GFSK	Test Freq. (MHz)	2441
Polarization	Horizontal		

Test By :BRAD WU Temperature(°C):23 Humidity(%):66

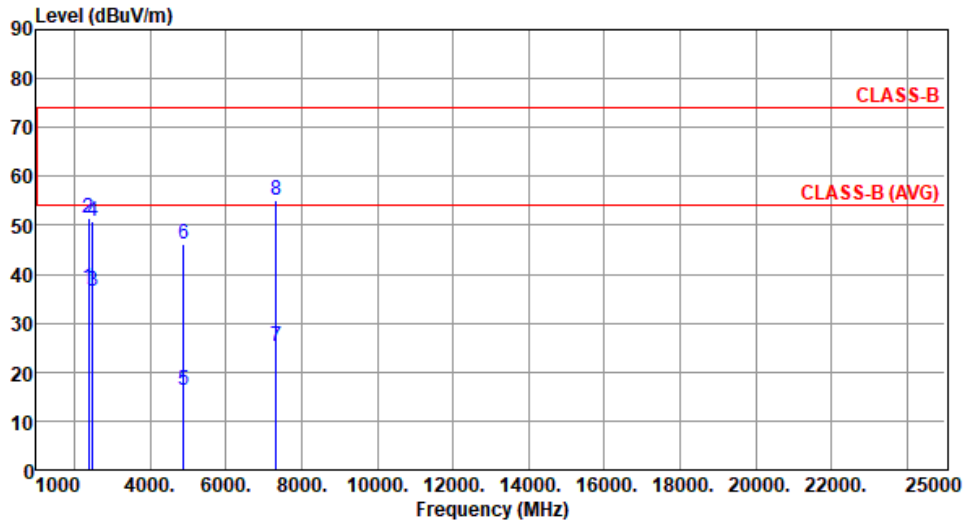

	Freq. MHz	Emission level dBuV/m	Limit dBuV/m	Margin dB	SA reading dBuV	Factor dB	Remark	ANT High cm	Turn Table deg
1	2390.00	37.23	54.00	-16.77	39.07	-1.84	Average	329	225
2	2390.00	51.50	74.00	-22.50	53.34	-1.84	Peak	329	225
3	2483.50	36.68	54.00	-17.32	38.48	-1.80	Average	329	225
4	2483.50	50.84	74.00	-23.16	52.64	-1.80	Peak	329	225
5	4882.00	16.11	54.00	-37.89	11.07	5.04	Average	100	5
6	4882.00	46.21	74.00	-27.79	41.17	5.04	Peak	100	5
7	7323.00	25.14	54.00	-28.86	14.84	10.30	Average	284	120
8	7323.00	55.24	74.00	-18.76	44.94	10.30	Peak	284	120

Note 1: Emission Level (dBuV/m) = SA Reading (dBuV/m) + Factor* (dB)

*Factor includes antenna factor , cable loss and amplifier gain

Note 2: Margin (dB) = Emission level (dBuV/m) – Limit (dBuV/m).

Modulation	GFSK	Test Freq. (MHz)	2441
Polarization	Vertical		

Test By :BRAD WU Temperature(°C):23 Humidity(%):66

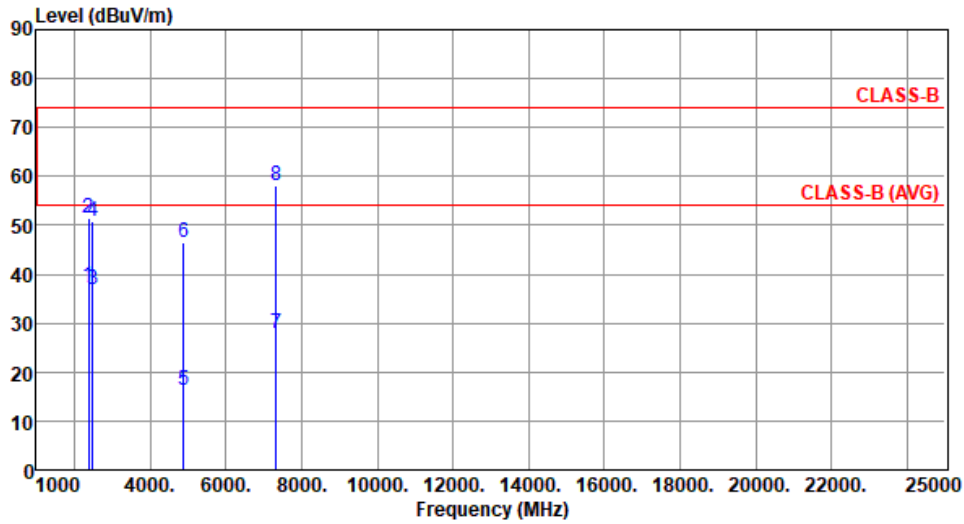

	Freq. MHz	Emission level dBuV/m	Limit dBuV/m	Margin dB	SA reading dBuV	Factor dB	Remark	ANT High cm	Turn Table deg
1	2390.00	37.41	54.00	-16.59	39.25	-1.84	Average	201	357
2	2390.00	51.64	74.00	-22.36	53.48	-1.84	Peak	201	357
3	2483.50	36.91	54.00	-17.09	38.71	-1.80	Average	201	357
4	2483.50	50.89	74.00	-23.11	52.69	-1.80	Peak	201	357
5	4882.00	16.41	54.00	-37.59	11.37	5.04	Average	100	310
6	4882.00	46.51	74.00	-27.49	41.47	5.04	Peak	100	310
7	7323.00	28.04	54.00	-25.96	17.74	10.30	Average	112	293
8	7323.00	58.14	74.00	-15.86	47.84	10.30	Peak	112	293

Note 1: Emission Level (dBuV/m) = SA Reading (dBuV/m) + Factor* (dB)

*Factor includes antenna factor , cable loss and amplifier gain

Note 2: Margin (dB) = Emission level (dBuV/m) – Limit (dBuV/m).

Modulation	GFSK	Test Freq. (MHz)	2480
Polarization	Horizontal		

Test By :BRAD WU Temperature(°C):23 Humidity(%):66

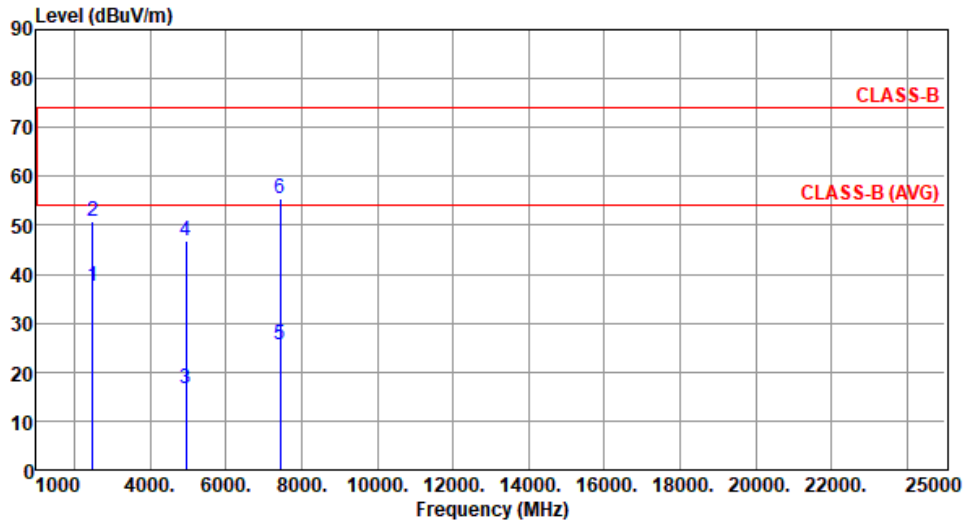

	Freq. MHz	Emission level dBuV/m	Limit dBuV/m	Margin dB	SA reading dBuV	Factor dB	Remark	ANT High cm	Turn Table deg
1	2483.50	37.48	54.00	-16.52	39.28	-1.80	Average	325	228
2	2483.50	50.69	74.00	-23.31	52.49	-1.80	Peak	325	228
3	4960.00	16.58	54.00	-37.42	11.28	5.30	Average	100	9
4	4960.00	46.68	74.00	-27.32	41.38	5.30	Peak	100	9
5	7440.00	25.49	54.00	-28.51	15.28	10.21	Average	282	125
6	7440.00	55.59	74.00	-18.41	45.38	10.21	Peak	282	125

Note 1: Emission Level (dBuV/m) = SA Reading (dBuV/m) + Factor* (dB)

*Factor includes antenna factor , cable loss and amplifier gain

Note 2: Margin (dB) = Emission level (dBuV/m) – Limit (dBuV/m).

Modulation	GFSK	Test Freq. (MHz)	2480
Polarization	Vertical		

Test By :BRAD WU Temperature(°C):23 Humidity(%):66

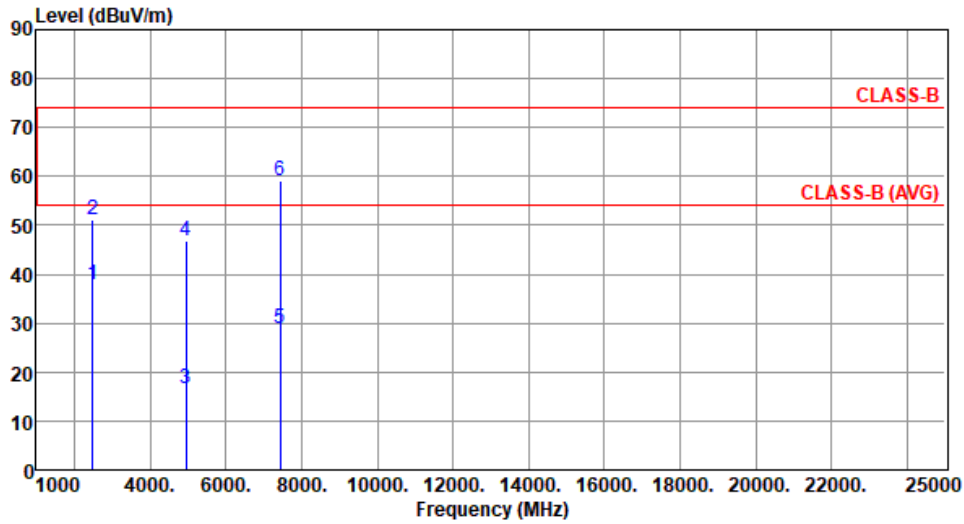

	Freq. MHz	Emission level dBuV/m	Limit dBuV/m	Margin dB	SA reading dBuV	Factor dB	Remark	ANT High cm	Turn Table deg
1	2483.50	37.85	54.00	-16.15	39.65	-1.80	Average	141	350
2	2483.50	50.99	74.00	-23.01	52.79	-1.80	Peak	141	350
3	4960.00	16.74	54.00	-37.26	11.44	5.30	Average	100	316
4	4960.00	46.84	74.00	-27.16	41.54	5.30	Peak	100	316
5	7440.00	28.85	54.00	-25.15	18.64	10.21	Average	110	296
6	7440.00	58.95	74.00	-15.05	48.74	10.21	Peak	110	296

Note 1: Emission Level (dBuV/m) = SA Reading (dBuV/m) + Factor* (dB)

*Factor includes antenna factor , cable loss and amplifier gain

Note 2: Margin (dB) = Emission level (dBuV/m) – Limit (dBuV/m).

3.1.6 Transmitter Radiated Unwanted Emissions (Above 1GHz) for 8DPSK

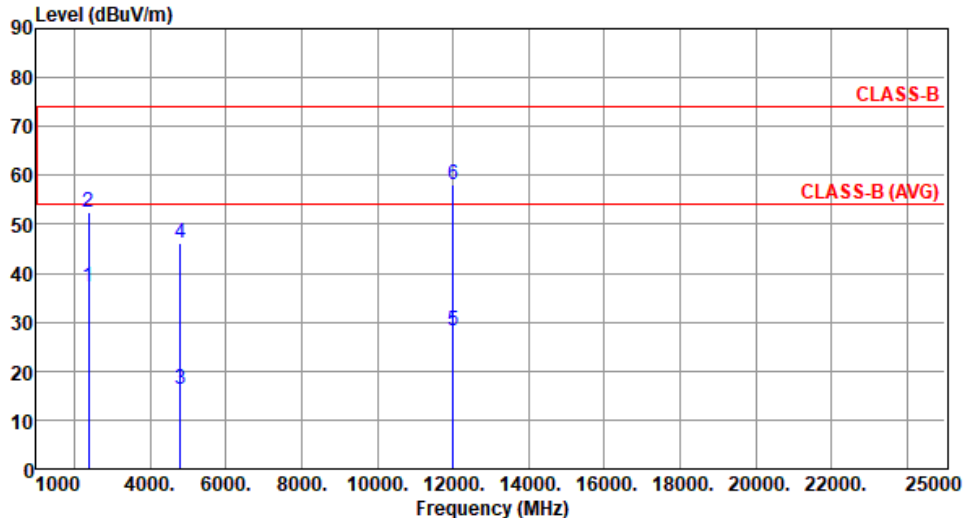
Modulation	8DPSK	Test Freq. (MHz)	2402						
Polarization	Horizontal								
Test By : BRAD WU Temperature(°C): 23 Humidity(%): 66									
									
	Freq. MHz	Emission level dBuV/m	Limit dBuV/m	Margin dB	SA reading dBuV	Factor dB	Remark	ANT High cm	Turn Table deg
1	2390.00	37.21	54.00	-16.79	39.05	-1.84	Average	316	225
2	2390.00	52.39	74.00	-21.61	54.23	-1.84	Peak	316	225
3	4804.00	16.14	54.00	-37.86	11.13	5.01	Average	100	19
4	4804.00	46.24	74.00	-27.76	41.23	5.01	Peak	100	19
5	12010.00	28.15	54.00	-25.85	13.65	14.50	Average	100	28
6	12010.00	58.25	74.00	-15.75	43.75	14.50	Peak	100	28

Note 1: Emission Level (dBuV/m) = SA Reading (dBuV/m) + Factor* (dB)
*Factor includes antenna factor , cable loss and amplifier gain
Note 2: Margin (dB) = Emission level (dBuV/m) – Limit (dBuV/m).

Modulation	8DPSK	Test Freq. (MHz)	2402
Polarization	Vertical		

Test By :BRAD WU Temperature(°C):23 Humidity(%) :66

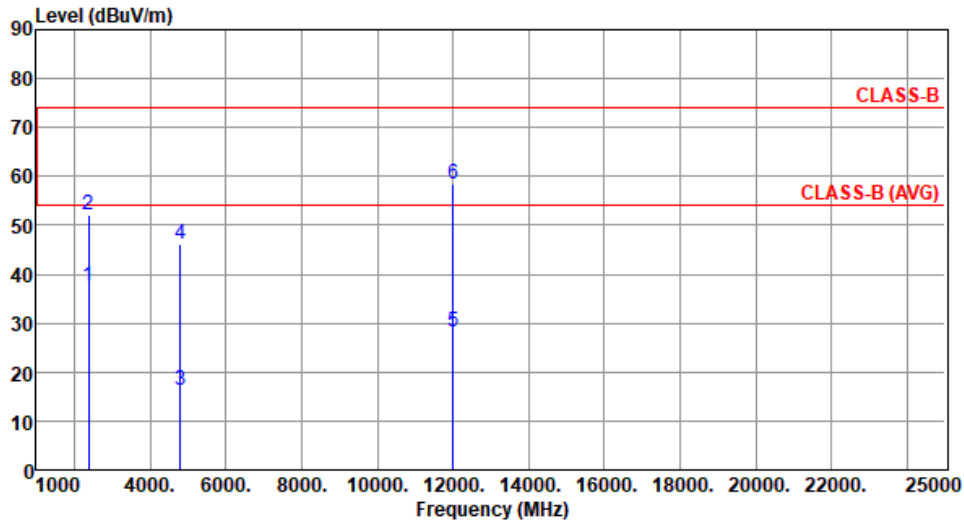

	Freq. MHz	Emission level dBuV/m	Limit dBuV/m	Margin dB	SA reading dBuV	Factor dB	Remark	ANT High cm	Turn Table deg
1	2390.00	37.38	54.00	-16.62	39.22	-1.84	Average	190	9
2	2390.00	52.21	74.00	-21.79	54.05	-1.84	Peak	190	9
3	4804.00	16.22	54.00	-37.78	11.21	5.01	Average	100	309
4	4804.00	46.32	74.00	-27.68	41.31	5.01	Peak	100	309
5	12010.00	28.29	54.00	-25.71	13.79	14.50	Average	100	29
6	12010.00	58.39	74.00	-15.61	43.89	14.50	Peak	100	29

Note 1: Emission Level (dBuV/m) = SA Reading (dBuV/m) + Factor* (dB)

*Factor includes antenna factor , cable loss and amplifier gain

Note 2: Margin (dB) = Emission level (dBuV/m) – Limit (dBuV/m).

Modulation	8DPSK	Test Freq. (MHz)	2441
Polarization	Horizontal		

Test By :BRAD WU Temperature(°C):23 Humidity(%) :66

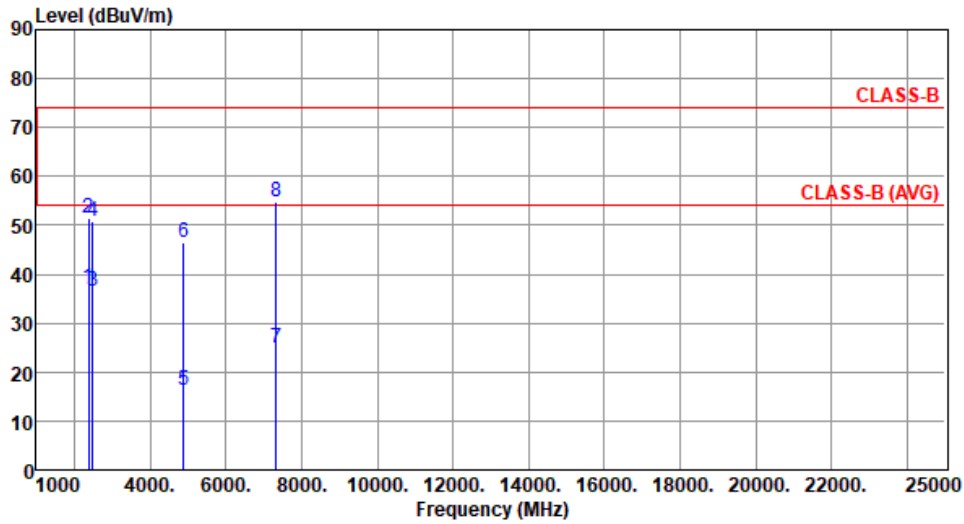

	Freq. MHz	Emission level dBuV/m	Limit dBuV/m	Margin dB	SA reading dBuV	Factor dB	Remark	ANT High cm	Turn Table deg
1	2390.00	37.26	54.00	-16.74	39.10	-1.84	Average	325	221
2	2390.00	51.45	74.00	-22.55	53.29	-1.84	Peak	325	221
3	2483.50	36.62	54.00	-17.38	38.42	-1.80	Average	325	221
4	2483.50	50.75	74.00	-23.25	52.55	-1.80	Peak	325	221
5	4882.00	16.39	54.00	-37.61	11.35	5.04	Average	100	8
6	4882.00	46.49	74.00	-27.51	41.45	5.04	Peak	100	8
7	7323.00	24.83	54.00	-29.17	14.53	10.30	Average	288	115
8	7323.00	54.93	74.00	-19.07	44.63	10.30	Peak	288	115

Note 1: Emission Level (dBuV/m) = SA Reading (dBuV/m) + Factor* (dB)
 *Factor includes antenna factor , cable loss and amplifier gain
 Note 2: Margin (dB) = Emission level (dBuV/m) – Limit (dBuV/m).

Modulation	8DPSK	Test Freq. (MHz)	2441
Polarization	Vertical		

Test By :BRAD WU Temperature(°C):23 Humidity(%) :66

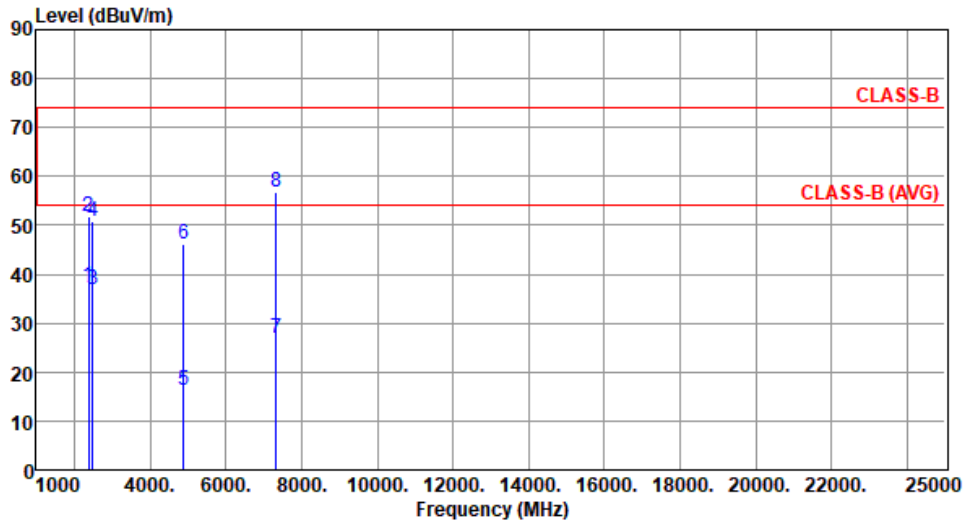

	Freq. MHz	Emission level dBuV/m	Limit dBuV/m	Margin dB	SA reading dBuV	Factor dB	Remark	ANT High cm	Turn Table deg
1	2390.00	37.46	54.00	-16.54	39.30	-1.84	Average	204	358
2	2390.00	51.68	74.00	-22.32	53.52	-1.84	Peak	204	358
3	2483.50	36.84	54.00	-17.16	38.64	-1.80	Average	204	358
4	2483.50	50.92	74.00	-23.08	52.72	-1.80	Peak	204	358
5	4882.00	16.19	54.00	-37.81	11.15	5.04	Average	100	336
6	4882.00	46.29	74.00	-27.71	41.25	5.04	Peak	100	336
7	7323.00	26.85	54.00	-27.15	16.55	10.30	Average	113	286
8	7323.00	56.95	74.00	-17.05	46.65	10.30	Peak	113	286

Note 1: Emission Level (dBuV/m) = SA Reading (dBuV/m) + Factor* (dB)

*Factor includes antenna factor , cable loss and amplifier gain

Note 2: Margin (dB) = Emission level (dBuV/m) – Limit (dBuV/m).

Modulation	8DPSK	Test Freq. (MHz)	2480
Polarization	Horizontal		

Test By :BRAD WU Temperature(°C):23 Humidity(%):66

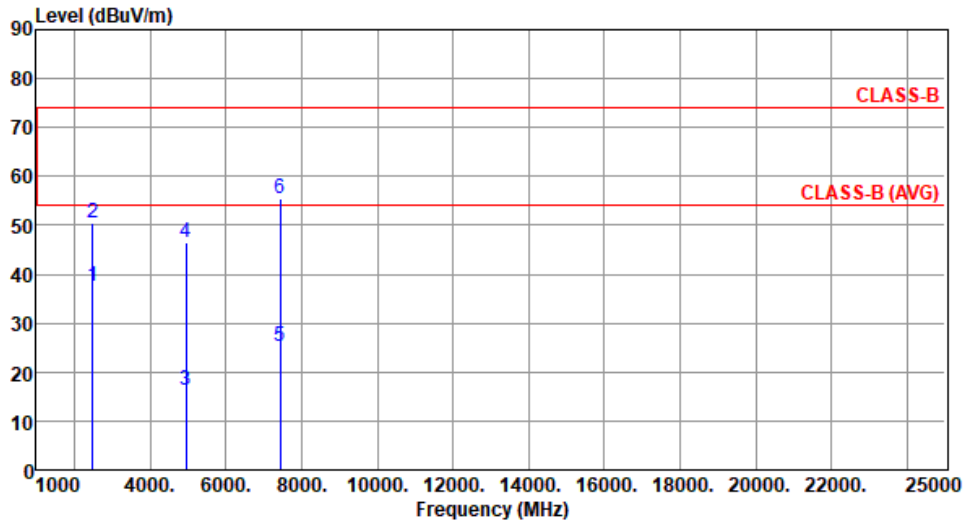

	Freq. MHz	Emission level dBuV/m	Limit dBuV/m	Margin dB	SA reading dBuV	Factor dB	Remark	ANT High cm	Turn Table deg
1	2483.50	37.51	54.00	-16.49	39.31	-1.80	Average	326	230
2	2483.50	50.62	74.00	-23.38	52.42	-1.80	Peak	326	230
3	4960.00	16.34	54.00	-37.66	11.04	5.30	Average	105	11
4	4960.00	46.44	74.00	-27.56	41.14	5.30	Peak	105	11
5	7440.00	25.38	54.00	-28.62	15.17	10.21	Average	279	126
6	7440.00	55.48	74.00	-18.52	45.27	10.21	Peak	279	126

Note 1: Emission Level (dBuV/m) = SA Reading (dBuV/m) + Factor* (dB)

*Factor includes antenna factor , cable loss and amplifier gain

Note 2: Margin (dB) = Emission level (dBuV/m) – Limit (dBuV/m).

Modulation	8DPSK	Test Freq. (MHz)	2480
Polarization	Vertical		

Test By :BRAD WU Temperature(°C):23 Humidity(%):66

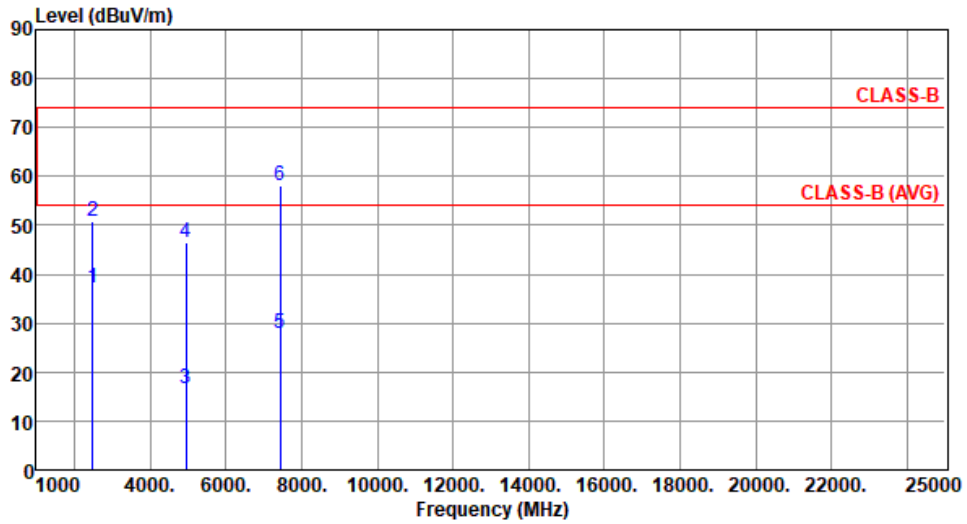

	Freq. MHz	Emission level dBuV/m	Limit dBuV/m	Margin dB	SA reading dBuV	Factor dB	Remark	ANT High cm	Turn Table deg
1	2483.50	37.24	54.00	-16.76	39.04	-1.80	Average	142	349
2	2483.50	50.86	74.00	-23.14	52.66	-1.80	Peak	142	349
3	4960.00	16.49	54.00	-37.51	11.19	5.30	Average	100	321
4	4960.00	46.59	74.00	-27.41	41.29	5.30	Peak	100	321
5	7440.00	28.06	54.00	-25.94	17.85	10.21	Average	104	293
6	7440.00	58.16	74.00	-15.84	47.95	10.21	Peak	104	293

Note 1: Emission Level (dBuV/m) = SA Reading (dBuV/m) + Factor* (dB)

*Factor includes antenna factor , cable loss and amplifier gain

Note 2: Margin (dB) = Emission level (dBuV/m) – Limit (dBuV/m).

3.2 Unwanted Emissions into Non-Restricted Frequency Bands

3.2.1 Limit of Unwanted Emissions into Non-Restricted Frequency Bands

Peak power in any 100 kHz bandwidth outside of the authorized frequency band shall be attenuated by at least 20 dB relative to the maximum in-band peak PSD level in 100 kHz.

3.2.2 Test Procedures

Reference level measurement

1. Set RBW=100kHz, VBW = 300kHz , Detector = Peak, Sweep time = Auto
2. Trace = max hold , Allow Trace to fully stabilize
3. Use the peak marker function to determine the maximum PSD level

Emission level measurement

1. Set RBW=100kHz, VBW = 300kHz , Detector = Peak, Sweep time = Auto
2. Trace = max hold , Allow Trace to fully stabilize
3. Scan Frequency range is up to 25GHz
4. Use the peak marker function to determine the maximum amplitude level

3.2.3 Test Setup

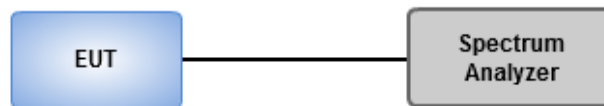

3.2.4 Unwanted Emissions into Non-Restricted Frequency Bands

Ambient Condition	21°C / 65%	Tested By	Alex Huang
-------------------	------------	-----------	------------

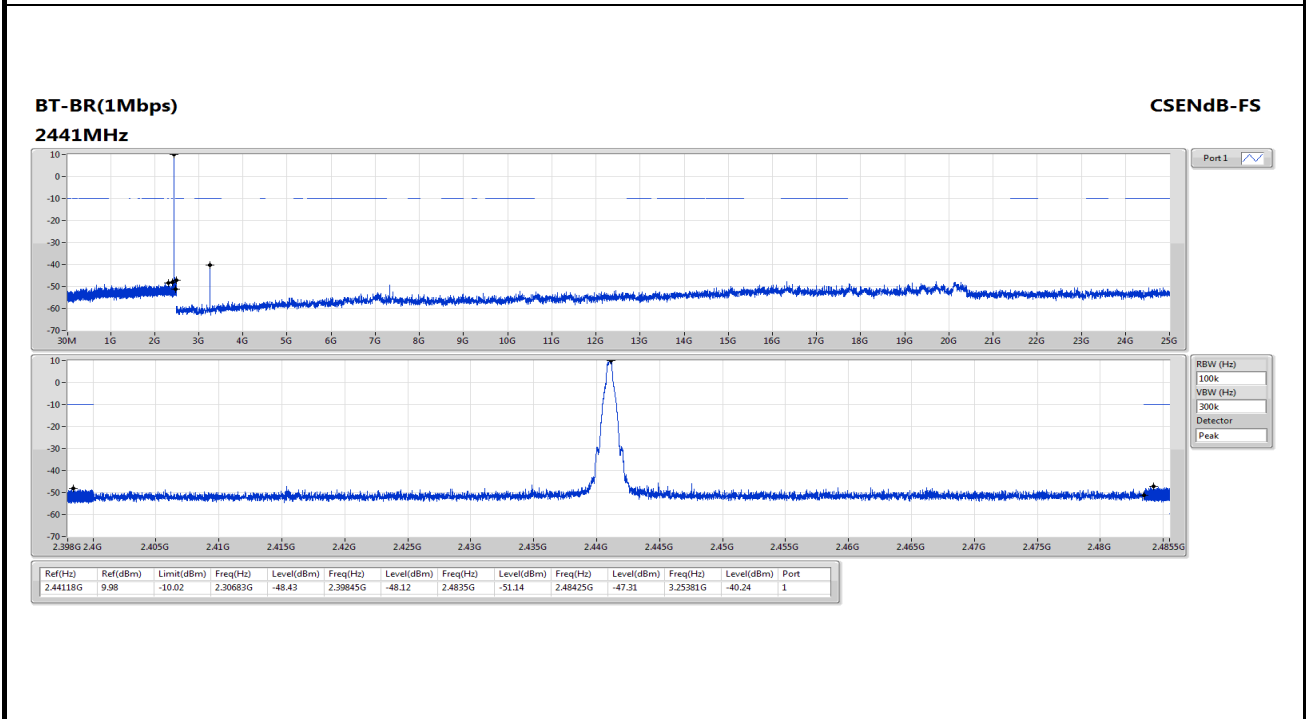
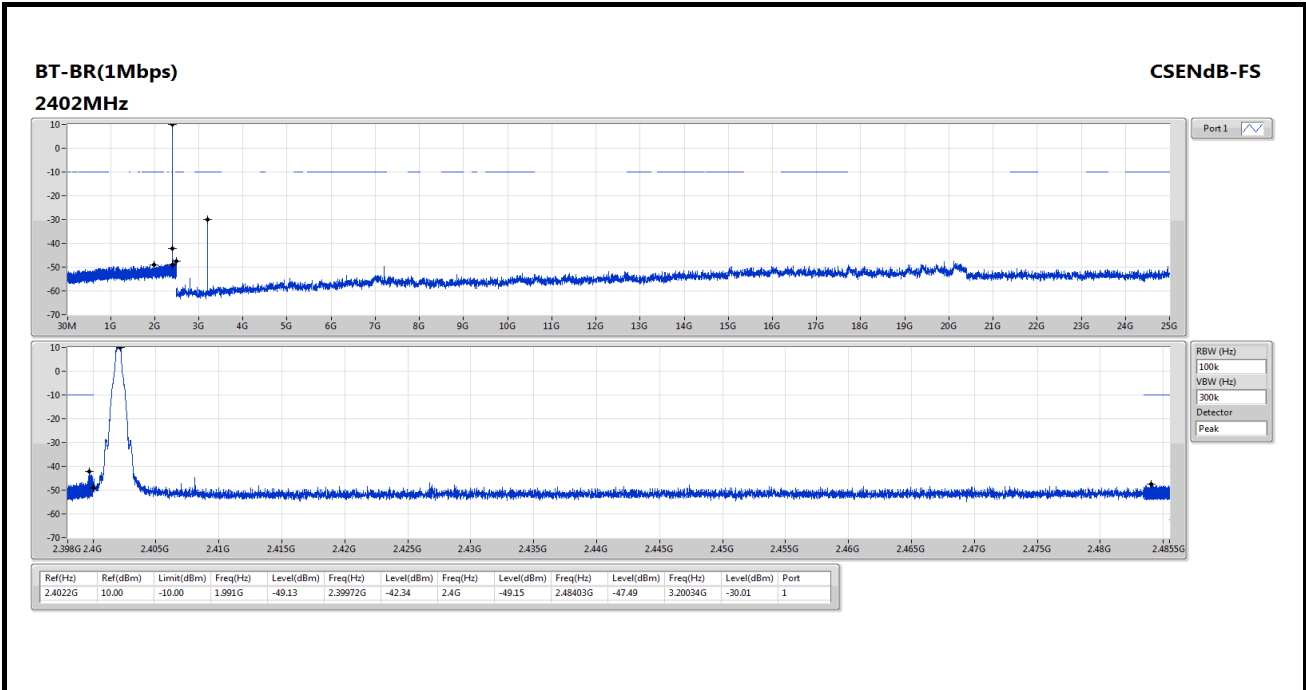

BT-BR(1Mbps)
2480MHz

CSENdB-FS

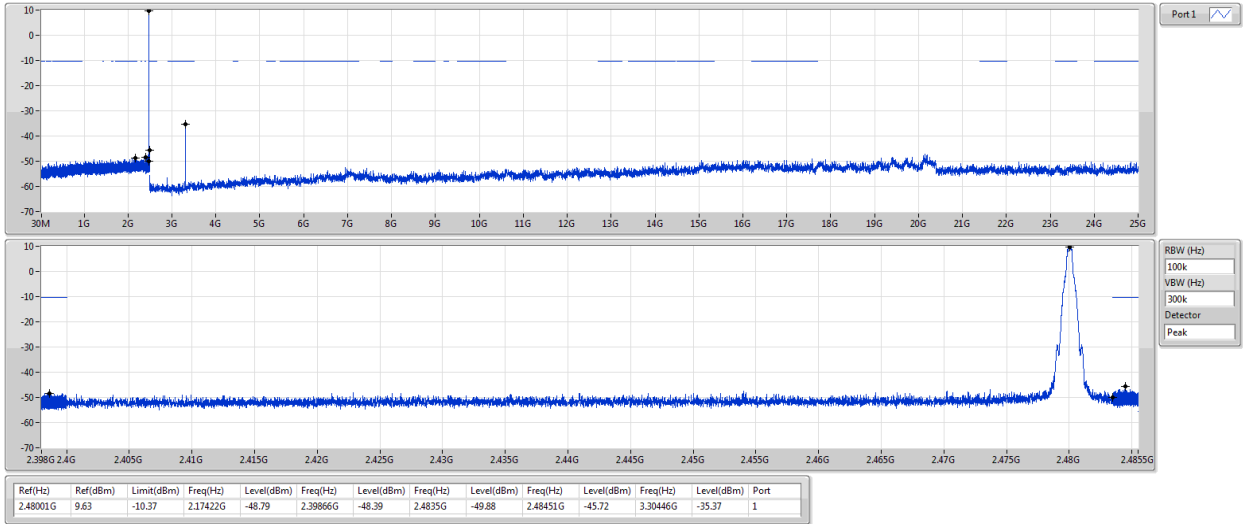

BT-EDR(2Mbps)
2402MHz

CSENdB-FS

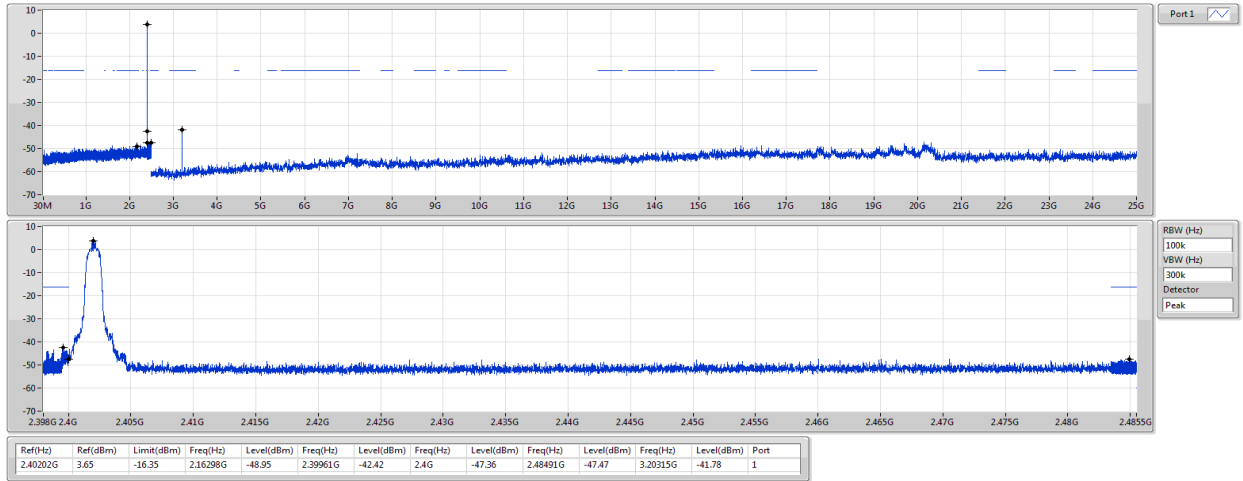

BT-EDR(2Mbps)

CSENdB-FS

2441MHz

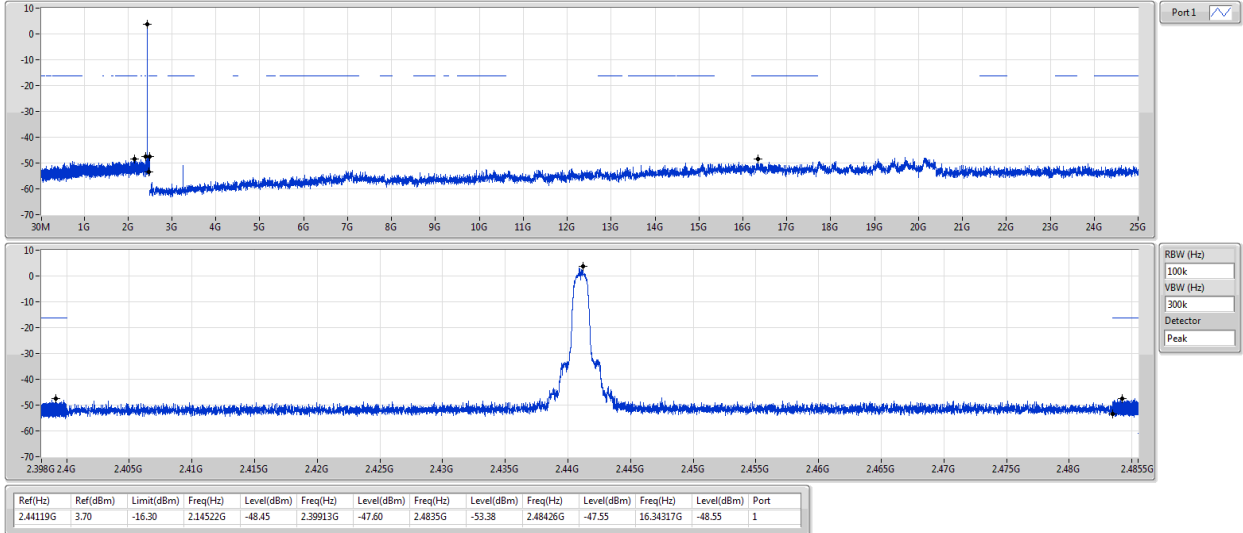

BT-EDR(2Mbps)

CSENdB-FS

2480MHz

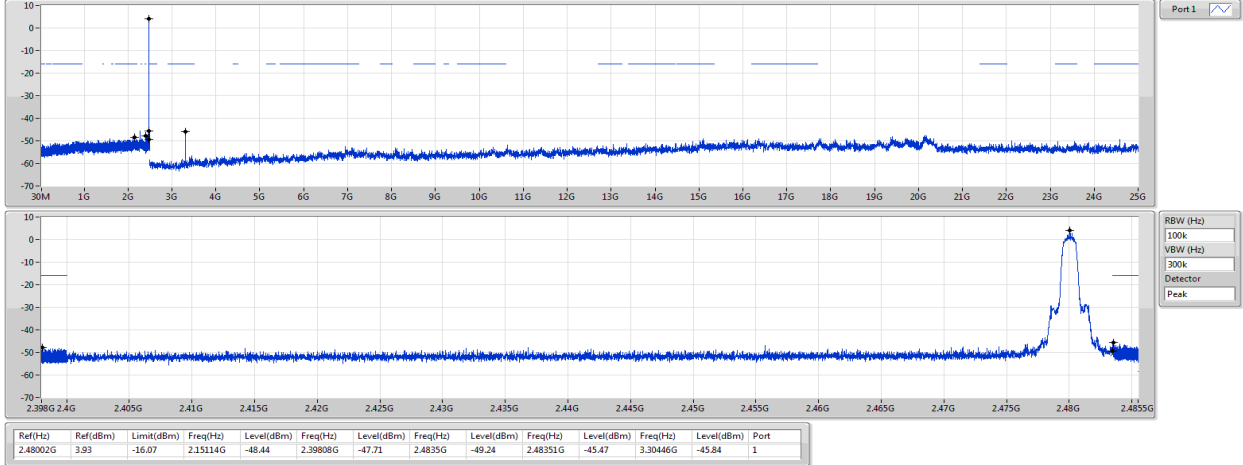

BT-EDR(3Mbps)

CSENdB-FS

2402MHz

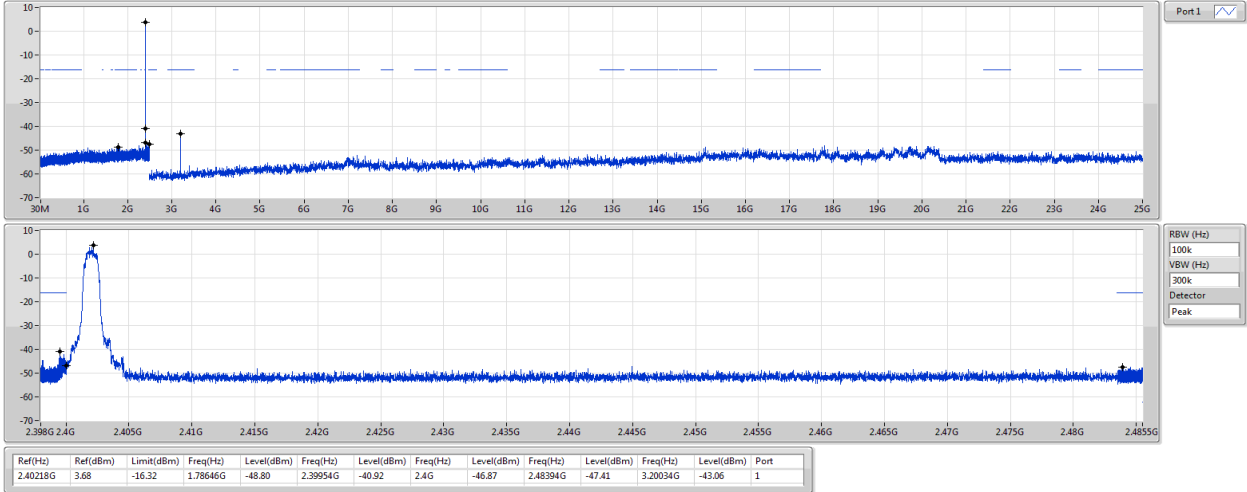

BT-EDR(3Mbps)

CSENdB-FS

2441MHz

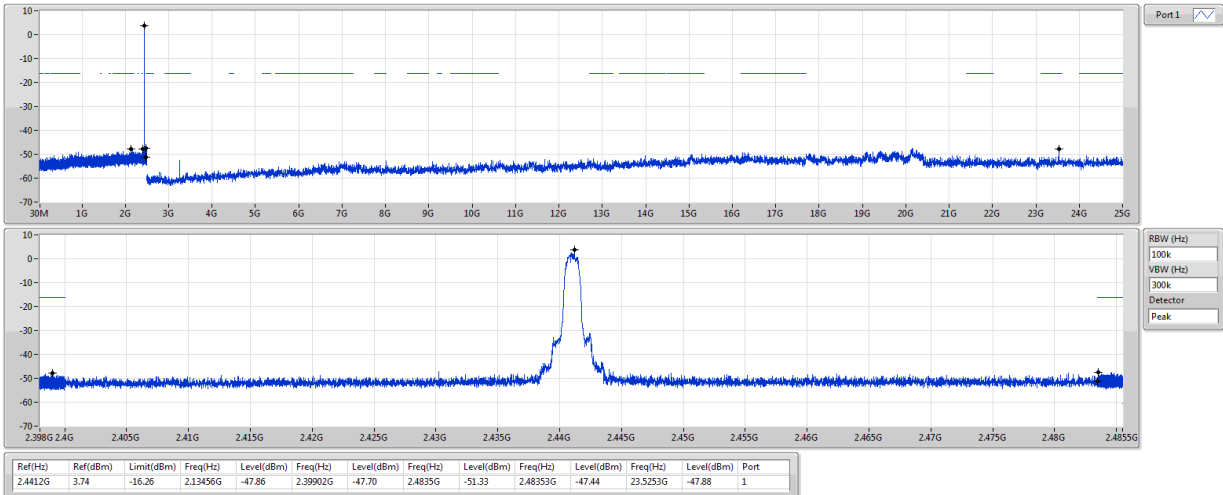

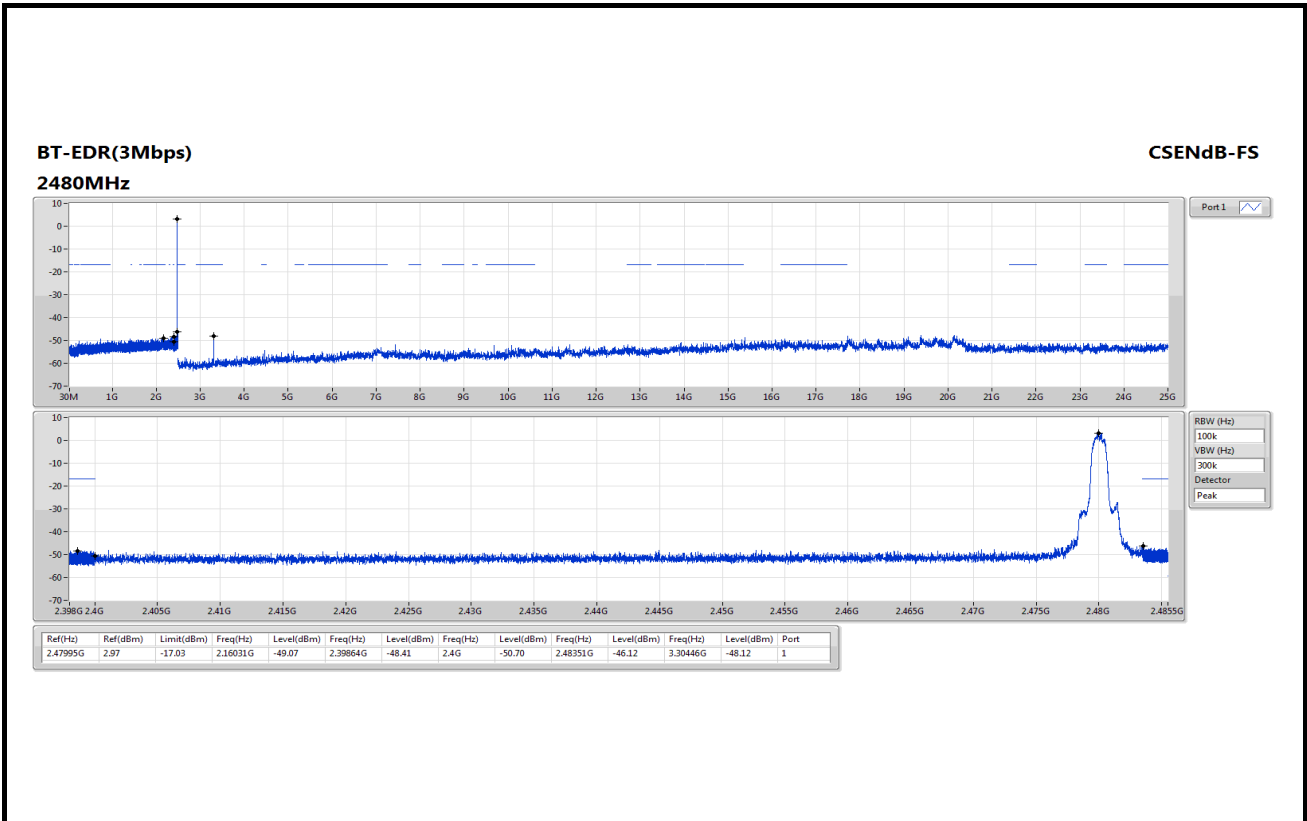

BT-BR(1Mbps)

2441MHz

Hopping Ch Bandedge (Non-restricted Band)

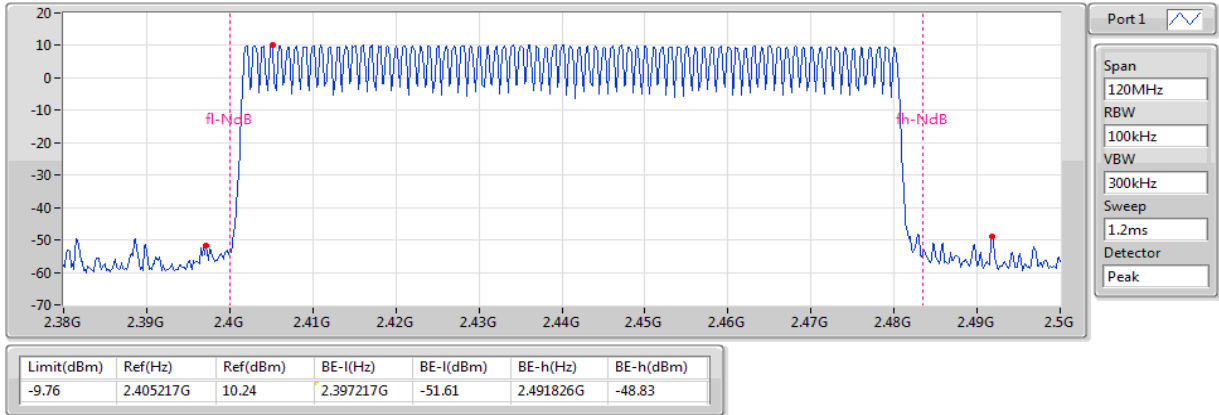

BT-EDR(2Mbps)

2441MHz

Hopping Ch Bandedge (Non-restricted Band)

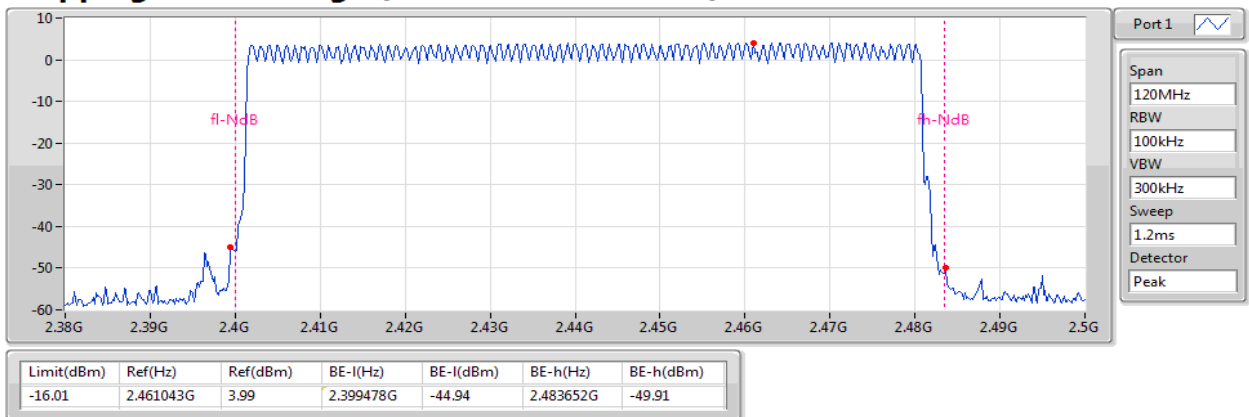

BT-EDR(3Mbps)

2441MHz

Hopping Ch Bandedge (Non-restricted Band)

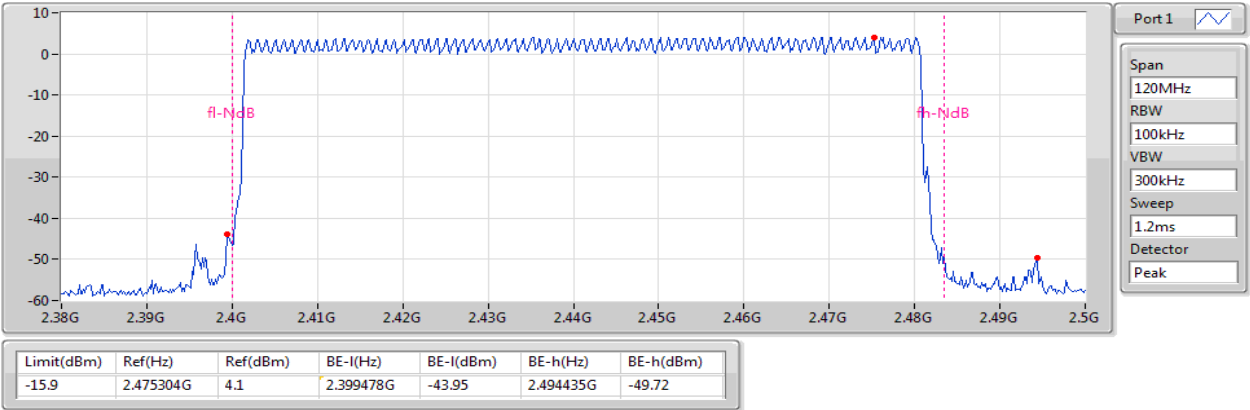

3.3 Conducted Output Power

3.3.1 Limit of Conducted Output Power

- 1 Watt
For frequency hopping systems operating in the 2400–2483.5 MHz band employing at least 75 non overlapping hopping channels, and all frequency hopping systems in the 5725–5850 MHz band.
- 0.125 Watt
For all other frequency hopping systems in the 2400–2483.5 MHz band.
- 0.125 Watt
For Frequency hopping systems operating in the 2400–2483.5 MHz band have hopping channel carrier frequencies that are separated by two-thirds of the 20 dB bandwidth of the hopping channel.

3.3.2 Test Procedures

1. A wideband power meter is used for power measurement. Bandwidth of power sensor and meter is 50MHz
2. If duty cycle of test signal is not 100 %, trigger and gating function of power meter will be enabled to capture transmission burst for measuring output power

3.3.3 Test Setup

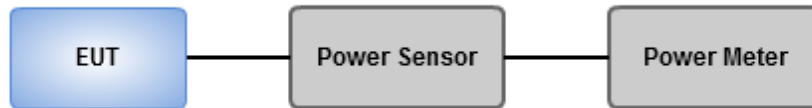

3.3.4 Test Result of Conducted Output Power

Ambient Condition	21°C / 65%	Tested By	Alex Huang
--------------------------	------------	------------------	------------

Summary of Peak Conducted Output Power

Mode	Power (dBm)	Power (W)
2.4-2.4835GHz	-	-
BT-BR(1Mbps)	10.87	0.01222
BT-EDR(2Mbps)	7.15	0.00519
BT-EDR(3Mbps)	7.56	0.00570

Result

Mode	Result	Gain (dBi)	Power (dBm)	Power Limit (dBm)
BT-BR(1Mbps)	-	-	-	-
2402MHz	Pass	1.72	10.87	21.00
2441MHz	Pass	1.72	10.68	21.00
2480MHz	Pass	1.72	10.50	21.00
BT-EDR(2Mbps)	-	-	-	-
2402MHz	Pass	1.72	7.06	21.00
2441MHz	Pass	1.72	7.15	21.00
2480MHz	Pass	1.72	7.12	21.00
BT-EDR(3Mbps)	-	-	-	-
2402MHz	Pass	1.72	7.52	21.00
2441MHz	Pass	1.72	7.56	21.00
2480MHz	Pass	1.72	7.51	21.00

Summary of Conducted (Average) Output Power

Mode	Power (dBm)	Power (W)
2.4-2.4835GHz	-	-
BT-BR(1Mbps)	10.82	0.01208
BT-EDR(2Mbps)	4.80	0.00302
BT-EDR(3Mbps)	4.81	0.00303

Result

Mode	Result	Gain (dBi)	Power (dBm)	Power Limit (dBm)
BT-BR(1Mbps)	-	-	-	-
2402MHz	Pass	1.72	10.82	-
2441MHz	Pass	1.72	10.63	-
2480MHz	Pass	1.72	10.46	-
BT-EDR(2Mbps)	-	-	-	-
2402MHz	Pass	1.72	4.49	-
2441MHz	Pass	1.72	4.71	-
2480MHz	Pass	1.72	4.80	-
BT-EDR(3Mbps)	-	-	-	-
2402MHz	Pass	1.72	4.49	-
2441MHz	Pass	1.72	4.72	-
2480MHz	Pass	1.72	4.81	-

Note: Average power is for reference only.

3.4 Number of Hopping Frequency

3.4.1 Limit of Number of Hopping Frequency

Frequency hopping systems in the 2400–2483.5 MHz band shall use at least 15 channels.

3.4.2 Test Procedures

1. Set RBW = 100kHz, VBW = 300kHz, Sweep time = Auto, Detector = Peak Trace max hold.
2. Allow trace to stabilize.

3.4.3 Test Setup

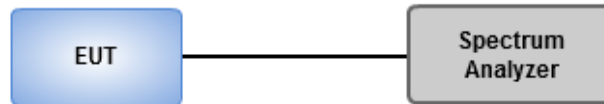

3.4.4 Test Result of Number of Hopping Frequency

Ambient Condition	21°C / 65%	Tested By	Alex Huang
--------------------------	------------	------------------	------------

Summary

Mode	Max-Hop No
2.4-2.4835GHz	-
BT-BR(1Mbps)	79
BT-EDR(2Mbps)	79
BT-EDR(3Mbps)	79

Result

Mode	Result	Hopping No	Limit
BT-BR(1Mbps)	-	-	-
2441MHz	Pass	79	15
BT-EDR(2Mbps)	-	-	-
2441MHz	Pass	79	15
BT-EDR(3Mbps)	-	-	-
2441MHz	Pass	79	15

BT-BR(1Mbps)
2441MHz

Hopping Ch

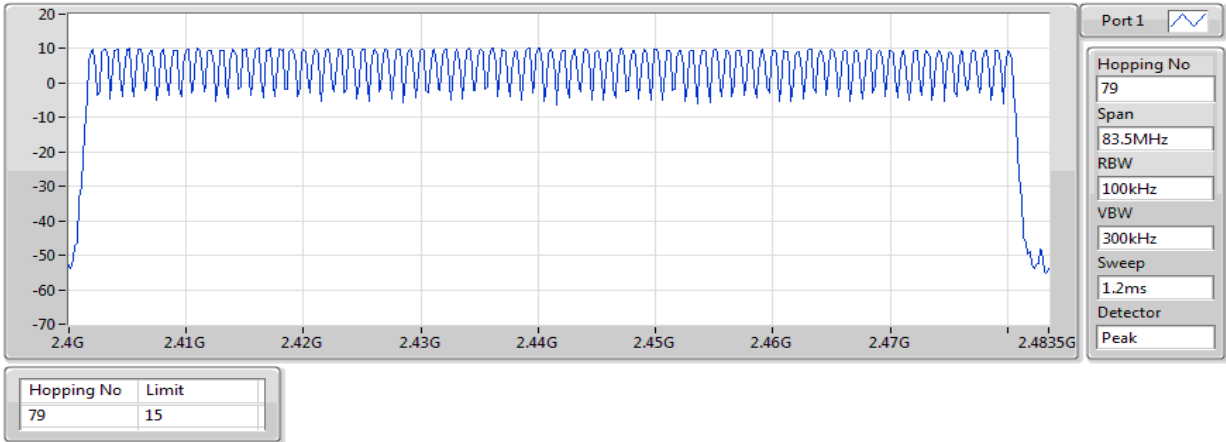

BT-EDR(2Mbps)
2441MHz

Hopping Ch

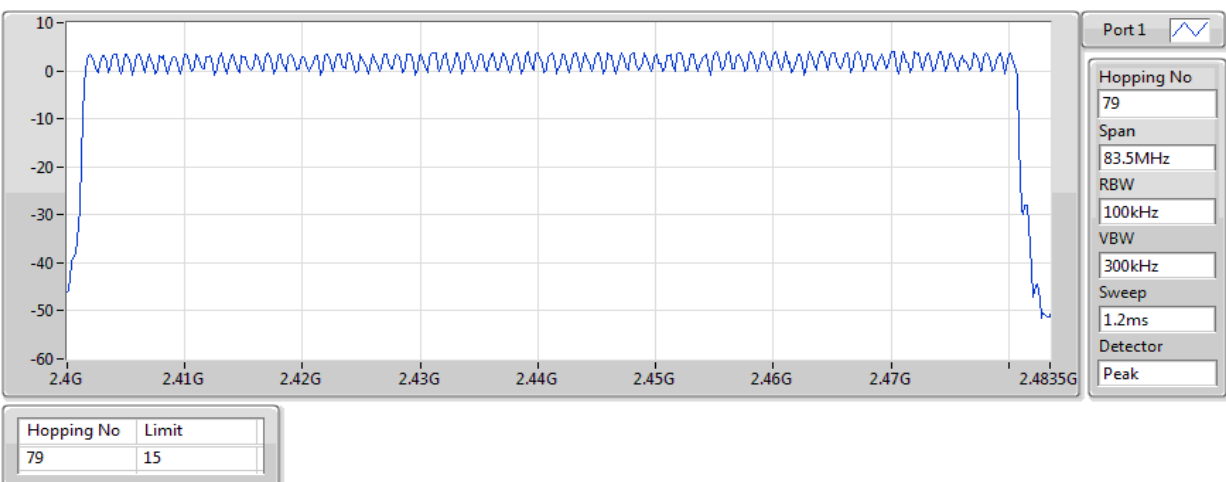

BT-EDR(3Mbps)
2441MHz

Hopping Ch

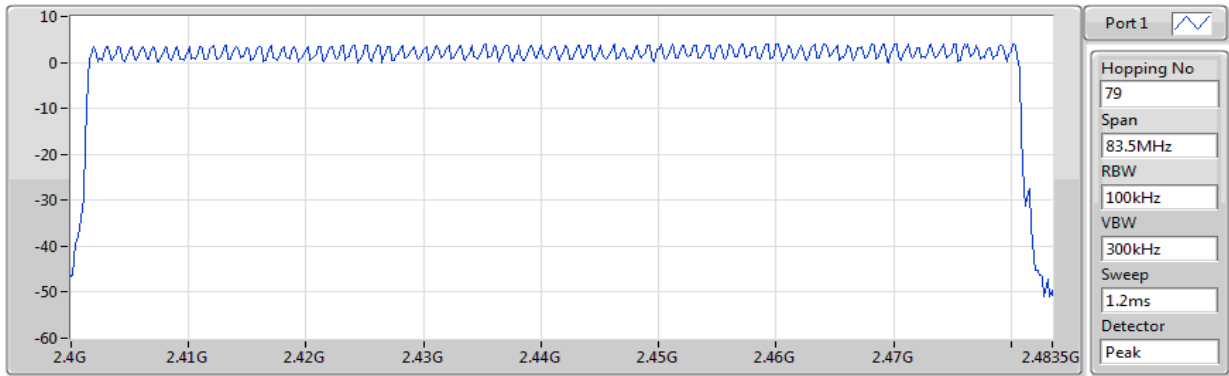

Hopping No	Limit
79	15

3.5 20dB and Occupied Bandwidth

3.5.1 Test Procedures

20dB Bandwidth

1. Set RBW=20kHz, VBW=100kHz, Sweep time = Auto, Detector=Peak , Trace max hold
2. Allow trace to stabilize
3. Measure the maximum width of the emission that is constrained by the frequencies associated with the two outermost amplitude points (upper and lower) that are attenuated by 20 dB relative to the maximum level measured in the fundamental emission.

Occupied Bandwidth

1. Set RBW=10kHz VBW= 30kHz for BT BR mode, RBW=20kHz, VBW=100kHz for other modes, Sweep time = Auto, Detector=Sample , Trace max hold
2. Allow trace to stabilize
3. Use Occupied bandwidth function of spectrum analyzer to measuring 99% occupied bandwidth

3.5.2 Test Setup

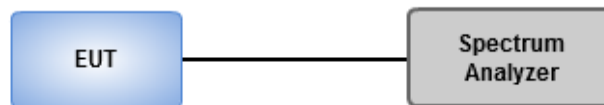

3.5.3 Test result of 20dB and Occupied Bandwidth

Ambient Condition	21°C / 65%	Tested By	Alex Huang
--------------------------	------------	------------------	------------

Summary

Mode	Max-N dB (Hz)	Max-OBW (Hz)	ITU-Code	Min-N dB (Hz)	Min-OBW (Hz)
2.4-2.4835GHz	-	-	-	-	-
BT-BR(1Mbps)	934.783k	853.835k	854KF1D	927.536k	848.046k
BT-EDR(2Mbps)	1.344M	1.201M	1M20G1D	1.33M	1.192M
BT-EDR(3Mbps)	1.337M	1.213M	1M21G1D	1.326M	1.207M

Max-N dB = Maximum 20dB down bandwidth; **Max-OBW** = Maximum 99% occupied bandwidth;
Min-N dB = Minimum 20dB down bandwidth; **Min-OBW** = Minimum 99% occupied bandwidth;

Result

Mode	Result	Limit (Hz)	Port 1-N dB (Hz)	Port 1-OBW (Hz)
BT-BR(1Mbps)	-	-	-	-
2402MHz	Pass	Inf	931.159k	848.046k
2441MHz	Pass	Inf	934.783k	848.046k
2480MHz	Pass	Inf	927.536k	853.835k
BT-EDR(2Mbps)	-	-	-	-
2402MHz	Pass	Inf	1.33M	1.192M
2441MHz	Pass	Inf	1.333M	1.195M
2480MHz	Pass	Inf	1.344M	1.201M
BT-EDR(3Mbps)	-	-	-	-
2402MHz	Pass	Inf	1.337M	1.21M
2441MHz	Pass	Inf	1.326M	1.207M
2480MHz	Pass	Inf	1.326M	1.213M

Port X-N dB = Port X 20dB down bandwidth; **Port X-OBW** = Port X 99% occupied bandwidth;

BT-BR(1Mbps)

EBW-FS

2402MHz

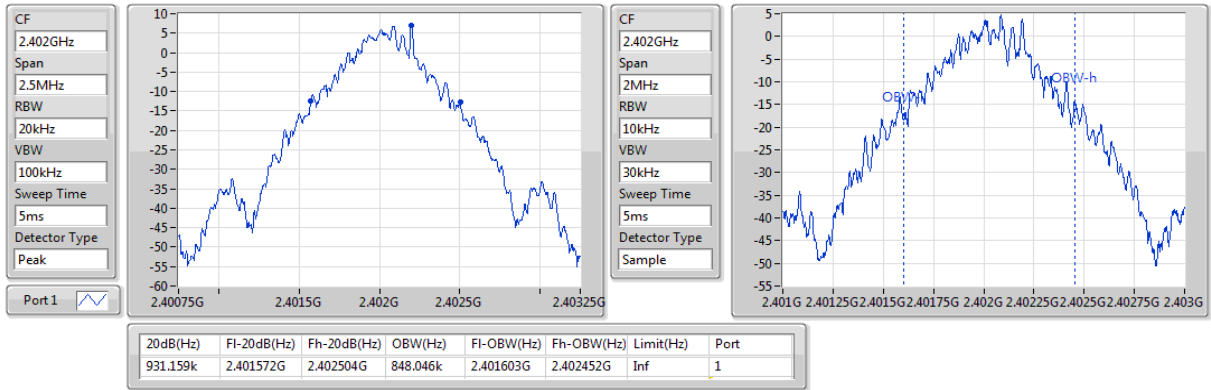

BT-BR(1Mbps)

EBW-FS

2441MHz

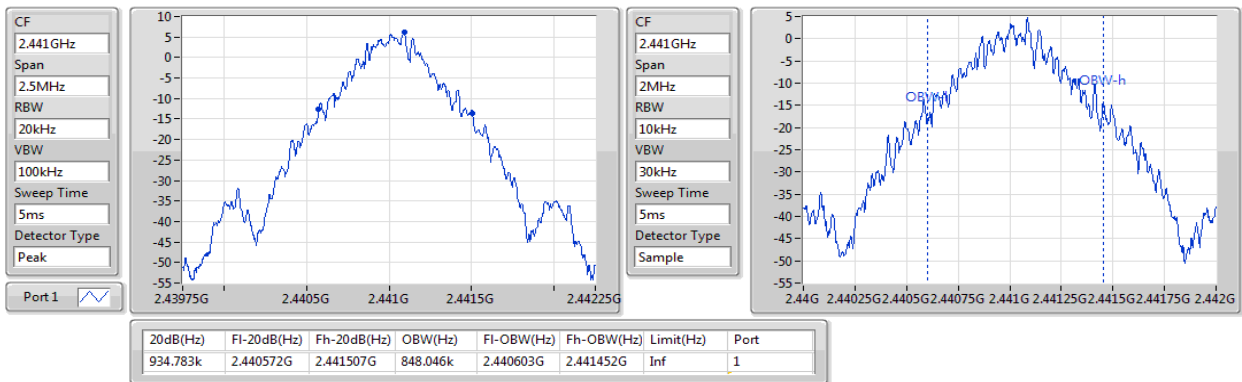

BT-BR(1Mbps)

EBW-FS

2480MHz

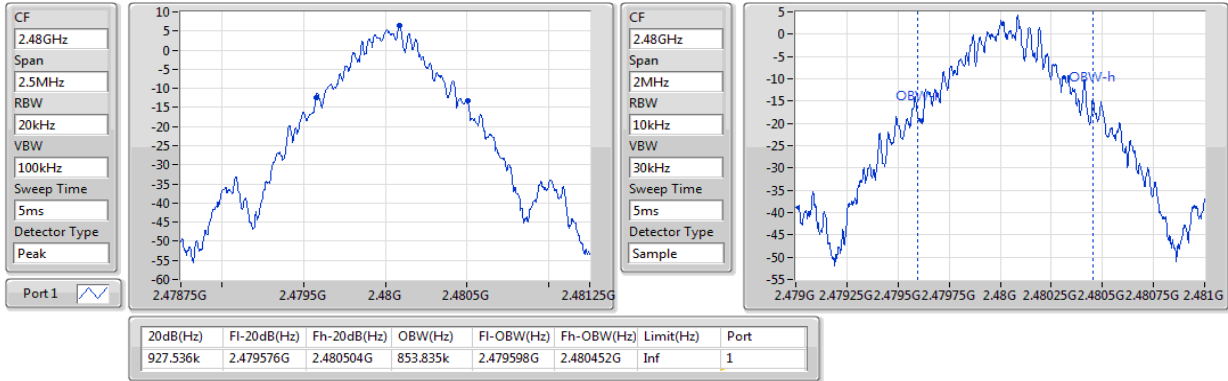

BT-EDR(2Mbps)

EBW-FS

2402MHz

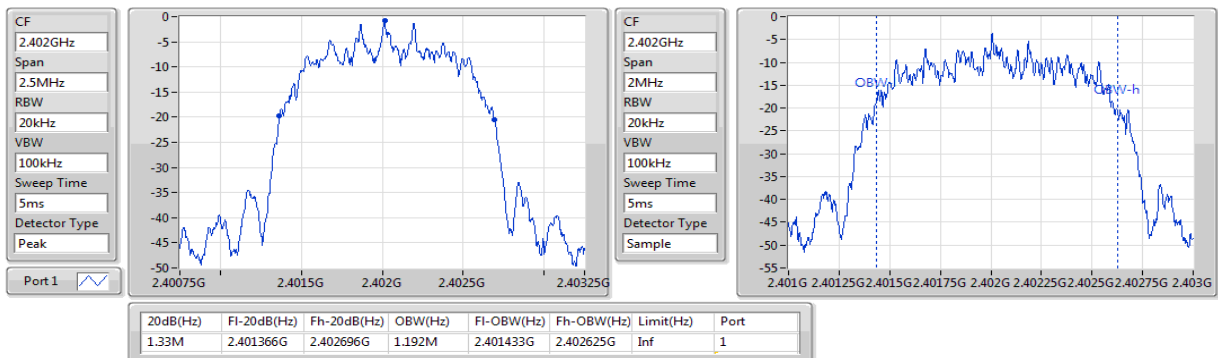

BT-EDR(2Mbps)

2441MHz

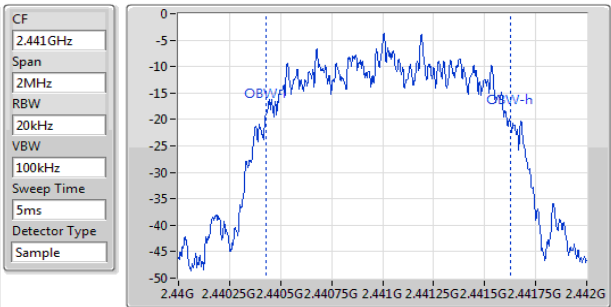
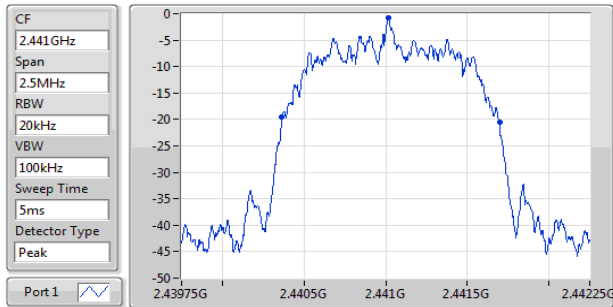

20dB(Hz)	Fl-20dB(Hz)	Fh-20dB(Hz)	OBW(Hz)	Fl-OBW(Hz)	Fh-OBW(Hz)	Limit(Hz)	Port
1.333M	2.440366G	2.441699G	1.195M	2.44043G	2.441625G	Inf	1

BT-EDR(2Mbps)

2480MHz

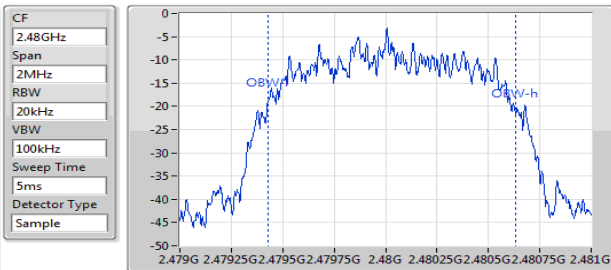
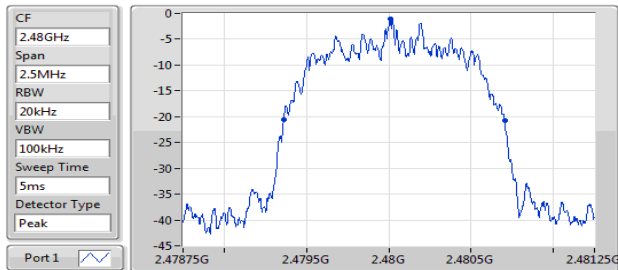

20dB(Hz)	Fl-20dB(Hz)	Fh-20dB(Hz)	OBW(Hz)	Fl-OBW(Hz)	Fh-OBW(Hz)	Limit(Hz)	Port
1.344M	2.479362G	2.480707G	1.201M	2.47943G	2.480631G	Inf	1

BT-EDR(3Mbps)

EBW-FS

2402MHz

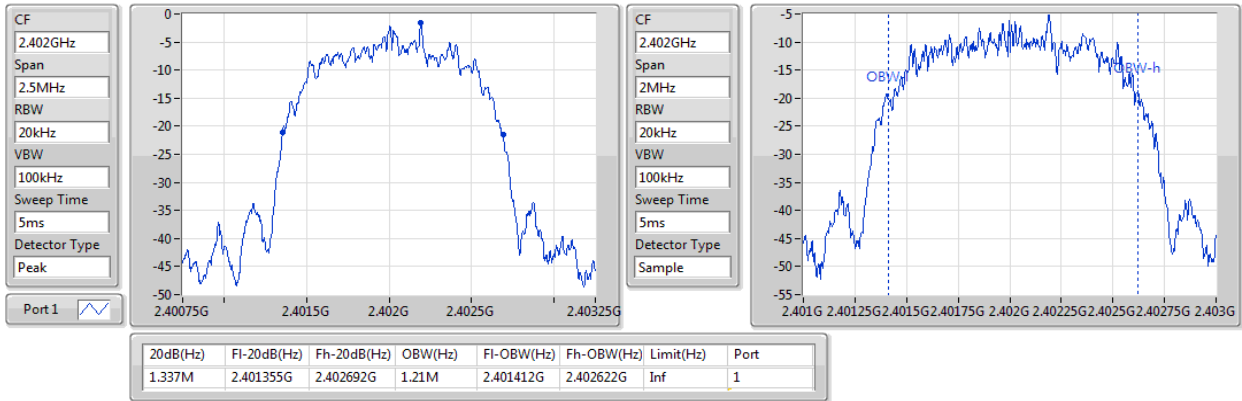

BT-EDR(3Mbps)

EBW-FS

2441MHz

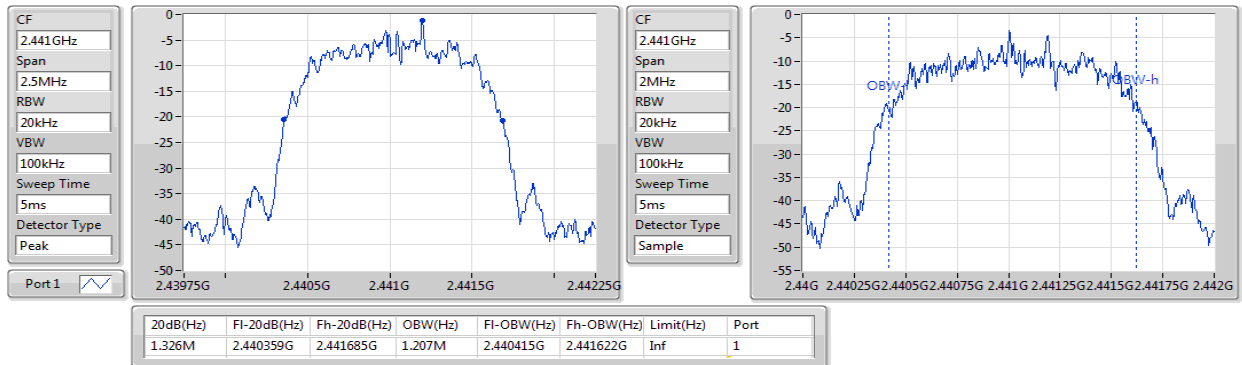

BT-EDR(3Mbps)

EBW-FS

2480MHz

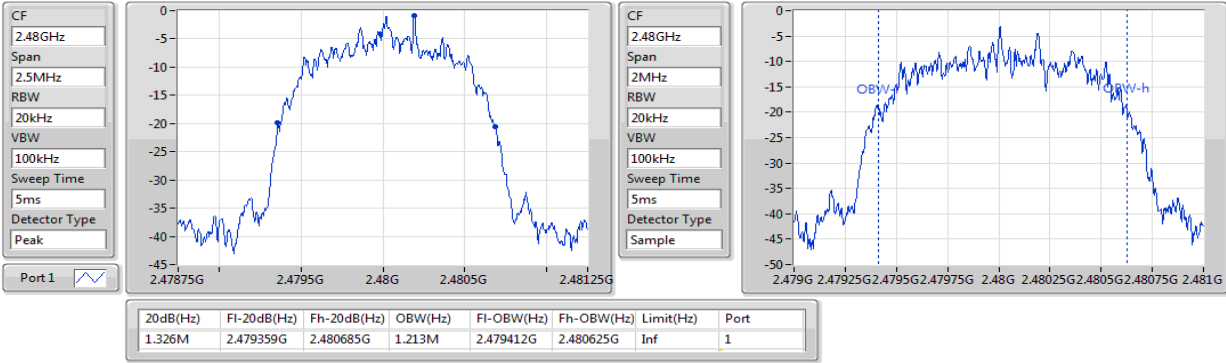

3.6 Channel Separation

3.6.1 Limit of Channel Separation

- Frequency hopping systems shall have hopping channel carrier frequencies separated by a minimum of 25 kHz or the 20 dB bandwidth of the hopping channel, whichever is greater.
- Frequency hopping systems operating in the 2400–2483.5 MHz band may have hopping channel carrier frequencies that are separated by 25 kHz or two-thirds of the 20 dB bandwidth of the hopping channel, whichever is greater.

3.6.2 Test Procedures

1. Set RBW=30kHz, VBW=100kHz, Sweep time = Auto, Detector=Peak Trace max hold
2. Allow trace to stabilize
3. Use the marker-delta function to determine the separation between the peaks of the adjacent channels. The EUT shall show compliance with the appropriate regulatory limit

3.6.3 Test Setup

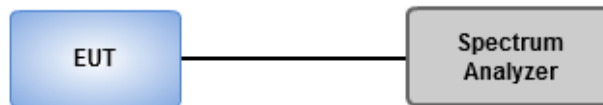

3.6.4 Test result of Channel Separation

Ambient Condition	21°C / 65%	Tested By	Alex Huang
--------------------------	------------	------------------	------------

Summary

Mode	Max-Space (Hz)	Min-Space (Hz)
2.4-2.4835GHz	-	-
BT-BR(1Mbps)	1M	1M
BT-EDR(2Mbps)	1.004348M	1M
BT-EDR(3Mbps)	1M	1M

Result

Mode	Result	Fl (Hz)	Fh (Hz)	Ch.Space (Hz)	Limit (Hz)
BT-BR(1Mbps)	-	-	-	-	-
2402MHz	Pass	2.402087G	2.403087G	1M	620.151894k
2441MHz	Pass	2.441087G	2.442087G	1M	622.565478k
2480MHz	Pass	2.479087G	2.480087G	1M	617.738976k
BT-EDR(2Mbps)	-	-	-	-	-
2402MHz	Pass	2.402017G	2.403017G	1M	885.78k
2441MHz	Pass	2.441017G	2.442017G	1M	887.778k
2480MHz	Pass	2.479017G	2.480022G	1.004348M	895.104k
BT-EDR(3Mbps)	-	-	-	-	-
2402MHz	Pass	2.402017G	2.403017G	1M	890.442k
2441MHz	Pass	2.441017G	2.442017G	1M	883.116k
2480MHz	Pass	2.479017G	2.480017G	1M	883.116k

BT-BR(1Mbps)

Channel Separation

2.402G/2.403GHz



BT-BR(1Mbps)

Channel Separation

2.441G/2.442GHz

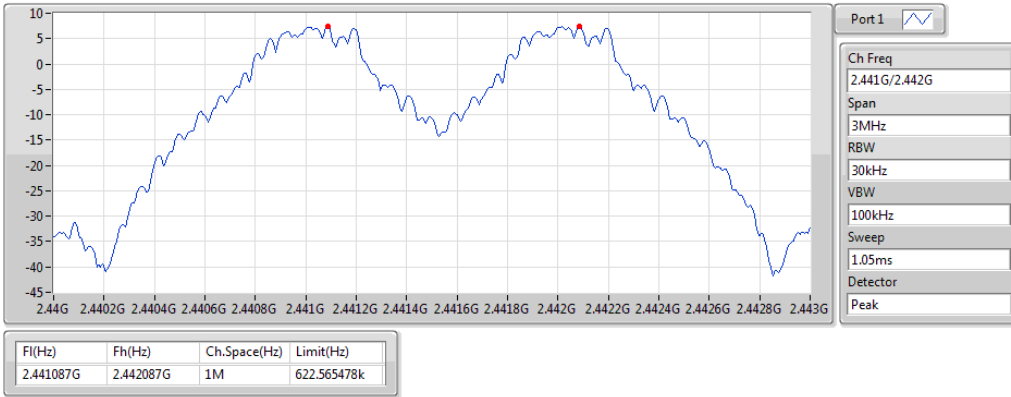

BT-BR(1Mbps)

Channel Separation

2.48G/2.479GHz



BT-EDR(2Mbps)

Channel Separation

2.402G/2.403GHz

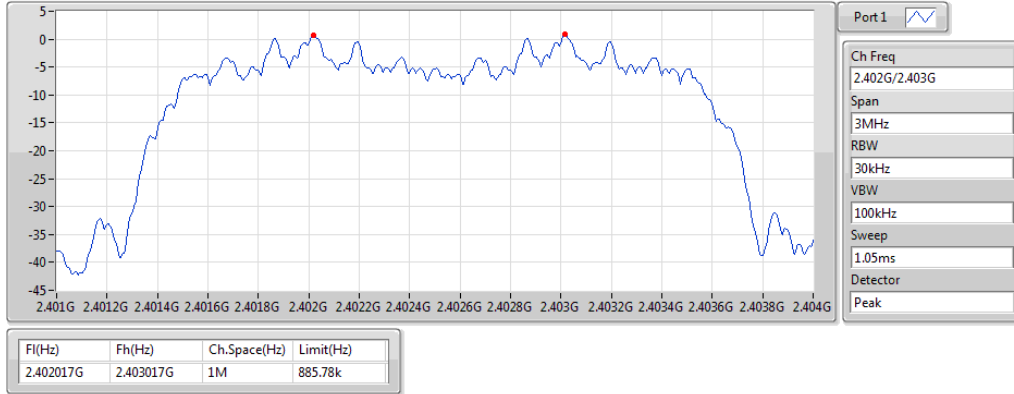

BT-EDR(2Mbps)

Channel Separation

2.441G/2.442GHz

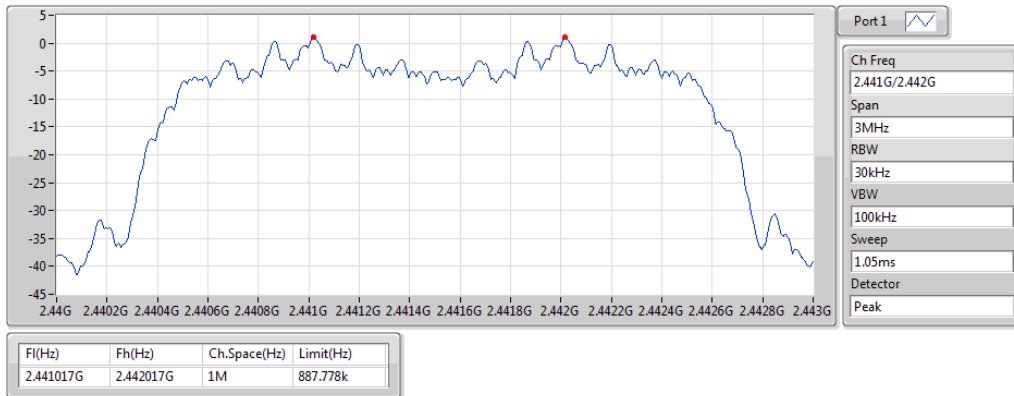

BT-EDR(2Mbps)

Channel Separation

2.48G/2.479GHz

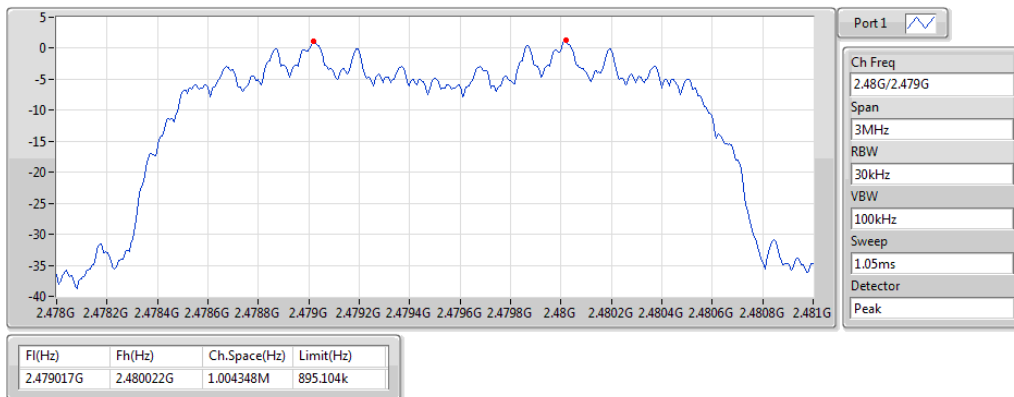

BT-EDR(3Mbps)

Channel Separation

2.402G/2.403GHz



Port 1

Ch Freq
2.402G/2.403G

Span
3MHz

RBW
30kHz

VBW
100kHz

Sweep
1.05ms

Detector
Peak

F1(Hz)	Fh(Hz)	Ch.Space(Hz)	Limit(Hz)
2.402017G	2.403017G	1M	890.442k

BT-EDR(3Mbps)

Channel Separation

2.441G/2.442GHz

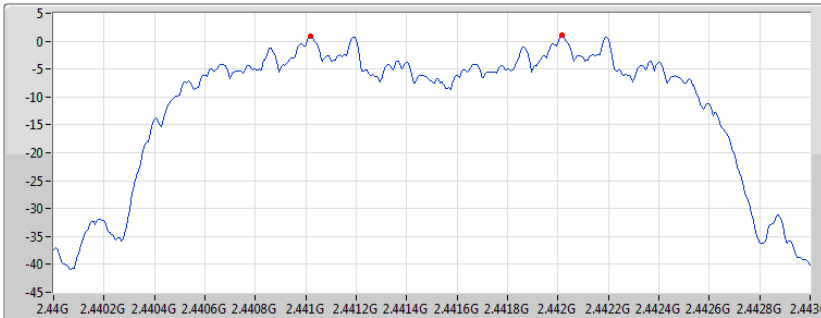

Port 1

Ch Freq
2.441G/2.442G

Span
3MHz

RBW
30kHz

VBW
100kHz

Sweep
1.05ms

Detector
Peak

F1(Hz)	Fh(Hz)	Ch.Space(Hz)	Limit(Hz)
2.441017G	2.442017G	1M	883.116k

BT-EDR(3Mbps)

Channel Separation

2.48G/2.479GHz

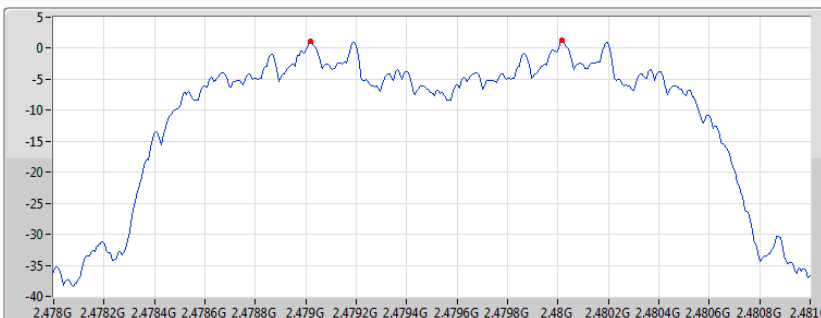

Port 1

Ch Freq
2.48G/2.479G

Span
3MHz

RBW
30kHz

VBW
100kHz

Sweep
1.05ms

Detector
Peak

F1(Hz)	Fh(Hz)	Ch.Space(Hz)	Limit(Hz)
2.479017G	2.480017G	1M	883.116k

3.7 Number of Dwell Time

3.7.1 Limit of Dwell time

The average time of occupancy on any channel shall not be greater than 0.4 seconds within a period of 0.4 seconds multiplied by the number of hopping channels employed.

3.7.2 Test Procedures

1. Set RBW=300 kHz, VBW=1 MHz, Sweep time=8 ms, Detector=Peak, Span=0 Hz, Trace max hold.
2. Enable gating and trigger function of spectrum analyzer to measure burst on time.
3. Set RBW=300 kHz, VBW=1 MHz, Sweep time=5 s / 2 s, Detector=Peak, Span=0 Hz, Trace max hold.
4. Enable gating and trigger function of spectrum analyzer to measure burst on number of transmission.
5. Set RBW=300 kHz, VBW=1 MHz, Sweep time=31.6 s / 8 s, Detector=Peak, Span=0 Hz, Trace max hold.
6. Enable gating and trigger function of spectrum analyzer to measure burst on number of transmission of entire time cycle.

3.7.3 Test Setup

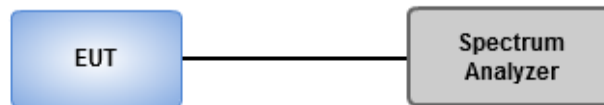

3.7.4 Test Result of Dwell Time

Ambient Condition	21°C / 65%	Tested By	Alex Huang
--------------------------	------------	------------------	------------

Summary

Mode	Max-Dwell (s)
2.4-2.4835GHz	-
BT-BR(1Mbps)	311.06566m_DH5
BT-EDR(2Mbps)	329.59116m_DH5
BT-EDR(3Mbps)	311.46856m_DH5
BT-BR-AFH(1Mbps)	312.687m_DH5-AFH
BT-EDR-AFH(2Mbps)	312.903m_DH5-AFH
BT-EDR-AFH(3Mbps)	313.092m_DH5-AFH

Result/ Non AFH mode

Mode	Result	Period (s)	Dwell (s)	Limit (s)	Tx On (ms)	Number of transmission in a 5 s
BT-BR(1Mbps)	-	-	-	-	-	-
2402MHz_DH5	PASS	31.6	0.31107	0.4	2.89525	17
BT-EDR(2Mbps)	-	-	-	-	-	-
2402MHz_DH5	PASS	31.6	0.32959	0.4	2.89725	18
BT-EDR(3Mbps)	-	-	-	-	-	-
2402MHz_DH5	PASS	31.6	0.31147	0.4	2.89900	17

Note 1: Dwell time =Number of transmission in a 5 second x Tx On Time x 6.32

Note 2: DH5 was the worst mode.

Result/ AFH mode

Mode	Result	Period (s)	Dwell (s)	Limit (s)	Tx On (ms)	Number of transmission in a 2 s
BT-BR-AFH(1Mbps)	-	-	-	-	-	-
2402MHz_DH5	PASS	8	0.31269	0.4	2.89525	27
BT-EDR-AFH(2Mbps)	-	-	-	-	-	-
2402MHz_DH5	PASS	8	0.31290	0.4	2.89725	27
BT-EDR-AFH(3Mbps)	-	-	-	-	-	-
2402MHz_DH5	PASS	8	0.31309	0.4	2.89900	27

Note 1: Dwell time =Number of transmission in a 2 second x Tx On Time x 4

Note 2: DH5 was the worst mode.

BT-BR(1Mbps)
2402MHz

Dwell

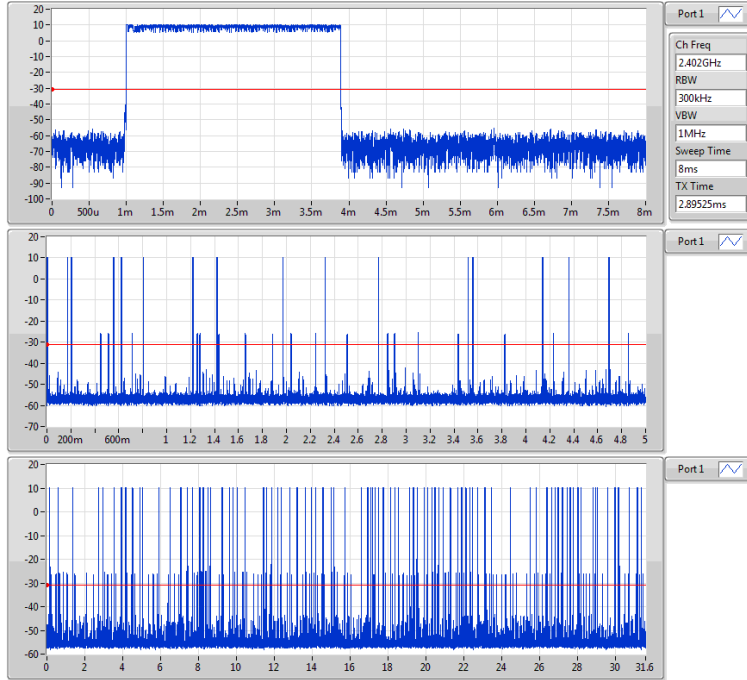

BT-EDR(2Mbps)
2402MHz

Dwell



BT-EDR(3Mbps)

Dwell

2402MHz

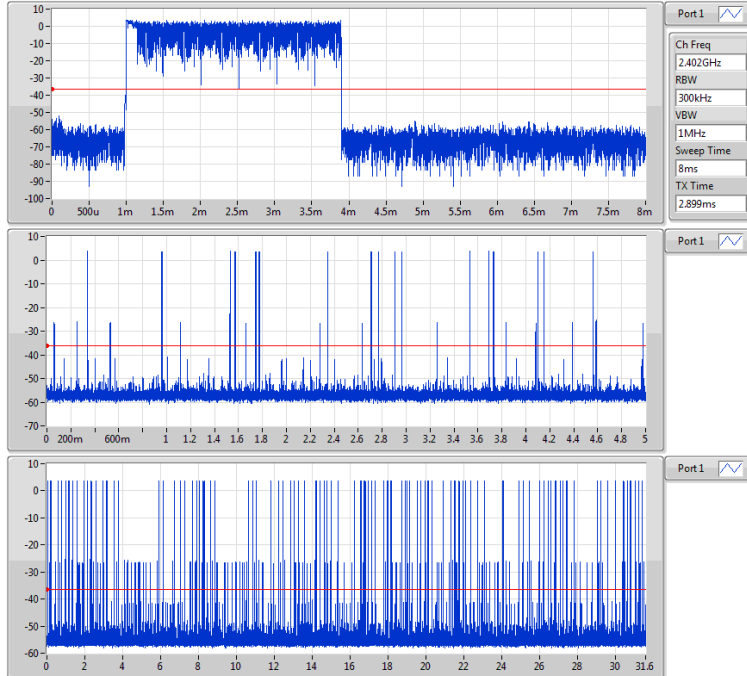

BT-BR-AFH(1Mbps)

Dwell

2402MHz



BT-EDR-AFH(2Mbps)

Dwell

2402MHz

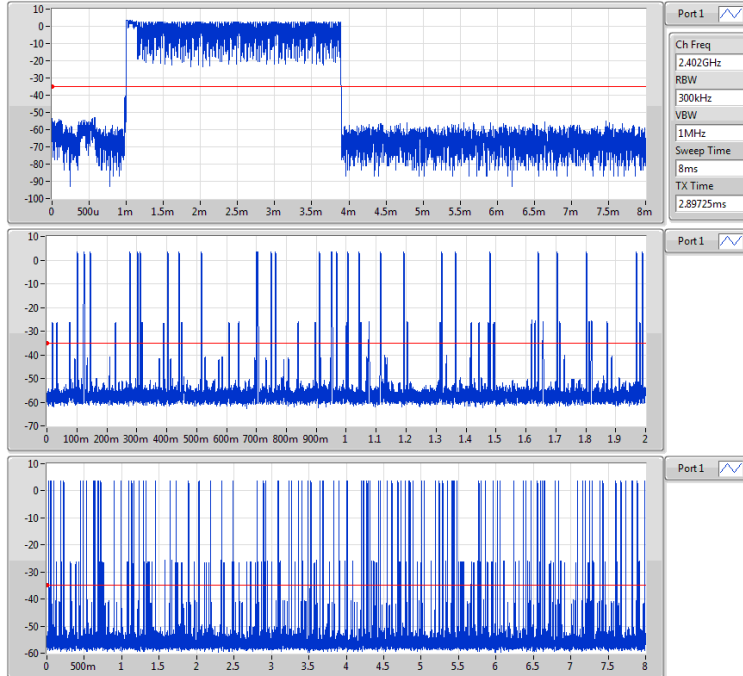

BT-EDR-AFH(3Mbps)

Dwell

2402MHz



4 Test laboratory information

Established in 2012, ICC provides foremost EMC & RF Testing and advisory consultation services by our skilled engineers and technicians. Our services employ a wide variety of advanced edge test equipment and one of the widest certification extents in the business.

International Certification Corporation (EMC and Wireless Communication Laboratory), it is our definitive objective is to institute long term, trust-based associations with our clients. The expectation we set up with our clients is based on outstanding service, practical expertise and devotion to a certified value structure. Our passion is to grant our clients with best EMC / RF services by oriented knowledgeable and accommodating staff.

Our Test sites are located at Linkou District and Kwei Shan District. Location map can be found on our website <http://www.icertifi.com.tw>.

Linkou

Tel: 886-2-2601-1640

No.30-2, Ding Fwu Tsuen, Lin Kou
District, New Taipei City, Taiwan
(R.O.C.)

Kwei Shan

Tel: 886-3-271-8666

No.3-1, Lane 6, Wen San 3rd
St., Kwei Shan Dist., Tao Yuan
City 33381, Taiwan (R.O.C.)

Kwei Shan Site II

Tel: 886-3-271-8640

No.14-1, Lane 19, Wen San 3rd
St., Kwei Shan Dist., Tao Yuan
City 333, Taiwan (R.O.C.)

If you have any suggestion, please feel free to contact us as below information.

Tel: 886-3-271-8666

Fax: 886-3-318-0155

Email: ICC_Service@icertifi.com.tw

==END==