

GARMIN®

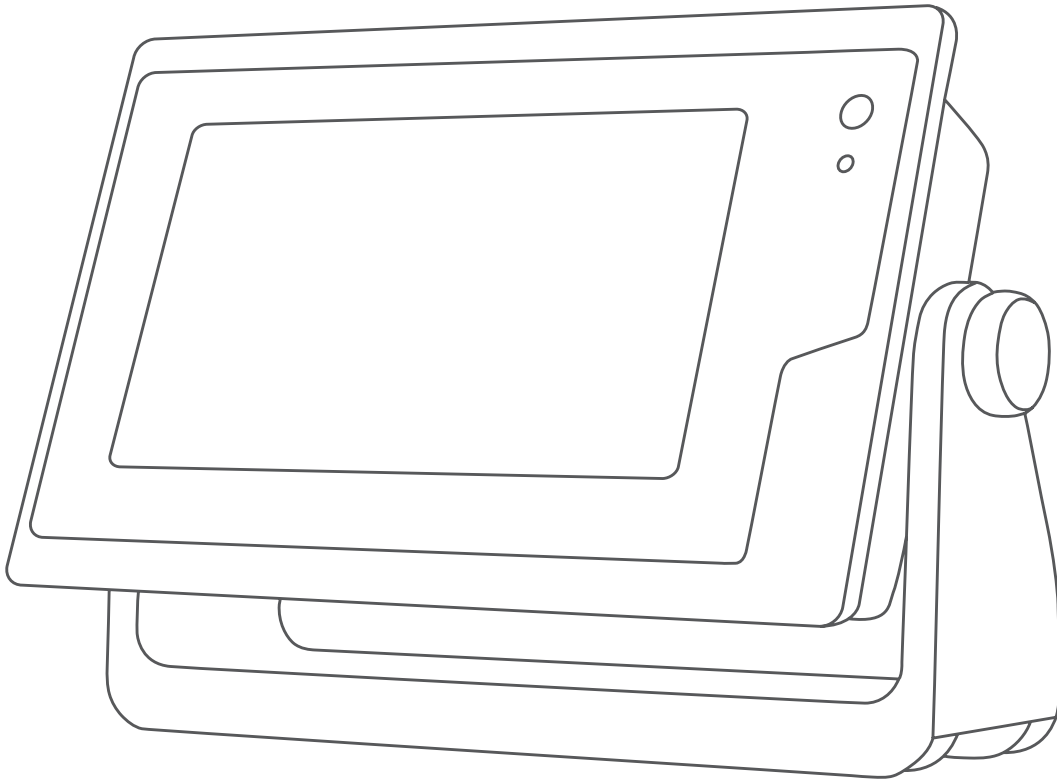

# GPSMAP® OWNER'S MANUAL

---

7x2, 9x2, 12x2 Touch, A12, 7x2 Plus, 9x2 Plus, 12x2 Plus,  
7x3, 9x3, 12x3

© 2019–2020 Garmin Ltd. or its subsidiaries

All rights reserved. Under the copyright laws, this manual may not be copied, in whole or in part, without the written consent of Garmin. Garmin reserves the right to change or improve its products and to make changes in the content of this manual without obligation to notify any person or organization of such changes or improvements. Go to [www.garmin.com](http://www.garmin.com) for current updates and supplemental information concerning the use of this product.

Garmin®, the Garmin logo, ActiveCaptain®, ANT®, BlueChart®, Fusion®, GPSMAP®, inReach®, Ultrascroll®, and VIRB® are trademarks of Garmin Ltd. or its subsidiaries, registered in the USA and other countries. ActiveCaptain®, Apollo™, Connect IQ™, ECHOMAP™, Fantom™, Fusion-Link™, Fusion PartyBus™, Garmin ClearVü™, Garmin Connect™, Garmin Express™, Garmin Nautix™, Garmin Quickdraw™, GC™, GCV™, GMM™, GMR™, GRID™, GXM™, LiveScope™, MotionScope™, OneChart™, OneHelm™, Panoptix™, Reactor™, Shadow Drive™, SmartMode™, and SteadyCast™ are trademarks of Garmin Ltd. or its subsidiaries. These trademarks may not be used without the express permission of Garmin.

Apple® and Mac® are trademarks of Apple Inc., registered in the U.S. and other countries. Android™ is a trademark of Google™ Inc. The BLUETOOTH® word mark and logos are owned by the Bluetooth SIG, Inc. and any use of such marks by Garmin is under license. CZone™ is a trademark of Power Products, LLC. Color Thermal Vision™ is a trademark of FLIR Systems, Inc. FLIR® and MSX® are registered trademarks of FLIR Systems, Inc. HDMI® is a registered trademark of HDMI Licensing, LLC. NMEA®, NMEA 2000®, and the NMEA 2000 logo are registered trademarks of the National Marine Electronics Association. microSD® and the microSD logo are trademarks of SD-3C, LLC. Optimus®, SeaWays®, and SeaStation® are registered trademarks of Dometic®. SD® and the SDHC logo are trademarks of SD-3C, LLC. SiriusXM® and all related marks and logos are trademarks of Sirius XM Radio Inc. All rights reserved. Wi-Fi® is a registered mark of Wi-Fi Alliance Corporation. Windows® is a registered trademark of Microsoft Corporation in the United States and other countries. Yamaha®, the Yamaha logo, Command Link Plus®, and Helm Master® are trademarks of the YAMAHA Motor Co., LTD. All other trademarks and copyrights are the property of their respective owners.

# Table of Contents

<b>Introduction</b> .....	<b>1</b>
Device Overview.....	1
GPSMAP 7x2/7x2 Plus and GPSMAP 9x2/9x2 Plus Connector View.....	1
GPSMAP 12x2 Touch/A12/12x2 Plus Connector View.....	1
GPSMAP 7x3 and GPSMAP 9x3 Connector View.....	1
GPSMAP 12x3 Connector View.....	1
Using the Touchscreen.....	2
On-Screen Buttons.....	2
Locking and Unlocking the Touchscreen.....	2
Tips and Shortcuts (MFD models).....	2
Accessing Owner's Manuals on the Chartplotter.....	2
Downloading the Manuals from the Web.....	2
Garmin Support Center.....	2
Memory Cards.....	2
Inserting Memory Cards (GPSMAP 7x2/9x2/12x2 Touch/A12/7x2 Plus/9x2 Plus/12x2 Plus).....	3
Inserting Memory Cards (GPSMAP 7x3/9x3/12x3).....	3
Acquiring GPS Satellite Signals.....	3
Selecting the GPS Source.....	3
<b>Customizing the Chartplotter</b> .....	<b>3</b>
Home Screen.....	3
Adding an Item to Favorites.....	4
Customizing the Home Screen.....	4
Customizing Pages.....	4
Customizing the Layout of a SmartMode or Combination Page.....	4
Changing the Background Image.....	4
Recommended Background Image Dimensions.....	4
Customizing the Startup Screen.....	4
Recommended Startup Image Dimensions.....	4
Adding a SmartMode Layout.....	4
Creating a New Combination Page.....	5
Deleting a Combination Page.....	5
Customizing the Data Overlays.....	5
Resetting the Station Layouts.....	5
Presets.....	5
Saving a New Preset.....	5
Managing Presets.....	5
Setting the Vessel Type.....	5
Adjusting the Backlight.....	5
Adjusting the Color Mode.....	5
Turning On the Chartplotter Automatically.....	5
Enabling Screen Lock.....	6
Automatically Turning Off the System.....	6
<b>ActiveCaptain App</b> .....	<b>6</b>
ActiveCaptain Roles.....	6
Getting Started with the ActiveCaptain App.....	6
Enabling Smart Notifications.....	6
Receiving Notifications.....	7
Managing Notifications.....	7
Making Notifications Private.....	7
Updating Software with the ActiveCaptain App.....	7
Updating Charts with ActiveCaptain.....	7
<b>Communication with Wireless Devices</b> .....	<b>7</b>
Wi-Fi Network.....	8
Setting Up the Wi-Fi Wireless Network.....	8
Connecting a Wireless Device to the Chartplotter.....	8
Changing the Wireless Channel.....	8
Changing the Wi-Fi Host.....	8
Wireless Remote Control.....	8
Pairing the Wireless Remote Control With the Chartplotter.....	8
Turning On and Off the Remote Backlight.....	8
Disconnecting the Remote from All Chartplotters.....	8
Wireless Wind Sensor.....	8
Connecting a Wireless Sensor to the Chartplotter.....	8
Adjusting the Wind Sensor Orientation.....	8
Viewing Boat Data on a Garmin Watch.....	8
Viewing Boat Data on a Garmin Nautix™ Device.....	9
<b>Charts and 3D Chart Views</b> .....	<b>9</b>
Navigation Chart and Fishing Chart.....	9
Zooming In and Out Using the Touchscreen.....	9
Chart Symbols.....	9
Measuring a Distance on the Chart.....	9
Creating a Waypoint on the Chart.....	9
Viewing Location and Object Information on a Chart.....	9
Viewing Details about Nav aids.....	10
Navigating to a Point on the Chart.....	10
Premium Charts.....	10
Fish Eye 3D Chart View.....	10
Viewing Tide Station Information.....	10
Animated Tide and Current Indicators.....	10
Showing Tides and Current Indicators.....	11
Showing Satellite Imagery on the Navigation Chart.....	11
Viewing Aerial Photos of Landmarks.....	11
Automatic Identification System.....	11
AIS Targeting Symbols.....	11
Heading and Projected Course of Activated AIS Targets.....	11
Activating a Target for an AIS Vessel.....	12
Viewing Information about a Targeted AIS Vessel.....	12
Deactivating a Target for an AIS Vessel.....	12
Viewing a List of AIS and MARPA Threats.....	12
Setting the Safe-Zone Collision Alarm.....	12
AIS Aids to Navigation.....	12
AIS Distress Signals.....	12
Navigating to a Distress Signal Transmission.....	12
AIS Distress Signal Device Targeting Symbols.....	12
Enabling AIS Transmission Test Alerts.....	12
Turning Off AIS Reception.....	13
Chart Menu.....	13
Chart Layers.....	13
Chart Layer Settings.....	13
Depth Layer Settings.....	13
My Vessel Layer Settings.....	13
Laylines Settings.....	13
User Data Layer Settings.....	14
Other Vessels Layer Settings.....	14
Water Layer Settings.....	14
Depth Range Shading.....	14
Weather Layer Settings.....	14
Radar Overlay Settings.....	15
Chart Settings.....	15
Fish Eye 3D Settings.....	15
Supported Maps.....	15
<b>Garmin Quickdraw Contours Mapping</b> .....	<b>15</b>
Mapping a Body of Water Using the Garmin Quickdraw Contours Feature.....	15
Adding a Label to a Garmin Quickdraw Contours Map.....	15
Garmin Quickdraw Community.....	15
Connecting to the Garmin Quickdraw Community with ActiveCaptain.....	16
Downloading Garmin Quickdraw Community Maps Using ActiveCaptain.....	16
Sharing Your Garmin Quickdraw Contours Maps with the Garmin Quickdraw Community Using ActiveCaptain.....	16
Connecting to the Garmin Quickdraw Community with Garmin Connect.....	16

Sharing Your Garmin Quickdraw Contours Maps with the Garmin Quickdraw Community Using Garmin Connect ..	16	Deleting All Saved Waypoints, Tracks, Routes, and Boundaries .....	23
Downloading Garmin Quickdraw Community Maps Using Garmin Connect .....	16	<b>Sailing Features .....</b>	<b>23</b>
Garmin Quickdraw Contours Settings .....	16	Setting the Vessel Type .....	23
<b>Navigation with a Chartplotter .....</b>	<b>17</b>	Sail Racing .....	23
Basic Navigation Questions .....	17	Starting Line Guidance .....	23
Destinations .....	17	Setting the Starting Line .....	23
Searching for a Destination by Name .....	17	Using the Starting Line Guidance .....	23
Selecting a Destination Using the Navigation Chart .....	17	Starting the Race Timer .....	23
Searching for a Marine Services Destination .....	17	Stopping the Race Timer .....	23
Setting and Following a Direct Course Using Go To .....	18	Setting the Distance between the Bow and the GPS Antenna .....	23
Stopping Navigation .....	18	Laylines Settings .....	23
Waypoints .....	18	Setting the Keel Offset .....	24
Marking Your Present Location as a Waypoint .....	18	Sailboat Autopilot Operation .....	24
Creating a Waypoint at a Different Location .....	18	Wind Hold .....	24
Marking an SOS Location .....	18	Setting the Wind Hold Type .....	24
Projecting a Waypoint .....	18	Engaging Wind Hold .....	24
Viewing a List of all Waypoints .....	18	Engaging Wind Hold from Heading Hold .....	24
Editing a Saved Waypoint .....	18	Adjusting the Wind Hold Angle with the Autopilot .....	24
Moving a Saved Waypoint .....	18	Tack and Gybe .....	24
Browsing for and Navigating to a Saved Waypoint .....	18	Tacking and Gybing from Heading Hold .....	24
Deleting a Waypoint or an MOB .....	19	Tacking and Gybing from Wind Hold .....	24
Deleting All Waypoints .....	19	Setting a Tack and Gybe Delay .....	24
Routes .....	19	Enabling the Gybe Inhibitor .....	25
Creating and Navigating a Route From Your Present Location .....	19	Heading Line and Angle Markers .....	25
Creating and Saving a Route .....	19	Setting the Heading Line and Angle Markers .....	25
Viewing a List of Routes and Auto Guidance Paths .....	19	<b>Sonar Fishfinder .....</b>	<b>25</b>
Editing a Saved Route .....	19	Stopping the Transmission of Sonar Signals .....	25
Browsing for and Navigating a Saved Route .....	19	Changing the Sonar View .....	25
Browsing for and Navigating Parallel to a Saved Route .....	19	Traditional Sonar View .....	25
Initiating a Search Pattern .....	20	Split-Frequency Sonar View .....	25
Deleting a Saved Route .....	20	Split-Zoom Sonar View .....	25
Deleting All Saved Routes .....	20	Garmin ClearVü Sonar View .....	25
Auto Guidance .....	20	SideVü Sonar View .....	26
Setting and Following an Auto Guidance Path .....	20	SideVü Scanning Technology .....	26
Creating and Saving an Auto Guidance Path .....	20	Measuring Distance on the Sonar Screen .....	26
Adjusting a Saved Auto Guidance Path .....	20	Panoptix Sonar Views .....	26
Canceling an Auto Guidance Calculation in Progress .....	20	LiveVü Down Sonar View .....	26
Setting a Timed Arrival .....	20	LiveVü Forward Sonar View .....	27
Auto Guidance Path Configurations .....	20	RealVü 3D Forward Sonar View .....	27
Adjusting the Distance from Shore .....	21	RealVü 3D Down Sonar View .....	27
Tracks .....	21	RealVü 3D Historical Sonar View .....	27
Showing Tracks .....	21	FrontVü Sonar View .....	27
Setting the Color of the Active Track .....	21	Panoptix LiveScope™ Sonar View .....	27
Saving the Active Track .....	21	Perspective View .....	28
Viewing a List of Saved Tracks .....	21	Selecting the Transducer Type .....	28
Editing a Saved Track .....	21	Selecting a Sonar Source .....	28
Saving a Track as a Route .....	21	Renaming a Sonar Source .....	28
Browsing for and Navigating a Recorded Track .....	21	Creating a Waypoint on the Sonar Screen .....	28
Deleting a Saved Track .....	22	Pausing the Sonar Display .....	28
Deleting All Saved Tracks .....	22	Viewing Sonar History .....	28
Retracing the Active Track .....	22	Sonar Sharing .....	28
Clearing the Active Track .....	22	Adjusting the Level of Detail .....	28
Managing the Track Log Memory During Recording .....	22	Adjusting the Color Intensity .....	28
Configuring the Recording Interval of the Track Log .....	22	Sonar Recordings .....	29
Boundaries .....	22	Recording the Sonar Display .....	29
Creating a Boundary .....	22	Stopping the Sonar Recording .....	29
Converting a Route to a Boundary .....	22	Deleting a Sonar Recording .....	29
Converting a Track to a Boundary .....	22	Playing Sonar Recordings .....	29
Editing a Boundary .....	22	Traditional, Garmin ClearVü, and SideVü Sonar Setup .....	29
Linking a Boundary to a SmartMode Layout .....	22	Setting the Zoom Level on the Sonar Screen .....	29
Setting a Boundary Alarm .....	22	Setting the Scroll Speed .....	29
Disabling all Boundary Alarms .....	23	Adjusting the Range of the Depth or Width Scale .....	30
Deleting a Boundary .....	23	Sonar Noise Rejection Settings .....	30
		Sonar Appearance Settings .....	30

Sonar Alarms.....	30	Reducing Cross Talk Clutter on the Radar Screen.....	39
Advanced Sonar Settings.....	31	Radar Appearance Settings.....	39
Traditional, Garmin ClearVü, and SideVü Transducer Installation Settings.....	31	Radar Installation Settings.....	39
Sonar Frequencies.....	31	Front-of-Boat Offset.....	39
Selecting the Transducer Frequency.....	31	Setting a Custom Park Position.....	39
Creating a Frequency Preset.....	31	Radar My Vessel Layer Settings.....	39
Turning On the A-Scope.....	31	Selecting a Different Radar Source.....	39
Panoptix Sonar Setup.....	32	Changing the Radar Mode.....	39
Zooming in a Panoptix LiveVü or LiveScope Sonar View.....	32	<b>Autopilot.....</b>	<b>39</b>
Adjusting the RealVü Viewing Angle and Zoom Level.....	32	Opening the Autopilot Screen.....	40
Adjusting the RealVü Sweep Speed.....	32	Autopilot Screen.....	40
LiveVü Forward and FrontVü Sonar Menu.....	32	Adjusting the Step Steering Increment.....	40
Setting the LiveVü and FrontVü Transducer Transmit Angle.....	32	Setting the Power Saver.....	40
Setting the FrontVü Depth Alarm.....	33	Enabling Shadow Drive™.....	40
LiveVü and FrontVü Appearance Settings.....	33	Selecting the Preferred Heading Source.....	40
RealVü Appearance Settings.....	33	Autopilot Overlay Bar.....	40
LiveScope and Perspective Sonar Menu.....	33	Engaging the Autopilot.....	40
LiveScope and Perspective Sonar Setup.....	33	Adjusting the Heading with the Helm.....	40
LiveScope and Perspective Appearance Settings.....	34	Adjusting the Heading with the Chartplotter in Step Steering Mode.....	40
Panoptix Transducer Installation Settings.....	34	Steering Patterns.....	41
Setting the Bow Offset.....	34	Following the U-Turn Pattern.....	41
Calibrating the Compass.....	34	Setting Up and Following the Circles Pattern.....	41
<b>Radar.....</b>	<b>35</b>	Setting Up and Following the Zigzag Pattern.....	41
Radar Interpretation.....	35	Following the Williamson Turn Pattern.....	41
Radar Overlay.....	35	Following an Orbit Pattern.....	41
Radar Overlay and Chart Data Alignment.....	35	Setting Up and Following the Cloverleaf Pattern.....	41
Transmitting Radar Signals.....	35	Setting Up and Following a Search Pattern.....	41
Stopping the Transmission of Radar Signals.....	35	Cancelling a Steering Pattern.....	41
Setting Up the Timed Transmit Mode.....	35	Adjusting the Autopilot Response.....	41
Enabling and Adjusting a Radar No Transmit Zone.....	35	Enabling the Autopilot Controls on a Garmin Watch.....	41
Adjusting the Radar Range.....	35	Customizing the Autopilot Button Actions.....	41
Tips for Selecting a Radar Range.....	36	Controlling the Autopilot with a GRID 20 Remote Control.....	41
MotionScope™ Doppler Radar Technology.....	36	Reactor™ Autopilot Remote Control.....	42
Enabling a Guard Zone.....	36	Pairing a Reactor Autopilot Remote Control With a Chartplotter.....	42
Defining a Circular Guard Zone.....	36	Changing the Functions of the Reactor Autopilot Remote Control Action Keys.....	42
Defining a Partial Guard Zone.....	36	Updating the Reactor Autopilot Remote Control Software.....	42
MARPA.....	36	Yamaha Autopilot.....	42
MARPA Targeting Symbols.....	36	Yamaha Autopilot Screen.....	42
Acquiring MARPA Targets Automatically.....	36	Yamaha Autopilot Settings.....	42
Assigning a MARPA Tag to an Object.....	37	Yamaha Autopilot Overlay Bar.....	42
Removing a MARPA Tag from a Targeted Object.....	37	<b>Force® Trolling Motor Control.....</b>	<b>43</b>
Viewing Information about a MARPA-tagged Object.....	37	Connecting to a Trolling Motor.....	43
Viewing a List of AIS and MARPA Threats.....	37	Adding the Trolling Motor Controls to Screens.....	43
Showing AIS Vessels on the Radar Screen.....	37	Trolling Motor Control Bar.....	43
VRM and EBL.....	37	Trolling Motor Settings.....	43
Showing and Adjusting the VRM and the EBL.....	37	Assigning a Shortcut to the Trolling Motor Remote Control Shortcut Keys.....	44
Measuring the Range and Bearing to a Target Object.....	37	Calibrating the Trolling Motor Compass.....	44
Echo Trails.....	37	Setting the Bow Offset.....	44
Turning on Echo Trails.....	37	<b>Digital Selective Calling.....</b>	<b>44</b>
Adjusting the Length of the Echo Trails.....	37	Networked Chartplotter and VHF Radio Functionality.....	44
Clearing the Echo Trails.....	37	Turning On DSC.....	44
Radar Settings.....	37	DSC List.....	44
Radar Gain.....	37	Viewing the DSC List.....	44
Adjusting Gain on the Radar Screen Automatically.....	37	Adding a DSC Contact.....	44
Adjusting Gain on the Radar Screen Manually.....	38	Incoming Distress Calls.....	44
Minimizing Nearby Large-Object Interference.....	38	Navigating to a Vessel in Distress.....	44
Minimizing Side-Lobe Interference on the Radar Screen.....	38	Man-Overboard Distress Calls Initiated from a VHF Radio.....	44
Radar Filter Settings.....	38	Man-Overboard and SOS Distress Calls Initiated from the Chartplotter.....	45
Adjusting Sea Clutter on the Radar Screen.....	38	Position Tracking.....	45
Adjusting Rain Clutter on the Radar Screen.....	38		
Averaging Multiple Scans on the Radar Screen.....	38		
Radar Options Menu.....	38		
Radar Setup Menu.....	39		

Viewing a Position Report .....	45	Saving Messages to a Memory Card .....	50
Navigating to a Tracked Vessel .....	45	Clearing all of the Messages .....	50
Creating a Waypoint at the Position of a Tracked Vessel ....	45	<b>Media Player .....</b>	<b>50</b>
Editing Information in a Position Report .....	45	Opening the Media Player .....	50
Deleting a Position-Report Call .....	45	Media Player Icons .....	50
Viewing Vessel Trails on the Chart .....	45	Selecting the Media Device and Source .....	51
Individual Routine Calls .....	45	Playing Music .....	51
Selecting a DSC Channel .....	45	Browsing for Music .....	51
Making an Individual Routine Call .....	45	Enabling Alphabetical Search .....	51
Making an Individual Routine Call to an AIS Target .....	45	Setting a Song to Repeat .....	51
<b>Gauges and Graphs .....</b>	<b>45</b>	Setting All Songs to Repeat .....	51
Viewing the Gauges .....	45	Setting Songs to Shuffle .....	51
Changing the Data Shown in a Gauge .....	45	Joining the Fusion PartyBus™ Network .....	51
Customizing the Gauges .....	46	Adjusting the Volume .....	51
Customizing Engine Gauge and Fuel Gauge Limits .....	46	Muting the Media Volume .....	51
Selecting the Number of Engines Shown in Gauges .....	46	Enabling and Disabling Zones .....	51
Customizing the Engines Shown in Gauges .....	46	VHF Radio .....	51
Enabling Status Alarms for Engine Gauges .....	46	Scanning VHF Channels .....	51
Enabling Some Engine Gauge Status Alarms .....	46	Adjusting the VHF Squelch .....	51
Yamaha Engine Gauges .....	46	Radio .....	51
Engine Condition Icons .....	46	Setting the Tuner Region .....	51
Engine Alert Icons .....	46	Changing the Radio Station .....	51
Setting Up the Gauges .....	47	Changing the Tuning Mode .....	51
Configuring the Number of Engines .....	47	Presets .....	51
Configuring the Tank Level Sensors .....	47	Saving a Station as a Preset .....	51
Changing the Data Shown .....	47	Selecting a Preset .....	51
Yamaha Engine Data Settings .....	47	Removing a Preset .....	52
Setting the Fuel Alarm .....	47	DAB Playback .....	52
Setting the Fuel Capacity of the Vessel .....	47	Setting the DAB Tuner Region .....	52
Synchronizing the Fuel Data with the Actual Vessel Fuel ...	47	Scanning for DAB Stations .....	52
Viewing the Wind Gauges .....	48	Changing DAB Stations .....	52
Configuring the Sailing Wind Gauge .....	48	Selecting a DAB Station from a List .....	52
Configuring the Speed Source .....	48	Selecting a DAB Station from a Category .....	52
Configuring the Heading Source of the Wind Gauge .....	48	DAB Presets .....	52
Customizing the Close-Hauled Wind Gauge .....	48	Saving a DAB Station as a Preset .....	52
Viewing Trip Gauges .....	48	Selecting a DAB Preset from a List .....	52
Resetting Trip Gauges .....	48	Removing DAB Presets .....	52
Battery Management .....	48	SiriusXM Satellite Radio .....	52
Setting Up the Battery Management Page .....	48	Locating a SiriusXM Radio ID .....	52
Viewing Graphs .....	48	Activating a SiriusXM Subscription .....	52
Setting the Graph Range and Time Scales .....	48	Customizing the Channel Guide .....	52
<b>inReach® Messages .....</b>	<b>48</b>	Saving a SiriusXM Channel to the Presets List .....	52
Connecting an inReach Device to the Chartplotter .....	48	Parental Controls .....	53
Receiving inReach Messages .....	49	Unlocking SiriusXM Parental Controls .....	53
Sending an inReach Preset Message .....	49	Setting Parental Controls on SiriusXM Radio	
Replying to an inReach Message .....	49	Channels .....	53
<b>Digital Switching .....</b>	<b>49</b>	Clearing All Locked Channels on a SiriusXM Radio .....	53
Adding and Editing a Digital Switching Page .....	49	Restoring Default Parental Control Settings Values .....	53
<b>Dometic® Optimus® Features .....</b>	<b>49</b>	Changing a Parental Passcode on a SiriusXM Radio .....	53
Activating the Optimus Overlay Bar .....	49	Setting the Device Name .....	53
Optimus Overlay Bar Overview .....	49	Updating the Media Player Software .....	53
Optimus Overlay Symbols .....	49	<b>SiriusXM Weather .....</b>	<b>53</b>
Optimus Limp Home Mode .....	49	SiriusXM Equipment and Subscription Requirements .....	53
<b>Tide, Current, and Celestial Information .....</b>	<b>50</b>	Weather Data Broadcasts .....	53
Tide Station Information .....	50	Weather Warnings and Weather Bulletins .....	53
Current Station Information .....	50	Changing the Weather Chart .....	54
Celestial Information .....	50	Viewing Precipitation Information .....	54
Viewing Tide Station, Current Station, or Celestial Information		Storm Cell and Lightning Information .....	54
for a Different Date .....	50	Hurricane Information .....	54
Viewing Information for a Different Tide or Current Station .....	50	Forecast Information .....	54
Viewing Almanac Information from the Navigation Chart .....	50	Viewing a Marine Forecast or an Offshore Forecast .....	54
<b>Warning Manager .....</b>	<b>50</b>	Viewing Forecast Information for Another Time Period .....	54
Viewing Messages .....	50	Weather Fronts and Pressure Centers .....	54
Sorting and Filtering Messages .....	50	City Forecasts .....	54
		Viewing Fish Mapping Data .....	54
		Viewing Sea Conditions .....	54

Surface Winds .....	54	Setting the Anchor Drag Alarm .....	61
Wave Height, Wave Period, and Wave Direction .....	55	System Alarms .....	61
Viewing Forecast Sea Conditions Information for Another Time Period .....	55	Sonar Alarms .....	61
Viewing Sea Temperature Information .....	55	Setting Weather Alarms .....	62
Surface Pressure and Water Temperature Data .....	55	Setting the Fuel Alarm .....	62
Changing the Sea Surface Temperature Color Range .....	55	My Vessel Settings .....	62
Visibility Information .....	55	Setting the Keel Offset .....	62
Viewing Forecast Visibility Information for Another Time Period .....	55	Setting the Water Temperature Offset .....	62
Viewing Buoy Reports .....	55	Calibrating a Water-Speed Device .....	63
Viewing Local Weather Information near a Buoy .....	55	Other Vessels Settings .....	63
Weather Overlay .....	55	Settings that are Synced on the Garmin Marine Network .....	63
Viewing Weather Subscription Information .....	55	Restoring the Original Chartplotter Factory Settings .....	63
<b>Viewing Video .....</b>	<b>55</b>	<b>Sharing and Managing User Data .....</b>	<b>64</b>
Selecting a Video Source .....	56	Selecting a File Type for Third-Party Waypoints and Routes .....	64
Alternating Among Multiple Video Sources .....	56	Copying User Data from a Memory Card .....	64
Networked Video Devices .....	56	Copying User Data to a Memory Card .....	64
Using Video Presets on Networked Video Cameras .....	56	Updating Built-In Maps with a Memory Card and Garmin Express .....	64
Saving Video Presets on a Networked Video Camera .....	56	Backing Up Data to a Computer .....	64
Naming Video Presets on a Networked Video Camera .....	56	Restoring Backup Data to a Chartplotter .....	64
Activating Video Presets on a Networked Video Camera .....	56	Saving System Information to a Memory Card .....	64
Camera Settings .....	56	<b>Appendix .....</b>	<b>64</b>
Video Settings .....	56	ActiveCaptain and Garmin Express .....	64
Associating the Camera to a Video Source .....	56	Garmin Express App .....	65
Video Camera Movement Control .....	56	Installing the Garmin Express App on a Computer .....	65
Controlling Video Cameras Using On-Screen Controls .....	57	Registering Your Device Using the Garmin Express App .....	65
Controlling a Video Camera Using Gestures .....	57	Updating Your Charts Using the Garmin Express App .....	65
Configuring the Video Appearance .....	57	Software Updates .....	65
Garmin VIRB® Action Cameras .....	57	Loading the New Software on a Memory Card Using Garmin Express .....	66
Connecting a VIRB 360 Action Camera .....	57	Updating the Device Software Using a Memory Card .....	66
Connecting a VIRB Action Camera .....	57	Pairing the GRID Device with the Chartplotter from the Chartplotter .....	66
Controlling the VIRB Action Camera with the Chartplotter .....	57	Pairing the GRID Device with the Chartplotter from the GRID Device .....	66
Controlling the VIRB Action Camera Video Playback .....	58	Rotating the GRID Remote Input Device .....	66
Deleting a VIRB Video .....	58	Cleaning the Screen .....	66
Starting a VIRB Video Slideshow .....	58	Viewing Images on a Memory card .....	66
VIRB Action Camera Settings .....	58	Screenshots .....	67
VIRB Action Camera Video Setup Settings .....	58	Capturing Screenshots .....	67
Adding the VIRB Action Camera Controls to Other Screens .....	58	Copying Screenshots to a Computer .....	67
HDMI Out Video Considerations .....	58	Troubleshooting .....	67
Pairing the GC™ 100 Camera with a Garmin Chartplotter .....	58	My device will not acquire GPS signals .....	67
<b>Device Configuration .....</b>	<b>59</b>	My device will not turn on or keeps turning off .....	67
System Settings .....	59	My device is not creating waypoints in the correct location .....	67
Sounds and Display Settings .....	59	Contacting Garmin Support .....	67
GPS Settings .....	59	Specifications .....	67
Station Settings .....	59	GPSMAP 7x2/7x2 Plus Specifications .....	67
Viewing System Software Information .....	59	GPSMAP 9x2/9x2 Plus Specifications .....	68
Viewing the Event Log .....	59	GPSMAP 12x2 Touch/A12/12x2 Plus Specifications .....	68
Viewing E-label Regulatory and Compliance Information .....	59	GPSMAP 7x3 Specifications .....	68
Preferences Settings .....	59	GPSMAP 9x3 Specifications .....	68
Units Settings .....	59	GPSMAP 12x3 Specifications .....	69
Navigation Settings .....	60	Sonar Models Specifications .....	69
Auto Guidance Path Configurations .....	60	NMEA 2000 PGN Information .....	69
Adjusting the Distance from Shore .....	60	NMEA 0183 Information .....	70
Communications Settings .....	60	J1939 Information .....	70
NMEA 0183 Settings .....	60	<b>Index .....</b>	<b>71</b>
Configuring NMEA 0183 Output Sentences .....	61		
Setting the Communication Format for Each NMEA 0183 Port .....	61		
NMEA 2000 Settings .....	61		
Naming Devices and Sensors on the Network .....	61		
Marine Network .....	61		
Setting Alarms .....	61		
Navigation Alarms .....	61		





# Introduction

## ⚠ WARNING

See the *Important Safety and Product Information* guide in the product box for product warnings and other important information.

All route and navigation lines displayed on the chartplotter are only intended to provide general route guidance or to identify proper channels, and are not intended to be precisely followed. Always defer to the nav aids and conditions on the water when navigating to avoid groundings or hazards that could result in vessel damage, personal injury, or death.

**NOTE:** Not all features are available on all models.

The Garmin® website at [support.garmin.com](http://support.garmin.com) presents up-to-date information about your product. The support pages will provide answers to frequently asked support questions, and you can download software and chart updates. There is also contact information to Garmin support should you have any questions.

## Device Overview



①	Touchscreen
②	Power key
③	Automatic backlight sensor
④	12x2/A12 models: 2 SD® memory card slots. 7x2/9x2 models: 2 microSD® memory card slots. 7x3/9x3/12x3 models: 2 microSD memory card slots are on the back of the device. All models: 32 GB max. card size.

## GPSMAP 7x2/7x2 Plus and GPSMAP 9x2/9x2 Plus Connector View

The connectors and locations vary based upon the model. This image and table represent a GPSMAP 922xs Plus model.



J1939	J1939 engine network (Not available on all models)
NMEA 2000	NMEA 2000® network
CVBS IN	Composite video in
ETHERNET	Garmin Marine Network
8-PIN XDCR	8-pin transducer (Not available on all models)
POWER	Power and NMEA® 0183 network
⏏	Ground screw

## GPSMAP 12x2 Touch/A12/12x2 Plus Connector View

The connectors and locations vary based upon the model.



SONAR	12-pin transducer (Not available on all models)
POWER	Power and NMEA 0183 network
⏏	Ground screw
CVBS IN	Composite video in
J1939	Engine or J1939 network
ETHERNET	Garmin Marine Network
HDMI OUT	HDMI® video out
NMEA 2000	NMEA 2000 network

## GPSMAP 7x3 and GPSMAP 9x3 Connector View

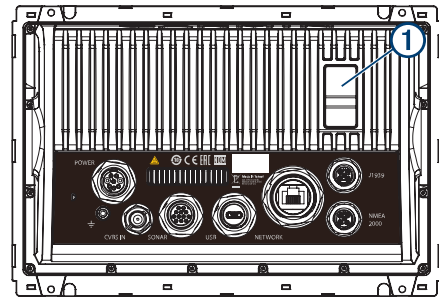

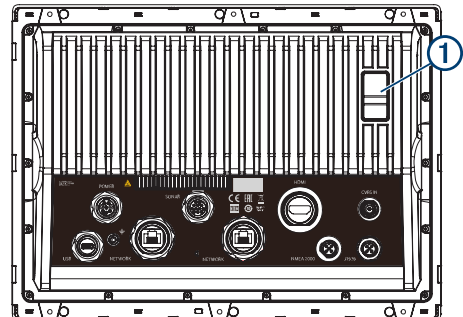

POWER	Power and NMEA 0183 network
ETHERNET	Garmin Marine Network
J1939	J1939 engine network
⏏	Ground screw
CVBS IN	Composite video in
SONAR	12-pin transducer (Not available on all models)
USB	Micro-USB for compatible Garmin card reader <sup>1</sup>
NMEA 2000	NMEA 2000 network
①	2 microSD memory card slots, 32 GB max.

## GPSMAP 12x3 Connector View



POWER	Power and NMEA 0183 network
SONAR	12-pin transducer (Not available on all models)
HDMI OUT	HDMI video out

<sup>1</sup> Only compatible Garmin card readers recommended. Third-party card readers are not guaranteed to be fully compatible.





















CVBS IN	Composite video in
USB	Micro-USB for compatible Garmin card reader <sup>1</sup>
	Ground screw
ETHERNET	Garmin Marine Network
NMEA 2000	NMEA 2000 network
J1939	Engine or J1939 network
	2 microSD memory card slots, 32 GB max.

## Using the Touchscreen

- Tap the screen to select an item.
- Drag or swipe your finger across the screen to pan or scroll.
- Pinch two fingers together to zoom out.
- Spread two fingers apart to zoom in.



## On-Screen Buttons

These on-screen buttons may be displayed on some screens and functions. Some buttons are accessible only in a combination page or SmartMode™ layout or when accessories, such as a radar, are connected.



Button	Function
	Clears the on-screen icons and re-centers the screen on the boat
	Opens a full-screen view of the item
	Creates a new waypoint
	Creates a route, with turns, to the destination
	Adds a turn to the route at the selected location
	Removes the last added turn from the route
	Creates a direct route, without turns, to the destination
	Creates an Auto Guidance route to the destination
	Begins navigation
	Ends navigation
	Stops and starts radar transmission
	Opens the radar gain adjustment menu
	Opens the radar sea clutter adjustment menu
	Opens the radar rain clutter adjustment menu
	Turns on and off the radar echo trails
	Acquires a radar target and begins tracking it
	Shows and sets the VRM/EBL line
	Opens the menu for the page or function
	Opens the Weather menu for the page or function
	Opens the Radar menu for the page or function
	Opens the Presets menu for the page or function





## Locking and Unlocking the Touchscreen

You can lock the touchscreen to prevent inadvertent screen touches.



- 1 Select  > **Lock Touchscreen** to lock the screen.
- 2 Select  to unlock the screen.

## Tips and Shortcuts (MFD models)

- Press  to turn on the chartplotter.
- From any screen, press  repeatedly to scroll through the brightness levels, if available. This can be helpful when the brightness is so low you cannot see the screen.
- Select **Home** from any screen to return to the Home screen.
- Select **Menu** to open additional settings about that screen.
- Select **Menu** to close the menu when finished.

- Press  to open additional options, such as locking the touchscreen.
- Press , and select **Power > Turn Off System**, or hold  until the **Turn Off System** bar fills to turn off the chartplotter, when available.
- Press , and select **Power > Sleep Station** to set the chartplotter to standby mode, when available.
- On the home screen of some models, swipe up or down on the category buttons along the right side of the screen to view the additional buttons.  
On some models, not all category buttons are visible. The arrows at the top or bottom of the buttons indicate not all buttons are visible.
- On some menu buttons, select the button  to enable the option.



- A green light on an option indicates the option is enabled .
- When available, select the arrow  to open the menu.

## Accessing Owner's Manuals on the Chartplotter

- 1 Select **Info > Owner's Manual**.
- 2 Select a manual.
- 3 Select **Open**.

## Downloading the Manuals from the Web

You can get the latest owner's manual and translations of manuals from the Garmin website. The owner's manual includes instructions for using device features and accessing regulatory information.

- 1 Go to [garmin.com/manuals/GPSMAPPlus](http://garmin.com/manuals/GPSMAPPlus).
- 2 Download the manual.

## Garmin Support Center

Go to [support.garmin.com](http://support.garmin.com) for help and information, such as product manuals, frequently asked questions, videos, software updates, and customer support.

## Memory Cards

You can use optional memory cards with the chartplotter. Map cards allow you to view high-resolution satellite imagery and aerial reference photos of ports, harbors, marinas, and other points of interest. You can use blank memory cards to record Garmin Quickdraw™ Contours mapping, record sonar (with a compatible transducer), transfer data such as waypoints and routes to another compatible chartplotter or a computer, and use the ActiveCaptain® app.

This device supports up to a 32 GB memory card, formatted to FAT32 with speed class 4 or higher. Use of an 8 GB or higher memory card with speed class 10 is recommended.

Model	Memory Card Location	Memory Card Type
GPSMAP 7x2/7x2 Plus	Front of the device	microSD
GPSMAP 9x2/9x2 Plus	Front of the device	microSD
GPSMAP 12x2 Touch/A12/12x2 Plus	Front of the device	SD
GPSMAP 7x3/9x3/12x3	Back of the device	microSD

<sup>1</sup> Only compatible Garmin card readers recommended. Third-party card readers are not guaranteed to be fully compatible.

## Inserting Memory Cards (GPSMAP 7x2/9x2/12x2 Touch/A12/7x2 Plus/9x2 Plus/12x2 Plus)

You can use optional memory cards with the chartplotter. Map cards allow you to view high-resolution satellite imagery and aerial reference photos of ports, harbors, marinas, and other points of interest. You can use blank memory cards to record Garmin Quickdraw Contours mapping, record sonar (with a compatible transducer), transfer data such as waypoints and routes to another compatible chartplotter or a computer, and use the ActiveCaptain app.

This device supports up to a 32 GB memory card, formatted to FAT32 with speed class 4 or higher. Use of an 8 GB or higher memory card with speed class 10 is recommended. 12x2/A12 models use an SD memory card. 7x2/9x2 models use a microSD memory card.

- 1 Open the access flap or door ① on the front of the chartplotter.



- 2 Insert the memory card ②.
- 3 Press the card in until it clicks.
- 4 Clean and dry the gasket and door.

### NOTICE

To prevent corrosion, be sure the memory card, gasket, and door are thoroughly dry before closing the door.

- 5 Close the door.

## Inserting Memory Cards (GPSMAP 7x3/9x3/12x3)

This device supports up to a 32 GB microSD memory card, formatted to FAT32 with speed class 4 or higher. Use of an 8 GB or higher memory card with speed class 10 is recommended.

- 1 Open the weather cap ① on the back of the chartplotter.

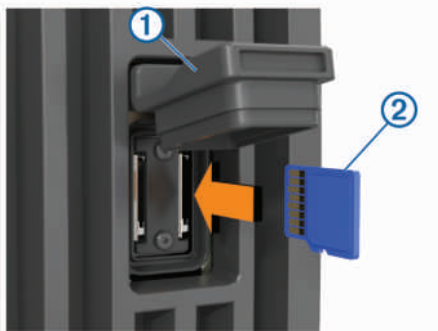

- 2 Insert the memory card ②.
- 3 Press the card in until it clicks.
- 4 Press the weather cap firmly shut to prevent corrosion.

## Acquiring GPS Satellite Signals



The device may need a clear view of the sky to acquire satellite signals. The time and date are set automatically based on the GPS position.

- 1 Turn on the device.

- 2 Wait while the device locates satellites.

It may take 30 to 60 seconds to acquire satellite signals.

When the device acquires satellite signals,  appears at the top of the Home screen.

If the device loses satellite signals,  disappears and a flashing question mark appears over  on the chart.

For more information about GPS, go to [garmin.com/aboutGPS](http://garmin.com/aboutGPS). For help acquiring satellite signals, see *My device will not acquire GPS signals*, page 67.

## Selecting the GPS Source

You can select your preferred source for GPS data, if you have more than one GPS source.

- 1 Select **Settings > System > GPS > Source**.
- 2 Select the source for GPS data.

## Customizing the Chartplotter

### Home Screen

The chartplotter home screen provides access to all of the features in the chartplotter. The features are dependant on the accessories you have connected to the chartplotter. You may not have all of the options and features discussed in this manual.

When viewing another screen, you can return to the home screen by selecting Home.



①	Status bar
②	Pages buttons
③	Categories bar
④	Menu bar

The categories along the right of the screen provide quick access to the main features of your chartplotter. For example, the Sonar category displays the views and pages related to the sonar feature. You can save items you commonly access to the Favorites category.

**TIP:** If your home screen has been customized by the boat manufacturer, you can open the original home page category tabs by dragging the bar on the right side of the screen to the left.

The SmartMode items are geared toward an activity, such as cruising or docking. When a SmartMode button is selected from the home screen, each display in the station can show unique information. For example, when Cruising is selected from the home screen, one display can show the navigation chart and another display can show the radar screen.

All of the options along the bottom of the home screen are visible on all other screens, except for the Settings button. The Settings button is accessible only from the home screen.

An indicator appears on the Info button when an alarm is activated (*Warning Manager*, page 50).

When multiple displays are installed on the Garmin Marine Network, you can group them together into a station. A station enables the displays to work together, instead of as several separate displays. You can customize the layout of the pages on

each display, making each page different on each display. When you change the layout of a page in one display, the changes appear on only that display. When you change the name and symbol of the layout, those changes appear on all displays in the station, to maintain a consistent appearance.

### Adding an Item to Favorites

You can add items such as a chart, combo screen, or gauge to the Favorites category.

**NOTE:** If your home screen has been customized by the boat manufacturer, you cannot add an item to the Favorites category.

- 1 From the home screen, select a category from the right.
- 2 Hold a button on the left.

The item is added to the Favorites home screen category.

To remove an item you have added to the Favorites category, open the Favorites category, select **Menu > Remove Favorite**, and select the item to remove.

### Customizing the Home Screen

- 1 Open the home screen category to customize.
- 2 Select **Menu**.
- 3 Select an option:
  - To rearrange an item, select **Rearrange**, and select the new location.
  - To add an item to the **Favorites** category, select **Add to Favorites**, and select the item.
  - To change the home screen background image, select **Background**, and select an image (*Recommended Background Image Dimensions, page 4*).

## Customizing Pages

### Customizing the Layout of a SmartMode or Combination Page

You can customize the layout and data shown in the combination pages and SmartMode layouts. When you change the layout of a page in a display you are interacting with, the change appears only on that display, except for the SmartMode name and symbol. When you change the SmartMode name or symbol for the layout, the new name or symbol appears on all displays in the station.

- 1 Open a page to customize.
- 2 Select **Menu**.
- 3 Select **Edit Layout** or **Edit Combo**.
- 4 Select an option:
  - To change the name, select **Name** or **Name & Symbol > Name**, enter a new name, and select **Done**.
  - To change the SmartMode symbol, select **Name & Symbol > Symbol**, and select a new symbol.
  - To change the number of functions shown and the layout of the screen, select **Layout**, and select an option.
  - To change the function of a portion of the screen, select the window to change, and select a function from the list on the right.
  - To change how the screens are split, drag the arrows to a new location.
  - To change the data shown on the page and additional data bars, select **Overlays**, and select an option.

**TIP:** While viewing a screen with data overlay, hold an overlay box to quickly change the data in it.

- To assign a preset to a portion of the SmartMode screen, select **Presets > Include**, and select a preset from the list on the right.

### Changing the Background Image

- 1 From the home screen, select **Menu > Background**.

**TIP:** You can also adjust this setting from **Settings > System > Sounds and Display > Background**.

- 2 Select an image.

#### Recommended Background Image Dimensions

For the best fit for the background image, use an image that has the following dimensions, in pixels.

Display resolution	Image width	Image height
WVGA	800	430
WSVGA	1024	535
WXGA	1380	723
HD	1920	991
WUXGA	1920	1111

### Customizing the Startup Screen

You personalize the image that is displayed when the chartplotter is turning on. For the best fit, the image should be 50 MB or less and conform to the recommended dimensions (*Recommended Startup Image Dimensions, page 4*).

- 1 Insert a memory card that contains the image you want to use.
- 2 Select **Settings > System > Sounds and Display > Startup Image > Select Image**.
- 3 Select the memory card slot.
- 4 Select the image.
- 5 Select **Set as Startup Image**.

The new image is shown then turning on the chartplotter.

#### Recommended Startup Image Dimensions

For the best fit for the startup images, use an image that has the following dimensions, in pixels.

Display resolution	Image width	Image height
WVGA	680	200
WSVGA	880	270
WXGA	1080	350
HD	1240	450
WUXGA	1700	650

### Adding a SmartMode Layout

You can add SmartMode layouts to suit your needs. Each customization made to one SmartMode layout for the home screen in a station appears on all displays in the station.

- 1 From the home screen, select **SmartMode™ > Menu > Add Layout**.
- 2 Select an option:
  - To change the name, select **Name & Symbol > Name**, enter a new name, and select **Done**.
  - To change the SmartMode symbol, select **Name & Symbol > Symbol**, and select a new symbol.
  - To change the number of functions shown and the layout of the screen, select **Layout**, and select an option.
  - To change the function of a portion of the screen, select the window to change, and select a function from the list on the right.
  - To change how the screens are split, drag the arrows to a new location.
  - To change the data shown on the page and additional data bars, select **Overlays**, and select an option.
  - To assign a preset to a portion of the SmartMode screen, select **Presets > Include**, and select a preset from the list on the right.

## Creating a New Combination Page

You can create a custom combination page to suit your needs.

- 1 Select **Combos > Menu > Add Combo**.
- 2 Select a window.
- 3 Select a function for the window.
- 4 Repeat these steps for each window of the page.
- 5 Drag the arrows to resize the windows.
- 6 Hold a window to rearrange it.
- 7 Hold a data field to select new data.
- 8 Select **Layout**, and select a layout.



- 9 Select **Name**, enter a name for the page, and select **Done**.
- 10 Select **Overlays**, and select which data to show.
- 11 Select **Done** when you have finished customizing the page.

## Deleting a Combination Page

- 1 Select **Combos > Menu > Delete Combo**.
- 2 Select a combination.

## Customizing the Data Overlays

You can customize the data in the data overlays shown on a screen.



- 1 Select an option based on the type of screen you are viewing:
  - From a full screen view, select **Menu > Edit Overlays**.
  - From a combination screen, select **Menu > Edit Combo > Overlays**.
  - From a SmartMode screen, select **Menu > Edit Layout > Overlays**.

**TIP:** To quickly change the data shown in an overlay box, hold the overlay box.
- 2 Select an item to customize the data and data bar:
  - To change the data shown in an overlay box, select the overlay box, select the new data to show, and select **Back**.
  - To select the location and layout of the data overlay bar, select **Data**, and select an option.
  - To customize the information shown when navigating, select **Navigation**, and select an option.
  - To turn on other data bars, like the media controls, select **Top Bar** or **Bottom Bar**, and select the necessary options.
- 3 Select **Done**.

## Resetting the Station Layouts

You can restore the layouts in this station to the factory default settings.

- 1 Select **Settings > System > Station Information > Reset Layouts**.

## Presets

A preset is a collection of settings that optimize the screen or view. You can use particular presets to optimize groups of settings for your activity. For example, some settings might be optimal for when you are fishing, and others might be optimal for when you are cruising. Presets are available on some screens, such as charts, sonar views, and radar views.

To select a preset for a compatible screen, select **Menu > i★**, and select the preset.

When you are using a preset and you make changes to the settings or view, you can save the changes to the preset or create a new preset based on the new customizations.

## Saving a New Preset

After you have customized the settings and view of a screen, you can save the customization as a new preset.

- 1 From a compatible screen, change the settings and view.
- 2 Select **Menu > i★ > Save > New**.
- 3 Enter a name, and select **Done**.
- 4 Select an item, and select **Include** to include or exclude the item from the preset.

## Managing Presets

You can customize the pre-loaded presets and edit presets you created.

- 1 From a compatible screen, select **Menu > i★ > Manage**.
- 2 Select a preset.
- 3 Select an option:
  - To rename the preset, select **Rename**, enter a name, and select **Done**.
  - To edit the preset, select **Edit**, and update the preset.
  - To delete the preset, select **Delete**.
  - To reset all presets to factory settings, select **Reset All**.

## Setting the Vessel Type

You can select your boat type to configure the chartplotter settings and to use features customized for your boat type.

- 1 Select **Settings > My Vessel > Vessel Type**.
- 2 Select an option.

## Adjusting the Backlight

- 1 Select **Settings > System > Display > Backlight**.
- 2 Adjust the backlight.

**TIP:** From any screen, press  $\odot$  repeatedly to scroll through the brightness levels. This can be helpful when the brightness is so low you cannot see the screen.

## Adjusting the Color Mode



- 1 Select **Settings > System > Sounds and Display > Color Mode**.

**TIP:** Select  $\odot$  > **Color Mode** from any screen to access the color settings.
- 2 Select an option.

## Turning On the Chartplotter Automatically

You can set the chartplotter to turn on automatically when the power is applied. Otherwise, you must turn on the chartplotter by pressing  $\odot$ .

Select **Settings > System > Auto Power Up**.

**NOTE:** When Auto Power Up is On, and the chartplotter is turned off using , and power is removed and reapplied within less than two minutes, you may need to press  to restart the chartplotter.

## Enabling Screen Lock

For anti-theft protection and to prevent unauthorized use of your device, you can enable the Screen Lock feature which requires a PIN (Personal Identification Number). When enabled, you must enter the PIN to unlock the screen each time you turn on the device. You can set up recovery questions and answers as prompts in case you forget the PIN.

### NOTICE

If you enable the Screen Lock feature, Garmin Support cannot retrieve the PIN or access your device. It is your responsibility to provide the PIN to anyone authorized to use the vessel.

- 1 Select **Settings > System > Sounds and Display > Screen Lock > Setup**.
- 2 Enter a memorable numeric PIN of 6 digits.
- 3 Reenter the PIN to verify.
- 4 When prompted, choose and answer three PIN recovery questions.

You can Disable or Reset the PIN and recovery questions as needed.

## Automatically Turning Off the System

You can set the chartplotter and the whole system to turn off automatically after it has been asleep for the selected length of time. Otherwise, you must press and hold  to turn off the system manually.

- 1 Select **Settings > System > Auto Power Off**.
- 2 Select an option.

## ActiveCaptain App

### ⚠ CAUTION

This feature allows users to submit information. Garmin makes no representations about the accuracy, completeness, or timeliness of information submitted by users. Any use or reliance on the information submitted by users is at your own risk.

The ActiveCaptain app provides a connection to your GPSMAP device, charts, maps, and the community for a connected boating experience.

On your mobile device with the ActiveCaptain app, you can download, purchase, and update maps and charts. You can use the app to easily and quickly transfer user data, such as waypoints and routes, connect to the Garmin Quickdraw Contours Community, update device software, and plan your trip.

You can connect to the ActiveCaptain community for up-to-date feedback on marinas and other points of interest. The app can push smart notifications, such as calls and texts, to your chartplotter display when paired.

## ActiveCaptain Roles

Your level of interaction with the GPSMAP device using the ActiveCaptain app depends on your role.

Feature	Owner	Guest
Register device, built-in maps, and supplemental map cards to account	Yes	No
Update software	Yes	Yes

Feature	Owner	Guest
Automatically transfer Garmin Quickdraw contours you have downloaded or created	Yes	No
Push smart notifications	Yes	Yes
Automatically transfer user data, such as waypoints and routes	Yes	No
Begin navigating to a specific waypoint or navigating a specific route, and send that waypoint or route to the GPSMAP device	Yes	Yes

## Getting Started with the ActiveCaptain App

You can connect a mobile device to the GPSMAP device using the ActiveCaptain app. The app provides a quick and easy way for you to interact with your GPSMAP device and complete such tasks as sharing data, registering, updating the device software, and receiving mobile device notifications.

- 1 From the GPSMAP device, select **A/V, Gauges, Controls > ActiveCaptain**.
- 2 From the **ActiveCaptain** page, select **Wi-Fi Network > Wi-Fi > On**.
- 3 Enter a name and password for this network.
- 4 Insert a memory card in the GPSMAP device's card slot ([Memory Cards, page 2](#)).
- 5 Select **Set ActiveCaptain Card**.

### NOTICE

You might be prompted to format the memory card. Formatting the card deletes all information saved on the card. This includes any saved user data, such as waypoints. Formatting the card is recommended, but not required. Before formatting the card, you should save the data from the memory card onto the device internal memory ([Copying User Data from a Memory Card, page 64](#)). After formatting the card for the ActiveCaptain app, you can transfer the user data back to the card ([Copying User Data to a Memory Card, page 64](#)).

Be sure the card is inserted each time you want to use the ActiveCaptain feature.

- 6 From the application store on your mobile device, install and open the ActiveCaptain app.
- 7 Bring the mobile device within 32 m (105 ft.) of the GPSMAP device.
- 8 From your mobile device settings, open the Wi-Fi® connections page and connect to the Garmin device, using the name and password you entered in the Garmin device.

## Enabling Smart Notifications

### ⚠ WARNING

Do not read or reply to notifications while operating the vessel. Failure to pay attention to the conditions on the water can result in vessel damage, personal injury, or death.

Before your GPSMAP device can receive notifications, you must connect it to your mobile device and to the ActiveCaptain app.

- 1 From the GPSMAP device, select **ActiveCaptain > Smart Notifications > Enable Notifications**.
- 2 Turn on Bluetooth® technology in the mobile device settings.
- 3 Bring the devices within 10 m (33 ft.) of each other.
- 4 From the ActiveCaptain app on the mobile device, select **Smart Notifications > Pair with Chartplotter**.
- 5 Follow the on-screen instructions to pair the app to the GPSMAP device.
- 6 When prompted, enter the key on your mobile device.

- If necessary, adjust which notifications you receive in your mobile device settings.

## Receiving Notifications

### WARNING

Do not read or reply to notifications while operating the vessel. Failure to pay attention to the conditions on the water can result in vessel damage, personal injury, or death.

Before your GPSMAP device can receive notifications, you must connect it to your mobile device and enable the Smart Notifications feature (*Enabling Smart Notifications, page 6*).

When the Smart Notifications feature is enabled and your mobile device receives a notification, a pop-up notification appears on the GPSMAP screen briefly.

**NOTE:** The available actions depend on the type of notification and your phone operating system.

- To answer a phone call on your phone, select **Answer**.  
**TIP:** Have your phone nearby. The phone call is answered on your mobile phone, not on the chartplotter.
- To not answer the phone call, select **Decline**.
- To review the full message, select **Review**.
- To dismiss the pop-up notification, select **OK** or wait for the notification to close automatically.
- To remove the notification from the chartplotter and your mobile device, select **Clear**.

## Managing Notifications

### WARNING

Do not read or reply to notifications while operating the vessel. Failure to pay attention to the conditions on the water can result in vessel damage, personal injury, or death.

Before you can manage the notifications, you must enable the Smart Notifications feature (*Enabling Smart Notifications, page 6*).

When the Smart Notifications feature is enabled and your mobile device receives a notification, a pop-up notification appears on the GPSMAP screen briefly. You can access and manage the notifications from the ActiveCaptain screen.

- Select **ActiveCaptain > Smart Notifications > Messages**.

A list of notifications appear.

- Select a notification.

- Select an option:

**NOTE:** The available options vary based on your mobile device and the notification type.

- To dismiss and remove the notification from the chartplotter and your mobile device, select **Clear** or **Delete**.

**NOTE:** This does not delete the message from the mobile device. This only dismisses and removes the notification.

- To call the phone number back, select **Call Back** or **Dial**.

## Making Notifications Private

You can turn off the pop-up notifications and disable the messages list on specific chartplotters for privacy. For example, the captain could disable pop-up notifications and messages on the chartplotter used for fishing, but allow notifications on the chartplotter used at the helm.

- From the chartplotter you want notifications to be private, select **ActiveCaptain > Smart Notifications**.

- Select an option:

- To turn off pop-up notifications on this chartplotter, select **Popups**.

- To turn off pop-up notifications and disable access to the messages list on this chartplotter, select **Visibility**.

## Updating Software with the ActiveCaptain App

If your device has Wi-Fi technology, you can use the ActiveCaptain app to download and install the latest software updates for your device.

### NOTICE

Software updates may require the app to download large files. Regular data limits or charges from your Internet service provider apply. Contact your Internet service provider for more information about data limits or charges.

The installation process can take several minutes.

- 1 Connect the mobile device to the GPSMAP device (*Getting Started with the ActiveCaptain App, page 6*).

- 2 When a software update is available and you have internet access on your mobile device, select **Software Updates > Download**.

The ActiveCaptain app downloads the update to the mobile device. When you reconnect the app to the GPSMAP device, the update is transferred to the device. After the transfer is complete, you are prompted to install the update.

- 3 When you are prompted by the GPSMAP device, select an option to install the update.

- To update the software immediately, select **OK**.
- To delay the update, select **Cancel**. When you are ready to install the update, select **ActiveCaptain > Software Updates > Install Now**.

## Updating Charts with ActiveCaptain

You can use the ActiveCaptain app to download and transfer the latest chart updates for your device. To save space on your mobile device, space on the ActiveCaptain card, and download time, consider using the ActiveCaptain app to download only the areas of the chart you need.

If you are downloading an entire chart, you can use the Garmin Express™ app to download the map onto a memory card (*Updating Your Charts Using the Garmin Express App, page 65*). The Garmin Express app downloads large charts more quickly than the ActiveCaptain app.

### NOTICE

Chart updates may require the app to download large files. Regular data limits or charges from your internet service provider apply. Contact your internet service provider for more information about data limits or charges.

- 1 Connect the mobile device to the GPSMAP device (*Getting Started with the ActiveCaptain App, page 6*).

- 2 When a chart update is available, and you have internet access on your mobile device, select **OneChart > My Charts**.

- 3 Select the map to update.

- 4 Select the area to download.

- 5 Select **Download**.

The ActiveCaptain app downloads the update to the mobile device. When you reconnect the app to the GPSMAP device, the update is transferred to the device. After the transfer is complete, the updated charts are available for use.

## Communication with Wireless Devices

The chartplotters can create a wireless network to which you can connect wireless devices.

Connecting wireless devices allows you to use Garmin apps, such as ActiveCaptain.

## Wi-Fi Network

### Setting Up the Wi-Fi Wireless Network

The chartplotters can create a Wi-Fi network to which you can connect wireless devices. The first time you access the wireless network settings, you are prompted to set up the network.

- 1 Select **Settings > Communications > Wi-Fi Network > Wi-Fi > On > OK**.
- 2 If necessary, enter a name for this wireless network.
- 3 Enter a password.

You will need this password to access the wireless network from a wireless device. The password is case-sensitive.

### Connecting a Wireless Device to the Chartplotter

Before you can connect a wireless device to the chartplotter wireless network, you must configure the chartplotter wireless network (*Setting Up the Wi-Fi Wireless Network, page 8*).

You can connect multiple wireless devices to the chartplotter to share data.

- 1 From the wireless device, turn on the Wi-Fi technology and search for wireless networks.
- 2 Select the name of your chartplotter wireless network (*Setting Up the Wi-Fi Wireless Network, page 8*).
- 3 Enter the chartplotter password.

### Changing the Wireless Channel

You can change the wireless channel if you have trouble finding or connecting to a device, or if you experience interference.

- 1 Select **Settings > Communications > Wi-Fi Network > Advanced > Channel**.
- 2 Enter a new channel.

You do not need to change the wireless channel of devices connected to this network.

### Changing the Wi-Fi Host

If there are multiple chartplotters with Wi-Fi technology on the Garmin marine network, you can change which chartplotter is the Wi-Fi host. This can be helpful if you are having trouble with Wi-Fi communications. Changing the Wi-Fi host allows you to select a chartplotter that is physically closer to your mobile device.

- 1 Select **Settings > Communications > Wi-Fi Network > Advanced > Wi-Fi Host**.
- 2 Follow the on-screen instructions.

## Wireless Remote Control

These steps are not applicable to the GRID™ remote input devices (*Pairing the GRID Device with the Chartplotter from the Chartplotter, page 66*).

### Pairing the Wireless Remote Control With the Chartplotter

Before you can use the wireless remote control with a chartplotter, you must pair the remote with the chartplotter.

You can connect a single remote to multiple plotters, and then press the pairing key to switch between the chartplotters.

- 1 Select **Settings > Communications > Wireless Devices > Wireless Remotes > GPSMAP® Remote**.
- 2 Select **New Connection**.
- 3 Follow the on-screen instructions.

### Turning On and Off the Remote Backlight

Turning off the remote backlight can significantly increase the battery life.

- 1 On the chartplotter, select **Settings > Communications > Wireless Devices > Wireless Remotes > GPSMAP® Remote > Backlight**.
- 2 Follow the on-screen instructions.

### Disconnecting the Remote from All Chartplotters

- 1 On the chartplotter, select **Settings > Communications > Wireless Devices > Wireless Remotes > GPSMAP® Remote > Disconnect All**.
- 2 Follow the on-screen instructions.

## Wireless Wind Sensor

### Connecting a Wireless Sensor to the Chartplotter

You can view data from a compatible wireless sensor on the chartplotter.

- 1 Select **Settings > Communications > Wireless Devices**.
- 2 Select the wind sensor.
- 3 Select **Enable**.  
The chartplotter begins searching for and connecting to the wireless sensor.

To view data from the sensor, add the data to a data field or gauge.

### Adjusting the Wind Sensor Orientation

You should adjust this setting if the sensor does not face the front of the boat, exactly parallel to the center line.

**NOTE:** The opening where the cable connects to the pole indicates the front of the sensor.

- 1 Estimate the angle, in degrees clockwise around the mast, by which the sensor points away from the center of the front of the boat:
  - If the sensor is facing starboard, the angle should be between 1 and 180 degrees.
  - If the sensor is facing port, the angle should be between -1 and -180 degrees.
- 2 Select **Settings > Communications > Wireless Devices**.
- 3 Select the wind sensor.
- 4 Select **Wind Angle Offset**.
- 5 Enter the angle observed in step 1.
- 6 Select **Done**.

## Viewing Boat Data on a Garmin Watch

You can connect a compatible Garmin watch to a compatible chartplotter to view data from the chartplotter.

- 1 Bring the Garmin watch within range (3 m) of the chartplotter.
- 2 From the watch clock screen, select **START > Boat Data > START**.

**NOTE:** If you have already connected to a chartplotter, and would like to connect to a different chartplotter, open the Boat Data screen, hold UP, and select Pair new.

- 3 On the chartplotter, select **Communications > Wireless Devices > Connect IQ™ Apps > Boat Data > Enable > New Connection**.

The chartplotter begins searching for and connecting to the wearable device.

- 4 Compare the code shown on the chartplotter with the one shown on the watch.
- 5 If the codes match, select **Yes** to complete the pairing process.

After the devices are paired, they connect automatically when they are turned on and within range.



## Viewing Boat Data on a Garmin Nautix™ Device

You can connect a Garmin Nautix device to the chartplotter to view chartplotter data on the Garmin Nautix device.

**NOTE:** You can connect a Garmin Nautix device to multiple compatible devices for better coverage on larger vessels.

- 1 Bring the a Garmin Nautix device within range (3 m) of the chartplotter.  
The device automatically looks for all compatible devices within range.
- 2 If necessary, from the wearable device menu, select **Device Connections > Pair New Device**.
- 3 On the chartplotter, select **Settings > Communications > Wireless Devices > Connect IQ™ Apps > Boat Data > Enable Connections > New Connection**.

The chartplotter begins searching for and connecting to the wearable device.

After the devices are paired, they connect automatically when they are turned on and within range.

## Charts and 3D Chart Views

The charts and 3D chart views that are available depend on the map data and accessories used.

**NOTE:** 3D chart views are available with premium charts, in some areas.

You can access the charts and 3D chart views by selecting **Charts**.

**Nav. Chart:** Shows navigation data available on your pre-loaded maps and from supplemental maps, if available. The data includes buoys, lights, cables, depth soundings, marinas, and tide stations in an overhead view.

**Fishing Chart:** Provides a detailed view of the bottom contours and depth soundings on the chart. This chart removes navigational data from the chart, provides detailed bathymetric data, and enhances bottom contours for depth recognition. This chart is best for offshore deep-sea fishing.

**NOTE:** The Fishing chart is available with premium charts, in some areas.

**Perspective 3D:** Provides a view from above and behind the boat (according to your course) and provides a visual navigation aid. This view is helpful when navigating tricky shoals, reefs, bridges, or channels, and is beneficial when trying to identify entry and exit routes in unfamiliar harbors or anchorages.

**3D Chart:** Shows a detailed, three-dimensional view from above and behind the boat (according to your course) and provides a visual navigation aid. This view is helpful when navigating tricky shoals, reefs, bridges, or channels, and when trying to identify entry and exit routes in unfamiliar harbors or anchorages.

**Fish Eye 3D:** Provides an underwater view that visually represents the sea floor according to the chart information. When a sonar transducer is connected, suspended targets (such as fish) are indicated by red, green, and yellow spheres. Red indicates the largest targets and green indicates the smallest.

**Relief Shading:** Provides high resolution elevation shading of lakes and coastal waters. This chart can be helpful for fishing and diving.

**NOTE:** The Relief Shading chart is available with premium charts, in some areas.

## Navigation Chart and Fishing Chart

**NOTE:** The Fishing chart is available with premium charts, in some areas.

The Nav. Chart is optimized for navigation. You can plan a course, view map information, and use the chart as a navigational aid. To open the Nav. Chart, select **Charts > Nav. Chart**.

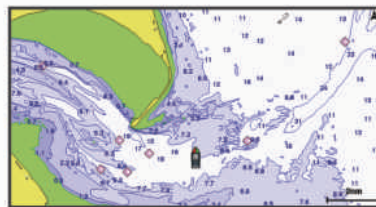

The Fishing Chart provides a detailed view with more bottom detail and fishing content. This chart is optimized for use when fishing. To open the Fishing Chart, select **Charts > Fishing Chart**.







### Zooming In and Out Using the Touchscreen

You can quickly zoom in and out of many screens, such as the charts and sonar views.

- Pinch two fingers together to zoom out.
- Spread two fingers apart to zoom in.

### Chart Symbols

This table contains some of the common symbols you might see on the detailed charts.

Icon	Description
	Buoy
	Information
	Marine services
	Tide station
	Current station
	Overhead photo available
	Perspective photo available

Other features common to most charts include depth contour lines, intertidal zones, spot soundings (as depicted on the original paper chart), navigational aids and symbols, obstructions, and cable areas.

### Measuring a Distance on the Chart

- 1 From a chart, select a location.
- 2 Select **Measure**.

A push pin appears on the screen at your present location. The distance and angle from the pin is listed in the corner.

**TIP:** To reset the pin and measure from the current location of the cursor, select **Set Reference**.

### Creating a Waypoint on the Chart

- 1 From a chart, select a location or object.
- 2 Select .

### Viewing Location and Object Information on a Chart

You can view information, such as tide, current, celestial, chart notes, or local services, about a location or an object on the Navigation chart or the Fishing chart.

- 1 From the Navigation chart or Fishing chart, select a location or object.

A list of options appears along the top of the chart. The options that appear vary based on the location or object you selected.

- 2 If necessary, select .

### 3 Select Information.

#### Viewing Details about Nav aids

From the Navigation chart, Fishing chart, Perspective 3D chart view, or Mariner's Eye 3D chart view, you can view details about various types of navigation aids, including beacons, lights, and obstructions.

**NOTE:** The Fishing chart is available with premium charts, in some areas.

**NOTE:** 3D chart views are available with premium charts, in some areas.

- 1 From a chart or 3D chart view, select a navaid.
- 2 Select the name of the navaid.

#### Navigating to a Point on the Chart

##### WARNING



All route and navigation lines displayed on the chartplotter are only intended to provide general route guidance or to identify proper channels, and are not intended to be precisely followed. Always defer to the nav aids and conditions on the water when navigating to avoid groundings or hazards that could result in vessel damage, personal injury, or death.

The Auto Guidance feature is based on electronic chart information. That data does not ensure obstacle and bottom clearance. Carefully compare the course to all visual sightings, and avoid any land, shallow water, or other obstacles that may be in your path.

When using Go To, a direct course and a corrected course may pass over land or shallow water. Use visual sightings, and steer to avoid land, shallow water, and other dangerous objects.

**NOTE:** The Fishing chart is available with premium charts, in some areas.

**NOTE:** Auto Guidance is available with premium charts, in some areas.

- 1 From the Navigation chart or Fishing chart, select a location.
- 2 If necessary, select **Navigate To**.
- 3 Select an option:
  - To navigate directly to the location, select **Go To** or .
  - To create a route to the location, including turns, select **Route To** or .
  - To use Auto Guidance, select **Auto Guidance** or .
- 4 Review the course indicated by the magenta line.

**NOTE:** When using Auto Guidance, a gray segment within any part of the magenta line indicates that Auto Guidance cannot calculate part of the Auto Guidance line. This is due to the settings for minimum safe water depth and minimum safe obstacle height.

- 5 Follow the magenta line, steering to avoid land, shallow water, and other obstacles.

#### Premium Charts

##### WARNING

All route and navigation lines displayed on the chartplotter are only intended to provide general route guidance or to identify proper channels, and are not intended to be precisely followed. Always defer to the nav aids and conditions on the water when navigating to avoid groundings or hazards that could result in vessel damage, personal injury, or death.

The Auto Guidance feature is based on electronic chart information. That data does not ensure obstacle and bottom clearance. Carefully compare the course to all visual sightings, and avoid any land, shallow water, or other obstacles that may be in your path.

**NOTE:** Not all models support all charts.

Optional premium charts, such as BlueChart® g3 Vision, allow you to get the most out of your chartplotter. In addition to detailed marine charting, premium charts may contain these features, which are available in some areas.

**Mariner's Eye 3D:** Provides a view from above and behind the boat for a three-dimensional navigation aid.

**Fish Eye 3D:** Provides an underwater, three-dimensional view that visually represents the sea floor according to the information on the chart.

**Fishing Charts:** Shows the chart with enhanced bottom contours and without navigational data. This chart works well for offshore deep-sea fishing.

**High Resolution Satellite Imagery:** Provides high-resolution satellite images for a realistic view of the land and water on the Navigation chart ([Showing Satellite Imagery on the Navigation Chart](#), page 11).

**Aerial Photos:** Shows marinas and other navigationally significant aerial photos to help you visualize your surroundings ([Viewing Aerial Photos of Landmarks](#), page 11).

**Detailed Roads and POI data:** Shows detailed road and point of interest (POI) data, which includes highly detailed coastal roads and POIs such as restaurants, lodging, and local attractions.

**Auto Guidance:** Uses specified information about your vessel and chart data to determine the best path to your destination.

#### Fish Eye 3D Chart View

Using the depth contour lines of the premium charts, such as BlueChart g3 Vision, the Fish Eye 3D chart view provides an underwater view of the sea floor or lake bottom.

Suspended targets, such as fish, are indicated by red, green, and yellow spheres. Red indicates the largest targets and green indicates the smallest.

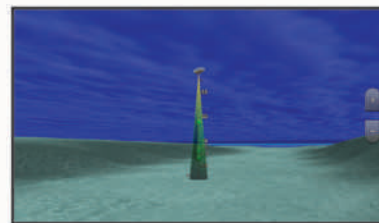

#### Viewing Tide Station Information

The  icon on the chart indicates a tide station. You can view a detailed graph for a tide station to help predict the tide level at different times or on different days.

**NOTE:** This feature is available with premium charts, in some areas.

- 1 From the Navigation chart or Fishing chart, select a tide station.

Tide direction and tide level information appear near .

- 2 Select the station name.

#### Animated Tide and Current Indicators

**NOTE:** This feature is available with premium charts, in some areas.

You can view indicators for animated tide station and current direction on the Navigation chart or the Fishing chart. You must also enable animated icons in the chart settings ([Showing Tides and Current Indicators](#), page 11).

An indicator for a tide station appears on the chart as a vertical bar graph with an arrow. A red arrow pointing downward indicates a falling tide, and a blue arrow pointing upward indicates a rising tide. When you move the cursor over the tide

station indicator, the height of the tide at the station appears above the station indicator.

Current direction indicators appear as arrows on the chart. The direction of each arrow indicates the direction of the current at a specific location on the chart. The color of the current arrow indicates the range of speed for the current at that location. When you move the cursor over the current direction indicator, the specific current speed at the location appears above the direction indicator.

Color	Current Speed Range
Yellow	0 to 1 knot
Orange	1 to 2 knots
Red	2 or more knots

### Showing Tides and Current Indicators

**NOTE:** This feature is available with premium charts, in some areas.

You can show static or animated tide and current station indicators on the Navigation chart or Fishing chart.

- From the Navigation or Fishing chart, select **Menu > Layers > Chart > Tides & Currents**.
- Select an option:
  - To show animated tide station indicators and animated current direction indicators on the chart, select **Animated**.
  - To enable the tides and current slider, which sets the time for which tides and currents are reported on the map, select **Slider**.

### Showing Satellite Imagery on the Navigation Chart

**NOTE:** This feature is available with premium charts, in some areas.

You can overlay high-resolution satellite images on the land or on both land and sea portions of the Navigation chart.

**NOTE:** When enabled, high-resolution satellite images are present only at lower zoom levels. If you cannot see high-resolution images in your optional chart region, you can select **+** to zoom in. You also can set the detail level higher by changing the map zoom detail.

- From the Navigation chart, select **Menu > Layers > Chart > Satellite Photos**.
- Select an option:
  - Select **Land Only** to show standard chart information on the water, with photos overlaying the land.



**NOTE:** This setting must be enabled to view Standard Mapping® charts.
  - Select **Photo Map** to show photos on both the water and the land at a specified opacity. Use the slider bar to adjust the photo opacity. The higher you set the percentage, the more the satellite photos cover both land and water.

### Viewing Aerial Photos of Landmarks

Before you can view aerial photos on the Navigation chart, you must turn on the Photo Points setting in the chart setup.

**NOTE:** This feature is available with premium charts, in some areas.

You can use aerial photographs of landmarks, marinas, and harbors to help orient yourself to your surroundings or to acquaint yourself with a marina or a harbor prior to arrival.

- From the Navigation chart, select a camera icon:
  - To view an overhead photo, select .
  - To view a perspective photo, select . The photo was taken from the location of the camera, pointed in the direction of the cone.
- Select **Photo**.







## Automatic Identification System

The Automatic Identification System (AIS) enables you to identify and track other vessels, and alerts you to area traffic. When connected to an external AIS device, the chartplotter can show some AIS information about other vessels that are within range, that are equipped with a transponder, and that are actively transmitting AIS information.

The information reported for each vessel includes the Maritime Mobile Service Identity (MMSI), location, GPS speed, GPS heading, time that has elapsed since the last position of the vessel was reported, nearest approach, and time to the nearest approach.

Some chartplotter models also support Blue Force Tracking. Vessels being tracked with Blue Force Tracking are indicated on the chartplotter with a blue-green color.

### AIS Targeting Symbols

Symbol	Description
	AIS vessel. The vessel is reporting AIS information. The direction in which the triangle is pointing indicates the direction in which the AIS vessel is moving.
	Target is selected.
	Target is activated. The target appears larger on the chart. A green line attached to the target indicates the heading of the target. The MMSI, speed, and direction of the vessel appear beneath the target, if the details setting has been set to Show. If the AIS transmission from the vessel is lost, a message banner appears.
	Target is lost. A green X indicates that the AIS transmission from the vessel is lost, and the chartplotter displays a message banner asking whether the vessel should continue to be tracked. If you discontinue vessel tracking, the lost target symbol disappears from the chart or the 3D chart view.
	Dangerous target in range. The target flashes while an alarm sounds and a message banner appears. After the alarm has been acknowledged, a solid red triangle with a red line attached to it indicates the location and the heading of the target. If the safe-zone collision alarm has been set to Off, the target flashes, but the audible alarm does not sound and the alarm banner does not appear. If the AIS transmission from the vessel is lost, a message banner appears.
	Dangerous target is lost. A red X indicates that the AIS transmission from the vessel is lost, and the chartplotter displays a message banner asking whether the vessel should continue to be tracked. If you discontinue vessel tracking, the lost dangerous target symbol disappears from the chart or the 3D chart view.
	The location of this symbol indicates the closest point of approach to a dangerous target, and the numbers near the symbol indicate the time to the closest point of approach to that target.

**NOTE:** Vessels being tracked with the Blue Force Tracking feature are indicated with a blue-green color regardless of their status.

### Heading and Projected Course of Activated AIS Targets

When heading and course over ground information are provided by an activated AIS target, the heading of the target appears on a chart as a solid line attached to the AIS target symbol. A heading line does not appear on a 3D chart view.

The projected course of an activated AIS target appears as a dashed line on a chart or a 3D chart view. The length of the projected course line is based on the value of the projected heading setting. If an activated AIS target is not transmitting speed information, or if the vessel is not moving, a projected course line does not appear. Changes in the speed, course over ground, or rate of turn information transmitted by the vessel can impact the calculation of the projected course line.

When course over ground, heading, and rate of turn information are provided by an activated AIS target, the projected course of the target is calculated based on the course over ground and the rate of turn information. The direction in which the target is turning, which is also based on the rate of turn information, is indicated by the direction of the barb at the end of the heading line. The length of the barb does not change.



When course over ground and heading information are provided by an activated AIS target, but rate of turn information is not provided, the projected course of the target is calculated based on the course over ground information.

### Activating a Target for an AIS Vessel

- 1 From a chart or a 3D chart view, select an AIS vessel.
- 2 Select **AIS Vessel > Activate Target**.

### Viewing Information about a Targeted AIS Vessel

You can view the AIS signal status, MMSI, GPS speed, GPS heading, and other information that is reported about a targeted AIS vessel.

- 1 From a chart or a 3D chart view, select an AIS vessel.
- 2 Select **AIS Vessel**.

### Deactivating a Target for an AIS Vessel

- 1 From a chart or a 3D chart view, select an AIS vessel.
- 2 Select **AIS Vessel > Deactivate**.

### Viewing a List of AIS and MARPA Threats

- 1 From a chart, select **Menu > Layers > Other Vessels > List > Show**.
- 2 Select the type of threats to include in the list.

### Setting the Safe-Zone Collision Alarm

Before you can set a collision alarm, you must have a compatible chartplotter connected to an AIS device or radar.

The safe-zone collision alarm is used only with AIS and MARPA. MARPA functionality works with radar. The safe zone is used for collision avoidance and can be customized.

- 1 Select **Settings > Alarms > Collision Alarm > On**.  
A message banner appears and an alarm sounds when a MARPA-tagged object or an AIS-activated vessel enters the safe-zone area around your boat. The object is also labeled as dangerous on the screen. When the alarm is off, the message banner and audible alarm are disabled, but the object is still labeled as dangerous on the screen.
- 2 Select **Range**, and select a distance for the safe-zone radius around your vessel.
- 3 Select **Time To**, and select a time at which the alarm will sound if a target is determined to intersect the safe zone.  
For example, to be notified of a pending intersection 10 minutes before it will likely occur, set Time To to 10, and the alarm will sound 10 minutes before the vessel intersects the safe zone.
- 4 Select **MARPA Alarm**, and select an option for when the alarm sounds for MARPA-tagged objects.

### AIS Aids to Navigation

An AIS aid to navigation (ATON) is any kind of navigational aid that is transmitted over the AIS radio. ATONs are displayed on the charts and have identifying information, such as position and type.

There are three main kinds of AIS ATONs. Real ATONs physically exist and send their identifying and location information from their actual location. Synthetic ATONs physically exist, and their identifying and location information is

sent from another location. Virtual ATONs do not actually exist, and their identifying and location information is sent from another location.

You can view AIS ATONs on the chart when the chartplotter is connected to a compatible AIS radio. To show AIS ATONs, from a chart, select **Menu > Layers > Chart > Navaid > ATONs**. You can view more information about an ATON if you select the ATON on the chart.

Symbol	Meaning
◇	Real or synthetic ATON
⬆	Real or synthetic ATON: Topmark North
⬇	Real or synthetic ATON: Topmark South
⬇	Real or synthetic ATON: Topmark East
⬆	Real or synthetic ATON: Topmark West
◇	Real or synthetic ATON: Topmark Special
◇	Real or synthetic ATON: Topmark Safe
⋮	Real or synthetic ATON: Topmark Danger
◇	Virtual ATON
⬆	Virtual ATON: Topmark North
⬇	Virtual ATON: Topmark South
⬇	Virtual ATON: Topmark East
⬆	Virtual ATON: Topmark West
◇	Virtual ATON: Topmark Special
◇	Virtual ATON: Topmark Safe
⋮	Virtual ATON: Topmark Danger

### AIS Distress Signals

Self-contained AIS distress signal devices transmit emergency position reports when activated. The chartplotter can receive signals from Search and Rescue Transmitters (SART), Emergency Position Indicating Radio Beacons (EPIRB), and other man overboard signals. Distress signal transmissions are different than standard AIS transmissions, so they appear differently on the chartplotter. Instead of tracking a distress signal transmission for collision avoidance, you track a distress signal transmission to locate and assist a vessel or person.

### Navigating to a Distress Signal Transmission

When you receive a distress signal transmission, a distress signal alarm appears.

Select **Review > Go To** to begin navigation to the transmission.

### AIS Distress Signal Device Targeting Symbols

Symbol	Description
⊗	AIS distress signal device transmission. Select to see more information about the transmission and begin navigation.
⊗	Transmission lost.
⊗	Transmission test. Appears when a vessel initiates a test of their distress signal device, and does not represent a true emergency.
⊗	Transmission test lost.

### Enabling AIS Transmission Test Alerts

To avoid a large number of test alerts and symbols in crowded areas such as marinas, you can select to receive or ignore AIS test messages. To test an AIS emergency device, you must enable the chartplotter to receive test alerts.

- 1 Select **Settings > Alarms > AIS**.

2 Select an option:

- To receive or ignore Emergency Position Indicating Radio Beacon (EPRIB) test signals, select **AIS-EPRIB Test**.
- To receive or ignore Man Overboard (MOB) test signals, select **AIS-MOB Test**.
- To receive or ignore Search and Rescue Transponder (SART) test signals, select **AIS-SART Test**.

## Turning Off AIS Reception

AIS signal reception is turned on by default.

Select **Settings > Other Vessels > AIS > Off**.

All AIS functionality on all charts and 3D chart views is disabled. This includes AIS vessel targeting and tracking, collision alarms that result from AIS vessel targeting and tracking, and the display of information about AIS vessels.

## Chart Menu

**NOTE:** Not all settings apply to all charts. Some options require premium maps or connected accessories, such as radar.

**NOTE:** The menus may contain some settings that are not supported by your installed charts or your present location. If you make changes to those settings, the changes will not impact the chart view.

From a chart, select Menu.

**Layers:** Adjusts the appearance of the different items on the charts ([Chart Layers, page 13](#)).

**Quickdraw Contours:** Turns on bottom contour drawing, and allows you to create fishing map labels ([Garmin Quickdraw Contours Mapping, page 15](#)).

**Settings:** Adjusts the chart settings ([Chart Settings, page 15](#)).

**Edit Overlays:** Adjusts the data shown on the screen ([Customizing the Data Overlays, page 5](#)).

## Chart Layers

You can turn on and off chart layers and customize features of the charts. Each setting is specific to the chart or chart view being used.

**NOTE:** Not all settings apply to all charts and chartplotter models. Some options require premium maps or connected accessories.

**NOTE:** The menus may contain some settings that are not supported by your installed charts or your present location. If you make changes to those settings, the changes will not impact the chart view.

From a chart, select **Menu > Layers**.

**Chart:** Shows and hides chart-related items ([Chart Layer Settings, page 13](#)).

**My Vessel:** Shows and hides items relating to the boat ([My Vessel Layer Settings, page 13](#)).

**User Data:** Shows and hides user data, such as waypoints, boundaries, and tracks, and opens user data lists ([User Data Layer Settings, page 14](#)).

**Other Vessels:** Adjusts how other vessels are shown ([Other Vessels Layer Settings, page 14](#)).

**Water:** Shows and hides depth items ([Water Layer Settings, page 14](#)).

**Quickdraw Contours:** Shows and hides Garmin Quickdraw Contours data ([Garmin Quickdraw Contours Settings, page 16](#)).

**Weather:** Shows and hides weather-related items ([Weather Layer Settings, page 14](#)).

## Chart Layer Settings

From a chart, select **Menu > Layers > Chart**.

**Satellite Photos:** Shows high-resolution satellite images on the land or on both land and sea portions of the Navigation chart, when certain premium maps are used ([Showing Satellite Imagery on the Navigation Chart, page 11](#)).

**NOTE:** This setting must be enabled to view Standard Mapping charts.

**Tides & Currents:** Shows current station indicators and tide station indicators on the chart ([Showing Tides and Current Indicators, page 11](#)) and enables the tides and current slider, which sets the time for which tides and currents are reported on the map.

**Land POIs:** Shows points of interest on land.

**Navaid:** Shows navigational aids, such as ATONs and flashing lights, on the chart. Allows you to select NOAA or IALA navaid type.

**Service Points:** Shows locations for marine services.

**Depth:** Adjusts the items on the depth layer ([Depth Layer Settings, page 13](#)).

**Restricted Areas:** Shows information about restricted areas on the chart.

**Photo Points:** Shows camera icons for aerial photos ([Viewing Aerial Photos of Landmarks, page 11](#)).

## Depth Layer Settings

From a chart, select **Menu > Layers > Chart > Depth**.

**Depth Shading:** Specifies an upper and lower depth to shade between.

**Shallow Shading:** Sets the shades from the shoreline to the specified depth.

**Spot Depths:** Turns on spot soundings and sets a dangerous depth. Spot depths that are equal to or more shallow than the dangerous depth are indicated by red text.

**Fishing Contours:** Sets the zoom level for a detailed view of bottom contours and depth soundings and simplifies map presentation for optimal use while fishing.

## My Vessel Layer Settings

From a chart, select **Menu > Layers > My Vessel**.

**Heading Line:** Shows and adjusts the heading line, which is a line drawn on the map from the bow of the boat in the direction of travel ([Setting the Heading Line and Angle Markers, page 25](#)).

**Active Tracks:** Shows the active track on the chart and opens the Active Track Options menu.

**Wind Rose:** Shows a visual representation of the wind angle or direction provided by the connected wind sensor and sets the wind source.

**Compass Rose:** Shows a compass rose around your boat, indicating compass direction oriented to the heading of the boat. Enabling this option disables the Wind Rose option.

**Vessel Icon:** Sets the icon that represents your present location on the chart.

## Laylines Settings

To use the laylines features, you must connect a wind sensor to the chartplotter.

When in sailing mode ([Setting the Vessel Type, page 5](#)), you can display laylines on the navigation chart. Laylines can be very helpful when racing.

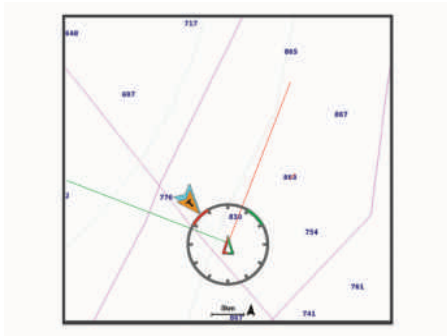

From the navigation chart, select **Menu > Layers > My Vessel > Laylines > Setup**.

**Display:** Sets how the laylines and vessel appear on the chart, and sets the length of the laylines.

**Sailing Ang.:** Allows you to select how the device calculates laylines. The Actual option calculates the laylines using the measured wind angle from the wind sensor. The Manual option calculates the laylines using manually entered windward and leeward angles.

**Windward Ang.:** Allows you to set a layline based on the windward sailing angle.

**Leeward Ang.:** Allows you to set a layline based on the leeward sailing angle.

**Tide Correction:** Corrects the laylines based on the tide.

**Layline Filter:** Filters the layline data based on the time interval entered. For a smoother layline that filters out some of the changes in the boat's heading or true wind angle, enter a higher number. For laylines that display a higher sensitivity to changes in the boat's heading or true wind angle, enter a lower number.

### User Data Layer Settings

You can show user data, such as waypoints, boundaries, and tracks, on the charts.

From a chart, select **Menu > Layers > User Data**.

**Waypoints:** Shows waypoints on the chart and opens the list of waypoints.

**Boundaries:** Shows boundaries on the chart and opens the list of boundaries.

**Tracks:** Shows tracks on the chart.

### Other Vessels Layer Settings

**NOTE:** These options require connected accessories, such as an AIS receiver, radar, or VHF radio.

From a chart, select **Menu > Layers > Other Vessels**.

**DSC:** Sets how DSC vessels and trails appear on the chart, and shows the DSC list.

**AIS:** Sets how AIS vessels and trails appear on the chart, and shows the AIS list.

**MARPA:** Sets how MARPA vessels and trails appear on the chart, and shows the MARPA list.

**Details:** Shows other vessel details on the chart.

**Proj. Heading:** Sets the projected heading time for AIS-activated and MARPA-tagged vessels.

**Collision Alarm:** Sets the safe-zone collision alarm ([Setting the Safe-Zone Collision Alarm, page 12](#)).

### Water Layer Settings

From a chart, select **Menu > Layers > Water**.

**NOTE:** The menu may contain some settings that are not supported by your installed charts or your present location. If you make changes to those settings, the changes will not impact the chart view.

**NOTE:** Not all settings apply to all charts, views, and chartplotter models. Some options require premium maps or connected accessories.

**Depth Shading:** Specifies an upper and lower depth to shade between.

**Shallow Shading:** Sets the shades from the shoreline to the specified depth.

**Spot Depths:** Turns on spot soundings and sets a dangerous depth. Spot depths that are equal to or more shallow than the dangerous depth are indicated by red text.

**Fishing Contours:** Sets the zoom level for a detailed view of bottom contours and depth soundings and simplifies map presentation for optimal use while fishing.

**Relief Shading:** Shows the gradient of the bottom with shading. This feature is available only with some premium maps.

**Sonar Imagery:** Shows sonar imagery to help show the density of the bottom. This feature is available only with some premium maps.

**Lake Level:** Sets the present water level of the lake. This feature is available only with some premium maps.

### Depth Range Shading

You can set color ranges on your map to show the water depths where your target fish are currently biting. You can set deeper ranges to monitor how quickly the bottom depth changes within a specific depth range. You can create up to ten depth ranges. For inland fishing, a maximum of five depth ranges can help reduce map clutter. The depth ranges apply to all charts and all bodies of water.

Some Garmin LakeVü™ and premium supplemental charts have multiple depth range shading by default.

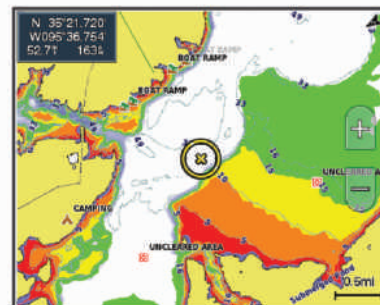

Red	From 0 to 1.5 m (from 0 to 5 ft.)
Orange	From 1.5 to 3 m (from 5 to 10 ft.)
Yellow	From 3 to 4.5 m (from 10 to 15 ft.)
Green	From 4.5 to 7.6 m (from 15 to 25 ft.)

### Weather Layer Settings

From the Navigation or Fishing chart, select **Menu > Layers > Chart > Weather > ☁**.

From a weather chart, select **Menu > Layers > Chart > Weather**.

**Observed Layers:** Sets which observed weather items are shown. Observed weather is the present weather condition that are visible now.

**Forecast Layers:** Sets which forecasted weather items are shown.

**Layer Mode:** Shows forecasted or observed weather information.

**Loop:** Shows a loop of forecasted or observed weather information.

**Legend:** Shows the weather legend, with the severity of the conditions increasing from left to right.

**Weather Subscription:** Shows weather subscription information.

**Restore Defaults:** Resets the weather settings to factory default values.

**Edit Overlays:** Adjusts the data shown on the screen (*Customizing the Data Overlays, page 5*).

### Radar Overlay Settings

From the Navigation or Fishing chart, select **Menu > Layers > Radar >** .

From a radar screen, select **Menu**.

**Radar To Standby:** Stops radar transmission.

**Gain:** Adjusts the gain (*Adjusting Gain on the Radar Screen Automatically, page 37*).

**Sea Clutter:** Adjusts the sea clutter (*Adjusting Gain on the Radar Screen Automatically, page 37*).

**Radar Options:** Opens the radar options menu (*Radar Options Menu, page 38*).

**Other Vessels:** Sets how other vessels are displayed on the radar view (*Other Vessels Layer Settings, page 14*).

**Radar Setup:** Opens the radar display settings (*Radar Setup Menu, page 39*).

**Edit Overlays:** Adjusts the data shown on the screen (*Customizing the Data Overlays, page 5*).

### Chart Settings

**NOTE:** Not all settings apply to all charts and 3D chart views. Some settings require external accessories or applicable premium charts.

From a chart, select **Menu > Settings**.

**Orientation:** Sets the perspective of the map.

**Detail:** Adjusts the amount of detail shown on the map, at different zoom levels.

**Chart Size:** Sets the visible size of the chart.

**World Map:** Uses either a basic world map or a shaded relief map on the chart. These differences are visible only when zoomed out too far to see the detailed charts.

**Start Line:** Sets the starting line for the sailing race (*Setting the Starting Line, page 23*).

**Inset Map:** Shows a small map centered on your present location.

### Fish Eye 3D Settings

**NOTE:** This feature is available with premium charts, in some areas.

From the Fish Eye 3D chart view, select **Menu**.

**View:** Sets the perspective of the 3D chart view.

**Tracks:** Shows tracks.

**Sonar Cone:** Shows a cone that indicates the area covered by the transducer.

**Fish Symbols:** Shows suspended targets.

## Supported Maps

To help you have a safe and enjoyable time on the water, Garmin devices only support official maps produced by Garmin or an approved third party producer.

You can purchase maps from Garmin. If you purchase maps from a seller other than Garmin, investigate the seller before purchasing. Be extra cautious with online sellers. If you have purchased an unsupported map, return it to the seller.

## Garmin Quickdraw Contours Mapping

### WARNING

The Garmin Quickdraw Contours mapping feature allows users to generate maps. Garmin makes no representations about the

accuracy, reliability, completeness or timeliness of the maps generated by third parties. Any use or reliance on the maps generated by third parties is at your own risk.

The Garmin Quickdraw Contours mapping feature allows you to instantly create maps with contours and depth labels for any body of water.

When Garmin Quickdraw Contours records data, a colored circle surrounds the vessel icon. This circle represents the approximate area of the map that is scanned by each pass.



A green circle indicates good depth and GPS position, and a speed under 16 km/h (10 mph). A yellow circle indicates good depth and GPS position, and a speed between 16 and 32 km/h (10 and 20 mph). A red circle indicates poor depth or GPS position, and a speed above 32 km/h (20 mph).

You can view Garmin Quickdraw Contours in a combination screen or as a single view on the map.

The amount of saved data depends on the size of your memory card, your sonar source, and the speed of your boat as you record data. You can record longer when you use a single-beam sonar. It is estimated that you might be able to record about 1,500 hours of data onto a 2 GB memory card.

When you record data on a memory card in your chartplotter, the new data is added to your existing Garmin Quickdraw Contours map, and is saved on the memory card. When you insert a new memory card, the existing data does not transfer onto the new card.

## Mapping a Body of Water Using the Garmin Quickdraw Contours Feature

Before you can use the Garmin Quickdraw Contours feature, you must have sonar depth, your GPS position, and a memory card with free space.

- 1 From a chart view, select **Menu > Quickdraw Contours > Start Recording**.
- 2 When recording is complete, select **Menu > Quickdraw Contours > Stop Recording**.
- 3 Select **Manage > Name**, and enter a name for the map.

## Adding a Label to a Garmin Quickdraw Contours Map

You can add labels to a Garmin Quickdraw Contours map to mark hazards or points of interest.

- 1 From the Navigation chart, select a location.
- 2 Select **Quickdraw Lbl.**
- 3 Enter text for the label, and select **Done**.

## Garmin Quickdraw Community

The Garmin Quickdraw Community is a free, public, online community that enables you to share your Garmin Quickdraw Contours maps with others. You can also download maps other users have created.

If your device has Wi-Fi technology, you can use the ActiveCaptain app to access the Garmin Quickdraw Community (*Connecting to the Garmin Quickdraw Community with ActiveCaptain, page 16*).

If your device does not have Wi-Fi technology, you can use the Garmin Connect™ website to access the Garmin Quickdraw Community ([Connecting to the Garmin Quickdraw Community with Garmin Connect](#), page 16).

## Connecting to the Garmin Quickdraw Community with ActiveCaptain

- 1 From your mobile device, open the ActiveCaptain app and connect to the GPSMAP device ([Getting Started with the ActiveCaptain App](#), page 6).
- 2 From the app, select **Quickdraw Community**.

You can download contours from others in the community ([Downloading Garmin Quickdraw Community Maps Using ActiveCaptain](#), page 16) and share the contours you have created ([Sharing Your Garmin Quickdraw Contours Maps with the Garmin Quickdraw Community Using ActiveCaptain](#), page 16).

## Downloading Garmin Quickdraw Community Maps Using ActiveCaptain

You can download Garmin Quickdraw Contours maps that other users have created and shared with the Garmin Quickdraw Community.

- 1 From the ActiveCaptain app on your mobile device, select **Quickdraw Community > Search for Contours**.
- 2 Use the map and search features to locate an area to download.  
The red dots represent Garmin Quickdraw Contours maps that have been shared for that area.
- 3 Select **Select Download Region**.
- 4 Drag the box to select the area to download.
- 5 Drag the corners to change the download area.
- 6 Select **Download Area**.

The next time you connect the ActiveCaptain app to the GPSMAP device, the downloaded contours are transferred to the device automatically.

## Sharing Your Garmin Quickdraw Contours Maps with the Garmin Quickdraw Community Using ActiveCaptain

You can share Garmin Quickdraw Contours maps that you have created with others in the Garmin Quickdraw Community.

When you share a contour map, only the contour map is shared. Your waypoints are not shared.

When you set up your ActiveCaptain app, you may have selected to share your contours with the community automatically. If not, follow these steps to enable sharing.

From the ActiveCaptain app on your mobile device, select **Sync with Plotter > Contribute to Community**.

The next time you connect the ActiveCaptain app to the GPSMAP device, your contour maps are transferred to the community automatically.

## Connecting to the Garmin Quickdraw Community with Garmin Connect

- 1 Go to [connect.garmin.com](http://connect.garmin.com).
- 2 Select **Getting Started > Quickdraw Community > Getting Started**.
- 3 If you do not have a Garmin Connect account, create one.
- 4 Sign in to your Garmin Connect account.
- 5 Select **Marine** in the upper-right to open the Garmin Quickdraw widget.

**TIP:** Make sure you have a memory card in your computer to share Garmin Quickdraw Contours maps.

## Sharing Your Garmin Quickdraw Contours Maps with the Garmin Quickdraw Community Using Garmin Connect

You can share Garmin Quickdraw Contours maps that you have created with others in the Garmin Quickdraw Community.

When you share a contour map, only the contour map is shared. Your waypoints are not shared.

- 1 Insert a memory card into the card slot ([Memory Cards](#), page 2).
- 2 Insert the memory card into your computer.
- 3 Access the Garmin Quickdraw Community ([Connecting to the Garmin Quickdraw Community with Garmin Connect](#), page 16).
- 4 Select **Share Your Contours**.
- 5 Browse to your memory card, and select the /Garmin folder.
- 6 Open the Quickdraw folder, and select the file named ContoursLog.svy.

After the file is uploaded, delete the ContoursLog.svy file from your memory card to avoid issues with future uploads. Your data will not be lost.

## Downloading Garmin Quickdraw Community Maps Using Garmin Connect

You can download Garmin Quickdraw Contours maps that other users have created and shared with the Garmin Quickdraw Community.

If your device does not have Wi-Fi technology, you can access the Garmin Quickdraw Community using the Garmin Connect website.

If your device has Wi-Fi technology, you should access the Garmin Quickdraw Community using the ActiveCaptain app ([Connecting to the Garmin Quickdraw Community with ActiveCaptain](#), page 16).

- 1 Insert the memory card into your computer.
- 2 Access the Garmin Quickdraw Community ([Connecting to the Garmin Quickdraw Community with Garmin Connect](#), page 16).
- 3 Select **Search for Contours**.
- 4 Use the map and search features to locate an area to download.  
The red dots represent Garmin Quickdraw Contours maps that have been shared for that region.
- 5 Select **Select an Area to Download**.
- 6 Drag the edges of the box to select the area to download.
- 7 Select **Start Download**.
- 8 Save the file to your memory card.  
**TIP:** If you cannot find the file, look in the "Downloads" folder. The browser may have saved the file there.
- 9 Remove the memory card from your computer.
- 10 Insert the memory card into the card slot ([Memory Cards](#), page 2).

The chartplotter automatically recognizes the contours maps. The chartplotter may take a few minutes to load the maps.

## Garmin Quickdraw Contours Settings

From a chart, select **Menu > Quickdraw Contours > Settings**.

**Recording Offset:** Sets the distance between the sonar depth and the contour recording depth. If the water level has changed since your last recording, adjust this setting so the recording depth is the same for both recordings.

For example, if the last time you recorded had a sonar depth of 3.1 m (10.5 ft.), and today's sonar depth is 3.6 m (12 ft.), enter -0.5 m (-1.5 ft.) for the a Recording Offset value.

**User Display Offset:** Sets differences in contour depths and depth labels on your own contours maps to compensate for



changes in the water level of a body of water, or for depth errors in recorded maps.

**Comm. Display Offset:** Sets differences in contour depths and depth labels on the community contours maps to compensate for changes in the water level of a body of water, or for depth errors in recorded maps.

**Survey Coloring:** Sets the color of the Garmin Quickdraw Contours display. When this setting is turned on, the colors indicate the quality of the recording. When this setting is turned off, the contour areas use standard map colors.

Green indicates good depth and GPS position, and a speed under 16 km/h (10 mph). Yellow indicates good depth and GPS position, and a speed between 16 and 32 km/h (10 and 20 mph). Red indicates poor depth or GPS position, and a speed above 32 km/h (20 mph).

**Depth Shading:** Specifies the minimum and maximum depths of a depth range and a color for that depth range.

## Navigation with a Chartplotter

### ⚠ WARNING

All route and navigation lines displayed on the chartplotter are only intended to provide general route guidance or to identify proper channels, and are not intended to be precisely followed. Always defer to the nav aids and conditions on the water when navigating to avoid groundings or hazards that could result in vessel damage, personal injury, or death.

The Auto Guidance feature is based on electronic chart information. That data does not ensure obstacle and bottom clearance. Carefully compare the course to all visual sightings, and avoid any land, shallow water, or other obstacles that may be in your path.

When using Go To, a direct course and a corrected course may pass over land or shallow water. Use visual sightings, and steer to avoid land, shallow water, and other dangerous objects.

### ⚠ CAUTION

If your vessel has an autopilot system, a dedicated autopilot control display must be installed at each steering helm in order to disable the autopilot system.

**NOTE:** Some chart views are available with premium charts, in some areas.

To navigate, you must choose a destination, set a course or create a route, and follow the course or route. You can follow the course or the route on the Navigation chart, Fishing chart, Perspective 3D chart view, or Mariner's Eye 3D chart view.

You can set and follow a course to a destination using one of three methods: Go To, Route To, or Auto Guidance.

**Go To:** Takes you directly to the destination. This is the standard option for navigating to a destination. The chartplotter creates a straight-line course or navigation line to the destination. The path may run over land and other obstacles.

**Route To:** Creates a route from your location to a destination, allowing you to add turns along the way. This option provides a straight-line course to the destination, but allows you to add turns into the route to avoid land and other obstacles.

**Auto Guidance:** Uses the specified information about your vessel and chart data to determine the best path to your destination. This option is available only when using a compatible premium chart in a compatible chartplotter. It provides a turn-by-turn navigation path to the destination, avoiding land and other obstacles ([Auto Guidance](#), page 20).

When you are using a compatible autopilot connected to the chartplotter using NMEA 2000, the autopilot follows the Auto Guidance route.

**NOTE:** Auto Guidance is available with premium charts, in some areas.

## Basic Navigation Questions

Question	Answer
How do I make the chartplotter point me in the direction in which I want to go (bearing)?	Navigate using Go To ( <a href="#">Setting and Following a Direct Course Using Go To</a> , page 18).
How do I make the device guide me along a straight line (minimizing cross track) to a location using the shortest distance from the present location?	Build a single-leg route and navigate it using Route To ( <a href="#">Creating and Navigating a Route From Your Present Location</a> , page 19).
How do I make the device guide me to a location while avoiding charted obstacles?	Build a multi-leg route and navigate it using Route To ( <a href="#">Creating and Navigating a Route From Your Present Location</a> , page 19).
How do I make the device steer my automatic pilot?	Navigate using Route To ( <a href="#">Creating and Navigating a Route From Your Present Location</a> , page 19).
Can the device create a path for me?	If you have premium maps that support Auto Guidance and are in an area covered by Auto Guidance, navigate using Auto Guidance ( <a href="#">Setting and Following an Auto Guidance Path</a> , page 20).
How do I change the Auto Guidance settings for my boat?	See <a href="#">Auto Guidance Path Configurations</a> , page 20.

## Destinations

You can select destinations using various charts and 3D chart views or using the lists.

### Searching for a Destination by Name

You can search for saved waypoints, saved routes, saved tracks, and marine services destinations by name.

- 1 Select **Info > Services > Search by Name**.
- 2 Enter at least a portion of the name of your destination.
- 3 If necessary, select **Done**.  
The 50 nearest destinations that contain your search criteria appear.
- 4 Select the destination.

### Selecting a Destination Using the Navigation Chart

From the Navigation chart, select a destination.

### Searching for a Marine Services Destination

**NOTE:** This feature is available with premium charts, in some areas.

The chartplotter contains information for thousands of destinations offering marine services.

- 1 Select **Info > Services**.
- 2 Select **Offshore Services** or **Inland Services**.
- 3 If necessary, select the marine service category.  
The chartplotter shows a list of the nearest locations and the distance and bearing to each.
- 4 Select a destination.

You can select Next Page or Previous Page to view additional information or to show the location on a chart.

## Setting and Following a Direct Course Using Go To

### WARNING

When using Go To, a direct course and a corrected course may pass over land or shallow water. Use visual sightings, and steer to avoid land, shallow water, and other dangerous objects.

You can set and follow a direct course from your current location to a selected destination.

- 1 Select a destination (*Destinations*, page 17).
- 2 Select **Navigate To > Go To**.

A magenta line appears. In the center of the magenta line is a thinner purple line that represents the corrected course from your current location to the destination. The corrected course is dynamic, and it moves with your boat when you are off course.

- 3 Follow the magenta line, steering to avoid land, shallow water, and other obstacles.
- 4 If you are off course, follow the purple line (corrected course) to go to your destination, or steer back to the magenta line (direct course).

You can also use the orange course-to-steer arrow, which shows a proposed turning radius to return your boat to the course.

### WARNING

Review the path for obstacles before negotiating the turn. If the path is unsafe, reduce your boat speed and determine a safe path back to the course.

## Stopping Navigation

While navigating, from an applicable chart, select an option:

- Select **Menu > Stop Navigation**.
- When navigating with Auto Guidance, select **Menu > Navigation Options > Stop Navigation**.
- Select .

## Waypoints

Waypoints are locations you record and store in the device. Waypoints can mark where you are, where you are going, or where you have been. You can add details about the location, such as name, elevation, and depth.

### Marking Your Present Location as a Waypoint

From any screen, select **Mark**.

### Creating a Waypoint at a Different Location

- 1 Select **Waypoints > New Waypoint**.
- 2 Select an option:
  - To create the waypoint by entering position coordinates, select **Enter Coordinates**, and enter the coordinates.
  - To create the waypoint using a chart, select **Use Chart**, select the location, and select **Select**.
  - To create the waypoint using a range (distance) and bearing, select **Enter Range/Bearing**, and enter the information.

### Marking an SOS Location

You can mark an SOS or MOB (man overboard) location.

- 1 Hold **SOS** for one second.
- 2 Select the SOS type.
- 3 If necessary, select **OK** to navigate to the man overboard location.

If you selected OK, the chartplotter sets a direct course back to the location. If you selected another type of SOS, the call details are sent to the VHF radio. You must send the call using the radio.

## Projecting a Waypoint

You can create a new waypoint by projecting the distance and bearing from a different location. This can be helpful when creating sail racing start and finish lines.

- 1 Select **Waypoints > New Waypoint > Enter Range/Bearing**.
- 2 If necessary, select a reference point on the chart.
- 3 Select **Enter Range/Bearing**.
- 4 Enter the distance, and select **Done**.
- 5 Enter the bearing, and select **Done**.
- 6 Select **Create Waypoint**.

### Viewing a List of all Waypoints

Select **Info > User Data > Waypoints**.

### Editing a Saved Waypoint

- 1 Select **Info > User Data > Waypoints**.
- 2 Select a waypoint.
- 3 Select **Review > Edit**.
- 4 Select an option:
  - To add a name, select **Name**, and enter a name.
  - To change the symbol, select **Symbol**.
  - To change the depth, select **Depth**.
  - To change the water temperature, select **Water Temp..**
  - To change the comment, select **Comment**.
  - To move the position of the waypoint, select **Position**.

### Moving a Saved Waypoint

- 1 Select **Waypoints**.
- 2 Select a waypoint.
- 3 Select **Review > Move**.
- 4 Indicate a new location for the waypoint:
  - To move the waypoint while using the chart, select **Use Chart**, select a new location on the chart, and select **Move**.
  - To move the waypoint using coordinates, select **Enter Coordinates**, and enter the new coordinates.
  - To move the waypoint using a range (distance) and bearing, select **Enter Range/Bearing**, and enter the information.

### Browsing for and Navigating to a Saved Waypoint

#### WARNING

All route and navigation lines displayed on the chartplotter are only intended to provide general route guidance or to identify proper channels, and are not intended to be precisely followed. Always defer to the nav aids and conditions on the water when navigating to avoid groundings or hazards that could result in vessel damage, personal injury, or death.

The Auto Guidance feature is based on electronic chart information. That data does not ensure obstacle and bottom clearance. Carefully compare the course to all visual sightings, and avoid any land, shallow water, or other obstacles that may be in your path.

When using Go To, a direct course and a corrected course may pass over land or shallow water. Use visual sightings, and steer to avoid land, shallow water, and other dangerous objects.

**NOTE:** Auto Guidance is available with premium charts, in some areas.

Before you can navigate to a waypoint, you must create a waypoint.

- 1 Select **Info > User Data > Waypoints**.
- 2 Select a waypoint.

- 3 Select **Navigate To**.
- 4 Select an option:
  - To navigate directly to the location, select **Go To**.
  - To create a route to the location, including turns, select **Route To**.
  - To use Auto Guidance, select **Auto Guidance**.

- 5 Review the course indicated by the magenta line.

**NOTE:** When using Auto Guidance, a gray segment within any part of the magenta line indicates that Auto Guidance cannot calculate part of the Auto Guidance line. This is due to the settings for minimum safe water depth and minimum safe obstacle height.

- 6 Follow the magenta line, steering to avoid land, shallow water, and other obstacles.

### Deleting a Waypoint or an MOB

- 1 Select **Info > User Data > Waypoints**.
- 2 Select a waypoint or an MOB.
- 3 Select **Review > Delete**.

### Deleting All Waypoints

Select **Info > User Data > Delete User Data > Waypoints > All**.

## Routes

A route is a path from one location to one or more destinations.

### Creating and Navigating a Route From Your Present Location

You can create and immediately navigate a route on the Navigation chart or the Fishing chart. This method does not save the route.

- 1 From the Navigation chart or Fishing chart, select a destination.
- 2 Select **Navigate To > Route To**.
- 3 Select the location of the last turn before the destination.
- 4 Select **Add Turn**.
- 5 If necessary, repeat to add turns, working backward from the destination to the present location of your vessel.  
The last turn you add should be the first turn you make, starting from your present location. It should be the turn closest to your vessel.
- 6 If necessary, select **Menu**.
- 7 Select **Done**.
- 8 Review the course indicated by the magenta line.
- 9 Follow the magenta line, steering to avoid land, shallow water, and other obstacles.

### Creating and Saving a Route

You can add up to 250 turns to one route.

- 1 Select **Info > User Data > Routes & Auto Guidance Paths > New > Route Using Chart**.
- 2 Select the starting location of the route.  
The starting point can be your present location or another location.
- 3 Select **Add Turn**.
- 4 Select the location of the next turn on the chart.
- 5 Select **Add Turn**.
- 6 If necessary, repeat steps 4 and 5 to add more turns.
- 7 Select the final destination.

### Viewing a List of Routes and Auto Guidance Paths

- 1 Select **Info > User Data > Routes & Auto Guidance Paths**.

- 2 If necessary, select **Filter** to see routes only or Auto Guidance paths only.

### Editing a Saved Route

You can change the name of a route or change the turns the route contains.

- 1 Select **Info > User Data > Routes & Auto Guidance Paths**.
- 2 Select a route.
- 3 Select **Review > Edit Route**.
- 4 Select an option:
  - To change the name, select **Name**, and enter the name.
  - To edit a turn from a list, select **Edit Turns > Use Turn List**, and select a turn from the list.
  - To select a turn using the chart, select **Edit Turns > Use Chart**, and select a location on the chart.

Modifying a turn that uses a saved waypoint does not move that waypoint, it relocates the turn in the route. Moving the location of a waypoint used in a route does not move the turn in the route.

### Browsing for and Navigating a Saved Route

Before you can browse a list of routes and navigate to one of them, you must create and save at least one route.

- 1 Select **Info > User Data > Routes & Auto Guidance Paths**.
- 2 Select a route.
- 3 Select **Navigate To**.
- 4 Select an option:
  - To navigate the route from the starting point used when the route was created, select **Forward**.
  - To navigate the route from the destination point used when the route was created, select **Backward**.

A magenta line appears. In the center of the magenta line is a thinner purple line that represents the corrected course from your present location to the destination. The corrected course is dynamic, and it moves with your boat when you are off course.

- 5 Review the course indicated by the magenta line.
- 6 Follow the magenta line along each leg in the route, steering to avoid land, shallow water, and other obstacles.
- 7 If you are off course, follow the purple line (corrected course) to go to your destination, or steer back to the magenta line (direct course).

### Browsing for and Navigating Parallel to a Saved Route

Before you can browse a list of routes and navigate to one of them, you must create and save at least one route.

- 1 Select **Info > User Data > Routes & Auto Guidance Paths**.
- 2 Select a route.
- 3 Select **Navigate To**.
- 4 Select **Offset** to navigate parallel to the route, offset from it by a specific distance.
- 5 Indicate how to navigate the route:
  - To navigate the route from the starting point used when the route was created, to the left of the original route, select **Forward - Port**.
  - To navigate the route from the starting point used when the route was created, to the right of the original route, select **Forward - Starboard**.
  - To navigate the route from the destination point used when the route was created, to the left of the original route, select **Backward - Port**.

- To navigate the route from the destination point used when the route was created, to the right of the original route, select **Backward - Starboard**.

6 If necessary, select **Done**.

A magenta line appears. In the center of the magenta line is a thinner purple line that represents the corrected course from your present location to the destination. The corrected course is dynamic, and it moves with your boat when you are off course.

7 Review the course indicated by the magenta line.

8 Follow the magenta line along each leg in the route, steering to avoid land, shallow water, and other obstacles.

9 If you are off course, follow the purple line (corrected course) to go to your destination, or steer back to the magenta line (direct course).

### Initiating a Search Pattern

You can initiate a search pattern to search an area. Different patterns are better suited for different search situations.

1 Select **Info > User Data > Routes & Auto Guidance Paths > New > Route Using SAR Pattern**.

2 Select a pattern:

- Select **Sector Search** when the location of the object is fairly known, the search area is small, and an intensive search is needed.
- Select **Expanding Square** when the location of the object is somewhat doubtful, the search area is small, and an intensive search is needed.
- Select **Creeping/Parallel Line** when the location of the object is approximate, the search area is small, and a consistent search is needed.

3 Enter the search parameters.

4 Select **Done**.

5 If necessary, select **Engage**.

### Deleting a Saved Route

1 Select **Info > User Data > Routes & Auto Guidance Paths**.

2 Select a route.

3 Select **Review > Delete**.

### Deleting All Saved Routes

Select **Info > User Data > Delete User Data > Routes & Auto Guidance Paths**.

## Auto Guidance

### WARNING

The Auto Guidance feature is based on electronic chart information. That data does not ensure obstacle and bottom clearance. Carefully compare the course to all visual sightings, and avoid any land, shallow water, or other obstacles that may be in your path.

All route and navigation lines displayed on the chartplotter are only intended to provide general route guidance or to identify proper channels, and are not intended to be precisely followed. Always defer to the nav aids and conditions on the water when navigating to avoid groundings or hazards that could result in vessel damage, personal injury, or death.

**NOTE:** Auto Guidance is available with premium charts, in some areas.

You can use Auto Guidance to plot the best path to your destination. Auto Guidance uses your chartplotter to scan chart data, such as water depth and known obstacles, to calculate a suggested path. You can adjust the path during navigation.

### Setting and Following an Auto Guidance Path

1 Select a destination (*Destinations, page 17*).

2 Select **Navigate To > Auto Guidance**.

3 Review the path, indicated by the magenta line.

4 Select **Start Navigation**.

5 Follow the magenta line, steering to avoid land, shallow water, and other obstacles.

**NOTE:** When using Auto Guidance, a gray segment within any part of the magenta line indicates that Auto Guidance cannot calculate part of the Auto Guidance line. This is due to the settings for minimum safe water depth and minimum safe obstacle height.

### Creating and Saving an Auto Guidance Path

1 Select **Info > User Data > Routes & Auto Guidance Paths > New > Auto Guidance**.

2 Select a starting point, and select **Next**.

3 Select a destination, and select **Next**.

4 Select an option:

- To view a hazard and adjust the path near a hazard, select **Hazard Review**.
- To adjust the path, select **Adjust Path**, and follow the on-screen instructions.
- To delete the path, select **Cancel Auto Guidance**.
- To save the path, select **Done**.

### Adjusting a Saved Auto Guidance Path

1 Select **Info > User Data > Routes & Auto Guidance Paths**.

2 Select a path, and select **Review > Edit > Adjust Path**.

**TIP:** When navigating an Auto Guidance path, select the path on the navigation chart, and select **Adjust Path**.

3 Select a location on the path.

4 Drag the point to a new location.

5 If necessary, select a point, and select **Remove**.

6 Select **Done**.

### Canceling an Auto Guidance Calculation in Progress

From the Navigation chart, select **Menu > Cancel**.

**TIP:** You can select **Back** to quickly cancel the calculation.

### Setting a Timed Arrival

You can use this feature on a route or an Auto Guidance path to get feedback about when you should arrive at a selected point.

This allows you to time your arrival at a location, such as a bridge opening or a race starting line.

1 From the Navigation chart, select **Menu**.

2 Select **Navigation Options > Timed Arrival**.

**TIP:** You can quickly open the Timed Arrival menu by selecting a point on the path or route.

### Auto Guidance Path Configurations

#### CAUTION

The Preferred Depth and Vertical Clearance settings influence how the chartplotter calculates an Auto Guidance path. If an area has an unknown water depth or an unknown obstacle height, the Auto Guidance path is not calculated in that area. If an area at the beginning or the end of an Auto Guidance path is shallower than the Preferred Depth or lower than the Vertical Clearance settings, the Auto Guidance path may not be calculated in that area, depending on the map data. On the chart, the course through those areas appears as a gray line or a magenta and gray striped line. When your boat enters one of those areas, a warning message appears.

**NOTE:** Auto Guidance is available with premium charts, in some areas.

**NOTE:** Not all settings apply to all maps.

You can set the parameters the chartplotter uses when calculating an Auto Guidance path.

**Preferred Depth:** Sets the minimum water depth, based on chart depth data, that your boat can safely travel over.

**NOTE:** The minimum water depth for the premium charts (made before 2016) is 3 feet. If you enter a value of less than 3 feet, the charts only use depths of 3 feet for Auto Guidance path calculations.

**Vertical Clearance:** Sets the minimum height of a bridge or obstacle, based on chart data, that your boat can safely travel under.

**Shoreline Distance:** Sets how close to the shore you want the Auto Guidance path to be placed. The Auto Guidance path may move if you change this setting while navigating. The available values for this setting are relative, not absolute. To ensure that the Auto Guidance line is placed the appropriate distance from shore, you can assess the placement of the Auto Guidance path using one or more familiar destinations that require navigation through a narrow waterway (*Adjusting the Distance from Shore, page 21*).

### Adjusting the Distance from Shore

The Shoreline Distance setting indicates how close to the shore you want the Auto Guidance line to be placed. The Auto Guidance line may move if you change this setting while navigating. The available values for the Shoreline Distance setting are relative, not absolute. To ensure the Auto Guidance line is placed the appropriate distance from shore, you can assess the placement of the Auto Guidance line using one or more familiar destinations that require navigation through a narrow waterway.

- 1 Dock your vessel or drop the anchor.
- 2 Select **Settings > Preferences > Navigation > Auto Guidance > Shoreline Distance > Normal**.
- 3 Select a destination that you have navigated to previously.
- 4 Select **Navigate To > Auto Guidance**.
- 5 Review the placement of the Auto Guidance line, and determine whether the line safely avoids known obstacles and the turns enable efficient travel.
- 6 Select an option:
  - If the placement of the Auto Guidance line is satisfactory, select **Menu > Navigation Options > Stop Navigation**, and proceed to step 10.
  - If the Auto Guidance line is too close to known obstacles, select **Settings > Preferences > Navigation > Auto Guidance > Shoreline Distance > Far**.
  - If the turns in the Auto Guidance line are too wide, select **Settings > Preferences > Navigation > Auto Guidance > Shoreline Distance > Near**.
- 7 If you selected **Near** or **Far** in step 6, review the placement of the Auto Guidance line, and determine whether the line safely avoids known obstacles and the turns enable efficient travel.

Auto Guidance maintains a wide clearance from obstacles in open water, even if you set the Shoreline Distance setting to **Near** or **Nearest**. As a result, the chartplotter may not reposition the Auto Guidance line, unless the destination selected requires navigation through a narrow waterway.

- 8 Select an option:
  - If the placement of the Auto Guidance line is satisfactory, select **Menu > Navigation Options > Stop Navigation**, and proceed to step 10.

- If the Auto Guidance line is too close to known obstacles, select **Settings > Preferences > Navigation > Auto Guidance > Shoreline Distance > Farthest**.
- If the turns in the Auto Guidance line are too wide, select **Settings > Preferences > Navigation > Auto Guidance > Shoreline Distance > Nearest**.

- 9 If you selected **Nearest** or **Farthest** in step 8, review the placement of the **Auto Guidance** line, and determine whether the line safely avoids known obstacles and the turns enable efficient travel.

Auto Guidance maintains a wide clearance from obstacles in open water, even if you set the Shoreline Distance setting to **Near** or **Nearest**. As a result, the chartplotter may not reposition the Auto Guidance line, unless the destination selected requires navigation through a narrow waterway.

- 10 Repeat steps 3 through 9 at least once more, using a different destination each time, until you are familiar with the functionality of the Shoreline Distance setting.

## Tracks

A track is a recording of the path of your boat. The track currently being recorded is called the active track, and it can be saved. You can show tracks in each chart or 3D chart view.

### Showing Tracks

- 1 From a chart, select **Menu > Layers > User Data > Tracks**.
- 2 Select the tracks to display.
  - A trailing line on the chart indicates your track.

### Setting the Color of the Active Track

- 1 Select **Info > User Data > Tracks > Active Track Options > Track Color**.
- 2 Select a track color.

### Saving the Active Track

The track currently being recorded is called the active track.

- 1 Select **Info > User Data > Tracks > Save Active Track**.
- 2 Select an option:
  - Select the time the active track began.
  - Select **Entire Log**.
- 3 Select **Save**.

### Viewing a List of Saved Tracks

Select **Info > User Data > Tracks > Saved Tracks**.

### Editing a Saved Track

- 1 Select **Info > User Data > Tracks > Saved Tracks**.
- 2 Select a track.
- 3 Select **Review > Edit Track**.
- 4 Select an option:
  - Select **Name**, and enter the new name.
  - Select **Track Color**, and select a color.

### Saving a Track as a Route

- 1 Select **Info > User Data > Tracks > Saved Tracks**.
- 2 Select a track.
- 3 Select **Select > Edit Track > Save as Route**.

### Browsing for and Navigating a Recorded Track

Before you can browse a list of tracks and navigate to them, you must record and save at least one track (*Tracks, page 21*).

- 1 Select **Info > User Data > Tracks > Saved Tracks**.
- 2 Select a track.
- 3 Select **Follow Track**.

- 4 Select an option:
  - To navigate the track from the starting point used when the track was created, select **Forward**.
  - To navigate the track from the destination point used when the track was created, select **Backward**.
- 5 Review the course indicated by the colored line.
- 6 Follow the line along each leg in the route, steering to avoid land, shallow water, and other obstacles.

### Deleting a Saved Track

- 1 Select **Info > User Data > Tracks > Saved Tracks**.
- 2 Select a track.
- 3 Select **Review > Delete**.

### Deleting All Saved Tracks

Select **Info > User Data > Delete User Data > Saved Tracks**.

### Retracing the Active Track

The track currently being recorded is called the active track.

- 1 Select **Info > User Data > Tracks > Follow Active Track**.
- 2 Select an option:
  - Select the time the active track began.
  - Select **Entire Log**.
- 3 Review the course indicated by the colored line.
- 4 Follow the colored line, steering to avoid land, shallow water, and other obstacles.

### Clearing the Active Track

Select **Info > User Data > Tracks > Clear Active Track**.

The track memory is cleared, and the active track continues to be recorded.

### Managing the Track Log Memory During Recording

- 1 Select **Info > User Data > Tracks > Active Track Options**.
- 2 Select **Record Mode**.
- 3 Select an option:
  - To record a track log until the track memory is full, select **Fill**.
  - To continuously record a track log, replacing the oldest track data with new data, select **Wrap**.

### Configuring the Recording Interval of the Track Log

You can indicate the frequency at which the track plot is recorded. Recording more frequent plots is more accurate but fills the track log faster. The resolution interval is recommended for the most efficient use of memory.

- 1 Select **Info > User Data > Tracks > Active Track Options > Interval**.
- 2 Select an option:
  - To record the track based on a distance between points, select **Interval > Distance > Change**, and enter the distance.
  - To record the track based on a time interval, select **Interval > Time > Change**, and enter the time interval.
  - To record the track plot based on a variance from your course, select **Interval > Resolution > Change**, and enter the maximum error allowed from the true course before recording a track point. This is the recommended recording option.

## Boundaries

Boundaries allow you to avoid or remain in designated areas in a body of water. You can set an alarm to alert you when you enter or exit a boundary.

You can create boundary areas, lines, and circles using the map. You can also convert saved tracks and routes into boundary lines. You can create a boundary area using waypoints by creating a route from the waypoints, and converting the route into a boundary line.

You can select a boundary to act as the active boundary. You can add the active boundary data to the data fields on the chart.

### Creating a Boundary

- 1 Select **Info > User Data > Boundaries > New**.
- 2 Select a boundary shape.
- 3 Follow the on-screen instructions.

### Converting a Route to a Boundary

Before you can convert a route to a boundary, you must create and save at least one route ([Creating and Saving a Route, page 19](#)).

- 1 Select **Info > User Data > Routes & Auto Guidance Paths**.
- 2 Select a route.
- 3 Select **Review > Edit Route > Save as Boundary**.

### Converting a Track to a Boundary

Before you can convert a track to a boundary, you must record and save at least one track ([Saving the Active Track, page 21](#)).

- 1 Select **Info > User Data > Tracks > Saved Tracks**.
- 2 Select a track.
- 3 Select **Review > Edit Track > Save as Boundary**.

### Editing a Boundary

- 1 Select **Info > User Data > Boundaries**.
- 2 Select a boundary.
- 3 Select **Review**.
- 4 Select an option:
  - To edit the appearance of the boundary on the chart, select **Display Options**.
  - To change the boundary lines or name, select **Edit Boundary**.
  - To edit the boundary alarm, select **Alarm**.

### Linking a Boundary to a SmartMode Layout

You can link a boundary to a SmartMode layout to automatically open the layout when entering or exiting the boundary. For example, you can set a boundary around your marina, and automatically open the Docking layout when you approach the marina.

- 1 Select **Info > User Data > Boundaries**.
- 2 Select a boundary.
- 3 Select **Review > Link SmartMode™ > SmartMode™**.
- 4 Select **Entering**, and select a layout.
- 5 Select **Exiting**, and select a layout.

### Setting a Boundary Alarm

Boundary alarms alert you when you are within a specified distance of a set boundary. This can be helpful when attempting to avoid certain areas or when you should be very alert in certain areas, such as shipping lanes.

- 1 Select **Info > User Data > Boundaries**.
- 2 Select a boundary.
- 3 Select **Review > Alarm**.
- 4 Select an option:
  - To set an alarm for when your boat is a specified distance from the boundary, select **Warning Dist.**, enter a distance, and select **Done**.
  - To set an alarm when you enter or exit the boundary, select **Area** to show **Entering** or **Exiting**.

## Disabling all Boundary Alarms

Select **Info** > **User Data** > **Boundaries** > **Alarms**.

## Deleting a Boundary

- 1 Select **Info** > **User Data** > **Boundaries**.
- 2 Select a boundary.
- 3 Select **Review** > **Edit Boundary** > **Delete**.

## Deleting All Saved Waypoints, Tracks, Routes, and Boundaries

Select **Info** > **User Data** > **Delete User Data** > **Delete All User Data** > **OK**.

# Sailing Features

## Setting the Vessel Type

You can select your boat type to configure the chartplotter settings and to use features customized for your boat type.

- 1 Select **Settings** > **My Vessel** > **Vessel Type**.
- 2 Select an option.

## Sail Racing

You can use the device to increase the likelihood that your boat will cross the start line of a race exactly when the race begins. When you synchronize the race timer with the official race countdown timer, you are alerted at one-minute intervals as the race start approaches. When you combine the race timer with the virtual start line, the device measures your speed, bearing, and remaining time on the countdown timer. The device uses this data to indicate whether your boat will cross the start line before, after, or at the correct time to start the race.

## Starting Line Guidance

Sailing start line guidance is a visual representation of the information you need to cross the start line at the optimal time and speed.

After you set the starboard and port start line pins, and the target speed and time, and after you start the race timer, a predictor line appears. The predictor line extends from your current location toward the start line and the laylines that extend from each pin.

The end point and color of the predictor line indicate where the boat will be when the timer expires, based on your current boat speed.

When the end point is before the start line, the line is white. This indicates the boat must increase speed to reach the start line on time.

When the end point is past the start line, the line is red. This indicates the boat must reduce speed to avoid a penalty for reaching the start line before the timer expires.

When the end point is on the start line, the line is white. This indicates the boat is moving at an optimal speed to reach the start line when the timer expires.

By default, the start line guidance window and the race timer window appear in the Sail Racing combination screen.

## Setting the Starting Line

The start line guidance window is added to the Sail Racing combination screen by default.

- 1 From the Sail Racing combination screen, select **Menu** > **Start Line Guidance** > **Start Line**.
- 2 Select an option:
  - To mark the port and starboard starting line marks as you sail past them, select **Ping Marks**.
  - To mark the port and starboard starting line marks by entering their coordinates, select **Enter Coordinates**.

- To switch the position of the port and starboard marks after you have set them, select **Swap Port & Starbd.**

## Using the Starting Line Guidance

You can use the starting line guidance feature to help get you cross the start line, at the optimal speed during a sailing race.

- 1 Mark the starting line ([Setting the Starting Line, page 23](#)).
- 2 From the Sail Racing combination screen, select **Menu** > **Start Line Guidance** > **Target Speed**, and select your target speed when crossing the starting line.
- 3 Select **Target Time**, and select the target time to cross the starting line.
- 4 Select **Back**.
- 5 Start the racing timer ([Starting the Race Timer, page 23](#)).

## Starting the Race Timer

The race timer is added to the Sail Racing combination screen by default.

- 1 From the Sail Racing combination screen, select **Start**.  
**NOTE:** You can also access this from the Sailing SmartMode screen and the navigation chart.
- 2 When necessary, select **Sync** to synchronize with the official race timer.

## Stopping the Race Timer

From the Sail Racing combination screen, select **Stop**.

## Setting the Distance between the Bow and the GPS Antenna

You can enter the distance between the bow of your boat and the location of your GPS antenna. This helps ensure the bow of your boat crosses the starting line at the precise start time.

- 1 From a navigation chart, select **Menu** > **Sailing** > **Start Line** > **GPS Bow Offset**.
- 2 Enter the distance.
- 3 Select **Done**.

## Laylines Settings

To use the laylines features, you must connect a wind sensor to the chartplotter.

When in sailing mode ([Setting the Vessel Type, page 5](#)), you can display laylines on the navigation chart. Laylines can be very helpful when racing.

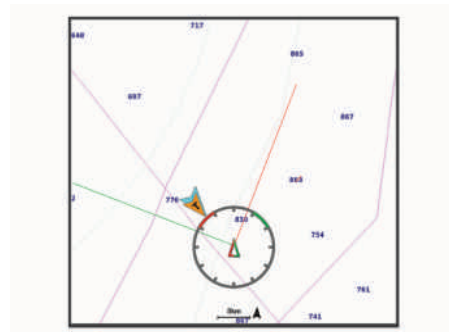

From the navigation chart, select **Menu** > **Layers** > **My Vessel** > **Laylines** > **Setup**.

**Display:** Sets how the laylines and vessel appear on the chart, and sets the length of the laylines.

**Sailing Ang.:** Allows you to select how the device calculates laylines. The Actual option calculates the laylines using the measured wind angle from the wind sensor. The Manual option calculates the laylines using manually entered windward and leeward angles.

**Windward Ang.:** Allows you to set a layline based on the windward sailing angle.

**Leeward Ang.:** Allows you to set a layline based on the leeward sailing angle.

**Tide Correction:** Corrects the laylines based on the tide.

**Layline Filter:** Filters the layline data based on the time interval entered. For a smoother layline that filters out some of the changes in the boat's heading or true wind angle, enter a higher number. For laylines that display a higher sensitivity to changes in the boat's heading or true wind angle, enter a lower number.

## Setting the Keel Offset

You can enter a keel offset to compensate the water depth reading for the transducer installation location. This allows you to view the depth of the water below the keel or the true depth of the water, depending on your needs.

If you want to know the water depth below the keel or the lowest point of your boat and the transducer is installed at the water line or anywhere above the end of the keel, measure the distance from the transducer location to the keel of the boat.

If you want to know the true water depth and the transducer is installed below the water line, measure the distance from the bottom of the transducer up to the water line.

**NOTE:** This option is only available when you have valid depth data.

1 Measure the distance:

- If the transducer is installed at the water line ① or anywhere above the end of the keel, measure the distance from the transducer location to the keel of the boat. Enter this value as a positive number.
- If the transducer is installed at the bottom of the keel ② and you want to know the true depth of the water, measure the distance from the transducer to the water line. Enter this value in as a negative number.

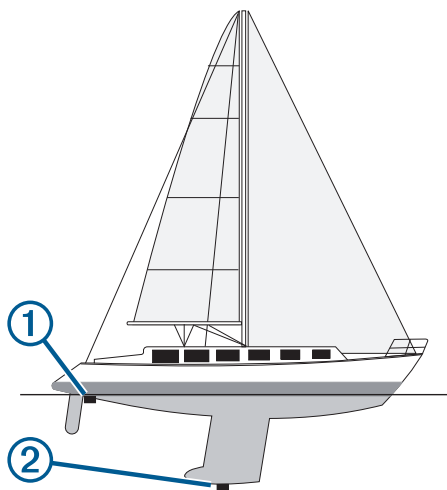

2 Complete an action:

- If the transducer is connected to the chartplotter or a sonar module, select **Settings** > **My Vessel** > **Depth and Anchoring** > **Keel Offset**.
- If the transducer is connected to the NMEA 2000 network, select **Settings** > **Communications** > **NMEA 2000 Setup** > **Device List**, select the transducer, and select **Review** > **Keel Offset**.

3 Select **+** if the transducer is installed at the water line, or select **-** if the transducer is installed at the bottom of the keel.

4 Enter the distance measured in step 1.

## Sailboat Autopilot Operation

### ⚠ CAUTION

When engaged, the autopilot controls only the rudder. You and your crew remain responsible for the sails while the autopilot is engaged.

In addition to heading hold, you can use the autopilot to maintain a wind hold. You can also use the autopilot to control the rudder while tacking and gybing.

### Wind Hold

You can set the autopilot to maintain a specific bearing relative to the current wind angle. Your device must be connected to a NMEA 2000 or NMEA 0183 compatible wind sensor to perform a wind hold or a wind-based tack or gybe.

#### Setting the Wind Hold Type

Before you can enable the wind hold type, you must connect a NMEA 2000 or NMEA 0183 wind sensor to the autopilot.

For advanced autopilot configuration, see the installation instructions included with your autopilot.

- 1 From the autopilot screen, select **Menu** > **Autopilot Setup** > **Wind Hold Type**.
- 2 Select **Apparent** or **True**.

#### Engaging Wind Hold

Before you can enable the wind hold type, you must connect a NMEA 2000 or NMEA 0183 wind sensor to the autopilot.

When the autopilot is in standby mode, select **Wind Hold**.

#### Engaging Wind Hold from Heading Hold

Before you can enable the wind hold type, you must connect a NMEA 2000 or NMEA 0183 wind sensor to the autopilot.

With heading hold engaged, select **Menu** > **Wind Hold**.

#### Adjusting the Wind Hold Angle with the Autopilot

You can adjust the wind hold angle on the autopilot when wind hold is engaged.

- To adjust the wind hold angle in increments of 1°, select ◀ or ▶.
- To adjust the wind hold angle in increments of 10°, hold ◀ or ▶.

### Tack and Gybe

You can set the autopilot to perform a tack or gybe while heading hold or wind hold is engaged.

#### Tacking and Gybing from Heading Hold

1 Engage heading hold ([Engaging the Autopilot, page 40](#)).

2 Select **Menu**.

3 Select an option.

The autopilot steers your boat through a tack or gybe.

#### Tacking and Gybing from Wind Hold

Before you can engage wind hold, you must have a wind sensor installed.

1 Engage wind hold ([Engaging Wind Hold, page 24](#)).

2 Select **Menu**.

3 Select an option.

The autopilot steers your boat through a tack or gybe, and information about the progress of the tack or gybe appears on the screen.

#### Setting a Tack and Gybe Delay

The tack and gybe delay allows you to delay steering a tack and gybe after you initiate the maneuver.

1 From the autopilot screen, select **Menu** > **Autopilot Setup** > **Sailing Setup** > **Tack Delay**.

2 Select the length of the delay.



3 If necessary, select **Done**.

### Enabling the Gybe Inhibitor

**NOTE:** The gybe inhibitor does not prevent you from manually performing a gybe using the helm or step steering.

The gybe inhibitor prevents the autopilot from performing a gybe.

- 1 From the autopilot screen, select **Menu > Autopilot Setup > Sailing Setup > Gybe Inhibitor**.
- 2 Select **Enabled**.

## Heading Line and Angle Markers

The heading line is an extension drawn on the map from the bow of the boat in the direction of travel. Angle markers indicate relative position from the heading or course over ground, which are helpful for casting or finding reference points.

### Setting the Heading Line and Angle Markers

The heading line is an extension drawn on the map from the bow of the boat in the direction of travel. Angle markers indicate relative position from the heading or course over ground, which are helpful for casting or finding reference points.

You can show the heading line and the course over ground (COG) line on the chart.

COG is your direction of movement. Heading is the direction the bow of the boat is pointed, when a heading sensor is connected.

- 1 From a chart, select **Menu > Layers > My Vessel > Heading Line > Angle Markers**.
- 2 If necessary, select **Source**, and select an option:
  - To automatically use the available source, select **Auto**.
  - To use the GPS antenna heading for COG, select **GPS Heading (COG)**.
  - To use data from a connected heading sensor, select **North Reference**.
  - To use data from both a connected heading sensor and the GPS antenna, select **COG and Heading**.This displays both the heading line and the COG line on the chart.
- 3 Select **Display**, and select an option:
  - Select **Distance > Distance**, and enter the length of the line shown on the chart.
  - Select **Time > Time**, and enter the time used to calculate the distance your boat will travel in the specified time at your present speed.

## Sonar Fishfinder

When properly connected to a transducer, your compatible chartplotter can be used as a fishfinder. Chartplotter models without an xsv or xs in their names require a Garmin sounder module and transducer to display sonar information.

For more information about which transducer is best for your needs, go to [garmin.com/transducers](http://garmin.com/transducers).

Different sonar views can help you view the fish in the area. The sonar views available vary depending on the type of transducer and sounder module connected to the chartplotter. For example, you can view certain Panoptix™ sonar screens only if you have a compatible Panoptix transducer connected.

There are four basic styles of sonar views available: a full-screen view, a split-screen view that combines two or more views, a split-zoom view, and a split-frequency view that displays two different frequencies. You can customize the settings for each view in the screen. For example, if you are viewing the split-frequency view, you can separately adjust the gain for each frequency.

If you do not see an arrangement of sonar views to suit your needs, you can create a custom combination screen ([Creating a New Combination Page, page 5](#)) or a SmartMode layout ([Adding a SmartMode Layout, page 4](#)).

## Stopping the Transmission of Sonar Signals

- To disable the active sonar, from the sonar screen, select **Menu > Transmit**.
- To disable all sonar transmissions, press  $\odot$ , and select **Disable All Sonar Trans.**

## Changing the Sonar View

- 1 From a combination screen or SmartMode layout with sonar, select the window to change.
- 2 Select **Menu > Change Sonar**.
- 3 Select a sonar view.

### Traditional Sonar View

There are several full-screen views available, depending on the transducer that is connected.

The full-screen Traditional sonar view shows a large image of the sonar readings from a transducer. The range scale along the right side of the screen shows the depth of detected objects as the screen scrolls from the right to the left.

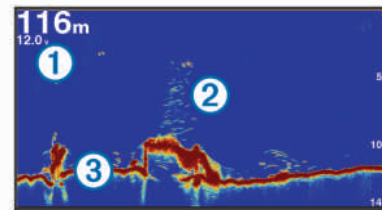

①	Depth information
②	Suspended targets or fish
③	Bottom of the body of water

### Split-Frequency Sonar View

In the split-frequency sonar view, the two sides of the screen show a full-view graph of sonar data of different frequencies.

**NOTE:** The split-frequency sonar view requires the use of a dual-frequency transducer.

### Split-Zoom Sonar View

The split-zoom sonar view shows a full-view graph of sonar readings, and a magnified portion of that graph, on the same screen.

### Garmin ClearVü Sonar View

**NOTE:** To receive Garmin ClearVü scanning sonar, you need a compatible chartplotter or fishfinder and a compatible transducer. For information about compatible transducers, go to [garmin.com/transducers](http://garmin.com/transducers).

Garmin ClearVü high-frequency sonar provides a detailed picture of the fishing environment around the boat in a detailed representation of structures the boat is passing over.



Traditional transducers emit a conical beam. The Garmin ClearVü scanning sonar technology emits two narrow beams, similar to the shape of the beam in a copying machine. These beams provide a clearer, picture-like image of what is beneath the boat.

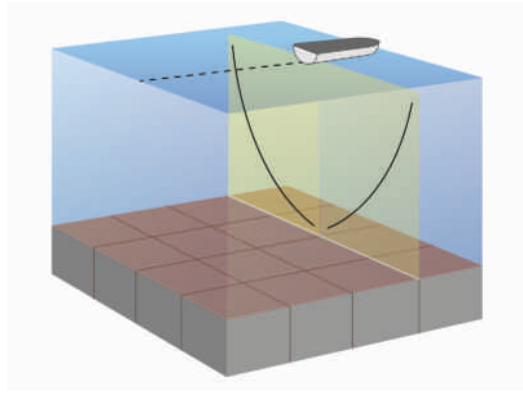
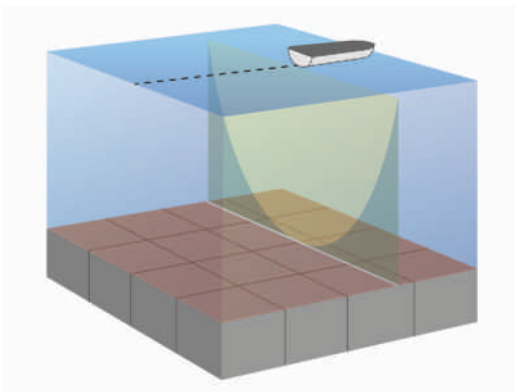

## SideVü Sonar View

**NOTE:** Not all models provide built-in SideVü sonar support. If your model does not provide built-in SideVü sonar, you need a compatible sounder module and compatible SideVü transducer. If your model does provide built-in SideVü sonar, you need a compatible SideVü transducer.

SideVü scanning sonar technology shows you a picture of what lies to the sides of the boat. You can use this as a search tool to find structures and fish.

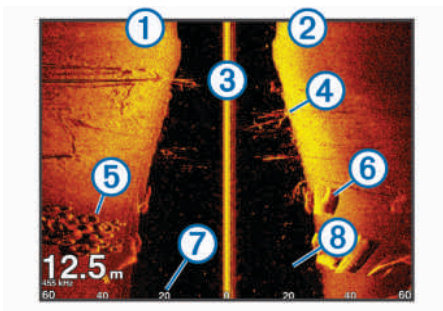

①	Left side of the boat
②	Right side of the boat
③	The transducer on your vessel
④	Trees
⑤	Old tires
⑥	Logs
⑦	Distance from the side of the boat
⑧	Water between the vessel and the bottom

## SideVü Scanning Technology

Instead of a more common conical beam, the SideVü transducer uses a flat beam to scan the water and bottom to the sides of your boat.

## Measuring Distance on the Sonar Screen

You can measure the distance between two points on the SideVü sonar view.

- 1 From the SideVü sonar view, select **||**.
- 2 Select a location on the screen.
- 3 Select **Measure**.

A push pin appears on the screen at the selected location.

- 4 Select another location.

The distance and angle from the pin is listed in the upper-left corner.

**TIP:** To reset the pin and measure from the current location of the pin, select Set Reference.

## Panoptix Sonar Views

To receive Panoptix sonar, you need a compatible transducer.

The Panoptix sonar views allow you to see all around the boat in real time. You can also watch your bait underwater and bait schools in front of or below your boat.

The LiveVü sonar views provide you a view of the live movement either in front of or below your boat. The screen updates very quickly, producing sonar views that look more like live video.

The RealVü 3D sonar views provide three-dimensional views of either what is in front of or below your boat. The screen updates with each sweep of the transducer.

To see all five Panoptix sonar views, you need one transducer to show the down views and a second transducer to show the forward views.

To access the Panoptix sonar views, select Sonar, and select a view.

## LiveVü Down Sonar View

This sonar view shows a two-dimensional view of what is below the boat and can be used to see a bait ball and fish.

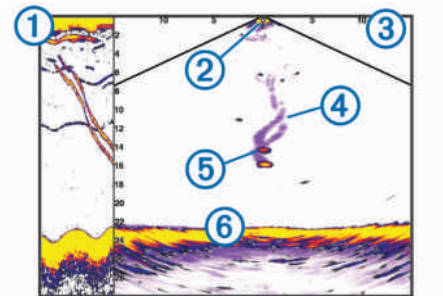

①	Panoptix down view history in a scrolling sonar view
②	Boat
③	Range
④	Trails

⑤	Drop shot rig
⑥	Bottom

### LiveVü Forward Sonar View

This sonar view shows a two-dimensional view of what is in front of the boat and can be used to see a bait ball and fish.

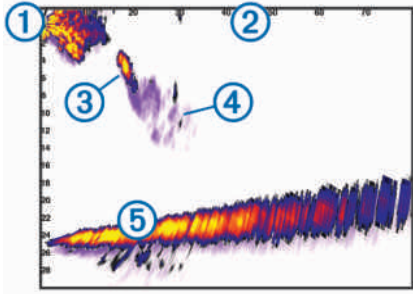

①	Boat
②	Range
③	Fish
④	Trails
⑤	Bottom

### RealVü 3D Forward Sonar View

This sonar view shows a three-dimensional view of what is in front of the transducer. This view can be used when you are stationary and you need to see the bottom and the fish approaching the boat.

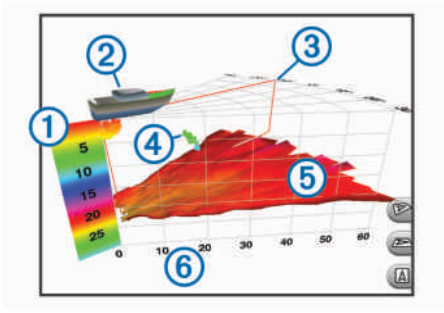

①	Color legend
②	Boat
③	Ping indicator
④	Fish
⑤	Bottom
⑥	Range

### RealVü 3D Down Sonar View

This sonar view shows a three-dimensional view of what is below the transducer and can be used when you are stationary and want to see what is around your boat.

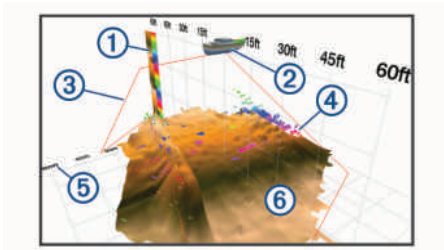

①	Color legend
②	Boat
③	Sonar beam
④	Range
⑤	Fish
⑥	Bottom

### RealVü 3D Historical Sonar View

This sonar view provides a three-dimensional view of what is behind your boat as you are moving and shows the entire water column in 3D, from the bottom to the top of the water. This view is used for finding fish.

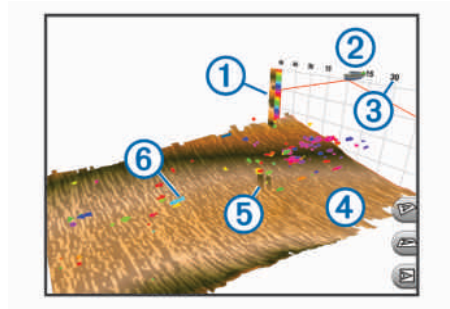

①	Color legend
②	Boat
③	Range
④	Bottom
⑤	Structure
⑥	Fish

### FrontVü Sonar View

The Panoptix FrontVü sonar view increases your situational awareness by showing obstructions under the water, up to 91 meters (300 feet) in front of the boat.

The ability to effectively avoid forward collisions with FrontVü sonar decreases as your speed rises above 8 knots.

To see the FrontVü sonar view, you must install and connect a compatible transducer, such as a PS21 transducer. You may need to update the transducer software.

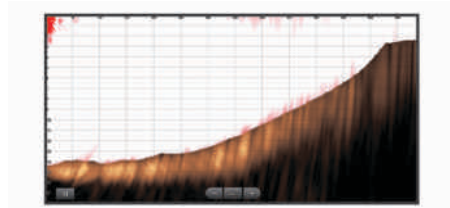

### Panoptix LiveScope™ Sonar View

This sonar view shows a live view of what is in front of or below the boat and can be used to see fish and structures.

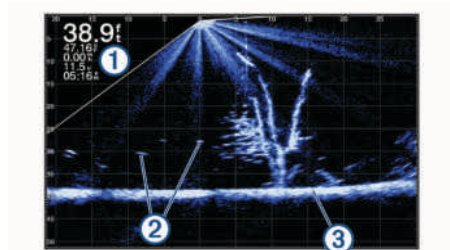

①	Depth information
②	Suspended targets or fish
③	Bottom of the body of water

## Perspective View

This sonar view shows a live view of what is around and ahead of your boat and can be used to see shorelines, fish, and structures. This view is best used in shallow water of 50 feet (15 meters) or less.

To see this sonar view, you must install a Panoptix LiveScope transducer on a Perspective Mode Mount (010-12970-00).

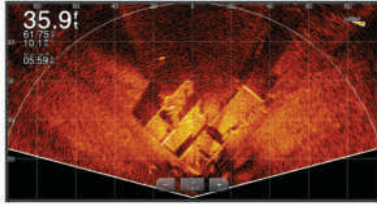

## Selecting the Transducer Type

This chartplotter is compatible with a range of accessory transducers, including the Garmin ClearVü™ transducers, which are available at [garmin.com/transducers](http://garmin.com/transducers).

If you are connecting a transducer that was not included with the chartplotter, you may need to set the transducer type to make the sonar function properly.

**NOTE:** Not all chartplotters and sonar modules support this feature.

- Complete an action:
  - From a sonar view, select **Menu > Sonar Setup > Installation > Transducers**.
  - Select **Settings > My Vessel > Transducers**.
- Select an option:
  - To enable the chartplotter to detect the transducer automatically, select the transducer to change, and select **Auto Detect**.
  - To select the transducer manually, select the transducer to change, select the transducer model from the list, and select **Change Model**.

**NOTE:** If you select the transducer manually, disconnect that transducer, and then connect a different transducer, you should reset this option to **Auto Detect**.

## Selecting a Sonar Source

This feature may not be available with all models.

When you are using more than one sonar data source for a particular sonar view, you can select the source to use for that sonar view. For example, if you have two sources for Garmin ClearVü, you can select the source to use from the Garmin ClearVü sonar view.

- Open the sonar view for which you will change the source.
- Select **Menu > Sonar Setup > Source**.
- Select the source for this sonar view.

## Renaming a Sonar Source

You can rename a sonar source to easily identify that source. For example, you use "Bow" as the name of the transducer on the bow of your boat.

To rename a source, you must be in the applicable sonar view for the source. For example, to rename the Garmin ClearVü sonar source, you must open the Garmin ClearVü sonar view.

- From the sonar view, select **Menu > Sonar Setup > Source > Rename Sources**.

- Enter the name.

## Creating a Waypoint on the Sonar Screen

- From a sonar view, drag the screen or select **■**.
- Select a location.
- Select **📍**.
- If necessary, edit the waypoint information.

## Pausing the Sonar Display

From a sonar view, select **■**.

## Viewing Sonar History

You can scroll the sonar display to view historical sonar data.

**NOTE:** Not all transducers save historical sonar data.

- From a sonar view, drag the screen to the right.
- Select **Back** to exit history.

## Sonar Sharing

You can view the sonar data from all compatible sources on the Garmin Marine Network. You can view sonar data from a compatible external sonar module, such as a GCV™ sonar module. In addition, you can view the sonar data from other chartplotters that have a built-in sonar module.

Each chartplotter on the network can display sonar data from every compatible sonar module and transducer on the network, no matter where the chartplotters and transducers are mounted on your boat. For example, from one GPSMAP 923 device mounted at the back of the boat, you can view the sonar data from another GPSMAP device and Garmin ClearVü transducer mounted at the front of your boat.

When sharing sonar data, the values of some sonar settings, such as Range and Gain, are synchronized across the devices on the network. The values of other sonar settings, such as the Appearance settings, are not synchronized and should be configured on each individual device. In addition, the scroll rates of the various traditional and Garmin ClearVü sonar views are synchronized to make the split views more cohesive.

**NOTE:** Using multiple transducers simultaneously can create cross talk, which can be removed by adjusting the Interference sonar setting.

## Adjusting the Level of Detail

You can control the level of detail and noise shown on the sonar screen either by adjusting the gain for traditional transducers or by adjusting the brightness for Garmin ClearVü transducers.

If you want to see the highest intensity signal returns on the screen, you can lower the gain or brightness to remove lower intensity returns and noise. If you want to see all return information, you can increase the gain or brightness to see more information on the screen. This also increases noise, and can make it more difficult to recognize actual returns.

- From a sonar view, select **Menu**.
- Select **Gain** or **Brightness**.
- Select an option:
  - To increase or decrease the gain or brightness manually, select **Up** or **Down**.
  - To allow the chartplotter to adjust the gain or brightness automatically, select an automatic option.

## Adjusting the Color Intensity

You can adjust the intensity of colors and highlight areas of interest on the sonar screen by adjusting the color gain for traditional transducers or the contrast for Garmin ClearVü and SideVü/ClearVü transducers. This setting works best after you

have adjusted the level of detail shown on the screen using the gain or brightness settings.

If you want to highlight smaller fish targets or create a higher intensity display of a target, you can increase the color gain or contrast setting. This causes a loss in the differentiation of the high intensity returns at the bottom. If you want to reduce the intensity of the return, you can reduce the color gain or contrast.

- 1 From a sonar view, select **Menu**.
- 2 Select an option:
  - While in the Garmin ClearVü or SideVü sonar view, select **Contrast**.
  - While in a Panoptix LiveVü sonar view, select **Color Gain**.
  - While in another sonar view, select **Sonar Setup > Appearance > Color Gain**.
- 3 Select an option:
  - To increase or decrease the color intensity manually, select **Up** or **Down**.
  - To use the default setting, select **Default**.

## Sonar Recordings

### Recording the Sonar Display

- 1 Insert a memory card into the card slot.
- 2 From a sonar view, select **Menu > Sonar Setup > Sonar Recording > Record Sonar**.

15 minutes of sonar recording uses approximately 200 MB of space of the inserted memory card. An individual recording automatically ends after it reaches 4 GB in size. You can record sonar data until the card reaches capacity.

### Stopping the Sonar Recording

Before you can stop recording sonar, you must begin recording it ([Recording the Sonar Display, page 29](#)).

From a sonar view, select **Menu > Sonar Setup > Sonar Recording > Stop Recording**.

### Deleting a Sonar Recording

- 1 Insert a memory card into the card slot.
- 2 From a sonar view, select **Menu > Sonar Setup > Sonar Recordings > View Recordings**.
- 3 Select a recording.
- 4 Select **Review > Delete**.

### Playing Sonar Recordings

Before you can play back the sonar recordings, you must download and install the HomePort™ application and record sonar data onto a memory card.

- 1 Remove the memory card from the device.
- 2 Insert the memory card into a card reader attached to a computer.
- 3 Open the HomePort application.
- 4 Select a sonar recording from your device list.
- 5 Right-click the sonar recording in the lower pane.
- 6 Select **Playback**.

## Traditional, Garmin ClearVü, and SideVü Sonar Setup

**NOTE:** Not all options and settings apply to all models, sounder modules, and transducers.

**NOTE:** These settings do not apply to Panoptix transducers.

From a sonar view, select **Menu > Sonar Setup**.

**Scroll Speed:** Sets the rate at which the sonar scrolls from right to left ([Setting the Scroll Speed, page 29](#)).

In shallow water, you can select a slower scroll speed to extend the length of time the information is displayed on screen. In deeper water, you can select a faster scroll speed. Automatic scroll speed adjusts the scrolling speed to the speed the boat is traveling.

**Noise Reject:** Reduces the interference and the amount of clutter shown on the sonar screen ([Sonar Noise Rejection Settings, page 30](#)).

**Appearance:** Configures the appearance of the sonar screen ([Sonar Appearance Settings, page 30](#)).

**Alarms:** Sets sonar alarms ([Sonar Alarms, page 30](#)).

**Advanced:** Configures various sonar display and data source settings ([Advanced Sonar Settings, page 31](#)). Not applicable to Garmin ClearVü or SideVü sonar views.

**Installation:** Configures the transducer ([Traditional, Garmin ClearVü, and SideVü Transducer Installation Settings, page 31](#)).

### Setting the Zoom Level on the Sonar Screen

- 1 From a sonar view, select **Menu > Zoom > [ ] > Mode**.
- 2 Select an option:
  - To set the depth and zoom automatically, select **Auto**.

If necessary, select **Set Zoom** to modify the zoom setting. Select **View Up** or **View Down** to set the depth range of the magnified area, and select **Zoom In** or **Zoom Out** to increase or decrease the magnification of the magnified area.
  - To set the depth range of the magnified area manually, select **Manual**.

If necessary, select **Set Zoom** to modify the zoom setting. Select **View Up** or **View Down** to set the depth range of the magnified area, and select **Zoom In** or **Zoom Out** to increase or decrease the magnification of the magnified area.
  - To magnify one particular area of the screen, select **Magnify**.

If necessary, select **Magnify** to increase or decrease the magnification level.

**TIP:** You can drag the magnification box to a new location on the screen.
  - To zoom in on the sonar data from the bottom depth, select **Bottom Lock**.

If necessary, select **Span** to adjust the depth and placement of the bottom lock area.

To cancel the zoom, deselect the Zoom option.

### Setting the Scroll Speed

You can set the rate at which the sonar image moves across the screen. A higher scroll speed shows more detail until there is no additional detail to show, at which point it starts stretching out the existing detail. This can be useful while moving or trolling, or when you are in very deep water where the sonar is pinging very slowly. A lower scroll speed displays sonar information on the screen longer.

For most situations, the Default setting provides a good balance between a quickly scrolling image and less distorted targets.

- 1 From a sonar view, select **Menu > Sonar Setup > Scroll Speed**.
- 2 Select an option:
  - To adjust the scroll speed automatically using speed-over-ground or water speed data, select **Auto**.

The **Auto** setting selects a scroll rate to match the boat speed, so targets in the water are drawn with the correct aspect ratio and appear less distorted. When viewing Garmin ClearVü or SideVü sonar views or searching for structure, it is recommend to use the **Auto** setting.

- To scroll faster, select **Up**.
- To scroll more slowly, select **Down**.

### Adjusting the Range of the Depth or Width Scale

You can adjust the range of the depth scale traditional and Garmin ClearVü sonar views and the range of the width scale for the SideVü sonar view.

Allowing the device to adjust the range automatically keeps the bottom within the lower or outer third of the sonar screen, and can be useful for tracking a bottom that has minimal or moderate terrain changes.

Manually adjusting the range enables you to view a specified range, which can be useful for tracking a bottom that has large terrain changes, such as a drop-offs or cliffs. The bottom can appear on the screen as long as it appears within the range you have set.

**1** From a sonar view, select **Menu > Range**.

**2** Select an option:

- To allow the chartplotter to adjust the range automatically, select **Auto**.
- To increase or decrease the range manually, select **Up** or **Down**.

**TIP:** From the sonar screen, you can select **+** or **-** to manually adjust the range.

**TIP:** When viewing multiple sonar screens, you can select **Select** to choose the active screen.

### Sonar Noise Rejection Settings

From a sonar view, select **Menu > Sonar Setup > Noise Reject**.

**Interference:** Adjusts the sensitivity to reduce the effects of interference from nearby sources of noise.

The lowest interference setting that achieves the desired improvement should be used to remove interference from the screen. Correcting installation issues that cause noise is the best way to eliminate interference.

**Color Limit:** Hides part of the color palette to help eliminate fields of weak clutter.

By setting the color limit to the color of the undesired returns, you can eliminate the display of undesired returns on the screen.

**Smoothing:** Removes noise that is not part of a normal sonar return, and adjusts the appearance of returns, such as the bottom.

When smoothing is set to high, more of the low-level noise remains than when using the interference control, but the noise is more subdued because of averaging. Smoothing can remove speckle from the bottom. Smoothing and interference work well together to eliminate low-level noise. You can adjust the interference and smoothing settings incrementally to remove undesirable noise from the display.

**Surface Noise:** Hides surface noise to help reduce clutter.

Wider beam widths (lower frequencies) can show more targets, but can generate more surface noise.

**TVG:** Adjusts the time varying gain, which can reduce noise.

This control is best used for situations when you want to control and suppress clutter or noise near the water surface. It also allows for the display of targets near the surface that are otherwise hidden or masked by surface noise.

### Sonar Appearance Settings

From a sonar view, select **Menu > Sonar Setup > Appearance**.

**Color Scheme:** Sets the color scheme.

**Color Gain:** Adjusts the intensity of colors (*Adjusting the Color Intensity*, page 28).

**A-Scope:** Displays a vertical flasher along the right side of the screen that shows instantaneously the range to targets along a scale.

**Depth Line:** Shows a quick-reference depth line.

**Edge:** Highlights the strongest signal from the bottom to help define the hardness or softness of the signal.

**Fish Symbols:** Sets how the sonar interprets suspended targets.

	Shows suspended targets as symbols and background sonar information.
	Shows suspended targets as symbols with target depth information and background sonar information.
	Shows suspended targets as symbols.
	Shows suspended targets as symbols with target depth information.

**Pic. Advance:** Allows the sonar picture to advance faster by drawing more than one column of data on the screen for each column of sounder data received. This is especially helpful when you are using the sounder in deep water, because the sonar signal takes longer to travel to the water bottom and back to the transducer.

The 1/1 setting draws one column of information on the screen per sounder return. The 2/1 setting draws two columns of information on the screen per sounder return, and so on for the 4/1 and 8/1 settings.

**Echo Stretch:** Adjusts the size of the echoes on the screen to make it easier to see separate returns on the screen.

When targets are difficult to see ①, echo stretch makes the target returns more pronounced and easier to see on the screen. If the echo stretch value is too high, the targets blend together. If the value is too low ②, the targets are small and more difficult to see.

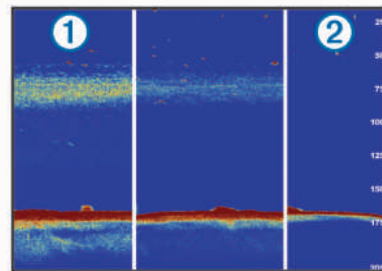

You can use echo stretch and filter width together to obtain the preferable resolution and noise reduction. With echo stretch and filter width set to low, the display has the highest resolution, but is the most susceptible to noise. With echo stretch set to high and filter width set to low, the display has a lower resolution, but has wider targets. With echo stretch and filter width set to high, the display has the lowest resolution, but is the least susceptible to noise. It is not recommended to set echo stretch to low and filter width to high.

**Overlay Data:** Sets the data shown on the sonar screen.

### Sonar Alarms

**NOTE:** Not all options are available on all transducers.

From an applicable sonar view, select **Menu > Sonar Setup > Alarms**.

You can also open the sonar alarms by selecting **Settings > Alarms > Sonar**.

**Shallow Water:** Sets an alarm to sound when the depth is less than the specified value.

**Deep Water:** Sets an alarm to sound when the depth is greater than the specified value.

**FrontVü Alarm:** Sets an alarm to sound when the depth in front of the vessel is less than the specified value, which can help



you avoid running aground ([Setting the FrontVü Depth Alarm, page 33](#)). This alarm is available only with Panoptix FrontVü transducers.

**Water Temp.:** Sets an alarm to sound when the transducer reports a temperature that is 2°F (1.1°C) above or below the specified temperature.

**Contour:** Sets an alarm to sound when the transducer detects a suspended target within the specified depth from the surface of the water and from the bottom.

#### Fish

**Fish:** Sets an alarm to sound when the device detects a suspended target.

-  sets the alarm to sound when fish of all sizes are detected.
-  sets the alarm to sound only when medium or large fish are detected.
-  sets the alarm to sound only when large fish are detected.

### Advanced Sonar Settings

From a Traditional sonar view, select **Menu > Sonar Setup > Advanced**.

**Shift:** Allows you to set the depth range on which the sonar is focused. This allows you to zoom in a higher resolution in the focused depth.

When using shift, bottom tracking may not work effectively, because the sonar looks for data within the depth range of the focused area, which may not include the bottom. Using shift also can impact the scroll speed, because data outside the depth range of the focused area is not processed, which reduces the time required to receive and display the data. You can zoom in to the focused area, which enables you to evaluate target returns more closely at a higher resolution than just zooming alone.

**Btm. Srch. Limit:** Limits the search for the bottom to the depth selected when the Range setting is set to Auto. To minimize the length of time it takes to find the bottom, you can select a depth to limit the search for the bottom. The device will not search for the bottom deeper than the selected depth.

### Traditional, Garmin ClearVü, and SideVü Transducer Installation Settings

From a Traditional, Garmin ClearVü, or SideVü sonar view, select **Menu > Sonar Setup > Installation**.

**Transmit Rate:** Sets the length of time between sonar pings. Increasing the transmit rate increases the scroll speed, but it may also increase self-interference.

Reducing the transmit rate increases the spacing between transmit pulses and can resolve self-interference. This option is available on the Traditional sonar view only.

**Transmit Power:** Reduces transducer ringing near the surface. A lower transmit power value reduces transducer ringing, but can also reduce the strength of the returns. This option is available on the Traditional sonar view only.

**Filter Width:** Defines the edges of the target. A shorter filter more clearly defines the edges of the targets but may allow more noise. A longer filter creates softer target edges and may also reduce noise. This option is available on the Traditional sonar view only.

**Flip Left/Right:** Switches the SideVü view orientation from left to right. This option is available on the SideVü sonar view only.

**Restore Sonar Defaults:** Restores the sonar settings to the factory default values.

Allows you to change the transducer, view details about the transducers, and save details to a memory card.

### Sonar Frequencies

**NOTE:** The frequencies available depend on the device and transducers being used.

Adjusting the frequency helps adapt the sonar for your particular goals and the present depth of the water.

Higher frequencies use narrow beam widths, and are better for high-speed operation and rough sea conditions. Bottom definition and thermocline definition can be better when using a higher frequency.

Lower frequencies use wider beam widths, which can let the fisherman see more targets, but could also generate more surface noise and reduce bottom signal continuity during rough sea conditions. Wider beam widths generate larger arches for fish target returns, making them ideal for locating fish. Wider beam widths also perform better in deep water, because the lower frequency has better deep water penetration.

CHIRP frequencies allow you to sweep each pulse through a range of frequencies, resulting in better target separation in deep water. CHIRP can be used to distinctly identify targets, like individual fish in a school, and for deep water applications. CHIRP generally performs better than single frequency applications. Because some fish targets may show up better using a fixed frequency, you should consider your goals and water conditions when using CHIRP frequencies.

Some transducers also provide the ability to customize preset frequencies for each transducer element, which enables you to change the frequency quickly using the presets as the water and your goals change.

Viewing two frequencies concurrently using the split-frequency view allows you to see deeper with the lower frequency return and, at the same time, see more detail from the higher frequency return.

#### NOTICE

Always be aware of local regulations on sonar frequencies. For example, to protect orca whale pods, you might be prohibited from using frequencies between 50 to 80 khz with in ½ mile of an orca whale pod. It is your responsibility to use the device in compliance with all applicable laws and ordinances.

### Selecting the Transducer Frequency

**NOTE:** You cannot adjust the frequency for all sonar views and transducers.

You can select which frequencies appear on the sonar screen.

#### NOTICE

Always be aware of local regulations on sonar frequencies. For example, to protect orca whale pods, you might be prohibited from using frequencies between 50 to 80 khz with in ½ mile of an orca whale pod. It is your responsibility to use the device in compliance with all applicable laws and ordinances.

- 1 From a sonar view, select **Menu > Frequency**.
- 2 Select a frequency suited to your needs and water depth.  
For more information on frequencies, see [Sonar Frequencies, page 31](#).

### Creating a Frequency Preset

**NOTE:** Not available with all transducers.

You can create a preset to save a specific sonar frequency, which allows you to change frequencies quickly.

- 1 From a sonar view, select **Menu > Frequency**.
- 2 Select **Manage Frequencies > New Preset**.
- 3 Enter a frequency.

### Turning On the A-Scope

**NOTE:** This feature is available in the Traditional sonar views.

The a-scope is a vertical flasher along the right side of the view, showing you what is underneath the transducer right now. You can use the a-scope to identify target returns that may be missed when the sonar data is quickly scrolling across the screen, such as when your boat is moving at high speeds. It can also be helpful for detecting fish that are close to the bottom.

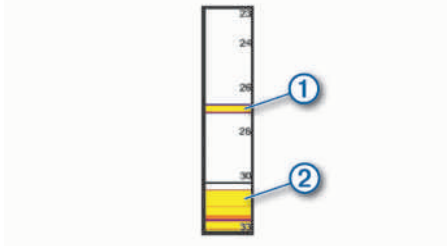

The a-scope above shows fish returns ① and a soft bottom return ②.

1 From a sonar view, select **Menu > Sonar Setup > Appearance > A-Scope > On**.

2 Select a hold time.

You can increase the hold time to increase the length of time the sonar returns are displayed.

## Panoptix Sonar Setup

### Zooming in a Panoptix LiveVü or LiveScope Sonar View

You can zoom in on the Panoptix LiveVü and LiveScope 2D sonar views.

**NOTE:** The scrolling history is hidden while the screen is in zoom mode.

1 From a Panoptix LiveVü or LiveScope 2D sonar view, spread two fingers apart to zoom in on the area.

An inset window ① appears and displays a small version of the full-screen image. The boxed area ② in the inset shows the location of the zoomed area.

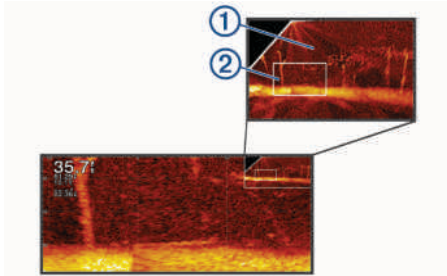

2 If necessary, tap or drag within the inset window to view a different area of the full-screen view.

3 If necessary, spread two fingers apart to zoom in.



4 If necessary, pinch two fingers together to zoom out.

To exit zoom mode, select Back or pinch two fingers together to zoom out until the screen returns to a full-screen view.

### Adjusting the RealVü Viewing Angle and Zoom Level

You can change the viewing angle of the RealVü sonar views. You can also zoom in and out of the view.

From a RealVü sonar view, select an option:

- To adjust the viewing angle diagonally, select .
- To adjust the viewing angle horizontally, select .
- To adjust the viewing angle vertically, select .
- To adjust the viewing angle, swipe the screen in any direction.
- To zoom in, spread two fingers apart.
- To zoom out, pinch two fingers together.

### Adjusting the RealVü Sweep Speed

You can update how quickly the transducer sweeps back and forth. A faster sweep rate creates a less detailed image, but the screen refreshes faster. A slower sweep rate creates a more detailed image, but the screen refreshes more slowly.

**NOTE:** This feature is not available for the RealVü 3D Historical sonar view.

1 From a RealVü sonar view, select **Menu > Sweep Speed**.

2 Select an option.

### LiveVü Forward and FrontVü Sonar Menu

From the LiveVü Forward or FrontVü sonar view, select Menu.

**Gain:** Controls the level of detail and noise shown on the sonar screen.

If you want to see the highest intensity signal returns on the screen, you can lower the gain to remove lower intensity returns and noise. If you want to see all return information, you can increase the gain to see more information on the screen. This also increases noise, and can make it more difficult to recognize actual returns.

**Depth Range:** Adjusts the range of the depth scale.

Allowing the device to adjust the range automatically keeps the bottom within the lower portion of the sonar screen, and can be useful for tracking a bottom that has minimal or moderate terrain changes.

Manually adjusting the range enables you to view a specified range, which can be useful for tracking a bottom that has large terrain changes, such as a drop-offs or cliffs. The bottom can appear on the screen as long as it appears within the range you have set.

**Forward Range:** Adjusts the range of the forward scale.

Allowing the device to adjust the range automatically adjusts the forward scale in relation to the depth. Manually adjusting the range enables you to view a specified range. The bottom can appear on the screen as long as it appears within the range you have set. Manually reducing this option can reduce the effectiveness of the FrontVü Alarm, reducing your reaction time to low depth readings.

**Transmit Angle:** Adjusts the focus of the transducer to the port or starboard side. This feature is available only with RealVü capable Panoptix transducers, such as the PS30, PS31, and PS60.

**Transmit:** Stops the active transducer from transmitting.

**FrontVü Alarm:** Sets an alarm to sound when the depth in front of the vessel is less than the specified value ([Setting the FrontVü Depth Alarm, page 33](#)). This is available only with Panoptix FrontVü transducers.

**Sonar Setup:** Adjusts the setup of the transducer and the appearance of the sonar returns.

**Edit Overlays:** Adjusts the data shown on the screen ([Customizing the Data Overlays, page 5](#)).

### Setting the LiveVü and FrontVü Transducer Transmit Angle

This feature is available only with RealVü capable Panoptix transducers, such as the PS30, PS31, and PS60.

You can change the transducer transmit angle to aim the transducer at a particular area of interest. For example, you might aim the transducer to follow a bait ball or focus on a tree as you pass it.

1 From a LiveVü or FrontVü sonar view, select **Menu > Transmit Angle**.

2 Select an option.



## Setting the FrontVü Depth Alarm

### WARNING

The FrontVü depth alarm is a tool for situational awareness only, and may not prevent groundings in all circumstances. It is the obligation of the vessel operator to ensure safe operation of the vessel.

This alarm is available only with Panoptix FrontVü transducers.

You can set an alarm to sound when the depth is below a specified level. For best results, you should set the bow offset when using the front collision alarm ([Setting the Bow Offset](#), page 34).

- 1 From the FrontVü sonar view, select **Menu > FrontVü Alarm**.
- 2 Select **On**.
- 3 Enter the depth at which the alarm is triggered, and select **Done**.

On the FrontVü screen, a depth line shows the depth at which the alarm is set. The line is green when you are in a safe depth. The line turns yellow when you are going faster than the forward range gives you time to react (10 seconds). It turns red and sounds an alarm when the system detects an obstruction or the depth is less than the entered value.

### CAUTION

The ability to effectively avoid running aground with FrontVü sonar decreases as your speed rises above 8 knots.

## LiveVü and FrontVü Appearance Settings

From a LiveVü or FrontVü Panoptix sonar view, select **Menu > Sonar Setup > Appearance**.

**Color Scheme:** Sets the color palette.

**Color Gain:** Adjusts the intensity of colors shown on the screen.

You can select a higher color gain value to see targets higher in the water column. A higher color gain value also allow you to differentiate low intensity returns higher in the water column, but this causes a loss in the differentiation of the returns at the bottom. You can select a lower color gain value when targets are near the bottom, to help you distinguish between targets and high intensity returns such as sand, rock, and mud.

**Trails:** Sets the how long the trails appear on the screen. The trails show the movement of the target.

**Bottom Fill:** Colors the bottom brown to distinguish it from the water returns.

**Grid Overlay:** Shows a grid of range lines.

**Scroll History:** Shows the sonar history in a traditional sonar view.

## RealVü Appearance Settings

From a RealVü sonar view, select **Menu > Sonar Setup > Appearance**.

**Point Colors:** Sets a different color palette for the sonar return points.

**Bottom Colors:** Sets the color scheme for the bottom.

**Bottom Style:** Sets the style for the bottom. When you are in deep water, you can select the Points option and manually set the range to a shallower value.

**Color Key:** Shows a legend of the depths the colors represent.

## LiveScope and Perspective Sonar Menu

From the LiveScope or Perspective sonar view, select **Menu**.

**Gain:** Controls the level of detail and noise shown on the sonar screen.

If you want to see the highest intensity signal returns on the screen, you can lower the gain to remove lower intensity

returns and noise. If you want to see all return information, you can increase the gain to see more information on the screen. Increasing the gain also increases noise, and can make it more difficult to recognize actual returns.

**Depth Range:** Adjusts the range of the depth scale.

Allowing the device to adjust the range automatically keeps the bottom within the lower portion of the sonar screen, and can be useful for tracking a bottom that has minimal or moderate terrain changes.

Manually adjusting the range enables you to view a specified range, which can be useful for tracking a bottom that has large terrain changes, such as a drop-offs or cliffs. The bottom can appear on the screen as long as it appears within the range you have set.

Available in LiveScope sonar view.

**Forward Range:** Adjusts the range of the forward scale.

Allowing the device to adjust the range automatically adjusts the forward scale in relation to the depth. Manually adjusting the range enables you to view a specified range. The bottom can appear on the screen as long as it appears within the range you have set.

Available in LiveScope sonar view.

**Range:** Adjust the range.

Allowing the device to adjust the range automatically keeps the bottom within the lower or outer third of the sonar screen, and can be useful for tracking a bottom that has minimal or moderate terrain changes.

Manually adjusting the range enables you to view a specified range, which can be useful for tracking a bottom that has large terrain changes, such as a drop-offs or cliffs. The bottom can appear on the screen as long as it appears within the range you have set.

Available in Perspective sonar view.

**Transmit:** Stops the active transducer from transmitting.

**Sonar Setup:** Adjusts the setup of the transducer and the appearance of the sonar returns ([LiveScope and Perspective Sonar Setup](#), page 33).

**Edit Overlays:** Adjusts the data shown on the screen ([Customizing the Data Overlays](#), page 5).

## LiveScope and Perspective Sonar Setup

From the LiveScope or Perspective sonar view, select **Menu > Sonar Setup**.

**Appearance:** Configures the appearance of the sonar screen ([LiveScope and Perspective Appearance Settings](#), page 34).

**Noise Reject:** Reduces noise and interference and attempts to remove returns that are not actually targets in the water.

**Ghost Reject:** Reduces the occurrence of "ghost" images, which are duplicated or reflected images that are not actually targets in the water. "Ghost" images are caused by strong sonar returns, such as the bottom. Shallow water and hard bottoms generally have stronger returns and may cause "ghost" images to occur more obviously.

Adjusting the Ghost Reject and Noise Reject settings together reduces the occurrence of "ghost" images most effectively.

**TVG:** Adjusts the time varying gain, which can reduce noise.

This control is best used for situations when you want to control and suppress clutter or noise near the water surface. It also allows for the display of targets near the surface that are otherwise hidden or masked by surface noise.

**Overlay Data:** Sets the data shown on the sonar screen.

**Installation:** Configures the transducer (*Traditional, Garmin ClearVü, and SideVü Transducer Installation Settings, page 31*).

### LiveScope and Perspective Appearance Settings

From the LiveScope or Perspective sonar view, select **Menu > Sonar Setup > Appearance**.

**Color Scheme:** Sets the color palette.

**Color Gain:** Adjusts the contrast of colors shown on the screen.

You can select a higher color gain value to see minor variances in targets with large color changes. You can select a lower color gain value to see more similar colors in the same situation.

**Trails:** Sets the how long the trails appear on the screen. The trails show the movement of the target.

**Bottom Fill:** Colors the bottom brown to distinguish it from the water returns. Not available in Perspective mode.

**Grid Overlay:** Shows or hides grids of range lines. The Grid option shows a square grid. The Radial option shows a circular grid with radial angle lines.

**Scroll History:** Shows the sonar history on the side of the screen. Not available in Perspective mode.

**Boat Icon:** Shows or hides the icon of the boat in the upper-right corner.

### Panoptix Transducer Installation Settings

From a Panoptix sonar view, select **Menu > Sonar Setup > Installation**.

**Install Depth:** Sets the depth below the water line where the Panoptix transducer is mounted. Entering the actual depth at which the transducer is mounted results in a more accurate visual presentation of what is in the water.

**Bow Offset:** Sets the distance between the bow and the forward view Panoptix transducer installation location. This allows you to view the forward distance from the bow instead of the transducer location.

This applies to Panoptix transducers in the FrontVü, LiveVü Forward, and RealVü 3D Forward sonar views.

**Beam Width:** Sets the width of the down view Panoptix transducer beam. Narrow beam widths allow you to see deeper and farther. Wider beam widths allow you to see more coverage area.

This applies to Panoptix transducers in the FrontVü, LiveVü Down, and LiveVü Forward sonar views.

**Use AHRS:** Enables the internal attitude heading and reference system (AHRS) sensors to detect the installation angle of the Panoptix transducer automatically. When this setting is turned off, you can enter the specific installation angle for the transducer using the Pitch Angle setting. Many forward view transducers are installed at a 45-degree angle and down view transducers are installed at a zero-degree angle.

**Flipped:** Sets the orientation of the Panoptix sonar view when the down view transducer is installed with the cables pointing toward the port side of the boat.

This applies to Panoptix transducers in the LiveVü Down, RealVü 3D Down, and RealVü 3D Historical sonar views.

**Calibrate Compass:** Calibrates the internal compass in the Panoptix transducer (*Calibrating the Compass, page 34*).

This applies to Panoptix transducers with an internal compass, such as the PS21-TR transducer.

**Orientation:** Controls if the transducer is in down or forward installation mode. The Auto setting uses the AHRS sensor to determine the orientation.

This applies to PS22 and LiveScope transducers.

**Focus:** Adjusts the sonar view to compensate for the speed of sound in water. The Auto setting uses the temperature of the water to calculate the speed of sound.

This applies to LiveScope transducers.

**Restore Sonar Defaults:** Restores the sonar settings to the factory default values.

### Setting the Bow Offset

For forward view Panoptix transducers, you can enter a bow offset to compensate the forward distance readings for the transducer installation location. This allows you to view the forward distance from the bow instead of the transducer installation location.

This feature applies to Panoptix transducers in the FrontVü, LiveVü Forward, and RealVü 3D Forward sonar views.

- 1 Measure the horizontal distance ① from the transducer to the bow.

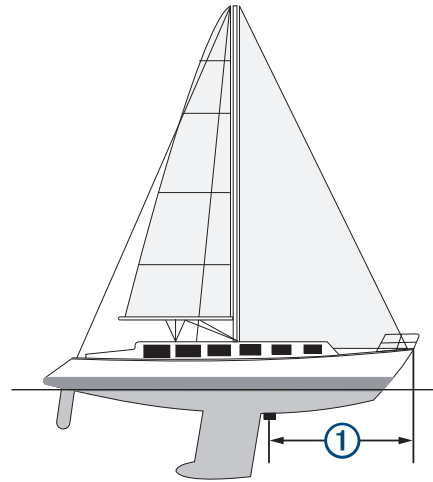

- 2 From an applicable sonar view, select **Menu > Sonar Setup > Installation > Bow Offset**.

- 3 Enter the distance measured, and select **Done**.

On the applicable sonar view, the forward range shifts by the distance you entered.

### Calibrating the Compass

Before you can calibrate the compass, the transducer must be installed on the shaft far enough away from the trolling motor to avoid magnetic interference, and deployed in the water. Calibration must be of sufficient quality to enable the internal compass.

**NOTE:** To use the compass, you must mount the transducer on the transom or the trolling motor shaft. The compass may not work when you mount the transducer on the motor.

**NOTE:** For best results, you should use a heading sensor such as the SteadyCast™ heading sensor. The heading sensor shows the direction the transducer is pointing relative to the boat.

**NOTE:** Compass calibration is available only for transducers with an internal compass, such as the PS21-TR transducer.

You can begin turning your boat before calibrating, but you must fully rotate your boat 1.5 times during calibration.

- 1 From an applicable sonar view, select **Menu > Sonar Setup > Installation**.
- 2 If necessary, select **Use AHRS** to turn on the AHRS sensor.
- 3 Select **Calibrate Compass**.
- 4 Follow the on-screen instructions.

# Radar

## ⚠ WARNING

The marine radar transmits microwave energy that has the potential to be harmful to humans and animals. Before beginning radar transmission, verify that the area around the radar is clear. The radar transmits a beam approximately 12° above and below a line extending horizontally from the center of the radar.

To avoid possible personal injury, do not look directly at the antenna at close range when the radar is transmitting. Eyes are the most sensitive part of the body to electromagnetic energy.

When you connect your compatible chartplotter to an optional Garmin marine radar, such as a GMR™ Fantom™ 6 radar or a GMR 24 xHD, you can view more information about your surroundings.

The radar transmits a narrow beam of microwave energy as it rotates to a 360° pattern. When the transmitted energy contacts a target, some of that energy is reflected back to the radar.

## Radar Interpretation

Reading and interpreting the radar display takes practice. The more you use the radar, the better you will become at relying on the radar display when you really need it.

Radar can be useful in many situations, such as avoiding collisions when you have limited visibility, for example when it is dark or foggy, tracking weather, seeing what is ahead of you, and locating birds and fish.

The radar overlay feature can help you interpret the radar display more easily, because it overlays the radar returns on top of the chart. This can help you identify the difference between a radar return of a land mass, bridge, or rain cloud. Showing the AIS vessels on the radar overlay can also help you identify features on the radar display.

In the screenshot below, the radar overlay is turned on. This screen also shows a video feed. We can easily identify a few items on the radar screen.

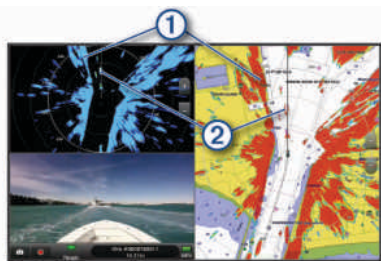

①	Land
②	Vessel

## Radar Overlay

When you connect your chartplotter to an optional Garmin marine radar, you can use overlay radar information on the Navigation chart or on the Fishing chart.

Data appears on the radar overlay based on the most recently used radar mode and all settings configurations applied to the radar overlay are also applied to the last-used radar mode.

## Radar Overlay and Chart Data Alignment

When using the Radar overlay, the chartplotter aligns radar data with chart data based on the boat heading, which is based by default on data from a magnetic heading sensor connected using a NMEA 0183 or NMEA 2000 network. If a heading sensor is not available, the boat heading is based on GPS tracking data.

GPS tracking data indicates the direction in which the boat is moving, not the direction in which the boat is pointing. If the boat

is drifting backward or sideways due to a current or wind, the Radar overlay may not perfectly align with the chart data. This situation should be avoided by using boat-heading data from an electronic compass.

If the boat heading is based on data from a magnetic heading sensor or an automatic pilot, the heading data could be compromised due to incorrect setup, mechanical malfunction, magnetic interference, or other factors. If the heading data is compromised, the Radar overlay may not align perfectly with the chart data.

## Transmitting Radar Signals

**NOTE:** As a safety feature, the radar enters standby mode after it warms up. This gives you an opportunity to verify the area around the radar is clear before beginning radar transmission.

- 1 With the chartplotter off, connect your radar as described in the radar installation instructions.
- 2 Turn on the chartplotter.  
If necessary, the radar warms up and a countdown alerts you when the radar is ready.
- 3 Select **Radar**.
- 4 Select a radar mode.  
A countdown message appears while the radar is starting up.
- 5 Select **Menu > Transmit Radar**.

## Stopping the Transmission of Radar Signals

From a radar screen, select **Menu > Radar To Standby**.

**TIP:** Press **⏻ > Radar To Standby** from any screen to quickly stop radar transmission.

## Setting Up the Timed Transmit Mode

To help conserve power, you can set up time intervals in which the radar will transmit and not transmit (standby) signal transmissions.

**NOTE:** This feature is not available in dual radar modes.

- 1 From a radar screen, select **Menu > Radar Options > Timed Transmit**.
- 2 Select **Timed Transmit** to enable the option.
- 3 Select **Stdby Time**, enter the time interval between radar signal transmissions, and select **Done**.
- 4 Select **Transmit Time**, enter the duration of each radar signal transmission, and select **Done**.

## Enabling and Adjusting a Radar No Transmit Zone

You can indicate areas within which the radar scanner does not transmit signals.

**NOTE:** GMR Fantom and xHD2 radar models support two no-transmit zones. Most other GMR radar models support one no-transmit zone. GMR 18 HD+ radar models do not support no-transmit zones.

- 1 From a radar screen, select **Menu > Radar Setup > Installation > No Transmit Zone**.  
The no-transmit zone is indicated by a shaded area on the radar screen.
- 2 Select **Angle 1**, and select the new location for the first angle.
- 3 Select **Angle 2**, and select the new location for the second angle.
- 4 Select **Done**.
- 5 If necessary, repeat for the second zone.

## Adjusting the Radar Range

The range of the radar signal indicates the length of the pulsed signal transmitted and received by the radar. As the range increases, the radar transmits longer pulses in order to reach

distant targets. Closer targets, especially rain and waves, also reflect the longer pulses, which can add noise to the Radar screen. Viewing information about longer-range targets can also decrease the amount of space available on the Radar screen for viewing information about shorter-range targets.

- Select **+** to decrease the range.
- Select **-** to increase the range.

### Tips for Selecting a Radar Range

- Determine what information you need to see on the Radar screen.  
For example, do you need information about nearby weather conditions or targets and traffic, or are you more concerned about distant weather conditions?
- Assess the environmental conditions where the radar is being used.  
Especially in inclement weather, longer-range radar signals can increase the clutter on the Radar screen and make it more difficult to view information about shorter-range targets. In rain, shorter-range radar signals can enable you to view information about nearby objects more effectively, if the rain clutter setting is configured optimally.
- Select the shortest effective range, given your reason for using radar and the present environmental conditions.

## MotionScope™ Doppler Radar Technology

The GMR Phantom radar uses the Doppler effect to detect and highlight moving targets to help you avoid potential collisions, find flocks of birds, and track weather formations. The Doppler effect is the frequency shift in the radar echo due to the relative motion of the target. This allows for instant detection of any targets moving toward or away from the radar.

The MotionScope feature highlights the moving targets on the radar display so you can navigate around other boats or severe weather, or toward fishing spots where birds are feeding at the surface.

The moving targets are color-coded so you can tell at a glance which targets are moving toward or away from you. On most color schemes, green indicates the target is moving away from you and red indicates the target is moving toward you.

On some models, you can also adjust the M-Scope Sensitivity setting to change the speed threshold for target highlighting. A higher setting highlights slower targets, and a lower setting highlights only faster targets.

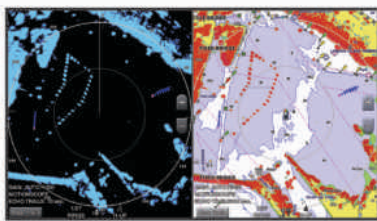

## Enabling a Guard Zone

You can enable a guard zone to alert you when anything comes within a specified area around your boat.

From a radar screen, select **Menu > Radar Options > Guard Zone**.

### Defining a Circular Guard Zone

Before you can define the boundaries of the guard zone, you must enable a guard zone ([Enabling a Guard Zone, page 36](#)).

You can define a circular guard zone that completely surrounds your boat.

- 1 From a radar screen, select **Menu > Radar Options > Guard Zone > > Circle**.

- 2 Select the location of the outer guard zone circle.
- 3 Select the location of the inner guard zone circle to define the width of the guard zone.

### Defining a Partial Guard Zone

Before you can define the boundaries of the guard zone, you must enable a guard zone ([Enabling a Guard Zone, page 36](#)).

You can define the boundaries of a guard zone that does not completely surround your boat.

- 1 From a radar screen, select **Menu > Radar Options > Guard Zone > > Corner 1**.
- 2 Touch and drag the location of the outer guard-zone corner ①.



- 3 Select **Corner 2**.
- 4 Select the location of the inner guard-zone corner ② to define the width of the guard zone.
- 5 Select **Done**.

## MARPA

Mini-automatic radar plotting aid (MARPA) enables you to identify and track targets and is primarily used for collision avoidance. To use MARPA, you assign a MARPA tag to a target. The radar system automatically tracks the tagged object and provides you with information about the object, including the range, bearing, speed, GPS heading, nearest approach, and time to nearest approach. MARPA indicates the status of each tagged object (acquiring, lost, tracking, or dangerous), and the chartplotter can sound a collision alarm if the object enters your safe zone.

Before you can use MARPA, you must have a heading sensor connected and an active GPS signal. The heading sensor must provide the NMEA 2000 parameter group number (PGN) 127250 or the NMEA 0183 HDM or HDG output sentence.

### MARPA Targeting Symbols

	Acquiring a target. Concentric, dashed green rings radiate from the target while the radar is locking onto it.
	Target has been acquired. A solid green ring indicates the location of a target that the radar has locked onto. A dashed green line attached to the circle indicates the projected course over ground or the GPS heading of the target.
	Dangerous target is in range. A red ring flashes from the target while an alarm sounds and a message banner appears. After the alarm has been acknowledged, a solid red dot with a dashed red line attached to it indicates the location and the projected course over ground or the GPS heading of the target. If the safe-zone collision alarm has been set to Off, the target flashes, but the audible alarm does not sound and the alarm banner does not appear.
	Target has been lost. A solid green ring with an X through it indicates that the radar could not lock onto the target.
	Closest point of approach and time to closest point of approach to a dangerous target.

### Acquiring MARPA Targets Automatically

You can acquire MARPA targets automatically based on MotionScope, guard zones, or boundaries.

- 1 From a radar screen, select **Menu > Layers > Other Vessels > MARPA > Auto Acquire**.
- 2 Select **➤**, and adjust additional settings (optional).

### Assigning a MARPA Tag to an Object

Before you can use MARPA, you must have a heading sensor connected and an active GPS signal. The heading sensor must provide the NMEA 2000 parameter group number (PGN) 127250 or the NMEA 0183 HDM or HDG output sentence.

- 1 From a radar screen, select an object or location.
- 2 Select **Acquire Tgt. > MARPA Target**.

### Removing a MARPA Tag from a Targeted Object

- 1 From the Radar screen, select a MARPA target.
- 2 Select **MARPA Target > Remove**.

### Viewing Information about a MARPA-tagged Object

You can view the range, bearing, speed, and other information about a MARPA-tagged object.

- 1 From a radar screen, select a targeted object.
- 2 Select **MARPA Target**.

### Viewing a List of AIS and MARPA Threats

From any Radar screen or the Radar overlay, you can view and customize the appearance of a list of AIS and MARPA threats.

- 1 From a Radar screen, select **Menu > Layers > Other Vessels**.
- 2 Select an option:
  - To view a list of AIS threats, select **AIS > AIS List**.
  - To view a list of MARPA threats, select **MARPA > MARPA List**.
- 3 If necessary, select **Display Options > Show**, and select the type of threats to include in the list.

### Showing AIS Vessels on the Radar Screen

AIS requires the use of an external AIS device and active transponder signals from other vessels.

You can configure how other vessels appear on the Radar screen. If any setting (except the AIS display range) is configured for one radar mode, the setting is applied to every other radar mode. The details and projected heading settings configured for one radar mode are applied to every other radar mode and to the Radar overlay.

- 1 From a Radar screen or the Radar overlay, select **Menu > Layers > Other Vessels > AIS**.
- 2 Select an option:
  - To indicate the distance from your location within which AIS vessels appear, select **Display Range**, and select a distance.
  - To show details about AIS-activated vessels, select **Details > Show**.
  - To set the projected heading time for AIS-activated vessels, select **Proj. Heading**, and enter the time.

### VRM and EBL

The variable range marker (VRM) and the electronic bearing line (EBL) measure the distance and bearing from your boat to a target object. On the Radar screen, the VRM appears as a circle that is centered on the present location of your boat, and the EBL appears as a line that begins at the present location of your boat and intersects the VRM. The point of intersection is the target of the VRM and the EBL.

### Showing and Adjusting the VRM and the EBL

You can adjust the diameter of the VRM and the angle of the EBL, which moves the intersection point of the VRM and the EBL. The VRM and the EBL configured for one mode are applied to all other radar modes.

- 1 From a radar screen, select **Menu > Radar Options > VRM/EBL**.
- 2 To adjust the VRM/EBL, select the arrows on the **VRM/EBL** button.
- 3 Select a new location for the intersection point of the VRM and the EBL.
- 4 Select **Done**.

### Measuring the Range and Bearing to a Target Object

Before you can adjust the VRM and the EBL, you must show them on the Radar screen ([Showing and Adjusting the VRM and the EBL](#), page 37).

- 1 From a Radar screen, select the target location.
- 2 Select **Measure**.

The range and the bearing to the target location appear in the upper-left corner of the screen.

### Echo Trails

The echo trails feature enables you to track the movement of vessels on the radar display. As a vessel moves, you can see a faint trail ① of the vessel's wake. You can change the length of time the trail is displayed.

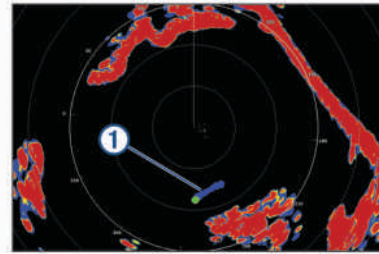

**NOTE:** Depending upon the radar in use, the settings configured for use in one radar mode may or may not be applied to other radar modes or to the radar overlay.

**NOTE:** This feature is not available on xHD open array or HD/HD+ radome models.

### Turning on Echo Trails

From a radar screen, select **Menu > Radar Options > Echo Trails > Display**.

### Adjusting the Length of the Echo Trails

- 1 From a radar screen or the radar overlay, select **Menu > Radar Options > Echo Trails > Time**.
- 2 Select the length of the trail.

### Clearing the Echo Trails

You can remove the echo trails from the radar screen to reduce the clutter on the screen.

From a radar screen, select **Menu > Radar Options > Echo Trails > Clear Trails**.

### Radar Settings

**NOTE:** Not all options and settings are available on all radar and chartplotter models.

**NOTE:** You can optimize the radar display for each radar mode.

### Radar Gain

#### Adjusting Gain on the Radar Screen Automatically

The automatic gain setting for each radar mode is optimized for that mode, and may differ from the automatic gain setting used for another mode.

**NOTE:** Depending upon the radar in use, the gain setting configured for use in one radar mode may or may not be applied to other radar modes or to the Radar overlay.

**NOTE:** Not all options are available on all radar models.

- 1 From a radar screen or the radar overlay, select **Menu > Gain**.
- 2 Select an option:
  - To adjust the gain automatically for changing conditions, select **Auto Low** or **Auto High**.
  - To adjust the gain automatically to show birds over the surface of the water, select **Auto Bird**.

**NOTE:** This option is not available on xHD open array or HD/HD+ radome models.

### **Adjusting Gain on the Radar Screen Manually**

For optimal radar performance, you can manually adjust the gain.

**NOTE:** Depending upon the radar in use, the gain setting configured for use in one radar mode may or may not be applied to other radar modes or to the Radar overlay.

- 1 From a Radar screen or the Radar overlay, select **Menu > Gain**.
- 2 Select **Up** to raise the gain, until light speckles appear across the Radar screen.
 

Data on the Radar screen is refreshed every few seconds. As a result, the effects of manually adjusting the gain may not appear instantly. Adjust the gain slowly.
- 3 Select **Down** to lower the gain until the speckles disappear.
- 4 If boats, land, or other targets are within range, select **Down** to lower the gain until the targets begin to blink.
- 5 Select **Up** to raise the gain until the boats, land, or other targets appear steadily lit on the Radar screen.
- 6 Minimize the appearance of nearby large objects, if necessary.
- 7 Minimize the appearance of side-lobe echoes, if necessary.

### **Minimizing Nearby Large-Object Interference**

Nearby targets of significant size, such as jetty walls, can cause a very bright image of the target to appear on the Radar screen. This image can obscure smaller targets located near it.

**NOTE:** Depending upon the radar in use, the gain setting configured for use in one radar mode may or may not be applied to other radar modes or to the Radar overlay.

- 1 From a Radar screen or the Radar overlay, select **Menu > Gain**.
- 2 Select **Down** to lower the gain until the smaller targets are clearly visible on the Radar screen.
 

Reducing the gain to eliminate nearby large-object interference may cause smaller or distant targets to blink or disappear from the Radar screen.

### **Minimizing Side-Lobe Interference on the Radar Screen**

Side-lobe interference may appear to streak outward from a target in a semi-circular pattern. Side-lobe effects can be avoided by reducing the gain or reducing the radar range.

**NOTE:** Depending upon the radar in use, the gain setting configured for use in one radar mode may or may not be applied to other radar modes or to the Radar overlay.

- 1 From a Radar screen or the Radar overlay, select **Menu > Gain**.
- 2 Select **Down** to lower the gain until the semi-circular, streaked pattern disappears from the Radar screen.
 

Reducing the gain to eliminate side-lobe interference may cause smaller or distant targets to blink or disappear from the Radar screen.

## **Radar Filter Settings**

### **Adjusting Sea Clutter on the Radar Screen**

You can adjust the appearance of clutter caused by choppy sea conditions. The sea clutter setting affects the appearance of

nearby clutter and targets more than it affects the appearance of distant clutter and targets. A higher sea clutter setting reduces the appearance of clutter caused by nearby waves, but it can also reduce or eliminate the appearance of nearby targets.

**NOTE:** Depending upon the radar in use, the sea clutter setting configured for use in one radar mode may or may not be applied to other radar modes or to the radar overlay.

**NOTE:** Not all options and settings are available on all radar and chartplotter models.

- 1 From a radar screen or the radar overlay, select **Menu > Radar Filters > Sea Clutter**.
- 2 Select an option:
  - Select an **Auto** option based on the sea conditions.
  - Select **Up** or **Down** to adjust the appearance of sea clutter until other targets are clearly visible on the radar screen. Select a setting that reflects the present sea conditions.

Clutter caused by sea conditions may still be visible.

When using a compatible radar model, the chartplotter adjusts the sea clutter based on the sea conditions automatically.

### **Adjusting Rain Clutter on the Radar Screen**

You can adjust the appearance of clutter caused by rain. Reducing the radar range also can minimize rain clutter ([Adjusting the Radar Range, page 35](#)).

The rain clutter setting affects the appearance of nearby rain clutter and targets more than it affects the appearance of distant rain clutter and targets. A higher rain clutter setting reduces the appearance of clutter caused by nearby rain, but it can also reduce or eliminate the appearance of nearby targets.

**NOTE:** Depending upon the radar in use, the rain clutter settings configured for use in one radar mode may or may not be applied to other radar modes or to the radar overlay.

- 1 From a radar screen, select **Menu > Radar Filters > Rain Clutter**.
- 2 Select **Up** or **Down** to decrease or increase the appearance of nearby rain clutter until other targets are clearly visible on the radar screen.
 

Clutter caused by rain may still be visible.

### **Averaging Multiple Scans on the Radar Screen**

You can average the results of multiple scans on the radar screen. This can be an effective method to filter out noise and enhances the detection of consistent targets. Averaging is most effective when using a longer range.

- 1 From a radar screen or the radar overlay, select **Menu > Radar Filters > Scan Average**.
- 2 Select an option.
 

The High setting filters out the most noise.

## **Radar Options Menu**

From a radar screen, select **Menu > Radar Options**.

**MotionScope™:** Uses the Doppler effect to detect and highlight moving targets to help you avoid potential collisions, find flocks of birds, and track weather formations ([MotionScope™ Doppler Radar Technology, page 36](#)). This option is only available on Fantom models.

**Pulse Exp.:** Increases the duration of the transmit pulse, which helps maximize the energy directed toward targets. This helps to enhance the detection and identification of targets. This option is only available on xHD radome and xHD2 open array models.

**Target Size:** Adjusts the size of targets, by adjusting the pulse compression processing. Select smaller targets for a sharp, high resolution radar image. Select larger targets to display larger echos for point targets, like boats and buoys. This option is only available on Fantom models.

**Echo Trails:** Enables you to track the movement of vessels on the radar screen. This option is not available on xHD open array or HD/HD+ radome models.

**VRM/EBL:** Shows the variable range marker (VRM) circle and the electronic bearing line (EBL) to allow you to measure the distance and bearing from your boat to a target object (*VRM and EBL, page 37*).

**Guard Zone:** Sets a safe zone around your boat and sounds an alarm when anything enters the zone (*Enabling a Guard Zone, page 36*).

**Timed Transmit:** Helps conserve power by transmitting radar signals at set intervals.

## Radar Setup Menu

From a radar screen, select **Menu > Radar Setup**.

**Source:** Selects the radar source when more than one radar is connected to the network.

**Chart Display:** Shows the chart under the radar image. When enabled, the Layers menu appears.

**Orientation:** Sets the perspective of the radar display.

**Crosstalk Rej.:** Reduces the appearance of clutter caused by interference from another nearby radar source.

**Rotation Spd.:** Sets the preferred speed at which the radar rotates. The High Speed option can be used to increase the refresh rate. In some situations, the radar automatically rotates at the normal speed to improve detection, for example, when a longer range is selected or when MotionScope or Dual range is used.

**Appearance:** Sets the color scheme, look-ahead speed, and navigation appearance.

**Installation:** Allows you to configure the radar for the installation, such as setting the front of the boat and the antenna park position.

### Reducing Cross Talk Clutter on the Radar Screen

You can reduce the appearance of clutter caused by interference from another nearby radar source, when the cross talk reject setting is on.

**NOTE:** Depending upon the radar in use, the cross talk reject setting configured for use in one radar mode may or may not be applied to other radar modes or to the Radar overlay.

From a Radar screen or the Radar overlay, select **Menu > Radar Setup > Crosstalk Rej.**

### Radar Appearance Settings

From a radar screen, select **Menu > Radar Setup > Appearance**.

**NOTE:** These settings do not apply to the radar overlay.

**Bkgd. Color:** Sets the color for the background.

**Frgd. Color:** Sets the color scheme for the radar returns.

**Brightness:** Sets the brightness of various radar features, such as range rings and tracking symbols.

**Look-Ahead Speed:** Shifts your present location toward the bottom of the screen automatically as your speed increases. Enter your top speed for the best results.

### Radar Installation Settings

**Front of Boat:** Compensates for the physical location of the radar when it is not on the boat axis (*Front-of-Boat Offset, page 39*).

**Antenna Configuration:** Sets the radar antenna size and sets the position in which the radar stops (*Setting a Custom Park Position, page 39*).

**No Transmit Zone:** Sets the area in which the radar does not transmit signals (*Enabling and Adjusting a Radar No Transmit Zone, page 35*).

### Front-of-Boat Offset

The front-of-boat offset compensates for the physical location of the radar scanner on a boat, if the radar scanner does not align with the bow-stern axis.

#### Measuring the Potential Front-of-Boat Offset

The front-of-boat offset compensates for the physical location of the radar scanner on a boat, if the radar scanner does not align with the bow-stern axis.

- 1 Using a magnetic compass, take an optical bearing of a stationary target located within viewable range.
- 2 Measure the target bearing on the radar.
- 3 If the bearing deviation is more than  $\pm 1^\circ$ , set the front-of-boat offset.

#### Setting the Front-of-Boat Offset

Before you can set the front-of-boat offset, you must measure the potential front-of-boat offset.

The front-of-boat offset setting configured for use in one radar mode is applied to every other radar mode and to the Radar overlay.

- 1 From a Radar screen or the Radar overlay, select **Menu > Radar Setup > Installation > Front of Boat**.
- 2 Select **Up** or **Down** to adjust the offset.

#### Setting a Custom Park Position

By default, the antenna is stopped perpendicular to the pedestal when it is not spinning. You can adjust this position.

- 1 From the radar screen, select **Menu > Radar Setup > Installation > Antenna Configuration > Park Position**.
- 2 Use the slider bar to adjust the position of the antenna when stopped, and select **Back**.

### Radar My Vessel Layer Settings

From a radar screen, select **Menu > Layers > My Vessel**.

**Heading Line:** Shows an extension from the bow of the boat in the direction of travel on the radar screen.

**Range Rings:** Shows the range rings that help you to visualize distances on the radar screen.

**Bearing Ring:** Shows a bearing relative to your heading or based on a north reference, to help you determine the bearing to an object shown on the radar screen.

### Selecting a Different Radar Source

- 1 Select an option:
  - From a radar screen or the radar overlay, select **Menu > Radar Setup > Source**.
  - Select **Settings > Communications > Preferred Sources > Radar**.
- 2 Select the radar source.

### Changing the Radar Mode

- 1 From a combination screen or SmartMode layout with radar, select **Menu > Radar Menu > Change Radar**.
- 2 Select a radar mode.

## Autopilot

### WARNING

You can use the autopilot feature only at a station installed next to a helm, throttle, and helm control device.

You are responsible for the safe and prudent operation of your vessel. The autopilot is a tool that enhances your capability to operate your boat. It does not relieve you of the responsibility of safely operating your boat. Avoid navigational hazards and never leave the helm unattended.

Always be prepared to promptly regain manual control of your boat.

Learn to operate the autopilot on calm and hazard-free open water.

Use caution when operating the autopilot near hazards in the water, such as docks, pilings, and other boats.

The autopilot system continuously adjusts the steering of your boat to maintain a constant heading (heading hold). The system also allows manual steering and several modes of automatic-steering functions and patterns.

When the chartplotter is connected to a compatible Garmin autopilot system, you can engage and control the autopilot from the chartplotter. For information about compatible Garmin autopilot systems, go to [garmin.com](http://garmin.com).

When the chartplotter is connected to a compatible Yamaha® autopilot system, you can control the autopilot from the chartplotter using the Yamaha autopilot screen and overlay bar (*Yamaha Autopilot*, page 42). For information about compatible Yamaha autopilot systems, contact your Yamaha dealer.

## Opening the Autopilot Screen

Before you can open the autopilot screen, you must have a compatible Garmin autopilot installed and configured.

Select **A/V, Gauges, Controls > Autopilot**.

## Autopilot Screen



①	Actual heading
②	Intended heading (heading the autopilot is steering toward)
③	Actual heading (when in standby mode) Intended heading (when engaged)
④	Rudder position indicator (This functionality is available only when a rudder sensor is connected.)

### Adjusting the Step Steering Increment

- From the Autopilot screen, select **Menu > Autopilot Setup > Step Turn Size**.
- Select an increment.

### Setting the Power Saver

You can adjust the level of rudder activity.

- From the autopilot screen, select **Menu > Autopilot Setup > Power Mode Setup > Power Saver**.
- Select a percentage.

Selecting a higher percentage reduces rudder activity and heading performance. The higher the percentage, the more the course deviates before the autopilot corrects it.

**TIP:** In choppy conditions at low speeds, increasing the Power Saver percentage reduces rudder activity.

### Enabling Shadow Drive™

**NOTE:** The Shadow Drive feature is not available on all autopilot models.

From the autopilot screen, select **Menu > Autopilot Setup > Shadow Drive > Enabled**.

## Selecting the Preferred Heading Source

### NOTICE

For best results, use the autopilot CCU internal compass for the heading source. Using a third-party GPS compass can cause the data to be delivered erratically and may result in excessive delays. The autopilot needs timely information, and therefore cannot often use third-party GPS compass data for GPS location or speed. If a third-party GPS compass is used, the autopilot will likely report loss of navigation data and speed source periodically.

If you have more than one heading source on the network, you can select a your preferred source. The source could be a compatible GPS compass or a magnetic heading sensor.

- From the autopilot screen, select **Menu > Autopilot Setup > Preferred Sources**
- Select a source.

If the selected heading source is unavailable, the autopilot screen does not display any data.

## Autopilot Overlay Bar

**NOTE:** Not all options are available on all autopilot models.



①	Autopilot mode
②	Enables the heading hold
③	Steers left
④	Actual heading
⑤	Rudder position indicator (available only when a rudder sensor is connected)
⑥	Intended heading (heading the autopilot is steering toward)
⑦	Steers right
⑧	Engages the steering pattern
⑨	Opens the full autopilot screen and menu

## Engaging the Autopilot

When you engage the autopilot, the autopilot takes control of the helm and steers the boat to maintain your heading.

From any screen, select **Engage**.

Your intended heading shows in the center of the Autopilot screen.

### Adjusting the Heading with the Helm

**NOTE:** You must enable the Shadow Drive feature before you can adjust the heading using the helm (*Enabling Shadow Drive™*, page 40).

With the autopilot engaged, manually steer the boat.

The autopilot activates Shadow Drive mode.

When you release the helm and manually maintain a specific heading for a few seconds, the autopilot resumes a heading hold at the new heading.

### Adjusting the Heading with the Chartplotter in Step Steering Mode

Before you can steer your boat using the keys at the bottom of the autopilot screen, you must engage the autopilot (*Engaging the Autopilot*, page 40).

- Select **<1° or 1°>** to initiate a single 1° turn.
  - Select **<<10° or 10°>>** to initiate a single 10° turn.
  - Hold **<1° or 1°>** to initiate a rate-controlled turn.
- The boat continues to turn until you let go of the key.



- Hold <<10° or 10°>> to initiate a sequence of 10° turns.

## Steering Patterns

### WARNING

You are responsible for the safe operation of your boat. Do not begin a pattern until you are certain that the water is clear of obstacles.

The autopilot can steer the boat in preset patterns for fishing, and it can also perform other specialty maneuvers such as U-turns and Williamson turns.

### Following the U-Turn Pattern

You can use the u-turn pattern to turn the boat around 180 degrees and maintain the new heading.

- 1 From the autopilot screen, select **Menu > Pattern Steering > U-Turn**.
- 2 Select **Engage Port** or **Engage Starboard**.

### Setting Up and Following the Circles Pattern

You can use the circles pattern to steer the boat in a continuous circle, in a specified direction, and at a specified time interval.

- 1 From the autopilot screen, select **Menu > Pattern Steering > Circles**.
- 2 If necessary, select **Time**, and select a time for the autopilot to steer one complete circle.
- 3 Select **Engage Port** or **Engage Starboard**.

### Setting Up and Following the Zigzag Pattern

You can use the zigzag pattern to steer the boat from port to starboard and back, over a specified time and angle, across your present heading.

- 1 From the autopilot screen, select **Menu > Pattern Steering > Zigzag**.
- 2 If necessary, select **Amplitude**, and select a degree.
- 3 If necessary, select **Period**, and select a length of time.
- 4 Select **Engage Zigzag**.

### Following the Williamson Turn Pattern

You can use the Williamson turn pattern to steer the boat around with the intent of running alongside the location where the Williamson turn pattern was initiated. The Williamson turn pattern can be used in man overboard situations.

- 1 From the autopilot screen, select **Menu > Pattern Steering > Williamson Turn**.
- 2 Select **Engage Port** or **Engage Starboard**.

### Following an Orbit Pattern

You can use the orbit pattern to steer the boat in a continuous circle around the active waypoint. The size of the circle is defined by your distance from the active waypoint when you begin the orbit pattern.

- 1 From the autopilot screen, select **Menu > Pattern Steering > Orbit**.
- 2 Select **Engage Port** or **Engage Starboard**.

### Setting Up and Following the Cloverleaf Pattern

You can use the cloverleaf pattern to steer the boat to repeatedly pass over an active waypoint. When you begin the cloverleaf pattern, the autopilot drives the boat toward the active waypoint and begins the cloverleaf pattern.

You can adjust the distance between the waypoint and the location where the autopilot turns the boat for another pass over the waypoint. The default setting turns the boat at a range of 1000 ft. (300 m) from the active waypoint.

- 1 From the autopilot screen, select **Menu > Pattern Steering > Cloverleaf**.

- 2 If necessary, select **Length**, and select a distance.

- 3 Select **Engage Port** or **Engage Starboard**.

### Setting Up and Following a Search Pattern

You can use the search pattern to steer the boat in increasingly larger circles outward from the active waypoint, forming a spiral pattern. When you begin the search pattern, the autopilot drives the boat to the active waypoint and begins the pattern.

You can adjust the distance between each circle in the spiral. The default distance between circles is 50 ft. (20 m).

- 1 From the autopilot screen, select **Menu > Pattern Steering > Search**.
- 2 If necessary, select **Search Spacing**, and select a distance.
- 3 Select **Engage Port** or **Engage Starboard**.

### Cancelling a Steering Pattern

- Physically steer the boat.  
**NOTE:** Shadow Drive must be enabled to cancel a steering pattern by physically steering the boat.
- Select ◀ or ▶ to cancel a pattern using step steering mode.
- Select **Standby**.

## Adjusting the Autopilot Response

The Response setting allows you to adjust the autopilot responsiveness for varying sea and wind conditions.

- 1 From the autopilot screen, select **Menu > Response**.
- 2 Adjust the rudder response.

If you need the rudder to be more responsive and move quicker, increase the value. If the rudder is moving too much, decrease the value.

## Enabling the Autopilot Controls on a Garmin Watch

You can control the Garmin autopilot with a compatible Garmin watch. Go to [garmin.com](http://garmin.com) for a list of compatible Garmin watches.

**NOTE:** Smart notifications are not available on your watch when the autopilot remote control is enabled.

- 1 Select **Communications > Wireless Devices > Connect IQ™ Apps > Autopilot Control > Enable > New Connection**.
- 2 Follow the on-screen instructions.

### Customizing the Autopilot Button Actions

Before you can set the autopilot button actions, you must install and configure a compatible Garmin autopilot.

You can select up to three autopilot actions for your Garmin watch to perform.

**NOTE:** Available autopilot actions depend on the autopilot installed.

- 1 On the chartplotter, select **Communications > Wireless Devices > Connect IQ™ Apps > Autopilot Control > Button Actions**.
- 2 Select a button.
- 3 Select an action.

## Controlling the Autopilot with a GRID 20 Remote Control

- Press the knob to change the mode.
- While in step steering mode, turn the knob to steer. Each turn of the knob produces a 1-degree step turn.
- While in autopilot response mode, turn the knob to adjust the **Response** setting.

- While in rudder steering mode, hold the joystick to the right or left to steer.

## Reactor™ Autopilot Remote Control

### ⚠ WARNING

You are responsible for the safe and prudent operation of your vessel. The autopilot is a tool that enhances your capability to operate your boat. It does not relieve you of the responsibility of safely operating your boat. Avoid navigational hazards and never leave the helm unattended.

You can wirelessly connect a Reactor autopilot remote control to the chartplotter to control the compatible Reactor autopilot system.

For more information about using the remote, see the Reactor autopilot remote control instructions at [garmin.com](http://garmin.com)

### Pairing a Reactor Autopilot Remote Control With a Chartplotter

- 1 Select **Settings > Communications > Wireless Devices > Wireless Remotes > Autopilot Remote**.
- 2 If necessary, select **Enable**.
- 3 Select **New Connection**.
- 4 On the remote control, select **Pair with MFD**.  
The chartplotter beeps and shows a confirmation message.
- 5 On the chartplotter, select **Yes** to complete the pairing process.

### Changing the Functions of the Reactor Autopilot Remote Control Action Keys

You can change the patterns or actions assigned to the Reactor autopilot remote control action keys.

- 1 Select **Settings > Communications > Wireless Devices > Wireless Remotes > Autopilot Remote > Button Actions**.
- 2 Select an action key to change.
- 3 Select a pattern or action to assign to the action key.

### Updating the Reactor Autopilot Remote Control Software

You can update the Reactor autopilot remote control software using the chartplotter.

- 1 Insert a memory card into the card slot on the computer.
- 2 Go to [buy.garmin.com/p/636376](http://buy.garmin.com/p/636376), and select **Software**.
- 3 Select **Download**.
- 4 Read and agree to the terms.
- 5 Select **Download**.
- 6 Choose a location, and select **Save**.
- 7 Double-click the downloaded file.
- 8 Select **Next**.
- 9 Select the drive associated with the memory card, and select **Next > Finish**.
- 10 On the chartplotter, insert the memory card into the card slot.
- 11 Select **Settings > Communications > Wireless Devices > Wireless Remotes > Autopilot Remote > Update Software**.

## Yamaha Autopilot

### ⚠ WARNING

You can use the autopilot feature only at a station installed next to a helm, throttle, and helm control device.

You are responsible for the safe and prudent operation of your vessel. The autopilot is a tool that enhances your capability to operate your boat. It does not relieve you of the responsibility of

safely operating your boat. Avoid navigational hazards and never leave the helm unattended.

Always be prepared to promptly regain manual control of your boat.

Learn to operate the autopilot on calm and hazard-free open water.

Use caution when operating the autopilot near hazards in the water, such as docks, pilings, and other boats.

The autopilot system continuously adjusts the steering of your boat to maintain a constant heading (heading hold).

When the chartplotter is connected to a compatible Yamaha autopilot system, you can view the autopilot information using the Yamaha autopilot screen and overlay bar. For information about compatible Yamaha autopilot systems, contact your Yamaha dealer.

### Yamaha Autopilot Screen

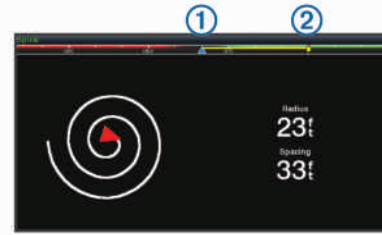

①	Actual heading
②	Intended heading (heading the autopilot is steering toward)

### Yamaha Autopilot Settings

From a Yamaha engine screen, select **Menu > Autopilot Setting**.

**Pattern Set:** Allows you to select an autopilot pattern.

**Direction:** Sets a port or starboard direction for the pattern.

**Spacing:** Sets the spacing for the pattern.

**Length:** Sets the length of the pattern.

**Amplitude:** Sets the angle for the zigzag pattern.

**Initial Radius:** Sets the radius of the spiral pattern.

**Final Track Point Mode:** Sets the mode for the autopilot when it reaches the end of a route. The FishPoint® option maintains the position, but does not maintain the heading. The DriftPoint® option allows the boat to drift with the wind or current while maintaining the selected heading, but does not maintain the position. The StayPoint® option maintains the position and the heading. The Deceleration option stops the motor, but does not maintain the position or heading. The No Deceleration option does not stop the motor.

**Course Hold Offset:** Sets a distance to navigate parallel to a route.

### Yamaha Autopilot Overlay Bar



①	Autopilot mode
②	Actual heading
③	Intended heading (heading the autopilot is steering toward)
④	Opens the full autopilot screen and menu

# Force® Trolling Motor Control

## ⚠ WARNING

Do not run the motor when the propeller is out of the water. Contact with the rotating propeller may result in severe injury.

Do not use the motor in areas where you or other people in the water may come into contact with the rotating propeller.

Always disconnect the motor from the battery before cleaning or servicing the propeller to avoid injury.

You are responsible for the safe and prudent operation of your vessel. The autopilot is a tool that enhances your capability to operate your boat. It does not relieve you of the responsibility of safely operating your boat. Avoid navigational hazards and never leave the helm unattended.

Learn to operate the autopilot on calm and hazard-free open water.

Use caution when operating the autopilot near hazards in the water, such as docks, pilings, and other boats.

## ⚠ CAUTION

When using the autopilot features, be prepared for sudden stops, acceleration, and turns.



When stowing or deploying the motor, be aware of the risk of entrapment or pinching from moving parts, which can result in injury.

When stowing or deploying the motor, be aware of slick surfaces around the motor. Slipping when stowing or deploying the motor may result in injury.

You can connect the Force trolling motor to the chartplotter to view and control the motor using the chartplotter.

## Connecting to a Trolling Motor

You can connect the chartplotter wirelessly to a compatible Garmin Force trolling motor on your boat to control the trolling motor from the chartplotter.

- 1 Turn on the chartplotter and the trolling motor.
- 2 Enable the Wi-Fi network on the chartplotter ([Setting Up the Wi-Fi Wireless Network, page 8](#)).
- 3 If multiple chartplotters are connected on the Garmin Marine Network, make sure this chartplotter is the host of the Wi-Fi network ([Changing the Wi-Fi Host, page 8](#)).
- 4 On the chartplotter, select **Settings > Communications > Wireless Devices > Garmin Trolling Motor**.
- 5 On the trolling motor display panel, press  three times to enter pairing mode.
  -  on the trolling motor display panel is solid blue as it searches for a connection to the chartplotter, and turns green when the connection is successful.

After the chartplotter and trolling motor connect successfully, enable the trolling motor overlay bar to control the motor ([Adding the Trolling Motor Controls to Screens, page 43](#)).

## Adding the Trolling Motor Controls to Screens

After you have connected the chartplotter to the Force trolling motor, you must add the trolling motor control bar to screens to control the trolling motor.

- 1 Open a screen from which you would like to control the trolling motor.
- 2 Select an option:
  - From a combination page or SmartMode layout, select **Menu > Edit > Overlays**.
  - From a full screen, select **Menu > Edit Overlays**.
- 3 Select **Top Bar** or **Bottom Bar**.

## 4 Select Trolling Motor Bar.











Repeat these steps to add the trolling motor controls to all of the screens from which you would like to control the trolling motor.

## Trolling Motor Control Bar

The trolling motor control bar allows you to control a Force trolling motor and see the status of the motor.

Select an item to engage it. The button illuminates when selected. Select the item again to disengage it.



	Trolling motor battery status.
	Turns the propeller on and off.
	Reduces the speed.
①	Speed indicator.
	Increases the speed.
	Enables the cruise control at the current speed over ground (SOG).
	Engages the propeller at full speed.
②	Trolling motor status.
	Enables anchor lock, which uses the trolling motor to hold your position.
	Steers the trolling motor. When in anchor lock, jogs the anchor lock position forward, backward, left, or right.
	Enables heading hold (set and maintain the current heading). When the trolling motor is in heading hold, an autopilot bar appears in the trolling motor bar.
	Opens the trolling motor settings.

## Trolling Motor Settings

From the trolling motor bar, select .

**Calibrate:** Calibrates the trolling motor compass ([Calibrating the Trolling Motor Compass, page 44](#)) and sets the trolling motor bow offset ([Setting the Bow Offset, page 44](#)).

**Anchor Gain:** Sets the response of the trolling motor when in anchor lock mode. If you need the trolling motor to be more responsive and move quicker, increase the value. If the motor is moving too much, decrease the value.

**Navigation Gain:** Sets the response of the trolling motor when navigating. If you need the trolling motor to be more responsive and move quicker, increase the value. If the motor is moving too much, decrease the value.

**Heading Hold Mode:** Sets the heading hold mode. The Vessel Align option attempts to keep the boat pointing in the same direction. The Go To option attempts to navigate a straight line in the requested direction.

**Arrival Mode:** Sets the behavior of the trolling motor when you reach the end of a route. With the Anchor Lock setting, the trolling motor holds the position using the anchor lock feature when the boat reaches the end of the route. With the Manual setting, the propeller turns off when the boat reaches the end of the route.

## ⚠ CAUTION

When using the Manual setting for the Arrival Mode option, you must be ready to take control of the boat.

**Auto Power On:** Turns on the trolling motor when you apply power to the system.

**Prop. Stow Side:** Sets which side of the trolling motor the propeller rotates to when stowing the trolling motor. This is helpful when you store other items near the stowed propeller.

**Shortcut Keys:** Enables the shortcut keys on the trolling motor remote control to work with this particular chartplotter. The keys work with only one chartplotter at a time.

**Restore Defaults:** Resets the trolling motor settings to the factory default values.

### Assigning a Shortcut to the Trolling Motor Remote Control Shortcut Keys

You can quickly open commonly used screens by assigning a shortcut key on the trolling motor remote control. You can create a shortcut to screens, such as sonar screens and charts.

**NOTE:** If you have more than one chartplotter on the network, you can assign shortcut keys to one chartplotter only.

- 1 Open a screen.
- 2 Hold a shortcut key.

**TIP:** The shortcut is also saved to the Favorites category with the shortcut key number.



### Calibrating the Trolling Motor Compass

You must calibrate the compass in the trolling motor before you can use the autopilot features.

- 1 Drive the boat to an open area of calm water.
- 2 From the trolling motor bar, select  > **Calibrate** > **Compass Cal.**
- 3 Follow the on-screen instructions.

### Setting the Bow Offset

Based on the installation angle, the trolling motor may not align with the center line of your boat. For the best results, you should set the bow offset.

- 1 Adjust the angle of the trolling motor  so it aligns with the center line of your boat , pointing straight forward.

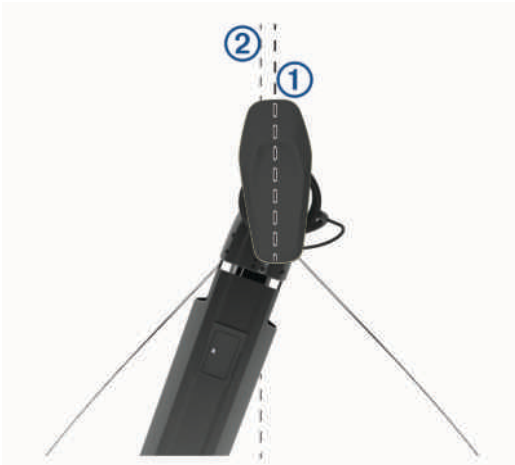

- 2 From the trolling motor bar, select  > **Calibrate** > **Bow Offset**.

## Digital Selective Calling

### Networked Chartplotter and VHF Radio Functionality

If you have a NMEA 0183 VHF radio or a NMEA 2000 VHF radio connected to your chartplotter, these features are enabled.

- The chartplotter can transfer your GPS position to your radio. If your radio is capable, GPS position information is transmitted with DSC calls.
- The chartplotter can receive digital selective calling (DSC) distress and position information from the radio.
- The chartplotter can track the positions of vessels sending position reports.

If you have a Garmin NMEA 2000 VHF radio connected to your chartplotter, these features are also enabled.

- The chartplotter allows you to quickly set up and send individual routine call details to your Garmin VHF radio.
- When you initiate a man-overboard distress call from your radio, the chartplotter shows the man-overboard screen and prompts you to navigate to the man-overboard point.
- When you initiate a man-overboard distress call from your chartplotter, the radio shows the Distress Call page to initiate a man-overboard distress call.

### Turning On DSC

Select **Settings** > **Other Vessels** > **DSC**.

### DSC List

The DSC list is a log of the most recent DSC calls and other DSC contacts you have entered. The DSC list can contain up to 100 entries. The DSC list shows the most recent call from a boat. If a second call is received from the same boat, it replaces the first call in the call list.

### Viewing the DSC List

Before you can view the DSC list, the chartplotter must be connected to a VHF radio that supports DSC.

Select **Info** > **DSC List**.

### Adding a DSC Contact

You can add a vessel to your DSC list. You can make calls to a DSC contact from the chartplotter.

- 1 Select **Info** > **DSC List** > **Add Contact**.
- 2 Enter the Maritime Mobile Service Identity (MMSI) of the vessel.
- 3 Enter the name of the vessel.

### Incoming Distress Calls

If your compatible chartplotter and VHF radio are connected using NMEA 0183 or NMEA 2000, your chartplotter alerts you when your VHF radio receives a DSC distress call. If position information was sent with the distress call, that information is also available and recorded with the call.

 designates a distress call in the DSC list and marks the position of the vessel on the Navigation chart at the time of the DSC distress call.

### Navigating to a Vessel in Distress

 designates a distress call in the DSC list and marks the position of a vessel on the Navigation chart at the time of the DSC distress call.

- 1 Select **Info** > **DSC List**.
- 2 Select a position-report call.
- 3 Select **Review** > **Navigate To**.
- 4 Select **Go To** or **Route To**.

### Man-Overboard Distress Calls Initiated from a VHF Radio

When the chartplotter is connected to a compatible VHF radio with NMEA 2000, and you initiate a man-overboard DSC distress call from the radio, the chartplotter shows the man-overboard screen and prompts you to navigate to the man-overboard point. If you have a compatible autopilot system connected to the network, the chartplotter prompts you to start a Williamson's turn to the man-overboard point.

If you cancel the man-overboard distress call on the radio, the chartplotter screen prompting you to activate navigation to the man-overboard location disappears.

## Man-Overboard and SOS Distress Calls Initiated from the Chartplotter

When your chartplotter is connected to a Garmin NMEA 2000 compatible radio and you mark an SOS or man-overboard location, the radio shows the Distress Call page so you can quickly initiate a distress call.

For information on placing distress calls from your radio, see the VHF radio owner's manual. For information about marking an MOB or SOS location, see [Marking an SOS Location, page 18](#).

## Position Tracking

When you connect the chartplotter to a VHF radio using NMEA 0183, you can track vessels that send position reports.

This feature is also available with NMEA 2000, when the vessel sends the correct PGN data (PGN 129808; DSC Call Information).

Every position report call received is logged in the DSC list ([DSC List, page 44](#)).

### Viewing a Position Report

- 1 Select **Info > DSC List**.
- 2 Select a position-report call.
- 3 Select **Review**.
- 4 Select an option:
  - To view the position report details, select **>**.
  - To view to a chart marking the location, select **<**.

### Navigating to a Tracked Vessel

- 1 Select **Info > DSC List**.
- 2 Select a position-report call.
- 3 Select **Review > Navigate To**.
- 4 Select **Go To** or **Route To**.

### Creating a Waypoint at the Position of a Tracked Vessel

- 1 Select **Info > DSC List**.
- 2 Select a position-report call.
- 3 Select **Review > Create Waypoint**.

### Editing Information in a Position Report

- 1 Select **Info > DSC List**.
- 2 Select a position-report call.
- 3 Select **Review > Edit**.
  - To enter the name of the vessel, select **Name**.
  - To select a new symbol, select **Symbol**, if available.
  - To enter a comment, select **Comment**.
  - To show a trail line for the vessel if your radio is tracking the position of the vessel, select **Trail**.
  - To select a color for the trail line, select **Trail Line**.

### Deleting a Position-Report Call

- 1 Select **Info > DSC List**.
- 2 Select a position-report call.
- 3 Select **Review > Clear Report**.

### Viewing Vessel Trails on the Chart

You can view trails for all tracked vessels on some chart views. By default, a black line indicates the path of the vessel, a black dot indicates each previously reported position of a tracked vessel, and a blue flag indicates the last reported position of the vessel.

- 1 From a chart or 3D chart view, select **Menu > Layers > Other Vessels > DSC > DSC Trails**.
- 2 Select the number of hours to show tracked vessels on the chart.

For example, if you select 4 Hours, all trail points that are less than four hours old appear for all tracked vessels.

## Individual Routine Calls

When you connect the chartplotter to a Garmin VHF radio, you can use the chartplotter interface to set up an individual routine call.

When setting up an individual routine call from your chartplotter, you can select the DSC channel on which you want to communicate. The radio transmits this request with your call.

### Selecting a DSC Channel

**NOTE:** The selection of a DSC channel is limited to those channels that are available in all frequency bands. The default channel is 72. If you select a different channel, the chartplotter uses that channel for subsequent calls until you call using another channel.

- 1 Select **Info > DSC List**.
- 2 Select a vessel or a station to call.
- 3 Select **Review > Call with Radio > Channel**.
- 4 Select an available channel.

### Making an Individual Routine Call

**NOTE:** When initiating a call from the chartplotter, if the radio does not have an MMSI number programmed, the radio will not receive call information.

- 1 Select **Info > DSC List**.
- 2 Select a vessel or a station to call.
- 3 Select **Review > Call with Radio**.
- 4 If necessary, select **Channel**, and select a new channel.
- 5 Select **Send**.

The chartplotter sends information about the call to the radio.

- 6 On your Garmin VHF radio, complete the call.

### Making an Individual Routine Call to an AIS Target

- 1 From a chart or 3D chart view, select an AIS target.
- 2 Select **AIS Vessel > Call with Radio**.
- 3 If necessary, select **Channel**, and select a new channel.
- 4 Select **Send**.

The chartplotter sends information about the call to the radio.

- 5 On your Garmin VHF radio, complete the call.

## Gauges and Graphs

The gauges and graphs provide various information about the engine and environment. To view the information, a compatible transducer or sensor must be connected to the network.

### Viewing the Gauges

- 1 Select **A/V, Gauges, Controls**.
- 2 Select a gauge.



- 3 Select **<** or **>** to view a different gauge page.

### Changing the Data Shown in a Gauge

- 1 From a gauges screen, hold a gauge.

- 2 Select **Replace Data**.
- 3 Select a data type.
- 4 Select the data to display.

### Customizing the Gauges

You can change the layout of the gauge pages, how the gauges pages are displayed, and the data in each gauge.

- 1 Open a gauge page.
- 2 Select **Menu > Edit Gauge Pages**.
- 3 Select an option:
  - To change the data shown in a gauge, select the gauge.
  - To change the layout of the gauges on the page, select **Change Layout**.
  - To add a page to this set of gauge pages, select **Add Page**.
  - To change the order of this page in the set of gauge pages, select **Move Page Left** or **Move Page Right**.
  - To restore this page to the original view, select **Restore Default View**.

### Customizing Engine Gauge and Fuel Gauge Limits

You can configure the upper and lower limits and the range of desired standard operation of a gauge.

**NOTE:** Not all options are available for all gauges.

- 1 From an applicable gauges screen, select **Menu > Installation > Set Gauge Limits**.
- 2 Select a gauge to customize.
- 3 Select an option:
  - To set the minimum value of the standard operating range, select **Rated Min..**
  - To set the maximum value of the standard operating range, select **Rated Max..**
  - To set the lower limit of the gauge lower than the rated minimum, select **Scale Min..**
  - To set the upper limit of the gauge higher than the rated maximum, select **Scale Max..**
- 4 Select the limit value.
- 5 Repeat steps 4 and 5 to set additional gauge limits.

### Selecting the Number of Engines Shown in Gauges

You can show information for up to four engines.

- 1 From the engine gauges screen, select **Menu > Installation > Engine Selection > Num. Engines**.
- 2 Select an option:
  - Select the number of engines.
  - Select **Auto Configure** to automatically detect the number of engines.

### Customizing the Engines Shown in Gauges

Before you can customize how the engines are shown in the gauges, you must manually select the number of engines ([Selecting the Number of Engines Shown in Gauges, page 46](#)).

- 1 From the engine gauges screen, select **Menu > Installation > Engine Selection > Num. Engines**.
- 2 Select **First Engine**.
- 3 Select the engine to display in the first gauge.
- 4 Repeat for the remaining engine bars.

### Enabling Status Alarms for Engine Gauges

You can enable the chartplotter to display engine status alarms.

From the engine gauges screen, select **Menu > Installation > Status Alarms > On**.

When an engine alarm is triggered, a gauge status alarm message appears and the gauge may become red depending on the type of alarm.

### Enabling Some Engine Gauge Status Alarms

- 1 From the engine gauges screen, select **Menu > Installation > Status Alarms > Custom**.
- 2 Select one or more engine gauge alarms to turn on or off.

### Yamaha Engine Gauges

Select **A/V, Gauges, Controls > YAMAHA** to view the Yamaha engine gauges. This screen varies based on the engine network and throttle controller.

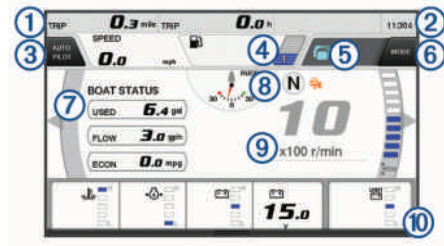

①	Data fields Hold to replace the data.
②	Current time Hold to view trip data.
③	Press to set the joystick button Set Point functions (Helm Master®).
④	Tank level information Hold a tank to view detailed tank level sensor information.
⑤	GPS signal strength Select to set the Fish Point high RPM limit (Helm Master). Select to set the trolling speed (Command Link Plus®).
⑥	Data fields Hold to replace the data.
⑦	Shift position
⑧	Tachometer and trim angle Hold to change the background.
⑨	Engine information Hold to replace the data and change the gauge appearance.

### Engine Condition Icons







Orange icons indicate engine conditions.

	Yamaha security system is on.
	Engines are under synchronization control.
	Engines are warming up.

### Engine Alert Icons

Red icons indicate engine abnormalities.

<b>NOTICE</b>	
Consult your Yamaha dealer if the problem cannot be located and corrected.	
	Low cooling water pressure.
	Low oil pressure. Stop the engine. Check the engine oil level, and add more oil if necessary.
<b>NOTICE</b>	
Do not continue to run the engine if this indicator is on. Serious engine damage will occur.	

	<p>Engine overheating. Stop the engine immediately. Check the cooling water inlet, and clear it if it is blocked.</p> <p style="text-align: center;"><b>NOTICE</b></p> <p>Do not continue to run the engine if this indicator is on. Serious engine damage will occur.</p>
	<p>Low battery voltage. Check the battery and battery connections, and tighten all loose battery connections. Return to port soon if tightening the battery connections does not increase the battery voltage. Consult your Yamaha dealer immediately.</p> <p><b>NOTE:</b> Do NOT stop the engine when this alert is on. If you do, you may not be able to restart the engine.</p>
	<p>Water in the fuel. Water has collected in the fuel filter (fuel separator). Stop the engine immediately and consult the engine manual to drain the water from the fuel filter.</p> <p><b>NOTE:</b> Gasoline mixed with water might cause damage to the engine.</p>
	<p>Check engine/maintenance alert. Consult your Yamaha dealer immediately. The check engine alert also appears when more than 100 hours have elapsed since the previous maintenance.</p>
	<p>Engine alert notification. (Helm Master)</p>
	<p>Engine emission issue.</p>

## Setting Up the Gauges

### Configuring the Number of Engines

- 1 From a gauges screen, select **Menu > Num. Engines**.
- 2 Select the number of engines.

### Configuring the Tank Level Sensors

- 1 From a gauges screen, select **Menu > Tank Preset**.
- 2 Select a tank level sensor to configure.
- 3 Select **Name**, enter a name, and select **Done**.
- 4 Select **Type**, and select the type of sensor.
- 5 Select **Style**, and select the style of sensor.
- 6 Select **Tank Capacity**, enter the capacity of the tank, and select **Done**.
- 7 Select **Calibration**, and follow the on-screen instructions to calibrate the tank levels.  
If you do not calibrate the tank levels, the system uses default settings for the tank levels.

### Changing the Data Shown

- 1 From a data screen, hold a customizable item.
- 2 Select a data type.
- 3 Select the data to display.

### Yamaha Engine Data Settings

#### NOTICE

Be sure the settings are set correctly. If not, the engine screen will not display the correct information.

From a Yamaha engine screen, select Menu.

**Trip:** Displays information about the trip, such as distance and hours, and allows you to reset these values.

**Maintenance Reminder:** Displays maintenance information, enables you to set the maintenance intervals, and allows you to reset the time elapsed since the previous maintenance.

**Tank Preset:** Sets the tank name, fluid type, sensor style, and tank capacity, and calibrates the sensor.

**Trim Assist:** Turns the trim assist feature on or off. Available on the Helm Master system equipped with a digital engine control (DEC) system.

**Steer Friction:** Sets the friction on the steering wheel. The friction adjusts automatically according to the engine speed. Available on the Helm Master system equipped with a digital engine control (DEC) system.

**Lock to Lock:** Sets the number of times the steering wheel can be turned between locks, fully to port and fully to starboard.

**Speed Control:** Sets the speed source to GPS or RPM. Using GPS as the Speed Source is available only with the Helm Master EX system equipped with an autopilot or joystick. GPS is not available on the Helm Master system.

**Autopilot Setting:** Configures the Yamaha autopilot settings. Available on the Helm Master EX system equipped with an autopilot. For Garmin autopilot information, see ([Autopilot, page 39](#)).

**Joystick and Set Point:** Sets the joystick thrust, trim angle and preset, fine tuning distance, and fish point settings. Available on the Helm Master system and the Helm Master EX system equipped with a joystick.

**Trim Assist Preset:** Sets up the trim assist presets. Available on the Helm Master system equipped with a digital engine control (DEC) system.

**Fuel Flow Offset:** Sets the offset for the fuel flow data.

**Off Timer:** Turns off the system one hour after the engine is turned off.

**Battery Management:** Configures the battery management system, such as setting the type and capacity of the batteries. Also displays the battery status. Available on Helm Master EX systems equipped with Battery Management System (BMS).

**Calibration:** Calibrates various features, such as the Trim Zero Set and compass.

**Reset:** Resets the engine and gateway data.

## Setting the Fuel Alarm

Before you can set a fuel level alarm, a compatible fuel flow sensor must be connected to the chartplotter.

You can set an alarm to sound when the total amount of remaining onboard fuel reaches the level you specify.

- 1 Select **Settings > Alarms > Fuel > Set Total Fuel Onboard > On**.
- 2 Enter the remaining amount of fuel that triggers the alarm, and select **Done**.

### Setting the Fuel Capacity of the Vessel

- 1 Select **Settings > My Vessel > Fuel Capacity**.
- 2 Enter the combined total capacity of the fuel tanks.

### Synchronizing the Fuel Data with the Actual Vessel Fuel

You can synchronize the fuel levels in the chartplotter with the actual fuel in the vessel when you add fuel to your vessel.

- 1 Select **A/V, Gauges, Controls > Engines > Menu**.
- 2 Select an option:
  - After you have filled up all the fuel tanks on the vessel, select **Fill Up All Tanks**. The fuel level is reset to maximum capacity.
  - After you have added less than a full tank of fuel, select **Add Fuel to Boat**, and enter the amount added.
  - To specify the total fuel in the vessel tanks, select **Set Total Fuel Onboard**, and enter the total amount of fuel in the tanks.

## Viewing the Wind Gauges

Before you can view wind information, you must have a wind sensor connected to the chartplotter.

Select **A/V, Gauges, Controls > Wind**.

### Configuring the Sailing Wind Gauge

You can configure the sailing wind gauge to show true or apparent wind speed and angle.

- 1 From the wind gauge, select **Menu > Sailing Wind Gauge**.
- 2 Select an option:
  - To show true or apparent wind angle, select **Needle**, and select an option.
  - To show true or apparent wind speed, select **Wind Speed**, and select an option.

### Configuring the Speed Source

You can specify whether the vessel speed data displayed on the gauge and used for wind calculations is based on water speed or GPS speed.

- 1 From the wind gauge, select **Menu > Compass Gauge > Speed Display**.
- 2 Select an option:
  - To calculate the vessel speed based on data from the water-speed sensor, select **Water Speed**.
  - To calculate the vessel speed based on GPS data, select **GPS Speed**.

### Configuring the Heading Source of the Wind Gauge

You can specify the source of the heading displayed on the wind gauge. Magnetic heading is the heading data received from a heading sensor, and GPS heading is calculated by your chartplotter GPS (course over ground).

- 1 From the wind gauge, select **Menu > Compass Gauge > Heading Source**.
- 2 Select **GPS** or **Magnetic**.

**NOTE:** When moving at low speeds or when stationary, the magnetic compass source is more accurate than the GPS source.

### Customizing the Close-Hauled Wind Gauge

You can specify the range of the close-hauled wind gauge for both the upwind scale and the downwind scale.

- 1 From the wind gauge, select **Menu > Compass Gauge > Gauge Type > Close Hauled Gauge**.
- 2 Select an option:
  - To set the maximum and minimum values that appear when the upwind close-hauled wind gauge appears, select **Change Upwind Scale**, and set the angles.
  - To set the maximum and minimum values that appear when the downwind close-hauled wind gauge appears, select **Change Downwind Scale**, and set the angles.
  - To view true or apparent wind, select **Wind**, and select an option.

## Viewing Trip Gauges

Trip gauges show information for odometer, speed, time, and fuel for your present trip.

Select **Info > Trip & Graphs > Trip**.

### Resetting Trip Gauges

- 1 Select **Info > Trip & Graphs > Trip**.
- 2 Select an option:
  - To set all the readings for the present trip to zero, select **Reset Trip**.
  - To set the maximum speed reading to zero, select **Reset Maximum Speed**.

- To set the odometer reading to zero, select **Reset Odometer**.
- To set all the readings to zero, select **Reset All**.

## Battery Management

You can view the battery and other power sources, and the devices that use those sources.

Batteries are listed along the top of the screen. Other sources of power, such as solar, alternator, converter, and wind generator, are listed along the left side. The items along the right side of the screen are devices that use the batteries and other power sources.

### Setting Up the Battery Management Page

- 1 Select **A/V, Gauges, Controls > Battery Management > Menu > Edit Devices**.
- 2 Select an item.
- 3 Select **Device**, and select an item from the list.
- 4 If necessary, select **Name**, enter a name for this device, and select **Done**.
- 5 If necessary, select **Change Icon**, select a new symbol, and select **Done**.
- 6 Repeat steps 2 through 5 for each device.

## Viewing Graphs

Before you can view graphs of various environmental changes, such as temperature, depth, and wind, you must have an appropriate transducer or sensor connected to the network.

Select **Info > Trip & Graphs > Graphs**.

### Setting the Graph Range and Time Scales

You can indicate the amount of time and the range of depth that appear in the depth and water temperature graphs.

- 1 From a graph, select **Graph Setup**.
- 2 Select an option:
  - To set a time-elapsed scale, select **Duration**. The default setting is 10 minutes. Increasing the time-elapsed scale allows you to view variations over a longer period of time. Decreasing the time-elapsed scale allows you to view more detail over a shorter period of time.
  - To set the graph scale, select **Scale**. Increasing the scale allows you to view more variation in readings. Decreasing the scale allows you to view more detail in the variation.

## inReach® Messages

### WARNING

Do not read or reply to notifications while operating the vessel. Failure to pay attention to the conditions on the water can result in vessel damage, personal injury, or death.

You can connect an inReach Mini device to the chartplotter to view, reply to, and send preset messages from the chartplotter.

**NOTE:** The inReach Mini device must be connected to the chartplotter and receiving satellite signals to send and receive messages using the chartplotter.

To open the InReach® page, select **A/V, Gauges, Controls > InReach®**.

### Connecting an inReach Device to the Chartplotter

You can connect a compatible inReach device to the chartplotter to manage messages.

- 1 Bring the inReach device within 3 m (10 ft.) of the chartplotter.



- From the main menu of the inReach device, select **Setup > ANT+ > Status > On**.
- On the chartplotter, select **A/V, Gauges, Controls > InReach® > Start Pairing**.  
The chartplotter begins searching for and connecting to the inReach device. This can take up to 60 seconds.
- If necessary, compare the code on the inReach device to the chartplotter, and select **OK** if they match.  
The inReach and chartplotter connect automatically when they are within range.

## Receiving inReach Messages

When your inReach device receives a message, a pop-up notification appears briefly on the GPSMAP screen.

- To review the full message, select **Review**.
- To dismiss the pop-up notification, select **OK** or wait for the notification to close automatically.

## Sending an inReach Preset Message

Preset messages are messages that you created at [explore.garmin.com](http://explore.garmin.com). Preset messages have predefined text and recipients.

- From the **InReach®** page, select **Messages > Send inReach Preset**.
- Select a preset message.
- Select **Send**.

## Replying to an inReach Message

You can reply to an inReach message with a pre-written message.

- From the **InReach®** page, select **Messages**.  
A list of sent and received messages appears.
- Select a received message.
- Select **Reply**.
- Select a message.
- Select **Send**.

## Digital Switching

Your chartplotter can be used to monitor and control circuits when a compatible system is connected.

For example, you can control the interior lights and navigation lights on the vessel. You can also monitor live well circuits.

To access the digital switching controls, select **A/V, Gauges, Controls > Switching**.

For more information about purchasing and configuring a digital switching system, contact your Garmin dealer.

## Adding and Editing a Digital Switching Page

You can add and customize digital switching pages to the chartplotter.

- Select **A/V, Gauges, Controls > Switching > Menu > Setup**.
- Select **Add Page** or **Edit Page**.
- Set up the page as needed:
  - To enter a name for the page, select **Name**.
  - To set up the switches, select **Edit Switches**.
  - To add an image of the boat, select **Add BoatView Image**.

**NOTE:** You can load an image of your vessel into the device to use for the image, or use a default image. You can also adjust the view and placement of the image.

## Dometic® Optimus® Features

When connected to a compatible Optimus system, the chartplotter allows you to access and control the system. You can enable the Optimus overlay to control the Optimus system ([Activating the Optimus Overlay Bar, page 49](#)).

When necessary, the Optimus system provides messages with information, instructions, and alerts about faults and hazards.

A no swimming icon  indicates that you should not swim when certain Optimus modes are active. In these modes, propeller control is automatic and could injure someone in the water.

## Activating the Optimus Overlay Bar

- From a chart, select **Menu > Edit Overlays**.
- Select **Top Bar** or **Bottom Bar**.
- Select **Optimus Bar**.

## Optimus Overlay Bar Overview

To use the overlay bar, you must connect your Optimus system to your chartplotter and add the overlay bar to the necessary screens ([Activating the Optimus Overlay Bar, page 49](#)).







①	Control mode
②	Optimus control buttons
③	Rudder
④	Standby button

You must press a mode button on the overlay bar to engage or disengage the mode. When the mode is engaged, the button is illuminated.

The overlay bar configuration and buttons vary, based on systems, modes, and equipment. Refer to your Optimus documentation for more information.

## Optimus Overlay Symbols

	Autopilot heading hold
	Autopilot track mode
	Autopilot route mode
	SeaStation position hold
	SeaStation heading hold

## Optimus Limp Home Mode

### **WARNING**

In the event of a steering failure, Optimus Limp Home mode becomes available. Limp Home mode is a system override that may severely limit your boat's control. It should only be used in an emergency if you are unable to call for assistance. Proceed with extreme caution. Read the Optimus owner's manual and always wear a personal flotation device (PFD).

You are responsible for the safe and prudent operation of your vessel. Use of Limp Home mode does not relieve you of the responsibility of safely operating your boat. Avoid navigational hazards and never leave the motor controls unattended.

When available, the Limp Home button appears on the Optimus overlay bar. Refer to the Optimus owner's manual before using Limp Home mode.

To engage Limp Home mode from any screen, select **Info > Warning Manager > Steering Limp Home**.

# Tide, Current, and Celestial Information

## Tide Station Information

### WARNING

Tide and current information is for information purposes only. It is your responsibility to heed all posted water-related guidance, to remain aware of your surroundings, and to use safe judgment in, on, and around the water at all times. Failure to heed this warning could result in property damage, serious personal injury, or death.

You can view information about a tide station for a specific date and time, including the tide height, and when the next high and low tides will occur. By default, the chartplotter shows tide information for the most recently viewed tide station, present date, and past hour.

Select **Info > Tides & Currents > Tides**.

## Current Station Information

### WARNING

Tide and current information is for information purposes only. It is your responsibility to heed all posted water-related guidance, to remain aware of your surroundings, and to use safe judgment in, on, and around the water at all times. Failure to heed this warning could result in property damage, serious personal injury, or death.

**NOTE:** Current station information is available with certain detailed maps.

You can view information about a current station for a specific date and time, including the current speed and level of the current. By default, the chartplotter shows current information for the most recently viewed current station and for the present date and time.

Select **Info > Tides & Currents > Currents**.

## Celestial Information

You can view information about sunrise, sunset, moonrise, moonset, moon phase, and the approximate sky view location of the sun and moon. The center of the screen represents the sky overhead, and the outermost rings represent the horizon. By default, the chartplotter shows celestial information for the present date and time.

Select **Info > Tides & Currents > Celestial**.

## Viewing Tide Station, Current Station, or Celestial Information for a Different Date

- 1 Select **Info > Tides & Currents**.
- 2 Select **Tides, Currents, or Celestial**.
- 3 Select an option:
  - To view information for a different date, select **Change Date > Manual**, and enter a date.
  - To view information for today, select **Change Date > Current**.
  - If available, to view information for the day after the date shown, select **Next Day**.
  - If available, to view information for the day before the date shown, select **Previous Day**.

## Viewing Information for a Different Tide or Current Station

- 1 Select **Info > Tides & Currents**.
- 2 Select **Tides** or **Currents**.

- 3 Select **Nearby Stations**.
- 4 Select a station.

## Viewing Almanac Information from the Navigation Chart

- 1 From a chart or 3D chart view, select a location.
- 2 Select **Information**.
- 3 Select **Tides, Currents, or Celestial**.

## Warning Manager

During an active warning, an indicator appears on the Info button on the menu bar. The Warning Manager displays a color-coded alarm icon and prioritizes alarm messages by severity.

Color	Severity
Red	Hazards that require immediate action to avoid severe personal injury or death
Yellow	Hazards or unsafe practices which could result in minor personal injury or product or property damage

## Viewing Messages

- 1 Select **Info > Warning Manager**.
- 2 Select a message.
- 3 Select **Review**.

## Sorting and Filtering Messages

- 1 Select **Info > Warning Manager > Sort/Filter**.
- 2 Select an option to sort or filter the message list.

## Saving Messages to a Memory Card

- 1 Insert a memory card into the card slot.
- 2 Select **Info > Warning Manager > Save to Card**.

## Clearing all of the Messages

Select **Info > Warning Manager > Clear Warning Manager**.

## Media Player

**NOTE:** The media player feature is not compatible with all chartplotter models.

**NOTE:** Not all features are available on all connected media players.

If you have a compatible stereo connected to the NMEA 2000 network or Garmin Marine Network, you can control the stereo using the chartplotter. The chartplotter should automatically detect the media player when it is first connected.

You can play media from sources connected to the media player and sources connected to the network.





## Opening the Media Player

Before you can open the media player, you must connect a compatible device to the chartplotter.

Select **A/V, Gauges, Controls > Media**.

## Media Player Icons

**NOTE:** Not all devices have these icons.

Icon	Description
	Saves or deletes a channel as a preset
	Repeats all songs
	Repeats one song
	Searches for stations or skips songs
	Shuffles

## Selecting the Media Device and Source

You can select the media source connected to the stereo. When you have multiple stereo or media devices connected on a network, you can select the device from which you want to play music.

**NOTE:** You can play media only from sources that are connected to the stereo.

**NOTE:** Not all features are available on all media devices and sources.

- 1 From the media screen, select **Devices**, and select the stereo.
- 2 From the media screen, select **Source**, and select the media source.

**NOTE:** The Devices button only appears when more than one media device is connected to the network.

**NOTE:** The Source button only appears for devices that support multiple media sources.

## Playing Music

### Browsing for Music

- 1 From the media screen, select **Browse** or **Menu > Browse**.
- 2 Select **Select** or select an option.

### Enabling Alphabetical Search

You can enable the alphabetical search feature to find a song or album in a large list.

From the media screen, select **Menu > Installation > Alpha Search**.

### Setting a Song to Repeat

- 1 While playing a song, select **Menu > Repeat**.
- 2 If necessary, select **Single**.

### Setting All Songs to Repeat

From the media screen, select **Menu > Repeat > All**.

### Setting Songs to Shuffle

- 1 From the media screen, select **Menu > Shuffle**.
- 2 If necessary, select an option.

### Joining the Fusion PartyBus™ Network

You can play music from other compatible stereos connected to the Fusion PartyBus network. One Fusion PartyBus stereo must be connected to the chartplotter using the NMEA 2000 network.

**NOTE:** A Fusion PartyBus zone stereo, such as the Apollo™ SRX400 zone stereo, cannot stream sources to other Fusion PartyBus devices on the network. Because of this, zone stereos do not appear as available sources in the chartplotter.

- 1 From the media screen, select **Source**.  
**NOTE:** After few moments, the compatible Fusion PartyBus stereos appear as sources.
- 2 Select the Fusion PartyBus stereo.
- 3 If necessary, select **Source**, and select a different source connected to the Fusion PartyBus stereo.

To leave the Fusion PartyBus network, you can select **Source > Leave PartyBus**.

## Adjusting the Volume

### Muting the Media Volume

- 1 From the media screen, select .
- 2 If necessary, select **Select**.

### Enabling and Disabling Zones

If you have wired your vessel's speakers into zones, you can enable needed zones and disable unused zones.

- 1 From the media screen, select **Menu > Audio Levels > Enable/Disable Zones**.
- 2 Select a zone.

## VHF Radio

**NOTE:** These features are available on some stereos with a VHF receiver.

### Scanning VHF Channels

Before you can scan VHF channels, you must set the source to VHF.

You can monitor VHF channels saved as presets for activity and automatically switch to an active channel.

From the VHF media screen, select **Scan**.

### Adjusting the VHF Squelch

**NOTE:** This feature is available on some stereos with a VHF receiver.

- 1 From the VHF source page, select **Menu > Squelch**.
- 2 Use the slider bar to adjust the VHF squelch.

## Radio

To listen to AM or FM radio, you must have a suitable marine AM/FM antenna properly connected to the stereo and be within range of a broadcasting station. For instructions on connecting an AM/FM antenna, see the stereo installation instructions.

To listen to SiriusXM® radio, you must have the appropriate equipment and subscriptions (*SiriusXM Satellite Radio*, page 52). For instructions on connecting a SiriusXM Connect Vehicle Tuner, see the stereo installation instructions.

To listen to DAB stations, you must have the appropriate equipment (*DAB Playback*, page 52). For instructions on connecting a DAB adapter and antenna, see the installation instructions provided with your adapter and antenna.

### Setting the Tuner Region

- 1 From the media screen, select **Menu > Installation > Tuner Region**.
- 2 Select an option.

### Changing the Radio Station

- 1 From the media screen, select an applicable source, such as **FM**.
- 2 Select **◀** or **▶** to tune to a station.

### Changing the Tuning Mode

You can change how you select a station for some media types, such as FM or AM radio.

**NOTE:** Not all tuning modes are available for all media sources.

- 1 From the media screen, select **Menu > Tuning Mode**.
- 2 Select an option.
- 3 If necessary, select **Select**.

### Presets

You can save your favorite AM stations and FM stations as presets for easy access.

You can save your favorite SiriusXM channels if the stereo is connected to an optional SiriusXM tuner and antenna.

You can save your favorite DAB stations if the stereo is connected to an optional DAB module and antenna.

### Saving a Station as a Preset

- 1 From an applicable media screen, tune to the station to save as a preset.
- 2 Select **Presets > Add Current Channel**.

### Selecting a Preset

- 1 From an applicable media screen, select **Presets**.

- 2 Select a preset from the list.
- 3 Select **Tune to Channel**.

### Removing a Preset

- 1 From an applicable media screen, select **Presets**.
- 2 Select a preset from the list.
- 3 Select **Remove Current Channel**.

## DAB Playback

When you connect a compatible Digital Audio Broadcasting (DAB) module and antenna, such as the Fusion® MS-DAB100A to a compatible stereo, you can tune in to and play DAB stations

To use the DAB source, you must be in a region in which DAB is available, and select the tuner region (*Setting the DAB Tuner Region*, page 52).

### Setting the DAB Tuner Region

You must select the region you are in to receive DAB stations properly.

- 1 From the media screen, select **Menu > Installation > Tuner Region**.
- 2 Select the region you are in.

### Scanning for DAB Stations

Before you can scan for DAB stations, you must connect a compatible DAB module and antenna (not included) to the stereo. Because DAB signals are broadcast in select countries only, you must also set the tuner region to a location where DAB signals are broadcast.

- 1 Select the **DAB** source.
- 2 Select **Scan** to scan for available DAB stations.

When scanning is complete, the first available station in the first ensemble found begins playing.

**NOTE:** After the first scan is complete, you can select Scan again to re-scan for DAB stations. When the re-scan is complete, the system starts playing the first station in the ensemble you were listening to when you started the re-scan.

### Changing DAB Stations

- 1 Select the **DAB** source.
- 2 If necessary, select **Scan** to scan for local DAB stations.
- 3 Select **◀** or **▶** to change the station.

When you reach the end of the current ensemble, the stereo automatically changes to the first available station in the next ensemble.

**TIP:** You can hold **◀** or **▶** to change the ensemble.

### Selecting a DAB Station from a List

- 1 From the DAB media screen, select **Browse > Stations**.
- 2 Select a station from the list.

### Selecting a DAB Station from a Category

- 1 From the DAB media screen, select **Browse > Categories**.
- 2 Select a category from the list.
- 3 Select a station from the list.

## DAB Presets

You can save your favorite DAB stations as presets for easy access.

You can save up to 15 DAB-station presets.

### Saving a DAB Station as a Preset

- 1 From the DAB media screen, select the station to save as a preset.
- 2 Select **Browse > Presets > Save Current**.

### Selecting a DAB Preset from a List

- 1 From the DAB media screen, select **Browse > Presets > View Presets**.
- 2 Select a preset from the list.

### Removing DAB Presets

- 1 From the DAB media screen, select **Browse > Presets**.
- 2 Select an option:
  - To remove one preset, select **Remove Preset**, and select the preset.
  - To remove all presets, select **Remove All Presets**.

## SiriusXM Satellite Radio

When you have a FUSION-Link™ capable stereo and SiriusXM Connect Tuner installed and connected to the chartplotter, you may have access to SiriusXM satellite radio, depending on your subscription.

### Locating a SiriusXM Radio ID

Before you can activate your SiriusXM subscription, you must have the radio ID of your SiriusXM Connect Tuner.

You can locate the SiriusXM Radio ID on the back of the SiriusXM Connect Tuner, on the back of its packaging, or by tuning your chartplotter to channel 0.

- 1 Select **Media > Source > SiriusXM**.
- 2 Tune to channel 0.

The SiriusXM radio ID does not include the letters I, O, S, or F.

### Activating a SiriusXM Subscription

- 1 With the SiriusXM source selected, tune to channel 1.

You should be able to hear the preview channel. If not, check the SiriusXM Connect Tuner and antenna installation and connections, and try again.
- 2 Tune to channel 0 to locate the Radio ID.
- 3 Contact SiriusXM listener care by phone at (866) 635-2349 or go to [www.siriusxm.com/activatenow](http://www.siriusxm.com/activatenow) to subscribe in the United States. Contact SiriusXM by phone at (877) 438-9677 or go to [www.siriusxm.ca/activatexm](http://www.siriusxm.ca/activatexm) to subscribe in Canada.
- 4 Provide the Radio ID.

The activation process usually takes 10 to 15 minutes, but can take up to an hour. For the SiriusXM Connect Tuner to receive the activation message, it must be turned on and receiving the SiriusXM signal.
- 5 If the service is not activated within the hour, go to <http://care.siriusxm.com/refresh> or contact SiriusXM Listener Care by phone at 1-866-635-2349.

### Customizing the Channel Guide

SiriusXM radio channels are grouped in categories. You can select the categories of channels that appear in the channel guide.

Select an option:

- If the media device is a FUSION-Link capable stereo, select **Media > Browse > Channel**.
- If the media device is a GXM™ antenna, select **Media > Category**.

### Saving a SiriusXM Channel to the Presets List

You can save your favorite channels to the presets list.

- 1 Select **Media**.
- 2 Select the channel to save as a preset.
- 3 Select an option:
  - If the media device is a FUSION-Link capable stereo, select **Browse > Presets**.

- If the media device is a GXM antenna, select **Menu > Presets > Add Current Channel**.

## Parental Controls

The parental control feature allows you to limit access to any SiriusXM channels, including those with mature content. When the parental control feature is enabled, you must enter a passcode to tune to the locked channels. You can also change the 4-digit passcode.

### Unlocking SiriusXM Parental Controls

- 1 From the media screen, select **Browse > Parental > Unlock**.
- 2 Enter your passcode.  
The default passcode is 0000.

### Setting Parental Controls on SiriusXM Radio Channels



Before you can set parental controls, the parental controls must be unlocked.

The parental control feature allows you to limit access to any SiriusXM channels, including those with mature content. When enabled, the parental control feature requires you to enter a passcode to tune to the locked channels.

Select **Browse > Parental > Lock/Unlock**.

A list of channels appears. A checkmark indicates a locked channel.

**NOTE:** When you view the channels after setting parental controls, the display changes:

-  indicates a locked channel.
-  indicates an unlocked channel.

### Clearing All Locked Channels on a SiriusXM Radio

Before you can clear all locked channels, the parental controls must be unlocked.

- 1 From the media screen, select **Browse > Parental > Clear All Locked**.
- 2 Enter your passcode.

### Restoring Default Parental Control Settings Values

This process deletes all the settings information you have entered. When you restore the parental control settings to their default values, the passcode value is reset to 0000.

- 1 From the media menu, select **Installation > Factory Defaults**.
- 2 Select **Yes**.

### Changing a Parental Passcode on a SiriusXM Radio

Before you can change the passcode, the parental controls must be unlocked.

- 1 From the media screen, select **Browse > Parental > Change PIN**.
- 2 Enter your passcode and select **Done**.
- 3 Enter a new passcode.
- 4 Confirm the new passcode.

## Setting the Device Name

- 1 From the media screen, select **Menu > Installation > Set Device Name**.
- 2 Enter a device name.
- 3 Select **Select** or **Done**.

## Updating the Media Player Software

You can update the software on compatible connected stereos and accessories.

- 1 Go to [www.fusionentertainment.com/marine](http://www.fusionentertainment.com/marine), and download the software update onto a USB flash drive.  
Software updates and instructions are available on your device product page.

- 2 Insert the USB flash drive into the USB port of the stereo.
- 3 On the chartplotter media screen, select **Menu > Installation > Update Software**.
- 4 Select the item to update.

## SiriusXM Weather

### WARNING

The weather information provided through this product is subject to service interruptions and may contain errors, inaccuracies, or outdated information, and consequently should not be relied upon exclusively. Always use common sense while navigating, and check alternate weather information sources prior to making safety-related decisions. You acknowledge and agree that you shall be solely responsible for use of the weather information and all decisions taken with respect to navigating in weather. Garmin will not be responsible for any consequences of using SiriusXM weather information.

**NOTE:** SiriusXM data is not available in all regions.

A Garmin SiriusXM satellite weather receiver and antenna receives satellite weather data and shows it on various Garmin devices, including the Navigation chart on a compatible chartplotter. The weather data for each feature comes from reputable weather data centers such as the National Weather Service and the Hydrometeorological Prediction Center. For more information, go to [www.siriusxm.com/sxmmarine](http://www.siriusxm.com/sxmmarine).

## SiriusXM Equipment and Subscription Requirements

To use satellite weather, you must have a compatible satellite weather receiver. To use SiriusXM satellite radio, you must have a compatible satellite radio receiver. Go to [www.garmin.com](http://www.garmin.com) for more information. You must also have a valid subscription to receive satellite weather and radio. For more information, refer to the instructions for your satellite weather and radio equipment.

## Weather Data Broadcasts

Weather data is broadcast at different intervals for each weather feature. For example, radar is broadcast at five-minute intervals. When the Garmin receiver is turned on, or when a different weather feature is selected, the receiver must receive new data before it can be shown. You might experience a delay before weather data or a different feature appears on the chart.

**NOTE:** Any weather feature can change in appearance if the source that provides the information changes.

## Weather Warnings and Weather Bulletins

When a marine weather warning, weather watch, weather advisory, weather bulletin, or other weather statement is issued, shading indicates the area to which the information applies. The aqua lines on the chart indicate the boundaries of marine forecasts, coastal forecasts, and offshore forecasts. Weather bulletins may consist of either weather watches or weather advisories.

To view information about the warning or bulletin, select the shaded area.

Color	Marine Weather Group
Cyan	Flash Flood
Blue	Flood
Red	Marine
Yellow	Severe Storm
Red	Tornado

## Changing the Weather Chart

- 1 From a combination screen or SmartMode layout with a weather chart, select **Menu > Weather Menu > Change Weather**.
- 2 Select a weather chart.

## Viewing Precipitation Information

Precipitation ranging from very light rain and snow, up to strong thunderstorms, is indicated in varying shades and colors. Precipitation is shown either independently or with other weather information.

Select **Charts > Precipitation**.

The time stamp in the upper-left corner of the screen indicates the elapsed time since the weather data provider last updated the information.

## Storm Cell and Lightning Information

Storm cells are represented by the  icon on the weather precipitation chart. They indicate both the present position of a storm and the projected path of that storm in the immediate future.

Red cones appear with a storm cell icon, and the widest part of each cone points in the direction of the projected path of the storm cell. The red lines in each cone indicate where the storm will most likely be in the near future. Each line represents 15 minutes.

Lightning strikes are represented by the  icon. Lightning appears on the weather precipitation chart if strikes were detected within the last seven minutes. The ground-based lightning detection network detects cloud-to-ground lightning only.

**NOTE:** This feature is not available on all devices and in all subscriptions.

## Hurricane Information

The weather Precipitation chart can show the present position of a hurricane , a tropical storm, or a tropical depression. A red line stemming from a hurricane icon indicates the projected path of the hurricane. Darkened dots on the red line indicate the projected locations through which the hurricane will pass, as received from the weather data provider.



## Forecast Information

The Forecast chart shows city forecasts, marine forecasts, warnings, hurricane warnings, METARS, county warnings, weather fronts and pressure centers, surface pressure, and weather buoys.

## Viewing a Marine Forecast or an Offshore Forecast





- 1 Select **Charts > Forecast**.
- 2 Pan the chart to an offshore location.  
The Marine Forecast or Offshore Forecast options appear when forecast information is available.
- 3 Select **Marine Forecast** or **Offshore Forecast**.

## Viewing Forecast Information for Another Time Period

- 1 Select **Charts > Forecast**.
- 2 Select an option:
  - To view the weather forecast for the next 48 hours, in 12-hour increments, select  multiple times.
  - To view the weather forecast for the previous 48 hours, in 12-hour increments, select  multiple times.

## Weather Fronts and Pressure Centers

Weather fronts appear as lines that indicate the leading edge of an air mass.









Front Symbol	Description
	Cold front
	Warm front
	Stationary front
	Occluded front
	Trough

Pressure-center symbols often appear near weather fronts.

Pressure-Center Symbol	Description
<b>L</b>	Indicates a low-pressure center, which is a region of relatively lower pressure. Moving away from a low-pressure center results in increased pressure. Winds flow counterclockwise around low-pressure centers in the northern hemisphere.
<b>H</b>	Indicates a high-pressure center, which is a region of relatively higher pressure. Moving away from a high-pressure center results in decreased pressure. Winds flow clockwise around high-pressure centers in the northern hemisphere.

## City Forecasts

City forecasts appear as weather symbols. The forecast is viewed in 12-hour increments.

Symbol	Weather
	Fair (sunny, hot, clear)
	Partly cloudy
	Cloudy
	Rain (drizzle, sleet, showers)
	Thunderstorms
	Windy
	Smoke (dusty, hazy)
	Foggy
	Snow (snow showers, flurries, blizzard, blowing snow, sleet, freezing rain, freezing drizzle)

## Viewing Fish Mapping Data

**NOTE:** This feature requires a GXM 54 antenna and a SiriusXM Fish Mapping™ service subscription.

The Fish Mapping weather chart shows information that can help you locate fish species.

- 1 Select **Charts > Fish Mapping**.
- 2 If necessary, select **Menu > Layers**, and turn on and off information.





## Viewing Sea Conditions

The Sea Conditions feature shows information about surface conditions, including winds, wave height, wave period, and wave direction.

Select **Charts > Sea Conditions**.

## Surface Winds

Surface wind vectors appear on the Sea Conditions chart using wind barbs that indicate the direction from which the wind is blowing. A wind barb is a circle with a tail. The line or flag attached to the tail of the wind barb indicates the wind speed. A short line represents 5 knots, a long line represents 10 knots, and triangle represents 50 knots.

Wind Barb	Wind Speed
	Calm
	5 knots
	10 knots
	15 knots

Wind Barb	Wind Speed
	20 knots
	50 knots
	65 knots

### Wave Height, Wave Period, and Wave Direction

Wave heights for an area appear as variations in color. Different colors indicate different wave heights, as shown in the legend.

The wave period indicates the time (in seconds) between successive waves. Wave period lines indicate areas that have the same wave period.

Wave directions appear on the chart using red arrows. The direction of each arrow pointer indicates the direction in which a wave is moving.

### Viewing Forecast Sea Conditions Information for Another Time Period

- 1 Select **Charts > Sea Conditions**.
- 2 Select an option:
  - To view forecasted sea conditions for the next 36 hours, in 12-hour increments, select multiple times.
  - To view the forecasted sea conditions for the previous 36 hours, in 12-hour increments, select multiple times.

### Viewing Sea Temperature Information

The Sea Temperature weather chart shows the present water temperature and present surface pressure conditions.

Select **Charts > Sea Temperature**.

### Surface Pressure and Water Temperature Data

Surface-pressure information appears as pressure isobars and pressure centers. Isobars connect points of equal pressure. Pressure readings can help to determine weather and wind conditions. High-pressure areas are generally associated with fair weather. Low-pressure areas are generally associated with clouds and the chance of precipitation. Isobars packed closely together show a strong pressure gradient. Strong pressure gradients are associated with areas of stronger winds.

Pressure units are shown in millibars (mb), inches of Mercury (inHg), or hectopascals (hPa).

Colored shading indicates the surface temperature of the water, as shown in the legend in the corner of the display.

### Changing the Sea Surface Temperature Color Range

You can change the color range dynamically to view higher resolution sea surface temperature readings.

- 1 Select **Charts > Sea Temperature > Menu > Sea Temperature**.
- 2 Select an option:
  - To allow the chartplotter to adjust the temperature range automatically, select **Auto Configure**.  
The chartplotter automatically finds the lower and upper limits for the current screen, and updates the temperature-color scale.
  - To enter the lower and upper limits for the temperature range, select **Lower Limit** or **Upper Limit**, and enter the lower or upper limit.

### Visibility Information

Visibility is the forecast maximum horizontal distance that can be seen at the surface, as shown in the legend on the left of the screen. Variations in the visibility shading show the forecast change in surface visibility.

**NOTE:** This feature is not available on all devices and in all subscriptions.

Select **Charts > Visibility**.

### Viewing Forecast Visibility Information for Another Time Period

- 1 Select **Charts > Visibility**.
- 2 Select an option:
  - To view the visibility forecast for the next 36 hours, in 12-hour increments, select multiple times.
  - To view the visibility forecast for the previous 36 hours, in 12-hour increments, select multiple times.

### Viewing Buoy Reports

Report readings are taken from buoys and coastal observation stations. These readings are used to determine air temperature, dew point, water temperature, tide, wave height and period, wind direction and speed, visibility, and barometric pressure.

- 1 From a weather chart, select .
- 2 Select **Buoy**.

### Viewing Local Weather Information near a Buoy

You can select an area near a buoy to view forecast information.

- 1 From a weather chart, select a location on the chart.
- 2 Select **Local Weather**.
- 3 Select an option:
  - To view present weather conditions from a local weather service, select **Current Condition**.
  - To view a local weather forecast, select **Forecast**.
  - To view surface wind and barometric pressure information, select **Sea Surface**.
  - To view wind and wave information, select **Marine Bulletin**.

### Weather Overlay

The weather overlay superimposes weather and weather-related information on the Navigation chart, the Fishing chart, and the Perspective 3D chart view. The Navigation chart and the Fishing chart can show weather radar, height of cloud tops, lightning, weather buoys, county warnings, and hurricane warnings. The Perspective 3D chart view can show weather radar.

Weather overlay settings configured for use on one chart are not applied to another chart. The weather overlay settings for each chart must be configured separately.

**NOTE:** The Fishing chart is available with premium charts, in some areas.

### Viewing Weather Subscription Information

You can view information about the weather services you have subscribed to and how many minutes have passed since the data for each service was updated.

From a weather chart, select **Menu > Subscription**.

## Viewing Video

### WARNING

Do not view video or photos while operating the vessel. Failure to pay attention to the conditions on the water can result in vessel damage, personal injury, or death.

Before you can view video, you must connect to a compatible source.

Compatible devices include video devices connected to the ports on the chartplotter or to the Garmin Marine Network, as well as supported network (IP-based) video cameras, encoders, and thermal cameras.

Select **A/V, Gauges, Controls > Video**.

## Selecting a Video Source

- 1 From the video screen, select **Menu > Source**.
- 2 Select the source of the video feed.

### Alternating Among Multiple Video Sources

If you have two or more video sources, you can alternate between them using a specific time interval.

- 1 From the video screen, select **Menu > Source > Alternate**.
- 2 Select **Time**, and select the amount of time each video appears.
- 3 Select **Source**, and select the video sources to add to the alternating sequence.

## Networked Video Devices

### NOTICE

A Garmin Power over Ethernet (PoE) Isolation Coupler (P/N 010-10580-10) must be used when connecting Ethernet devices, such as FLIR® cameras, to a Garmin Marine Network. Connecting an Ethernet device directly to a Garmin Marine Network chartplotter damages the Garmin chartplotter and may damage the Ethernet device.

Before you can view and control video devices such as IP cameras, encoders, and thermal cameras using your chartplotter, you must have a compatible video device connected to your chartplotter, and you must have a marine network cable Power over Ethernet (PoE) isolation coupler. Go to [garmin.com](http://garmin.com) for a list of compatible devices or to purchase a PoE Isolation Coupler.

You can connect multiple supported video cameras and up to two video encoders to the Garmin Marine Network. You can select and view up to four video sources at once. Chartplotters with multiple composite built-in video inputs can display a single built-in video input only. When the cameras are connected, the network detects them automatically and displays them in the source list.

### Using Video Presets on Networked Video Cameras

You can save, name, and activate video presets for each networked video source.

#### Saving Video Presets on a Networked Video Camera

- 1 From a video screen, touch the screen.  
The video controls appear on the screen.
- 2 Hold a video preset button.  
A green light indicates the setting is stored.

#### Naming Video Presets on a Networked Video Camera

- 1 From a video screen, select **Menu > Video Setup > Presets**.
- 2 Select a preset.
- 3 Select **Rename**.
- 4 Enter preset name.

#### Activating Video Presets on a Networked Video Camera

You can quickly return networked cameras to preset values.

- 1 From a video screen, touch the screen.  
The video controls appear on the screen.
- 2 Select a video preset.  
The camera restores the video settings saved for that preset.  
**TIP:** You can also save and activate presets using the video menu.

### Camera Settings

Some cameras provide additional options to control the camera view.

**NOTE:** Not all options are available on all camera models and chartplotter models. Refer to the camera manual for a list of

available features. You may need to update the camera software to use this feature.

From the infrared video screen, select **Menu**.

**IR Blend:** Selects the infrared effect to MSX® (Multi-Spectral Dynamic Imaging) mode or CTV (Color Thermal Vision™) mode, and allows you to blend the effects.

**IR/Visible:** Displays an infrared or visible light image.

**Scan:** Surveys the surrounding area.

**Freeze:** Pauses the camera image.

**Change Colors:** Selects the color scheme of the infrared image.

**Change Scene:** Selects the infrared image mode, such as day, night, MOB, or docking.

**Video Setup:** Opens more video options.

### Video Settings

Some cameras provide additional setup options.

**NOTE:** Not all options are available on all camera models and chartplotter models. You may need to update the camera software to use this feature.

From the video screen, select **Menu > Video Setup**.

**Set Input:** Associates the camera with a video source.

**Mirror:** Reverses the image like a rearview mirror.

**Standby:** Places the camera in standby mode to conserve power and protect the lens when not in use.

**Home Position:** Sets the home position of the camera.

**Scan Speed:** Sets how quickly the camera moves during a scan.

**Scan Width:** Sets the width of the image captured by the camera during a scan.

**Stabilization:** Stabilizes the picture using mechanical means.

**Low Light:** Optimizes the video for low-light environments.

**Aspect:** Sets the aspect ratio.

**Defog:** Optimizes the video for foggy environments.

**Dynamic Range:** Sets the range to wide or standard.

**E. Stabilization:** Stabilizes the picture using software image processing.

**Light:** Controls the camera's integrated light source to help illuminate the environment.

**Name:** Allows you to enter a new name for this camera.

**FLIR™ Menu:** Provides access to the settings for the camera.

### Associating the Camera to a Video Source

You may need to associate the camera with a video source.

- 1 From the video screen, select **Menu > Source**.
- 2 Select the camera.
- 3 Select **Video Setup > Set Input**.
- 4 Select the video input.

### Video Camera Movement Control

#### NOTICE

Do not aim the camera at the sun or extremely bright objects. Damage to the lens may occur.

Always use the chartplotter controls or buttons to pan and tilt the camera. Do not manually move the camera unit. Manually moving the camera may damage the camera.

**NOTE:** This feature is available only when a compatible camera is connected. You may need to update the camera software to use this feature.

You can control the movements of the connected video cameras that support panning, tilting, and zooming.



### Controlling Video Cameras Using On-Screen Controls

On-screen controls allow you to control pan-tilt-zoom (PTZ) cameras. Refer to the camera manual for a list of available features.

- 1 From a video screen, touch the screen.  
The video controls appear on the screen.
- 2 Select an option:
  - To zoom in and out, use the zoom button.
  - To pan or tilt the camera, use the compass rose.**TIP:** Hold within the compass rose to continue to move the camera in the desired direction.

### Controlling a Video Camera Using Gestures

When a networked video camera supports gesture responses, you can control pan-tilt-zoom cameras using gestures directly on the chartplotter screen. Check your camera user manual for a list of available features.

**TIP:** Using gestures allows video control without displaying the video controls.

- 1 From a video screen, touch the screen.
- 2 Select an option:
  - To zoom in and out with the camera, use pinch and zoom gestures.
  - To pan or tilt the camera, swipe the screen in the desired direction.

## Configuring the Video Appearance

**NOTE:** Not all options are available on all camera models and chartplotter models.

- 1 From the video screen, select **Menu > Video Setup**.
- 2 Select an option:
  - To show the video using a stretched aspect ratio, select **Aspect > Stretch**. The video cannot be stretched beyond the dimensions provided by the connected video device, and it may not fill the entire screen.
  - To show the video using a standard aspect ratio, select **Aspect > Standard**.
  - To adjust the brightness, select **Brightness**, and select **Up, Down, or Auto**.
  - To adjust the color saturation, select **Saturation**, and select **Up, Down, or Auto**.
  - To adjust the contrast, select **Contrast**, and select **Up, Down, or Auto**.
  - To allow the chartplotter to automatically select the source format, select **Standard > Auto**.

## Garmin VIRB® Action Cameras

### WARNING

Do not view video or photos while operating the vessel. Failure to pay attention to the conditions on the water can result in vessel damage, personal injury, or death.

Most VIRB action cameras connect to the chartplotter from the camera menu ([Connecting a VIRB Action Camera, page 57](#)).

The VIRB 360 camera connects using WPS ([Connecting a VIRB 360 Action Camera, page 57](#)).

In this manual, the term "VIRB action camera" refers to all models, except in the instructions on how to connect. In that case, as listed above, the term "VIRB 360 camera" refers to only the 360 model.

### Connecting a VIRB 360 Action Camera

You can connect a VIRB 360 action camera to the chartplotter using WPS. If you are connecting a VIRB camera, connect

through the camera settings ([Connecting a VIRB Action Camera, page 57](#)).

- 1 Set up the chartplotter's Wi-Fi network ([Setting Up the Wi-Fi Wireless Network, page 8](#)).
- 2 Bring the camera near the chartplotter.
- 3 On the VIRB 360 camera main menu, select **Wireless > Wi-Fi**.
- 4 If necessary, select the **Wi-Fi** toggle switch to enable the Wi-Fi technology.
- 5 Press **▶** to select **WPS**, and press **OK**.
- 6 On the chartplotter, select **A/V, Gauges, Controls > VIRB® > **.

The camera searches for the Wi-Fi network and connects.

You can control the camera using the chartplotter.

### Connecting a VIRB Action Camera

You connect a VIRB action camera to the chartplotter using the camera settings. If you are connecting a VIRB 360 camera, connect through the VIRB app ([Connecting a VIRB 360 Action Camera, page 57](#)).

- 1 Set up the chartplotter's Wi-Fi network ([Setting Up the Wi-Fi Wireless Network, page 8](#)).
- 2 From the VIRB camera main menu, select **Wireless > Wi-Fi > Status** to turn on Wi-Fi wireless technology.
- 3 Select **Mode > Connect**.
- 4 Select **Add New**.  
The camera searches for nearby Wi-Fi networks.
- 5 Select the chartplotter's Wi-Fi network, and enter the network password.  
The app and the camera connect to the chartplotter's Wi-Fi network.

You can control the camera using the chartplotter.





### Controlling the VIRB Action Camera with the Chartplotter

Before you can control a VIRB action camera with the chartplotter, you must connect the devices using a wireless connection.

You can connect up to five VIRB action cameras to the chartplotter.

After you connect the VIRB action camera with the chartplotter, a new option is added to A/V, Gauges, Controls. You can start and stop recording on the VIRB action camera using the chartplotter.





**NOTE:** The VIRB image shown on the chartplotter is a in a lower resolution than the VIRB action camera records. To view the high-resolution video, view the video on a computer or television.

- 1 Select **A/V, Gauges, Controls > VIRB®**.
- 2 Select an option:
  - To take a still photograph, select .
  - To begin recording, select .
  - When recording, the remaining recording memory is shown.
  - To stop recording, select  again.
  - If you have more than one VIRB action camera connected, use the arrows to select a different action camera to control.
  - To view stored videos or images, select .
  - To pan and tilt the VIRB 360, drag your finger on the screen.
  - To return the VIRB 360 view to the home position, select .

### Controlling the VIRB Action Camera Video Playback

You can view VIRB action camera video and images using the chartplotter.

**NOTE:** The VIRB playback on the chartplotter is shown in the same quality as the live view on the chartplotter. To view the high-resolution video, view the video on a computer or television.

- 1 From the **VIRB®** screen, select .
- 2 Wait a few seconds for the thumbnail images to load.
- 3 Select a video or image.
- 4 Control the playback using the on-screen buttons or menu options:
  - To stop the video, select .
  - To pause the video, select .
  - To replay the video, select .
  - To play the video, select .
  - To skip ahead or back in the video, drag the slider.

### Deleting a VIRB Video

You can delete a video or image from the VIRB action camera.

- 1 Open the VIRB video or image to delete.
- 2 Select **Menu > Delete File**.

### Starting a VIRB Video Slideshow

You can view a slideshow of the videos and images on the VIRB action camera.

- 1 From the **VIRB®** screen, select .
- 2 Wait a few seconds for the thumbnail images to load.
- 3 Select a video or image.
- 4 Select **Menu > Start Slideshow**.

To stop the slideshow, select **Menu > Stop Slideshow**.

### VIRB Action Camera Settings

**NOTE:** Not all options and settings apply to all camera models. Select **A/V, Gauges, Controls > VIRB® > Menu**.

**Name:** Allows you to enter a new name for the VIRB action camera.

**Recording:** Starts and stops recording.

**Take Photo:** Takes a still photograph.

**Playback:** Allows you to view video recordings and photos.

**Freeze:** Pauses the camera image.

**Sleep:** Puts the VIRB action camera into a low power mode to conserve battery power. Not available on the VIRB 360 camera.

**Video Setup:** Sets up the video (*VIRB Action Camera Video Setup Settings, page 58*).

**Edit Overlays:** Adjusts the data shown on the screen (*Customizing the Data Overlays, page 5*).

### VIRB Action Camera Video Setup Settings

**NOTE:** Not all options and settings apply to all camera models.

Select **A/V, Gauges, Controls > VIRB® > Menu > Video Setup**.

**Aspect:** Sets the video aspect ratio.

**Video Mode:** Sets the video mode. For example, you can select the Slow-Mo option to shoot slow motion videos.

**Video Size:** Sets the size or pixel dimensions of videos.

**Video FPS:** Sets the frames per second.

**Video Timestamp:** Adds the date and time a video was recorded.

**Photo Timestamp:** Adds the date and time a photo was taken.

**Photo Size:** Sets the size or pixel dimensions of photos.

**Field of View:** Sets the zoom level.

**Lens Mode:** Sets which lens or lenses the camera uses while shooting video.

**Mirror:** Allows you to flip or mirror the video.

**Rotation:** Allows you to rotate the camera angle.

### Adding the VIRB Action Camera Controls to Other Screens

Before you can control a VIRB action camera with the chartplotter, you must connect the devices using a wireless connection (*Connecting a Wireless Device to the Chartplotter, page 8*).

You can add the VIRB action camera control bar to other screens. This allows you to start and stop recording from other functions in the chartplotter.

1 Open the screen to which you want to add the VIRB action camera control bar.

2 Select **Menu > Edit Overlays > Bottom Bar > VIRB Bar**.

When viewing a screen that has the VIRB action camera controls, you can select  to open the full screen view of the VIRB action camera.

## HDMI Out Video Considerations

### NOTICE

To prevent corrosion due to moisture, you must use Garmin GPSMAP accessory cables when connecting the chartplotter to the video display. Using different cables voids your warranty.

The GPSMAP A12/12x3 chartplotter models have HDMI out capability to duplicate the chartplotter screen on another device, such as a television or monitor.

The Garmin GPSMAP HDMI accessory cable is 4.5 m (15 ft.) long. If you need a longer cable, you should use an active HDMI cable only. You need an HDMI coupler to connect the two HDMI cables.

You must make all cable connections in a dry environment.

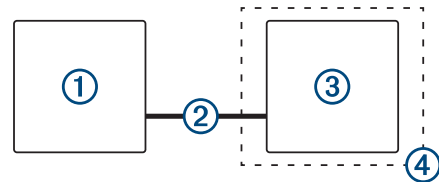

Item	Description
①	GPSMAP A12/12x3 chartplotter
②	GPSMAP HDMI cable (HDMI OUT)
③	Display with an HDMI In port, such as a computer or television
④	Dry environment, protected from moisture

## Pairing the GC™ 100 Camera with a Garmin Chartplotter

Before you can connect a wireless device to the chartplotter wireless network, you must configure the chartplotter wireless network.

- 1 With the camera within an unobstructed 76 m (250 ft.) of the chartplotter, quickly press  three times.
- 2 On the chartplotter, select **Settings > Communications > Wireless Devices > Garmin Camera > Start**.
- 3 Follow the on-screen instructions.

# Device Configuration

## System Settings

Select **Settings > System**.

**Sounds and Display:** Adjusts the display and audio settings.

**GPS:** Provides information about the GPS satellites and settings.

**System Information:** Provides information about the devices on the network and the software version.

**Station Information:** Adjusts the setup of the station.

**Auto Power Up:** Controls which devices turn on automatically when power is applied.

**Auto Power Off:** Automatically turns off the system after it has been asleep for the selected length of time.

**Simulator:** Turns the simulator on or off and allows you to set the time, date, speed, and simulated location.

## Sounds and Display Settings

Select **Settings > System > Sounds and Display**.

**Beeper:** Turns on and off the tone that sounds for alarms and selections.

**Backlight:** Sets the backlight brightness. You can select the Auto option to adjust the backlight brightness automatically based on the ambient light.

**Backlight Sync:** Synchronizes the backlight brightness of other chartplotters in the station.

**Color Mode:** Sets the device to display day or night colors. You can select the Auto option to allow the device to set day or night colors automatically based on the time of day.

**Background:** Sets the background image.

**Startup Image:** Sets the image that appears when you turn on the device.

**Startup Layout:** Sets the layout that appears when you turn on the device.

**Screen Lock:** Sets the anti-theft feature that requires a security PIN (Personal Identification Number) to prevent unauthorized use of the device ([Enabling Screen Lock, page 6](#)).

## GPS Settings

**NOTE:** Not all options are available on all models.

Select **Settings > System > GPS**.

**Skyview:** Shows the relative position of GPS satellites in the sky.

**GLONASS:** Turns on or off GLONASS data (Russia satellite system). When the system is used in situations with poor sky visibility, GLONASS data can be used in combination with GPS to provide more accurate position information.

**WAAS/EGNOS:** Turns on or off WAAS data (in North America) or EGNOS data (in Europe), which can provide more-accurate GPS position information. When using WAAS or EGNOS data, the device may take longer to acquire satellites.

**Galileo:** Turns on or off Galileo data (European Union satellite system). When the system is used in situations with poor sky visibility, Galileo data can be used in combination with GPS to provide more accurate position information.

**Speed Filter:** Averages the speed of your vessel over a short period of time for smoother speed values.

**Source:** Allows you to select the preferred source for GPS data.

## Station Settings

Select **Settings > System > Station Information**.

**Change Station:** Sets the entire station to a new set of defaults based on the location of this station. You can also select to

use this display as a stand-alone, individual display, instead of grouping it with other displays to make a station.

**GRID™ Pairing:** Allows you to pair a GRID remote input device with this station.

**Display Order:** Sets the order of the displays, which is important when using a GRID remote input device.

**Autopilot Enabled:** Allows you to control the autopilot from this device.

**Reset Layouts:** Resets the layouts in this station to the factory default settings.

**Reset Station Settings:** Resets all station settings to on all connected devices in the station to the factory default settings, and requires initial station setup.

## Viewing System Software Information

You can view the software version, the basemap version, all supplemental map information (if applicable), the software version for an optional Garmin radar (if applicable), and the unit ID number. You may need this information to update the system software or to purchase additional map data information.

Select **Settings > System > System Information > Software Information**.

## Viewing the Event Log

The event log shows a list of system events.

Select **Settings > System > System Information > Event Log**.

## Viewing E-label Regulatory and Compliance Information

The label for this device is provided electronically. The e-label may provide regulatory information, such as identification numbers provided by the FCC or regional compliance markings, as well as applicable product and licensing information. Not available on all models.

- 1 Select **Settings**.
- 2 Select **System**.
- 3 Select **Regulatory Information**.

## Preferences Settings

Select **Settings > Preferences**.

**Units:** Sets units of measure.

**Language:** Sets the on-screen text language.

**Navigation:** Sets navigation preferences.

**Keyboard Layout:** Arranges the keys on the on-screen keyboard.

**Screenshot Capture:** Allows the device to save images of the screen.

**Menu Bar Display:** Shows or automatically hides the menu bar when it is not needed.

## Units Settings

Select **Settings > Preferences > Units**.

**System Units:** Sets the unit format for the device.

**Variance:** Sets the magnetic declination, the angle between magnetic north and true north, for your present location.

**North Reference:** Sets the direction references used in calculating heading information. True sets geographic north as the north reference. Grid sets grid north as the north reference (000°). Magnetic sets the magnetic north as the north reference.

**Position Format:** Sets the position format in which a given location reading appears. Do not change this setting unless you are using a map or chart that specifies a different position format.

**Map Datum:** Sets the coordinate system on which the map is structured. Do not change this setting unless you are using a map or chart that specifies a different map datum.

**Time:** Sets the time format, time zone, and daylight saving time.

## Navigation Settings

**NOTE:** Some settings and options require additional charts or hardware.

Select **Settings > Preferences > Navigation**.

**Route Labels:** Sets the type of labels shown with route turns on the map.

**Turn Transition:** Adjusts how the chartplotter transitions to the next turn or leg or the route. You can set the transition to be based on time or distance before the turn. You can increase the time or distance value to help improve the accuracy of the autopilot when navigating a route or an Auto Guidance line with many frequent turns or at higher speeds. For straighter routes or slower speeds, lowering this value can improve autopilot accuracy.

**Speed Sources:** Sets the source for the speed readings.

**Auto Guidance:** Sets the measurements for the Preferred Depth, Vertical Clearance, and Shoreline Distance, when you are using some premium maps.

**Route Start:** Selects a starting point for route navigation.

### Auto Guidance Path Configurations

#### CAUTION

The Preferred Depth and Vertical Clearance settings influence how the chartplotter calculates an Auto Guidance path. If an area has an unknown water depth or an unknown obstacle height, the Auto Guidance path is not calculated in that area. If an area at the beginning or the end of an Auto Guidance path is shallower than the Preferred Depth or lower than the Vertical Clearance settings, the Auto Guidance path may not be calculated in that area, depending on the map data. On the chart, the course through those areas appears as a gray line or a magenta and gray striped line. When your boat enters one of those areas, a warning message appears.

**NOTE:** Auto Guidance is available with premium charts, in some areas.

**NOTE:** Not all settings apply to all maps.

You can set the parameters the chartplotter uses when calculating an Auto Guidance path.

**Preferred Depth:** Sets the minimum water depth, based on chart depth data, that your boat can safely travel over.

**NOTE:** The minimum water depth for the premium charts (made before 2016) is 3 feet. If you enter a value of less than 3 feet, the charts only use depths of 3 feet for Auto Guidance path calculations.

**Vertical Clearance:** Sets the minimum height of a bridge or obstacle, based on chart data, that your boat can safely travel under.

**Shoreline Distance:** Sets how close to the shore you want the Auto Guidance path to be placed. The Auto Guidance path may move if you change this setting while navigating. The available values for this setting are relative, not absolute. To ensure that the Auto Guidance line is placed the appropriate distance from shore, you can assess the placement of the Auto Guidance path using one or more familiar destinations that require navigation through a narrow waterway (*Adjusting the Distance from Shore*, page 21).

### Adjusting the Distance from Shore

The Shoreline Distance setting indicates how close to the shore you want the Auto Guidance line to be placed. The Auto Guidance line may move if you change this setting while navigating. The available values for the Shoreline Distance

setting are relative, not absolute. To ensure the Auto Guidance line is placed the appropriate distance from shore, you can assess the placement of the Auto Guidance line using one or more familiar destinations that require navigation through a narrow waterway.

- 1 Dock your vessel or drop the anchor.
- 2 Select **Settings > Preferences > Navigation > Auto Guidance > Shoreline Distance > Normal**.
- 3 Select a destination that you have navigated to previously.
- 4 Select **Navigate To > Auto Guidance**.
- 5 Review the placement of the Auto Guidance line, and determine whether the line safely avoids known obstacles and the turns enable efficient travel.
- 6 Select an option:
  - If the placement of the Auto Guidance line is satisfactory, select **Menu > Navigation Options > Stop Navigation**, and proceed to step 10.
  - If the Auto Guidance line is too close to known obstacles, select **Settings > Preferences > Navigation > Auto Guidance > Shoreline Distance > Far**.
  - If the turns in the Auto Guidance line are too wide, select **Settings > Preferences > Navigation > Auto Guidance > Shoreline Distance > Near**.
- 7 If you selected **Near** or **Far** in step 6, review the placement of the Auto Guidance line, and determine whether the line safely avoids known obstacles and the turns enable efficient travel.

Auto Guidance maintains a wide clearance from obstacles in open water, even if you set the Shoreline Distance setting to **Near** or **Nearest**. As a result, the chartplotter may not reposition the Auto Guidance line, unless the destination selected requires navigation through a narrow waterway.

- 8 Select an option:
  - If the placement of the Auto Guidance line is satisfactory, select **Menu > Navigation Options > Stop Navigation**, and proceed to step 10.
  - If the Auto Guidance line is too close to known obstacles, select **Settings > Preferences > Navigation > Auto Guidance > Shoreline Distance > Farthest**.
  - If the turns in the Auto Guidance line are too wide, select **Settings > Preferences > Navigation > Auto Guidance > Shoreline Distance > Nearest**.
- 9 If you selected **Nearest** or **Farthest** in step 8, review the placement of the **Auto Guidance** line, and determine whether the line safely avoids known obstacles and the turns enable efficient travel.

Auto Guidance maintains a wide clearance from obstacles in open water, even if you set the Shoreline Distance setting to **Near** or **Nearest**. As a result, the chartplotter may not reposition the Auto Guidance line, unless the destination selected requires navigation through a narrow waterway.
- 10 Repeat steps 3 through 9 at least once more, using a different destination each time, until you are familiar with the functionality of the Shoreline Distance setting.

## Communications Settings

### NMEA 0183 Settings

Select **Settings > Communications > NMEA 0183 Setup**.

**Port Types:** See *Setting the Communication Format for Each NMEA 0183 Port*, page 61.

**Output Sentences:** See *Configuring NMEA 0183 Output Sentences*, page 61.

**Position Precision:** Adjusts the number of digits to the right of the decimal point for transmission of NMEA output.

**XTE Precision:** Adjusts the number of digits to the right of the decimal point for NMEA crosstalk error output.

**Waypoint IDs:** Sets the device to transmit waypoint names or numbers via NMEA 0183 while navigating. Using numbers may resolve compatibility issues with older NMEA 0183 autopilots.

**Restore Defaults:** Restores the NMEA 0183 settings to the original factory defaults.

**Diagnostics:** Displays NMEA 0183 diagnostic information.

### Configuring NMEA 0183 Output Sentences

You can enable and disable NMEA 0183 output sentences.

- 1 Select **Settings > Communications > NMEA 0183 Setup > Output Sentences**.
- 2 Select an option.
- 3 Select one or more NMEA 0183 output sentences, and select **Back**.
- 4 Repeat steps 2 and 3 to enable or disable additional output sentences.

### Setting the Communication Format for Each NMEA 0183 Port

You can configure the communication format for each internal NMEA 0183 port when connecting your chartplotter to external NMEA 0183 devices, a computer, or other Garmin devices.

- 1 Select **Settings > Communications > NMEA 0183 Setup > Port Types**.
- 2 Select an input or output port.
- 3 Select a format:
  - To support the input or output of standard NMEA 0183 data, DSC, and sonar NMEA input support for the DPT, MTW, and VHW sentences, select **NMEA Std.**
  - To support the input or output of standard NMEA 0183 data for most AIS receivers, select **NMEA High Speed**.
  - To support the input or output of Garmin proprietary data for interfacing with Garmin software, select **Garmin**.
- 4 Repeat steps 2–3 to configure additional input or output ports.

### NMEA 2000 Settings

Select **Settings > Communications > NMEA 2000 Setup**.

**Device List:** Displays the devices connected to the network and allows you to set options for some transducers connected using the NMEA 2000 network.

**Label Devices:** Changes the labels for available connected devices.

### Naming Devices and Sensors on the Network

You can name devices and sensors connected to the Garmin Marine Network and the NMEA 2000 network.

- 1 Select **Settings > Communications**.
- 2 Select **Marine Network** or **NMEA 2000 Setup > Device List**.
- 3 Select a device from the list on the left.
- 4 Select **Review > Change Name**.
- 5 Enter the name, and select **Done**.

### Marine Network

The Marine Network allows you to share data from Garmin peripheral devices with the chartplotters quickly and easily. You can connect a chartplotter to the Marine Network to receive data from and share data with other devices and chartplotters that are compatible with the Marine Network.

Select **Settings > Communications > Marine Network**.

## Setting Alarms

### ⚠ CAUTION

The Beeper setting must be turned on to make alarms audible (*Sounds and Display Settings*, page 59). Failure to set audible alarms could lead to injury or property damage.

### Navigation Alarms

Select **Settings > Alarms > Navigation**.

**Arrival:** Sets an alarm to sound when you are within a specified distance or time from a turn or a destination.

**Anchor Drag:** Sets an alarm to sound when you exceed a specified drift distance while anchored.

**Off Course:** Sets an alarm to sound when you are off course by a specified distance.

**Boundary Alarms:** Disables and enables all boundary alarms.

### Setting the Anchor Drag Alarm

You can set an alarm to sound if you have moved more than an allowable distance. This is very useful when anchoring overnight.

- 1 Select **Settings > Alarms > Navigation > Anchor Drag**.
- 2 Select **Alarm** to turn on the alarm.
- 3 Select **Set Radius**, and select a distance on the chart.
- 4 Select **Back**.

### System Alarms

**Alarm Clock:** Sets an alarm clock.

**Unit Voltage:** Sets an alarm to sound when the battery reaches a specified low voltage.

**GPS Accuracy:** Sets an alarm to sound when the GPS location accuracy falls outside the user-defined value.

### Sonar Alarms

**NOTE:** Not all options are available on all transducers.

From an applicable sonar view, select **Menu > Sonar Setup > Alarms**.

You can also open the sonar alarms by selecting **Settings > Alarms > Sonar**.

**Shallow Water:** Sets an alarm to sound when the depth is less than the specified value.

**Deep Water:** Sets an alarm to sound when the depth is greater than the specified value.



**FrontVü Alarm:** Sets an alarm to sound when the depth in front of the vessel is less than the specified value, which can help you avoid running aground (*Setting the FrontVü Depth Alarm*, page 33). This alarm is available only with Panoptix FrontVü transducers.

**Water Temp.:** Sets an alarm to sound when the transducer reports a temperature that is 2°F (1.1°C) above or below the specified temperature.

**Contour:** Sets an alarm to sound when the transducer detects a suspended target within the specified depth from the surface of the water and from the bottom.

### Fish

**Fish:** Sets an alarm to sound when the device detects a suspended target.

-  sets the alarm to sound when fish of all sizes are detected.
-  sets the alarm to sound only when medium or large fish are detected.
-  sets the alarm to sound only when large fish are detected.

## Setting Weather Alarms

Before you can set weather alarms, you must have a compatible chartplotter connected to a weather device, such as a GXM device, and have a valid weather subscription.

- 1 Select **Settings > Alarms > Weather**.
- 2 Turn on alarms for specific weather events.

## Setting the Fuel Alarm

Before you can set a fuel level alarm, a compatible fuel flow sensor must be connected to the chartplotter.

You can set an alarm to sound when the total amount of remaining onboard fuel reaches the level you specify.

- 1 Select **Settings > Alarms > Fuel > Set Total Fuel Onboard > On**.
- 2 Enter the remaining amount of fuel that triggers the alarm, and select **Done**.

## My Vessel Settings

**NOTE:** Some settings and options require additional charts or hardware.

Select **Settings > My Vessel**.

**Transducers:** Shows all transducers on the network, allows you to change transducers, and allows you to view diagnostic information (*Selecting the Transducer Type*, page 28).

**Depth and Anchoring:** Allows you to enter information about the keel (*Setting the Keel Offset*, page 24) and the anchor.

The Anchor Height value is the height of the anchor above the waterline. The Anchor Scope value is the ratio of the length of anchor rode in use to the vertical distance from the bow of the vessel to the bottom of the water. These anchor settings are used to calculate the Target Anchor Rode date field.

**Temp. Offset:** Allows you to set an offset value to compensate for the water temperature reading from a NMEA 0183 water-temperature sensor or a temperature-capable transducer (*Setting the Water Temperature Offset*, page 62).

**Calibrate Water Speed:** Calibrates the speed-sensing transducer or sensor (*Calibrating a Water-Speed Device*, page 63).

**Fuel Capacity:** Sets the combined fuel capacity of all the fuel tanks on your vessel (*Setting the Fuel Capacity of the Vessel*, page 47).

**Vessel Type:** Enables some chartplotter features based on the boat type.

**CZone™:** Sets the digital switching circuits.

**SeaStar Instance:** Sets the digital switching circuits.

**System Profiles:** Allows you to save your system profile to a memory card and import system profile settings from a memory card. This can be helpful for charter or fleet vessels, and for sharing your setup information with a friend.

**Hull ID Number:** Allows you to enter the Hull Identification Number (HIN). The HIN might be permanently affixed to the upper starboard side of the transom or outboard side.

**Optimus Steering:** Allows you to adjust the Optimus steering parameters.

## Setting the Keel Offset

You can enter a keel offset to compensate the water depth reading for the transducer installation location. This allows you to view the depth of the water below the keel or the true depth of the water, depending on your needs.

If you want to know the water depth below the keel or the lowest point of your boat and the transducer is installed at the water line or anywhere above the end of the keel, measure the distance from the transducer location to the keel of the boat.

If you want to know the true water depth and the transducer is installed below the water line, measure the distance from the bottom of the transducer up to the water line.

**NOTE:** This option is only available when you have valid depth data.

- 1 Measure the distance:
  - If the transducer is installed at the water line ① or anywhere above the end of the keel, measure the distance from the transducer location to the keel of the boat. Enter this value as a positive number.
  - If the transducer is installed at the bottom of the keel ② and you want to know the true depth of the water, measure the distance from the transducer to the water line. Enter this value in as a negative number.

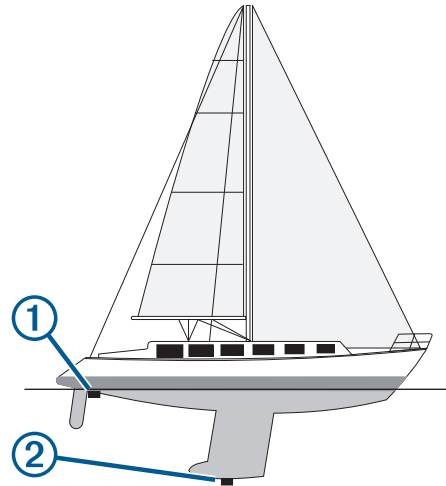

- 2 Complete an action:

- If the transducer is connected to the chartplotter or a sonar module, select **Settings > My Vessel > Depth and Anchoring > Keel Offset**.
- If the transducer is connected to the NMEA 2000 network, select **Settings > Communications > NMEA 2000 Setup > Device List**, select the transducer, and select **Review > Keel Offset**.

- 3 Select **+** if the transducer is installed at the water line, or select **-** if the transducer is installed at the bottom of the keel.

- 4 Enter the distance measured in step 1.

## Setting the Water Temperature Offset

The temperature offset compensates for the temperature reading from a temperature sensor or temperature-capable transducer.

- 1 Measure the water temperature using the temperature sensor or temperature-capable transducer that is connected to the network.
- 2 Measure the water temperature using a different temperature sensor or a thermometer that is known to be accurate.
- 3 Subtract the water temperature measured in step 1 from the water temperature measured in step 2.

This value is the temperature offset. Enter this value in step 5 as a positive number if the sensor measures the water temperature as being colder than it actually is. Enter this value in step 5 as a negative number if the sensor measures the water temperature as being warmer than it actually is.

- 4 Complete an action:

- If the sensor or transducer is connected to the chartplotter or a sonar module, select **Settings > My Vessel > Temp. Offset**.

- If the sensor or transducer is connected to the NMEA 2000 network, select **Settings > Communications > NMEA 2000 Setup > Device List**, select the transducer, and select **Review > Temp. Offset**.

5 Enter the temperature offset value calculated in step 3.

### Calibrating a Water-Speed Device

If you have a speed sensor or a speed-sensing transducer connected, you can calibrate that speed-sensing device to improve the accuracy of water-speed data displayed by the chartplotter.

1 Complete an action:

- If the sensor or transducer is connected to the chartplotter or a sonar module, select **Settings > My Vessel > Calibrate Water Speed**.
- If the sensor or transducer is connected to the NMEA 2000 network, select **Settings > Communications > NMEA 2000 Setup > Device List**, select the transducer, and select **Review > Calibrate Water Speed**.

2 Follow the on-screen instructions.

If the boat is not moving fast enough or the speed sensor is not registering a speed, a message appears.

3 Select **OK**, and safely increase the boat speed.

4 If the message appears again, stop the boat, and ensure the speed-sensor wheel is not stuck.

5 If the wheel turns freely, check the cable connections.

6 If you continue to get the message, contact Garmin product support.

### Other Vessels Settings

When your compatible chartplotter is connected to an AIS device or VHF radio, you can set up how other vessels are displayed on the chartplotter.

Select **Settings > Other Vessels**.

**AIS:** Enables and disables AIS signal reception.

**DSC:** Enables and disables digital selective calling (DSC).

**Collision Alarm:** Sets the collision alarm ([Setting the Safe-Zone Collision Alarm](#), page 12).

**AIS-EPIRB Test:** Enables test signals from Emergency Position Indicating Radio Beacons (EPIRB).

**AIS-MOB Test:** Enables test signals from man overboard (MOB) devices.

**AIS-SART Test:** Enables test transmissions from Search and Rescue Transponders (SART).

### Settings that are Synced on the Garmin Marine Network

The following devices sync certain settings when connected to the Garmin Marine Network.

- ECHOMAP™ 70 series
- GPSMAP 507 series (software version 3.0 or later)
- GPSMAP 701 series (software version 3.0 or later)
- GPSMAP 702 series
- GPSMAP 800 series
- GPSMAP 902 series
- GPSMAP 1000 series
- GPSMAP 1002 series
- GPSMAP 1202 series
- GPSMAP 7400/7600 series
- GPSMAP 8400/8600/8700 series

The following settings are synced, if applicable, to the device.

Alarm Settings (also syncs alarm acknowledgment):

- Arrival
- Anchor Drag
- Off Course
- GPS Accuracy
- Shallow Water
- Deep Water (Not available in the GPSMAP 8400/8600 series)
- Water Temp.
- Contour (Not available in echoMAP 70s and GPSMAP 507/701 series)

- Fish
- Collision Alarm

General Settings:

- Auto Guidance Preferred Depth
- Auto Guidance Vertical Clearance
- Beeper
- Color Mode
- Keyboard Layout
- Language
- Map Datum
- North Reference
- Position Format
- System Units
- Calibrate Water Speed
- Radar Antenna Size

Chart Settings:

- Chart Borders
- Hazard Colors
- Heading Line
- Land POIs
- Light Sectors
- Navaid Size
- Navaid Type
- Photo Points
- Preferred Depth
- Shallow Shading
- Service Points
- Vessel Icon (Cannot be synced between all models)

### Restoring the Original Chartplotter Factory Settings

**NOTE:** This affects all devices on the network.

1 Select **Settings > System > System Information > Reset**.

2 Select an option:

- To reset the device settings to the factory default values, select **Reset Default Settings**. This restores the default configuration settings, but does not remove saved user data, maps, or software updates.
- To reset all settings in all devices in the station to the factory default values, select **Reset Station Settings**. This restores the default configuration settings, but does not remove saved user data, maps, or software updates
- To clear saved data, such as waypoints and routes, select **Delete User Data**. This does not affect maps or software updates.
- To clear saved data and reset device settings to the factory default values, disconnect the chartplotter from the Garmin Marine Network, and select **Delete Data and**

**Reset Settings.** This does not affect maps or software updates.

## Sharing and Managing User Data

You can share user data between compatible devices. User data includes waypoints, saved tracks, routes, and boundaries.

- You can share data across the Garmin Marine Network.
- You can share and manage user data using a memory card. You must have a memory card installed in the device. This device supports up to a 32 GB memory card, formatted to FAT32.

### Selecting a File Type for Third-Party Waypoints and Routes

You can import and export waypoints and routes from third-party devices.

- 1 Insert a memory card into the card slot.
- 2 Select **Info > User Data > Data Transfer > File Type.**
- 3 Select **GPX.**

To transfer data with Garmin devices again, select the ADM file type.

### Copying User Data from a Memory Card

You can transfer user data from a memory card to transfer from other devices. User data includes waypoints, routes, Auto Guidance paths, tracks, and boundaries.

**NOTE:** Only boundary files with an .adm extension are supported.

- 1 Insert a memory card into a card slot.
- 2 Select **Info > User Data > Data Transfer.**
- 3 If necessary, select the memory card to copy data to.
- 4 Select an option:
  - To transfer data from the memory card to the chartplotter and combine it with existing user data, select **Merge from Card.**
  - To transfer data from the memory card to the chartplotter and overwrite existing user data, select **Replace from Card.**
- 5 Select the file name.

### Copying User Data to a Memory Card

You can save user data to a memory card to transfer to other devices. User data includes waypoints, routes, Auto Guidance paths, tracks, and boundaries.

- 1 Insert a memory card into the card slot.
- 2 Select **Info > User Data > Data Transfer > Save to Card.**
- 3 If necessary, select the memory card to copy the data to.
- 4 Select an option:
  - To create a new file, select **Add New File**, and enter a name.
  - To add the information to an existing file, select the file from the list, and select **Save to Card.**

### Updating Built-In Maps with a Memory Card and Garmin Express

You can update the built-in maps using Garmin Express and a memory card.

- 1 Insert a memory card into the computer's card slot.
- 2 Open the Garmin Express application.

If you do not have the Garmin Express application installed on your computer, you can download it from [garmin.com/express](http://garmin.com/express).

- 3 If necessary, register your device (*Registering Your Device Using the Garmin Express App*, page 65).
- 4 Click **Vessel > View Details.**
- 5 Click **Download** next to the map to update.
- 6 Follow the on-screen instructions to complete the download.
- 7 Wait while the update downloads.  
The update may take an extended period of time.
- 8 After the download is complete, eject the card from the computer.
- 9 Insert the memory card into the card slot (*Memory Cards*, page 2).
- 10 On the chartplotter, select **Settings > System > System Information > Update Built-In Map.**

The updated chart appears on your chartplotter.

### Backing Up Data to a Computer

- 1 Insert a memory card into the card slot.
- 2 Select **Info > User Data > Data Transfer > Save to Card.**
- 3 Select a file name from the list, or select **Add New File.**
- 4 Select **Save to Card.**
- 5 Remove the memory card, and insert it into a card reader attached to a computer.
- 6 Open the Garmin\UserData folder on the memory card.
- 7 Copy the backup file on the card and paste it to any location on the computer.

### Restoring Backup Data to a Chartplotter

- 1 Insert a memory card into a card reader that is attached to the computer.
- 2 Copy a backup file from the computer to the memory card, into a folder named Garmin\UserData.
- 3 Insert a memory card into the card slot.
- 4 Select **Info > User Data > Data Transfer > Replace from Card.**

### Saving System Information to a Memory Card

You can save system information to a memory card as a troubleshooting tool. A product support representative may ask you to use this information to retrieve data about the network.

- 1 Insert a memory card into the card slot.
- 2 Select **Settings > System > System Information > Garmin Devices > Save to Card.**
- 3 If necessary, select the memory card to save system information to.
- 4 Remove the memory card.

## Appendix

### ActiveCaptain and Garmin Express

The ActiveCaptain and Garmin Express apps help you manage your Garmin chartplotter and other devices.

**ActiveCaptain:** The ActiveCaptain mobile app provides an easy-to-use connection between your compatible mobile device and your compatible Garmin chartplotter, charts, and the Garmin Quickdraw Contours Community (*ActiveCaptain App*, page 6). The app allows you to monitor and track your boat with the OnDeck™ system, provides unlimited access to



your cartography and a quick, mobile way to download new charts using the OneChart™ feature, provides a link to receive notifications on your chartplotter, and provides access to the ActiveCaptain Community for feedback on marinas and other boating points of interest. You can also use the app to plan your trip and sync user data. The app checks your devices for available updates, and notifies you when an update is available.

**Garmin Express:** The Garmin Express desktop app allows you to use your computer and a memory card to download and update Garmin chartplotter software and charts (*Garmin Express App, page 65*). You should use the Garmin Express app for faster data transfer of larger downloads and updates, and to avoid possible data charges with some mobile devices.

Function	ActiveCaptain mobile app	Garmin Express desktop app
Register your new Garmin Marine device	Yes	Yes
Update your Garmin chartplotter software	Yes	Yes
Update your Garmin charts	Yes	Yes
Download new Garmin charts	Yes	Yes
Access the Garmin Quickdraw Contours Community to download and share contours with other users	Yes	No
Monitor and track your boat with the OnDeck system	Yes	No
Sync a mobile device with your Garmin chartplotter	Yes	No
Access the ActiveCaptain Community for feedback on marinas and boating points of interest	Yes	No
Receive smart notification on the chartplotter	Yes	No

## Garmin Express App

The Garmin Express desktop app allows you to use your computer and a memory card to download and update Garmin device software and charts and register your devices. We recommend it for larger downloads and updates for faster data transfer and to avoid possible data charges with some mobile devices.

### Installing the Garmin Express App on a Computer

You can install the Garmin Express app on a Windows® or Mac® computer.

- 1 Go to [garmin.com/express](http://garmin.com/express).
- 2 Select **Download for Windows** or **Download for Mac**.
- 3 Follow the on-screen instructions.

### Registering Your Device Using the Garmin Express App

**NOTE:** You should use the ActiveCaptain app and a mobile device to register the device (*Getting Started with the ActiveCaptain App, page 6*).

Help us better support you by completing our online registration today. Keep the original sales receipt, or a photocopy, in a safe place.

- 1 Install the Garmin Express app on your computer (*Installing the Garmin Express App on a Computer, page 65*).
- 2 Insert a memory card into the card slot (*Memory Cards, page 2*).
- 3 Wait a few moments.

The chartplotter opens the card management page and creates a file named GarminDevice.xml in the Garmin folder on the memory card.

- 4 Remove the memory card from your device.
- 5 Open the Garmin Express app on your computer.
- 6 Insert the memory card into your computer.
- 7 If necessary, select **Get Started**.
- 8 If necessary, while the application searches, select **Sign In** next to **Have marine charts or devices?** near the bottom of the screen.
- 9 Create or sign in to your Garmin account.
- 10 Follow the on-screen instructions to set up your vessel.
- 11 Select **+Add**.

The Garmin Express application searches the memory card for the device information.

- 12 Select **Add Device** to register the device.

When registration is complete, the Garmin Express application searches for additional charts and chart updates for your device.

When you add devices to the chartplotter network, repeat these steps to register the new devices using the Garmin Express app.

### Updating Your Charts Using the Garmin Express App

This device supports up to a 32 GB memory card, formatted to FAT32 with speed class 4 or higher. Use of an 8 GB or higher memory card with speed class 10 is recommended.

Downloading the chart update may take up to a few hours.

You should use a blank memory card for chart updates. The update process erases the content on the card and reformats the card.

- 1 Install the Garmin Express app on your computer (*Installing the Garmin Express App on a Computer, page 65*).
- 2 Open the Garmin Express app on your computer.
- 3 Select your vessel and device.
- 4 If chart updates are available, select **Chart Updates > Continue**.
- 5 Read and agree to the terms.
- 6 Insert your chartplotter chart memory card into the computer.
- 7 Select the drive for the memory card.
- 8 Review the reformat warning, and select **OK**.
- 9 Wait while the chart update is copied to the memory card.  
**NOTE:** Copying the update file onto the card may take from a few minutes up to a few hours.
- 10 Close the Garmin Express app.
- 11 Eject the memory card from the computer.
- 12 Turn on the chartplotter.
- 13 After the home screen appears, insert the memory card into the card slot.  
**NOTE:** In order for the update instructions to appear, the device must be fully booted before the card is inserted.
- 14 Select **Update Software > Yes**.
- 15 Wait several minutes while the update process completes.
- 16 When prompted, leave the memory card in place, and restart the chartplotter.
- 17 Remove the memory card.  
**NOTE:** If the memory card is removed before the device restarts fully, the update is not complete.

### Software Updates

You may need to update the software when you install a new device or add an accessory.

You can use the ActiveCaptain mobile app to update the device software (*Updating Software with the ActiveCaptain App*, page 7).

You can also use the Garmin Express desktop app to update your chartplotter software (*Loading the New Software on a Memory Card Using Garmin Express*, page 66).

This device supports up to a 32 GB memory card, formatted to FAT32 with speed class 4 or higher. Use of an 8 GB or higher memory card with speed class 10 is recommended.

Before you update the software, you should check the software version installed on your device (*Viewing System Software Information*, page 59). Then, you can go to [garmin.com/support/software/marine.html](http://garmin.com/support/software/marine.html), select See All Devices in this Bundle, and compare the installed software version to the software version listed for your product.

If the software version installed on your device is older than the version listed on the website, you should update the software using the ActiveCaptain mobile app (*Updating Software with the ActiveCaptain App*, page 7) or the Garmin Express desktop app (*Loading the New Software on a Memory Card Using Garmin Express*, page 66).

### **Loading the New Software on a Memory Card Using Garmin Express**

You can copy the software update to a memory card using a computer with the Garmin Express app.

This device supports up to a 32 GB memory card, formatted to FAT32 with speed class 4 or higher. Use of an 8 GB or higher memory card with speed class 10 is recommended.

Downloading the software update may take from a few minutes up to a few hours.

You should use a blank memory card for software updates. The update process erases the content on the card and reformats the card.

- 1 Insert a memory card into the card slot on the computer.
- 2 Install the Garmin Express app (*Installing the Garmin Express App on a Computer*, page 65).
- 3 Select your vessel and device.
- 4 Select **Software Updates > Continue**.
- 5 Read and agree to the terms.
- 6 Select the drive for the memory card.
- 7 Review the reformat warning, and select **Continue**.
- 8 Wait while the software update is copied to the memory card.

**NOTE:** Copying the update file onto the card may take from a few minutes up to a few hours.

- 9 Close the Garmin Express app.
- 10 Eject the memory card from the computer.

After loading the update onto the memory card, install the software on the chartplotter (*Updating the Device Software Using a Memory Card*, page 66).

### **Updating the Device Software Using a Memory Card**

To update the software using a memory card, you must obtain a software-update memory card or load the latest software onto a memory card using the Garmin Express app (*Loading the New Software on a Memory Card Using Garmin Express*, page 66).

- 1 Turn on the chartplotter.
- 2 After the home screen appears, insert the memory card into the card slot.

**NOTE:** In order for the software update instructions to appear, the device must be fully booted before the card is inserted.

- 3 Select **Update Software > Yes**.
- 4 Wait several minutes while the software update process completes.

- 5 When prompted, leave the memory card in place, and restart the chartplotter.

- 6 Remove the memory card.

**NOTE:** If the memory card is removed before the device restarts fully, the software update is not complete.

## **Pairing the GRID Device with the Chartplotter from the Chartplotter**

**NOTE:** These steps are applicable to both the GRID device and the GRID 20 device.

Before you can pair the GRID 20 device with the chartplotter to make the data connection, you must supply power using batteries, the included power cable, or a NMEA 2000 network connection.

Before you can pair the GRID device with the chartplotter, you must connect it to the Garmin Marine Network.

- 1 Select **Settings > System > Station Information > GRID™ Pairing > Add**.
- 2 Select an action:
  - On the GRID remote input device, press **SELECT**.
  - On the GRID 20 remote input device, press ◀ and ▶ until the remote control beeps three times.

### **Pairing the GRID Device with the Chartplotter from the GRID Device**

**NOTE:** This is not applicable to the GRID 20 device.

- 1 On the GRID remote input device, press **+** and **HOME** at the same time.

A selection page opens on all of the chartplotters on the Garmin Marine Network.
- 2 Rotate the wheel on the GRID remote input device to highlight **Select** on the chartplotter you want to control with the GRID remote input device.
- 3 Press **SELECT**.

### **Rotating the GRID Remote Input Device**

For certain installation situations, you can rotate the orientation of the GRID device.

**NOTE:** This is not applicable to the GRID 20 device.

- 1 Select **Settings > Communications > Marine Network**.
- 2 Select the GRID device.

## **Cleaning the Screen**

### **NOTICE**

Cleaners containing ammonia will harm the anti-reflective coating.

The device is coated with a special anti-reflective coating which is very sensitive to waxes and abrasive cleaners.

- 1 Apply an eyeglass lens cleaner specified as safe for anti-reflective coatings to the cloth.
- 2 Gently wipe the screen with a soft, clean, lint-free cloth.

## **Viewing Images on a Memory card**

You can view images that are saved on a memory card. You can view .jpg, .png, and .bmp files.

- 1 Insert a memory card with image files into the card slot.
- 2 Select **Info > Image Viewer**.
- 3 Select the folder containing the images.
- 4 Wait a few seconds for the thumbnail images to load.
- 5 Select an image.
- 6 Use the arrows to scroll through the images.

7 If necessary, select **Menu > Start Slideshow**.

## Screenshots

You can capture a screenshot of any screen shown on your chartplotter as a .png file. You can transfer the screenshot to your computer. You can also view the screenshot in the image viewer (*Viewing Images on a Memory card, page 66*).

### Capturing Screenshots

- 1 Insert a memory card into the card slot.
- 2 Select **Settings > Preferences > Screenshot Capture > On**.
- 3 Go to a screen you want to capture.
- 4 Hold **Home** for at least six seconds.

### Copying Screenshots to a Computer

- 1 Remove the memory card from the chartplotter, and insert it into a card reader that is attached to a computer.
- 2 From Windows Explorer, open the Garmin\scrn folder on the memory card.
- 3 Copy a .bmp file from the card and paste it to any location on the computer.

## Troubleshooting

### My device will not acquire GPS signals

If the device is not acquiring satellite signals, there could be a few causes. If the device has moved a large distance since the last time it has acquired satellites or has been turned off for longer than a few weeks or months, the device may not be able to acquire the satellites correctly.

- Ensure the device is using the latest software. If not, update the device software (*Software Updates, page 65*).
- Make sure the device has a clear view of the sky so the antenna can receive the GPS signal. If it is mounted inside of a cabin, it should be close to a window so it can receive the GPS signal.

### My device will not turn on or keeps turning off

Devices erratically turning off or not turning on could indicate an issue with the power supplied to the device. Check these items to attempt to troubleshoot the cause of the power issue.

- Make sure the power source is generating power.  
You can check this several ways. For example, you can check whether other devices powered by the source are functioning.
- Check the fuse in the power cable.  
The fuse should be located in a holder that is part of the red wire of the power cable. Check that the proper size fuse is installed. Refer to the label on the cable or the installation instructions for the exact fuse size needed. Check the fuse to make sure there is still a connection inside of the fuse. You can test the fuse using a multimeter. If the fuse is good, the multimeter reads 0 ohm.
- Check to make sure the device is receiving at least 12 V.  
To check the voltage, measure the female power and ground sockets of the power cable for DC voltage. If the voltage is less than 12 V, the device will not turn on.
- If the device is receiving enough power but does not turn on, contact Garmin product support.

### My device is not creating waypoints in the correct location

You can manually enter a waypoint location to transfer and share data from one device to the next. If you have manually entered a waypoint using coordinates, and the location of the point does not appear where the point should be, the map

datum and position format of the device may not match the map datum and position format originally used to mark the waypoint.

Position format is the way in which the GPS receiver's position appears on the screen. This is commonly displayed as latitude/longitude in degrees and minutes, with options for degrees, minutes and second, degrees only, or one of several grid formats.

Map datum is a math model which depicts a part of the surface of the earth. Latitude and longitude lines on a paper map are referenced to a specific map datum.

- 1 Find out which map datum and position format was used when the original waypoint was created.  
If the original waypoint was taken from a map, there should be a legend on the map that lists the map datum and position format used to create that map. Most often this is found near the map key.
- 2 Select **Settings > Preferences > Units**.
- 3 Select the correct map datum and position format settings.
- 4 Create the waypoint again.

## Contacting Garmin Support

- Go to [support.garmin.com](http://support.garmin.com) for help and information, such as product manuals, frequently asked questions, videos, and customer support.
- In the USA, call 913-397-8200 or 1-800-800-1020.
- In the UK, call 0808 238 0000.
- In Europe, call +44 (0) 870 850 1241.

## Specifications

### GPSPMAP 7x2/7x2 Plus Specifications

Dimensions (W × H × D)	22.4 × 14.3 × 5.4 cm (8.8 × 5.6 × 2.1 in.)
Display size (W × H)	15.4 × 8.6 cm (6.1 × 3.4 in.) 7 in. diagonal
Display resolution	WVGA, 800 × 480 pixels
Weight	0.86 kg (1.9 lb.)
Compass-safe distance	71 cm (28 in.)
Temperature range	From -15° to 55°C (from 5° to 131°F)
Material	Polycarbonate plastic and die-cast aluminum
Water rating	IEC 60529 IPX7 <sup>1</sup>
Fuse	6 A, 125 V fast-acting
Input voltage	From 10 to 32 Vdc
Max. power usage at 10 Vdc	24 W
Typical current draw at 12 Vdc	1.5 A
Max. current draw at 12 Vdc	2.0 A
NMEA 2000 LEN @ 9 Vdc	2
NMEA 2000 draw	75 mA max.
Max. waypoints	5,000
Max. routes	100
Max. active track points	50,000 points, 50 saved tracks
Wireless frequency	2.4 GHz @ 17.6 dBm nominal
Memory card	2 SD card slots; 32 GB max. card size
HTML integration	Compatible with OneHelm™ integration (Plus models only)

<sup>1</sup> The device withstands incidental exposure to water of up to 1 m for up to 30 min. For more information, go to [www.garmin.com/waterrating](http://www.garmin.com/waterrating).

## GPSMAP 9x2/9x2 Plus Specifications

Dimensions (W × H × D)	25.6 × 16.2 × 5.2 cm (10.1 × 6.4 × 2.1 in.)
Display size (W × H)	19.6 × 11.4 cm (7.7 × 4.5 in.) 9 in. diagonal
Display resolution	WSVGA, 1024 × 600 pixels
Weight	9x2: 1.14 kg (2.5 lb.) 9x2 Plus: 1.27 kg (2.8 lb.)
Compass-safe distance	76 cm (30 in.)
Temperature range	From -15° to 55°C (from 5° to 131°F)
Material	Polycarbonate plastic and die-cast aluminum
Water rating	IEC 60529 IPX7 <sup>1</sup>
Fuse	6 A, 125 V fast-acting
Input voltage	From 10 to 32 Vdc
Max. power usage at 10 Vdc	27 W
Typical current draw at 12 Vdc	1.3 A
Max. current draw at 12 Vdc	2.3 A
NMEA 2000 LEN @ 9 Vdc	2
NMEA 2000 draw	75 mA max.
Max. waypoints	5,000
Max. routes	100
Max. active track points	50,000 points, 50 saved tracks
Wireless frequency	2.4 GHz @ 17.6 dBm nominal
Memory card	2 SD card slots; 32 GB max. card size
HTML integration	Compatible with OneHelm integration (Plus models only)

## GPSMAP 12x2 Touch/A12/12x2 Plus Specifications

Dimensions (W × H × D)	33.0 × 22.6 × 7.9 cm (13.0 × 8.9 × 3.1 in.)
Display size (W × H)	26.2 × 16.3 cm (10.3 × 6.4 in.) 12 in. diagonal
Display resolution	WXGA, 1280 × 800 pixels
Weight	2.72 kg (6.0 lb.)
Compass-safe distance	65 cm (25.6 in.)
Clearance to nearest obstruction	9.5 cm (3 <sup>3</sup> / <sub>4</sub> in.)
Temperature range	From -15° to 55°C (from 5° to 131°F)
Material	Polycarbonate plastic and die-cast aluminum
Water rating	IEC 60529 IPX7 <sup>1</sup>
Fuse	6 A, 125 V fast-acting
Input voltage	From 10 to 32 Vdc
Max. power usage at 10 Vdc	36 W
Typical current draw at 12 Vdc	2.5 A
Max. current draw at 12 Vdc	3.0 A
NMEA 2000 LEN @ 9 Vdc	2
NMEA 2000 Draw	75 mA max.
Max. waypoints	5,000
Max. routes	100
Max. active track points	50,000 points, 50 saved tracks
Memory card	2 SD card slots; 32 GB max. card size
Wireless frequency	2.4 GHz @ 19.5 dBm nominal
HTML integration	Compatible with OneHelm integration (Plus models only)

<sup>1</sup> The device withstands incidental exposure to water of up to 1 m for up to 30 min. For more information, go to [www.garmin.com/waterrating](http://www.garmin.com/waterrating).

## GPSMAP 7x3 Specifications

Dimensions (W × H × D)	192.3 × 140.3 × 74.1 mm (7 <sup>9</sup> / <sub>16</sub> × 5 <sup>1</sup> / <sub>2</sub> × 2 <sup>15</sup> / <sub>16</sub> in.)
Clearance to next obstruction	27.8 mm (2 in.)
Display size (W × H)	154.6 × 91.0 mm (6 <sup>1</sup> / <sub>16</sub> × 3 <sup>9</sup> / <sub>16</sub> in.) 17.8 cm (7.0 in.) diagonal
Display resolution	WSVGA, 1024 × 600 pixels
Weight	1.3 kg (2.8 lb.)
Compass-safe distance	35 cm (13.78 in.)
Max. power usage at 10 Vdc	Non-sonar models: 17.6 W Sonar models: 35.9 W
Typical current draw at 12 Vdc	Non-sonar models: 1.08 A Sonar models: 1.18 A
Max. current draw at 12 Vdc	Non-sonar models: 1.45 A Sonar models: 2.96 A
Temperature range	From -15° to 55°C (from 5° to 131°F)
Material	Polycarbonate plastic and die-cast aluminum
Water rating	IEC 60529 IPX7 <sup>1</sup>
Input voltage	From 10 to 32 Vdc
Fuse	6 A, 125 V fast-acting
NMEA 2000 LEN @ 9 Vdc	2
NMEA 2000 draw	75 mA max.
Max. waypoints	5,000
Max. routes	100
Max. active track points	50,000 points, 50 saved tracks
Wireless frequency	2.4 GHz @ 17.6 dBm nominal
Memory card	2 microSD card slots; 32 GB max. card size

## GPSMAP 9x3 Specifications

Dimensions (W × H × D)	233.0 × 162.3 × 75.8 mm (9 <sup>3</sup> / <sub>16</sub> × 6 <sup>3</sup> / <sub>8</sub> × 3 in.)
Clearance to next obstruction	33.2 mm (1 <sup>5</sup> / <sub>8</sub> in.)
Display size (W × H)	198.7 × 111.8 mm (7 <sup>13</sup> / <sub>16</sub> × 4 <sup>3</sup> / <sub>8</sub> in.) 22.9 cm (9.0 in.) diagonal
Display resolution	WXGA, 1280 × 720 pixels
Weight	1.6 kg (3.6 lb.)
Compass-safe distance	30 cm (11.81 in.)
Max. power usage at 10 Vdc	Non-sonar models: 22.0 W Sonar models: 40.2 W
Typical current draw at 12 Vdc	Non-sonar models: 1.34 A Sonar models: 1.37 A
Max. current draw at 12 Vdc	Non-sonar models: 1.78 A Sonar models: 3.20 A
Temperature range	From -15° to 55°C (from 5° to 131°F)
Material	Polycarbonate plastic and die-cast aluminum
Water rating	IEC 60529 IPX7 <sup>1</sup>
Input voltage	From 10 to 32 Vdc
Fuse	6 A, 125 V fast-acting
NMEA 2000 LEN @ 9 Vdc	2
NMEA 2000 draw	75 mA max.
Max. waypoints	5,000
Max. routes	100
Max. active track points	50,000 points, 50 saved tracks
Wireless frequency	2.4 GHz @ 17.6 dBm nominal
Memory card	2 microSD card slots; 32 GB max. card size

<sup>1</sup> The device withstands incidental exposure to water of up to 1 m for up to 30 min. For more information, go to [www.garmin.com/waterrating](http://www.garmin.com/waterrating).

## GPSPMAP 12x3 Specifications

Dimensions (W × H × D)	308.3 × 227.6 × 81.8 mm (12 1/8 × 8 15/16 × 3 1/4 in.)
Clearance to next obstruction	18.7 mm (3/4 in.)
Display size (W × H)	262.1 × 164.2 mm (10 15/16 × 6 7/16 in.) 30.7 cm (12.1 in.) diagonal
Display resolution	WXGA, 1280 × 800 pixels
Weight	3.0 kg (6.6 lb.)
Compass-safe distance	45 cm (17.72 in.)
Max. power usage at 10 Vdc	Non-sonar models: 26.5 W Sonar models: 43.0 W
Typical current draw at 12 Vdc	Non-sonar models: 1.67 A Sonar models: 1.68 A
Max. current draw at 12 Vdc	Non-sonar models: 2.15 A Sonar models: 3.56 A
Temperature range	From -15° to 55°C (from 5° to 131°F)
Material	Polycarbonate plastic and die-cast aluminum
Water rating	IEC 60529 IPX7 <sup>1</sup>
Input voltage	From 10 to 32 Vdc
Fuse	6 A, 125 V fast-acting
NMEA 2000 LEN @ 9 Vdc	2
NMEA 2000 draw	75 mA max.
Max. waypoints	5,000
Max. routes	100
Max. active track points	50,000 points, 50 saved tracks
Wireless frequency	2.4 GHz @ 17.6 dBm nominal
Memory card	2 microSD card slots; 32 GB max. card size

## Sonar Models Specifications

Specification	Measurement
Sonar frequencies <sup>2</sup>	Traditional: 50/200, 77/200, 83/200 kHz Single Channel CHIRP: from 40 to 250 kHz Garmin ClearVü CHIRP: 260/455/800 kHz Ultra High-Definition Garmin ClearVü: 0.8 MHz (800 kHz), CHIRP range: 760 to 880 kHz Ultra High-Definition SideVü: 1.2 MHz (1,200 kHz), CHIRP range: 1,060 to 1,170 kHz
Sonar transmit power (RMS) <sup>3</sup>	CHIRP: 1000 W Garmin ClearVü and SideVü CHIRP: 500 W
Sonar depth <sup>4</sup>	5,000 ft. at 1 kW

## NMEA 2000 PGN Information

### Transmit and Receive

PGN	Description
059392	ISO acknowledgment
059904	ISO request
060160	ISO transport protocol: Data transfer
060416	ISO transport protocol: Connection management
060928	ISO address claimed
065240	Commanded address
126208	Request group function
126996	Product information
126998	Configuration information
127237	Heading/track control
127245	Rudder

<sup>1</sup> The device withstands incidental exposure to water of up to 1 m for up to 30 min. For more information, go to [www.garmin.com/waterrating](http://www.garmin.com/waterrating).

<sup>2</sup> Dependent upon the transducer.

<sup>3</sup> Dependent upon the transducer rating and depth.

<sup>4</sup> Dependent upon the transducer, water salinity, bottom type, and other water conditions.

PGN	Description
127250	Vessel heading
127258	Magnetic variance
127488	Engine parameters: Rapid update
127489	Engine parameters: Dynamic
127493	Transmission parameters: Dynamic
127505	Fluid level
127508	Battery status
128259	Speed: Water referenced
128267	Water depth
129025	Position: Rapid update
129026	COG and SOG: Rapid update
129029	GNSS position data
129283	Cross track error
129284	Navigation data
129539	GNSS DOPs
129540	GNSS satellites in view
130060	Label
130306	Wind data
130310	Environmental parameters (obsolete)
130311	Environmental parameters (obsolete)
130312	Temperature (obsolete)

### Transmit

PGN	Description
126464	Transmit and receive PGN list group function
126984	Alert Response
127497	Trip parameters: Engine

### Receive

PGN	Description
065030	Generator average basic AC quantities (GAAC)
126983	Alert
126985	Alert text
126987	Alert threshold
126988	Alert value
126992	System time
127251	Rate of turn
127257	Attitude
127498	Engine parameters: Static
127503	AC input status (obsolete)
127504	AC output status (obsolete)
127506	DC detailed status
127507	Charger status
127509	Inverter status
128000	Nautical leeway angle
128275	Distance log
129038	AIS class A position report
129039	AIS class B position report
129040	AIS class B extended position report
129044	Datum
129285	Navigation: Route, waypoint information
129794	AIS class A static and voyage related data
129798	AIS SAR aircraft position report
129799	Radio frequency/mode/power
129802	AIS safety-related broadcast message
129808	DSC call Information
129809	AIS class B "CS" static data report, part A
129810	AIS class B "CS" static data report, part B

PGN	Description
130313	Humidity
130314	Actual pressure
130316	Temperature: Extended range
130576	Trim tab status
130577	Direction data

## NMEA 0183 Information

### Transmit

Sentence	Description
GPAPB	APB: Heading or track controller (autopilot) sentence "B"
GPBOD	BOD: Bearing (origin to destination)
GPBWC	BWC: Bearing and distance to waypoint
GPGGA	GGA: Global positioning system fix data
GPGLL	GLL: Geographic position (latitude and longitude)
GPGSA	GSA: GNSS DOP and active satellites
GPGSV	GSV: GNSS satellites in view
GPRMB	RMB: Recommended minimum navigation information
GPRMC	RMC: Recommended minimum specific GNSS data
GPRTE	RTE: Routes
GPVTG	VTG: Course over ground and ground speed
GPWPL	WPL: Waypoint location
GPXTE	XTE: Cross track error
PGRME	E: Estimated error
PGRMM	M: Map datum
PGRMZ	Z: Altitude
SDDBT	DBT: Depth below transducer
SDDPT	DPT: Depth
SDMTW	MTW: Water temperature
SDVHW	VHW: Water speed and heading

### Receive

Sentence	Description
DPT	Depth
DBT	Depth below transducer
MTW	Water temperature
VHW	Water speed and heading
WPL	Waypoint location
DSC	Digital selective calling information
DSE	Expanded digital selective calling
HDG	Heading, deviation, and variation
HDM	Heading, magnetic
MWD	Wind direction and speed
MDA	Meteorological composite
MWV	Wind speed and angle
VDM	AIS VHF data-link message

You can purchase complete information about National Marine Electronics Association (NMEA) format and sentences from [www.nmea.org](http://www.nmea.org).

## J1939 Information

The chartplotter can receive J1939 sentences. The chartplotter cannot transmit over the J1939 network.

Description	PGN	SPN
Engine percent load at current speed	61443	92
Engine speed	61444	190
Engine manifold exhaust gas temperature - right manifold	65031	2433
Engine manifold exhaust gas temperature - left manifold	65031	2434
Engine auxiliary coolant	65172	

Description	PGN	SPN
Active diagnostic trouble codes	65226	
Vehicle distance	65248	
Water in fuel indicator	65279	
Engine wait to start lamp	65252	1081
Engine over speed test	65252	2812
Engine air shutoff command status	65252	2813
Engine alarm output command status	65252	2814
Engine total hours of operation	65253	247
Navigation-based vehicle speed	65256	517
Engine fuel temperature 1	65262	174
Engine oil temperature 1	65262	175
Engine fuel delivery pressure	65263	94
Engine oil pressure	65263	100
Engine coolant pressure	65263	109
Engine coolant temperature	65263	110
Engine coolant level	65263	111
Engine fuel rate	65266	183
Engine average fuel economy	65266	185
Engine intake manifold #1 pressure	65270	102
Battery potential / power input 1	65271	168
Transmission oil temperature	65272	177
Transmission oil pressure	65272	127
Fuel level	65276	96
Engine oil filter differential pressure	65276	969

# Index

## A

ActiveCaptain **6, 64**  
  quickdraw **16**  
  smart notifications **6, 7**  
  updating charts **7**  
  updating software **7**  
aerial photos **11**  
AIS **11–14**  
  ATONs **12**  
  distress signal device **12**  
  radar **37**  
  SART **12**  
  targeting **11, 12**  
  threats **12, 37**  
  turning on **63**  
alarms **22, 61**  
  anchor drag **61**  
  arrival **61**  
  collision **12, 63**  
  deep water **30, 61**  
  engine **46**  
  fuel **47, 62**  
  gauges **46**  
  navigation **61**  
  off course **61**  
  shallow water **30, 61**  
  sonar **30, 61**  
  water temperature **30, 61**  
  weather **62**

## AM

**51**  
anchor **61**  
anchor drag alarm **61**  
animated currents, tides **10**  
antenna, GPS **3**  
arrival alarm **61**  
Auto Guidance **17, 20, 60**  
  paths **20**  
  shoreline distance **21, 60**  
autopilot **39–42**  
  adjusting the heading **40**  
  circles pattern **41**  
  cloverleaf pattern **41**  
  engaging **40**  
  orbit pattern **41**  
  pattern steering **41**  
  reducing rudder activity **40**  
  search pattern **41**  
  Shadow Drive **40**  
  steering increment **40**  
  steering patterns **41**  
  u-turn pattern **41**  
  Williamson turn pattern **41**  
  zigzag pattern **41**  
autopilot. **42**

## B

back view **1**  
background **4**  
backlight **5, 8**  
battery, management **48**  
boundaries  
  copying **64**  
  linking to SmartMode layout **22**  
  showing **14**  
boundary line **22, 23**  
boundary lines **22**  
buoy reports **55**

## C

camera **58**  
  configuration **56**  
  controlling **56–58**  
  home position **56**  
  pausing **56**  
  standby **56**  
celestial information **50**

## chart

  layers **13, 14**  
  settings **13, 14**  
charts **9, 11, 14, 15**  
  appearance **13–15**  
  details **9**  
  fishing **9**  
  layers **13, 14**  
  measuring distance **9**  
  navigation **9–11**  
  quickdraw **15, 16**  
  radar **15**  
  settings **13**  
  symbols **9**  
  updating **7, 65**

## circuits

**49**  
clock **61**  
  alarm **61**  
collision alarm **12, 63**  
color mode **5**  
combinations **5**  
compass  
  data bar **5**  
  rose **13**  
connectors **1**  
courses **17**  
current stations **50**  
  indicators **11**

## D

DAB **51, 52**  
data  
  backup **64**  
  copying **64**  
  management **64**  
deleting, all user data **23**  
depth log **48**  
depth shading **13, 14**  
destinations  
  navigation chart **17**  
  selecting **17**  
detailed maps **64**  
device  
  cleaning **66**  
  registration **65**  
digital selective calling **44, 45**  
  channels **45**  
  contacts **44**  
  individual routine call **45**  
  turning on **44, 63**  
digital switching **49**  
distress call **44, 45**  
distress signal device **12**  
DSC. See digital selective calling

## E

EBL **37**  
  measuring **37**  
  showing **37**  
EGNOS **59**  
engine **46, 47**  
  alerts **46**  
  conditions **46**  
engine gauges **45, 46**  
  configuring **46**  
  status alarms **46**  
EPIRB **12**  
event log **59**

## F

factory settings **63**  
  stations **5**  
favorites **4**  
Fish Eye 3D **10**  
  sonar cone **15**  
  suspended targets **15**  
  tracks **15**  
fishfinder. See sonar  
fishing chart **9, 55**  
FM **51**

Force trolling motor **43, 44**  
fuel capacity **47**  
fuel gauges **45–47**  
  status alarm **47, 62**  
  synchronizing with actual fuel **47**  
Fusion PartyBus **51**

## G

Garmin ClearVü **25**  
Garmin Express **64, 65**  
  updating charts **65**  
Garmin Marine Network **61**  
Garmin product support. See product support  
gauges **45–47**  
  engine **45, 46**  
  fuel **45, 47**  
  limits **46**  
  status alarms **46**  
  trip **48**  
  wind **48**  
GLONASS **59**  
Go To **17, 18**  
GPS **67**  
  EGNOS **59**  
  GLONASS **59**  
  signals **3**  
  source **3**  
  WAAS **59**  
GPS accuracy **61**  
graphs  
  air temperature **48**  
  atmospheric pressure **48**  
  configuring **48**  
  depth **48**  
  water temperature **48**  
  wind angle **48**  
  wind speed **48**  
GRID **66**  
GRID pairing **59, 66**  
gybing. See tacking and gybing

## H

heading **40**  
  adjusting **40**  
  heading hold **24**  
  holding **40**  
  line **13, 25**  
  Shadow Drive **40**  
help. See product support  
home screen **3**  
  customizing **4, 5**

## I

images **4, 66**  
inReach **48**  
  messages **49**

## J

jibing. See tacking and gybing  
joystick **66**

## K

keel offset **24, 62**  
keyboard **59**

## L

language **59**  
locking, screen **2**

## M

man overboard **18, 41, 45**  
manual viewer **2**  
maps **15, 64**. See charts  
marine services **17**  
mark location **18**  
MARPA  
  acquiring **36**  
  navigation chart **14**  
  tagged object **37**  
  targeting **36**  
  threats **12, 37**

- measuring distance **26**
  - charts **9**
- media player **50–53**
  - alphabetical search **51**
  - DAB **52**
  - device name **53**
  - FUSION-Link **50**
  - muting **51**
  - preset **51, 52, 56**
  - radio **52, 53**
  - repeating **51**
  - shuffling **51**
  - SiriusXM Satellite Radio **52**
  - source **51**
  - stereo **51**
  - tuner region **51, 12**
  - tuning mode **51**
  - VHF **51**
  - zones **51**
- memory card **2, 64**
  - detailed maps **64**
  - installing **3**
  - slot **1**
- messages **48**
- MOB, device **12**
- music player **50, 52, 53**. See media player

## N

- navaids **10**
- naviads **12**
- navigation alarms **61**
- navigation chart **9, 11, 17, 55**
  - ATONs **12**
  - marine service points **17**
  - MARPA **14**
  - radar overlay **35**
  - vessel trails **14, 45**
- navigation inset **5**
- NMEA 0183 **44, 60**
- NMEA 2000 **44, 61**
- notifications **6, 7**

## O

- off **6**
- off course alarm **61**
- offset, front of boat **39**
- Optimus **49**
- Optimus Optimus **49**
- other vessels
  - AIS **14**
  - trails **14**
- overlay bar **43**
- overlay numbers **5**

## P

- Panoptix **34**
- Perspective 3D **55**
- photos, aerial **11**
- ports **1**
- position, tracking **45**
- position report **45**
- power key **1, 2, 5, 6**
- powerboat **5, 23**
- preferred data source **39, 40**
- premium charts **10, 11**
  - aerial photos **11**
  - Fish Eye 3D **10, 15**
  - tide and current indicators **10**
- presets **5, 51, 52**
  - DAB **52**
- product registration **65**
- product support **2, 67**

## Q

- quickdraw **16**

## R

- radar **35–37, 39**
  - AIS **37**
  - averaging **38**
  - bird mode **37**

- clutter **38, 39**
- color scheme **39**
- custom park position **39**
- echo trails **37**
- field of view **39**
- front-of-boat offset **39**
- gain **37, 38**
- guard zone **36**
- MARPA **12**
- optimizing display **38**
- overlay **15**
- overlay screen **35**
- range **35, 36**
- range rings **39**
- source **39**
- timed transmit **35**
- transmitting **35**
- waypoints **39**
- radar overlay **35**
- radio **51**
  - AM **51**
  - FM **51**
  - SiriusXM **52, 53**
- range rings **13**
- registering the device **65**
- remote control **8, 41, 42**
  - disconnecting **8**
- reset **63**
- resetting
  - settings **53**
  - station layouts **5**
- restore **63**
- Route To **17**
- routes **17, 19, 22**
  - copying **64**
  - creating **19, 20**
  - deleting **20**
  - editing **19**
  - navigating **19**
  - navigating parallel to **19**
  - viewing list of **19**
  - waypoints **64**

## S

- safe depth **60**
- safe height **60**
- safe-zone collision alarm **12, 63**
- sailboat **5, 23**
- sailing **13, 23, 41**
  - race timer **23**
  - starting line **23**
- sailing gauges **48**
- sailingstarting line **23**
- SART **12**
- satellite imagery **11**
- satellite signals, acquiring **3**
- screen
  - brightness **5**
  - locking **2, 6**
  - unlocking **2**
- screenshots **67**
  - capturing **67**
- settings **16, 59, 60**
  - radar display **39**
  - system information **59**
- Shadow Drive, enabling **40**
- sharing data **64**
- shoreline distance **21, 60**
- shortcuts **44**
- SideVü **26**
- SiriusXM **51, 53**
  - parental controls **53**
  - Satellite Radio **52**
- SiriusXM Satellite Radio **51–53**
- smart notifications **6, 7**
- SmartMode layout, linking to boundary **22**
- software
  - updates **53, 66**
  - updating **7, 65, 66**

- sonar **25, 28, 31**
  - a-scope **30, 31**
  - alarms **30, 61**
  - appearance **30**
  - bottom lock **29**
  - color gain **28**
  - color rejection **30**
  - cone **15**
  - depth **29**
  - depth scale **30**
  - frequencies **31**
  - FrontVü **27**
  - gain **28**
  - Garmin ClearVü **25**
  - interference **30**
  - measuring distances **26**
  - noise **28**
  - numbers **5**
  - Panoptix **26, 27, 32, 33**
  - Panoptix LiveScope **28, 34**
  - perspective **28**
  - picture advance **30**
  - recording **29**
  - scroll speed **29, 33**
  - sharing **28**
  - SideVü **26**
  - source **28**
  - surface noise **30**
  - suspended targets **30**
  - views **25**
  - waypoint **28**
  - zoom **29**
- SOS **18, 45**
- stations **3**
  - changing the station **59**
  - customizing the home screen of **4**
  - ordering the displays **59**
  - restoring the layout **5, 59**
- support. See product support
- suspended targets **15**
- symbols **11**
- system information **59, 64**

## T

- tacking and gybing **24, 25**
  - heading hold **24**
  - wind hold **24**
- tank level sensors **47**
- targeting **36**
- temperature log **48**
- tide stations **10, 50**
  - indicators **11**
- touchscreen **1, 2**
- tracks **21, 22**
  - clearing **22**
  - copying **64**
  - deleting **22**
  - editing **21**
  - list **21**
  - navigating **21, 22**
  - recording **22**
  - saving **21**
  - saving as route **21**
  - showing **14, 21**
- transducer **25, 28, 31, 34**
- trip gauges **48**
- trolling motor **43**
  - bow offset **44**
  - compass **44**
- troubleshooting **67**

## U

- unit ID **59**
- units of measure **59**
- unlocking, screen **2**
- updates, software **65, 66**
- updating
  - charts **7**
  - software **7**
- user data, deleting **23**



## V

- vessel trails **14, 45**
- VHF radio **44**
  - calling an AIS target **45**
  - distress calls **44, 45**
  - DSC channel **45**
  - individual routine call **45**
- video **55–58**
  - configuring **56, 57**
  - source **56**
  - viewing **56**
- VIRB camera **58**
- voltage **61**
- VRM **37**
  - measuring **37**
  - showing **37**

## W

- WAAS **59**
- warning manager **50**
  - messages **50**
- watch, marine **41**
- water
  - speed **63**
  - temperature log **48**
  - temperature offset **62**
- waypoints **18, 67**
  - copying **64**
  - creating **9, 18**
  - deleting **19**
  - editing **18**
  - man overboard **18**
  - navigating to **18**
  - projecting **18**
  - showing **14**
  - sonar **28**
  - tracked vessel **45**
  - viewing list of **18**
- weather **53, 54**
  - alarms **62**
  - broadcasts **53**
  - charts **14, 54**
  - fishing **54**
  - forecast **53–55**
  - overlay **55**
  - precipitation **54**
  - sea conditions **54, 55**
  - subscription **53, 55**
  - surface pressure **55**
  - visibility **55**
  - water temperature **55**
  - wave information **55**
  - winds **54**
- Wi-Fi **6**
- Wi-Fi technology **8**
- wind, rose **13**
- wind angle graph **48**
- wind gauges **48**
- wind hold **24**
  - adjusting **24**
- wind sensor **8**
- wind speed graph **48**
- wireless devices **7, 8, 48, 57, 58**
  - connecting a wireless device **8, 9**
  - connecting to a wireless device **6**
  - network configuration **8**

## Z

- zoom
  - chart **9**
  - sonar **29**

