



**ROGERS LABS, INC.**

4405 West 259<sup>th</sup> Terrace  
Louisburg, KS 66053  
Phone / Fax (913) 837-3214

**47 CFR, PART 15C - Intentional Radiators  
47 CFR Paragraph 15.249 and  
Industry Canada RSS-GEN Issue 5 and RSS-210 Issue 10  
Application For Grant of Certification**

**Model: A03847**

2402-2480 MHz (DXX)  
Low Power Digital Transmitter

**FCC ID: IPH-03847**

**IC: 1792A-03847**

**Garmin International, Inc.**

1200 East 151st Street  
Olathe, KS 66062

FCC Designation: US5305  
ISED Registration: 3041A-1

Test Report Number: 191125

Test Date: November 25, 2019

Authorized Signatory: *Scot D Rogers*  
Scot D. Rogers

This report shall not be reproduced except in full, without the written approval of the laboratory. This report must not be used by the client to claim product certification, approval, or endorsement by NVLAP, NIST, or any agency of the U.S. Government.

Rogers Labs, Inc.  
4405 West 259<sup>th</sup> Terrace  
Louisburg, KS 66053  
Phone/Fax: (913) 837-3214  
Revision 1

Garmin International, Inc.  
Model: A03847  
Test: 191125  
Test to: CFR47 15.249, RSS-210, RSS-Gen  
File: A03847 DXX TstRpt 191125

SN: 3315409516 / 3315409596  
FCC ID: IPH-03847  
IC: 1792A-03847  
Date: February 12, 2020  
Page 1 of 65

## Table of Contents

<b>TABLE OF CONTENTS.....</b>	<b>2</b>
<b>REVISIONS.....</b>	<b>4</b>
<b>FOREWORD.....</b>	<b>5</b>
<b>OPINION / INTERPRETATION OF RESULTS .....</b>	<b>5</b>
<b>EQUIPMENT TESTED.....</b>	<b>6</b>
<b>Equipment Function .....</b>	<b>8</b>
<b>Equipment Configuration.....</b>	<b>9</b>
<b>APPLICATION FOR CERTIFICATION.....</b>	<b>10</b>
<b>APPLICABLE STANDARDS &amp; TEST PROCEDURES .....</b>	<b>11</b>
<b>TESTING PROCEDURES .....</b>	<b>11</b>
<b>AC Line Conducted Emission Test Procedure .....</b>	<b>11</b>
<b>Radiated Emission Test Procedure.....</b>	<b>11</b>
<b>Antenna Port Conducted Emission Test Procedure.....</b>	<b>12</b>
Diagram 1 Test arrangement for Conducted emissions .....	13
Diagram 2 Test arrangement for radiated emissions of tabletop equipment.....	14
Diagram 3 Test arrangement for radiated emissions tested on Open Area Test Site (OATS).....	15
Diagram 4 Test arrangement for Antenna Port Conducted emissions .....	16
<b>TEST SITE LOCATIONS .....</b>	<b>16</b>
<b>LIST OF TEST EQUIPMENT .....</b>	<b>17</b>
<b>UNITS OF MEASUREMENTS .....</b>	<b>18</b>
<b>ENVIRONMENTAL CONDITIONS.....</b>	<b>18</b>
<b>STATEMENT OF MODIFICATIONS AND DEVIATIONS .....</b>	<b>18</b>
<b>INTENTIONAL RADIATORS.....</b>	<b>19</b>

**Antenna Requirements .....19**

**Restricted Bands of Operation.....19**

Table 1 Radiated Emissions in Restricted Frequency Bands Data Mode 1 ANT (GFSK) .....20

Table 2 Radiated Emissions in Restricted Frequency Bands Data Mode 2 BT BR (GFSK) .....21

Table 3 Radiated Emissions in Restricted Frequency Bands Data Mode 3 BT 2EDR ( $\pi/4$  DQPSK) .....22

Table 4 Radiated Emissions in Restricted Frequency Bands Data Mode 4 BT 3EDR (8DPSK) .....23

Table 5 Radiated Emissions in Restricted Frequency Bands Data Mode 5 BT BLE (GMSK) .....24

**Summary of Results for Radiated Emissions in Restricted Bands .....24**

**AC Line Conducted EMI Procedure .....25**

Figure 1 AC Line Conducted emissions of EUT line 1 Configuration #3 .....26

Figure 2 AC Line Conducted emissions of EUT line 2 Configuration #3 .....27

Figure 3 AC Line Conducted emissions of EUT line 1 Configuration #4 .....28

Figure 4 AC Line Conducted emissions of EUT line 2 Configuration #4 .....29

Table 6 AC Line Conducted Emissions Data L1 Configuration #3 .....30

Table 7 AC Line Conducted Emissions Data L2 Configuration #3 .....30

Table 8 AC Line Conducted Emissions Data L1 Configuration #4 .....31

Table 9 AC Line Conducted Emissions Data L2 Configuration #4 .....31

**Summary of Results for AC Line Conducted Emissions Results .....31**

**General Radiated Emissions Procedure.....32**

Table 10 General Radiated Emissions Data .....33

**Summary of Results for General Radiated Emissions .....33**

**Operation in the Band 2400 – 2483.5 MHz .....34**

Figure 5 Plot of Transmitter Emissions Operation in 2402-2480 MHz Mode 1 ANT (GFSK) .....35

Figure 6 Plot of Transmitter Emissions 99% Occupied Bandwidth Mode 1 ANT (GFSK) .....36

Figure 7 Plot of Transmitter Emissions Low Band Edge Mode 1 ANT (GFSK) .....37

Figure 8 Plot of Transmitter Emissions High Band Edge Mode 1 ANT (GFSK) .....38

Figure 9 Plot of Transmitter Emissions Operation in 2402-2480 MHz Mode 2 BT BR (GFSK) .....39

Figure 10 Plot of Transmitter Emissions 99% Occupied Bandwidth Mode 2 BT BR (GFSK) .....40

Figure 11 Plot of Transmitter Emissions Low Band Edge Mode 2 BT BR (GFSK) .....41

Figure 12 Plot of Transmitter Emissions High Band Edge Mode 2 BT BR (GFSK) .....42

Figure 13 Plot of Transmitter Emissions Operation in 2402-2480 MHz Mode 3 BT 2EDR ( $\pi/4$  DQPSK) .....43

Figure 14 Plot of Transmitter Emissions 99% Occupied Bandwidth Mode 3 BT 2EDR ( $\pi/4$  DQPSK) .....44

Figure 15 Plot of Transmitter Emissions Low Band Edge Mode 3 BT 2EDR ( $\pi/4$  DQPSK) .....45  
 Figure 16 Plot of Transmitter Emissions High Band Edge Mode 3 BT 2EDR ( $\pi/4$  DQPSK).....46  
 Figure 17 Plot of Transmitter Emissions Operation in 2402-2480 MHz Mode 4 BT 3EDR (8DPSK).....47  
 Figure 18 Plot of Transmitter Emissions 99% Occupied Bandwidth Mode 4 BT 3EDR (8DPSK).....48  
 Figure 19 Plot of Transmitter Emissions Low Band Edge Mode 4 BT 3EDR (8DPSK) .....49  
 Figure 20 Plot of Transmitter Emissions High Band Edge Mode 4 BT 3EDR (8DPSK).....50  
 Figure 21 Plot of Transmitter Emissions Operation in 2402-2480 MHz Mode 5 BT BLE (GMSK) .....51  
 Figure 22 Plot of Transmitter Emissions 99% Occupied Bandwidth Mode 5 BT BLE (GMSK) .....52  
 Figure 23 Plot of Transmitter Emissions Low Band Edge Mode 5 BT BLE (GMSK) .....53  
 Figure 24 Plot of Transmitter Emissions High Band Edge Mode 5 BT BLE (GMSK).....54

**Transmitter Emissions Data.....55**

Table 11 Transmitter Radiated Emissions Mode 1 ANT (GFSK).....55  
 Table 12 Transmitter Radiated Emissions Mode 2 BT BR (GFSK).....56  
 Table 13 Transmitter Radiated Emissions Mode 3 BT 2EDR ( $\pi/4$  DQPSK) .....57  
 Table 14 Transmitter Radiated Emissions Mode 4 BT 3EDR (8DPSK) .....58  
 Table 15 Transmitter Radiated Emissions Mode 5 BT BLE (GMSK) .....59

**Summary of Results for Transmitter Radiated Emissions of Intentional Radiator.....60**

**ANNEX..... 61**

**Annex A Measurement Uncertainty Calculations.....62**

**Annex B Additional Test Equipment.....63**

**Annex C Rogers Qualifications.....64**

**Annex D Laboratory Certificate of Accreditation.....65**

## Revisions

Revision 1 Issued February 12, 2020

## Foreword

The following information is submitted for consideration in obtaining Grant of Certification for low power intentional radiator per the eCFR Title 47 Federal Communications Code of Federal Regulations (47 CFR), dated November 25, 2019, Industry Canada RSS-210 Issue 10 and RSS-GEN Issue 5, low power digital device transmitter operations in the 2400 – 2483.5 MHz frequency band.

Name of Applicant: Garmin International, Inc.  
1200 East 151st Street  
Olathe, KS 66062

M/N: A03847

FCC ID: IPH-03847 IC: 1792A-03847

Operating Frequency Range: 2402-2480 MHz

### Operational communication modes

Mode	Peak Power (dB $\mu$ V/m@3m)	Average power (dB $\mu$ V/m@3m)	99% OBW (kHz)
Mode 1 ANT (GFSK)	96.2	85.0	860.6
Mode 2 BT BR (GFSK)	98.8	92.9	889.4
Mode 3 BT 2EDR ( $\pi/4$ DQPSK)	97.8	89.1	1,096.2
Mode 4 BT 3EDR (8DPSK)	97.8	89.4	1,230.8
Mode 5 BT BLE (GMSK)	93.8	91.3	1,033.7

This report addresses EUT Operations as Low Power Device using Modes 1 through 5

### Opinion / Interpretation of Results

Tests Performed	Margin (dB)	Results
Restricted Bands 47 CFR 15.205, RSS-210 4.1	-4.5	Complies
AC Line Conducted 47 CFR 15.207, RSS-GEN 8.8	-4.5	Complies
Radiated Emissions 47 CFR 15.209, RSS-GEN 8.9	-11.8	Complies
Harmonic Emissions per 47 CFR 15.249, RSS-210 B.10	-4.6	Complies

## Equipment Tested

Model: A03847

Equipment	Model / PN	Serial Number
EUT #1	A03847	3315409516
EUT #2	A03847	3315409596
DC Power cable	320-01404-00	N/A
Moto Mount	011-05088-00	N/A
CLA	320-00239-50	E17270002160
Auto Mount	011-05098-00	N/A
Interface cable	320-00541-01	N/A
Laptop Computer	Latitude 7480	HX91RN2
USB Printer	Dell 0N5819	5D1SL61
AC Adapter	362-00096-00	P183100862A1

Test results in this report relate only to the items tested. Worst-case configuration data recorded in this report.

Wireless communication modes

Mode	Transmitter Operation and Modulation
1	2402-2480 MHz, ANT (GFSK)
2	2402-2480 MHz, BT BR (GFSK)
3	2402-2480 MHz, BT 2EDR ( $\pi/4$ DQPSK)
4	2402-2480 MHz, BT 3EDR (8DPSK)
5	2402-2480 MHz, BT BLE (GMSK)

Software Version: 0.60, The software has no name as described by the manufacturer. The software does not provide ability to change power as it is hardcoded in manufacturer-controlled firmware. The manufacturer reported the following power level settings in the design.

- BT and BLE modulations +1 dBm power setting, 2.2-dBi integral Antenna
- ANT modulation +1 dBm power setting, 3-dBi integral Antenna
- 802.11 b/g/n/n40 +18dBm conducted power setting, 3-dBi integral Antenna
- U-N11 +13dBm conducted power setting, 3.9-dBi integral Antenna

The manufacturer reported the antenna characteristics were 50 ohms impedance with antenna gain as presented. The design may operate two or three transmitter functions at time as collocated transmitters. The design offers wireless communication with compatible ANT, BT, BLE, and 802.11b/g/n/n40/a/ac. The modulation characteristics for these standards are defined in each related standard including the available bit and symbol rates.

## **Equipment Function**

The EUT is a GPS receiver and digital display unit offering reception and display of location, navigation, and other information as Portable Navigational Device (PND). The design offers use as a hand-held, transportation mount or portable configuration for use in navigational applications. The design offers cabled and wireless interface capabilities for use with compatible equipment and installations. The EUT provides a single USB interface port for cabled communications and power for operation and internal battery recharge. The design incorporates transmitter circuitries operating in the 2402-2480 MHz, 5150-5250 MHz and 5725-5850 MHz bands. The transmitters designs provide low power operation across the 2402-2480 MHz band providing operating modes including ANT (GFSK), Bluetooth® Basic Rate (GFSK), 2EDR ( $\pi/4$  DQPSK), 3EDR (8DPSK), and BLE (GMSK). The design provides wireless communication capability as Digital Transmission System with compatible 802.11b/g/n/n40 equipment operating across the 2412-2462 MHz band. The device also provides wireless communication capability with compatible 802.11a/n/n40/ac equipment operating across the 5180-5240 MHz (U-NII-1) and 5745-5825 MHz (U-NII-3) bands operating as Unlicensed National Information Infrastructure (U-NII) Local Area Network Transmission System. The product operates from internal rechargeable battery or external direct current power sources as documented in this report. The design offers no other interface options than those presented below in the configuration diagrams. The design utilizes internal fixed antenna systems and offers no provision for antenna replacement or modification. Two samples were provided for testing, one representative of production design, and the other modified for testing purposes replacing integral antennas with RF connection ports. The test samples were provided with test software (version 0.60) which enable transmitter functions on defined modes and channels with near 100% duty cycle. Production product will not operate at these high of duty cycles. The antenna modification provided the ability to connect test equipment to the temporary antenna ports for antenna port conducted emission testing. The EUT was arranged as described by the manufacturer emulating typical user configurations for testing purposes. For testing purposes, the EUT was powered from freshly charged internal battery or external power options and configured to operate in available modes. The equipment was tested for emissions compliance using the available configurations with the worst-case data presented. This report documents compliance testing and results for applicable product modes of operation.

Test results in this report relate only to the products described in this report.

Rogers Labs, Inc.	Garmin International, Inc.	SN: 3315409516 / 3315409596
4405 West 259 <sup>th</sup> Terrace	Model: A03847	FCC ID: IPH-03847
Louisburg, KS 66053	Test: 191125	IC: 1792A-03847
Phone/Fax: (913) 837-3214	Test to: CFR47 15.249, RSS-210, RSS-Gen	Date: February 12, 2020
Revision 1	File: A03847 DXX TstRpt 191125	Page 8 of 65



## Equipment Configuration

320-01404-00 Ca Assy, Bare Wire, 5V, 1.5A, 2 pin, Moto Mount Cable  
 PCBA: 012-01779-16 Rev. C.

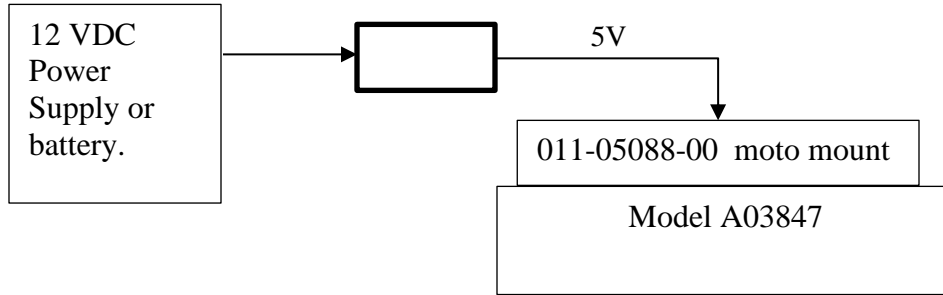


Fig. 1. Configuration 1. Motorcycle Mounting.

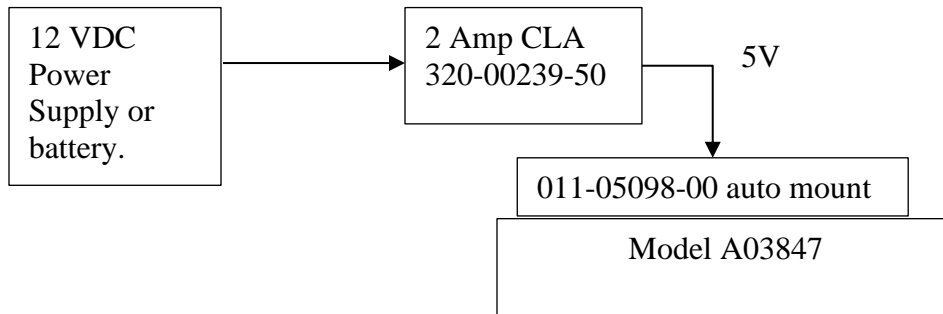


Fig. 2. Configuration 2. Automobile Mounting.

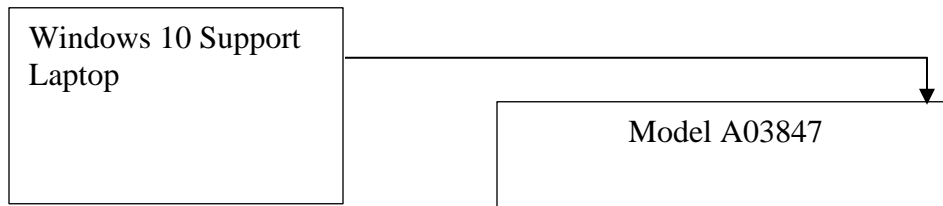


Fig. 3. Configuration 3. Data Configuration

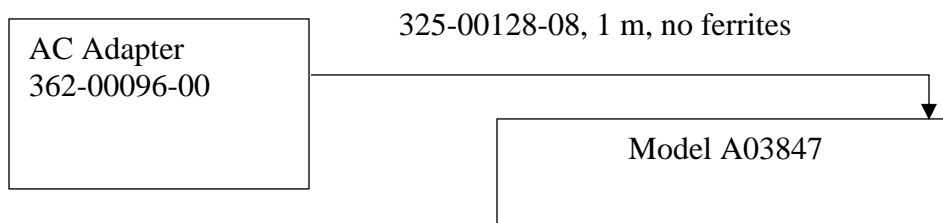


Fig. 4. Configuration 4. AC Charger Configuration

## Application for Certification

- (1) Manufacturer: Garmin International, Inc.  
1200 East 151st Street  
Olathe, KS 66062
- (2) Identification: M/N: A03847  
FCC ID: IPH-03847 IC: 1792A-03847
- (3) Instruction Book:  
Refer to Exhibit for Instruction Manual.
- (4) Description of Circuit Functions:  
Refer to Exhibit of Operational Description.
- (5) Block Diagram with Frequencies:  
Refer to Exhibit of Operational Description.
- (6) Report of Measurements:  
Report of measurements follows in this Report.
- (7) Photographs: Construction, Component Placement, etc.:  
Refer to Exhibit for photographs of equipment.
- (8) List of Peripheral Equipment Necessary for operation. The equipment operates from internal battery or direct current power provided from compatible power sources. The EUT offers proprietary interface with mount and single USB interface port for power and communications or power as presented in this filing.
- (9) Transition Provisions of 47 CFR 15.37 are not requested.
- (10) Not Applicable. The unit is not a scanning receiver.
- (11) Not Applicable. The EUT does not operate in the 59 – 64 GHz frequency band.
- (12) The equipment is not software defined and this section is not applicable.
- (13) Applications for certification of U-NII devices in the 5.15-5.35 GHz and the 5.47-5.85 GHz bands must include a high-level operational description of the security procedures that control the radio frequency operating parameters and ensure that unauthorized modifications cannot be made. This requirement is not applicable to his DTS device.
- (14) Contain at least one drawing or photograph showing the test set-up for each of the required types of tests applicable to the device for which certification is requested. These drawings or photographs must show enough detail to confirm other information contained in the test report. Any photographs used must be focused originals without glare or dark spots and must clearly show the test configuration used. This information is provided in this report and Test Setup Exhibits provided with the application filing.

## Applicable Standards & Test Procedures

The following information is submitted in accordance with the eCFR Title 47 Federal Communications Code of Federal Regulations (47 CFR), dated November 25, 2019: Part 2, Subpart J, Paragraphs 2.907, 2.911, 2.913, 2.925, 2.926, 2.1031 through 2.1057, and applicable parts of paragraph 15, Part 15C Paragraph 15.249, Industry Canada RSS-210 Issue 10, and RSS-GEN Issue 5 operation in the 2400 – 2483.5 MHz Frequency band. Test procedures used are the established Methods of Measurement of Radio-Noise Emissions as described in ANSI C63.10-2013.

## Testing Procedures

### ***AC Line Conducted Emission Test Procedure***

Testing for the AC line-conducted emissions was performed as defined in ANSI C63.10-2013. The test setup, including the EUT, was arranged in the test configurations as presented during testing. The test configuration was placed on a 1 x 1.5-meter bench, 0.8 meters high located in a screen room. The power lines of the system were isolated from the power source using a standard LISN with a 50- $\mu$ Hy choke. EMI was coupled to the spectrum analyzer through a 0.1  $\mu$ F capacitor internal to the LISN. The LISN was positioned on the floor beneath the wooden bench supporting the EUT. The power lines and cables were draped over the back edge of the table. Refer to diagram one showing typical test arrangement and photographs in exhibits for EUT placement used during testing.

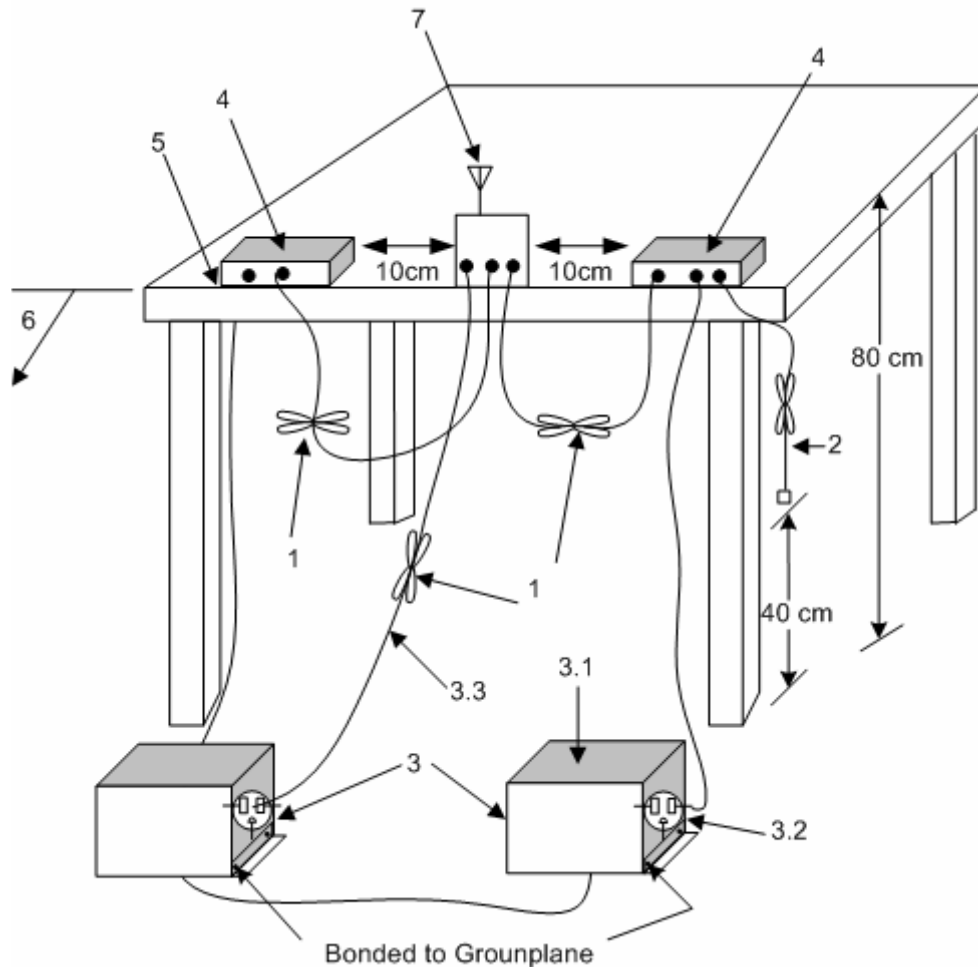
### ***Radiated Emission Test Procedure***

Radiated emissions testing was performed as required in 47 CFR 15C, RSS-210 Issue 10, and specified in ANSI C63.10-2013. The EUT was placed on a rotating 0.9 x 1.2-meter platform, elevated as required above the ground plane at a distance of 3 meters from the FSM antenna. EMI energy was maximized by equipment placement permitting orientation in three orthogonal axes, raising and lowering the FSM antenna, changing the antenna polarization, and by rotating the turntable. Each emission was maximized before data was taken and recorded. The frequency spectrum from 9 kHz to 25,000 MHz was searched for emissions during preliminary

investigation. Refer to diagrams two and three showing typical test setup. Refer to photographs in the test setup exhibits for specific EUT placement during testing.

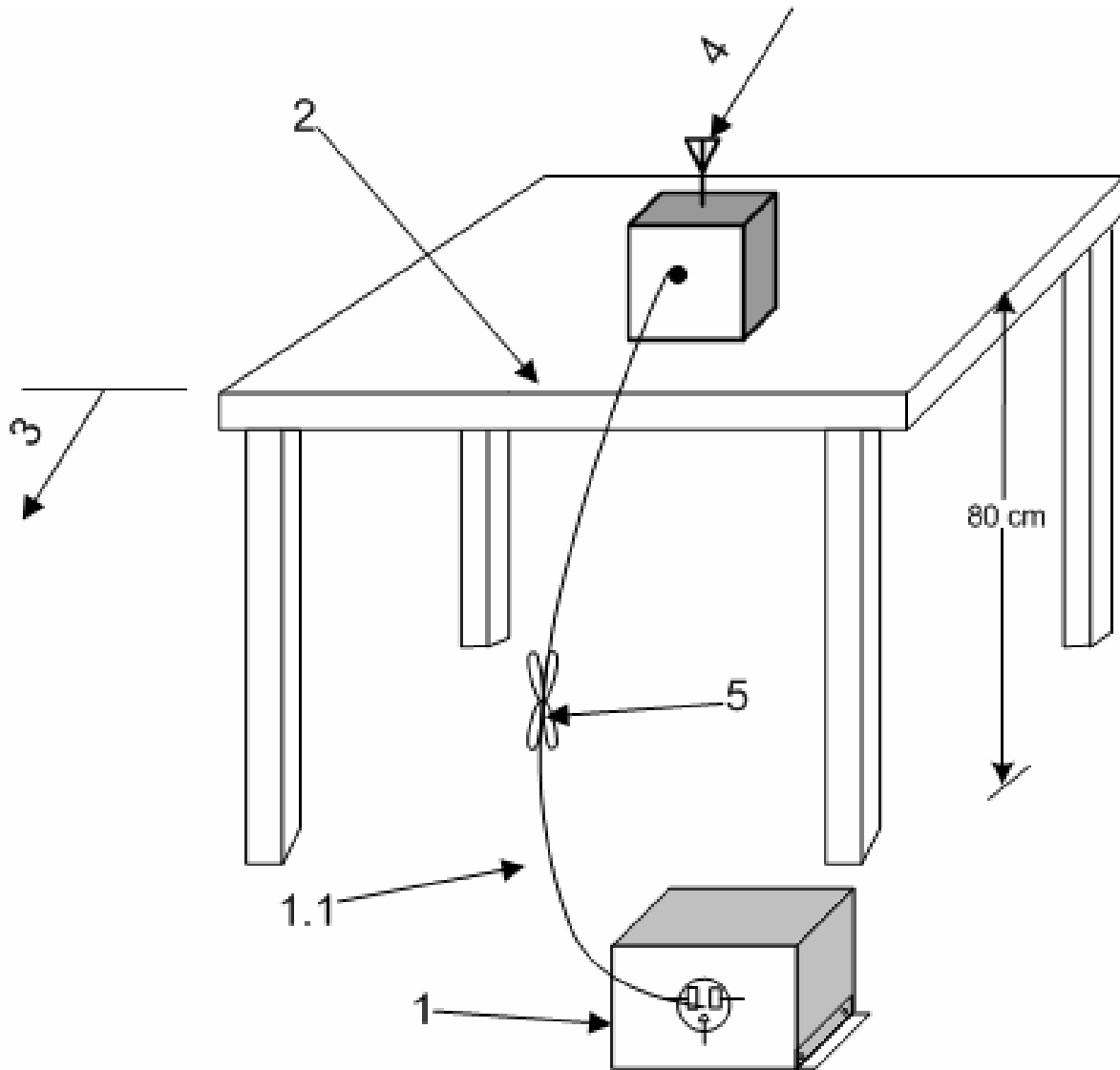
### ***Antenna Port Conducted Emission Test Procedure***

The EUT was assembled as required for operation placed on a benchtop. This configuration provided the ability to connect test equipment to the provided test antenna port. Antenna Port conducted emissions testing was performed presented in the regulations and specified in ANSI C63.10-2013. Testing was completed on a laboratory bench in a shielded room. The active antenna port of the device was connected to appropriate attenuation and the spectrum analyzer. Refer to diagram four showing typical test arrangement and photographs in the test setup exhibits for specific EUT placement during testing.



1. Interconnecting cables that hang closer than 40 cm to the ground plane shall be folded back and forth in the center forming a bundle 30 cm to 40 cm long see (see 6.2.3.1).
2. I/O cables that are not connected to an accessory shall be bundled in the center. The end of the cable may be terminated, if required, using the correct terminating impedance. The overall length shall not exceed 1 m (see 6.2.2).
3. EUT connected to one LISN. Unused LISN measuring port connectors shall be terminated in 50  $\Omega$  loads. LISN can be placed on top of, or immediately beneath, reference ground plane (see 6.2.2 and 6.2.3).
  - 3.1 All other equipment powered from additional LISN(s).
  - 3.2 Multiple-outlet strip can be used for multiple power cords of non-EUT equipment.
  - 3.3 LISN at least 80 cm from nearest part of EUT chassis.
4. Non-EUT components of EUT system being tested.
5. Rear of EUT, including peripherals, shall all be aligned and flush with rear of tabletop (see 6.2.3.1).
6. Edge of tabletop shall be 40 cm removed from a vertical conducting plane that is bonded to the ground plane (see 6.2.2 for options).
7. Antenna may be integral or detachable. If detachable, the antenna shall be attached for this test.

**Diagram 1 Test arrangement for Conducted emissions**



1—A LISN is optional for radiated measurements between 30 MHz and 1000 MHz but not allowed for measurements below 30 MHz and above 1000 MHz (see 6.3.1). If used, then connect EUT to one LISN. Unused LISN measuring port connectors shall be terminated in 50  $\Omega$  loads. The LISN may be placed on top of, or immediately beneath, the reference ground plane (see 6.2.2 and 6.2.3.2).

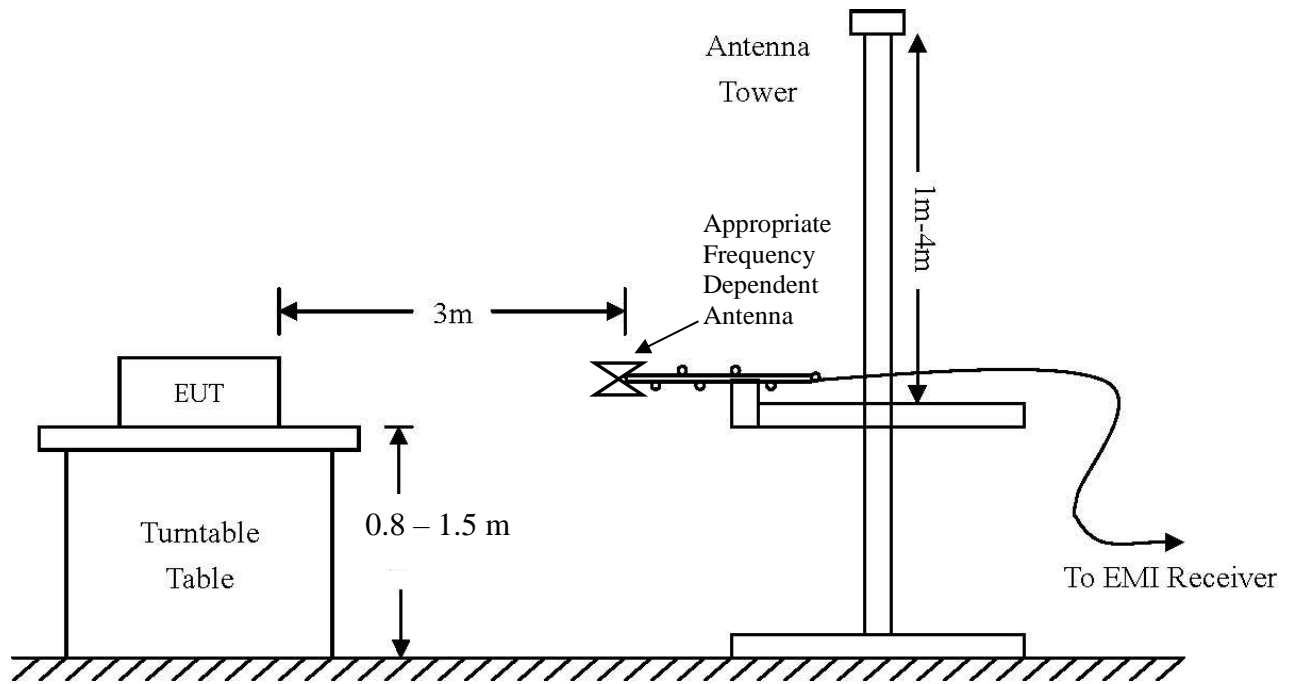
1.1—LISN spaced at least 80 cm from the nearest part of the EUT chassis.

2—Antenna can be integral or detachable, depending on the EUT (see 6.3.1).

3—Interconnecting cables that hang closer than 40 cm to the ground plane shall be folded back and forth in the center forming a bundle 30 cm to 40 cm long (see 6.3.1).

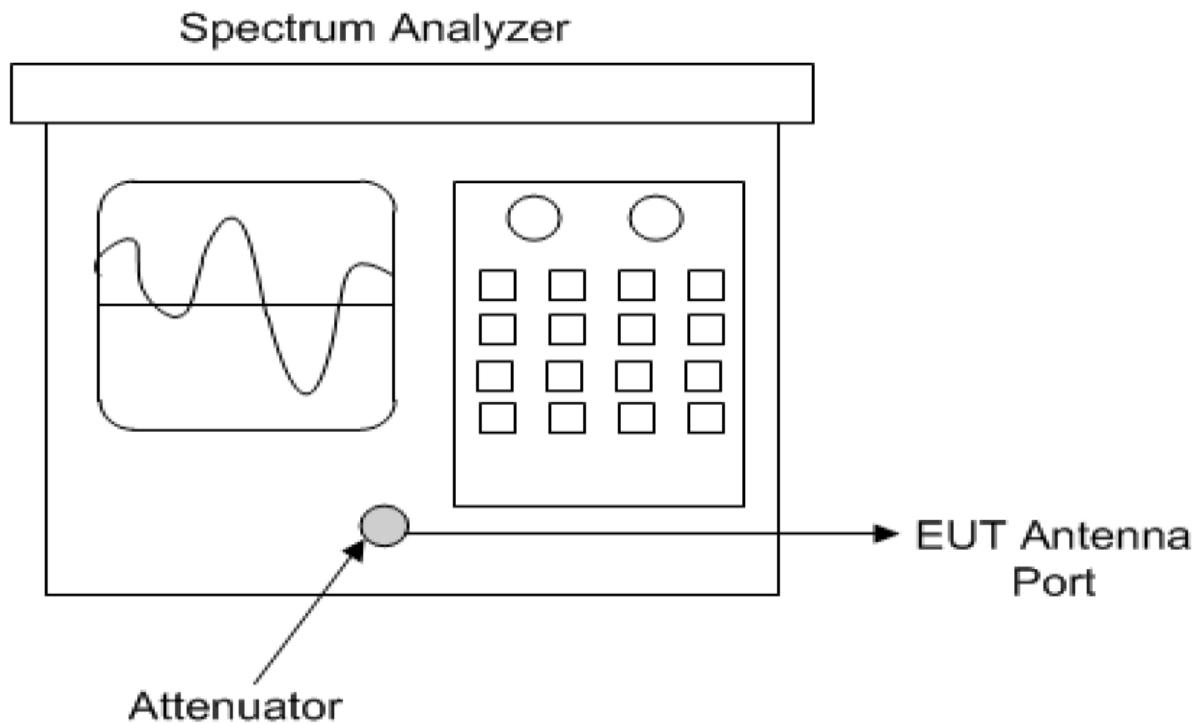
4—For emission measurements at or below 1 GHz, the table height shall be 80 cm. For emission measurements above 1 GHz, the table height shall be 1.5 m for measurements, except as otherwise specified (see 6.3.1 and 6.6.3.1).

### Diagram 2 Test arrangement for radiated emissions of tabletop equipment



AC Line Conducted Emissions (0.150 -30 MHz)		
RBW	AVG. BW	Detector Function
9 kHz	30 kHz	Peak / Quasi Peak
Emissions (30-1000 MHz)		
RBW	AVG. BW	Detector Function
120 kHz	300 kHz	Peak / Quasi Peak
Emissions (Above 1000 MHz)		
RBW	Video BW	Detector Function
100 kHz	100 kHz	Peak
1 MHz	1 MHz	Peak / Average

**Diagram 3 Test arrangement for radiated emissions tested on Open Area Test Site (OATS)**



**Diagram 4 Test arrangement for Antenna Port Conducted emissions**

### Test Site Locations

- Conducted EMI      AC line conducted emissions testing performed in a shielded screen room located at Rogers Labs, Inc., 4405 West 259<sup>th</sup> Terrace, Louisburg, KS
- Antenna port      Antenna port conducted emissions testing was performed in a shielded screen room located at Rogers Labs, Inc., 4405 West 259<sup>th</sup> Terrace, Louisburg, KS
- Radiated EMI      The radiated emissions tests were performed at the 3 meters, Open Area Test Site (OATS) located at Rogers Labs, Inc., 4405 West 259<sup>th</sup> Terrace, Louisburg, KS

Registered Site information: FCC Site: US5305, ISED: 3041A, CAB Identifier: US0096

NVLAP Accreditation      Lab code 200087-0



## List of Test Equipment

<u>Equipment</u>	<u>Manufacturer</u>	<u>Model (SN)</u>	<u>Band</u>	<u>Cal Date(m/d/y)</u>	<u>Due</u>
<input checked="" type="checkbox"/> LISN	FCC	FCC-LISN-50-25-10(1PA) (160611)	.15-30MHz	4/18/2019	4/18/2020
<input checked="" type="checkbox"/> LISN	Compliance Design	FCC-LISN-2.Mod.cd,(126)	.15-30MHz	10/14/2019	10/14/2020
<input checked="" type="checkbox"/> Cable	Huber & Suhner Inc.	Sucoflex102ea(L10M)(303073)	9kHz-40 GHz	10/14/2019	10/14/2020
<input checked="" type="checkbox"/> Cable	Huber & Suhner Inc.	Sucoflex102ea(1.5M)(303069)	9kHz-40 GHz	10/14/2019	10/14/2020
<input checked="" type="checkbox"/> Cable	Huber & Suhner Inc.	Sucoflex102ea(1.5M)(303071)	9kHz-40 GHz	10/14/2019	10/14/2020
<input checked="" type="checkbox"/> Cable	Belden	RG-58 (L1-CAT3-11509)	9kHz-30 MHz	10/14/2019	10/14/2020
<input checked="" type="checkbox"/> Cable	Belden	RG-58 (L2-CAT3-11509)	9kHz-30 MHz	10/14/2019	10/14/2020
<input checked="" type="checkbox"/> Antenna	Com Power	AL-130 (121055)	.001-30 MHz	10/14/2019	10/14/2020
<input type="checkbox"/> Antenna:	EMCO	6509	.001-30 MHz	10/16/2018	10/16/2020
<input type="checkbox"/> Antenna	ARA	BCD-235-B (169)	20-350MHz	10/14/2019	10/14/2020
<input type="checkbox"/> Antenna:	Schwarzbeck Model:	BBA 9106/VHBB 9124 (9124-627)		4/18/2019	4/18/2021
<input checked="" type="checkbox"/> Antenna	Sunol	JB-6 (A100709)	30-1000 MHz	10/14/2019	10/14/2020
<input type="checkbox"/> Antenna	ETS-Lindgren	3147 (40582)	200-1000MHz	10/14/2019	10/14/2020
<input type="checkbox"/> Antenna:	Schwarzbeck Model:	VULP 9118 A (VULP 9118 A-534)		4/18/2019	4/18/2021
<input checked="" type="checkbox"/> Antenna	ETS-Lindgren	3117 (200389)	1-18 GHz	5/02/2019	5/2/2020
<input type="checkbox"/> Antenna	Com Power	AH-118 (10110)	1-18 GHz	10/14/2019	10/14/2020
<input checked="" type="checkbox"/> Antenna	Com Power	AH-840 (101046)	18-40 GHz	4/18/2019	4/18/2021
<input checked="" type="checkbox"/> Analyzer	Rohde & Schwarz	ESU40 (100108)	20Hz-40GHz	4/18/2019	4/18/2020
<input checked="" type="checkbox"/> Analyzer	Rohde & Schwarz	ESW44 (101534)	20Hz-44GHz	1/31/2019	1/31/2020
<input type="checkbox"/> Analyzer	Rohde & Schwarz	FS-Z60, 90, 140, and 220	40GHz-220GHz	12/22/2017	12/22/2027
<input checked="" type="checkbox"/> Amplifier	Com-Power	PA-010 (171003)	100Hz-30MHz	10/14/2019	10/14/2020
<input checked="" type="checkbox"/> Amplifier	Com-Power	CPPA-102 (01254)	1-1000 MHz	10/14/2019	10/14/2020
<input checked="" type="checkbox"/> Amplifier	Com-Power	PAM-118A (551014)	0.5-18 GHz	10/14/2019	10/14/2020
<input checked="" type="checkbox"/> Amplifier	Com-Power	PAM-840A (461328)	18-40 GHz	10/14/2019	10/14/2020
<input type="checkbox"/> Power Meter	Agilent	N1911A with N1921A	0.05-40 GHz	4/18/2019	4/18/2020
<input type="checkbox"/> Generator	Rohde & Schwarz	SMB100A6 (100150)	20Hz-6 GHz	4/18/2019	4/18/2020
<input type="checkbox"/> Generator	Rohde & Schwarz	SMBV100A6 (260771)	20Hz-6 GHz	4/18/2019	4/18/2020
<input type="checkbox"/> RF Filter	Micro-Tronics	BRC50722 (009).9G notch	30-18000 MHz	4/18/2019	4/18/2020
<input type="checkbox"/> RF Filter	Micro-Tronics	HPM50114 (017)1.5G HPF	30-18000 MHz	4/18/2019	4/18/2020
<input type="checkbox"/> RF Filter	Micro-Tronics	HPM50117 (063) 3G HPF	30-18000 MHz	4/18/2019	4/18/2020
<input type="checkbox"/> RF Filter	Micro-Tronics	HPM50105 (059) 6G HPF	30-18000 MHz	4/18/2019	4/18/2020
<input type="checkbox"/> RF Filter	Micro-Tronics	BRM50702 (172) 2G notch	30-18000 MHz	4/18/2019	4/18/2020
<input type="checkbox"/> RF Filter	Micro-Tronics	BRC50703 (G102) 5G notch	30-18000 MHz	4/18/2019	4/18/2020
<input type="checkbox"/> RF Filter	Micro-Tronics	BRC50705 (024) 5G notch	30-18000 MHz	4/18/2019	4/18/2020
<input type="checkbox"/> Attenuator	Fairview	SA6NFN100W-40 (1625)	30-18000 MHz	4/18/2019	4/18/2020
<input type="checkbox"/> Attenuator	Mini-Circuits	VAT-3W2+ (1436)	30-6000 MHz	4/18/2019	4/18/2020
<input type="checkbox"/> Attenuator	Mini-Circuits	VAT-3W2+ (1445)	30-6000 MHz	4/18/2019	4/18/2020
<input type="checkbox"/> Attenuator	Mini-Circuits	VAT-3W2+ (1735)	30-6000 MHz	4/18/2019	4/18/2020
<input type="checkbox"/> Attenuator	Mini-Circuits	VAT-6W2+ (1438)	30-6000 MHz	4/18/2019	4/18/2020
<input type="checkbox"/> Attenuator	Mini-Circuits	VAT-6W2+ (1736)	30-6000 MHz	4/18/2019	4/18/2020
<input checked="" type="checkbox"/> Weather station	Davis	6312 (A81120N075)		11/4/2019	11/4/2020

Rogers Labs, Inc.  
4405 West 259<sup>th</sup> Terrace  
Louisburg, KS 66053  
Phone/Fax: (913) 837-3214  
Revision 1

Garmin International, Inc.  
Model: A03847  
Test: 191125  
Test to: CFR47 15.249, RSS-210, RSS-Gen  
File: A03847 DXX TstRpt 191125

SN: 3315409516 / 3315409596  
FCC ID: IPH-03847  
IC: 1792A-03847  
Date: February 12, 2020  
Page 17 of 65

## Units of Measurements

Conducted EMI            Data presented in dB $\mu$ V; dB referenced to one microvolt

Antenna port Conducted            Data is in dBm; dB referenced to one milliwatt

Radiated EMI            Data presented in dB $\mu$ V/m; dB referenced to one microvolt per meter

Note: Radiated limit may be expressed for measurement in dB $\mu$ V/m when the measurement is taken at a distance of 3 or 10 meters. Data taken for this report was taken at distance of 3 meters. Sample calculation demonstrates corrected field strength reading for Open Area Test Site using the measurement reading and correcting for receive antenna factor, cable losses, and amplifier gains.

Sample Calculation:

RFS = Radiated Field Strength, FSM = Field Strength Measured

A.F. = Receive antenna factor, Losses = attenuators/cable losses, Gain = amplification gains

$RFS (dB\mu V/m @ 3m) = FSM (dB\mu V) + A.F. (dB/m) + Losses (dB) - Gain (dB)$

## Environmental Conditions

Ambient Temperature            20.7° C

Relative Humidity            33 %

Atmospheric Pressure            1006.0 mb

## Statement of Modifications and Deviations

No modifications to the EUT were required for the equipment to demonstrate compliance with the 47 CFR Part 15C, Industry Canada RSS-210 Issue 10, and RSS-GEN Issue 5 emission requirements. There were no deviations to the specifications.

## **Intentional Radiators**

The following information is submitted supporting compliance with the requirements of 47 CFR, Subpart C, paragraph 15.249, Industry Canada RSS-210 Issue 10 and RSS-GEN Issue 5.

### ***Antenna Requirements***

The EUT incorporates integral antenna system. Production equipment offers no provision for connection to alternate antenna system. The antenna connection point complies with the unique antenna connection requirements. There are no deviations or exceptions to the specification.

### ***Restricted Bands of Operation***

Spurious emissions falling in the restricted frequency bands of operation were measured at the OATS. The EUT utilizes frequency, determining circuitry, which generates harmonics falling in the restricted bands. Emissions were investigated at the OATS, using appropriate antennas or pyramidal horns, amplification stages, and a spectrum analyzer. Peak and average amplitudes of frequencies above 1000 MHz were compared to the required limits with worst-case data presented below. Test procedures of ANSI C63.10-2013 were used during testing. No other significant emission was observed which fell into the restricted bands of operation. Computed emission values consider the received radiated field strength, receive antenna correction factor, amplifier gain stage, and test system cable losses.

**Table 1 Radiated Emissions in Restricted Frequency Bands Data Mode 1 ANT (GFSK)**

Frequency in MHz	Horizontal Peak (dB $\mu$ V/m)	Horizontal Average (dB $\mu$ V/m)	Vertical Peak (dB $\mu$ V/m)	Vertical Average (dB $\mu$ V/m)	Limit @ 3m (dB $\mu$ V/m)	Horizontal Margin (dB)	Vertical Margin (dB)
2390.0	44.5	31.4	46.1	31.4	54.0	-22.6	-22.6
2483.5	58.6	34.0	52.9	33.7	54.0	-20.0	-20.3
4804.0	49.1	36.3	50.1	36.9	54.0	-17.7	-17.1
4882.0	49.8	36.9	49.5	36.3	54.0	-17.1	-17.7
4960.0	49.1	35.9	49.7	36.6	54.0	-18.1	-17.4
7206.0	52.3	39.7	52.5	39.4	54.0	-14.3	-14.6
7323.0	52.2	39.6	52.8	39.9	54.0	-14.4	-14.1
7440.0	52.7	39.7	52.9	40.0	54.0	-14.3	-14.0
12010.0	58.0	45.3	57.6	45.0	54.0	-8.7	-9.0
12205.0	57.6	45.1	58.8	45.7	54.0	-8.9	-8.3
12400.0	58.5	45.2	58.3	45.4	54.0	-8.8	-8.6

Other emissions present had amplitudes at least 20 dB below the limit. Peak and Quasi-Peak amplitude emissions are recorded for frequency below 1000 MHz. Peak and Average amplitude emissions are recorded for frequency range above 1000 MHz.

**Table 2 Radiated Emissions in Restricted Frequency Bands Data Mode 2 BT BR (GFSK)**

Frequency in MHz	Horizontal Peak (dBµV/m)	Horizontal Average (dBµV/m)	Vertical Peak (dBµV/m)	Vertical Average (dBµV/m)	Limit @ 3m (dBµV/m)	Horizontal Margin (dB)	Vertical Margin (dB)
2390.0	71.6	47.3	71.9	49.5	54.0	-6.7	-4.5
2483.5	62.7	47.4	67.5	48.6	54.0	-6.6	-5.4
4804.0	49.6	36.3	49.6	36.4	54.0	-17.7	-17.6
4882.0	48.7	36.0	49.4	36.0	54.0	-18.0	-18.0
4960.0	48.9	36.1	49.0	36.2	54.0	-17.9	-17.8
7206.0	52.3	39.8	52.8	39.8	54.0	-14.2	-14.2
7323.0	52.4	39.8	53.7	40.2	54.0	-14.2	-13.8
7440.0	52.8	40.2	53.2	40.3	54.0	-13.8	-13.7
12010.0	58.4	45.3	59.2	45.4	54.0	-8.7	-8.6
12205.0	58.3	45.6	58.9	45.9	54.0	-8.4	-8.1
12400.0	58.0	45.5	58.9	45.5	54.0	-8.5	-8.5

Other emissions present had amplitudes at least 20 dB below the limit. Peak and Quasi-Peak amplitude emissions are recorded for frequency below 1000 MHz. Peak and Average amplitude emissions are recorded for frequency range above 1000 MHz.

**Table 3 Radiated Emissions in Restricted Frequency Bands Data Mode 3 BT 2EDR ( $\pi/4$  DQPSK)**

Frequency in MHz	Horizontal Peak (dB $\mu$ V/m)	Horizontal Average (dB $\mu$ V/m)	Vertical Peak (dB $\mu$ V/m)	Vertical Average (dB $\mu$ V/m)	Limit @ 3m (dB $\mu$ V/m)	Horizontal Margin (dB)	Vertical Margin (dB)
2390.0	63.9	46.7	67.8	48.4	54.0	-7.3	-5.6
2483.5	65.1	47.0	65.1	47.3	54.0	-7.0	-6.7
4804.0	48.9	36.3	49.1	36.3	54.0	-17.7	-17.7
4882.0	48.8	36.2	48.6	36.1	54.0	-17.8	-17.9
4960.0	49.6	36.3	49.5	36.1	54.0	-17.7	-17.9
7206.0	52.9	39.7	53.1	39.7	54.0	-14.3	-14.3
7323.0	53.2	40.3	53.0	40.4	54.0	-13.7	-13.6
7440.0	53.0	40.0	53.1	40.3	54.0	-14.0	-13.7
12010.0	58.6	45.5	57.8	45.4	54.0	-8.5	-8.6
12205.0	59.5	46.0	59.0	45.9	54.0	-8.0	-8.1
12400.0	58.4	45.5	58.9	45.4	54.0	-8.5	-8.6

Other emissions present had amplitudes at least 20 dB below the limit. Peak and Quasi-Peak amplitude emissions are recorded for frequency below 1000 MHz. Peak and Average amplitude emissions are recorded for frequency range above 1000 MHz.

**Table 4 Radiated Emissions in Restricted Frequency Bands Data Mode 4 BT 3EDR (8DPSK)**

Frequency in MHz	Horizontal Peak (dBµV/m)	Horizontal Average (dBµV/m)	Vertical Peak (dBµV/m)	Vertical Average (dBµV/m)	Limit @ 3m (dBµV/m)	Horizontal Margin (dB)	Vertical Margin (dB)
2390.0	64.1	46.6	64.4	46.8	54.0	-7.4	-7.2
2483.5	67.4	47.1	63.8	48.0	54.0	-6.9	-6.0
4804.0	49.4	36.2	48.5	36.3	54.0	-17.8	-17.7
4882.0	48.9	35.8	48.8	35.9	54.0	-18.2	-18.1
4960.0	48.6	36.1	49.3	36.1	54.0	-17.9	-17.9
7206.0	52.3	39.7	53.0	39.8	54.0	-14.3	-14.2
7323.0	53.1	40.0	53.3	40.2	54.0	-14.0	-13.8
7440.0	53.3	40.0	53.1	40.3	54.0	-14.0	-13.7
12010.0	58.3	45.3	58.3	45.3	54.0	-8.7	-8.7
12205.0	58.3	45.6	58.7	45.8	54.0	-8.4	-8.2
12400.0	58.8	45.6	58.3	45.6	54.0	-8.4	-8.4

Other emissions present had amplitudes at least 20 dB below the limit. Peak and Quasi-Peak amplitude emissions are recorded for frequency below 1000 MHz. Peak and Average amplitude emissions are recorded for frequency range above 1000 MHz.

**Table 5 Radiated Emissions in Restricted Frequency Bands Data Mode 5 BT BLE (GMSK)**

Frequency in MHz	Horizontal Peak (dB $\mu$ V/m)	Horizontal Average (dB $\mu$ V/m)	Vertical Peak (dB $\mu$ V/m)	Vertical Average (dB $\mu$ V/m)	Limit @ 3m (dB $\mu$ V/m)	Horizontal Margin (dB)	Vertical Margin (dB)
2390.0	62.5	46.3	65.5	47.2	54.0	-7.7	-6.8
2483.5	65.2	47.0	68.0	48.4	54.0	-7.0	-5.6
4804.0	48.9	36.2	49.3	36.2	54.0	-17.8	-17.8
4884.0	49.0	35.9	48.5	35.9	54.0	-18.1	-18.1
4960.0	49.8	36.0	48.4	36.1	54.0	-18.0	-17.9
7206.0	52.4	39.7	53.2	39.7	54.0	-14.3	-14.3
7326.0	53.2	40.0	53.8	40.2	54.0	-14.0	-13.8
7440.0	53.0	40.0	53.4	40.4	54.0	-14.0	-13.6
12010.0	58.3	45.3	57.9	45.3	54.0	-8.7	-8.7
12210.0	58.2	45.6	58.1	45.6	54.0	-8.4	-8.4
12400.0	57.7	45.4	58.6	45.7	54.0	-8.6	-8.3

Other emissions present had amplitudes at least 20 dB below the limit. Peak and Quasi-Peak amplitude emissions are recorded for frequency below 1000 MHz. Peak and Average amplitude emissions are recorded for frequency range above 1000 MHz.

### **Summary of Results for Radiated Emissions in Restricted Bands**

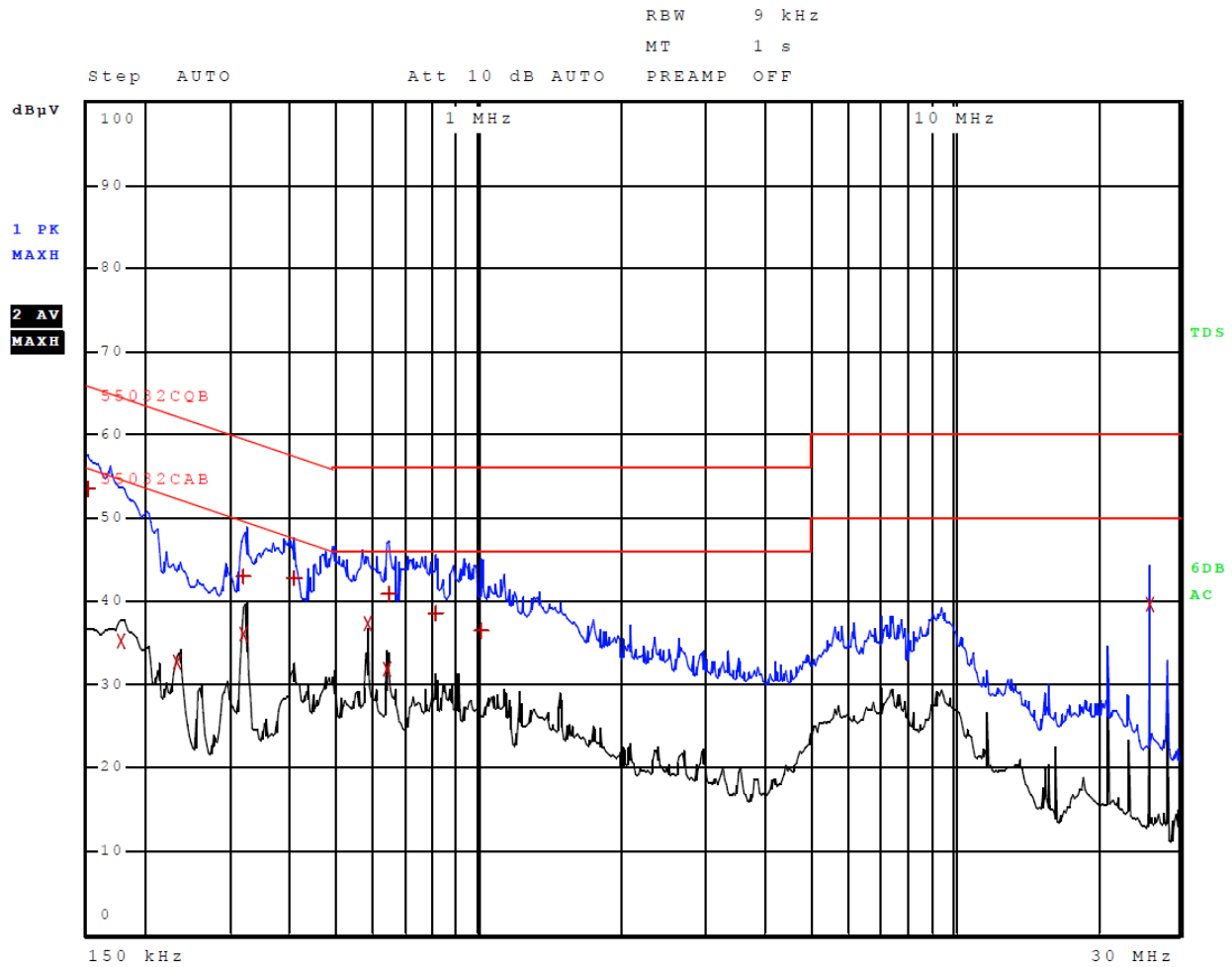
The EUT demonstrated compliance with the radiated emissions requirements of 47 CFR Part 15C and RSS-210 Issue 10 Intentional Radiator requirements. The EUT demonstrated a worst-case minimum margin of -4.5 dB below the emissions requirements in restricted frequency bands. Peak, Quasi-peak, and average amplitudes were checked for compliance with the regulations. Worst-case emissions are reported with other emissions found in the restricted frequency bands at least 20 dB below the requirements.



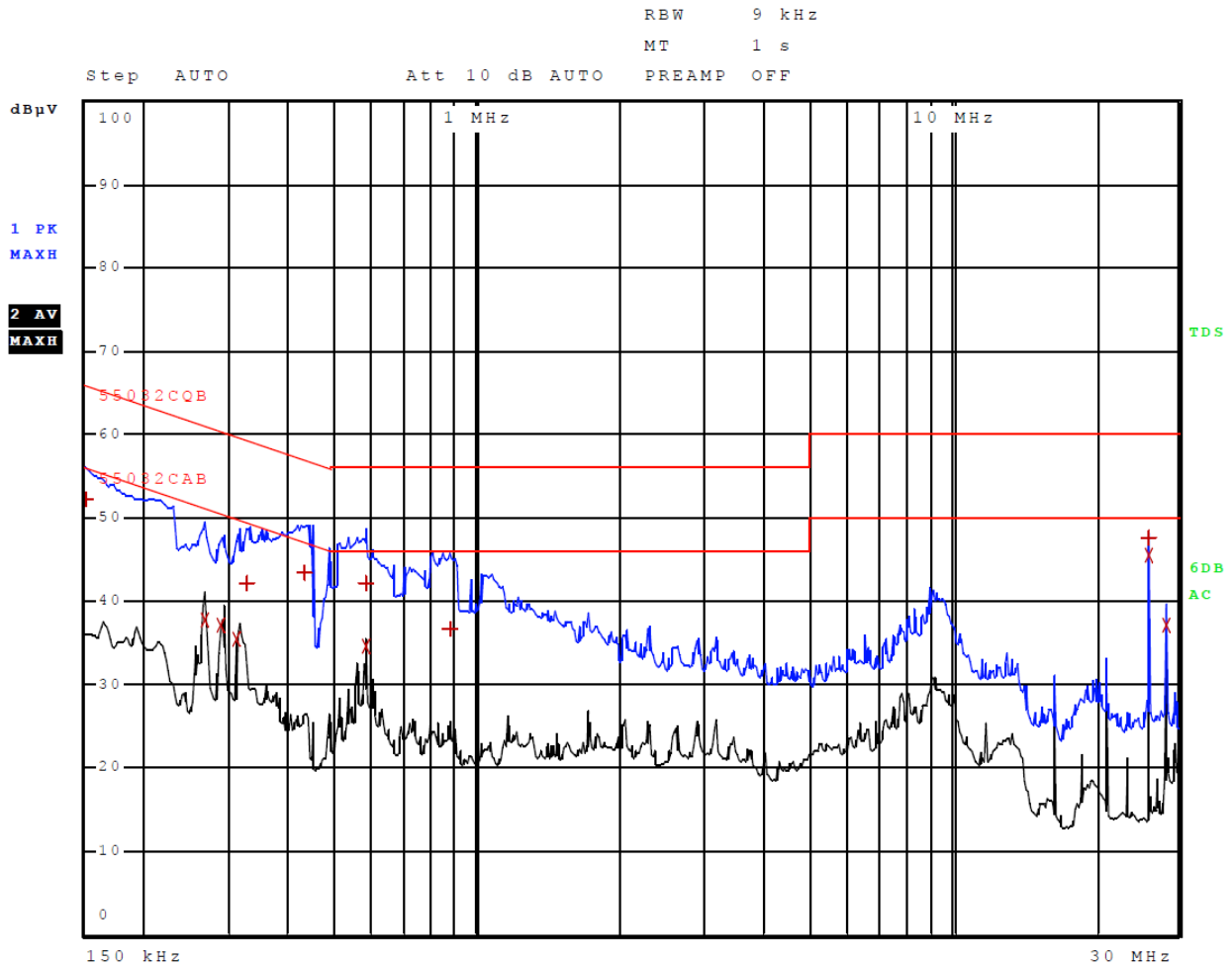
### **AC Line Conducted EMI Procedure**

The EUT was arranged in typical equipment configurations as offered by manufacturer and presented above in equipment configuration. AC Line Conducted emission testing was performed with the EUT placed on a 1 x 1.5-meter bench 80 cm above the conducting ground plane, floor of a screen room. The bench was positioned 40 cm away from the wall of the screen room. The LISN was positioned on the floor of the screen room 80-cm from the rear of the EUT. Testing for the AC line-conducted emissions followed the procedures of ANSI C63.10-2013. The EUT was configured as presented in the AC Line conducted configurations as directed by the manufacture and presented above in equipment configuration. The AC adapter for the EUT was connected to the LISN for AC line-conducted emissions testing. A second LISN was positioned on the floor of the screen room 80-cm from the rear of the supporting equipment of the test configuration. All power cords except the EUT were then powered from the second LISN. EMI was coupled to the spectrum analyzer through a 0.1 µF capacitor, internal to the LISN. Power line conducted emissions testing was carried out individually for each current carrying conductor of the EUT. The excess length of lead between the system and the LISN receptacle was folded back and forth to form a bundle not exceeding 40 cm in length. The screen room, conducting ground plane, analyzer, and LISN were bonded together to the protective earth ground. Preliminary testing was performed to identify the frequencies of each of the emissions, which demonstrated the highest amplitudes. The cables were repositioned to obtain maximum amplitude of measured EMI level. Once the worst-case configuration was identified, plots were made of the EMI from 0.15 MHz to 30 MHz and data recorded.

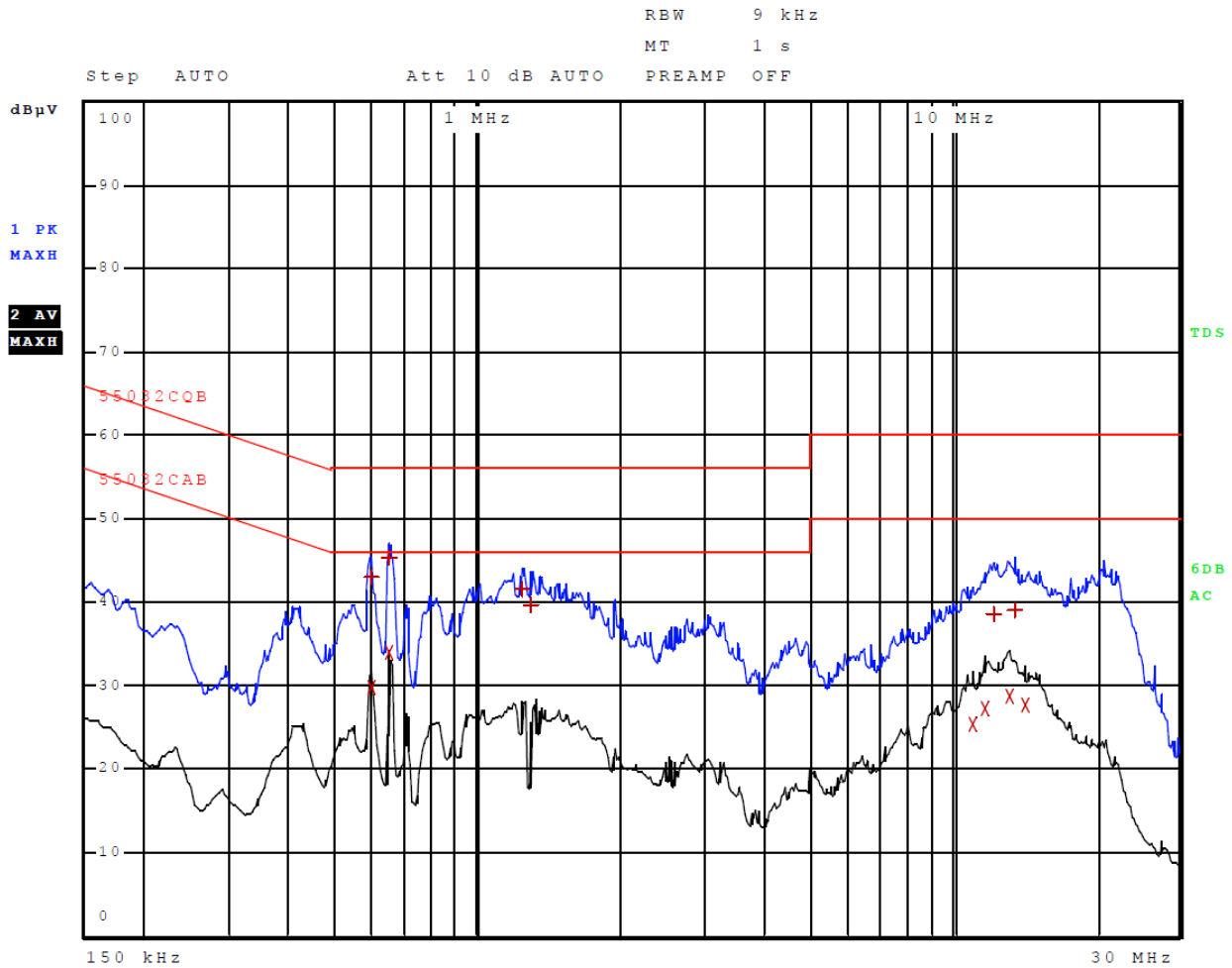
Refer to figures one and two for plots of the EUT configuration #3 AC Line conducted emissions. Refer to figures three and four showing plots of the EUT configuration #4 AC Line conducted emissions.



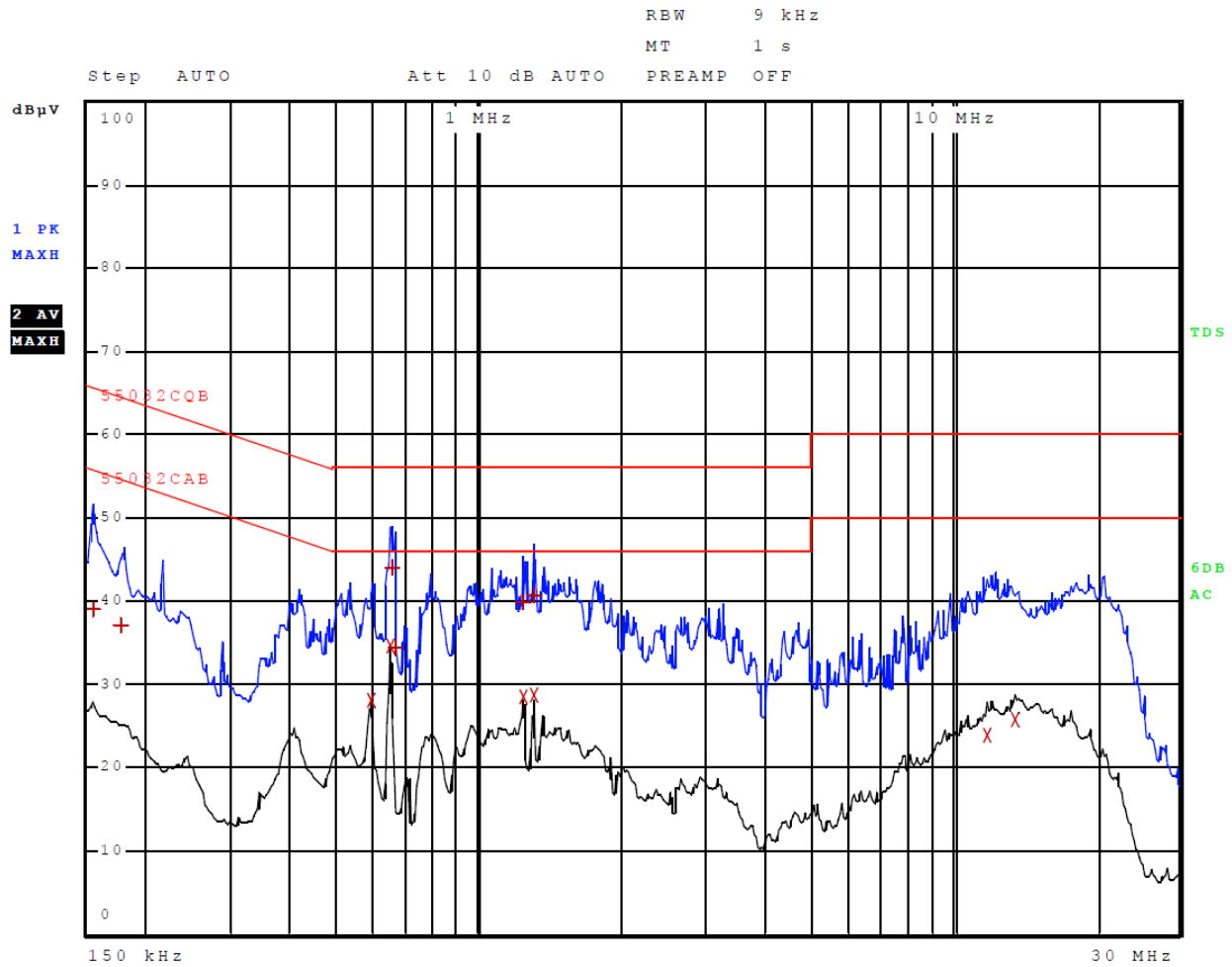
**Figure 1 AC Line Conducted emissions of EUT line 1 Configuration #3**



**Figure 2 AC Line Conducted emissions of EUT line 2 Configuration #3**



**Figure 3 AC Line Conducted emissions of EUT line 1 Configuration #4**



**Figure 4 AC Line Conducted emissions of EUT line 2 Configuration #4**

**Table 6 AC Line Conducted Emissions Data L1 Configuration #3**

Trace	Frequency	Level (dBµV)	Detector	Delta Limit/dB
1	150.000000000 kHz	53.56	Quasi Peak	-12.44
2	178.000000000 kHz	35.20	Average	-19.38
2	234.000000000 kHz	32.69	Average	-19.61
1	322.000000000 kHz	42.87	Quasi Peak	-16.79
2	322.000000000 kHz	36.03	Average	-13.63
1	406.000000000 kHz	42.82	Quasi Peak	-14.91
2	578.000000000 kHz	37.25	Average	-8.75
2	638.000000000 kHz	31.83	Average	-14.17
1	642.000000000 kHz	40.89	Quasi Peak	-15.11
1	810.000000000 kHz	38.57	Quasi Peak	-17.43
1	1.006000000 MHz	36.55	Quasi Peak	-19.45
2	25.872000000 MHz	39.51	Average	-10.49

Other emissions present had amplitudes at least 20 dB below the limit.

**Table 7 AC Line Conducted Emissions Data L2 Configuration #3**

Trace	Frequency	Level (dBµV)	Detector	Delta Limit/dB
1	150.000000000 kHz	52.12	Quasi Peak	-13.88
2	266.000000000 kHz	37.80	Average	-13.44
2	290.000000000 kHz	37.17	Average	-13.36
2	314.000000000 kHz	35.45	Average	-14.41
1	330.000000000 kHz	42.10	Quasi Peak	-17.35
1	430.000000000 kHz	43.32	Quasi Peak	-13.94
2	578.000000000 kHz	34.58	Average	-11.42
1	582.000000000 kHz	42.14	Quasi Peak	-13.86
1	870.000000000 kHz	36.61	Quasi Peak	-19.39
2	25.872000000 MHz	45.46	Average	-4.54
1	25.872000000 MHz	47.59	Quasi Peak	-12.41
2	28.224000000 MHz	37.01	Average	-12.99

Other emissions present had amplitudes at least 20 dB below the limit.

**Table 8 AC Line Conducted Emissions Data L1 Configuration #4**

Trace	Frequency	Level (dBµV)	Detector	Delta Limit/dB
2	594.000000000 kHz	29.72	Average	-16.28
1	594.000000000 kHz	42.89	Quasi Peak	-13.11
2	650.000000000 kHz	33.92	Average	-12.08
1	650.000000000 kHz	45.35	Quasi Peak	-10.65
1	1.242000000 MHz	41.50	Quasi Peak	-14.50
1	1.294000000 MHz	39.62	Quasi Peak	-16.38
2	11.040000000 MHz	25.22	Average	-24.78
2	11.728000000 MHz	27.23	Average	-22.77
1	12.148000000 MHz	38.61	Quasi Peak	-21.39
2	13.116000000 MHz	28.74	Average	-21.26
1	13.468000000 MHz	38.90	Quasi Peak	-21.10
2	14.156000000 MHz	27.62	Average	-22.38

Other emissions present had amplitudes at least 20 dB below the limit.

**Table 9 AC Line Conducted Emissions Data L2 Configuration #4**

Trace	Frequency	Level (dBµV)	Detector	Delta Limit/dB
1	154.000000000 kHz	38.96	Quasi Peak	-26.82
1	178.000000000 kHz	37.00	Quasi Peak	-27.58
2	590.000000000 kHz	28.09	Average	-17.91
2	650.000000000 kHz	34.55	Average	-11.45
1	654.000000000 kHz	43.93	Quasi Peak	-12.07
1	662.000000000 kHz	34.27	Quasi Peak	-21.73
2	1.242000000 MHz	28.49	Average	-17.51
1	1.242000000 MHz	39.74	Quasi Peak	-16.26
2	1.302000000 MHz	28.75	Average	-17.25
1	1.306000000 MHz	40.75	Quasi Peak	-15.25
2	11.808000000 MHz	23.88	Average	-26.12
2	13.524000000 MHz	25.69	Average	-24.31

Other emissions present had amplitudes at least 20 dB below the limit.

**Summary of Results for AC Line Conducted Emissions Results**

The EUT demonstrated compliance with the AC Line Conducted Emissions requirements of 47CFR Part 15C and other applicable emissions requirements. The EUT configuration #3 configuration demonstrated a minimum margin of -4.5 dB below the requirement. The EUT configuration #4 demonstrated a minimum margin of -10.6 dB below the requirement. Other emissions were present with amplitudes at least 20 dB below the limit and worst-case amplitudes recorded.

## **General Radiated Emissions Procedure**

The EUT was arranged in a typical equipment configuration and operated through all available mode during testing. Preliminary testing was performed in a screen room with the EUT positioned 1 meter from the FSM. Radiated emissions measurements were performed to identify the frequencies, which produced the highest emissions. Each radiated emission was then maximized at the OATS location before final radiated measurements were performed. Final data was taken with the EUT located on the OATS at 3 meters distance between the EUT and the receiving antenna. The frequency spectrum from 9 kHz to 25,000 MHz was searched for general radiated emissions. Measured emission levels were maximized by EUT placement on the table, rotating the turntable through 360 degrees, varying the antenna height between 1 and 4 meters above the ground plane and changing antenna position between horizontal and vertical polarization. Antennas used were Loop from 9 kHz to 30 MHz, Broadband Biconical from 30 to 200 MHz, Biconilog from 30 to 1000 MHz, Log Periodic from 200 MHz to 1 GHz and or double Ridge or pyramidal horns and mixers above 1 GHz, notch filters and appropriate amplifiers and external mixers were utilized.



**Table 10 General Radiated Emissions Data**

Frequency (MHz)	Horizontal Peak (dBµV/m)	Horizontal Quasi-Peak (dBµV/m)	Vertical Peak (dBµV/m)	Vertical Quasi-Peak (dBµV/m)	Limit @ 3m (dBµV/m)	Horizontal Margin (dB)	Vertical Margin (dB)
38.0	26.5	20.8	48.7	28.2	40.0	-19.2	-11.8
51.8	23.9	18.6	33.4	28.1	40.0	-21.4	-11.9
65.6	24.4	17.5	29.1	24.4	40.0	-22.5	-15.6
368.3	23.4	16.9	21.5	16.1	47.0	-30.1	-30.9
421.2	25.1	19.1	22.6	17.0	47.0	-27.9	-30.0
844.2	36.9	24.7	39.2	33.2	47.0	-22.3	-13.8
897.1	30.8	24.9	30.8	24.8	47.0	-22.1	-22.2

Other emissions present had amplitudes at least 20 dB below the limit. Peak and Quasi-Peak amplitude emissions are recorded for frequency range below 1000 MHz. Peak and Average amplitude emissions are recorded for frequency range above 1000 MHz.

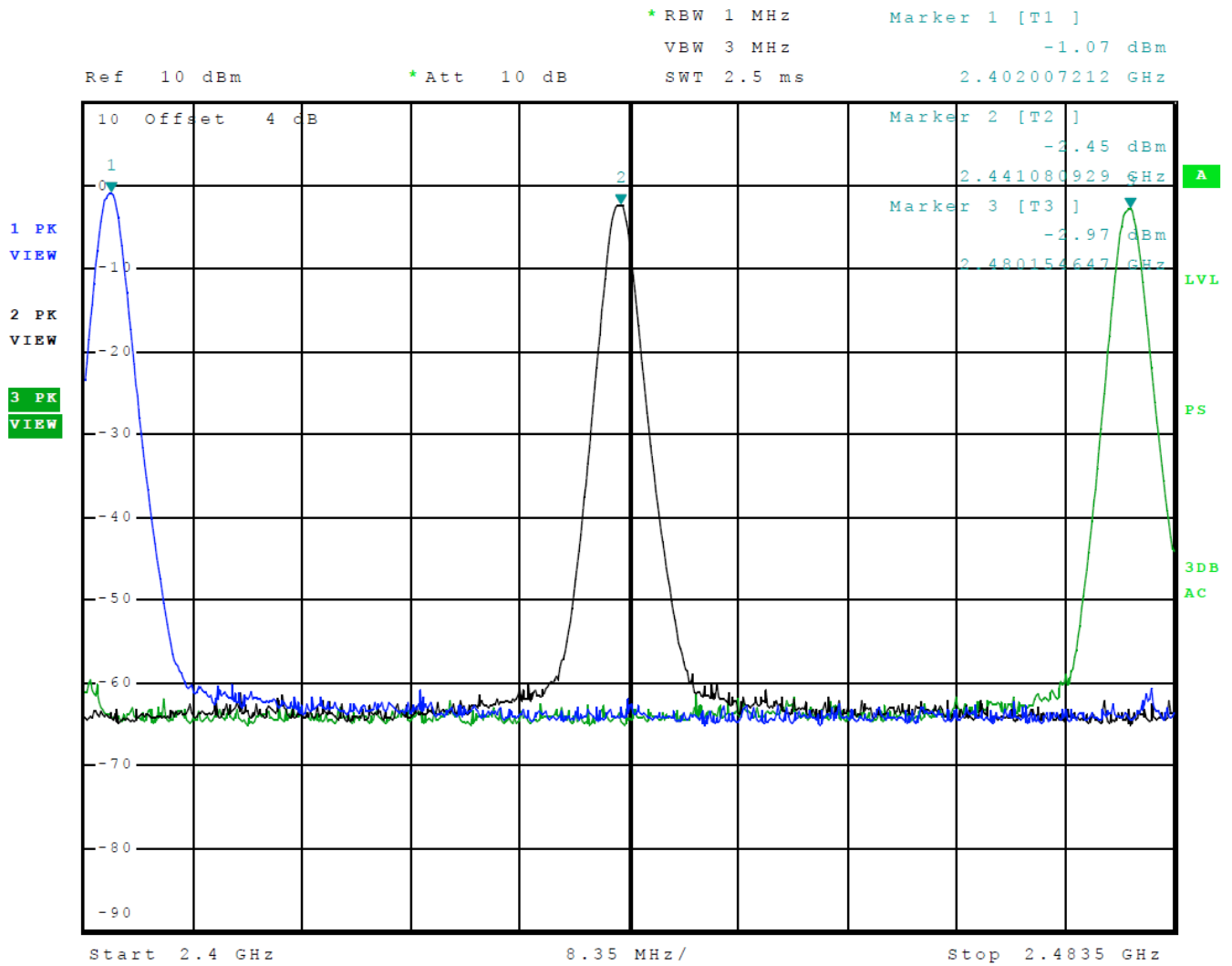
**Summary of Results for General Radiated Emissions**

The EUT demonstrated compliance with the radiated emissions requirements of 47 CFR Part 15C paragraph 15.209, RSS-210 Issue 10, and RSS-GEN Issue 5 Intentional Radiators. The EUT demonstrated a minimum margin of -11.8 dB below the requirements. Other emissions were present with amplitudes at least 20 dB below the Limits.

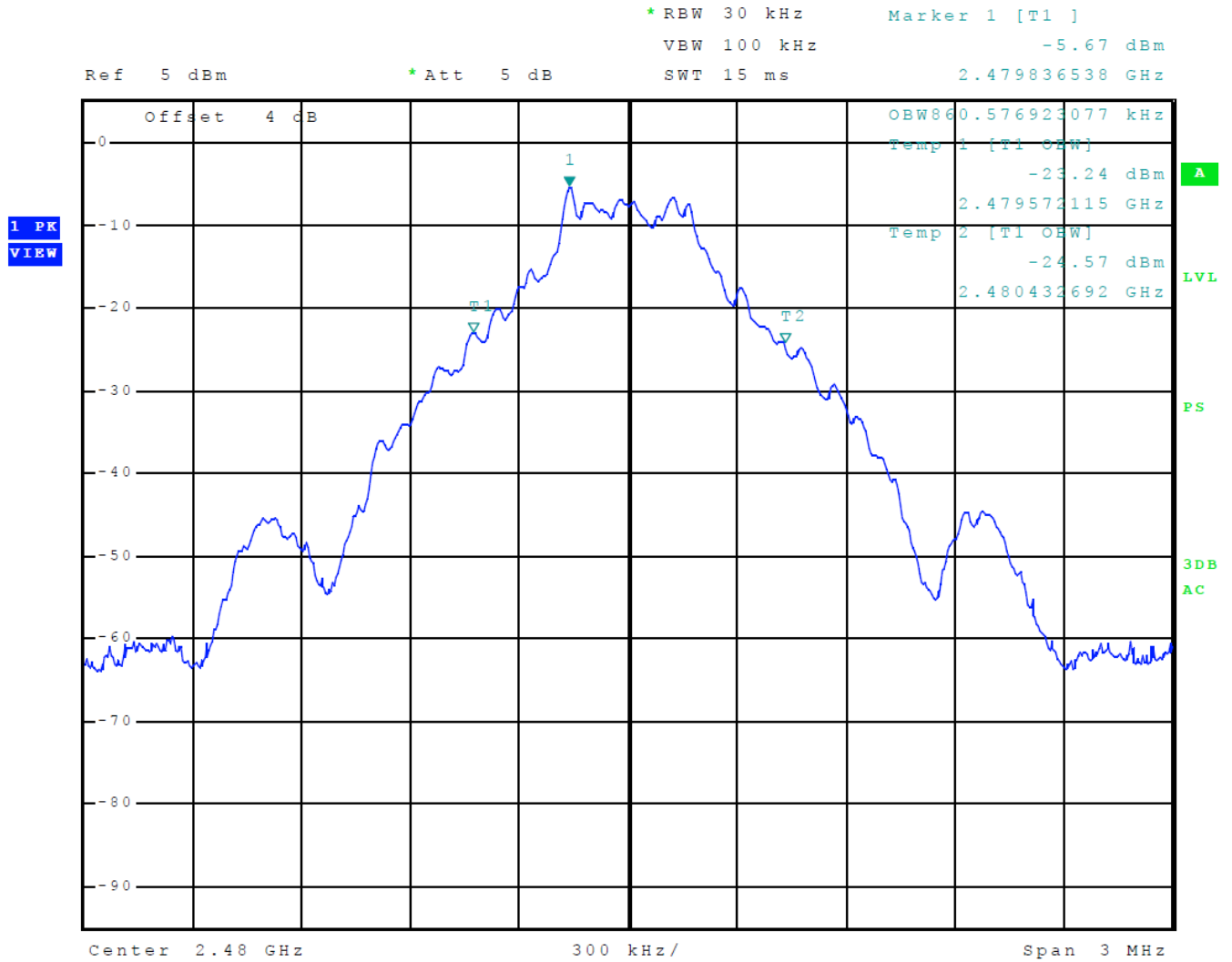
### **Operation in the Band 2400 – 2483.5 MHz**

The transmitter output power; harmonic and general emissions were measured on an open area test site @ 3 meters. The EUT was placed on a turntable elevated as required above the ground plane and at a distance of 3 meters from the FSM antenna. The peak and quasi-peak amplitude of frequencies below 1000 MHz were measured using a spectrum analyzer. The peak and average amplitude of frequencies above 1000 MHz were measured using a spectrum analyzer. The amplitude of each emission was then recorded from the analyzer display. Emissions radiated outside of the specified bands, except for harmonics, shall be attenuated by at least 50 dB below the level of the fundamental or to the general radiated emission limits, whichever is the lesser attenuation. Antenna port emission plots were taken of transmitter performance for reference in this and other documentation using test sample #2. The amplitude of each radiated emission was measured on the OATS at a distance of 3 meters from the FSM antenna testing was performed on sample representative of production with integral antenna (sample #1) with worst-case data provided. The amplitude of each radiated emission was maximized by equipment orientation and placement on the turn table, raising and lowering the FSM (Field Strength Measuring) antenna, changing the FSM antenna polarization, and by rotating the turntable. A Loop antenna was used for measuring emissions from 0.009 to 30 MHz, Biconilog Antenna for 30 to 1000 MHz, Double-Ridge, and/or Pyramidal Horn Antennas from 1 GHz to 25 GHz. Emissions were measured in dB $\mu$ V/m @ 3 meters.

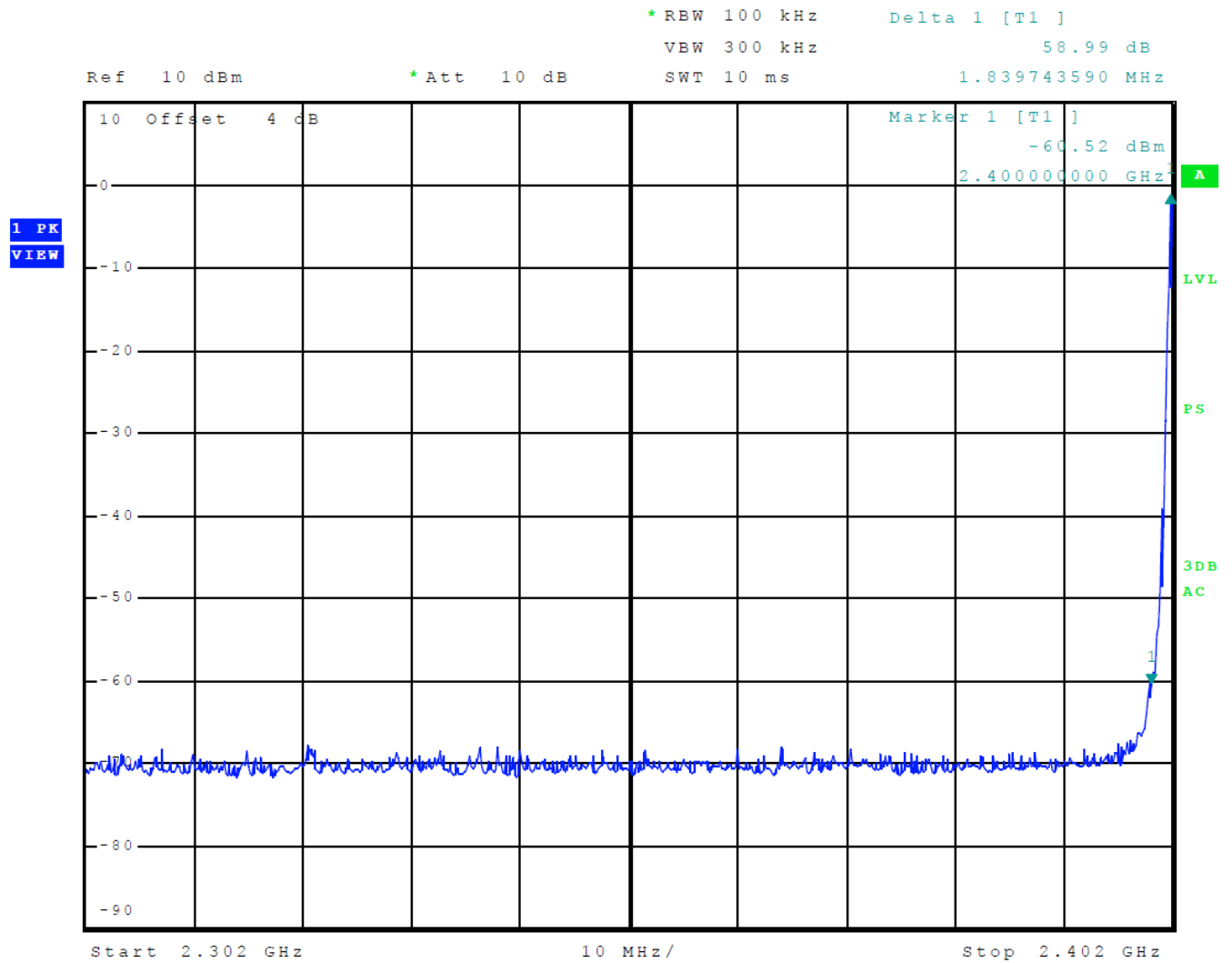
Refer to figures five through twenty-four showing plots taken of the 2402-2480 MHz transmitter operation displaying compliance with the specifications.



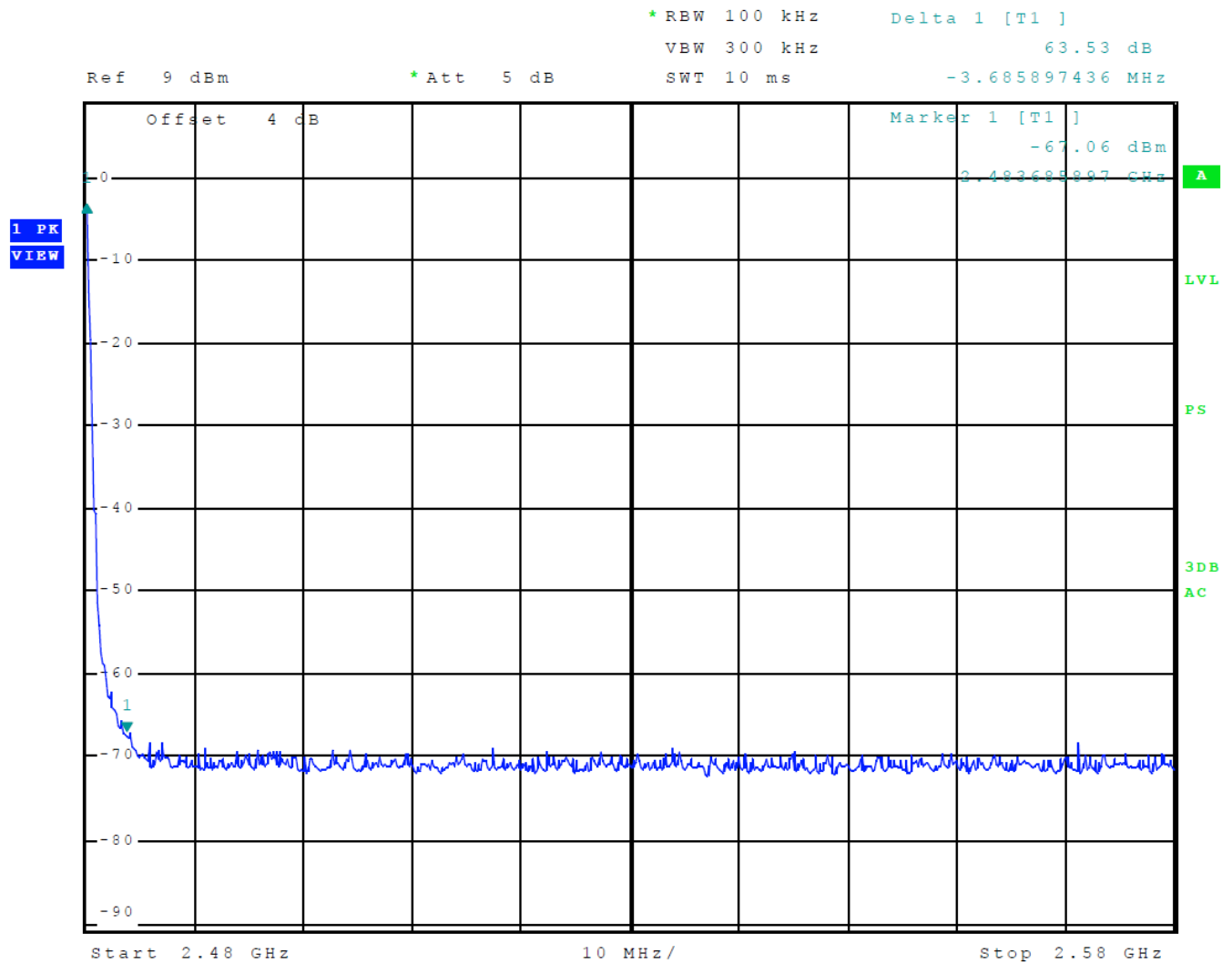
**Figure 5 Plot of Transmitter Emissions Operation in 2402-2480 MHz Mode 1 ANT (GFSK)**



**Figure 6 Plot of Transmitter Emissions 99% Occupied Bandwidth Mode 1 ANT (GFSK)**



**Figure 7 Plot of Transmitter Emissions Low Band Edge Mode 1 ANT (GFSK)**



**Figure 8 Plot of Transmitter Emissions High Band Edge Mode 1 ANT (GFSK)**

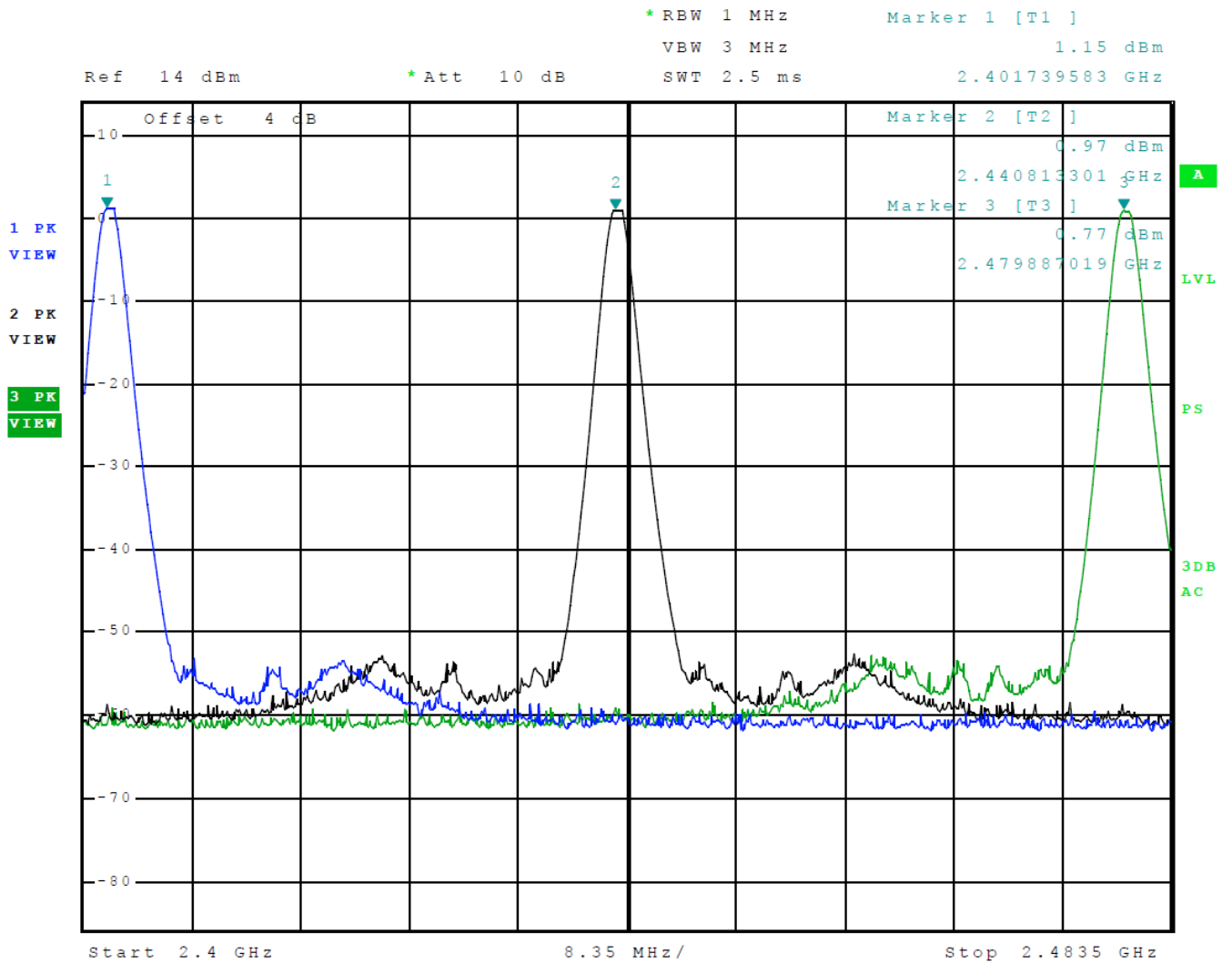
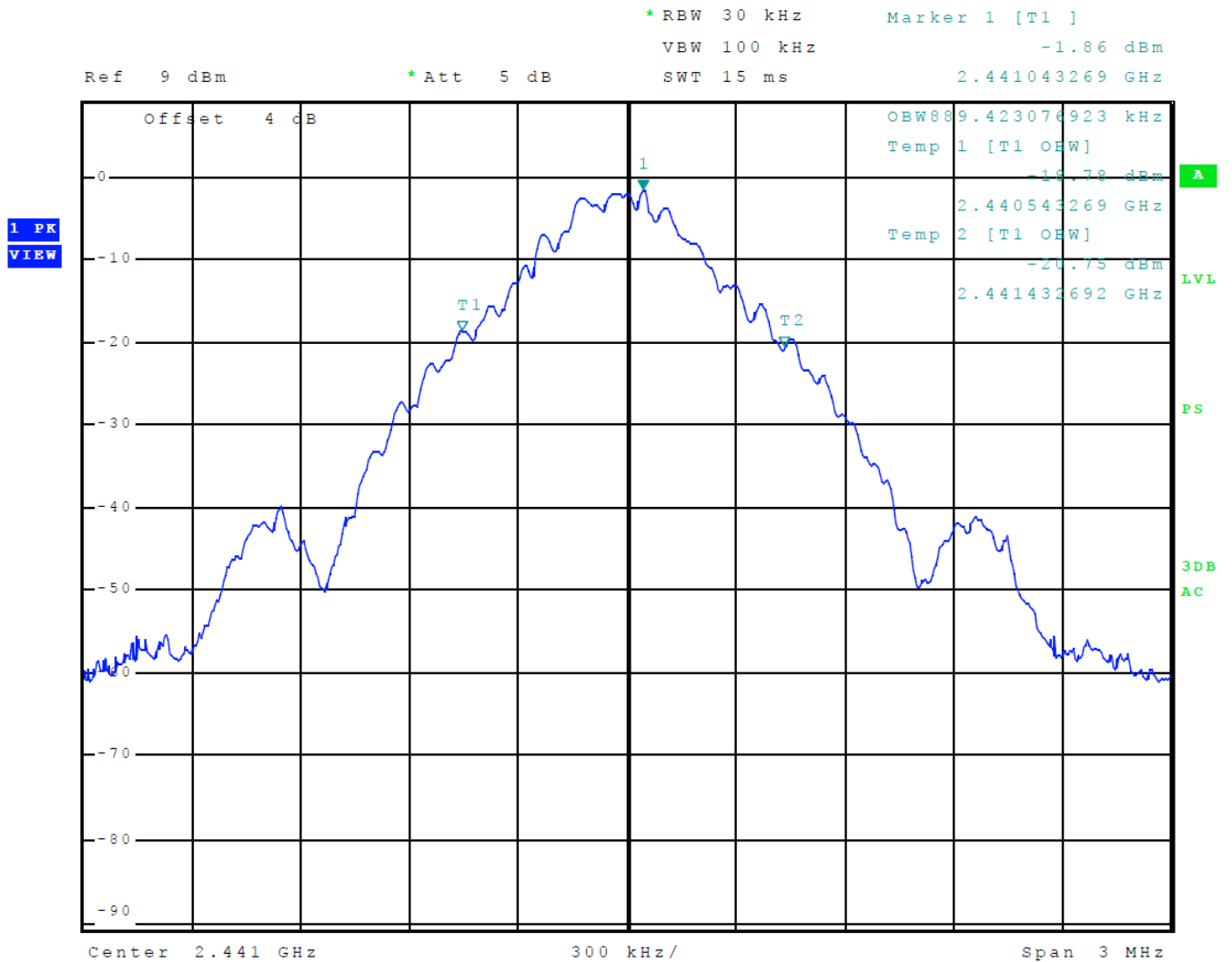
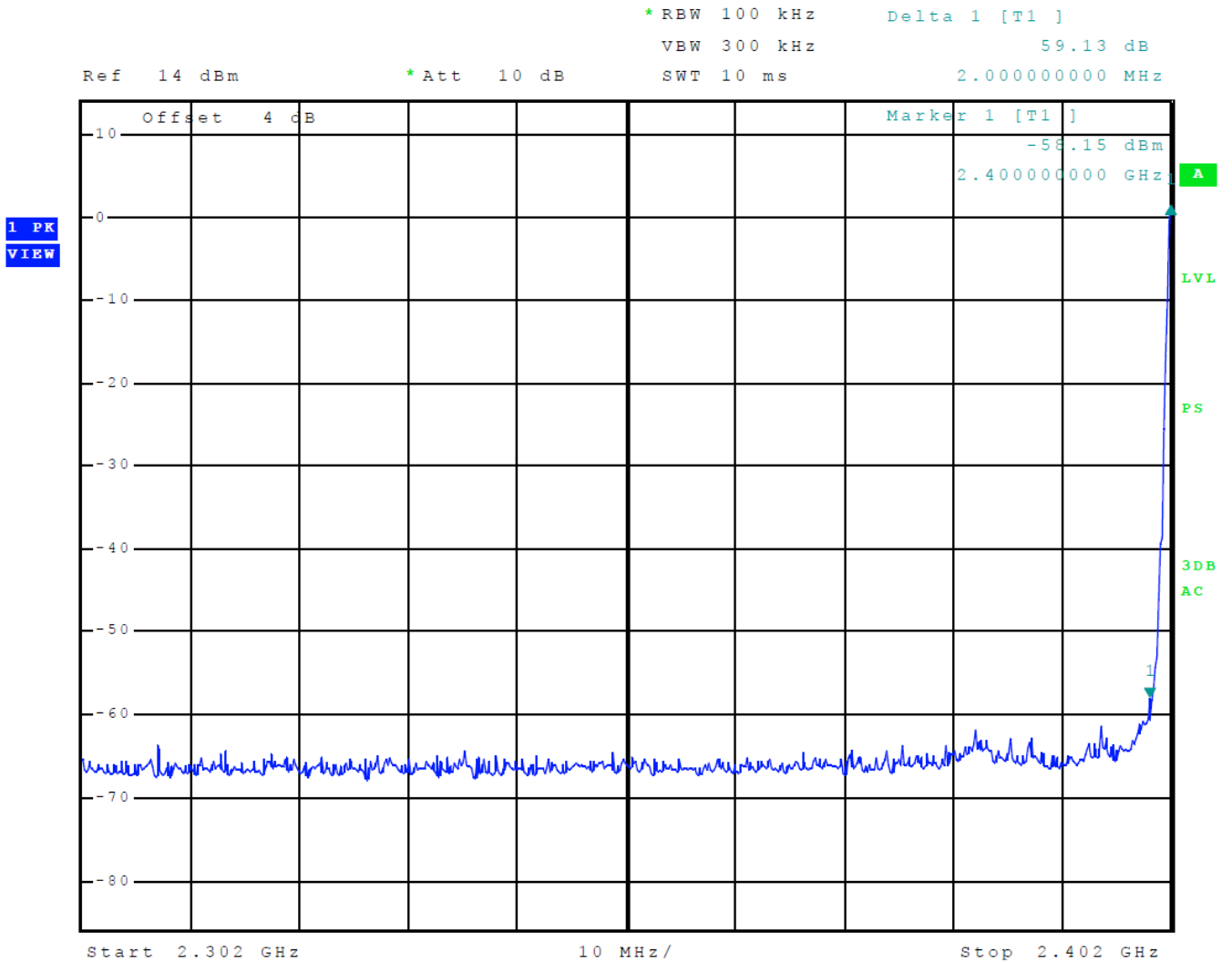


Figure 9 Plot of Transmitter Emissions Operation in 2402-2480 MHz Mode 2 BT BR (GFSK)

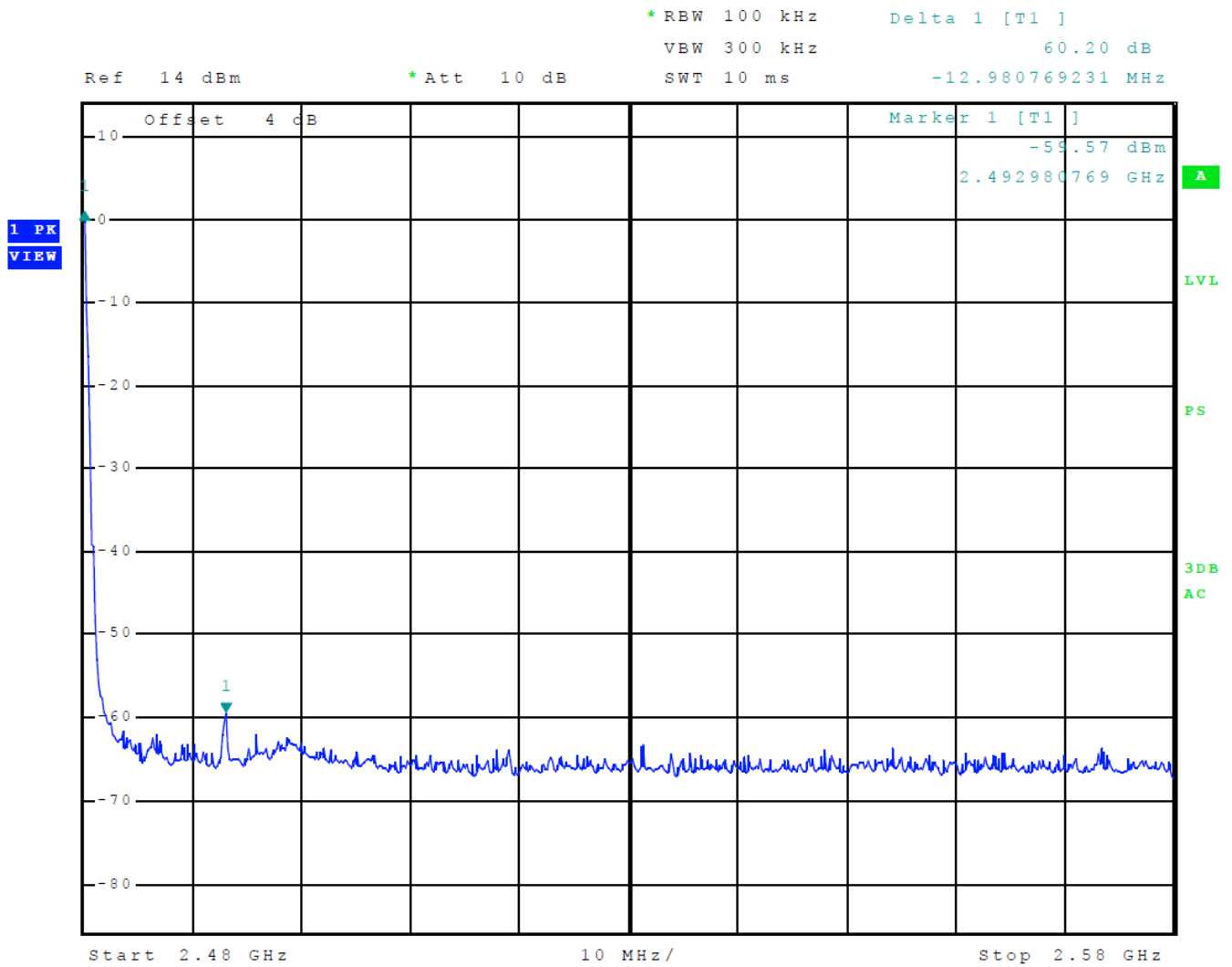


**Figure 10 Plot of Transmitter Emissions 99% Occupied Bandwidth Mode 2 BT BR (GFSK)**

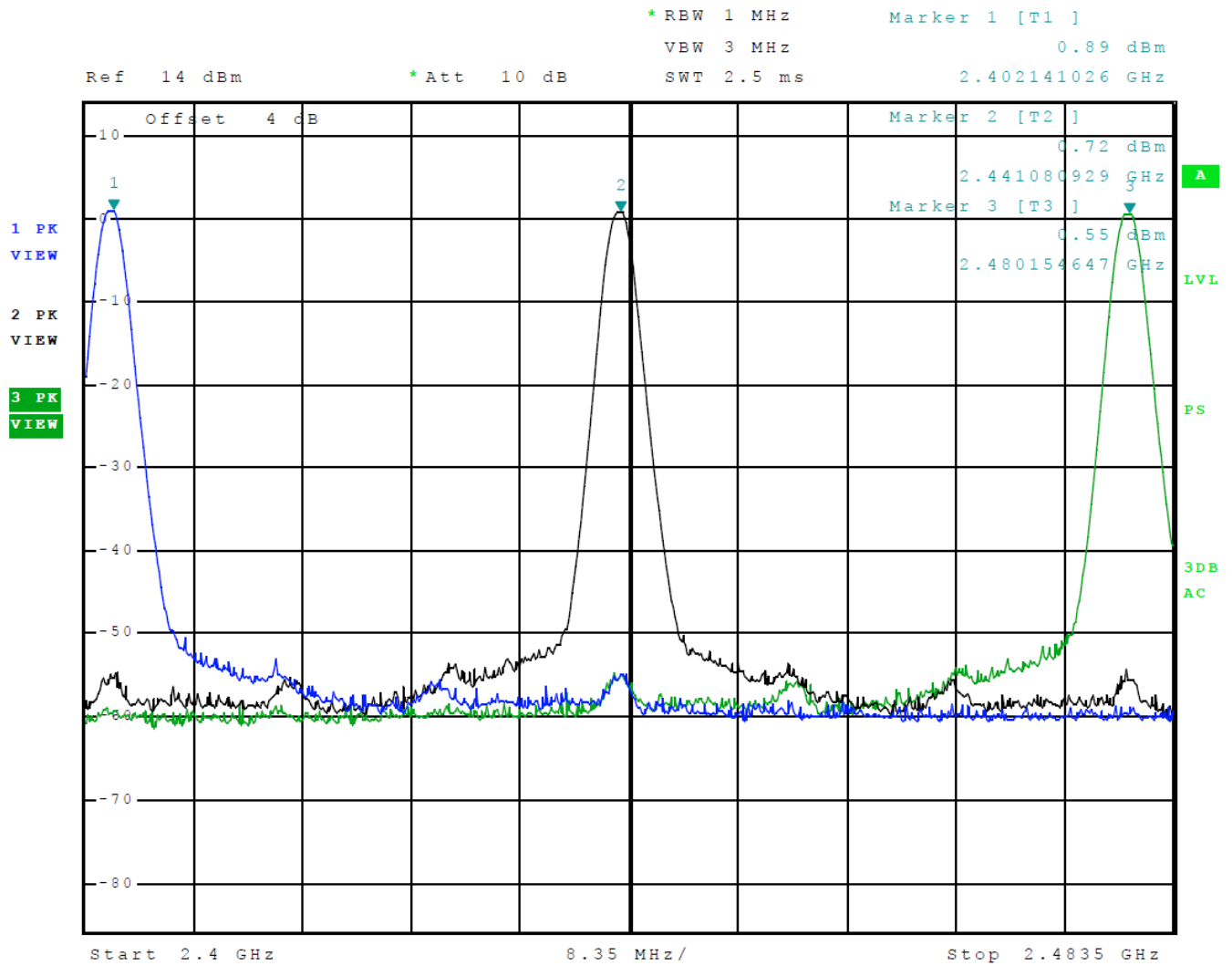




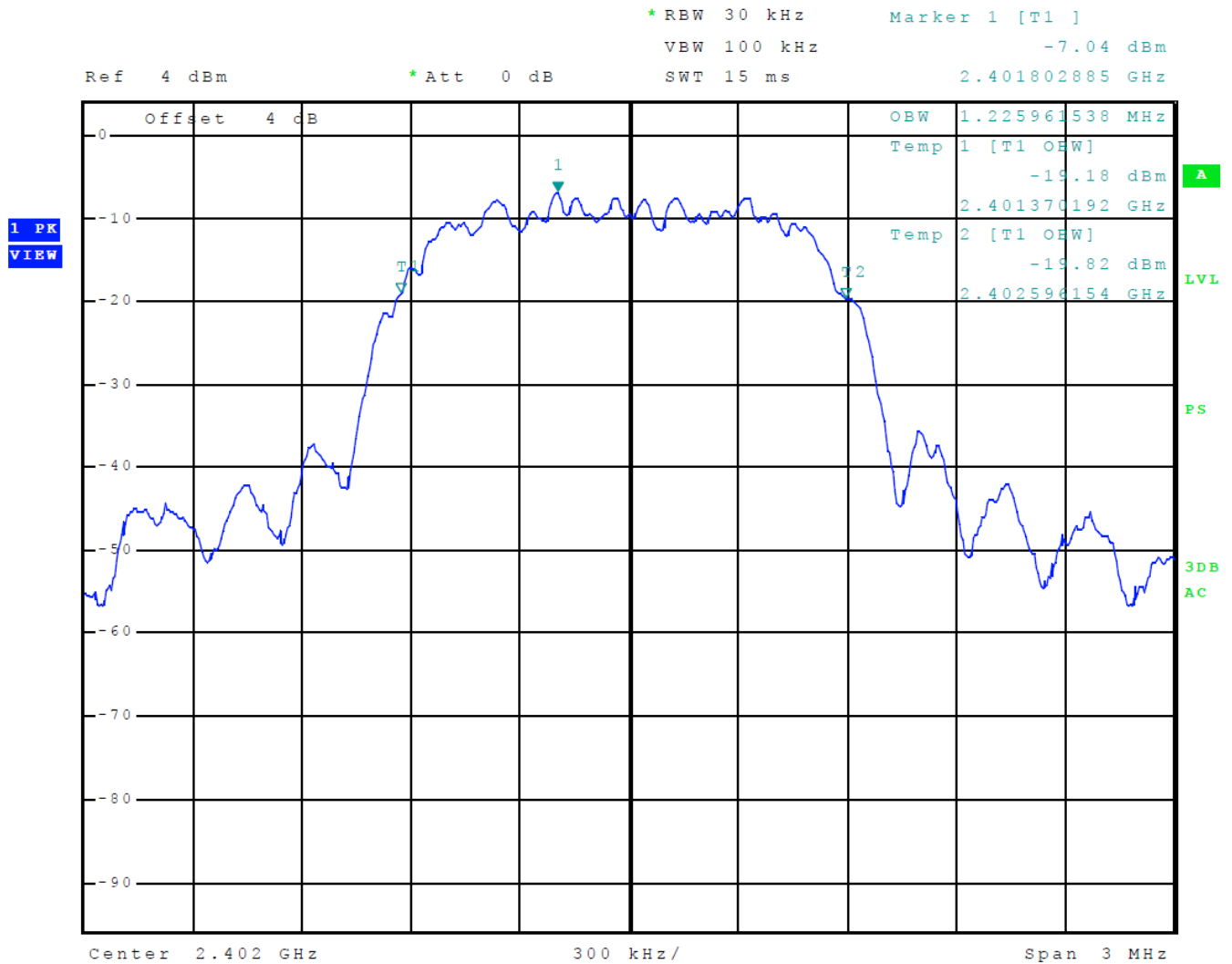
**Figure 11 Plot of Transmitter Emissions Low Band Edge Mode 2 BT BR (GFSK)**



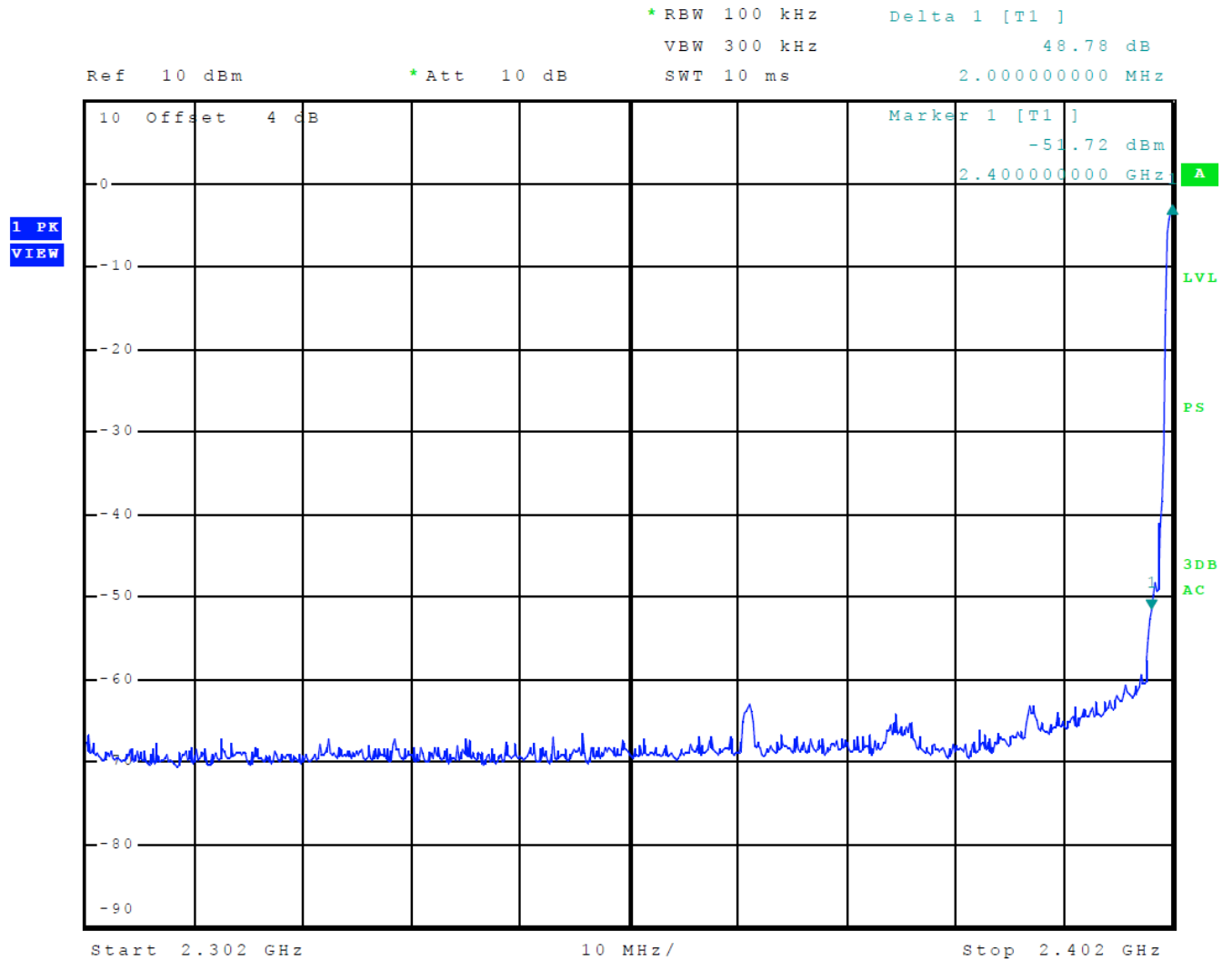
**Figure 12 Plot of Transmitter Emissions High Band Edge Mode 2 BT BR (GFSK)**



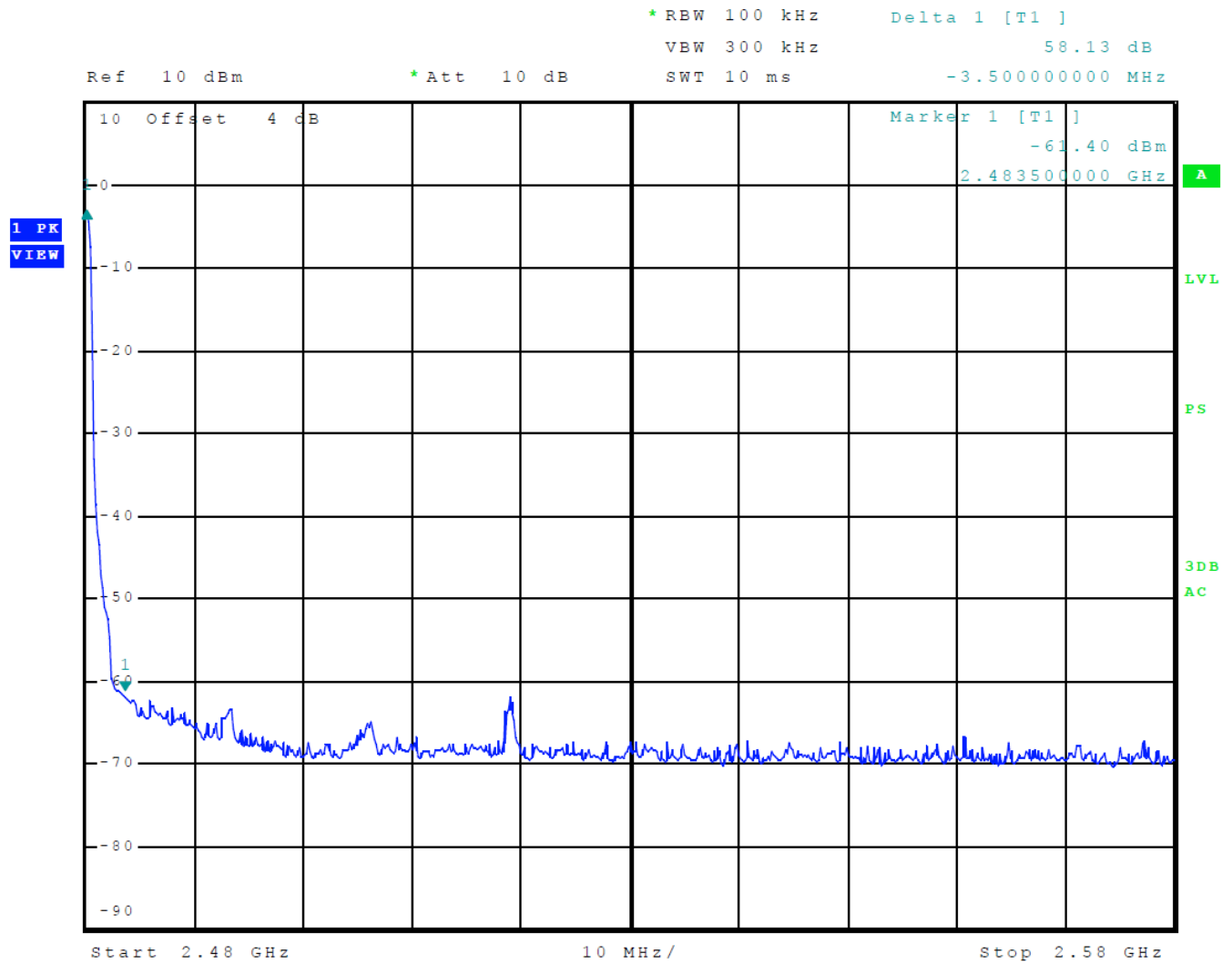
**Figure 13 Plot of Transmitter Emissions Operation in 2402-2480 MHz Mode 3 BT 2EDR ( $\pi/4$  DQPSK)**



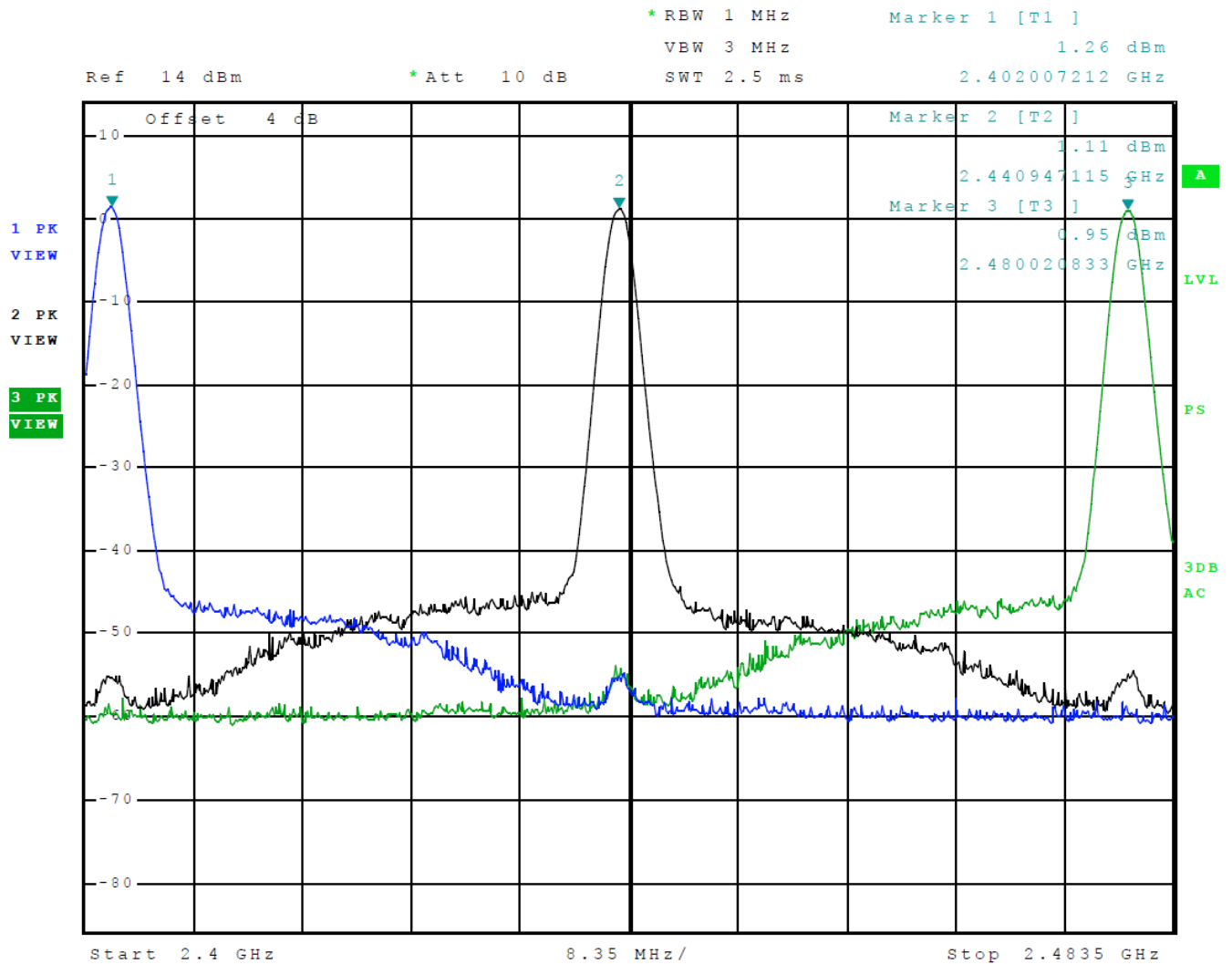
**Figure 14 Plot of Transmitter Emissions 99% Occupied Bandwidth Mode 3 BT 2EDR ( $\pi/4$  DQPSK)**



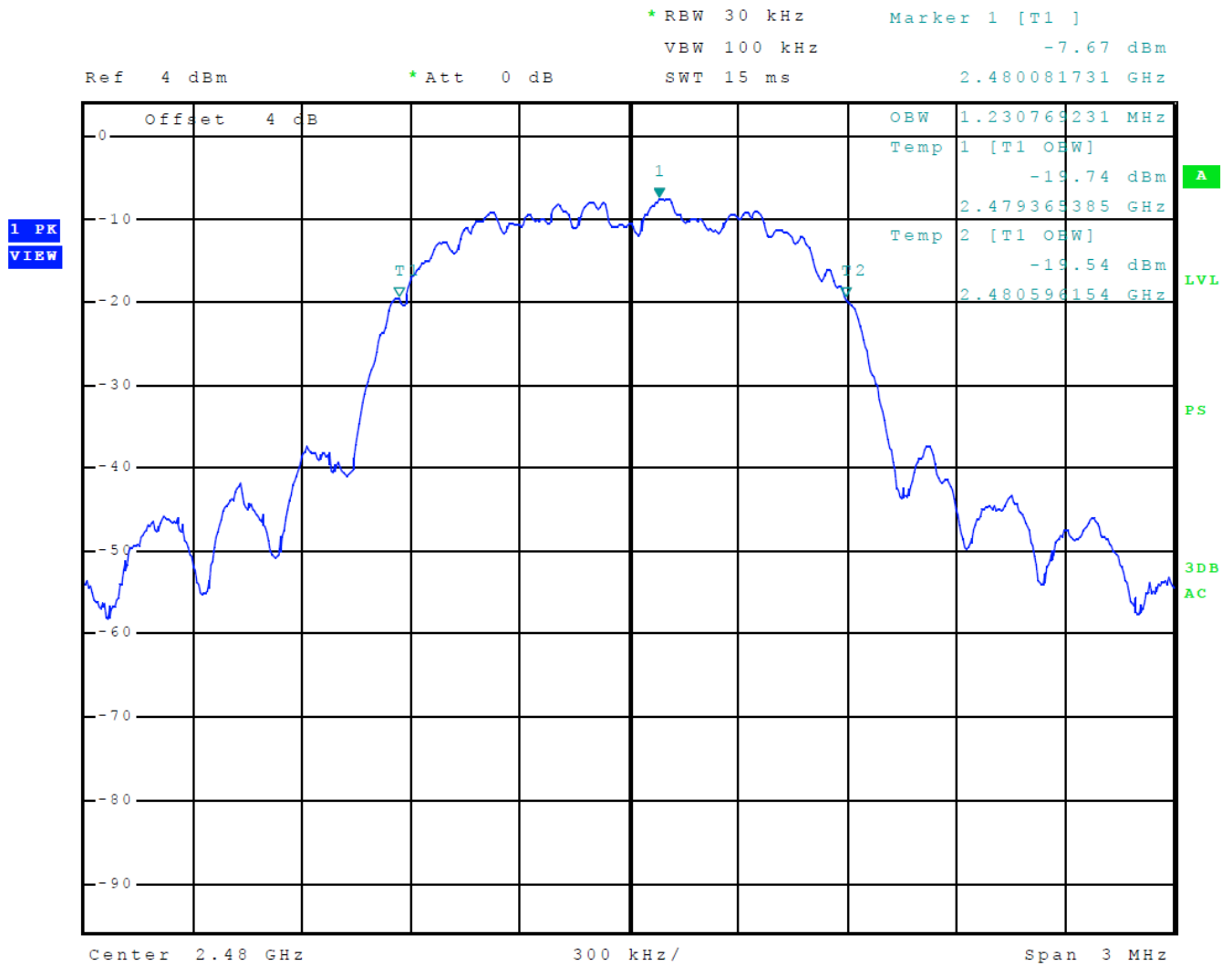
**Figure 15 Plot of Transmitter Emissions Low Band Edge Mode 3 BT 2EDR ( $\pi/4$  DQPSK)**



**Figure 16 Plot of Transmitter Emissions High Band Edge Mode 3 BT 2EDR ( $\pi/4$  DQPSK)**

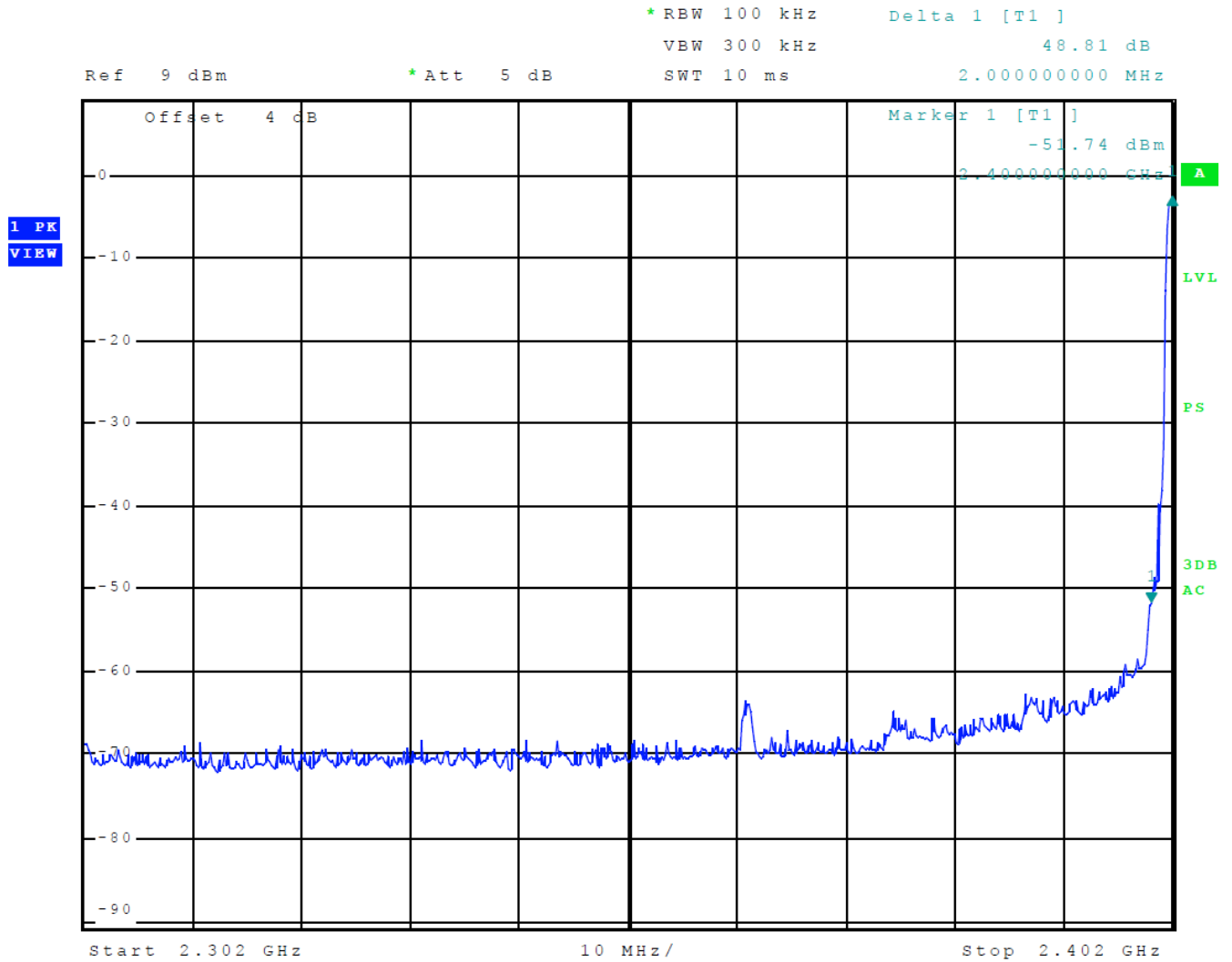


**Figure 17 Plot of Transmitter Emissions Operation in 2402-2480 MHz Mode 4 BT 3EDR (8DPSK)**

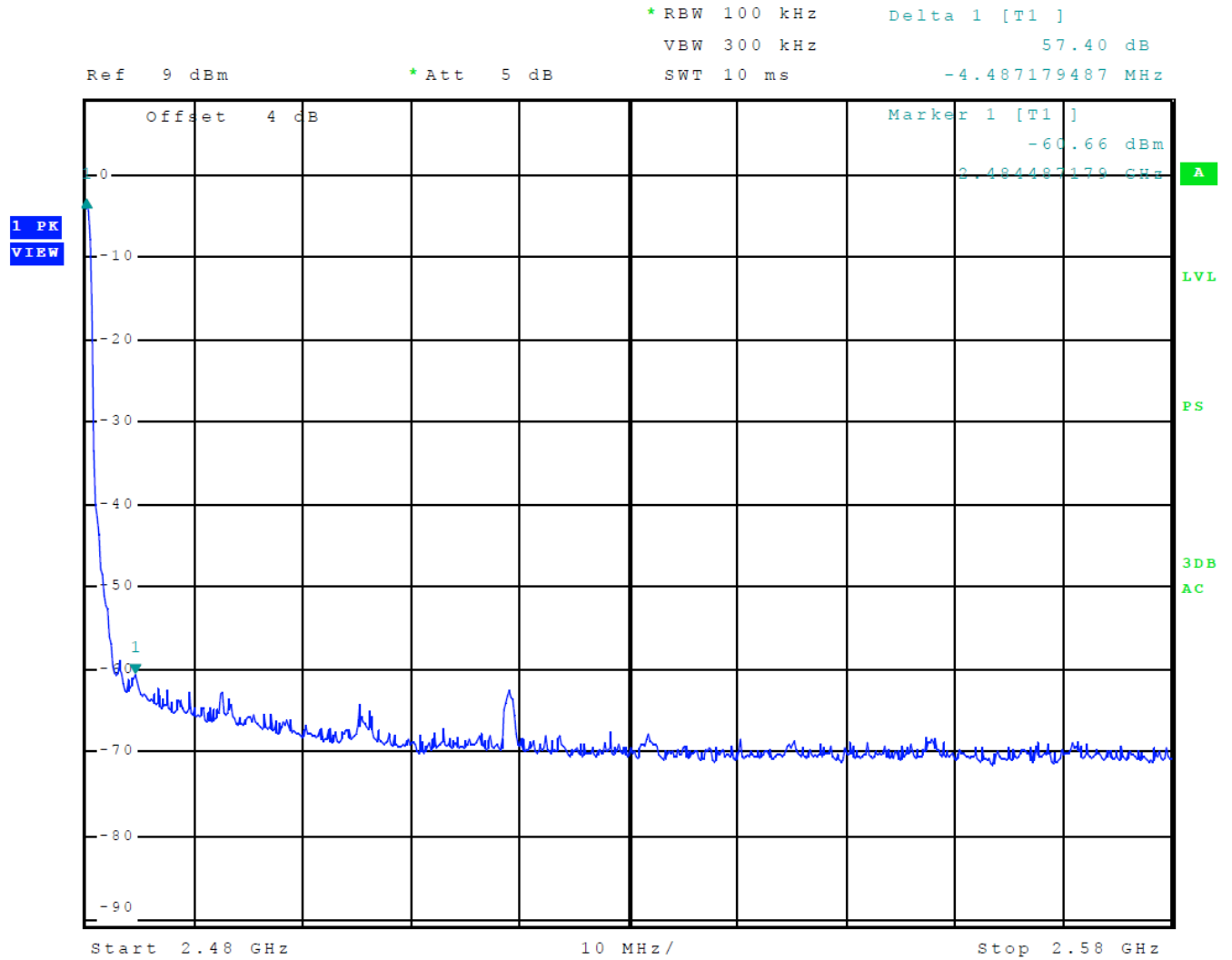


**Figure 18 Plot of Transmitter Emissions 99% Occupied Bandwidth Mode 4 BT 3EDR (8DPSK)**

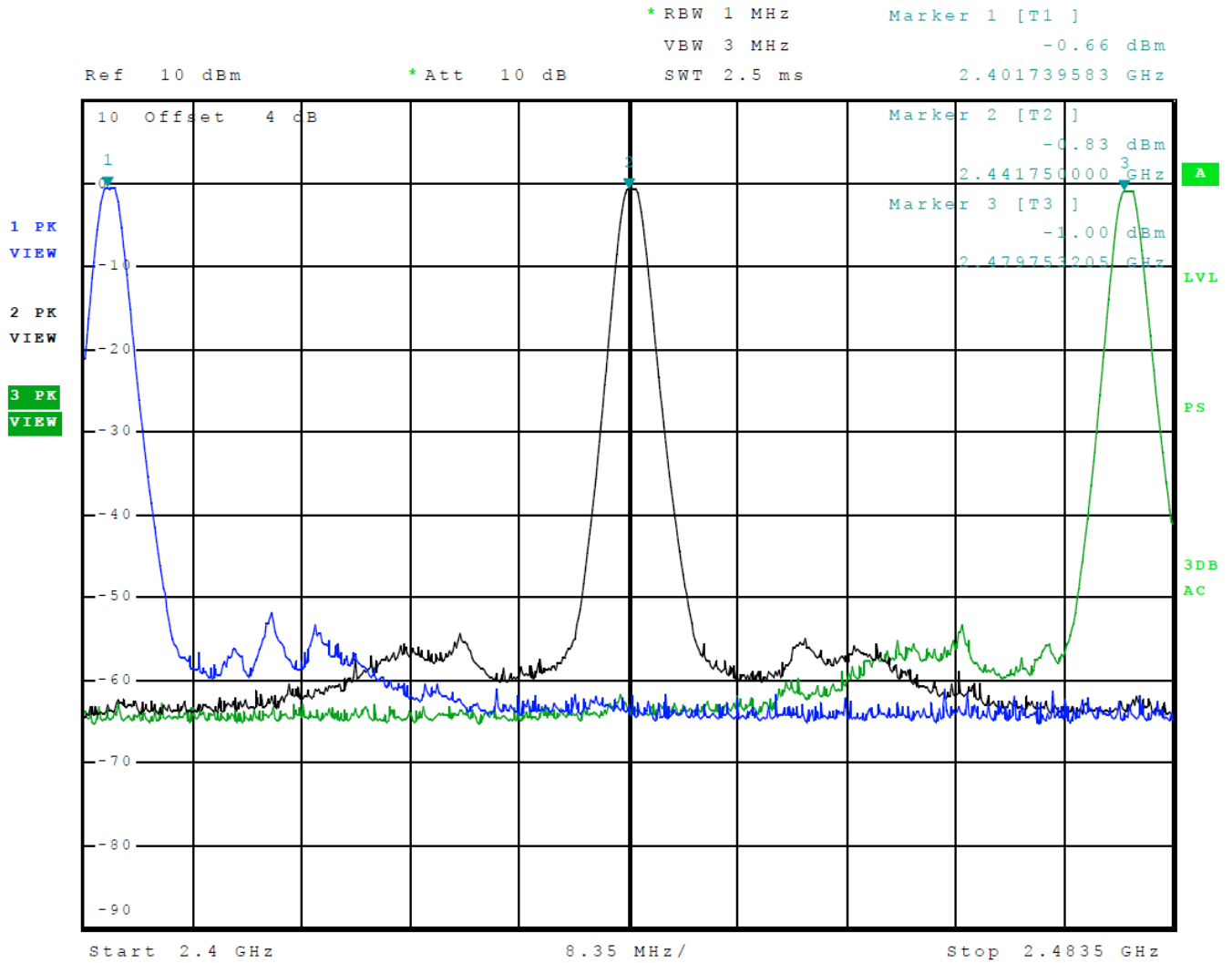




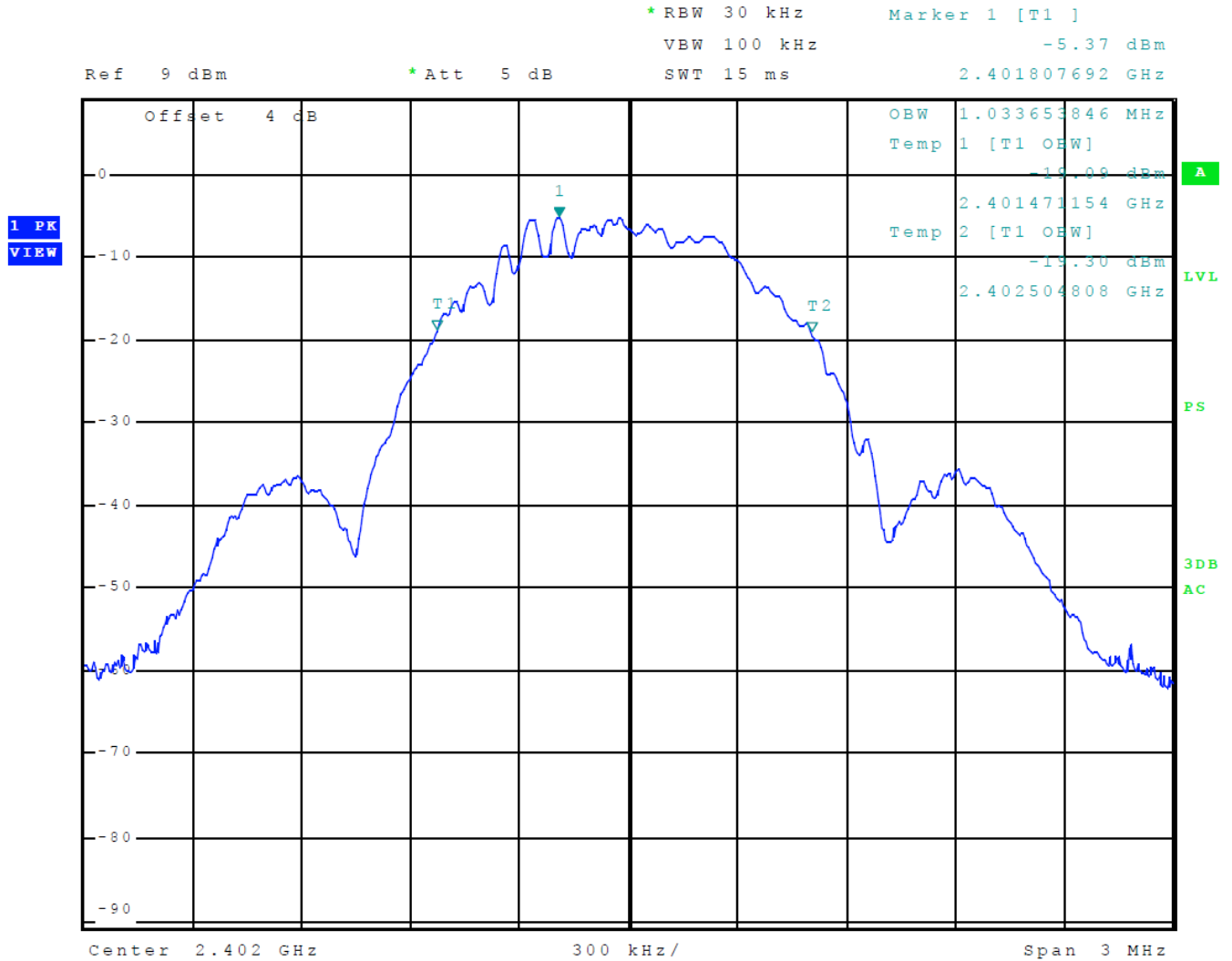
**Figure 19 Plot of Transmitter Emissions Low Band Edge Mode 4 BT 3EDR (8DPSK)**



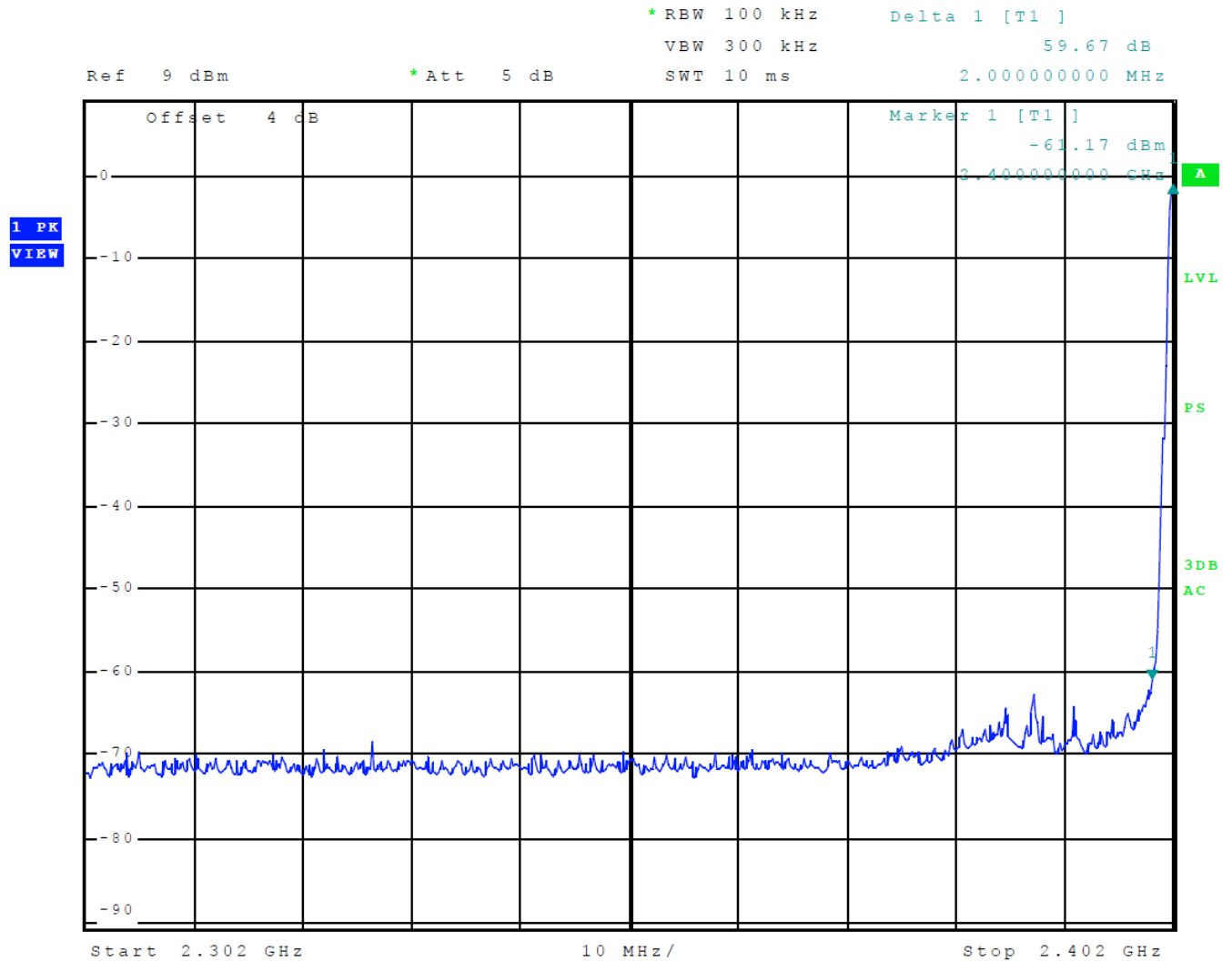
**Figure 20 Plot of Transmitter Emissions High Band Edge Mode 4 BT 3EDR (8DPSK)**



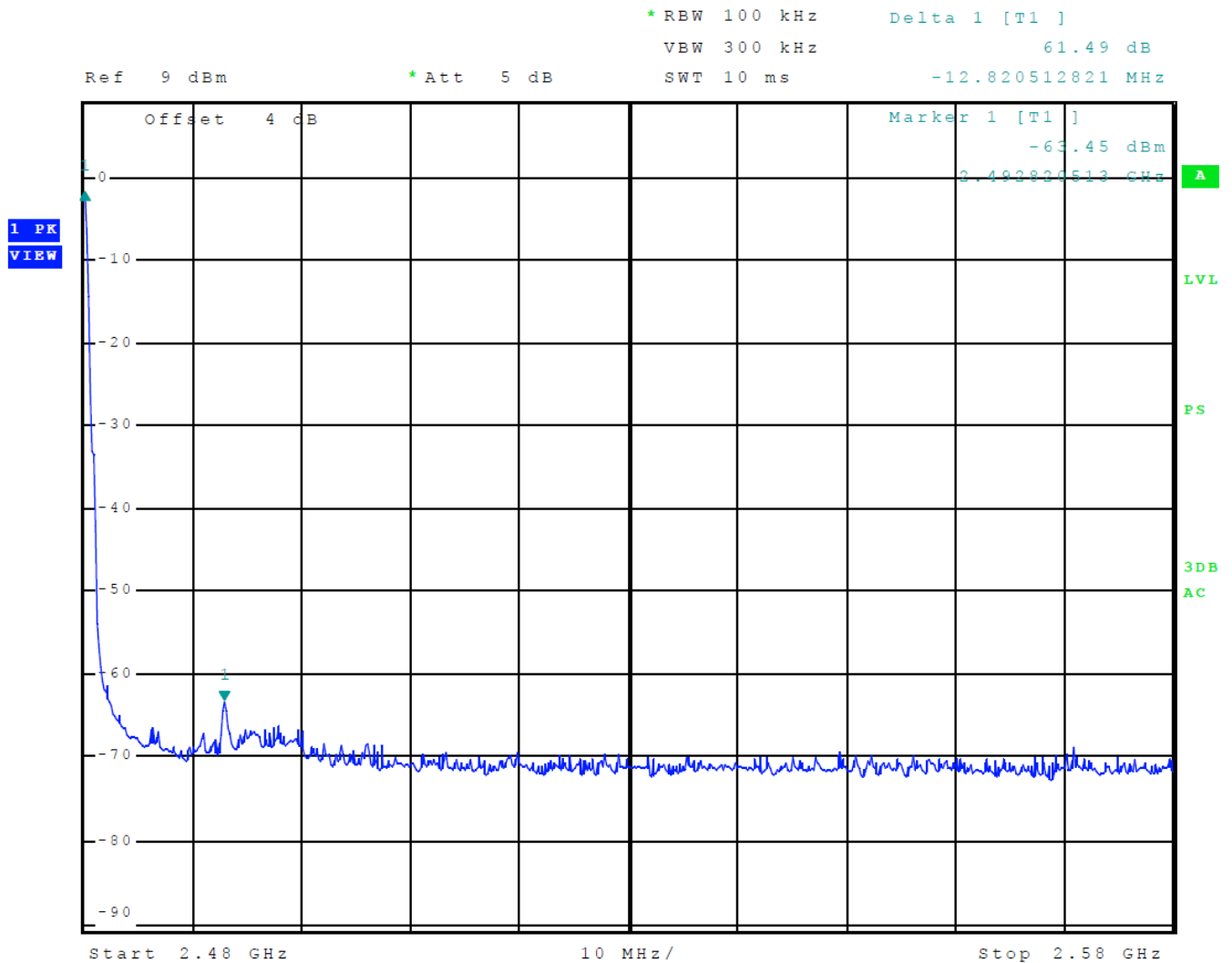
**Figure 21 Plot of Transmitter Emissions Operation in 2402-2480 MHz Mode 5 BT BLE (GMSK)**



**Figure 22 Plot of Transmitter Emissions 99% Occupied Bandwidth Mode 5 BT BLE (GMSK)**



**Figure 23 Plot of Transmitter Emissions Low Band Edge Mode 5 BT BLE (GMSK)**



**Figure 24 Plot of Transmitter Emissions High Band Edge Mode 5 BT BLE (GMSK)**

## Transmitter Emissions Data

**Table 11 Transmitter Radiated Emissions Mode 1 ANT (GFSK)**

Frequency in MHz	Horizontal Peak (dB $\mu$ V/m)	Horizontal Average (dB $\mu$ V/m)	Vertical Peak (dB $\mu$ V/m)	Vertical Average (dB $\mu$ V/m)	Limit @ 3m (dB $\mu$ V/m)	Horizontal Margin (dB)	Vertical Margin (dB)
2402.0	96.2	85.0	91.4	79.5	94.0	-9.0	-14.5
4804.0	49.1	36.3	50.1	36.9	54.0	-17.7	-17.1
7206.0	52.3	39.7	52.5	39.4	54.0	-14.3	-14.6
9608.0	55.7	42.1	54.0	41.1	54.0	-11.9	-12.9
12010.0	58.0	45.3	57.6	45.0	54.0	-8.7	-9.0
14412.0	60.3	47.8	60.0	47.4	54.0	-6.2	-6.6
16814.0	61.5	48.7	61.0	48.3	54.0	-5.3	-5.7
2441.0	93.8	82.6	89.2	78.1	94.0	-11.4	-15.9
4882.0	49.8	36.9	49.5	36.3	54.0	-17.1	-17.7
7323.0	52.2	39.6	52.8	39.9	54.0	-14.4	-14.1
9764.0	54.0	41.1	54.6	41.6	54.0	-12.9	-12.4
12205.0	57.6	45.1	58.8	45.7	54.0	-8.9	-8.3
14646.0	60.1	47.3	60.4	47.6	54.0	-6.7	-6.4
17087.0	61.1	48.5	61.6	48.8	54.0	-5.5	-5.2
2480.0	94.6	83.3	90.0	78.8	94.0	-10.7	-15.2
4960.0	49.1	35.9	49.7	36.6	54.0	-18.1	-17.4
7440.0	52.7	39.7	52.9	40.0	54.0	-14.3	-14.0
9920.0	53.9	40.7	54.4	41.2	54.0	-13.3	-12.8
12400.0	58.5	45.2	58.3	45.4	54.0	-8.8	-8.6
14880.0	60.3	47.5	61.0	47.8	54.0	-6.5	-6.2
17360.0	61.5	48.5	61.9	48.9	54.0	-5.5	-5.1

Other emissions present had amplitudes at least 20 dB below the limit. Peak and Quasi-Peak amplitude emissions are recorded for frequency range below 1000 MHz. Peak and Average amplitude emissions are recorded for frequency range above 1000 MHz.

**Table 12 Transmitter Radiated Emissions Mode 2 BT BR (GFSK)**

Frequency in MHz	Horizontal Peak (dBµV/m)	Horizontal Average (dBµV/m)	Vertical Peak (dBµV/m)	Vertical Average (dBµV/m)	Limit @ 3m (dBµV/m)	Horizontal Margin (dB)	Vertical Margin (dB)
2402.0	94.1	92.3	95.2	92.9	94.0	-1.7	-1.1
4804.0	49.6	36.3	49.6	36.4	54.0	-17.7	-17.6
7206.0	52.3	39.8	52.8	39.8	54.0	-14.2	-14.2
9608.0	55.9	42.4	54.4	42.0	54.0	-11.6	-12.0
12010.0	58.4	45.3	59.2	45.4	54.0	-8.7	-8.6
14412.0	60.4	47.9	61.1	47.9	54.0	-6.1	-6.1
16814.0	62.1	48.9	61.8	48.9	54.0	-5.1	-5.1
2441.0	97.3	90.8	98.8	92.3	94.0	-3.2	-1.7
4882.0	48.7	36.0	49.4	36.0	54.0	-18.0	-18.0
7323.0	52.4	39.8	53.7	40.2	54.0	-14.2	-13.8
9764.0	54.6	42.4	54.5	42.1	54.0	-11.6	-11.9
12205.0	58.3	45.6	58.9	45.9	54.0	-8.4	-8.1
14646.0	61.2	47.9	60.5	47.9	54.0	-6.1	-6.1
17087.0	62.6	49.1	62.5	49.3	54.0	-4.9	-4.7
2480.0	91.6	90.8	93.6	92.9	94.0	-3.2	-1.1
4960.0	48.9	36.1	49.0	36.2	54.0	-17.9	-17.8
7440.0	52.8	40.2	53.2	40.3	54.0	-13.8	-13.7
9920.0	54.0	41.4	54.5	41.7	54.0	-12.6	-12.3
12400.0	58.0	45.5	58.9	45.5	54.0	-8.5	-8.5
14880.0	60.6	47.8	60.1	48.0	54.0	-6.2	-6.0
17360.0	61.7	48.8	62.9	49.0	54.0	-5.2	-5.0

Other emissions present had amplitudes at least 20 dB below the limit. Peak and Quasi-Peak amplitude emissions are recorded for frequency range below 1000 MHz. Peak and Average amplitude emissions are recorded for frequency range above 1000 MHz.



**Table 13 Transmitter Radiated Emissions Mode 3 BT 2EDR ( $\pi/4$  DQPSK)**

Frequency in MHz	Horizontal Peak (dB $\mu$ V/m)	Horizontal Average (dB $\mu$ V/m)	Vertical Peak (dB $\mu$ V/m)	Vertical Average (dB $\mu$ V/m)	Limit @ 3m (dB $\mu$ V/m)	Horizontal Margin (dB)	Vertical Margin (dB)
2402.0	93.9	89.1	94.3	89.0	94.0	-4.9	-5.0
4804.0	48.9	36.3	49.1	36.3	54.0	-17.7	-17.7
7206.0	52.9	39.7	53.1	39.7	54.0	-14.3	-14.3
9608.0	54.8	42.0	55.2	41.9	54.0	-12.0	-12.1
12010.0	58.6	45.5	57.8	45.4	54.0	-8.5	-8.6
14412.0	60.7	47.9	60.8	47.8	54.0	-6.1	-6.2
16814.0	62.1	48.9	61.7	48.8	54.0	-5.1	-5.2
2441.0	94.5	88.2	97.8	88.0	94.0	-5.8	-6.0
4882.0	48.8	36.2	48.6	36.1	54.0	-17.8	-17.9
7323.0	53.2	40.3	53.0	40.4	54.0	-13.7	-13.6
9764.0	54.9	42.0	54.8	42.0	54.0	-12.0	-12.0
12205.0	59.5	46.0	59.0	45.9	54.0	-8.0	-8.1
14646.0	61.1	48.2	61.2	48.2	54.0	-5.8	-5.8
17087.0	61.8	49.4	62.1	49.4	54.0	-4.6	-4.6
2480.0	90.6	87.1	91.8	87.7	94.0	-6.9	-6.3
4960.0	49.6	36.3	49.5	36.1	54.0	-17.7	-17.9
7440.0	53.0	40.0	53.1	40.3	54.0	-14.0	-13.7
9920.0	54.9	41.5	55.1	41.7	54.0	-12.5	-12.3
12400.0	58.4	45.5	58.9	45.4	54.0	-8.5	-8.6
14880.0	60.7	47.8	60.5	47.9	54.0	-6.2	-6.1
17360.0	61.5	48.8	61.6	48.8	54.0	-5.2	-5.2

Other emissions present had amplitudes at least 20 dB below the limit. Peak and Quasi-Peak amplitude emissions are recorded for frequency range below 1000 MHz. Peak and Average amplitude emissions are recorded for frequency range above 1000 MHz.

**Table 14 Transmitter Radiated Emissions Mode 4 BT 3EDR (8DPSK)**

Frequency in MHz	Horizontal Peak (dBμV/m)	Horizontal Average (dBμV/m)	Vertical Peak (dBμV/m)	Vertical Average (dBμV/m)	Limit @ 3m (dBμV/m)	Horizontal Margin (dB)	Vertical Margin (dB)
2402.0	94.1	89.4	93.5	88.4	94.0	-4.6	-5.6
4804.0	49.4	36.2	48.5	36.3	54.0	-17.8	-17.7
7206.0	52.3	39.7	53.0	39.8	54.0	-14.3	-14.2
9608.0	54.2	41.8	55.6	41.9	54.0	-12.2	-12.1
12010.0	58.3	45.3	58.3	45.3	54.0	-8.7	-8.7
14412.0	61.1	47.8	61.1	47.8	54.0	-6.2	-6.2
16814.0	61.5	48.7	61.5	48.7	54.0	-5.3	-5.3
2441.0	95.7	87.9	97.8	87.8	94.0	-6.1	-6.2
4882.0	48.9	35.8	48.8	35.9	54.0	-18.2	-18.1
7323.0	53.1	40.0	53.3	40.2	54.0	-14.0	-13.8
9764.0	55.2	41.8	54.6	41.9	54.0	-12.2	-12.1
12205.0	58.3	45.6	58.7	45.8	54.0	-8.4	-8.2
14646.0	61.0	47.8	61.1	47.8	54.0	-6.2	-6.2
17087.0	61.6	49.0	61.9	49.0	54.0	-5.0	-5.0
2480.0	90.8	86.6	92.5	88.3	94.0	-7.4	-5.7
4960.0	48.6	36.1	49.3	36.1	54.0	-17.9	-17.9
7440.0	53.3	40.0	53.1	40.3	54.0	-14.0	-13.7
9920.0	54.2	41.7	54.6	41.5	54.0	-12.3	-12.5
12400.0	58.8	45.6	58.3	45.6	54.0	-8.4	-8.4
14880.0	61.3	47.8	60.3	47.8	54.0	-6.2	-6.2
17360.0	62.2	48.8	61.8	48.7	54.0	-5.2	-5.3

Other emissions present had amplitudes at least 20 dB below the limit. Peak and Quasi-Peak amplitude emissions are recorded for frequency range below 1000 MHz. Peak and Average amplitude emissions are recorded for frequency range above 1000 MHz.

**Table 15 Transmitter Radiated Emissions Mode 5 BT BLE (GMSK)**

Frequency in MHz	Horizontal Peak (dBμV/m)	Horizontal Average (dBμV/m)	Vertical Peak (dBμV/m)	Vertical Average (dBμV/m)	Limit @ 3m (dBμV/m)	Horizontal Margin (dB)	Vertical Margin (dB)
2402.0	93.3	91.3	93.5	90.7	94.0	-2.7	-3.3
4804.0	48.9	36.2	49.3	36.2	54.0	-17.8	-17.8
7206.0	52.4	39.7	53.2	39.7	54.0	-14.3	-14.3
9608.0	54.1	41.6	55.0	41.8	54.0	-12.4	-12.2
12010.0	58.3	45.3	57.9	45.3	54.0	-8.7	-8.7
14412.0	61.6	47.4	61.4	47.8	54.0	-6.6	-6.2
16814.0	61.4	48.7	62.0	48.7	54.0	-5.3	-5.3
2442.0	92.9	90.1	93.8	89.5	94.0	-3.9	-4.5
4884.0	49.0	35.9	48.5	35.9	54.0	-18.1	-18.1
7326.0	53.2	40.0	53.8	40.2	54.0	-14.0	-13.8
9768.0	54.1	41.6	54.7	41.7	54.0	-12.4	-12.3
12210.0	58.2	45.6	58.1	45.6	54.0	-8.4	-8.4
14652.0	61.1	47.7	60.9	47.8	54.0	-6.3	-6.2
17094.0	61.9	48.8	61.6	49.0	54.0	-5.2	-5.0
2480.0	90.0	89.0	91.2	89.8	94.0	-5.0	-4.2
4960.0	49.8	36.0	48.4	36.1	54.0	-18.0	-17.9
7440.0	53.0	40.0	53.4	40.4	54.0	-14.0	-13.6
9920.0	54.1	41.3	54.2	41.2	54.0	-12.7	-12.8
12400.0	57.7	45.4	58.6	45.7	54.0	-8.6	-8.3
14880.0	61.1	47.8	60.5	47.8	54.0	-6.2	-6.2
17360.0	62.1	48.7	61.9	48.7	54.0	-5.3	-5.3

Other emissions present had amplitudes at least 20 dB below the limit. Peak and Quasi-Peak amplitude emissions are recorded for frequency range below 1000 MHz. Peak and Average amplitude emissions are recorded for frequency range above 1000 MHz.

## ***Summary of Results for Transmitter Radiated Emissions of Intentional Radiator***

The EUT demonstrated compliance with the radiated emissions requirements of FCC 47 CFR Part 15.249, Industry Canada RSS-210 Issue 10 and RSS-GEN Issue 5 Intentional Radiator regulations. The EUT worst-case test sample configuration demonstrated minimum average margin of -1.1 dB below the average emission limit for the fundamental. The EUT worst-case configuration demonstrated minimum radiated harmonic emission margin of -4.6 dB below the limit. No other radiated emissions were found in the restricted bands less than 20 dB below limits than those recorded in this report. Other emissions were present with amplitudes at least 20 dB below the limits.

## Annex

- Annex A Measurement Uncertainty Calculations
- Annex B Additional Test Equipment List
- Annex C Rogers Qualifications
- Annex D Rogers Labs Certificate of Accreditation

## Annex A Measurement Uncertainty Calculations

The measurement uncertainty was calculated for all measurements listed in this test report according to CISPR 16-4. Result of measurement uncertainty calculations are recorded below. Component and process variability of production devices similar to those tested may result in additional deviations. The manufacturer has the sole responsibility of continued compliance.

Measurement	Expanded Measurement Uncertainty $U_{(lab)}$
3 Meter Horizontal 0.009-1000 MHz Measurements	4.16
3 Meter Vertical 0.009-1000 MHz Measurements	4.33
3 Meter Measurements 1-18 GHz	5.14
3 Meter Measurements 18-40 GHz	5.16
10 Meter Horizontal Measurements 0.009-1000 MHz	4.15
10 Meter Vertical Measurements 0.009-1000 MHz	4.32
AC Line Conducted	1.75
Antenna Port Conducted power	1.17
Frequency Stability	1.00E-11
Temperature	1.6°C
Humidity	3%

## **Annex B Additional Test Equipment**

List of Test Equipment	Calibration	Date (m/d/y)	Due
<input type="checkbox"/> Frequency Counter: Leader LDC-825 (8060153)		4/18/2019	4/18/2021
<input type="checkbox"/> LISN: Fischer Custom Communications Model: FCC-LISN-50-16-2-08		4/18/2019	4/18/2020
<input type="checkbox"/> Cable Huber & Suhner Inc. Sucoflex102ea(1.5M)(303070) 9kHz-40 GHz		10/14/2019	10/14/2020
<input type="checkbox"/> Cable Huber & Suhner Inc. Sucoflex102ea(1.5M)(303072) 9kHz-40 GHz		10/14/2019	10/14/2020
<input type="checkbox"/> Cable Huber & Suhner Inc. Sucoflex102ea(L4M)(281184) 9kHz-40 GHz		10/14/2019	10/14/2020
<input type="checkbox"/> Cable Huber & Suhner Inc. Sucoflex102ea(L10M)(317546)9kHz-40 GHz		10/14/2019	10/14/2020
<input type="checkbox"/> Cable Time Microwave 4M-750HF290-750 (4M) 9kHz-24 GHz		10/14/2019	10/14/2020
<input type="checkbox"/> RF Filter Micro-Tronics BRC17663 (001) 9.3-9.5 notch 30-1800 MHz		4/18/2019	4/18/2020
<input type="checkbox"/> RF Filter Micro-Tronics BRC19565 (001) 9.2-9.6 notch 30-1800 MHz		10/16/2018	4/18/2020
<input type="checkbox"/> Attenuator Mini-Circuits VAT-3W2+ (1735) 30-6000 MHz		4/18/2019	4/18/2020
<input type="checkbox"/> Analyzer HP 8562A (3051A05950) 9kHz-125GHz		4/18/2019	4/18/2020
<input type="checkbox"/> Analyzer HP External Mixers11571, 11970 25GHz-110GHz		4/18/2015	4/18/2025
<input type="checkbox"/> Analyzer HP 8591EM (3628A00871)		5/2/2018	5/2/2020
<input type="checkbox"/> CDN Com-Power M325E		10/14/2019	10/14/2020
<input type="checkbox"/> Antenna: Solar 9229-1 & 9230-1		2/22/2019	2/22/2020
<input type="checkbox"/> R.F. Generator: SMB100A6 s/n 100623		4/18/2019	4/18/2020
<input type="checkbox"/> R.F. Generator: SBMBV100A s/n: 260771		4/18/2019	4/18/2020
<input type="checkbox"/> R.F. Power Amp ACS 230-50W		2/22/2019	2/22/2020
<input type="checkbox"/> R.F. Power Amp EIN Model: A301		2/22/2019	2/22/2020
<input type="checkbox"/> R.F. Power Amp A.R. Model: 10W 1010M7		2/22/2019	2/22/2020
<input type="checkbox"/> LISN: Com-Power Model LI-550C		10/14/2019	10/14/2020
<input type="checkbox"/> LISN: Compliance Eng. Model 240/20		4/18/2019	4/18/2020
<input type="checkbox"/> LISN: Fischer Custom Communications Model: FCC-LISN-50-16-2-08		4/18/2019	4/18/2020
<input type="checkbox"/> Oscilloscope Scope: Tektronix MDO 4104		2/22/2019	2/22/2020
<input type="checkbox"/> EMC Transient Generator HVT TR 3000		2/22/2019	2/22/2020
<input type="checkbox"/> AC Power Source (Ametech, California Instruments)		2/22/2019	2/22/2020
<input type="checkbox"/> Field Intensity Meter: EFM-018		2/22/2019	2/22/2020
<input type="checkbox"/> ESD Simulator: MZ-15		2/22/2019	2/22/2020
<input checked="" type="checkbox"/> Shielded Room		Calibration Not required	

## **Annex C Rogers Qualifications**

***Scot D. Rogers, Engineer***

### **Rogers Labs, Inc.**

Mr. Rogers has approximately 32 years' experience in the field of electronics. Work experience includes working in the automated controls industry, design, development and testing of radio communications and electronic equipment.

#### Positions Held:

Systems Engineer: A/C Controls Mfg. Co., Inc. 6 Years

Electrical Engineer: Rogers Consulting Labs, Inc. 5 Years

Electrical Engineer: Rogers Labs, Inc. Current

#### Educational Background:

- 1) Bachelor of Science Degree in Electrical Engineering from Kansas State University
- 2) Bachelor of Science Degree in Business Administration Kansas State University
- 3) Several Specialized Training courses and seminars pertaining to Microprocessors and Software programming.



**Annex D Laboratory Certificate of Accreditation**

United States Department of Commerce  
National Institute of Standards and Technology



---

**Certificate of Accreditation to ISO/IEC 17025:2017**

---

NVLAP LAB CODE: 200087-0

**Rogers Labs, Inc.**  
Louisburg, KS

*is accredited by the National Voluntary Laboratory Accreditation Program for specific services,  
listed on the Scope of Accreditation, for:*

**Electromagnetic Compatibility & Telecommunications**

*This laboratory is accredited in accordance with the recognized International Standard ISO/IEC 17025:2017.  
This accreditation demonstrates technical competence for a defined scope and the operation of a laboratory quality  
management system (refer to joint ISO-ILAC-IAF Communique dated January 2009).*

---

2019-11-07 through 2020-03-31  
Effective Dates



---

*[Signature]*  
For the National Voluntary Laboratory Accreditation Program

Rogers Labs, Inc.  
4405 West 259<sup>th</sup> Terrace  
Louisburg, KS 66053  
Phone/Fax: (913) 837-3214  
Revision 1

Garmin International, Inc.  
Model: A03847  
Test: 191125  
Test to: CFR47 15.249, RSS-210, RSS-Gen  
File: A03847 DXX TstRpt 191125

SN: 3315409516 / 3315409596  
FCC ID: IPH-03847  
IC: 1792A-03847  
Date: February 12, 2020  
Page 65 of 65