

Application For Grant of Certification

FOR

Model: A03608
2402-2480 MHz (DTS)
Broadband Digital Transmission System
FCC ID: IPH-03608
IC: 1792A-03608

FOR

Garmin International, Inc.

1200 East 151st Street
Olathe, KS 66062

FCC Designation: US5305
IC Test Site Registration: 3041A-1

Test Report Number: 180905

Authorized Signatory: *Scot D. Rogers*
Scot D. Rogers

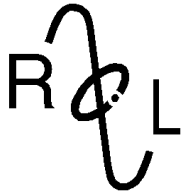

ROGERS LABS, INC.

4405 West 259th Terrace
Louisburg, KS 66053
Phone / Fax (913) 837-3214

Engineering Test Report For Grant of Certification Application

FOR
47 CFR, PART 15C - Intentional Radiators
47 CFR Paragraph 15.247 and
Industry Canada RSS-GEN and RSS-247
License Exempt Intentional Radiator

For
Garmin International, Inc.

1200 East 151st Street
Olathe, KS 66062

Digital Transmission System
Model: A03608

Frequency Range 2402-2480 MHz
FCC ID: IPH-03608
IC: 1792A-03608

Test Date: September 5, 2018

Certifying Engineer: *Scot D. Rogers*
Scot D. Rogers
Rogers Labs, Inc.
4405 West 259th Terrace
Louisburg, KS 66053
Telephone/Facsimile: (913) 837-3214

This report shall not be reproduced except in full, without the written approval of the laboratory.
This report must not be used by the client to claim product certification, approval, or
endorsement by NVLAP, NIST, or any agency of the Federal Government.

Rogers Labs, Inc.
4405 W. 259th Terrace
Louisburg, KS 66053
Phone/Fax: (913) 837-3214
Revision 1

Garmin International, Inc.
Model: A03608
Test #: 180905
Test to: CFR47 15C, RSS-Gen RSS-247
File: A03608 DTS TstRpt 180905

SN's: 39771 86171 / 39771 86163
FCC ID: IPH-03608
IC: 1792A-03608
Date: October 29, 2018
Page 2 of 51

Table of Contents

TABLE OF CONTENTS.....	3
REVISIONS.....	5
FOREWORD.....	6
OPINION / INTERPRETATION OF RESULTS	6
EQUIPMENT TESTED.....	7
Equipment Function	8
Equipment Configuration.....	9
APPLICATION FOR CERTIFICATION.....	10
APPLICABLE STANDARDS & TEST PROCEDURES	11
TESTING PROCEDURES	11
AC Line Conducted Emission Test Procedure	11
Radiated Emission Test Procedure.....	11
Antenna Port Conducted Emission Test Procedure.....	11
Diagram 1 Test arrangement for radiated emissions of tabletop equipment.....	12
Diagram 2 Test arrangement for radiated emissions tested on Open Area Test Site (OATS).....	13
Diagram 3 Test arrangement for Antenna Port Conducted emissions	14
TEST SITE LOCATIONS	14
LIST OF TEST EQUIPMENT.....	15
UNITS OF MEASUREMENTS	16
ENVIRONMENTAL CONDITIONS.....	16
STATEMENT OF MODIFICATIONS AND DEVIATIONS	16
INTENTIONAL RADIATORS.....	16

Antenna Requirements16

Restricted Bands of Operation.....17

Table 1 Radiated Emissions in Restricted Frequency Bands Data (GFSK)17

Table 2 Radiated Emissions in Restricted Frequency Bands Data (GMSK)18

Table 3 Harmonic Radiated Emissions in Restricted Bands Data (802.11b, Worst-case).....19

Table 4 Harmonic Radiated Emissions in Restricted Bands Data (802.11g, Worst-case).....20

Table 5 Harmonic Radiated Emissions in Restricted Bands Data (802.11n, Worst-case).....21

Summary of Results for Radiated Emissions in Restricted Bands21

General Radiated Emissions Procedure.....22

Table 6 General Radiated Emissions Data23

Summary of Results for General Radiated Emissions23

Operation in the Band 2400 – 2483.5 MHz24

Figure 1 Plot of Transmitter Emissions Operation in 2402-2480 MHz (GFSK)25

Figure 2 Plot of Transmitter Emissions Operation in 2402-2480 MHz (GMSK).....25

Figure 3 Plot of Transmitter Emissions in Operational Frequency (802.11 b-Mode)26

Figure 4 Plot of Transmitter Emissions in Operational Frequency (802.11 g-Mode)26

Figure 5 Plot of Transmitter Emissions in Operational Frequency (802.11 n-Mode)27

Figure 6 Plot of Transmitter Emissions Low Band Edge (GFSK).....27

Figure 7 Plot of Transmitter Emissions Low Band Edge (GMSK)28

Figure 8 Plot of Lower Band Edge (802.11 b-mode)28

Figure 9 Plot of Lower Band Edge (802.11 g-mode)29

Figure 10 Plot of Lower Band Edge (802.11 n-mode)29

Figure 11 Plot of Transmitter Emissions High Band Edge (GFSK).....30

Figure 12 Plot of Transmitter Emissions High Band Edge (GMSK).....30

Figure 13 Plot of Upper Band Edge (802.11 b-mode).....31

Figure 14 Plot of Upper Band Edge (802.11 g-mode).....31

Figure 15 Plot of Upper Band Edge (802.11 n-mode).....32

Figure 16 Plot of Transmitter Emissions 6-dB Occupied Bandwidth (GFSK).....32

Figure 17 Plot of Transmitter Emissions 99% Occupied Bandwidth (GFSK)33

Figure 18 Plot of Transmitter Emissions 6-dB Occupied Bandwidth (GMSK)33

Figure 19 Plot of Transmitter Emissions 99% Occupied Bandwidth (GMSK)34

Figure 20 Plot of Transmitter 6-dB Occupied Bandwidth (802.11 b-mode).....34

Figure 21 Plot of Transmitter 99% Occupied Bandwidth (802.11 b-mode).....35

Figure 22 Plot of Transmitter 6-dB Occupied Bandwidth (802.11 g-mode).....35

Figure 23 Plot of Transmitter 99% Occupied Bandwidth (802.11 g-mode).....	36
Figure 24 Plot of Transmitter 6-dB Occupied Bandwidth (802.11 n-mode).....	36
Figure 25 Plot of Transmitter 99% Occupied Bandwidth (802.11 n-mode).....	37
Figure 26 Plot of Transmitter Power Spectral Density (GFSK).....	37
Figure 27 Plot of Transmitter Power Spectral Density (GMSK).....	38
Figure 28 Plot of Transmitter Power Spectral Density (802.11 b-mode).....	38
Figure 29 Plot of Transmitter Power Spectral Density (802.11 g-mode).....	39
Figure 30 Plot of Transmitter Power Spectral Density (802.11 n-mode).....	39
Transmitter Emissions Data.....	40
Table 7 Transmitter Radiated Emissions (GFSK).....	40
Table 8 Transmitter Radiated Emissions (GMSK).....	41
Table 9 Transmitter Radiated Emission Worst-case Data 802.11b.....	42
Table 10 Transmitter Radiated Emission Worst-case Data 802.11g.....	43
Table 11 Transmitter Radiated Emission Worst-case Data 802.11n.....	44
Table 12 Transmitter Antenna Port Data.....	45
Summary of Results for Transmitter Radiated Emissions of Intentional Radiator.....	46
ANNEX.....	47
Annex A Measurement Uncertainty Calculations.....	48
Annex B Additional Test Equipment List.....	49
Annex C Rogers Qualifications.....	50
Annex D Rogers Labs Certificate of Accreditation.....	51

Revisions

Revision 1 Issued October 29, 2018

Foreword

The following information is submitted for consideration in obtaining Grant of Certification for License Exempt Digital Transmission System Intentional Radiator operating under Code of Federal Regulations Title 47 (47 CFR) Paragraph 15.247 and Industry Canada RSS-GEN, Issue 5 and RSS-247 Issue 2, operation in the 2400 – 2483.5 MHz band.

Name of Applicant: Garmin International, Inc.
1200 East 151st Street
Olathe, KS 66062

M/N: A03608

FCC ID: IPH-03608 Industry Canada ID: 1792A-03608

Frequency Range: 2402-2480 MHz

Power and OBW:

GFSK and GMSK mode 1

GFSK output power Peak 0.001 W, (99% Occupied 894.2 kHz)

GMSK output power Peak 0.002 W, (99% Occupied 1057.7 kHz)

802.11b/g/n (Wi-Fi) mode 2

802.11b output power Peak 0.044 W, Average 0.026, (99% Occupied 14,712 kHz)

802.11g output power Peak 0.044 W, Average 0.026, (99% Occupied 17,403 kHz)

802.11n output power Peak 0.044 W, Average 0.022, (99% Occupied 18,365 kHz)

Opinion / Interpretation of Results

Tests Performed	Margin (dB)	Results
Emissions 15.205, RSS-GEN	-0.4	Complies
Emissions as per 47 CFR paragraphs 2 and 15.207	N/A	Complies
Emissions as per 47 CFR paragraphs 2 and 15.209	-0.9	Complies
Harmonic Emissions per 47 CFR 15.247	-0.4	Complies
Power Spectral Density per 47 CFR 15.247	-2.3	Complies

Equipment Tested

<u>Equipment</u>	<u>Model / PN</u>	<u>Serial Number</u>
EUT	A03608	39771 86171
EUT#2	A03608	39771 86163
Remote Interface	GRID 011-02810	326004542
Remote Interface	GRID 011-02810	326002808
Remote Interface	GRID 011-02810	326004544
Remote Interface	GRID 011-02810	38613 18243
Interface cables	Manufacturer provided	N/A
DC Power Supply	BK 1745A	209C13

Test results in this report relate only to the items tested

Equipment Function

The EUT is a marine mounted GPS enabled device for use in the maritime environment. The design incorporates interface ports for use with wired devices as well as transmitters providing operation capability across the 2402-2480 MHz frequency band. This design provides communications operation in two modes across the 2402-2480 MHz band. The unit provides transmitter function across the 2402-2480 MHz band in mode 1 utilizing GFSK and GMSK modulations. The design also provides transmitter function across the 2412-2462 MHz band in mode 2 using 802.11b/g/n modulations. Operations of the design comply with Digital Transmission System requirements (DTS). The DTS system provides peak output power of 44 mW (16.45 dBm) into the antenna system. The design requires external display to provide user display. The product operates from external direct current power only and offers no provision to interface with utility power systems. The design utilizes internal fixed antenna systems and offers no provision for antenna replacement or modification. Two samples were provided for testing, one representative of production design with integral antenna, and the other modified replacing the integral antenna with RF connection ports for testing purposes. Test samples were provided with test software (icb_fw: ver 2.50) enabling testing personnel the ability to enable transmitter functions on defined channels and operational modes. The antenna modification offered testing facility ability to connect test equipment to the temporary antenna port for antenna port conducted emission testing. The EUT was arranged as described by the manufacturer for testing purposes. The design provides interface options including connection to marine network interfaces, NMEA 0183, NMEA 2000, J1939 interface, micro USB, CVBS input, HDMI video in/out interfaces, and power. Garmin Remote Interface Devices (GRID) were attached to the marine Network ports. The EUT offers no other interface connections than those in the configuration option shown below as described by the manufacturer. For testing purposes, the EUT received power from a bench DC power supply and configured to operate in available modes. As requested by the manufacturer and required by regulations, the equipment was tested for emissions compliance using the available configurations with the worst-case data presented. Test results in this report relate only to the products described in this report.

Equipment Configuration

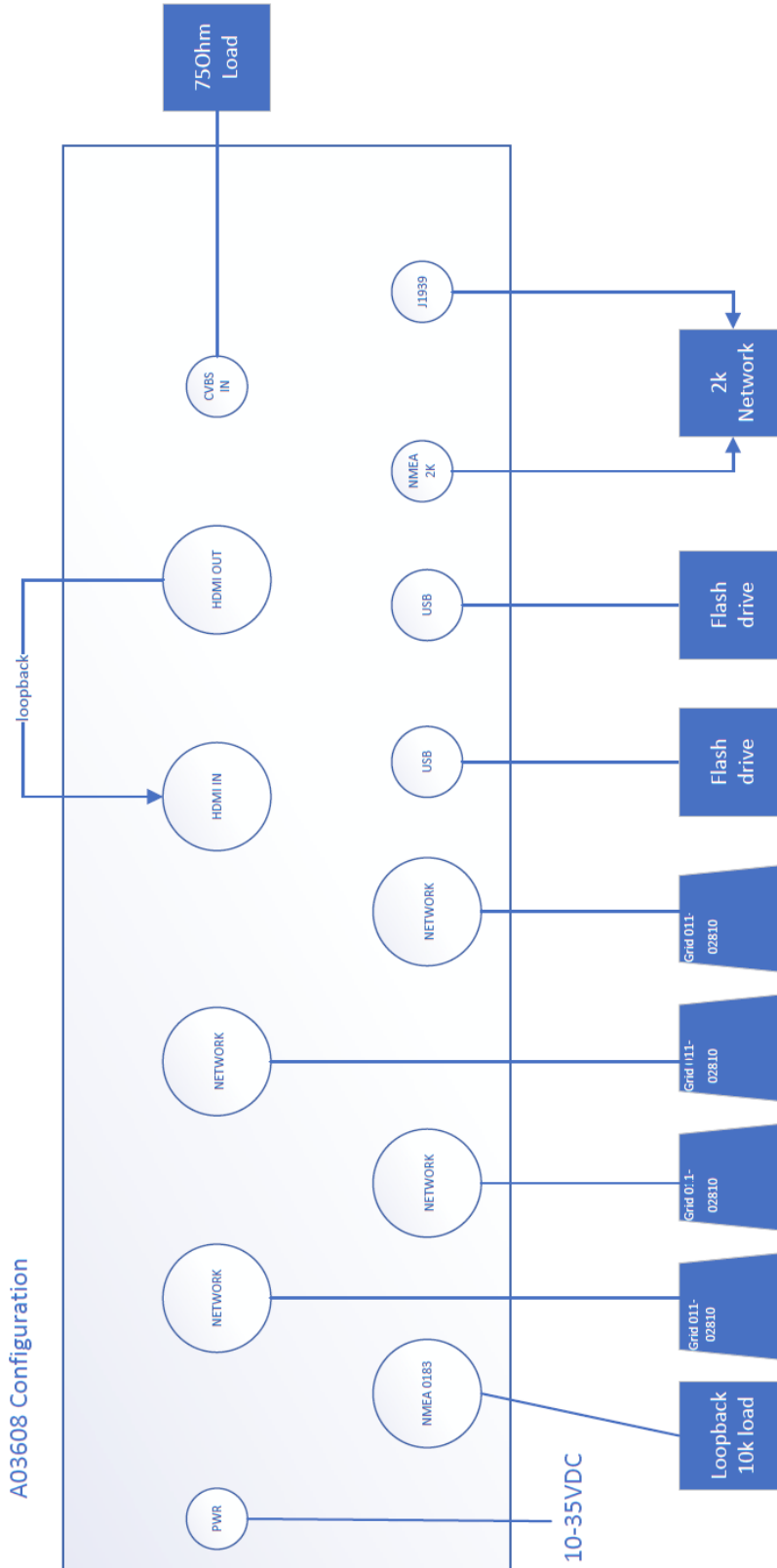

Application for Certification

- (1) Manufacturer: Garmin International, Inc.
1200 East 151st Street
Olathe, KS 66062
- (2) Identification: M/N: A03608
FCC ID: IPH-03608 IC: 1792A-03608
- (3) Instruction Book:
Refer to Exhibit for Instruction Manual.
- (4) Description of Circuit Functions:
Refer to Exhibit of Operational Description.
- (5) Block Diagram with Frequencies:
Refer to Exhibit of Operational Description.
- (6) Report of Measurements:
Report of measurements follows in this Report.
- (7) Photographs: Construction, Component Placement, etc.:
Refer to Exhibit for photographs of equipment.
- (8) List of Peripheral Equipment Necessary for operation. The equipment operates from external direct current power provided from installation vehicle sources. The EUT also provides communication options as documented and presented in this filing.
- (9) Transition Provisions of 47 CFR 15.37 are not requested.
- (10) Not Applicable. The unit is not a scanning receiver.
- (11) Not Applicable. The EUT does not operate in the 59 – 64 GHz frequency band.
- (12) The equipment is not software defined and this section is not applicable.
- (13) Applications for certification of U-NII devices in the 5.15-5.35 GHz and the 5.47-5.85 GHz bands must include a high-level operational description of the security procedures that control the radio frequency operating parameters and ensure that unauthorized modifications cannot be made. This requirement is not applicable to his DTS device.
- (14) Contain at least one drawing or photograph showing the test set-up for each of the required types of tests applicable to the device for which certification is requested. These drawings or photographs must show enough detail to confirm other information contained in the test report. Any photographs used must be focused originals without glare or dark spots and must clearly show the test configuration used. This information is provided in this report and Test Setup Exhibits provided with the application filing.

Applicable Standards & Test Procedures

The following information is submitted in accordance with the eCFR Federal Communications Code of Federal Regulations, dated September 5, 2018, Part 2, Subpart J, Paragraphs 2.907, 2.911, 2.913, 2.925, 2.926, 2.1031 through 2.1057, and applicable parts of paragraph 15, Part 15C Paragraph 15.247, and Industry Canada RSS-GEN Issue 5, and RSS-247 Issue 2. Test procedures used are the established Methods of Measurement of Radio-Noise Emissions as described in ANSI C63.10-2013. This report documents compliance for the EUT operations as Digital Transmission system equipment.

Testing Procedures

AC Line Conducted Emission Test Procedure

The EUT operates on direct current power only provided by the vehicle installation. Therefore, no AC line conducted emission testing was required or performed.

Radiated Emission Test Procedure

Radiated emissions testing was performed as required in 47 CFR 15, RSS-247 and specified in ANSI C63.10-2013. The EUT was placed on a rotating 0.9 x 1.2-meter platform, elevated as required above the ground plane at a distance of 3 meters from the FSM antenna. EMI energy was maximized by equipment placement permitting orientation in three orthogonal axes, raising and lowering the FSM antenna, changing the antenna polarization, and by rotating the turntable. Each emission was maximized before data was taken using a spectrum analyzer. The frequency spectrum from 9 kHz to 25,000 MHz was searched for during preliminary investigation. Refer to diagrams one and two showing typical test arrangement and photographs in the test setup exhibits for specific EUT placement during testing.

Antenna Port Conducted Emission Test Procedure

The EUT was assembled as required for operation placed on a benchtop. This configuration provided the ability to connect test equipment to the provided test antenna port. Antenna Port conducted emissions testing was performed presented in the regulations and specified in ANSI C63. 26-2015. Testing was completed on a laboratory bench in a shielded room. The active antenna port of the device was connected to appropriate attenuation and the spectrum analyzer. Refer to diagram three showing typical test arrangement and photographs in the test setup exhibits for specific EUT placement during testing.

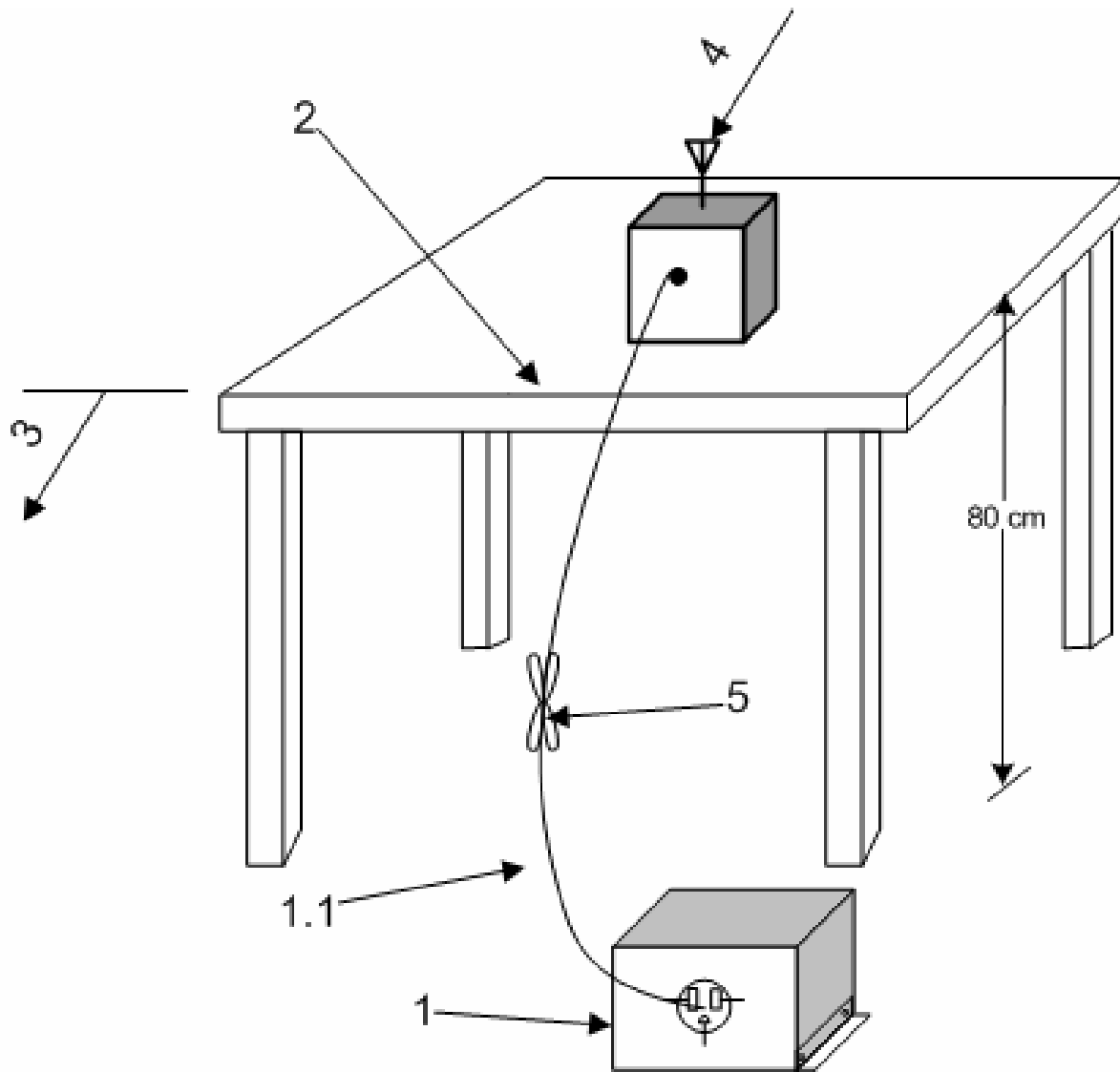

1—A LISN is optional for radiated measurements between 30 MHz and 1000 MHz but not allowed for measurements below 30 MHz and above 1000 MHz (see 6.3.1). If used, then connect EUT to one LISN. Unused LISN measuring port connectors shall be terminated in 50 Ω loads. The LISN may be placed on top of, or immediately beneath, the reference ground plane (see 6.2.2 and 6.2.3.2).

1.1—LISN spaced at least 80 cm from the nearest part of the EUT chassis.

2—Antenna can be integral or detachable, depending on the EUT (see 6.3.1).

3—Interconnecting cables that hang closer than 40 cm to the ground plane shall be folded back and forth in the center forming a bundle 30 cm to 40 cm long (see 6.3.1).

4—For emission measurements at or below 1 GHz, the table height shall be 80 cm. For emission measurements above 1 GHz, the table height shall be 1.5 m for measurements, except as otherwise specified (see 6.3.1 and 6.6.3.1).

Diagram 1 Test arrangement for radiated emissions of tabletop equipment

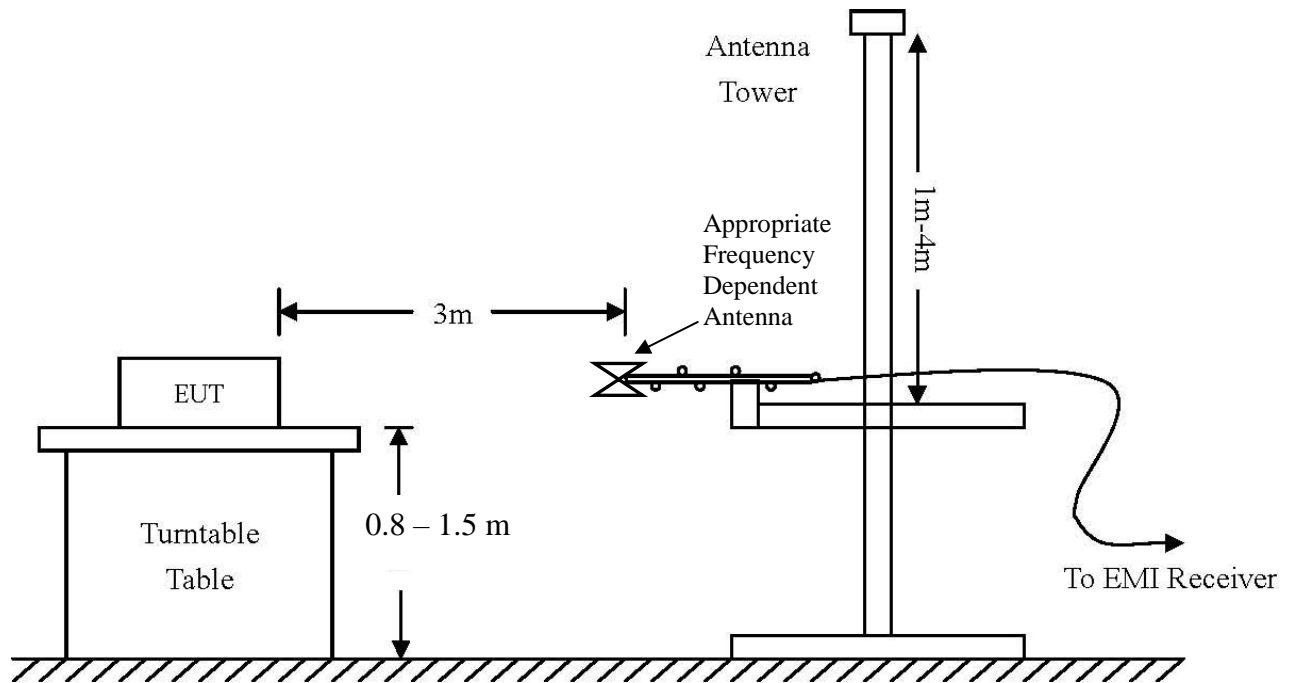

AC Line Conducted Emissions (0.150 -30 MHz)		
RBW	AVG. BW	Detector Function
9 kHz	30 kHz	Peak / Quasi Peak
Emissions (30-1000 MHz)		
RBW	AVG. BW	Detector Function
120 kHz	300 kHz	Peak / Quasi Peak
Emissions (Above 1000 MHz)		
RBW	Video BW	Detector Function
100 kHz	100 kHz	Peak
1 MHz	1 MHz	Peak / Average

Diagram 2 Test arrangement for radiated emissions tested on Open Area Test Site (OATS)

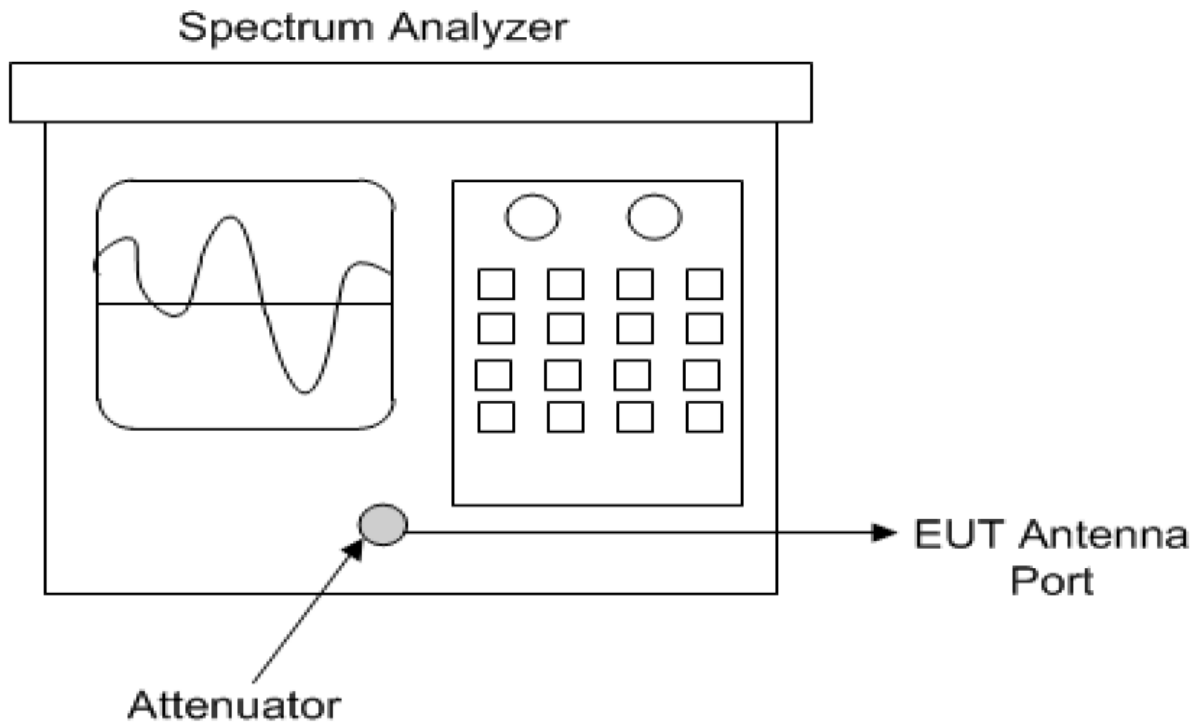

Diagram 3 Test arrangement for Antenna Port Conducted emissions

Test Site Locations

Conducted EMI	AC line conducted emissions testing performed in a shielded screen room located at Rogers Labs, Inc., 4405 West 259 th Terrace, Louisburg, KS
Radiated EMI	The radiated emissions tests were performed at the 3 meters, Open Area Test Site (OATS) located at Rogers Labs, Inc., 4405 West 259 th Terrace, Louisburg, KS
Registered Site #	FCC Site: US5305 and Industry Canada Registration: 3041A-1
NVLAP Accreditation	Lab code 200087-0

List of Test Equipment

<u>Equipment</u>	<u>Manufacturer</u>	<u>Model (SN)</u>	<u>Band</u>	<u>Cal Date(m/d/y)</u>	<u>Due</u>
<input type="checkbox"/> LISN	FCC	FCC-LISN-50-2-10(1PA) (160611)	.15-30MHz	5/2/2018	5/2/2019
<input type="checkbox"/> LISN	Compliance Design	FCC-LISN-2.Mod.cd,	.15-30MHz	10/24/2017	10/24/2018
<input checked="" type="checkbox"/> Cable	Huber & Suhner Inc.	Sucoflex102ea(L10M)(303073)	9kHz-40 GHz	10/24/2017	10/24/2018
<input checked="" type="checkbox"/> Cable	Huber & Suhner Inc.	Sucoflex102ea(1.5M)(303069)	9kHz-40 GHz	10/24/2017	10/24/2018
<input type="checkbox"/> Cable	Huber & Suhner Inc.	Sucoflex102ea(1.5M)(303071)	9kHz-40 GHz	10/24/2017	10/24/2018
<input type="checkbox"/> Cable	Belden	RG-58 (L1-CAT3-11509)	9kHz-30 MHz	10/24/2017	10/24/2018
<input type="checkbox"/> Cable	Belden	RG-58 (L2-CAT3-11509)	9kHz-30 MHz	10/24/2017	10/24/2018
<input type="checkbox"/> Antenna	ARA	BCD-235-B (169)	20-350MHz	10/24/2017	10/24/2018
<input type="checkbox"/> Antenna	EMCO	3147 (40582)	200-1000MHz	10/24/2017	10/24/2018
<input checked="" type="checkbox"/> Antenna	ETS-Lindgren	3117 (200389)	1-18 GHz	5/2/2018	5/2/2020
<input type="checkbox"/> Antenna	Com Power	AH-118 (10110)	1-18 GHz	10/24/2017	10/24/2019
<input checked="" type="checkbox"/> Antenna	Com Power	AH-840 (101046)	18-40 GHz	5/15/2017	5/15/2019
<input checked="" type="checkbox"/> Antenna	Com Power	AL-130 (121055)	.001-30 MHz	10/24/2017	10/24/2018
<input checked="" type="checkbox"/> Antenna	Sunol	JB-6 (A100709)	30-1000 MHz	10/24/2017	10/24/2018
<input checked="" type="checkbox"/> Analyzer	Rohde & Schwarz	ESU40 (100108)	20Hz-40GHz	5/2/2018	5/2/2019
<input type="checkbox"/> Analyzer	Rohde & Schwarz	ESW44 (101534)	20Hz-44GHz	12/22/2017	12/22/2018
<input type="checkbox"/> Analyzer	Rohde & Schwarz	FS-Z60, 90, 140, and 220	40GHz-220GHz	12/22/2017	12/22/2019
<input type="checkbox"/> Analyzer	HP	8591EM (3628A00871)	9kHz-1.8GHz	5/2/2018	5/2/2019
<input type="checkbox"/> Analyzer	HP	8562A (3051A05950)	9kHz-125GHz	5/2/2018	5/2/2019
<input type="checkbox"/> Analyzer	HP External Mixers	11571, 11970	25GHz-110GHz	5/2/2018	5/2/2019
<input checked="" type="checkbox"/> Amplifier	Com-Power	PA-010 (171003)	100Hz-30MHz	10/24/2017	10/24/2018
<input checked="" type="checkbox"/> Amplifier	Com-Power	CPPA-102 (01254)	1-1000 MHz	10/24/2017	10/24/2018
<input checked="" type="checkbox"/> Amplifier	Com-Power	PAM-118A (551014)	0.5-18 GHz	10/24/2017	10/24/2018
<input checked="" type="checkbox"/> Power Meter	Agilent	N1911A with N1921A	0.05-40 GHz	5/2/2018	5/2/2019
<input type="checkbox"/> Generator	Rohde & Schwarz	SMB100A6 (100150)	20Hz-6 GHz	5/2/2018	5/2/2019
<input type="checkbox"/> Generator	Rohde & Schwarz	SMBV100A6 (260771)	20Hz-6 GHz	5/2/2018	5/2/2019
<input type="checkbox"/> RF Filter	Micro-Tronics	BRC50722 (009).9G notch	30-1800 MHz	5/2/2018	5/2/2019
<input type="checkbox"/> RF Filter	Micro-Tronics	HPM50114 (017)1.5G HPF	30-18000 MHz	5/2/2018	5/2/2019
<input type="checkbox"/> RF Filter	Micro-Tronics	HPM50117 (063) 3G HPF	30-18000 MHz	5/2/2018	5/2/2019
<input type="checkbox"/> RF Filter	Micro-Tronics	HPM50105 (059) 6G HPF	30-18000 MHz	5/2/2018	5/2/2019
<input type="checkbox"/> RF Filter	Micro-Tronics	BRM50702 (172) 2G notch	30-1800 MHz	5/2/2018	5/2/2019
<input type="checkbox"/> RF Filter	Micro-Tronics	BRC50703 (G102) 5G notch	30-1800 MHz	5/2/2018	5/2/2019
<input type="checkbox"/> RF Filter	Micro-Tronics	BRC50705 (024) 5G notch	30-1800 MHz	5/2/2018	5/2/2019
<input checked="" type="checkbox"/> Attenuator	Mini-Circuits	VAT-3W2+ (1735)	30-6000 MHz	5/2/2018	5/2/2019
<input type="checkbox"/> Attenuator	Mini-Circuits	VAT-3W2+ (1436)	30-6000 MHz	5/2/2018	5/2/2019
<input type="checkbox"/> Attenuator	Mini-Circuits	VAT-3W2+ (14362)	30-6000 MHz	5/2/2018	5/2/2019
<input type="checkbox"/> Attenuator	Mini-Circuits	VAT-3W2+ (1445)	30-6000 MHz	5/2/2018	5/2/2019
<input type="checkbox"/> Attenuator	Mini-Circuits	VAT-3W2+ (14452)	30-6000 MHz	5/2/2018	5/2/2019
<input type="checkbox"/> Attenuator	Mini-Circuits	VAT-6W2+ (1438)	30-6000 MHz	5/2/2018	5/2/2019
<input type="checkbox"/> Attenuator	Mini-Circuits	VAT-6W2+ (1736)	30-6000 MHz	5/2/2018	5/2/2019
<input checked="" type="checkbox"/> Weather station	Davis	6312 (A70927D44N)		10/24/2017	10/24/2018

Rogers Labs, Inc.
4405 W. 259th Terrace
Louisburg, KS 66053
Phone/Fax: (913) 837-3214
Revision 1

Garmin International, Inc.
Model: A03608
Test #: 180905
Test to: CFR47 15C, RSS-Gen RSS-247
File: A03608 DTS TstRpt 180905

SN's: 39771 86171 / 39771 86163
FCC ID: IPH-03608
IC: 1792A-03608
Date: October 29, 2018
Page 15 of 51

Units of Measurements

Conducted EMI Data is in dB μ V; dB referenced to one microvolt

Radiated EMI Data is in dB μ V/m; dB/m referenced to one microvolt per meter

Sample Calculation:

RFS = Radiated Field Strength, FSM = Field Strength Measured

A.F. = Receive antenna factor, Gain = amplification gains and/or cable losses

RFS (dB μ V/m @ 3m) = FSM (dB μ V) + A.F. (dB) - Gain (dB)

Environmental Conditions

Ambient Temperature 23.7° C

Relative Humidity 40%

Atmospheric Pressure 1017.9 mb

Statement of Modifications and Deviations

No modifications to the EUT were required for the unit to demonstrate compliance with the 47 CFR Part 15C, RSS-Gen, and RSS-247 emission requirements. There were no deviations to the specifications.

Intentional Radiators

The following information is submitted in support demonstration of compliance with the requirements of 47 CFR, Subpart C, paragraph 15.247 and Industry Canada RSS-247 and RSS-Gen the following information is submitted.

Antenna Requirements

The EUT incorporates integral antenna system and offers no provision for connection to alternate antenna system. The antenna connection point complies with the unique antenna connection requirements. There are no deviations or exceptions to the specification.

Restricted Bands of Operation

Spurious emissions falling in the restricted frequency bands of operation were measured at the OATS. The EUT utilizes frequency, determining circuitry, which generates harmonics falling in the restricted bands. Emissions were investigated at the OATS, using appropriate antennas or pyramidal horns, amplification stages, and a spectrum analyzer. Peak and average amplitudes of frequencies above 1000 MHz were compared to the required limits with worst-case data presented below. Test procedures of ANSI C63.10-2013 were used during testing. No other significant emission was observed which fell into the restricted bands of operation. Computed emission values consider the received radiated field strength, receive antenna correction factor, amplifier gain stage, and test system cable losses.

Table 1 Radiated Emissions in Restricted Frequency Bands Data (GFSK)

Frequency in MHz	Horizontal Peak (dBμV/m)	Horizontal Quasi-Peak (dBμV/m)	Horizontal Average (dBμV/m)	Vertical Peak (dBμV/m)	Vertical Quasi-Peak (dBμV/m)	Vertical Average (dBμV/m)	Limit @ 3m (dBμV/m)
2390.0	54.9	N/A	30.2	47.6	N/A	29.9	54.0
2483.5	56.6	N/A	30.7	48.2	N/A	30.5	54.0
4804.0	67.5	N/A	39.6	53.3	N/A	34.6	54.0
4884.0	67.2	N/A	39.5	57.4	N/A	35.7	54.0
4958.0	50.3	N/A	34.3	47.0	N/A	33.9	54.0
7206.0	50.5	N/A	37.8	50.3	N/A	37.8	54.0
7326.0	51.3	N/A	38.2	50.8	N/A	38.2	54.0
7437.0	51.5	N/A	38.2	51.4	N/A	38.2	54.0
12010.0	55.5	N/A	43.0	56.1	N/A	43.0	54.0
12210.0	58.0	N/A	44.7	57.6	N/A	44.7	54.0
12395.0	56.6	N/A	44.0	57.5	N/A	44.1	54.0

Other emissions present had amplitudes at least 20 dB below the limit. Peak and Quasi-Peak amplitude emissions are recorded for frequency range below 1000 MHz. Peak and Average amplitude emissions are recorded for frequency range above 1000 MHz.

Table 2 Radiated Emissions in Restricted Frequency Bands Data (GMSK)

Frequency in MHz	Horizontal Peak (dBµV/m)	Horizontal Quasi-Peak (dBµV/m)	Horizontal Average (dBµV/m)	Vertical Peak (dBµV/m)	Vertical Quasi-Peak (dBµV/m)	Vertical Average (dBµV/m)	Limit @ 3m (dBµV/m)
2390.0	55.6	N/A	30.7	45.1	N/A	29.9	54.0
2483.5	61.9	N/A	34.9	51.4	N/A	31.2	54.0
4804.0	62.2	N/A	51.6	61.7	N/A	51.0	54.0
4880.0	62.5	N/A	53.6	57.1	N/A	48.6	54.0
4960.0	56.6	N/A	47.3	54.6	N/A	43.2	54.0
7206.0	52.4	N/A	39.9	53.0	N/A	40.1	54.0
7320.0	53.2	N/A	40.4	55.0	N/A	42.7	54.0
7440.0	53.2	N/A	40.6	52.9	N/A	39.9	54.0
12010.0	56.0	N/A	43.0	56.5	N/A	43.1	54.0
12200.0	57.7	N/A	44.8	57.9	N/A	44.8	54.0
12400.0	56.6	N/A	44.0	56.4	N/A	44.0	54.0

Other emissions present had amplitudes at least 20 dB below the limit. Peak and Quasi-Peak amplitude emissions are recorded for frequency range below 1000 MHz. Peak and Average amplitude emissions are recorded for frequency range above 1000 MHz.

Table 3 Harmonic Radiated Emissions in Restricted Bands Data (802.11b, Worst-case)

Frequency in MHz	Horizontal Peak (dBμV/m)	Horizontal Quasi-Peak (dBμV/m)	Horizontal Average (dBμV/m)	Vertical Peak (dBμV/m)	Vertical Quasi-Peak (dBμV/m)	Vertical Average (dBμV/m)	Limit @ 3m (dBμV/m)
2390.0	52.6	N/A	45.2	44.8	N/A	31.7	54.0
2483.5	51.0	N/A	38.9	52.9	N/A	33.8	54.0
4824.0	49.8	N/A	36.3	50.3	N/A	40.8	54.0
4874.0	47.7	N/A	36.0	48.2	N/A	35.4	54.0
4924.0	48.8	N/A	37.2	51.0	N/A	42.1	54.0
7236.0	51.1	N/A	37.7	51.7	N/A	37.8	54.0
7311.0	51.7	N/A	38.9	51.9	N/A	38.9	54.0
7386.0	51.2	N/A	38.2	51.9	N/A	38.2	54.0
12060.0	56.6	N/A	43.4	56.6	N/A	43.2	54.0
12185.0	58.2	N/A	45.4	58.7	N/A	45.4	54.0
12310.0	57.9	N/A	45.2	58.4	N/A	45.2	54.0

Other emissions present had amplitudes at least 20 dB below the limit. Peak and Quasi-Peak amplitude emissions are recorded for frequency below 1000 MHz. Peak and Average amplitude emissions are recorded for frequency range above 1000 MHz.

Table 4 Harmonic Radiated Emissions in Restricted Bands Data (802.11g, Worst-case)

Frequency in MHz	Horizontal Peak (dB μ V/m)	Horizontal Quasi-Peak (dB μ V/m)	Horizontal Average (dB μ V/m)	Vertical Peak (dB μ V/m)	Vertical Quasi-Peak (dB μ V/m)	Vertical Average (dB μ V/m)	Limit @ 3m (dB μ V/m)
2390.0	65.1	N/A	39.1	52.1	N/A	31.8	54.0
2483.5	64.0	N/A	39.0	56.2	N/A	33.7	54.0
4824.0	47.6	N/A	34.3	47.8	N/A	34.6	54.0
4874.0	47.8	N/A	34.8	48.7	N/A	35.4	54.0
4924.0	47.4	N/A	34.3	47.3	N/A	34.4	54.0
7236.0	50.5	N/A	37.8	50.5	N/A	37.8	54.0
7311.0	51.3	N/A	38.6	51.6	N/A	38.6	54.0
7386.0	51.6	N/A	38.2	51.3	N/A	38.2	54.0
12060.0	56.3	N/A	43.2	56.1	N/A	43.1	54.0
12185.0	58.5	N/A	45.0	58.0	N/A	45.0	54.0
12310.0	58.2	N/A	45.2	59.0	N/A	45.3	54.0

Other emissions present had amplitudes at least 20 dB below the limit. Peak and Quasi-Peak amplitude emissions are recorded for frequency below 1000 MHz. Peak and Average amplitude emissions are recorded for frequency range above 1000 MHz.

Table 5 Harmonic Radiated Emissions in Restricted Bands Data (802.11n, Worst-case)

Frequency in MHz	Horizontal Peak (dBµV/m)	Horizontal Quasi-Peak (dBµV/m)	Horizontal Average (dBµV/m)	Vertical Peak (dBµV/m)	Vertical Quasi-Peak (dBµV/m)	Vertical Average (dBµV/m)	Limit @ 3m (dBµV/m)
2390.0	64.5	N/A	38.4	54.7	N/A	31.9	54.0
2483.5	64.6	N/A	39.6	55.3	N/A	33.4	54.0
4824.0	48.1	N/A	34.4	47.7	N/A	34.5	54.0
4874.0	48.0	N/A	35.0	48.1	N/A	35.2	54.0
4924.0	47.3	N/A	34.3	47.4	N/A	34.4	54.0
7236.0	50.6	N/A	37.8	51.0	N/A	37.8	54.0
7311.0	52.1	N/A	38.7	51.7	N/A	38.5	54.0
7386.0	52.0	N/A	38.4	51.1	N/A	38.3	54.0
12060.0	56.7	N/A	43.4	56.6	N/A	43.6	54.0
12185.0	57.8	N/A	45.0	58.1	N/A	45.0	54.0
12310.0	58.3	N/A	45.2	58.5	N/A	45.2	54.0

Other emissions present had amplitudes at least 20 dB below the limit. Peak and Quasi-Peak amplitude emissions are recorded for frequency below 1000 MHz. Peak and Average amplitude emissions are recorded for frequency range above 1000 MHz.

Summary of Results for Radiated Emissions in Restricted Bands

The EUT demonstrated compliance with the radiated emissions requirements of 47 CFR Part 15C RSS-Gen, and RSS-247 Intentional Radiators. The EUT worst-case operation mode demonstrated a minimum radiated emission margin of -0.4 dB below the requirements in restricted frequency bands. Peak, Quasi-peak, and average amplitudes were checked for compliance with the regulations. Worst-case emissions are reported with other emissions found in the restricted frequency bands at least 20 dB below the requirements.

General Radiated Emissions Procedure

The EUT was arranged in a typical equipment configuration and operated through all available mode during testing. Preliminary testing was performed in a screen room with the EUT positioned 1 meter from the FSM. Radiated emissions measurements were performed to identify the frequencies, which produced the highest emissions. Each radiated emission was then maximized at the OATS location before final radiated measurements were performed. Final data was taken with the EUT located on the OATS at 3 meters distance between the EUT and the receiving antenna. The frequency spectrum from 9 kHz to 25,000 MHz was searched for general radiated emissions. Measured emission levels were maximized by EUT placement on the table, rotating the turntable through 360 degrees, varying the antenna height between 1 and 4 meters above the ground plane and changing antenna position between horizontal and vertical polarization. Antennas used were Loop from 9 kHz to 30 MHz, Broadband Biconical from 30 to 200 MHz, Biconilog from 30 to 1000 MHz, Log Periodic from 200 MHz to 1 GHz and or double Ridge or pyramidal horns and mixers above 1 GHz, notch filters and appropriate amplifiers and external mixers were utilized.

Table 6 General Radiated Emissions Data

Frequency in MHz	Horizontal Peak (dBµV/m)	Horizontal Quasi-Peak (dBµV/m)	Horizontal Average (dBµV/m)	Vertical Peak (dBµV/m)	Vertical Quasi-Peak (dBµV/m)	Vertical Average (dBµV/m)	Limit @ 3m (dBµV/m)
55.7	34.9	30.5	N/A	42.2	39.1	N/A	40.0
56.4	36.4	32.3	N/A	41.5	38.2	N/A	40.0
77.3	35.4	30.8	N/A	38.5	35.6	N/A	40.0
90.0	35.7	30.5	N/A	39.0	32.6	N/A	40.0
95.0	30.3	23.0	N/A	32.4	27.2	N/A	40.0
103.0	27.3	19.1	N/A	25.9	20.5	N/A	40.0
110.8	36.1	32.0	N/A	30.2	25.7	N/A	40.0
129.5	38.1	34.1	N/A	31.6	29.0	N/A	40.0
148.3	37.5	34.1	N/A	35.3	31.6	N/A	40.0
161.2	34.1	30.4	N/A	28.0	24.2	N/A	40.0
179.2	29.8	25.1	N/A	24.8	19.8	N/A	40.0
249.7	40.7	37.4	N/A	37.0	34.2	N/A	47.0
250.0	46.2	43.8	N/A	40.2	38.1	N/A	47.0

Other emissions present had amplitudes at least 20 dB below the limit. Peak and Quasi-Peak amplitude emissions are recorded for frequency range below 1000 MHz. Peak and Average amplitude emissions are recorded for frequency range above 1000 MHz.

Summary of Results for General Radiated Emissions

The EUT demonstrated compliance with the radiated emissions requirements of 47 CFR Part 15C paragraph 15.209, RSS-247 and RSS-GEN Intentional Radiators. The EUT demonstrated a minimum margin of -0.9 dB below the requirements. Other emissions were present with amplitudes at least 20 dB below the Limits.

Operation in the Band 2400 – 2483.5 MHz

Test procedures of ANSI C63.10-2013 and KDB 558074 v05 were used during transmitter testing. Test sample #2 was provided for testing antenna port conducted emissions. This sample was modified by replacing the internal antenna with a 50-ohm antenna port connector and attenuator for testing purposes. The transmitter peak and average power was measured at the antenna port using a wideband RF power meter as described in KDB 558074 and C63.10-2013. The peak Power Spectral Density (PKPSD) was measured as defined in KDB 558074 and C63.10-2013. DTS Emission bandwidth was measured as described in KDB 558074 and C63.10-2013. The amplitude of each harmonic and general radiated emission was measured on the OATS at distance of 3 meters from the FSM antenna (radiated emission testing was performed on sample #1 representative of production equipment with integral antenna). The EUT was positioned on supporting turntable elevated as required above the ground plane, at a distance of 3 meters from the FSM antenna. Radiated emission investigations were performed from 9 kHz to 25,000 MHz. Each radiated emission was maximized by varying the FSM antenna height and polarization, and by rotating the turntable. The worst-case amplitude of each emission was then recorded from the analyzer display. The peak and quasi-peak amplitude of frequencies below 1000 MHz were measured using a spectrum analyzer. The peak and average amplitude of frequencies above 1000 MHz were measured using a spectrum analyzer. A Loop antenna was used for measuring emissions from 0.009 to 30 MHz, Biconilog Antenna for 30 to 1000 MHz, Double-Ridge, and/or Pyramidal Horn Antennas from 1 GHz to 25 GHz. Radiated Emissions were measured in dB μ V/m @ 3 meters. Plots were taken of transmitter performance (using sample #2) for reference in this and other documentation.

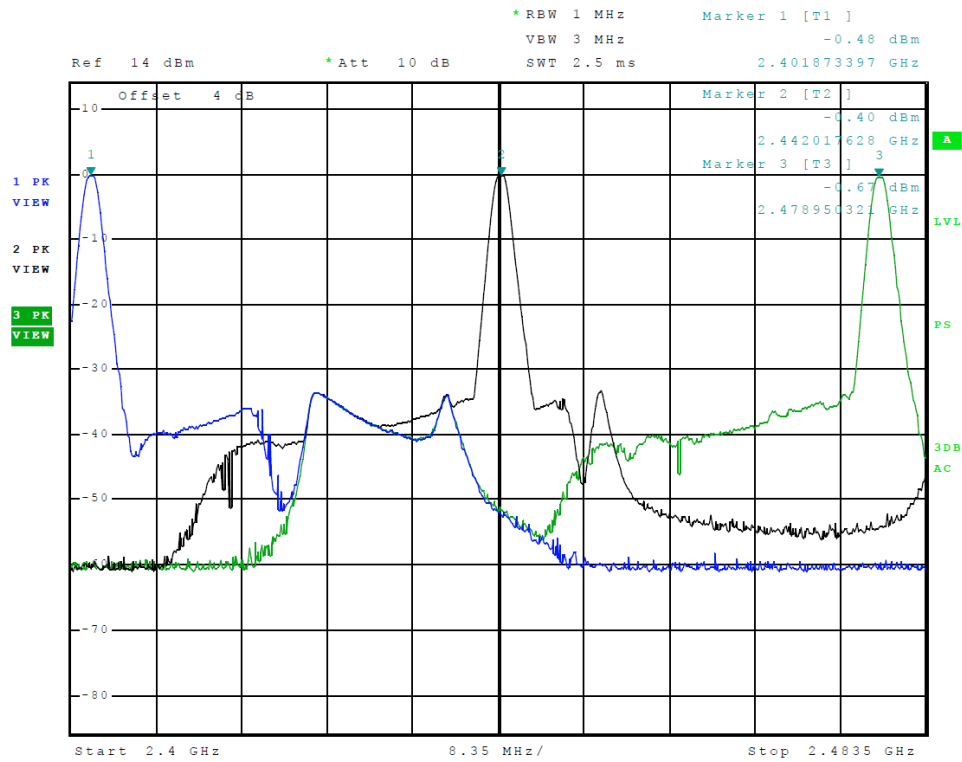

Figure 1 Plot of Transmitter Emissions Operation in 2402-2480 MHz (GFSK)

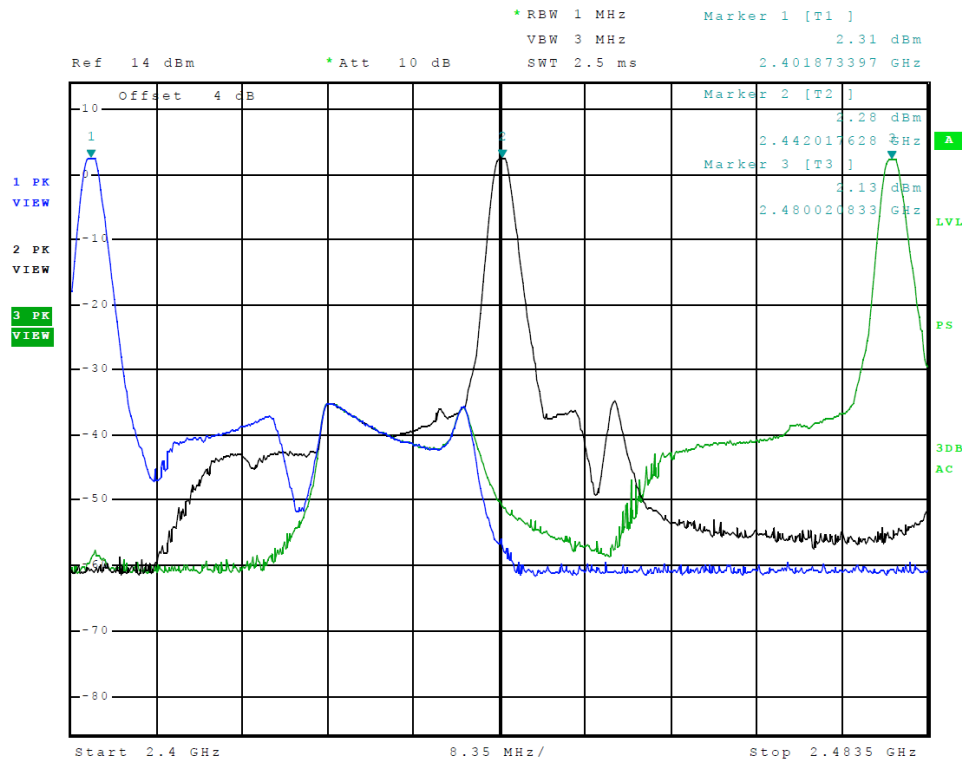

Figure 2 Plot of Transmitter Emissions Operation in 2402-2480 MHz (GMSK)

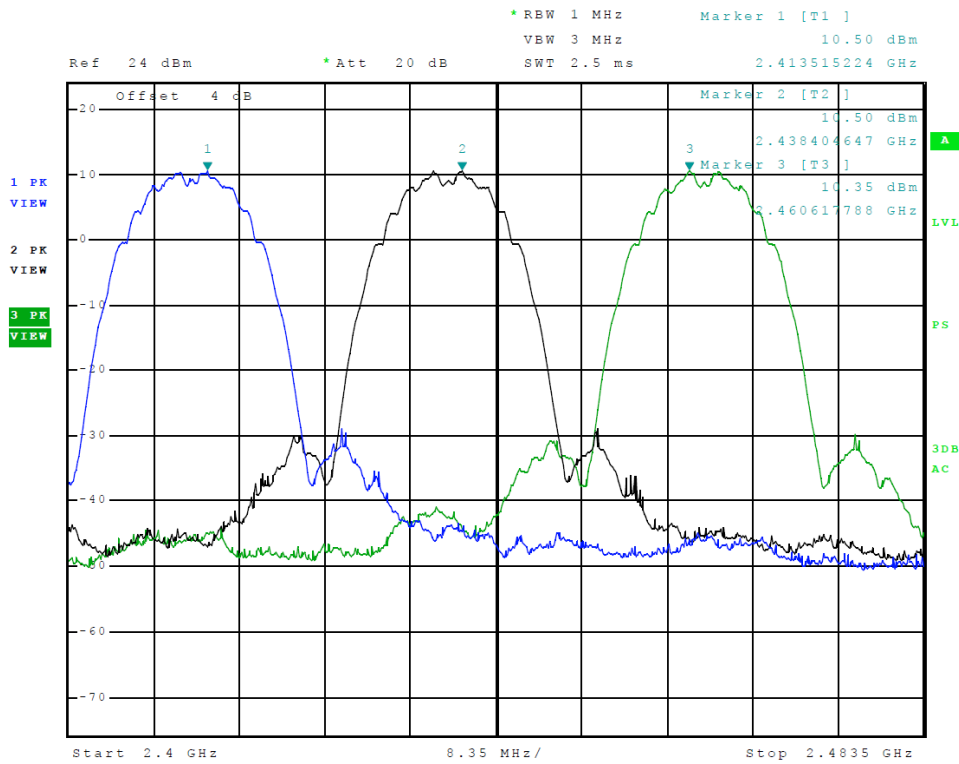

Figure 3 Plot of Transmitter Emissions in Operational Frequency (802.11 b-Mode)

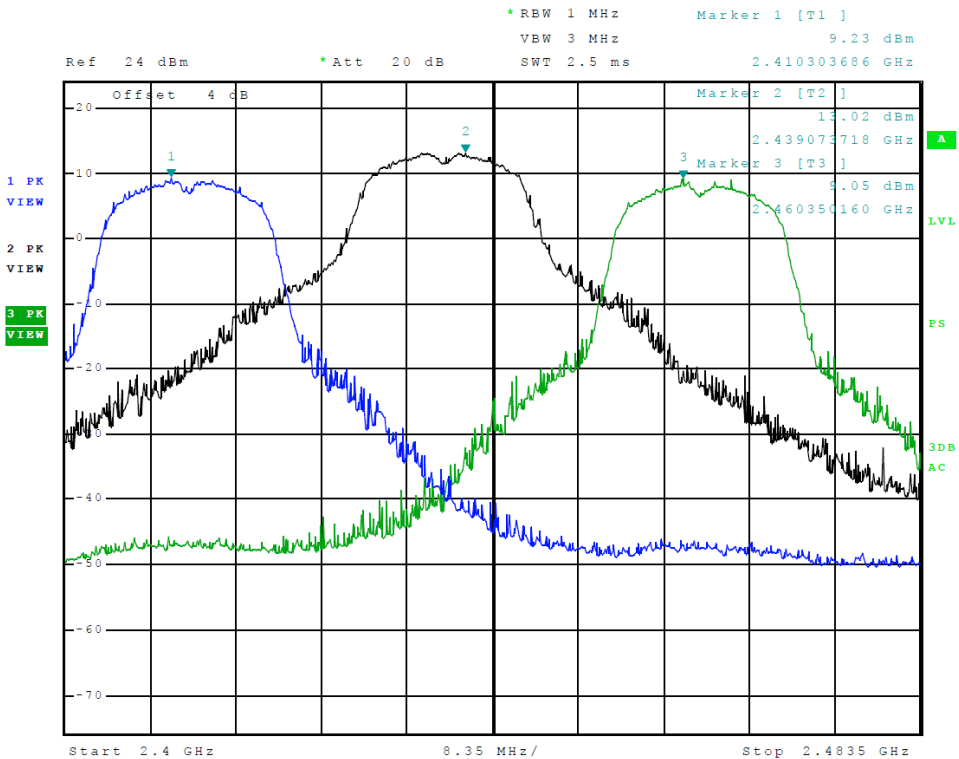

Figure 4 Plot of Transmitter Emissions in Operational Frequency (802.11 g-Mode)

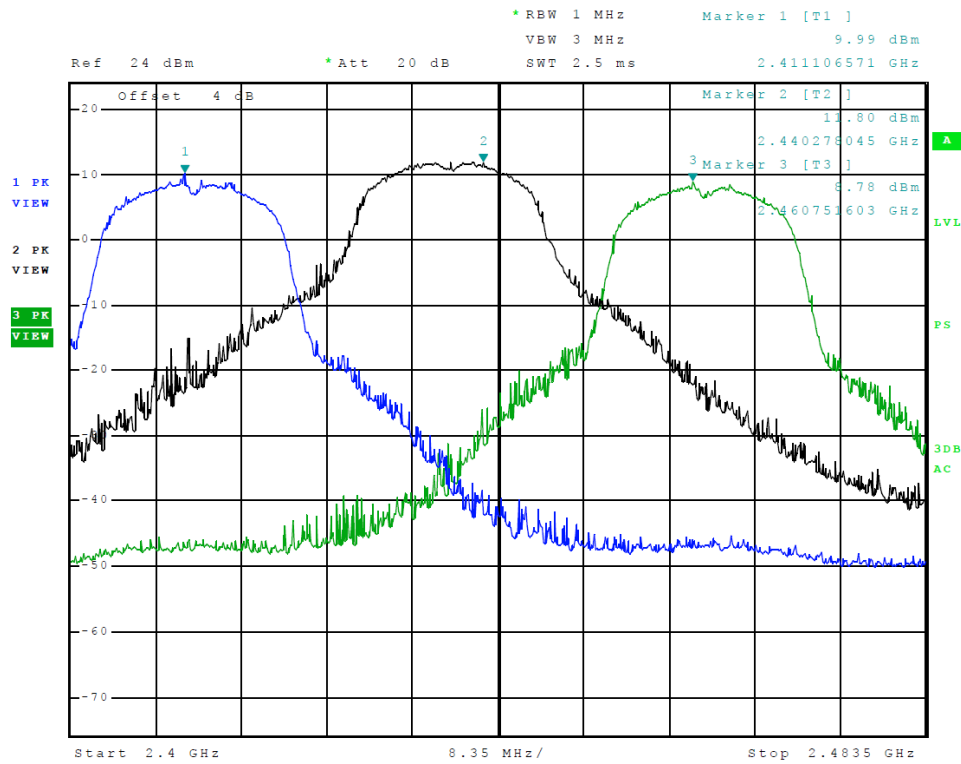

Figure 5 Plot of Transmitter Emissions in Operational Frequency (802.11 n-Mode)

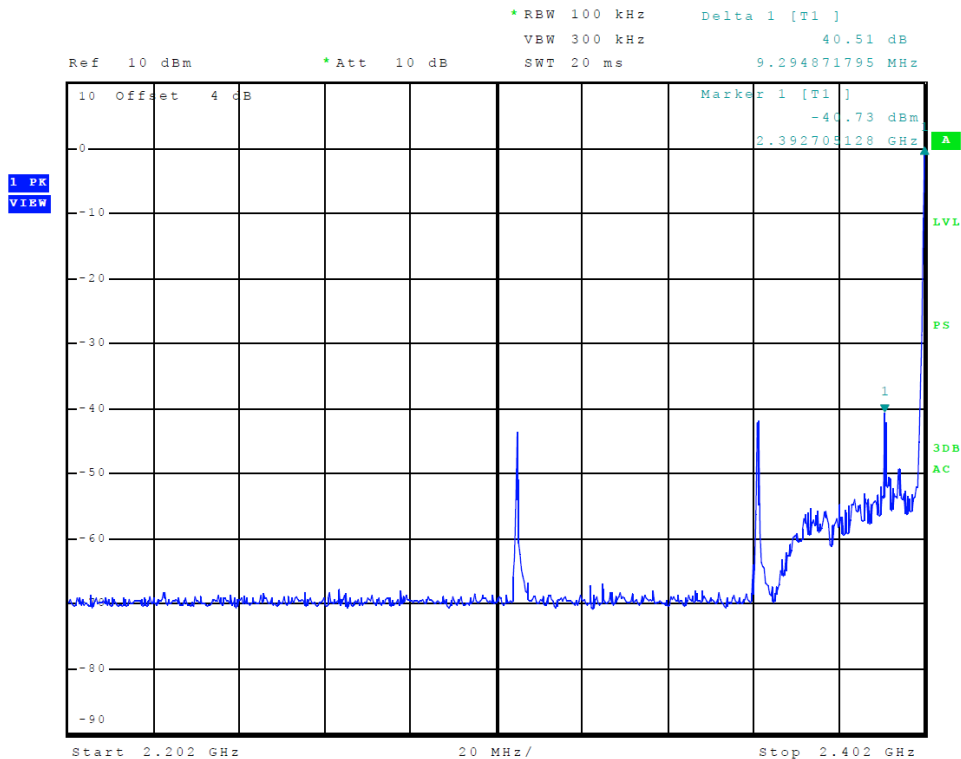

Figure 6 Plot of Transmitter Emissions Low Band Edge (GFSK)

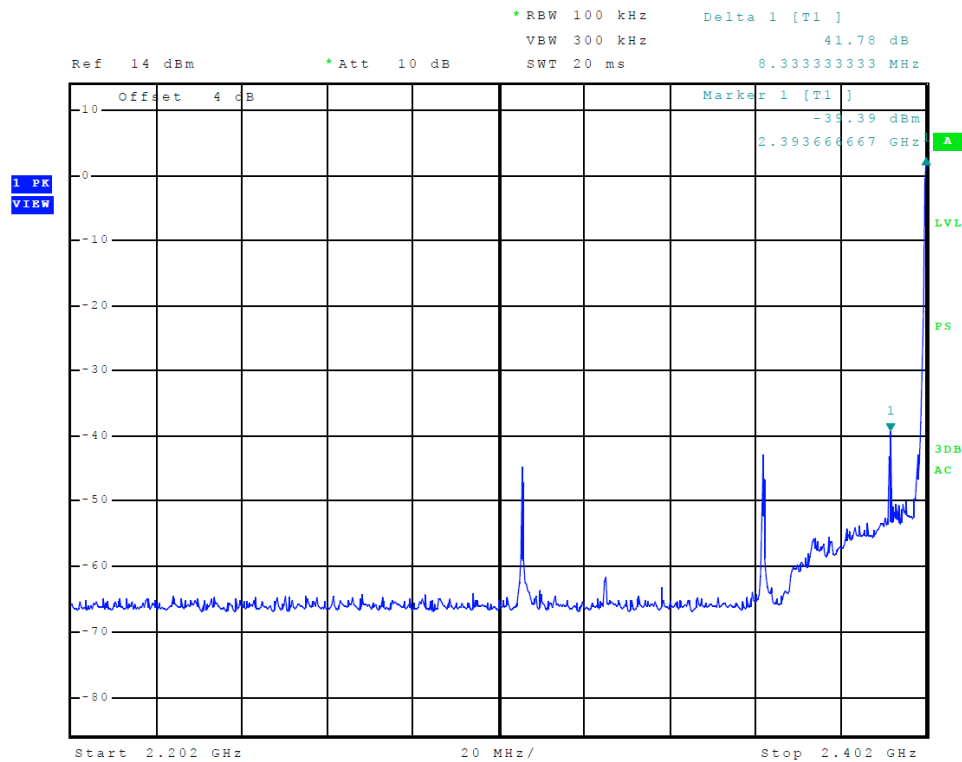

Figure 7 Plot of Transmitter Emissions Low Band Edge (GMSK)

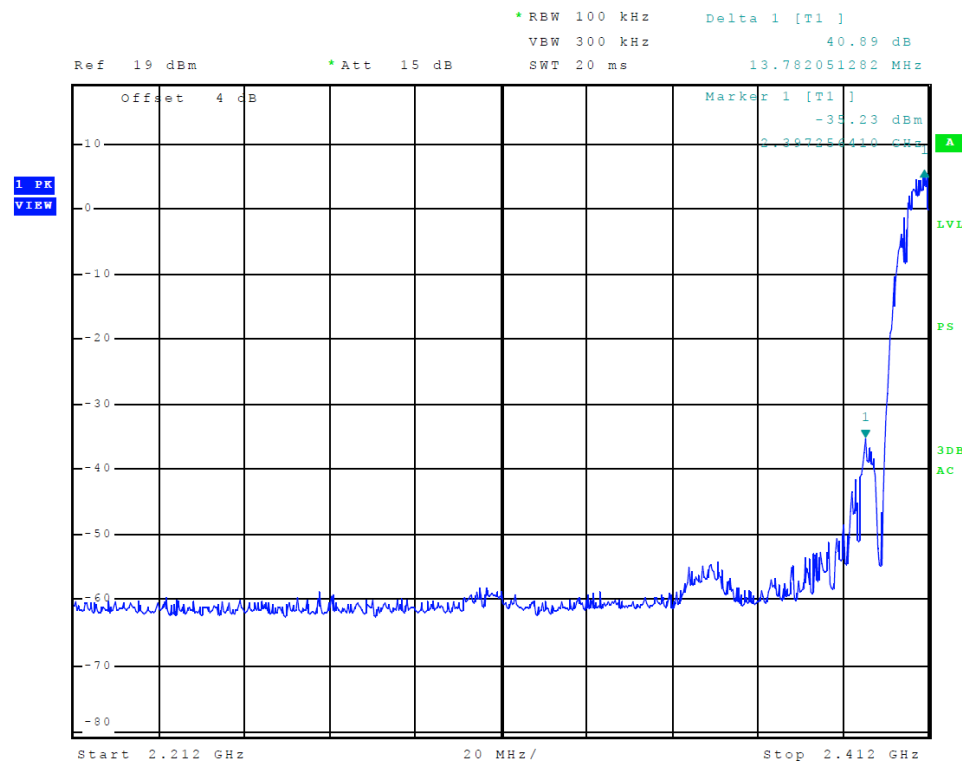

Figure 8 Plot of Lower Band Edge (802.11 b-mode)

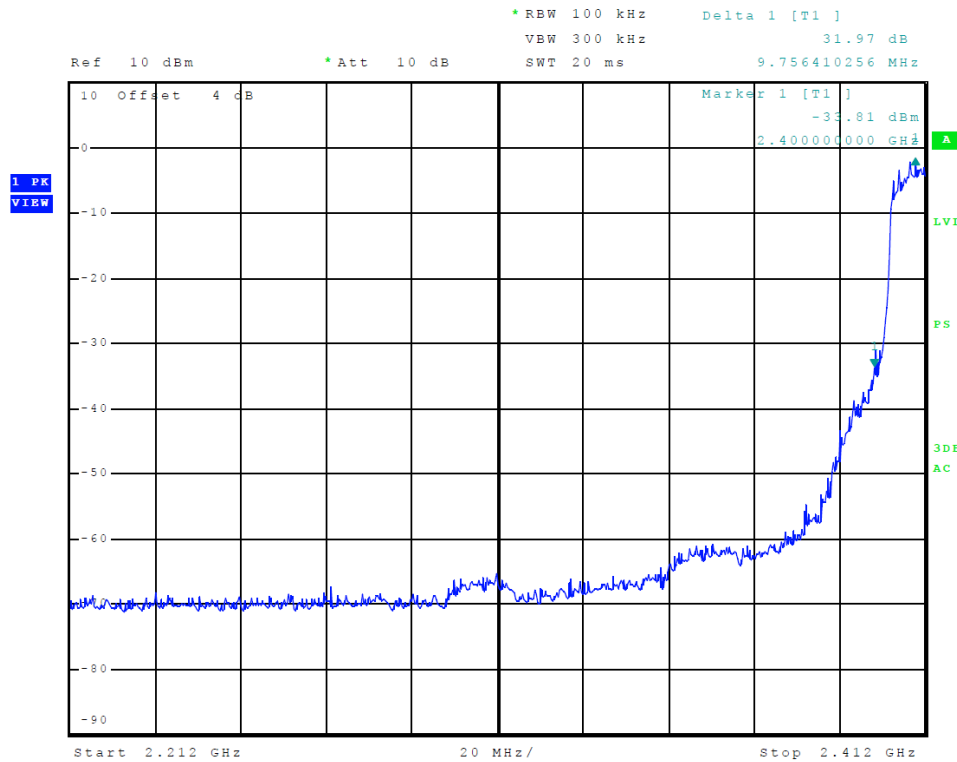

Figure 9 Plot of Lower Band Edge (802.11 g-mode)

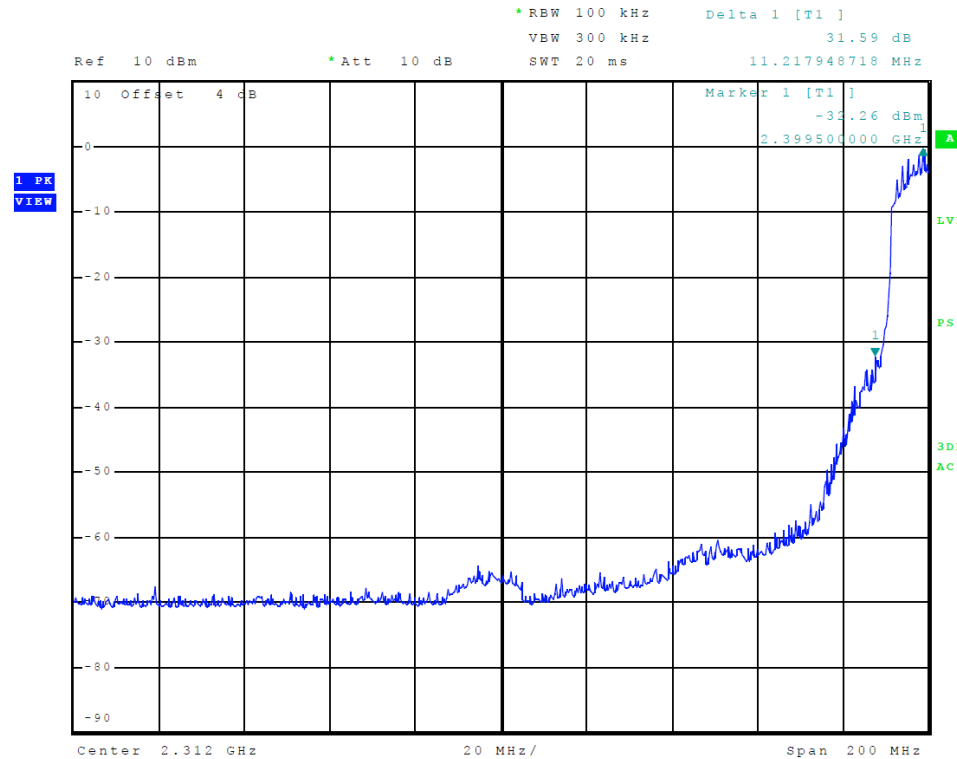

Figure 10 Plot of Lower Band Edge (802.11 n-mode)

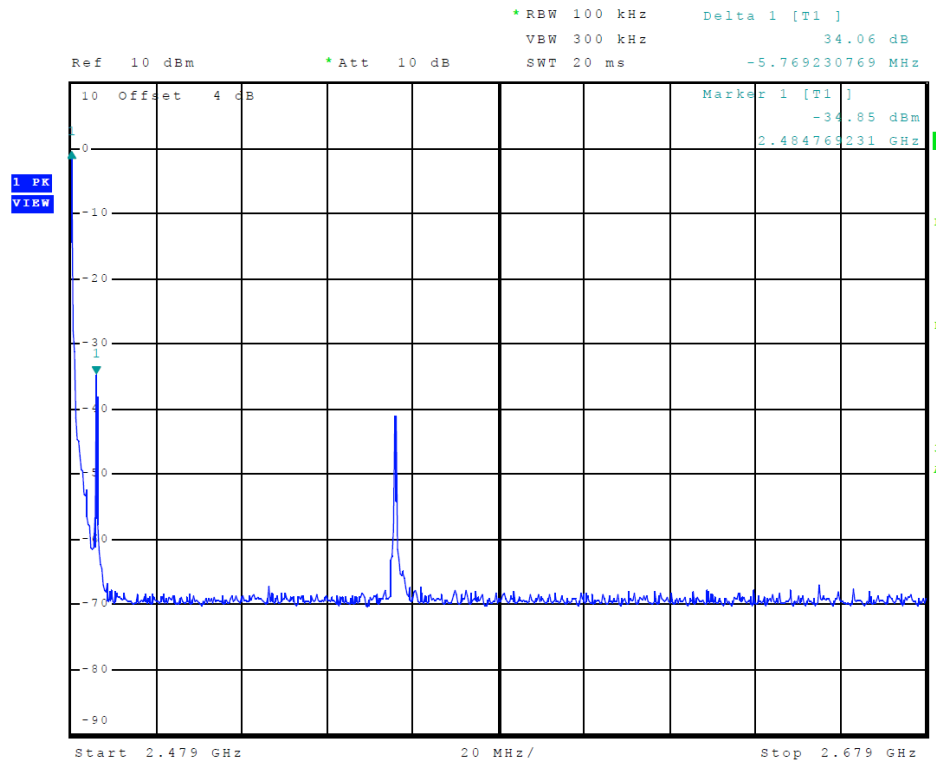

Figure 11 Plot of Transmitter Emissions High Band Edge (GFSK)

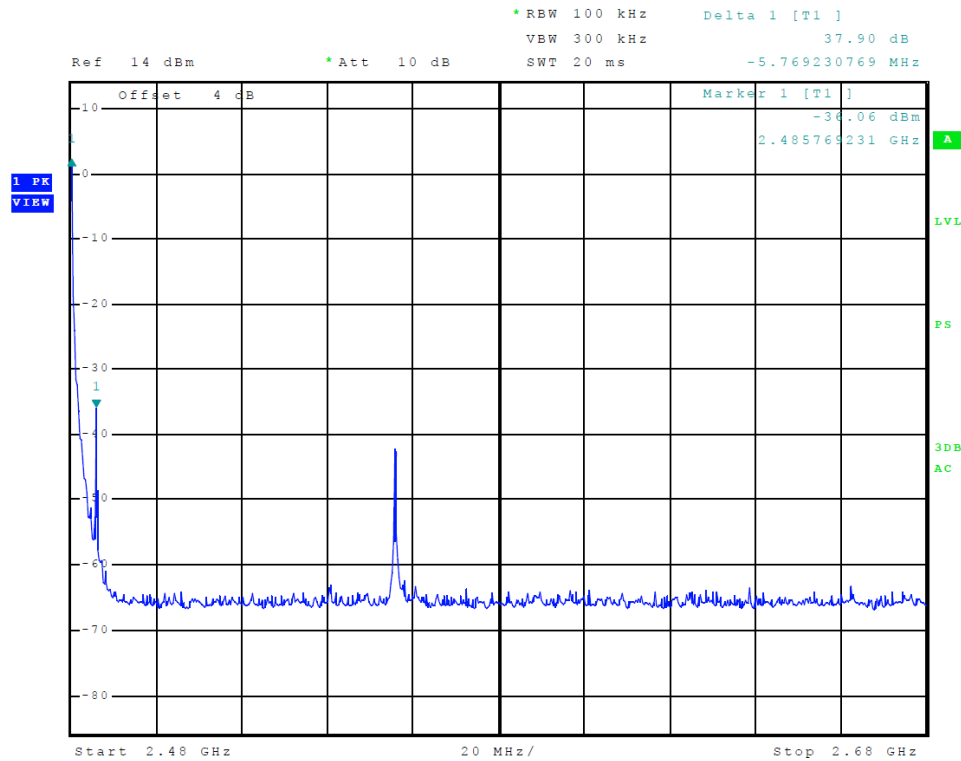

Figure 12 Plot of Transmitter Emissions High Band Edge (GMSK)

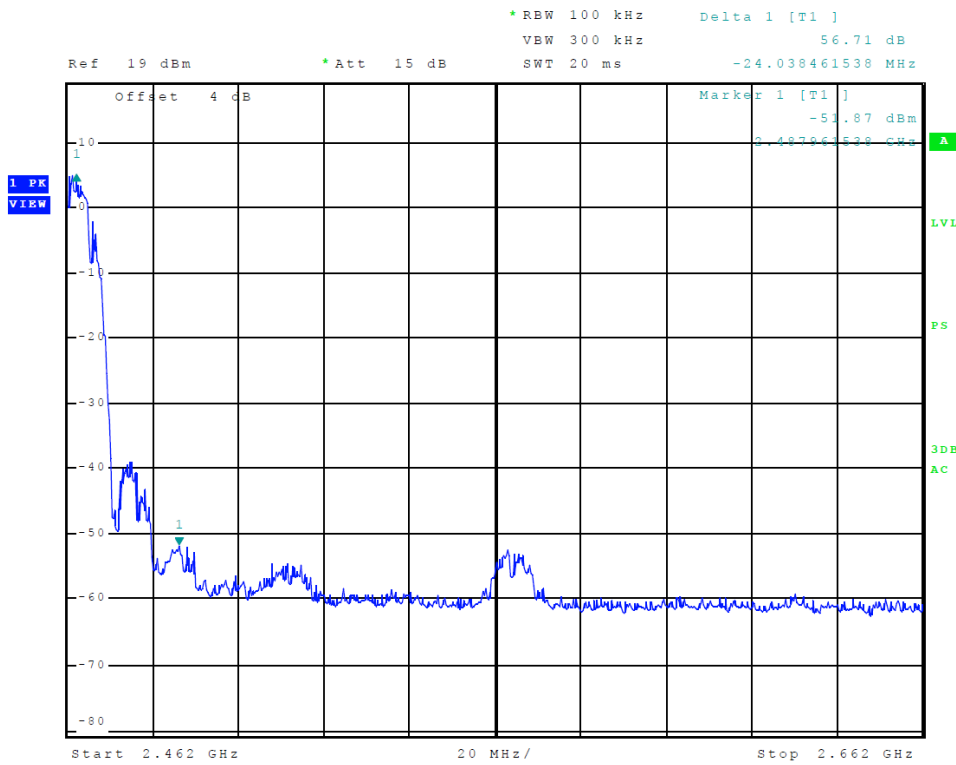

Figure 13 Plot of Upper Band Edge (802.11 b-mode)

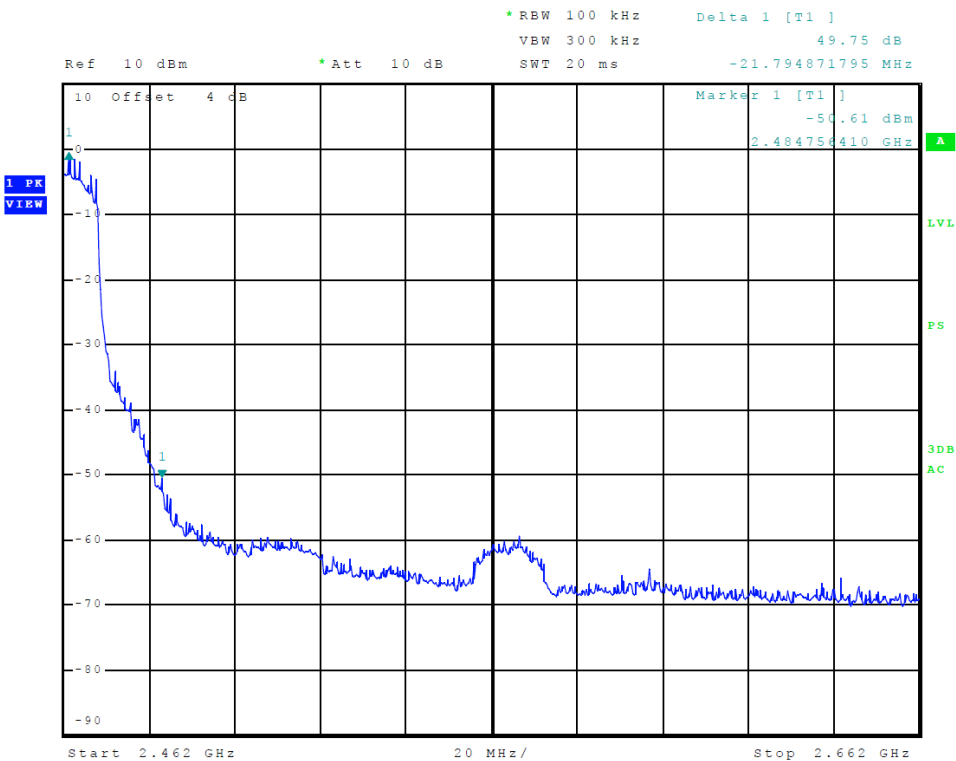

Figure 14 Plot of Upper Band Edge (802.11 g-mode)

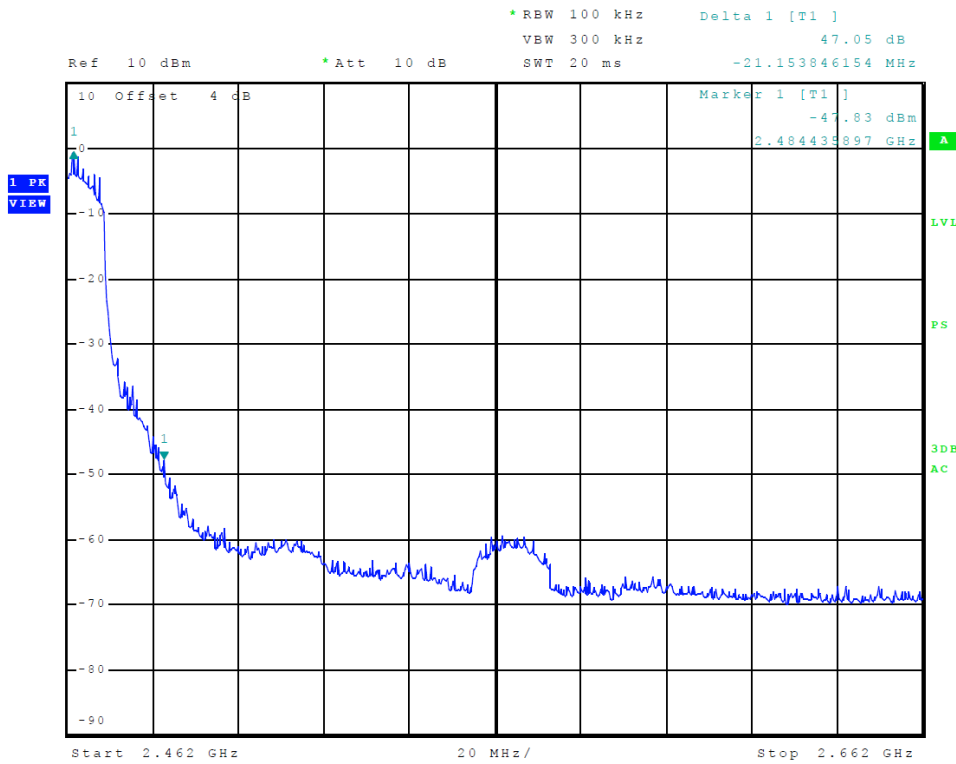

Figure 15 Plot of Upper Band Edge (802.11 n-mode)

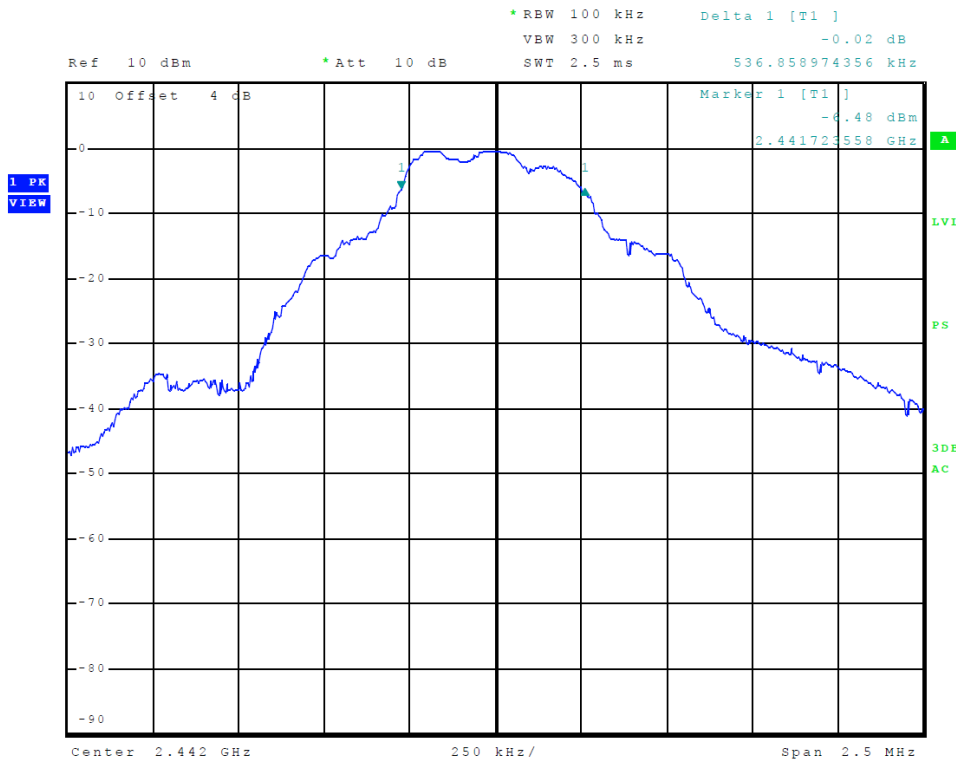

Figure 16 Plot of Transmitter Emissions 6-dB Occupied Bandwidth (GFSK)

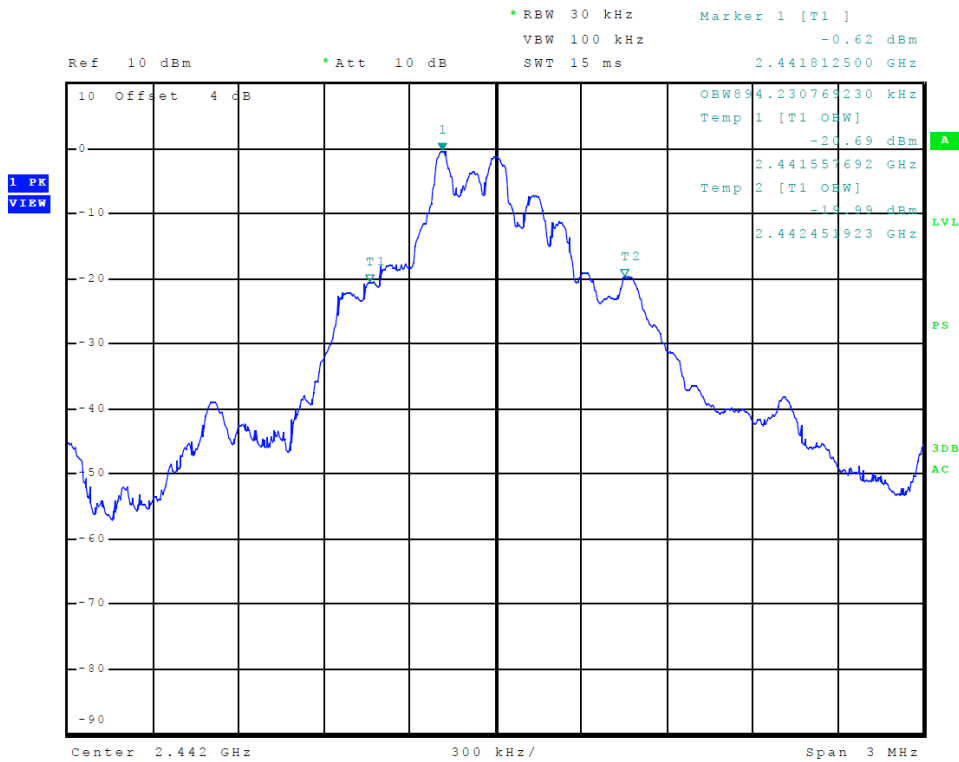

Figure 17 Plot of Transmitter Emissions 99% Occupied Bandwidth (GFSK)

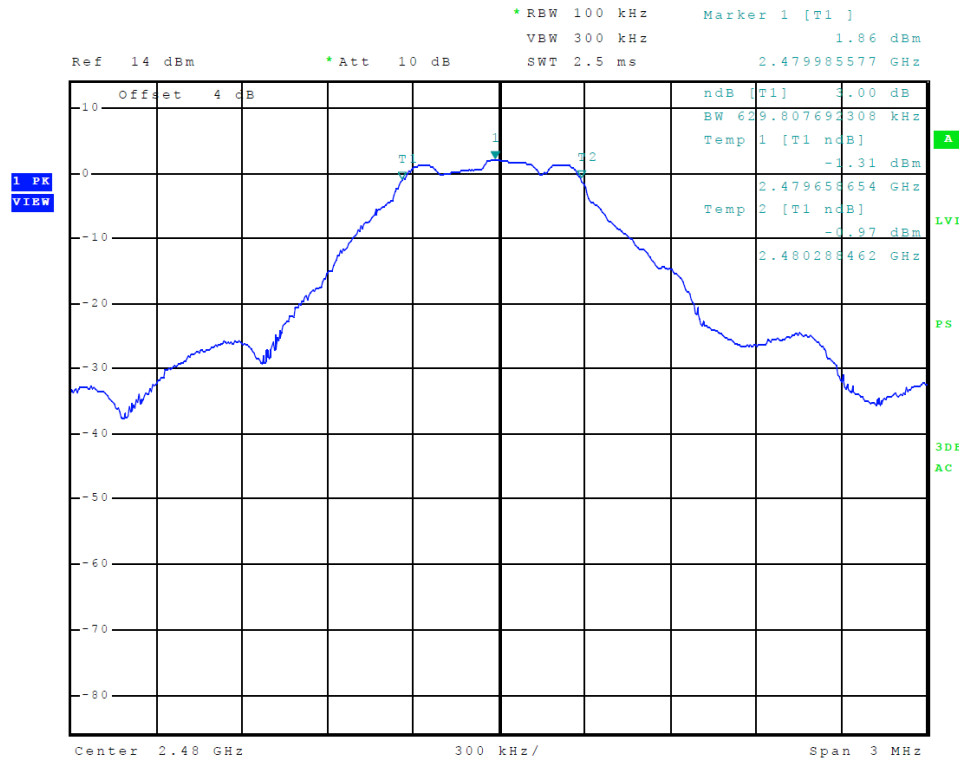

Figure 18 Plot of Transmitter Emissions 6-dB Occupied Bandwidth (GMSK)

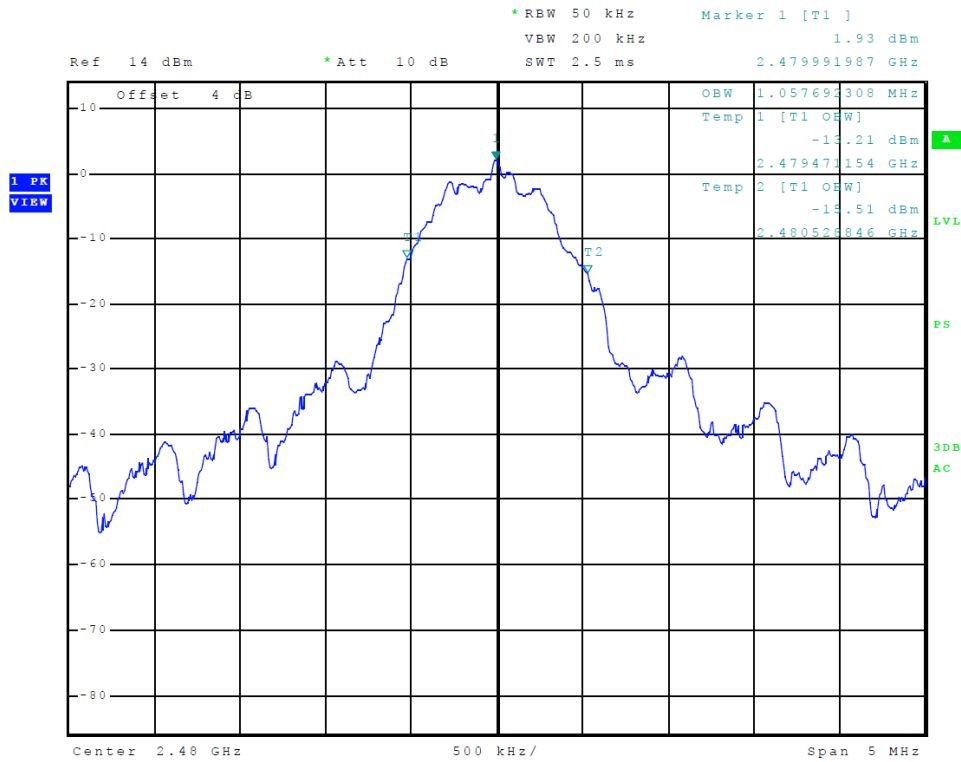

Figure 19 Plot of Transmitter Emissions 99% Occupied Bandwidth (GMSK)

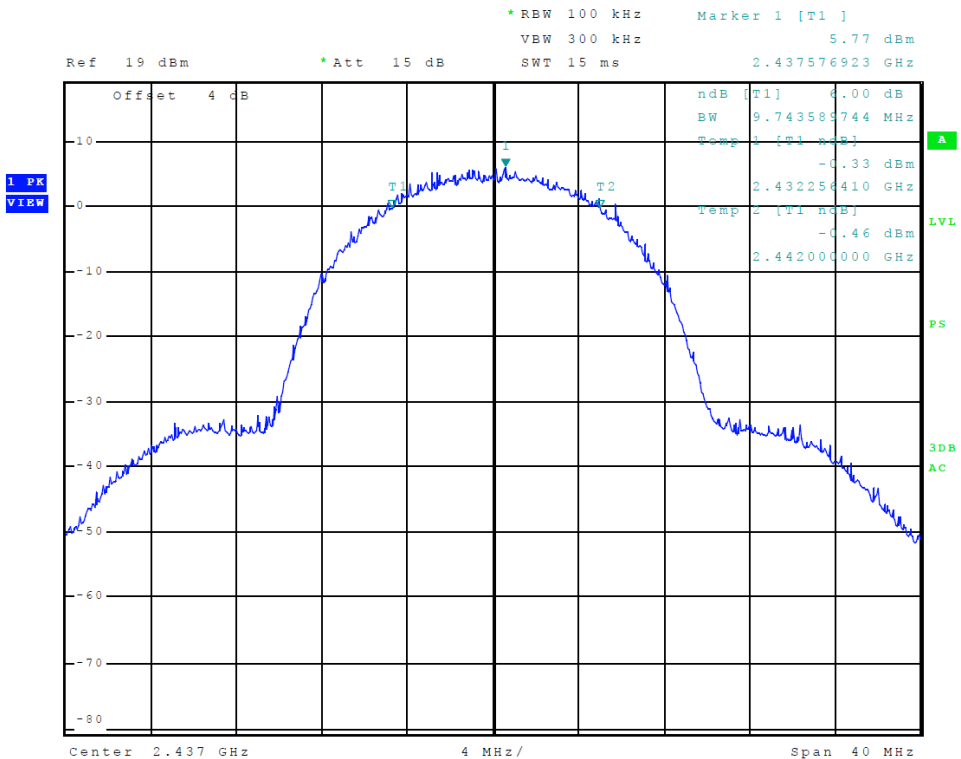

Figure 20 Plot of Transmitter 6-dB Occupied Bandwidth (802.11 b-mode)

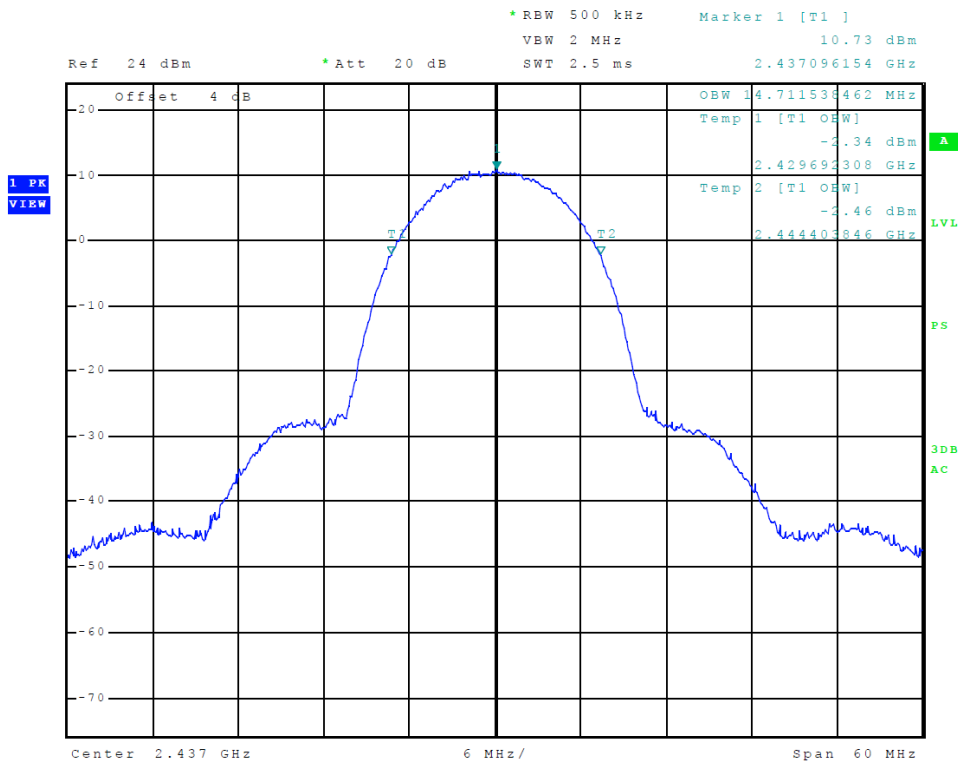

Figure 21 Plot of Transmitter 99% Occupied Bandwidth (802.11 b-mode)

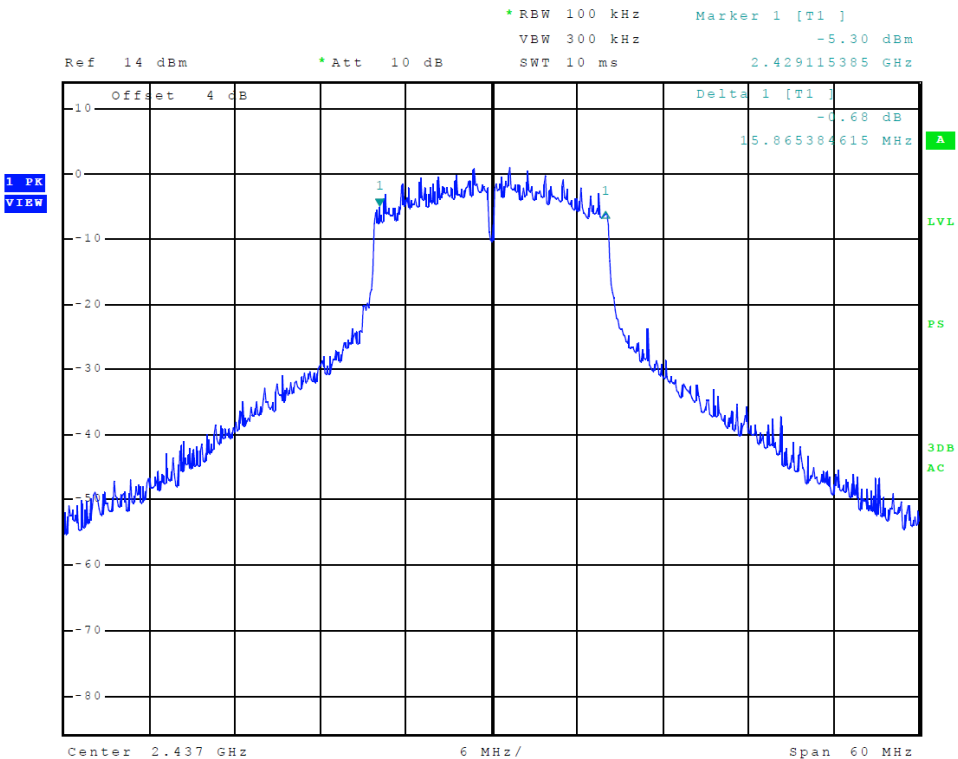

Figure 22 Plot of Transmitter 6-dB Occupied Bandwidth (802.11 g-mode)

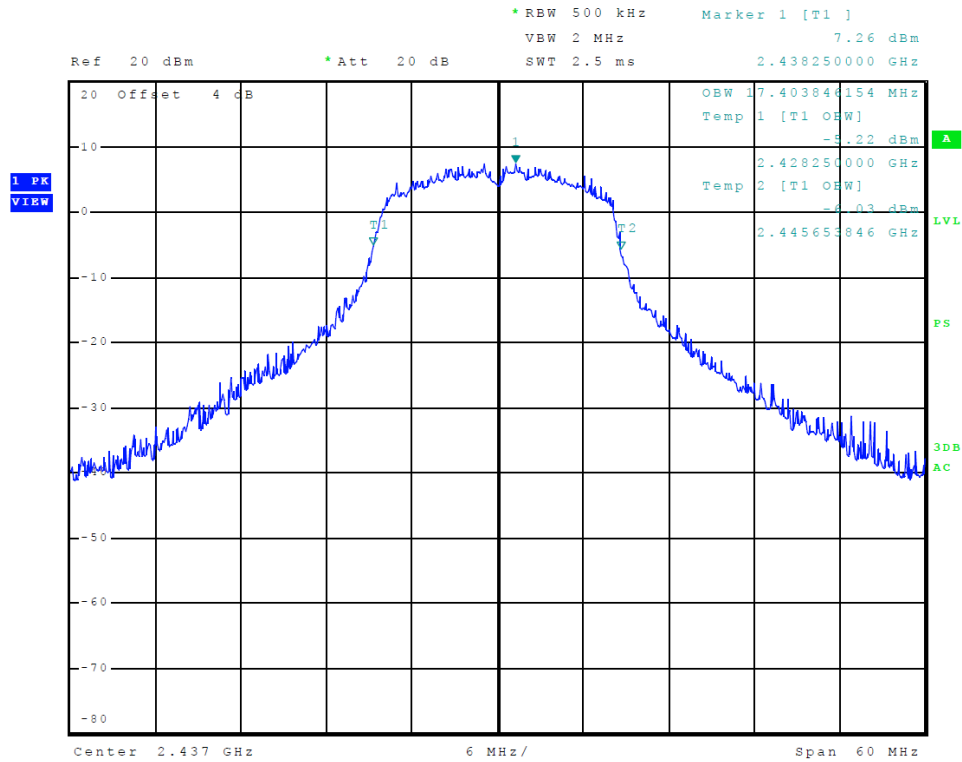

Figure 23 Plot of Transmitter 99% Occupied Bandwidth (802.11 g-mode)

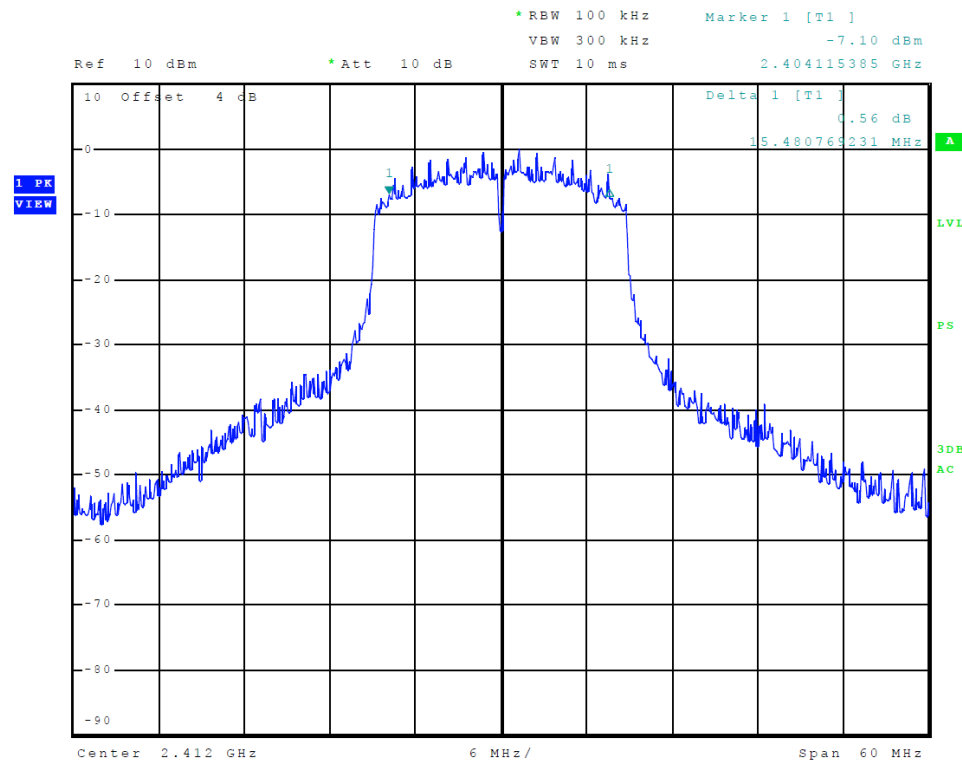

Figure 24 Plot of Transmitter 6-dB Occupied Bandwidth (802.11 n-mode)

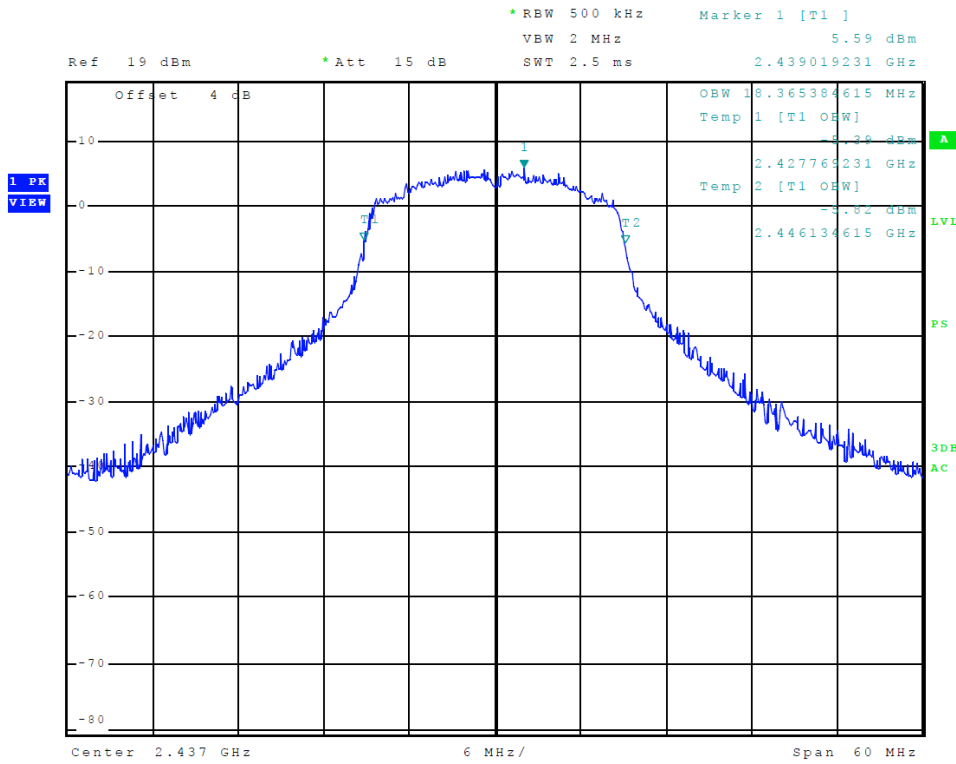

Figure 25 Plot of Transmitter 99% Occupied Bandwidth (802.11 n-mode)

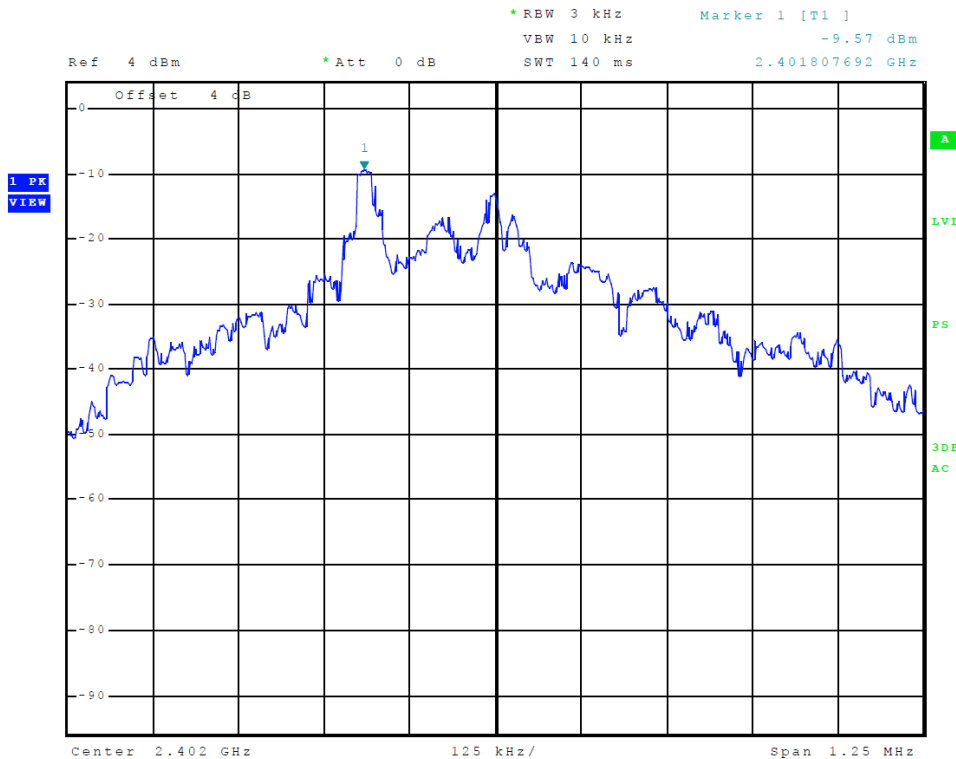

Figure 26 Plot of Transmitter Power Spectral Density (GFSK)

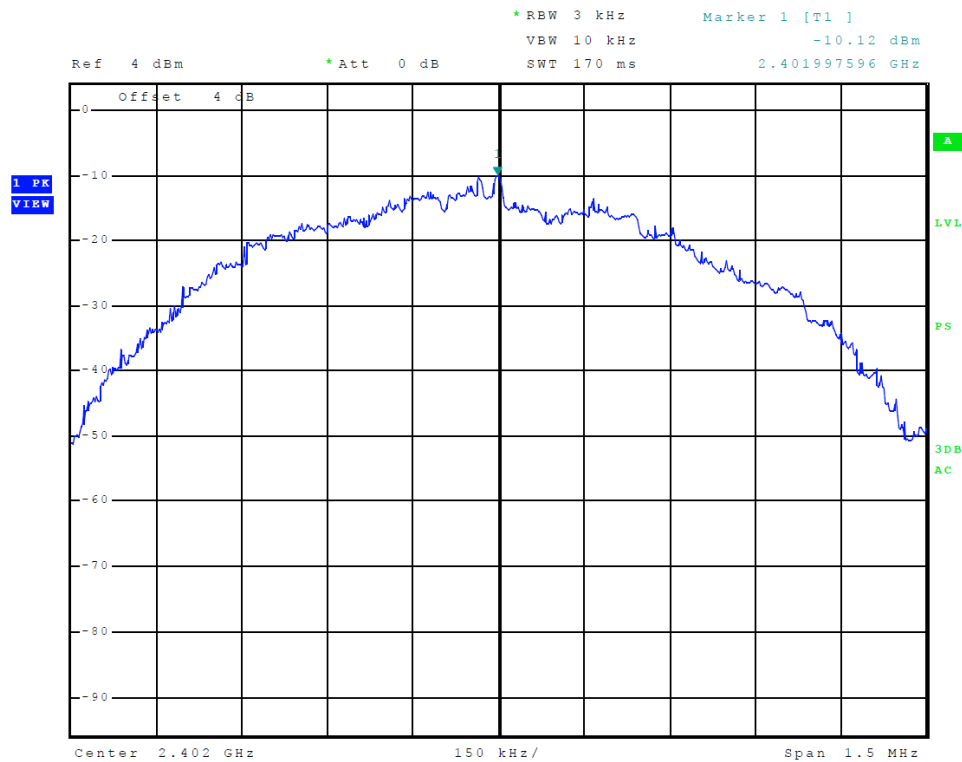

Figure 27 Plot of Transmitter Power Spectral Density (GMSK)

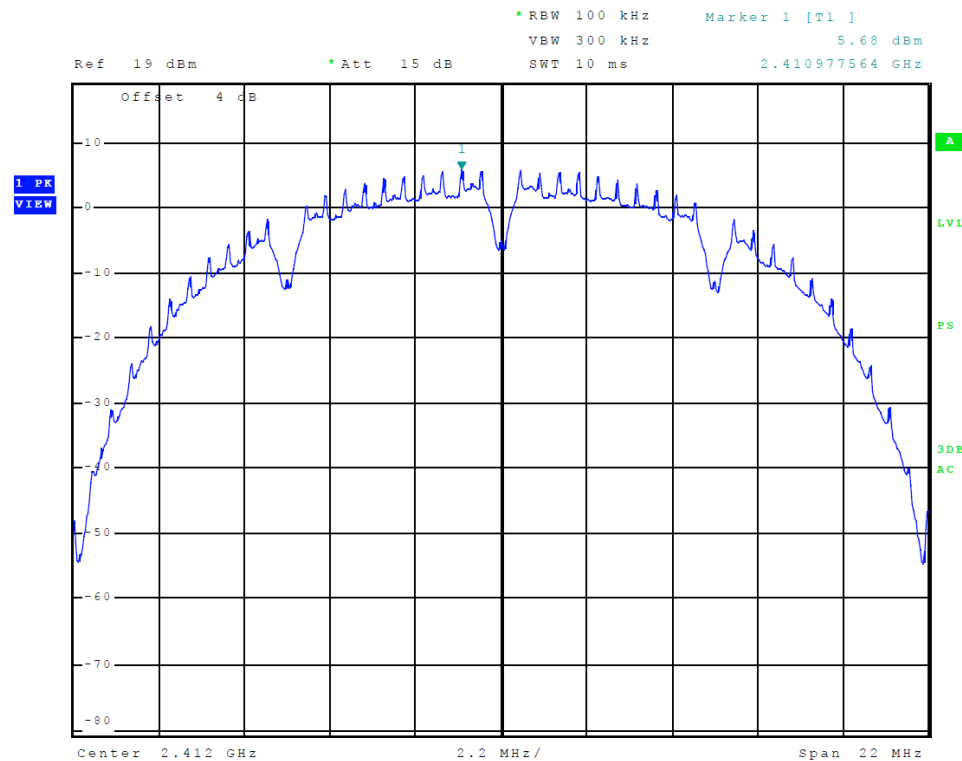

Figure 28 Plot of Transmitter Power Spectral Density (802.11 b-mode)

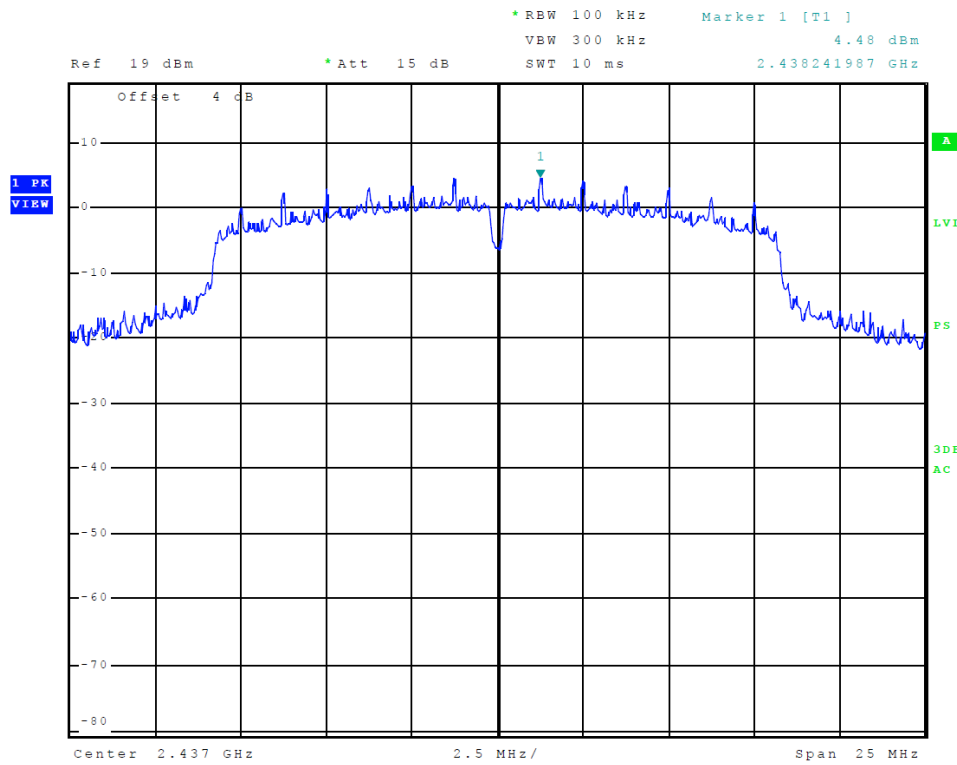

Figure 29 Plot of Transmitter Power Spectral Density (802.11 g-mode)

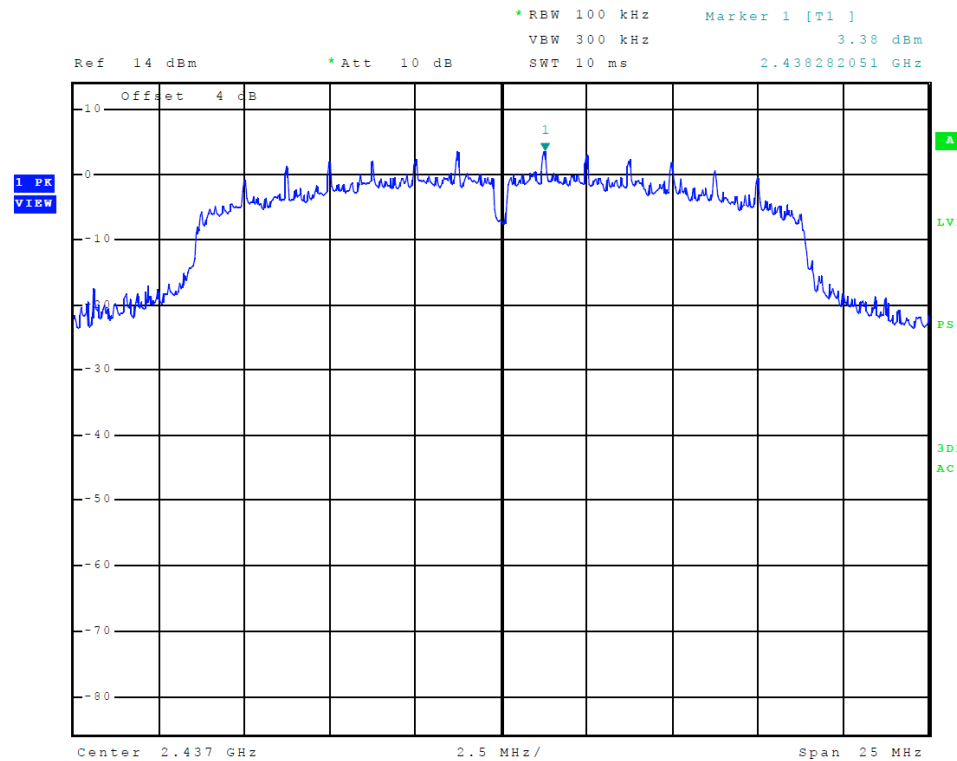

Figure 30 Plot of Transmitter Power Spectral Density (802.11 n-mode)

Transmitter Emissions Data

Table 7 Transmitter Radiated Emissions (GFSK)

Frequency in MHz	Horizontal Peak (dBµV/m)	Horizontal Average (dBµV/m)	Vertical Peak (dBµV/m)	Vertical Average (dBµV/m)	Limit @ 3m (dBµV/m)
2402.0	--	--	--	--	--
4804.0	67.5	39.6	53.3	34.6	54.0
7206.0	50.5	37.8	50.3	37.8	54.0
9608.0	54.9	41.3	53.6	41.3	54.0
12010.0	55.5	43.0	56.1	43.0	54.0
14412.0	57.7	44.6	57.5	44.6	54.0
16814.0	61.0	47.6	60.9	47.9	54.0
2442.0	--	--	--	--	--
4884.0	67.2	39.5	57.4	35.7	54.0
7326.0	51.3	38.2	50.8	38.2	54.0
9768.0	53.4	41.1	54.1	41.1	54.0
12210.0	58.0	44.7	57.6	44.7	54.0
14652.0	59.7	46.3	59.8	46.3	54.0
17094.0	61.3	48.7	62.1	48.6	54.0
2479.0	--	--	--	--	--
4958.0	50.3	34.3	47.0	33.9	54.0
7437.0	51.5	38.2	51.4	38.2	54.0
9916.0	53.8	41.1	54.7	41.1	54.0
12395.0	56.6	44.0	57.5	44.1	54.0
14874.0	59.2	46.3	59.0	46.3	54.0
17353.0	61.7	48.1	60.5	48.1	54.0

Other emissions present had amplitudes at least 20 dB below the limit. Peak and Quasi-Peak amplitude emissions are recorded for frequency range below 1000 MHz. Peak and Average amplitude emissions are recorded for frequency range above 1000 MHz.

Table 8 Transmitter Radiated Emissions (GMSK)

Frequency in MHz	Horizontal Peak (dB μ V/m)	Horizontal Average (dB μ V/m)	Vertical Peak (dB μ V/m)	Vertical Average (dB μ V/m)	Limit @ 3m (dB μ V/m)
2402.0	--	--	--	--	--
4804.0	62.2	51.6	61.7	51.0	54.0
7206.0	52.4	39.9	53.0	40.1	54.0
9608.0	54.0	41.2	54.7	41.3	54.0
12010.0	56.0	43.0	56.5	43.1	54.0
14412.0	57.9	44.6	58.0	44.6	54.0
16814.0	61.2	48.2	61.3	48.2	54.0
2440.0	--	--	--	--	--
4880.0	62.5	53.6	57.1	48.6	54.0
7320.0	53.2	40.4	55.0	42.7	54.0
9760.0	54.6	41.2	53.8	41.2	54.0
12200.0	57.7	44.8	57.9	44.8	54.0
14640.0	59.2	46.4	60.1	46.3	54.0
17080.0	61.5	48.6	61.6	48.6	54.0
2480.0	--	--	--	--	--
4960.0	56.6	47.3	54.6	43.2	54.0
7440.0	53.2	40.6	52.9	39.9	54.0
9920.0	54.2	41.1	54.5	41.1	54.0
12400.0	56.6	44.0	56.4	44.0	54.0
14880.0	59.9	46.3	59.1	46.2	54.0
17360.0	61.1	48.2	61.0	48.2	54.0

Other emissions present had amplitudes at least 20 dB below the limit. Peak and Quasi-Peak amplitude emissions are recorded for frequency range below 1000 MHz. Peak and Average amplitude emissions are recorded for frequency range above 1000 MHz.

Table 9 Transmitter Radiated Emission Worst-case Data 802.11b

Frequency in MHz	Horizontal Peak (dB μ V/m)	Horizontal Average (dB μ V/m)	Vertical Peak (dB μ V/m)	Vertical Average (dB μ V/m)	Limit @ 3m (dB μ V/m)
2412.0	--	--	--	--	--
4824.0	49.8	36.3	50.3	40.8	54.0
7236.0	51.1	37.7	51.7	37.8	54.0
9648.0	54.2	41.2	54.2	41.2	54.0
12060.0	56.6	43.4	56.6	43.2	54.0
14472.0	58.1	44.9	57.7	44.8	54.0
16884.0	61.2	48.0	60.6	48.0	54.0
2437.0	--	--	--	--	--
4874.0	47.7	36.0	48.2	35.4	54.0
7311.0	51.7	38.9	51.9	38.9	54.0
9748.0	53.5	40.7	54.0	40.8	54.0
12185.0	58.2	45.4	58.7	45.4	54.0
14622.0	60.0	47.1	60.0	47.1	54.0
17059.0	62.4	49.6	62.3	49.7	54.0
2462.0	--	--	--	--	--
4924.0	48.8	37.2	51.0	42.1	54.0
7386.0	51.2	38.2	51.9	38.2	54.0
9848.0	54.7	41.7	54.4	41.4	54.0
12310.0	57.9	45.2	58.4	45.2	54.0
14772.0	59.9	46.4	59.4	46.5	54.0
17234.0	61.7	49.0	61.6	49.1	54.0

Other emissions present had amplitudes at least 20 dB below the limit. Peak and Quasi-Peak amplitude emissions are recorded for frequency below 1000 MHz. Peak and Average amplitude emissions are recorded for frequency range above 1000 MHz.

Table 10 Transmitter Radiated Emission Worst-case Data 802.11g

Frequency in MHz	Horizontal Peak (dB μ V/m)	Horizontal Average (dB μ V/m)	Vertical Peak (dB μ V/m)	Vertical Average (dB μ V/m)	Limit @ 3m (dB μ V/m)
2412.0	--	--	--	--	--
4824.0	47.6	34.3	47.8	34.6	54.0
7236.0	50.5	37.8	50.5	37.8	54.0
9648.0	54.3	41.1	54.3	41.2	54.0
12060.0	56.3	43.2	56.1	43.1	54.0
14472.0	57.4	44.8	58.3	44.7	54.0
16884.0	61.6	48.1	60.6	48.0	54.0
2437.0	--	--	--	--	--
4874.0	47.8	34.8	48.7	35.4	54.0
7311.0	51.3	38.6	51.6	38.6	54.0
9748.0	54.7	41.7	54.0	41.3	54.0
12185.0	58.5	45.0	58.0	45.0	54.0
14622.0	59.1	46.2	59.2	46.2	54.0
17059.0	62.3	49.5	62.5	49.5	54.0
2462.0	--	--	--	--	--
4924.0	47.4	34.3	47.3	34.4	54.0
7386.0	51.6	38.2	51.3	38.2	54.0
9848.0	54.2	41.6	54.5	41.3	54.0
12310.0	58.2	45.2	59.0	45.3	54.0
14772.0	60.2	46.5	59.8	46.4	54.0
17234.0	62.0	49.2	62.5	49.1	54.0

Other emissions present had amplitudes at least 20 dB below the limit. Peak and Quasi-Peak amplitude emissions are recorded for frequency below 1000 MHz. Peak and Average amplitude emissions are recorded for frequency range above 1000 MHz.

Table 11 Transmitter Radiated Emission Worst-case Data 802.11n

Frequency in MHz	Horizontal Peak (dB μ V/m)	Horizontal Average (dB μ V/m)	Vertical Peak (dB μ V/m)	Vertical Average (dB μ V/m)	Limit @ 3m (dB μ V/m)
2412.0	--	--	--	--	--
4824.0	48.1	34.4	47.7	34.5	54.0
7236.0	50.6	37.8	51.0	37.8	54.0
9648.0	54.7	41.2	54.7	41.2	54.0
12060.0	56.7	43.4	56.6	43.6	54.0
14472.0	58.1	44.9	58.1	45.1	54.0
16884.0	61.0	48.1	61.4	48.2	54.0
2437.0	--	--	--	--	--
4874.0	48.0	35.0	48.1	35.2	54.0
7311.0	52.1	38.7	51.7	38.5	54.0
9748.0	54.6	41.7	54.4	41.4	54.0
12185.0	57.8	45.0	58.1	45.0	54.0
14622.0	59.4	46.3	59.1	46.5	54.0
17059.0	62.5	49.5	62.6	49.3	54.0
2462.0	--	--	--	--	--
4924.0	47.3	34.3	47.4	34.4	54.0
7386.0	52.0	38.4	51.1	38.3	54.0
9848.0	54.8	41.4	54.7	41.4	54.0
12310.0	58.3	45.2	58.5	45.2	54.0
14772.0	59.8	46.6	59.3	46.6	54.0
17234.0	62.2	49.3	61.6	49.0	54.0

Other emissions present had amplitudes at least 20 dB below the limit. Peak and Quasi-Peak amplitude emissions are recorded for frequency below 1000 MHz. Peak and Average amplitude emissions are recorded for frequency range above 1000 MHz.

Table 12 Transmitter Antenna Port Data

Frequency MHz	Antenna Port Output Peak / Average (Watts)	99% Occupied Bandwidth (kHz)	6-dB Occupied Bandwidth (kHz)	Peak Power Spectral Density (dBm)
GFSK				
2402.0	0.001 / 0.001	884.6	524.8	-9.6
2442.0	0.001 / 0.001	894.2	536.9	-9.8
2479.0	0.001 / 0.001	889.4	512.8	-9.9
GMSK				
2402.0	0.002 / 0.002	1041.7	625.0	-10.1
2442.0	0.002 / 0.002	1033.7	620.2	-10.4
2480.0	0.002 / 0.002	1057.7	629.8	-11.4
802.11b				
2412	0.044 / 0.024	14,711.5	9,294.9	5.7
2437	0.038 / 0.023	14,711.5	9,743.6	5.6
2462	0.042 / 0.026	14,711.5	9,551.3	5.3
802.11g				
2412	0.032 / 0.009	16,730.8	15,576.9	-1.2
2437	0.044 / 0.026	17,403.8	15,865.4	4.5
2462	0.027 / 0.008	16,730.8	15,673.1	-1.0
802.11n				
2412	0.035 / 0.009	17,884.6	15,480.8	-0.5
2437	0.044 / 0.022	18,365.4	15,384.6	3.4
2462	0.037 / 0.009	17,884.6	15,480.8	-1.0

Summary of Results for Transmitter Radiated Emissions of Intentional Radiator

The EUT demonstrated compliance with the radiated and conducted emission requirements of 47CFR Part 15.247, RSS-GEN, and RSS-247 Digital Transmission Systems. Peak Output power of 0.044 Watts was measured at the antenna port and average output power of 0.026 Watts. The peak power spectral density measured at the antenna port presented a minimum margin of -2.3 dB below the requirements. The EUT demonstrated a minimum margin of -0.4 dB below the harmonic emissions requirements. There were no other significantly measurable emissions in the restricted bands other than those recorded in this report. Other emissions were present with amplitudes at least 20 dB below the requirements. There were no other deviations or exceptions to the requirements.

Annex

- Annex A Measurement Uncertainty Calculations
- Annex B Additional Test Equipment List
- Annex C Rogers Qualifications
- Annex D Rogers Labs Certificate of Accreditation

Annex A Measurement Uncertainty Calculations

The measurement uncertainty was calculated for all measurements listed in this test report according To CISPR 16-4. Result of measurement uncertainty calculations are recorded below. Component and process variability of production devices similar to those tested may result in additional deviations. The manufacturer has the sole responsibility of continued compliance.

Measurement	Expanded Measurement Uncertainty $U_{(lab)}$
3 Meter Horizontal 0.009-1000 MHz Measurements	4.16
3 Meter Vertical 0.009-1000 MHz Measurements	4.33
3 Meter Measurements 1-18 GHz	5.14
3 Meter Measurements 18-40 GHz	5.16
10 Meter Horizontal Measurements 0.009-1000 MHz	4.15
10 Meter Vertical Measurements 0.009-1000 MHz	4.32
AC Line Conducted	1.75
Antenna Port Conducted power	1.17
Frequency Stability	1.00E-11
Temperature	1.6°C
Humidity	3%

Annex B Additional Test Equipment List

List of Test Equipment	Calibration	Date (m/d/y)	Due
Antenna: Schwarzbeck Model: BBA 9106/VHBB 9124 (9124-627)		5/2/2018	5/2/2019
Antenna: Schwarzbeck Model: VULP 9118 A (VULP 9118 A-534)		5/2/2018	5/2/2019
Antenna: EMCO 6509		10/24/2016	10/24/2018
Antenna: EMCO 3143 (9607-1277) 20-1200 MHz		5/2/2018	5/2/2019
Antenna: EMCO Dipole Set 3121C		2/23/2018	2/23/2019
Antenna: C.D. B-101		2/23/2018	2/23/2019
Antenna: Solar 9229-1 & 9230-1		2/23/2018	2/23/2019
Cable: Belden 8268 (L3)		10/24/2017	10/24/2018
Cable: Time Microwave: 4M-750HF290-750		10/24/2017	10/24/2018
Frequency Counter: Leader LDC-825 (8060153)		5/2/2018	5/2/2019
Oscilloscope Scope: Tektronix 2230		2/23/2018	2/23/2019
Wattmeter: Bird 43 with Load Bird 8085		2/23/2018	2/23/2019
Power Supplies: Sorensen SRL 20-25, SRL 40-25, DCR 150, DCR 140		2/23/2018	2/23/2019
R.F. Generator: SMB100A6 s/n 100623		5/2/2018	5/2/2019
R.F. Generator: SBMBV100A s/n: 260771		5/2/2018	5/2/2019
R.F. Generators: HP 606A, HP 8614A, HP 8640B		2/23/2018	2/23/2019
R.F. Power Amp 65W Model: 470-A-1010		2/23/2018	2/23/2019
R.F. Power Amp 50W M185- 10-501		2/23/2018	2/23/2019
R.F. Power Amp A.R. Model: 10W 1010M7		2/23/2018	2/23/2019
R.F. Power Amp EIN Model: A301		2/23/2018	2/23/2019
LISN: Compliance Eng. Model 240/20		5/2/2018	5/2/2019
LISN: Fischer Custom Communications Model: FCC-LISN-50-16-2-08		5/2/2018	5/2/2019
Audio Oscillator: H.P. 201CD		2/23/2018	2/23/2019
ESD Test Set 2010i		2/23/2018	2/23/2019
Oscilloscope Scope: Tektronix MDO 4104		2/23/2018	2/23/2019
EMC Transient Generator HVT TR 3000		2/23/2018	2/23/2019
AC Power Source (Ametech, California Instruments)		2/23/2018	2/23/2019
Fast Transient Burst Generator Model: EFT/B-101		2/23/2018	2/23/2019
Field Intensity Meter: EFM-018		2/23/2018	2/23/2019
KEYTEK Ecat Surge Generator		2/23/2018	2/23/2019
ESD Simulator: MZ-15		2/23/2018	2/23/2019
Shielded Room not required			

Rogers Labs, Inc.
4405 W. 259th Terrace
Louisburg, KS 66053
Phone/Fax: (913) 837-3214
Revision 1

Garmin International, Inc.
Model: A03608
Test #: 180905
Test to: CFR47 15C, RSS-Gen RSS-247
File: A03608 DTS TstRpt 180905

SN's: 39771 86171 / 39771 86163
FCC ID: IPH-03608
IC: 1792A-03608
Date: October 29, 2018
Page 49 of 51

Annex C Rogers Qualifications

Scot D. Rogers, Engineer

Rogers Labs, Inc.

Mr. Rogers has approximately 27 years' experience in the field of electronics. Engineering experience includes six years in the automated controls industry and remaining years working with the design, development and testing of radio communications and electronic equipment.

Positions Held

Systems Engineer: A/C Controls Mfg. Co., Inc. 6 Years

Electrical Engineer: Rogers Consulting Labs, Inc. 5 Years

Electrical Engineer: Rogers Labs, Inc. Current

Educational Background

- 1) Bachelor of Science Degree in Electrical Engineering from Kansas State University.
- 2) Bachelor of Science Degree in Business Administration Kansas State University.
- 3) Several Specialized Training courses and seminars pertaining to Microprocessors and Software programming.

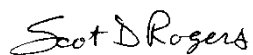

Scot D. Rogers

Annex D Rogers Labs Certificate of Accreditation

<p>United States Department of Commerce National Institute of Standards and Technology</p> <p>NVLAP®</p> <hr/> <p>Certificate of Accreditation to ISO/IEC 17025:2005</p> <hr/> <p>NVLAP LAB CODE: 200087-0</p> <p>Rogers Labs, Inc. Louisburg, KS</p> <p><i>is accredited by the National Voluntary Laboratory Accreditation Program for specific services, listed on the Scope of Accreditation, for:</i></p> <p>Electromagnetic Compatibility & Telecommunications</p> <p><i>This laboratory is accredited in accordance with the recognized International Standard ISO/IEC 17025:2005. This accreditation demonstrates technical competence for a defined scope and the operation of a laboratory quality management system (refer to joint ISO-ILAC-IAF Communique dated January 2009).</i></p> <hr/> <p>2018-02-21 through 2019-03-31 Effective Dates</p> <p style="text-align: center;"></p> <p style="text-align: right;"> For the National Voluntary Laboratory Accreditation Program</p>	
---	--

Rogers Labs, Inc.
4405 W. 259th Terrace
Louisburg, KS 66053
Phone/Fax: (913) 837-3214
Revision 1

Garmin International, Inc.
Model: A03608
Test #: 180905
Test to: CFR47 15C, RSS-Gen RSS-247
File: A03608 DTS TstRpt 180905

SN's: 39771 86171 / 39771 86163
FCC ID: IPH-03608
IC: 1792A-03608
Date: October 29, 2018
Page 51 of 51