

# Application For Grant of Certification

Model: A03562  
2402-2480 MHz  
47 CFR 15.249 and RSS-210  
Low Power Transmitter

FCC ID: IPH-03562  
IC: 1792A-03562

FOR

## Garmin International, Inc.

1200 East 151st Street  
Olathe, KS 66062

FCC Designation: US5305  
IC Test Site Registration: 3041A-1  
Test Report Number: 180904

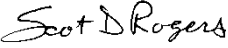
Authorized Signatory:   
Scot D. Rogers

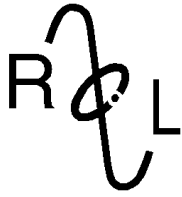

## **ROGERS LABS, INC.**

4405 West 259<sup>th</sup> Terrace  
Louisburg, KS 66053  
Phone / Fax (913) 837-3214

# Engineering Test Report For Grant of Certification Application

for  
47 CFR, PART 15C - Intentional Radiators Paragraph 15.249,  
Industry Canada RSS-210 Issue 9, and RSS-GEN Issue 5  
License Exempt Intentional Radiator

For  
**Garmin International, Inc.**

1200 East 151st Street  
Olathe, KS 66062

Model: A03562

**Low Power Transmitter**

Frequency Range 2402-2480 MHz  
FCC ID: IPH-03562  
IC: 1792A-03562

Test Date: September 4, 2018

Certifying Engineer: *Scot D. Rogers*  
Scot D. Rogers  
Rogers Labs, Inc.  
4405 West 259<sup>th</sup> Terrace  
Louisburg, KS 66053  
Telephone/Facsimile: (913) 837-3214

This report shall not be reproduced except in full, without the written approval of the laboratory.  
This report must not be used by the client to claim product certification, approval, or  
endorsement by NVLAP, NIST, or any agency of the Federal Government.

Rogers Labs, Inc.  
4405 W. 259th Terrace  
Louisburg, KS 66053  
Phone/Fax: (913) 837-3214  
Revision 1

Garmin International, Inc.  
Model: A03562  
Test #: 180904  
Test to: CFR47 15.249, RSS-210, RSS-Gen  
File: A03562 DXX TstRpt 180904

SN's: 984512717 / 39733 09969  
FCC ID: IPH-03562  
IC: 1792A-03562  
Date: October 25, 2018  
Page 2 of 31

## Table of Contents

<b>TABLE OF CONTENTS.....</b>	<b>3</b>
<b>REVISIONS.....</b>	<b>5</b>
<b>FOREWORD.....</b>	<b>6</b>
<b>OPINION / INTERPRETATION OF RESULTS .....</b>	<b>6</b>
<b>EQUIPMENT TESTED.....</b>	<b>6</b>
<b>EQUIPMENT FUNCTION AND CONFIGURATION.....</b>	<b>7</b>
<b>Equipment Configuration.....</b>	<b>8</b>
<b>APPLICATION FOR CERTIFICATION.....</b>	<b>9</b>
<b>APPLICABLE STANDARDS &amp; TEST PROCEDURES .....</b>	<b>10</b>
<b>TESTING PROCEDURES .....</b>	<b>10</b>
<b>AC Line Conducted Emission Test Procedure .....</b>	<b>10</b>
<b>Radiated Emission Test Procedure.....</b>	<b>10</b>
Diagram 1 Test arrangement for radiated emissions of tabletop equipment.....	11
Diagram 2 Test arrangement for radiated emissions tested on Open Area Test Site (OATS).....	12
<b>TEST SITE LOCATIONS .....</b>	<b>12</b>
<b>LIST OF TEST EQUIPMENT .....</b>	<b>13</b>
<b>UNITS OF MEASUREMENTS .....</b>	<b>14</b>
<b>ENVIRONMENTAL CONDITIONS.....</b>	<b>14</b>
<b>STATEMENT OF MODIFICATIONS AND DEVIATIONS .....</b>	<b>14</b>
<b>INTENTIONAL RADIATORS.....</b>	<b>14</b>
<b>Antenna Requirements .....</b>	<b>14</b>
<b>Restricted Bands of Operation.....</b>	<b>15</b>

Table 1 Radiated Emissions in Restricted Frequency Bands Data (GFSK) .....15

Table 2 Radiated Emissions in Restricted Frequency Bands Data (GMSK) .....16

**Summary of Results for Radiated Emissions in Restricted Bands .....16**

**General Radiated Emissions Procedure.....17**

Table 3 General Radiated Emissions Data .....18

**Summary of Results for General Radiated Emissions .....18**

**Operation in the Band 2400 – 2483.5 MHz .....19**

Figure 1 Plot of Transmitter Emissions Operation in 2402-2480 MHz (GFSK) .....20

Figure 2 Plot of Transmitter Emissions Operation in 2402-2480 MHz (GMSK).....20

Figure 3 Plot of Transmitter Emissions 99% Occupied Bandwidth (GFSK) .....21

Figure 4 Plot of Transmitter Emissions 99% Occupied Bandwidth (GMSK) .....21

Figure 5 Plot of Transmitter Emissions Low Band Edge (GFSK).....22

Figure 6 Plot of Transmitter Emissions Low Band Edge (GMSK) .....22

Figure 7 Plot of Transmitter Emissions High Band Edge (GFSK).....23

Figure 8 Plot of Transmitter Emissions High Band Edge (GMSK).....23

**Transmitter Emissions Data.....24**

Table 4 Transmitter Radiated Emissions (GFSK) .....24

Table 5 Transmitter Radiated Emissions (GMSK) .....25

**Summary of Results for Transmitter Radiated Emissions of Intentional Radiator.....26**

**ANNEX..... 27**

**Annex A Measurement Uncertainty Calculations.....28**

**Annex B Rogers Labs Additional Test Equipment List.....29**

**Annex C Rogers Qualifications .....30**

**Annex D Rogers Labs Certificate of Accreditation.....31**



## Revisions

Revision 1 Issued October 25, 2018

Rogers Labs, Inc.  
4405 W. 259th Terrace  
Louisburg, KS 66053  
Phone/Fax: (913) 837-3214  
Revision 1

Garmin International, Inc.  
Model: A03562  
Test #: 180904  
Test to: CFR47 15.249, RSS-210, RSS-Gen  
File: A03562 DXX TstRpt 180904

SN's: 984512717 / 39733 09969  
FCC ID: IPH-03562  
IC: 1792A-03562  
Date: October 25, 2018  
Page 5 of 31

## Foreword

The following information is submitted for consideration in obtaining Grant of Certification for low power intentional radiator per 47 CFR Paragraph 15.249, Industry Canada RSS-210 Issue 9 and RSS-GEN Issue 5, low power digital device transmitter operations in the 2400 – 2483.5 MHz frequency band.

Name of Applicant: Garmin International, Inc.  
1200 East 151st Street  
Olathe, KS 66062

M/N: A03562

FCC ID: IPH-03562 IC: 1792A-03562

Operating Frequency Range: 2402-2480 MHz

ANT (GFSK) Average power of 66.1 dB $\mu$ V/m @ 3, (peak 98.6 dB $\mu$ V/m, OBW, 899.0 kHz)

BLE (GMSK) Average power of 93.6 dB $\mu$ V/m @ 3, (peak 97.8 dB $\mu$ V/m, OBW, 1033.7 kHz)

## Opinion / Interpretation of Results

Tests Performed	Margin (dB)	Results
Restricted Bands 47 CFR 15.205, RSS-210 2.2	-6.0	Complies
AC Line Conducted 47 CFR 15.207, RSS-GEN 8.8	N/A	Complies
Radiated Emissions 47 CFR 15.209, RSS-GEN 8.9	-3.6	Complies
Harmonic Emissions per 47 CFR 15.249, RSS-210 A2.9	-5.0	Complies

## Equipment Tested

<u>Equipment</u>	<u>Model / PN</u>	<u>Serial Number</u>
EUT	A03562	984512717
EUT#2	A03562	39733 09969
Interface cables	Manufacturer provided	N/A
DC Power Supply	Sorensen / SR40-25	1639

Test results in this report relate only to the items tested

Rogers Labs, Inc.  
4405 W. 259th Terrace  
Louisburg, KS 66053  
Phone/Fax: (913) 837-3214  
Revision 1

Garmin International, Inc.  
Model: A03562  
Test #: 180904  
Test to: CFR47 15.249, RSS-210, RSS-Gen  
File: A03562 DXX TstRpt 180904

SN's: 984512717 / 39733 09969  
FCC ID: IPH-03562  
IC: 1792A-03562  
Date: October 25, 2018  
Page 6 of 31

## Equipment Function and Configuration

The EUT is a marine mounted GPS enabled display for use in the maritime environment. The design incorporates transmitters with operation capability across the 2402-2480 MHz frequency band. This design provides communications operation in two modes across the 2402-2480 MHz band. The unit provides low power transmitter function across the 2402-2480 MHz band as well as higher power Digital Transmission System (DTS) operating across reduced frequency band of 2412-2462 MHz. The DTS system provides peak output power of 49 mW (16.9 dBm) into the antenna system. The design provides wireless communications interface capabilities with compatible equipment. The design is offered in multiple display sizes utilizing electrically identical transmitter circuitry. The product operates from external direct current power only and offers no provision to interface with utility power systems. The design utilizes internal fixed antenna systems and offers no provision for antenna replacement or modification. Two samples were provided for testing, one representative of production design with integral antenna, and the other modified replacing the integral antenna with RF connection port for testing purposes. Test samples were provided with test software(version icb\_fw: ver 1.10) enabling testing personnel the ability to enable transmitter functions on defined channels and operational modes. The antenna modification offered testing facility ability to connect test equipment to the temporary antenna port for antenna port conducted emission testing. The EUT was arranged as described by the manufacturer for testing purposes. The design provides interface options including connection to transducers providing below surface depth and other information, marine network interfaces, NMEA network interface, micro USB, audio, composite and HDMI video interfaces, and power. The EUT offers no other interface connections than those in the configuration option shown below as described by the manufacturer. For testing purposes, the EUT received power from a bench DC power supply and configured to operate in available modes. As requested by the manufacturer and required by regulations, the equipment was tested for emissions compliance using the available configurations with the worst-case data presented. Test results in this report relate only to the products described in this report.

## Equipment Configuration

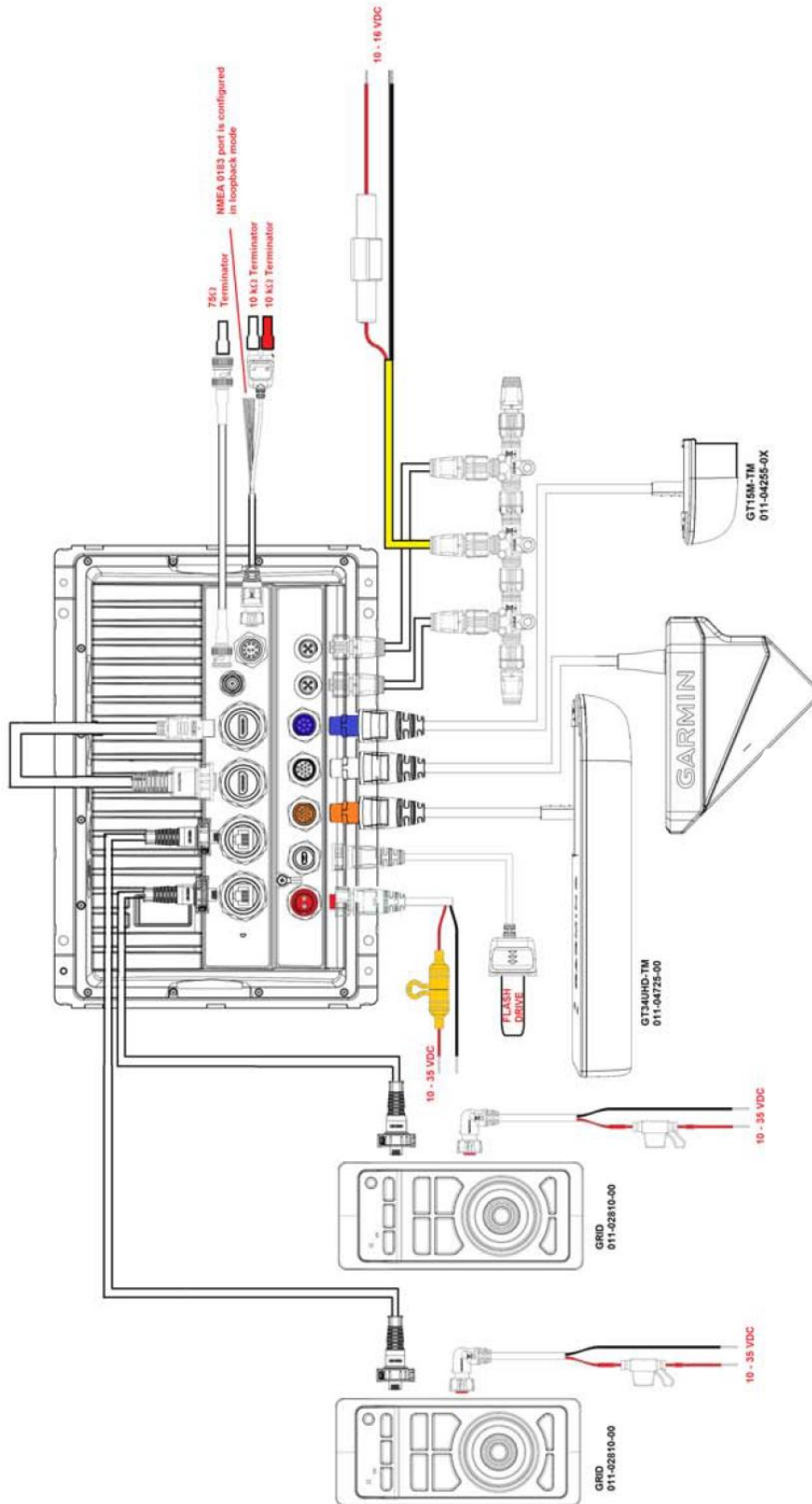

Rogers Labs, Inc.  
 4405 W. 259th Terrace  
 Louisburg, KS 66053  
 Phone/Fax: (913) 837-3214  
 Revision 1

Garmin International, Inc.  
 Model: A03562  
 Test #: 180904  
 Test to: CFR47 15.249, RSS-210, RSS-Gen  
 File: A03562 DXX TstRpt 180904

SN's: 984512717 / 39733 09969  
 FCC ID: IPH-03562  
 IC: 1792A-03562  
 Date: October 25, 2018  
 Page 8 of 31



## Application for Certification

- (1) Manufacturer: Garmin International, Inc.  
1200 East 151st Street  
Olathe, KS 66062
- (2) Identification: M/N: A03562  
FCC ID: IPH-03562 IC: 1792A-03562
- (3) Instruction Book:  
Refer to Exhibit for Instruction Manual.
- (4) Description of Circuit Functions:  
Refer to Exhibit of Operational Description.
- (5) Block Diagram with Frequencies:  
Refer to Exhibit of Operational Description.
- (6) Report of Measurements:  
Report of measurements follows in this Report.
- (7) Photographs: Construction, Component Placement, etc.:  
Refer to Exhibit for photographs of equipment.
- (8) List of Peripheral Equipment Necessary for operation. The equipment operates from external direct current power provided from installation vehicle sources. The EUT also provides communication options as documented and presented in this filing.
- (9) Transition Provisions of 47 CFR 15.37 are not requested.
- (10) Not Applicable. The unit is not a scanning receiver.
- (11) Not Applicable. The EUT does not operate in the 59 – 64 GHz frequency band.
- (12) The equipment is not software defined and this section is not applicable.
- (13) Applications for certification of U-NII devices in the 5.15-5.35 GHz and the 5.47-5.85 GHz bands must include a high-level operational description of the security procedures that control the radio frequency operating parameters and ensure that unauthorized modifications cannot be made. This requirement is not applicable to his DTS device.
- (14) Contain at least one drawing or photograph showing the test set-up for each of the required types of tests applicable to the device for which certification is requested. These drawings or photographs must show enough detail to confirm other information contained in the test report. Any photographs used must be focused originals without glare or dark spots and must clearly show the test configuration used. This information is provided in this report and Test Setup Exhibits provided with the application filing.

## Applicable Standards & Test Procedures

In accordance with the e-CFR Code of Federal Regulations Title 47, dated September 4, 2018: Part 2, Subpart J, Paragraphs 2.907, 2.911, 2.913, 2.925, 2.926, 2.1031 through 2.1057, and applicable parts of paragraph 15, Part 15C Paragraph 15.249, Industry Canada RSS-210 Issue 9, and RSS-GEN Issue 5 operation in the 2400 – 2483.5 MHz Frequency band. Test procedures used are the established Methods of Measurement of Radio-Noise Emissions as described in ANSI C63.10-2013.

## Testing Procedures

### ***AC Line Conducted Emission Test Procedure***

The EUT operates on direct current power only provided by the vehicle installation. Therefore, no AC line conducted emission testing was required or performed.

### ***Radiated Emission Test Procedure***

Radiated emissions testing was performed as required in 47 CFR 15C, RSS-210 and specified in ANSI C63.10-2013. The EUT was placed on a rotating 0.9 x 1.2-meter platform, elevated as required above the ground plane at a distance of 3 meters from the FSM antenna. EMI energy was maximized by equipment placement permitting orientation in three orthogonal axes, raising and lowering the FSM antenna, changing the antenna polarization, and by rotating the turntable. Each emission was maximized before data was taken and recorded. The frequency spectrum from 9 kHz to 25,000 MHz was searched for emissions during preliminary investigation. Refer to diagrams one and two showing typical test setup. Refer to photographs in the test setup exhibits for specific EUT placement during testing.

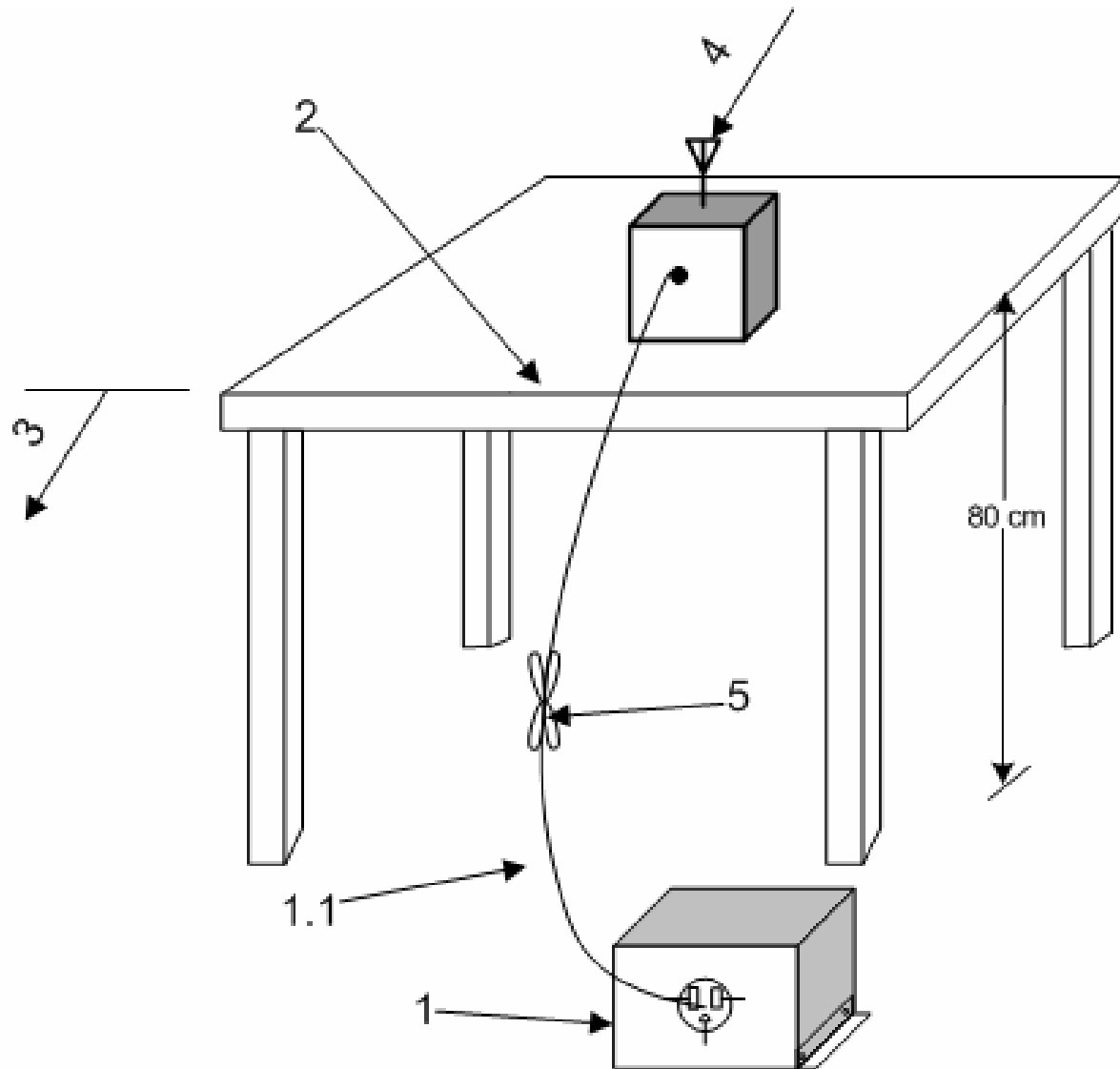

1—A LISN is optional for radiated measurements between 30 MHz and 1000 MHz but not allowed for measurements below 30 MHz and above 1000 MHz (see 6.3.1). If used, then connect EUT to one LISN. Unused LISN measuring port connectors shall be terminated in 50  $\Omega$  loads. The LISN may be placed on top of, or immediately beneath, the reference ground plane (see 6.2.2 and 6.2.3.2).

1.1—LISN spaced at least 80 cm from the nearest part of the EUT chassis.

2—Antenna can be integral or detachable, depending on the EUT (see 6.3.1).

3—Interconnecting cables that hang closer than 40 cm to the ground plane shall be folded back and forth in the center forming a bundle 30 cm to 40 cm long (see 6.3.1).

4—For emission measurements at or below 1 GHz, the table height shall be 80 cm. For emission measurements above 1 GHz, the table height shall be 1.5 m for measurements, except as otherwise specified (see 6.3.1 and 6.6.3.1).

### Diagram 1 Test arrangement for radiated emissions of tabletop equipment

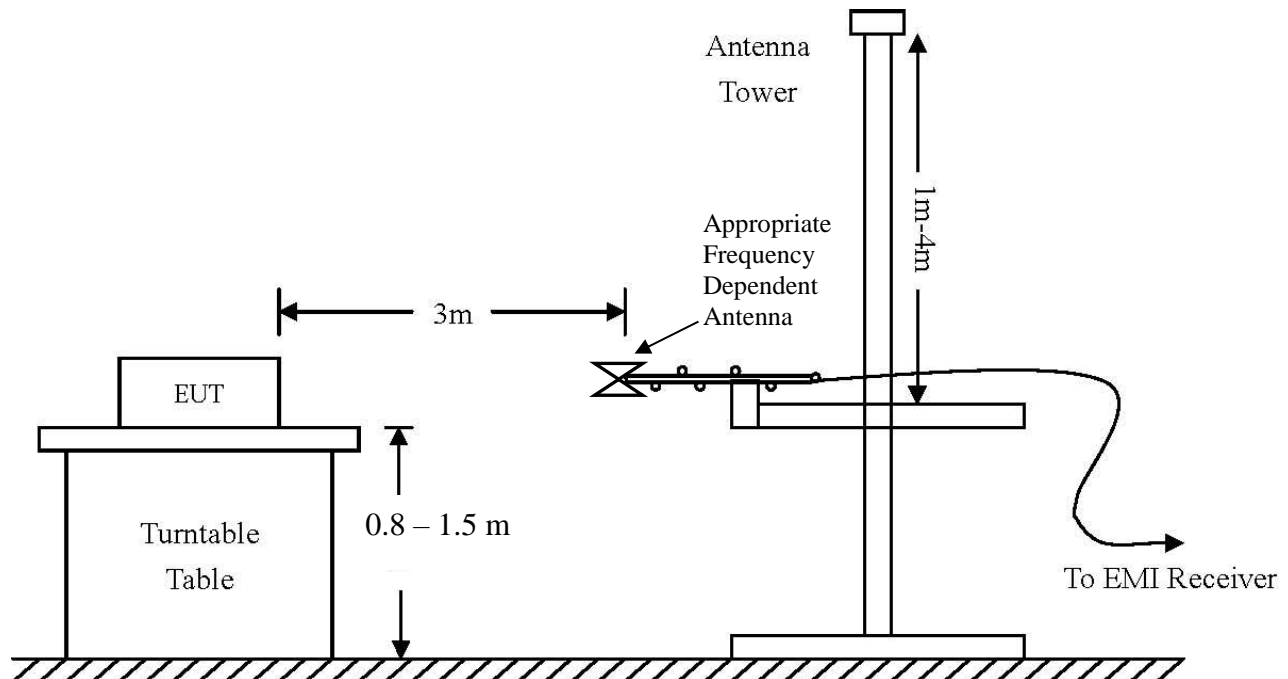

AC Line Conducted Emissions (0.150 -30 MHz)		
RBW	AVG. BW	Detector Function
9 kHz	30 kHz	Peak / Quasi Peak
Emissions (30-1000 MHz)		
RBW	AVG. BW	Detector Function
120 kHz	300 kHz	Peak / Quasi Peak
Emissions (Above 1000 MHz)		
RBW	Video BW	Detector Function
100 kHz	100 kHz	Peak
1 MHz	1 MHz	Peak / Average

**Diagram 2 Test arrangement for radiated emissions tested on Open Area Test Site (OATS)**

## Test Site Locations

Conducted EMI AC line conducted emissions testing performed in a shielded screen room located at Rogers Labs, Inc., 4405 West 259<sup>th</sup> Terrace, Louisburg, KS

Radiated EMI The radiated emissions tests were performed at the 3 meters, Open Area Test Site (OATS) located at Rogers Labs, Inc., 4405 West 259<sup>th</sup> Terrace, Louisburg, KS

Registered Site # FCC Site: US5305 and Industry Canada Registration: 3041A-1

NVLAP Accreditation Lab code 200087-0

Rogers Labs, Inc.  
4405 W. 259th Terrace  
Louisburg, KS 66053  
Phone/Fax: (913) 837-3214  
Revision 1

Garmin International, Inc.  
Model: A03562  
Test #: 180904  
Test to: CFR47 15.249, RSS-210, RSS-Gen  
File: A03562 DXX TstRpt 180904

SN's: 984512717 / 39733 09969  
FCC ID: IPH-03562  
IC: 1792A-03562  
Date: October 25, 2018  
Page 12 of 31

## List of Test Equipment

<u>Equipment</u>	<u>Manufacturer</u>	<u>Model (SN)</u>	<u>Band</u>	<u>Cal Date(m/d/y)</u>	<u>Due</u>
<input type="checkbox"/> LISN	FCC	FCC-LISN-50-2-10(1PA) (160611)	.15-30MHz	5/2/2018	5/2/2019
<input type="checkbox"/> LISN	Compliance Design	FCC-LISN-2.Mod.cd,	.15-30MHz	10/24/2017	10/24/2018
<input checked="" type="checkbox"/> Cable	Huber & Suhner Inc.	Sucoflex102ea(L10M)(303073)	9kHz-40 GHz	10/24/2017	10/24/2018
<input checked="" type="checkbox"/> Cable	Huber & Suhner Inc.	Sucoflex102ea(1.5M)(303069)	9kHz-40 GHz	10/24/2017	10/24/2018
<input type="checkbox"/> Cable	Huber & Suhner Inc.	Sucoflex102ea(1.5M)(303071)	9kHz-40 GHz	10/24/2017	10/24/2018
<input type="checkbox"/> Cable	Belden	RG-58 (L1-CAT3-11509)	9kHz-30 MHz	10/24/2017	10/24/2018
<input type="checkbox"/> Cable	Belden	RG-58 (L2-CAT3-11509)	9kHz-30 MHz	10/24/2017	10/24/2018
<input type="checkbox"/> Antenna	ARA	BCD-235-B (169)	20-350MHz	10/24/2017	10/24/2018
<input type="checkbox"/> Antenna	EMCO	3147 (40582)	200-1000MHz	10/24/2017	10/24/2018
<input checked="" type="checkbox"/> Antenna	ETS-Lindgren	3117 (200389)	1-18 GHz	5/2/2018	5/2/2020
<input type="checkbox"/> Antenna	Com Power	AH-118 (10110)	1-18 GHz	10/24/2017	10/24/2019
<input checked="" type="checkbox"/> Antenna	Com Power	AH-840 (101046)	18-40 GHz	5/15/2017	5/15/2019
<input checked="" type="checkbox"/> Antenna	Com Power	AL-130 (121055)	.001-30 MHz	10/24/2017	10/24/2018
<input checked="" type="checkbox"/> Antenna	Sunol	JB-6 (A100709)	30-1000 MHz	10/24/2017	10/24/2018
<input checked="" type="checkbox"/> Analyzer	Rohde & Schwarz	ESU40 (100108)	20Hz-40GHz	5/2/2018	5/2/2019
<input type="checkbox"/> Analyzer	Rohde & Schwarz	ESW44 (101534)	20Hz-44GHz	12/22/2017	12/22/2018
<input type="checkbox"/> Analyzer	Rohde & Schwarz	FS-Z60, 90, 140, and 220	40GHz-220GHz	12/22/2017	12/22/2019
<input type="checkbox"/> Analyzer	HP	8591EM (3628A00871)	9kHz-1.8GHz	5/2/2018	5/2/2019
<input type="checkbox"/> Analyzer	HP	8562A (3051A05950)	9kHz-125GHz	5/2/2018	5/2/2019
<input type="checkbox"/> Analyzer	HP External Mixers	11571, 11970	25GHz-110GHz	5/2/2018	5/2/2019
<input checked="" type="checkbox"/> Amplifier	Com-Power	PA-010 (171003)	100Hz-30MHz	10/24/2017	10/24/2018
<input checked="" type="checkbox"/> Amplifier	Com-Power	CPPA-102 (01254)	1-1000 MHz	10/24/2017	10/24/2018
<input checked="" type="checkbox"/> Amplifier	Com-Power	PAM-118A (551014)	0.5-18 GHz	10/24/2017	10/24/2018
<input type="checkbox"/> Power Meter	Agilent	N1911A with N1921A	0.05-40 GHz	5/2/2018	5/2/2019
<input type="checkbox"/> Generator	Rohde & Schwarz	SMB100A6 (100150)	20Hz-6 GHz	5/2/2018	5/2/2019
<input type="checkbox"/> Generator	Rohde & Schwarz	SMBV100A6 (260771)	20Hz-6 GHz	5/2/2018	5/2/2019
<input type="checkbox"/> RF Filter	Micro-Tronics	BRC50722 (009).9G notch	30-1800 MHz	5/2/2018	5/2/2019
<input type="checkbox"/> RF Filter	Micro-Tronics	HPM50114 (017)1.5G HPF	30-18000 MHz	5/2/2018	5/2/2019
<input type="checkbox"/> RF Filter	Micro-Tronics	HPM50117 (063) 3G HPF	30-18000 MHz	5/2/2018	5/2/2019
<input type="checkbox"/> RF Filter	Micro-Tronics	HPM50105 (059) 6G HPF	30-18000 MHz	5/2/2018	5/2/2019
<input type="checkbox"/> RF Filter	Micro-Tronics	BRM50702 (172) 2G notch	30-1800 MHz	5/2/2018	5/2/2019
<input type="checkbox"/> RF Filter	Micro-Tronics	BRC50703 (G102) 5G notch	30-1800 MHz	5/2/2018	5/2/2019
<input type="checkbox"/> RF Filter	Micro-Tronics	BRC50705 (024) 5G notch	30-1800 MHz	5/2/2018	5/2/2019
<input checked="" type="checkbox"/> Attenuator	Mini-Circuits	VAT-3W2+ (1735)	30-6000 MHz	5/2/2018	5/2/2019
<input type="checkbox"/> Attenuator	Mini-Circuits	VAT-3W2+ (1436)	30-6000 MHz	5/2/2018	5/2/2019
<input type="checkbox"/> Attenuator	Mini-Circuits	VAT-3W2+ (14362)	30-6000 MHz	5/2/2018	5/2/2019
<input type="checkbox"/> Attenuator	Mini-Circuits	VAT-3W2+ (1445)	30-6000 MHz	5/2/2018	5/2/2019
<input type="checkbox"/> Attenuator	Mini-Circuits	VAT-3W2+ (14452)	30-6000 MHz	5/2/2018	5/2/2019
<input type="checkbox"/> Attenuator	Mini-Circuits	VAT-6W2+ (1438)	30-6000 MHz	5/2/2018	5/2/2019
<input type="checkbox"/> Attenuator	Mini-Circuits	VAT-6W2+ (1736)	30-6000 MHz	5/2/2018	5/2/2019
<input checked="" type="checkbox"/> Weather station	Davis	6312 (A70927D44N)		10/24/2017	10/24/2018

Rogers Labs, Inc.  
4405 W. 259th Terrace  
Louisburg, KS 66053  
Phone/Fax: (913) 837-3214  
Revision 1

Garmin International, Inc.  
Model: A03562  
Test #: 180904  
Test to: CFR47 15.249, RSS-210, RSS-Gen  
File: A03562 DXX TstRpt 180904

SN's: 984512717 / 39733 09969  
FCC ID: IPH-03562  
IC: 1792A-03562  
Date: October 25, 2018  
Page 13 of 31

## Units of Measurements

Conducted EMI            Data is in dB $\mu$ V; dB referenced to one microvolt

Radiated EMI            Data is in dB $\mu$ V/m; dB/m referenced to one microvolt per meter

Sample Calculation:

RFS = Radiated Field Strength, FSM = Field Strength Measured

A.F. = Receive antenna factor, Gain = amplification gains and/or cable losses

RFS (dB $\mu$ V/m @ 3m) = FSM (dB $\mu$ V) + A.F. (dB) - Gain (dB)

## Environmental Conditions

Ambient Temperature        23.5° C

Relative Humidity            41%

Atmospheric Pressure        1016.2 mb

## Statement of Modifications and Deviations

No modifications to the EUT were required for the equipment to demonstrate compliance with the 47 CFR Part 15C, 15.249, Industry Canada RSS-210 Issue 9, and RSS-GEN Issue 5 emission requirements. There were no deviations to the specifications.

## Intentional Radiators

The following information is submitted supporting compliance with the requirements of 47 CFR, Subpart C, paragraph 15.249, Industry Canada RSS-210 Issue 9 and RSS-GEN Issue 5.

## *Antenna Requirements*

The EUT incorporates integral antenna system. Production equipment offers no provision for connection to alternate antenna system. The antenna connection point complies with the unique antenna connection requirements. There are no deviations or exceptions to the specification.

### **Restricted Bands of Operation**

Spurious emissions falling in the restricted frequency bands of operation were measured at the OATS. The EUT utilizes frequency, determining circuitry, which generates harmonics falling in the restricted bands. Emissions were investigated at the OATS, using appropriate antennas or pyramidal horns, amplification stages, and a spectrum analyzer. Peak and average amplitudes of frequencies above 1000 MHz were compared to the required limits with worst-case data presented below. Test procedures of ANSI C63.10-2013 were used during testing. No other significant emission was observed which fell into the restricted bands of operation. Computed emission values take into account the received radiated field strength, receive antenna correction factor, amplifier gain stage, and test system cable losses.

**Table 1 Radiated Emissions in Restricted Frequency Bands Data (GFSK)**

Frequency in MHz	Horizontal Peak (dB $\mu$ V/m)	Horizontal Quasi-Peak (dB $\mu$ V/m)	Horizontal Average (dB $\mu$ V/m)	Vertical Peak (dB $\mu$ V/m)	Vertical Quasi-Peak (dB $\mu$ V/m)	Vertical Average (dB $\mu$ V/m)	Limit @ 3m (dB $\mu$ V/m)
2390.0	51.8	N/A	29.7	59.9	N/A	29.9	54.0
2483.5	54.0	N/A	30.3	62.3	N/A	30.5	54.0
4804.0	47.6	N/A	34.0	56.5	N/A	35.3	54.0
4884.0	50.3	N/A	34.8	56.4	N/A	35.6	54.0
4958.0	48.3	N/A	34.1	56.3	N/A	35.6	54.0
7206.0	50.7	N/A	37.6	50.8	N/A	37.6	54.0
7326.0	50.9	N/A	38.2	51.6	N/A	38.1	54.0
7437.0	51.1	N/A	38.2	51.1	N/A	38.5	54.0
12010.0	56.1	N/A	42.9	55.9	N/A	42.8	54.0
12210.0	57.7	N/A	44.6	57.7	N/A	44.6	54.0
12395.0	56.6	N/A	44.2	57.4	N/A	44.2	54.0

Other emissions present had amplitudes at least 20 dB below the limit. Peak and Quasi-Peak amplitude emissions are recorded for frequency range below 1000 MHz. Peak and Average amplitude emissions are recorded for frequency range above 1000 MHz.

**Table 2 Radiated Emissions in Restricted Frequency Bands Data (GMSK)**

Frequency in MHz	Horizontal Peak (dB $\mu$ V/m)	Horizontal Quasi-Peak (dB $\mu$ V/m)	Horizontal Average (dB $\mu$ V/m)	Vertical Peak (dB $\mu$ V/m)	Vertical Quasi-Peak (dB $\mu$ V/m)	Vertical Average (dB $\mu$ V/m)	Limit @ 3m (dB $\mu$ V/m)
2390.0	47.9	N/A	30.2	57.4	N/A	30.7	54.0
2483.5	56.5	N/A	32.0	65.7	N/A	37.1	54.0
4804.0	48.3	N/A	35.6	57.1	N/A	48.0	54.0
4884.0	49.2	N/A	36.9	54.5	N/A	45.9	54.0
4960.0	48.5	N/A	35.9	52.7	N/A	42.0	54.0
7206.0	52.5	N/A	39.1	53.9	N/A	40.4	54.0
7326.0	52.2	N/A	38.9	51.5	N/A	38.9	54.0
7440.0	52.0	N/A	38.4	51.3	N/A	38.5	54.0
12010.0	56.6	N/A	43.3	55.8	N/A	43.1	54.0
12210.0	57.6	N/A	44.7	58.0	N/A	44.8	54.0
12400.0	56.3	N/A	44.0	57.3	N/A	44.0	54.0

Other emissions present had amplitudes at least 20 dB below the limit. Peak and Quasi-Peak amplitude emissions are recorded for frequency range below 1000 MHz. Peak and Average amplitude emissions are recorded for frequency range above 1000 MHz.

**Summary of Results for Radiated Emissions in Restricted Bands**

The EUT demonstrated compliance with the radiated emissions requirements of 47 CFR Part 15C and RSS-210 Intentional Radiator requirements. The EUT demonstrated a worst-case minimum margin of -6.0 dB below the emissions requirements in restricted frequency bands. Peak, Quasi-peak, and average amplitudes were checked for compliance with the regulations. Worst-case emissions are reported with other emissions found in the restricted frequency bands at least 20 dB below the requirements.



### **General Radiated Emissions Procedure**

The EUT was arranged in typical equipment configurations and operated through available modes during testing. Preliminary testing was performed in a screen room with the EUT positioned 1 meter from the FSM. Radiated emissions measurements were performed to identify the frequencies, which produced the highest emissions. Each radiated emission was then maximized at the OATS location before final radiated measurements were performed. Final data was taken with the EUT located at the OATS at a distance of 3 meters between the EUT and the receiving antenna. The frequency spectrum from 9 kHz to 25,000 MHz was searched for general radiated emissions. Measured emission levels were maximized by EUT placement on the table, rotating the turntable through 360 degrees, varying the antenna height between 1 and 4 meters above the ground plane and changing antenna position between horizontal and vertical polarization. Antennas used were Loop from 9 kHz to 30 MHz, Broadband Biconical from 30 to 200 MHz, Biconilog from 30 to 1000 MHz, Log Periodic from 200 MHz to 1 GHz and or double Ridge or pyramidal horns and mixers above 1 GHz, notch filters and appropriate amplifiers and external mixers were utilized.

**Table 3 General Radiated Emissions Data**

Frequency in MHz	Horizontal Peak (dBµV/m)	Horizontal Quasi-Peak (dBµV/m)	Horizontal Average (dBµV/m)	Vertical Peak (dBµV/m)	Vertical Quasi-Peak (dBµV/m)	Vertical Average (dBµV/m)	Limit @ 3m (dBµV/m)
49.9	51.7	36.2	N/A	49.6	34.2	N/A	40.0
51.5	56.3	36.3	N/A	53.8	34.3	N/A	40.0
54.3	54.7	36.4	N/A	54.9	35.2	N/A	40.0
72.0	53.1	35.4	N/A	43.8	29.7	N/A	40.0
76.7	50.9	35.1	N/A	53.8	34.5	N/A	40.0
121.2	52.3	36.9	N/A	50.6	34.7	N/A	43.5
123.0	48.0	31.7	N/A	51.2	34.1	N/A	43.5
123.6	48.5	31.8	N/A	53.6	35.4	N/A	43.5
148.0	53.7	36.2	N/A	43.6	25.6	N/A	43.5
148.3	51.1	36.1	N/A	43.2	29.1	N/A	43.5
148.8	47.9	34.4	N/A	39.1	24.2	N/A	43.5
154.9	50.0	35.9	N/A	38.0	21.9	N/A	43.5

Other emissions present had amplitudes at least 20 dB below the limit. Peak and Quasi-Peak amplitude emissions are recorded for frequency range below 1000 MHz. Peak and Average amplitude emissions are recorded for frequency range above 1000 MHz.

**Summary of Results for General Radiated Emissions**

The EUT demonstrated compliance with the radiated emissions requirements of 47 CFR Part 15C paragraph 15.209, RSS-210 and RSS-GEN Intentional Radiators. The EUT demonstrated a minimum margin of -3.6 dB below the requirements. Other emissions were present with amplitudes at least 20 dB below the Limits.

### **Operation in the Band 2400 – 2483.5 MHz**

The transmitter output power; harmonic and general emissions were measured on an open area test site @ 3 meters. The EUT was placed on a turntable elevated as required above the ground plane and at a distance of 3 meters from the FSM antenna. The peak and quasi-peak amplitude of frequencies below 1000 MHz were measured using a spectrum analyzer. The peak and average amplitude of frequencies above 1000 MHz were measured using a spectrum analyzer. The amplitude of each emission was then recorded from the analyzer display. Emissions radiated outside of the specified bands, except for harmonics, shall be attenuated by at least 50 dB below the level of the fundamental or to the general radiated emission limits, whichever is the lesser attenuation. Antenna port emission plots were taken of transmitter performance for reference in this and other documentation using test sample #2. The amplitude of each radiated emission was measured on the OATS at a distance of 3 meters from the FSM antenna testing was performed on sample representative of production with integral antenna (sample #1) with worst-case data provided. The amplitude of each radiated emission was maximized by equipment orientation and placement on the turn table, raising and lowering the FSM (Field Strength Measuring) antenna, changing the FSM antenna polarization, and by rotating the turntable. A Loop antenna was used for measuring emissions from 0.009 to 30 MHz, Biconilog Antenna for 30 to 1000 MHz, Double-Ridge, and/or Pyramidal Horn Antennas from 1 GHz to 25 GHz. Emissions were measured in dB $\mu$ V/m @ 3 meters.

Refer to figures one through eight showing plots taken of the 2402-2480 MHz transmitter operation displaying compliance with the specifications.

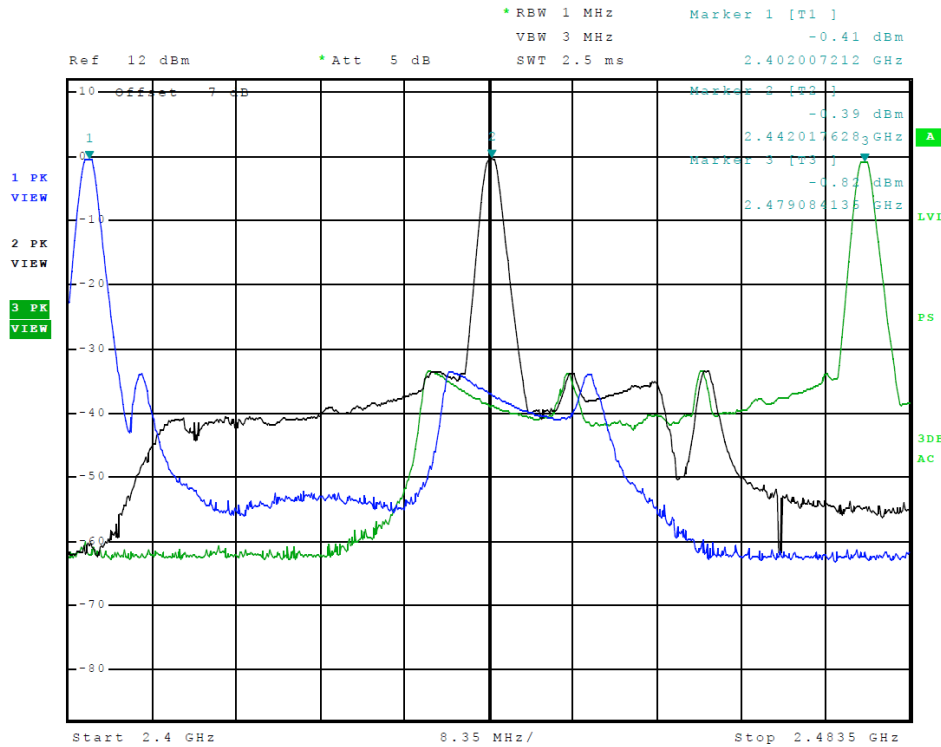

**Figure 1 Plot of Transmitter Emissions Operation in 2402-2480 MHz (GFSK)**

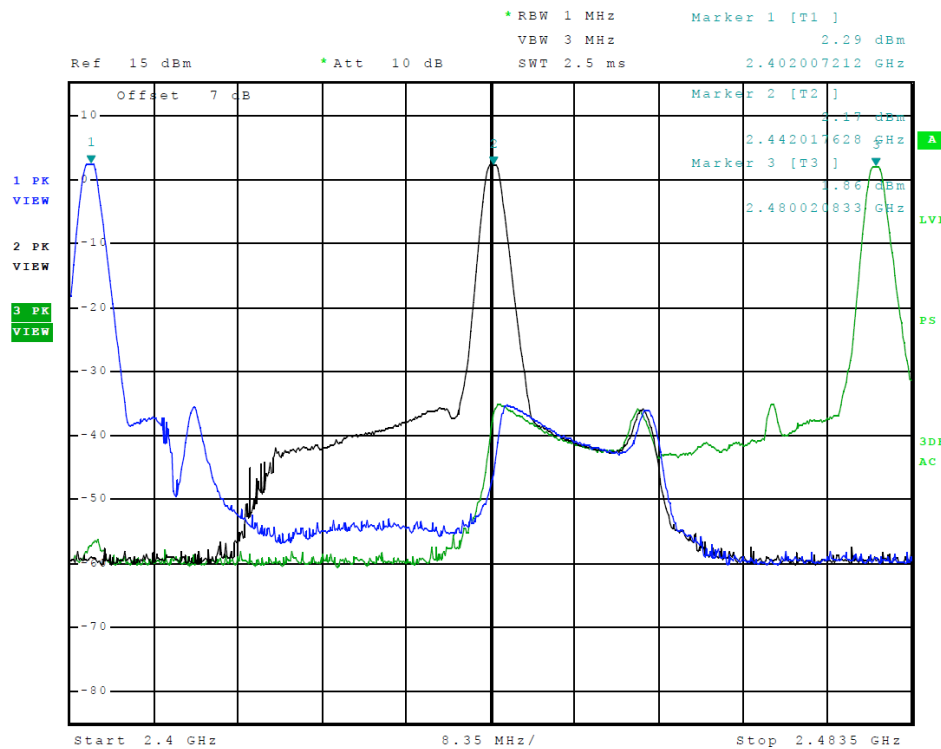

**Figure 2 Plot of Transmitter Emissions Operation in 2402-2480 MHz (GMSK)**

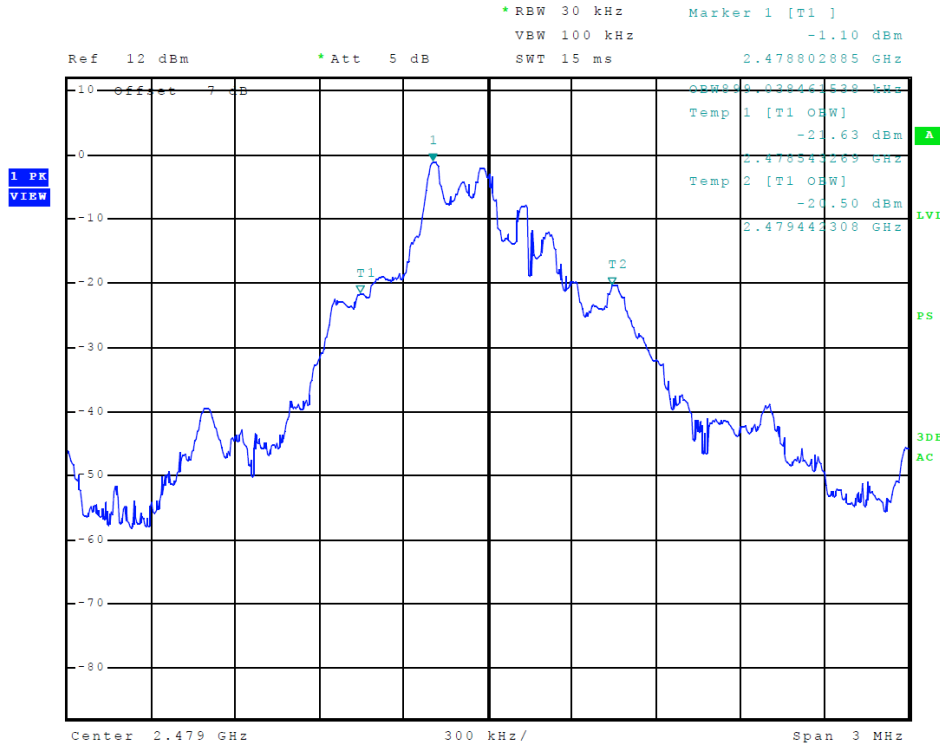

**Figure 3 Plot of Transmitter Emissions 99% Occupied Bandwidth (GFSK)**

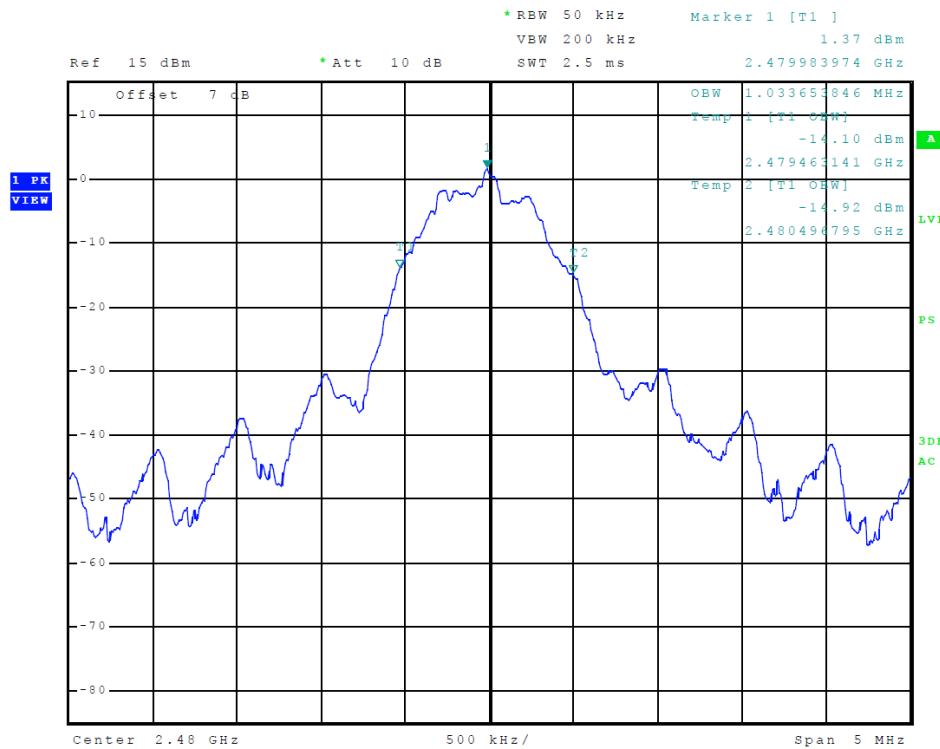

**Figure 4 Plot of Transmitter Emissions 99% Occupied Bandwidth (GMSK)**

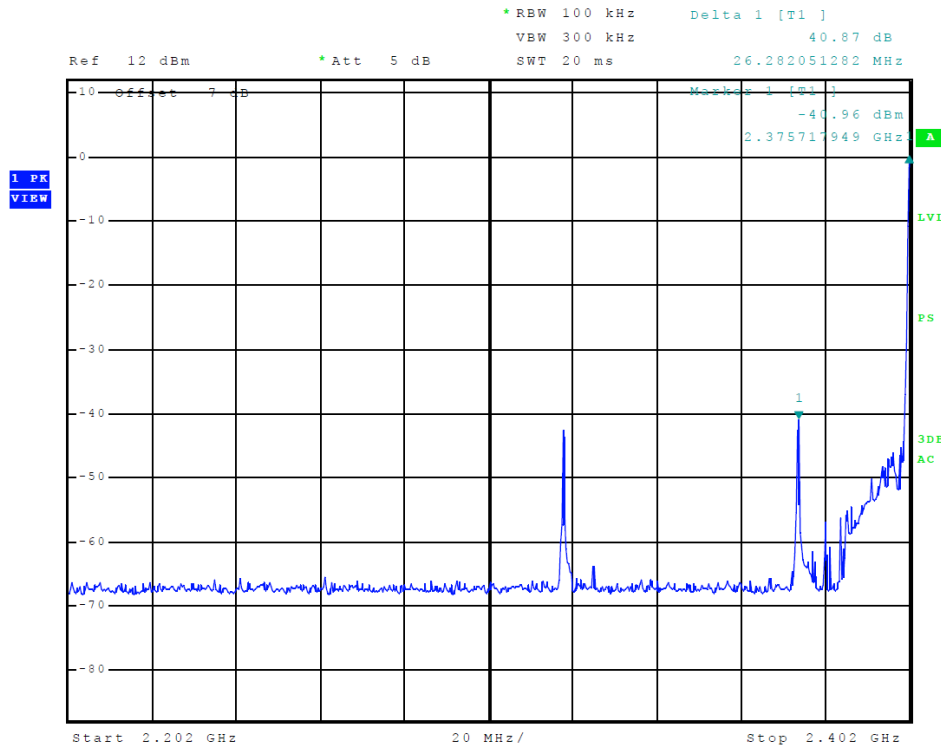

Figure 5 Plot of Transmitter Emissions Low Band Edge (GFSK)

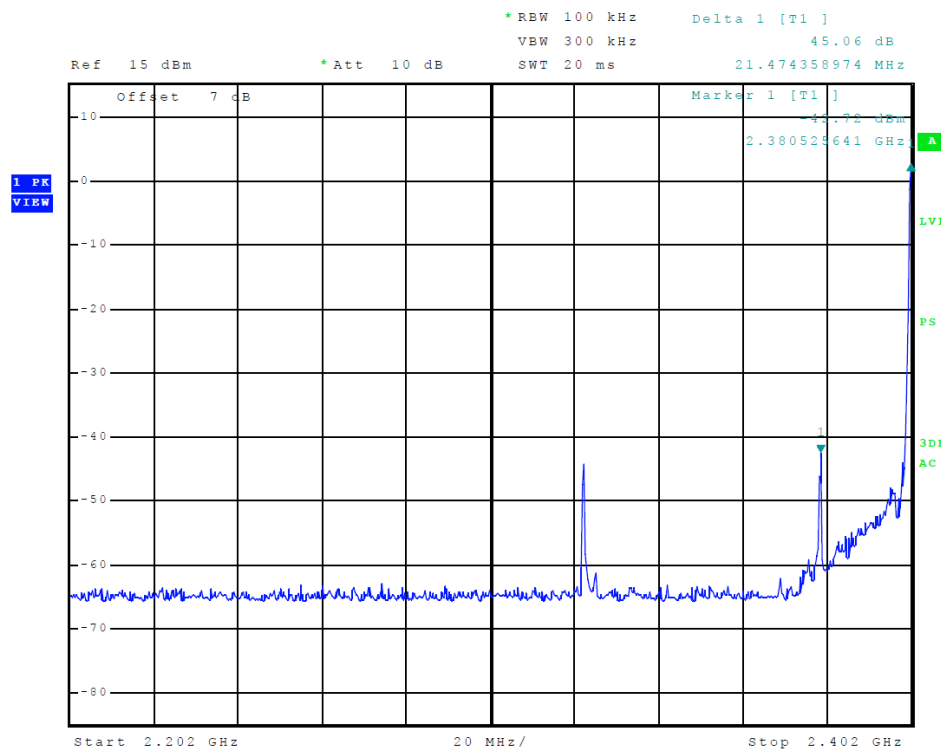
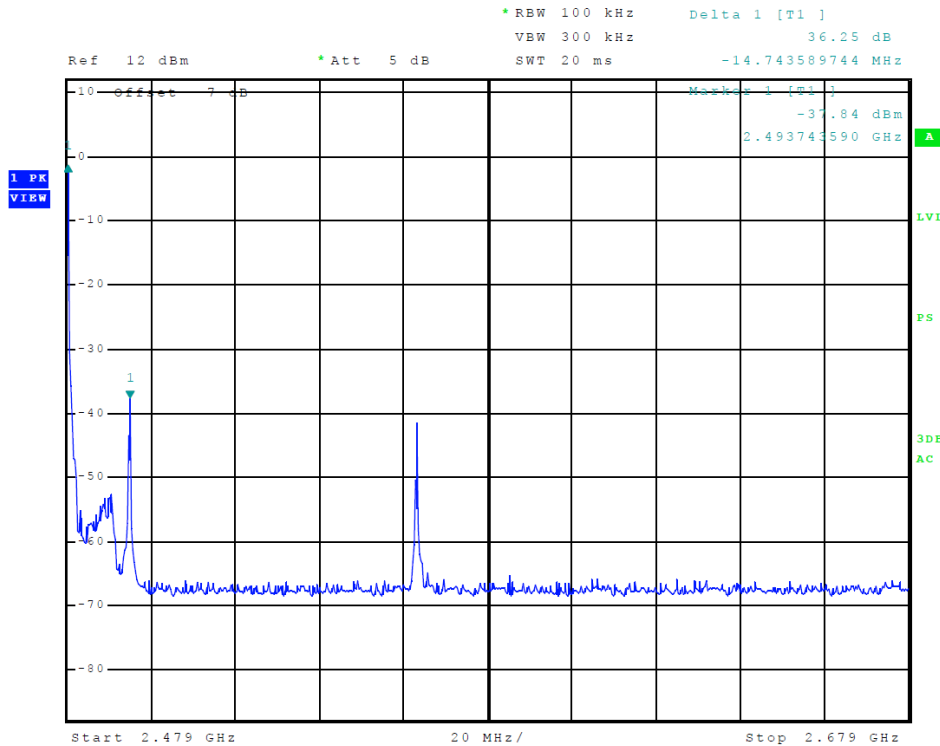
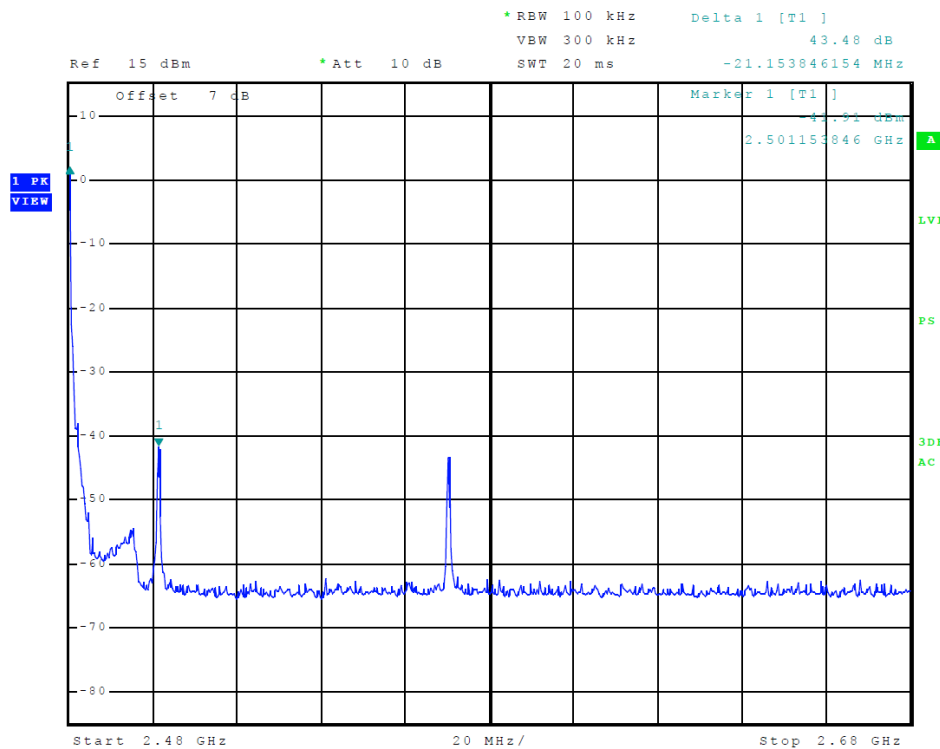

Figure 6 Plot of Transmitter Emissions Low Band Edge (GMSK)



**Figure 7 Plot of Transmitter Emissions High Band Edge (GFSK)**



**Figure 8 Plot of Transmitter Emissions High Band Edge (GMSK)**

## Transmitter Emissions Data

**Table 4 Transmitter Radiated Emissions (GFSK)**

Frequency in MHz	Horizontal Peak (dB $\mu$ V/m)	Horizontal Quasi-Peak (dB $\mu$ V/m)	Horizontal Average (dB $\mu$ V/m)	Vertical Peak (dB $\mu$ V/m)	Vertical Quasi-Peak (dB $\mu$ V/m)	Vertical Average (dB $\mu$ V/m)	Limit @ 3m (dB $\mu$ V/m)
2402.0	89.3	N/A	57.1	98.6	N/A	66.1	94.0
4804.0	47.6	N/A	34.0	56.5	N/A	35.3	54.0
7206.0	50.7	N/A	37.6	50.8	N/A	37.6	54.0
9608.0	53.4	N/A	41.0	54.2	N/A	41.1	54.0
12010.0	56.1	N/A	42.9	55.9	N/A	42.8	54.0
14412.0	57.3	N/A	44.6	57.9	N/A	44.6	54.0
16814.0	60.9	N/A	48.2	61.2	N/A	48.1	54.0
2442.0	88.8	N/A	56.6	98.6	N/A	65.9	94.0
4884.0	50.3	N/A	34.8	56.4	N/A	35.6	54.0
7326.0	50.9	N/A	38.2	51.6	N/A	38.1	54.0
9768.0	53.8	N/A	40.9	54.2	N/A	41.0	54.0
12210.0	57.7	N/A	44.6	57.7	N/A	44.6	54.0
14652.0	59.4	N/A	46.2	60.2	N/A	46.2	54.0
17094.0	61.1	N/A	48.5	61.6	N/A	48.5	54.0
2479.0	89.3	N/A	57.0	98.4	N/A	65.7	94.0
4958.0	48.3	N/A	34.1	56.3	N/A	35.6	54.0
7437.0	51.1	N/A	38.2	51.1	N/A	38.5	54.0
9916.0	54.0	N/A	41.1	54.0	N/A	41.2	54.0
12395.0	56.6	N/A	44.2	57.4	N/A	44.2	54.0
14874.0	59.6	N/A	46.2	60.0	N/A	46.8	54.0
17353.0	61.3	N/A	48.0	62.3	N/A	49.0	54.0

Other emissions present had amplitudes at least 20 dB below the limit. Peak and Quasi-Peak amplitude emissions are recorded for frequency range below 1000 MHz. Peak and Average amplitude emissions are recorded for frequency range above 1000 MHz.



**Table 5 Transmitter Radiated Emissions (GMSK)**

Frequency in MHz	Horizontal Peak (dBμV/m)	Horizontal Quasi-Peak (dBμV/m)	Horizontal Average (dBμV/m)	Vertical Peak (dBμV/m)	Vertical Quasi-Peak (dBμV/m)	Vertical Average (dBμV/m)	Limit @ 3m (dBμV/m)
2402.0	90.1	N/A	84.9	97.8	N/A	93.6	94.0
4804.0	48.3	N/A	35.6	57.1	N/A	48.0	54.0
7206.0	52.5	N/A	39.1	53.9	N/A	40.4	54.0
9608.0	54.2	N/A	41.2	54.7	N/A	41.2	54.0
12010.0	56.6	N/A	43.3	55.8	N/A	43.1	54.0
14412.0	57.6	N/A	44.7	57.6	N/A	44.7	54.0
16814.0	61.4	N/A	48.3	61.3	N/A	48.4	54.0
2442.0	90.4	N/A	85.6	97.4	N/A	93.3	94.0
4884.0	49.2	N/A	36.9	54.5	N/A	45.9	54.0
7326.0	52.2	N/A	38.9	51.5	N/A	38.9	54.0
9768.0	54.1	N/A	41.2	54.1	N/A	41.2	54.0
12210.0	57.6	N/A	44.7	58.0	N/A	44.8	54.0
14652.0	59.1	N/A	46.4	59.0	N/A	46.3	54.0
17094.0	61.5	N/A	48.2	62.1	N/A	48.3	54.0
2480.0	89.8	N/A	85.6	97.7	N/A	93.6	94.0
4960.0	48.5	N/A	35.9	52.7	N/A	42.0	54.0
7440.0	52.0	N/A	38.4	51.3	N/A	38.5	54.0
9920.0	54.7	N/A	41.2	54.4	N/A	41.3	54.0
12400.0	56.3	N/A	44.0	57.3	N/A	44.0	54.0
14880.0	59.4	N/A	46.4	59.6	N/A	46.4	54.0
17360.0	61.5	N/A	48.5	61.3	N/A	48.5	54.0

Other emissions present had amplitudes at least 20 dB below the limit. Peak and Quasi-Peak amplitude emissions are recorded for frequency range below 1000 MHz. Peak and Average amplitude emissions are recorded for frequency range above 1000 MHz.

## ***Summary of Results for Transmitter Radiated Emissions of Intentional Radiator***

The EUT demonstrated compliance with the radiated emissions requirements of FCC 47 CFR Part 15.249, Industry Canada RSS-210 Issue 9 and RSS-GEN Issue 5 Intentional Radiator regulations. The EUT worst-case test sample configuration demonstrated minimum average margin of -0.4 dB below the average emission limit for the fundamental. The EUT worst-case configuration demonstrated minimum radiated harmonic emission margin of -5.0 dB below the limit. No other radiated emissions were found in the restricted bands less than 20 dB below limits than those recorded in this report. Other emissions were present with amplitudes at least 20 dB below the limits.

## Annex

- Annex A Measurement Uncertainty Calculations
- Annex B Rogers Labs Additional Test Equipment List
- Annex C Rogers Qualifications
- Annex D Rogers Labs Certificate of Accreditation

## Annex A Measurement Uncertainty Calculations

The measurement uncertainty was calculated for all measurements listed in this test report according to CISPR 16-4. Result of measurement uncertainty calculations are recorded below. Component and process variability of production devices similar to those tested may result in additional deviations. The manufacturer has the sole responsibility of continued compliance.

Measurement	Expanded Measurement Uncertainty $U_{(lab)}$
3 Meter Horizontal 0.009-1000 MHz Measurements	4.16
3 Meter Vertical 0.009-1000 MHz Measurements	4.33
3 Meter Measurements 1-18 GHz	5.14
3 Meter Measurements 18-40 GHz	5.16
10 Meter Horizontal Measurements 0.009-1000 MHz	4.15
10 Meter Vertical Measurements 0.009-1000 MHz	4.32
AC Line Conducted	1.75
Antenna Port Conducted power	1.17
Frequency Stability	1.00E-11
Temperature	1.6°C
Humidity	3%

## **Annex B Rogers Labs Additional Test Equipment List**

List of Test Equipment	Calibration	<u>Date (m/d/y)</u>	<u>Due</u>
Antenna: Schwarzbeck Model: BBA 9106/VHBB 9124 (9124-627)		5/2/2018	5/2/2019
Antenna: Schwarzbeck Model: VULP 9118 A (VULP 9118 A-534)		5/2/2018	5/2/2019
Antenna: EMCO 6509		10/24/2016	10/24/2018
Antenna: EMCO 3143 (9607-1277) 20-1200 MHz		5/2/2018	5/2/2019
Antenna: EMCO Dipole Set 3121C		2/23/2018	2/23/2019
Antenna: C.D. B-101		2/23/2018	2/23/2019
Antenna: Solar 9229-1 & 9230-1		2/23/2018	2/23/2019
Cable: Belden 8268 (L3)		10/24/2017	10/24/2018
Cable: Time Microwave: 4M-750HF290-750		10/24/2017	10/24/2018
Frequency Counter: Leader LDC-825 (8060153)		5/2/2018	5/2/2019
Oscilloscope Scope: Tektronix 2230		2/23/2018	2/23/2019
Wattmeter: Bird 43 with Load Bird 8085		2/23/2018	2/23/2019
Power Supplies: Sorensen SRL 20-25, SRL 40-25, DCR 150, DCR 140		2/23/2018	2/23/2019
R.F. Generator: SMB100A6 s/n 100623		5/2/2018	5/2/2019
R.F. Generator: SBMBV100A s/n: 260771		5/2/2018	5/2/2019
R.F. Generators: HP 606A, HP 8614A, HP 8640B		2/23/2018	2/23/2019
R.F. Power Amp 65W Model: 470-A-1010		2/23/2018	2/23/2019
R.F. Power Amp 50W M185- 10-501		2/23/2018	2/23/2019
R.F. Power Amp A.R. Model: 10W 1010M7		2/23/2018	2/23/2019
R.F. Power Amp EIN Model: A301		2/23/2018	2/23/2019
LISN: Compliance Eng. Model 240/20		5/2/2018	5/2/2019
LISN: Fischer Custom Communications Model: FCC-LISN-50-16-2-08		5/2/2018	5/2/2019
Audio Oscillator: H.P. 201CD		2/23/2018	2/23/2019
ESD Test Set 2010i		2/23/2018	2/23/2019
Oscilloscope Scope: Tektronix MDO 4104		2/23/2018	2/23/2019
EMC Transient Generator HVT TR 3000		2/23/2018	2/23/2019
AC Power Source (Ametech, California Instruments)		2/23/2018	2/23/2019
Fast Transient Burst Generator Model: EFT/B-101		2/23/2018	2/23/2019
Field Intensity Meter: EFM-018		2/23/2018	2/23/2019
KEYTEK Ecat Surge Generator		2/23/2018	2/23/2019
ESD Simulator: MZ-15		2/23/2018	2/23/2019
Shielded Room not required			

Rogers Labs, Inc.  
4405 W. 259th Terrace  
Louisburg, KS 66053  
Phone/Fax: (913) 837-3214  
Revision 1

Garmin International, Inc.  
Model: A03562  
Test #: 180904  
Test to: CFR47 15.249, RSS-210, RSS-Gen  
File: A03562 DXX TstRpt 180904

SN's: 984512717 / 39733 09969  
FCC ID: IPH-03562  
IC: 1792A-03562  
Date: October 25, 2018  
Page 29 of 31

## **Annex C Rogers Qualifications**

**Scot D. Rogers, Engineer**

### **Rogers Labs, Inc.**

Mr. Rogers has approximately 27 years' experience in the field of electronics. Engineering experience includes six years in the automated controls industry and remaining years working with the design, development and testing of radio communications and electronic equipment.

#### Positions Held

Systems Engineer: A/C Controls Mfg. Co., Inc. 6 Years

Electrical Engineer: Rogers Consulting Labs, Inc. 5 Years

Electrical Engineer: Rogers Labs, Inc. Current

#### Educational Background

- 1) Bachelor of Science Degree in Electrical Engineering from Kansas State University.
- 2) Bachelor of Science Degree in Business Administration Kansas State University.
- 3) Several Specialized Training courses and seminars pertaining to Microprocessors and Software programming.

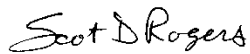

Scot D. Rogers

**Annex D Rogers Labs Certificate of Accreditation**

United States Department of Commerce  
National Institute of Standards and Technology

**NVLAP®**

---

**Certificate of Accreditation to ISO/IEC 17025:2005**

---

NVLAP LAB CODE: 200087-0

**Rogers Labs, Inc.**  
Louisburg, KS

*is accredited by the National Voluntary Laboratory Accreditation Program for specific services,  
listed on the Scope of Accreditation, for:*

**Electromagnetic Compatibility & Telecommunications**

*This laboratory is accredited in accordance with the recognized International Standard ISO/IEC 17025:2005.  
This accreditation demonstrates technical competence for a defined scope and the operation of a laboratory quality  
management system (refer to joint ISO-ILAC-IAF Communique dated January 2009).*

2018-02-21 through 2019-03-31  
*Effective Dates*



  
*For the National Voluntary Laboratory Accreditation Program*

Rogers Labs, Inc.  
4405 W. 259th Terrace  
Louisburg, KS 66053  
Phone/Fax: (913) 837-3214  
Revision 1

Garmin International, Inc.  
Model: A03562  
Test #: 180904  
Test to: CFR47 15.249, RSS-210, RSS-Gen  
File: A03562 DXX TstRpt 180904

SN's: 984512717 / 39733 09969  
FCC ID: IPH-03562  
IC: 1792A-03562  
Date: October 25, 2018  
Page 31 of 31