

ROGERS LABS, INC.

4405 West 259th Terrace
Louisburg, KS 66053
Phone / Fax (913) 837-3214

Application For Grant of Certification

for

Model: A03559

13.56 MHz

NFC Transmitter Operating in the band 13.110-14.010 MHz

FCC ID: IPH-03559

IC: 1792A-03559

FOR

Garmin International, Inc.

1200 East 151st Street
Olathe, KS 66062

FCC Designation: US5305

ISED Registration: 3041A-1

Test Report Number: 190410

Test Date: April 10, 2019

Authorized Signatory: *Scot D. Rogers*

Scot D. Rogers

Rogers Labs, Inc.
4405 West 259th Terrace
Louisburg, KS 66053
Phone/Fax: (913) 837-3214
Revision 1

Garmin International, Inc.
Model: A03559
Test: 190410
Test to: CFR47 (15.225), RSS-210
File: A03559 NFC TstRpt 190410

SN's: 3991277219, 3992239593
FCC ID: IPH-03559
IC: 1792A-03559
Date: May 24, 2019
Page 1 of 38

Engineering Test Report For Grant of Certification Application

FOR
CFR Title 47, PART 15C - Intentional Radiators Paragraph 15.225
Industry Canada RSS-210 Issue 9, RSS-Gen Issue 5
License Exempt Intentional Radiator

For
Garmin International, Inc.

1200 East 151st Street
Olathe, KS 66062

Model: A03559

NFC Transmitter Operating in the band 13.110-14.010 MHz
Frequency Range 13.56 MHz
FCC ID: IPH-03559
IC: 1792A-03559

Test Date: April 10, 2019

Certifying Engineer: *Scot D. Rogers*
Scot D. Rogers
Rogers Labs, Inc.
4405 West 259th Terrace
Louisburg, KS 66053
Telephone/Facsimile: (913) 837-3214

This report shall not be reproduced except in full, without the written approval of the laboratory.
This report must not be used by the client to claim product certification, approval, or
endorsement by NVLAP, NIST, or any agency of the Federal Government.

Rogers Labs, Inc.
4405 West 259th Terrace
Louisburg, KS 66053
Phone/Fax: (913) 837-3214
Revision 1

Garmin International, Inc.
Model: A03559
Test: 190410
Test to: CFR47 (15.225), RSS-210
File: A03559 NFC TstRpt 190410

SN's: 3991277219, 3992239593
FCC ID: IPH-03559
IC: 1792A-03559
Date: May 24, 2019
Page 2 of 38

Table of Contents

TABLE OF CONTENTS.....	3
REVISIONS.....	5
FOREWORD.....	6
OPINION / INTERPRETATION OF RESULTS	6
EQUIPMENT TESTED.....	7
Equipment Function and Configuration.....	8
Equipment Configuration.....	9
APPLICATION FOR CERTIFICATION.....	10
APPLICABLE STANDARDS & TEST PROCEDURES.....	11
EQUIPMENT TESTING PROCEDURES	11
AC Line Conducted Emission Test Procedure	11
Radiated Emission Test Procedure.....	11
Diagram 1 Test arrangement for Conducted emissions	12
Diagram 2 Test arrangement for radiated emissions of tabletop equipment.....	13
Diagram 3 Test arrangement for radiated emissions tested on Open Area Test Site (OATS).....	14
TEST SITE LOCATIONS	14
LIST OF TEST EQUIPMENT	15
UNITS OF MEASUREMENTS	16
ENVIRONMENTAL CONDITIONS.....	16
STATEMENT OF MODIFICATIONS AND DEVIATIONS	16
INTENTIONAL RADIATORS.....	16
Antenna Requirements	16
Restricted Bands of Operation.....	17

Table 1 Radiated Emissions in Restricted Bands Data 17

Summary of Results for Radiated Emissions in Restricted Bands 17

AC Line Conducted EMI Procedure 18

Figure 1 AC Line Conducted emissions of EUT line 1 (#2, EUT – Computer) 19

Figure 2 AC Line Conducted emissions of EUT line 2 (#2, EUT – Computer) 20

Figure 3 AC Line Conducted emissions of EUT line 1 (#3, EUT – 362-00091-00) 21

Figure 4 AC Line Conducted emissions of EUT line 2 (#3, EUT – 362-00091-00) 22

Table 2 AC Line Conducted Emissions Data L1 (configuration #2, EUT – Computer) 23

Table 3 AC Line Conducted Emissions Data L2 (configuration #2, EUT – Computer) 23

Table 4 AC Line Conducted Emissions Data L1 (configuration #3, EUT – 362-00091-00) 24

Table 5 AC Line Conducted Emissions Data L2 (configuration #3, – 362-00091-00) 24

Summary of Results for AC Line Conducted Emissions Results 24

General Radiated Emissions Procedure 25

Table 6 General Radiated Emissions from EUT Data (Highest Emissions) 26

Summary of Results for General Radiated Emissions 26

Operation in the Band 13.110 - 14.010 MHz Band 27

Figure 5 Plot of NFC Operation Across Frequency Spectrum 28

Figure 6 Plot of NFC Operation in Authorized Frequency Band 29

Figure 7 Plot of NFC 99 percent Occupied Bandwidth 30

Table 7 NFC Transmitter Emissions in Frequency Band 13.110-14.010 MHz 30

Table 8 Transmitter Harmonic Radiated Emissions Data 31

Summary of Results for Transmitter Radiated Emissions of Intentional Radiator 31

Frequency Stability 32

Measurements Required 32

Test Arrangement 32

13.110 – 14.010 MHz Transmitter Emissions Data 33

Table 9 Frequency Stability vs. Temperature Results 33

Table 10 Frequency Stability vs. Input Power Supply Voltage Results 33

ANNEX 34

Annex A Measurement Uncertainty Calculations.....35

Annex B Additional Test Equipment List36

Annex C Rogers Qualifications37

Annex D Laboratory Certificate of Accreditation.....38

Revisions

Revision 1 Issued May 24, 2019

Rogers Labs, Inc.
4405 West 259th Terrace
Louisburg, KS 66053
Phone/Fax: (913) 837-3214
Revision 1

Garmin International, Inc.
Model: A03559
Test: 190410
Test to: CFR47 (15.225), RSS-210
File: A03559 NFC TstRpt 190410

SN's: 3991277219, 3992239593
FCC ID: IPH-03559
IC: 1792A-03559
Date: May 24, 2019
Page 5 of 38

Foreword

The following information is submitted for consideration in obtaining Grant of Certification for low power intentional radiator per CFR Title 47 Paragraph 15.225, and Industry Canada RSS-210, operation at 13.56 MHz as Near Field Communications Device.

Name of Applicant: Garmin International, Inc.
 1200 East 151st Street
 Olathe, KS 66062

Model: A03559

FCC I.D.: IPH-03559 Industry Canada ID: 1792A-03559

Frequency Range: 13.56 MHz

Operating power: maximum peak power 62.7 dB μ V/m @ 3 meters, 99 percent occupied bandwidth 16.7 kHz

Opinion / Interpretation of Results

Tests Performed	Margin (dB)	Results
Emissions as per CFR Title 47 15.205, RS-210 4.1	-24.3	Complies
Emissions as per CFR Title 47 15.207, RSS-210 4.3	-13.4	Complies
Emissions as per CFR Title 47 15.209, RSS-210 4.3	-10.6	Complies
Fundamental Emission per CFR Title 47 15.225, RSS-210 B.6	-61.3	Complies

Equipment Tested

<u>Equipment</u>	<u>Model / PN</u>	<u>Serial Number</u>
EUT	A03559	3991277219
EUT#2	A03559	3992239593
USB Cable	320-01048-10	N/A
AC Adapter	362-00091-00	N/A
Laptop Computer	Latitude E6320	FCN03Q1
USB Printer	Dell 0N5819	5D1SL61

Test results in this report relate only to the items tested

Operational communication modes

Mode	Transmitter Operation
0	Near Field Communications (NFC)
1	ANT (GFSK)
2	BT BR (GFSK)
3	BT 2EDR (PI/4 DQPSK)
4	BT BLE (GMSK)
5	802.11b
6	802.11g
7	802.11n

Software Versions 1.52 with ANT/BLE/BT Ver 4.13

Test results in this report relate only to the items tested.

This report documents operations in mode 0 as Near Field Communications (NFC) device

Equipment Function and Configuration

The EUT is a portable body worn digital device. The device displays time, incorporates sensors to log movement and other parameters and includes transmitter functions for communication with compatible equipment. The design provides a single unique connection point for use with the unique USB interface cable and offers no other interface options as presented below in the configuration diagrams. The transmitters provide operation capability as Near Field Communications (NFC) and across the 2402-2480 MHz frequency band. The design provides wireless communications with compatible NFC, ANT, Bluetooth® (BT), and 802.11b/g/n (Wi-Fi) equipment. The product operates from internal rechargeable battery only and requires battery recharge through the provided USB interface cable and compatible USB power source. The design utilizes internal fixed antenna systems and offers no provision for antenna replacement or modification. Two samples were provided for testing, one representative of production design, and the other modified for testing purposes replacing the integral 2.4 GHz antenna with RF connection port. The test samples were provided with test software (Version 1.52 with ANT/BLE/BT Ver. 4.13) enabling testing personnel the ability to enable transmitter functions on defined modulations and channels. The test software enabled near 100% transmit duty cycle for testing purposes. The production product will not operate near this high of duty cycle to conserve battery life. The antenna modification offered testing facility the ability to connect test equipment to the temporary 2.4 GHz antenna port. The EUT was arranged as described by the manufacturer emulating typical user configurations for testing purposes. For testing purposes, the EUT received powered from freshly charged internal battery and/or AC power configurations and configured to operate in available modes. As requested by the manufacturer and required by regulations, the equipment was tested for compliance using the available configurations with the worst-case data presented. This report documents the performed testing and results for applicable configurations and product modes of operation. Test results in this report relate only to the products described in this report.

Equipment Configuration

- 1) Unit operating off internal battery



- 2) Unit connected to Computer USB port through cable assembly (GPN: 320-01048-10)



- 3) Unit connected to (and powered by) AC adapter through USB cable (GPN: 320-01048-10)



Application for Certification

- (1) Manufacturer: Garmin International, Inc.
1200 East 151st Street
Olathe, KS 66062
- (2) Identification: Model: A03559
FCC ID: IPH-03559 IC: 1792A-03559
- (3) Instruction Book:
Refer to Exhibit for Instruction Manual.
- (4) Description of Circuit Functions:
Refer to Exhibit of Operational Description.
- (5) Block Diagram with Frequencies:
Refer to Exhibit of Operational Description.
- (6) Report of Measurements:
Report of measurements follows in this Report.
- (7) Photographs: Construction, Component Placement, etc.:
Refer to Exhibit for photographs of equipment.
- (8) List of Peripheral Equipment Necessary for operation. The equipment operates from direct current power provided from internal rechargeable battery. The design provides interface options with unique USB cable and compatible equipment as presented in this filing. The EUT offers no other connection ports than those presented in this filing.
- (9) Transition Provisions of CFR47 15.37 are not requested.
- (10) Not Applicable. The unit is not a scanning receiver.
- (11) Not Applicable. The EUT does not operate in the 59 – 64 GHz frequency band.
- (12) The equipment is not software defined and this section is not applicable.
- (13) Applications for certification of U-NII devices in the 5.15-5.35 GHz and the 5.47-5.85 GHz bands must include a high-level operational description of the security procedures that control the radio frequency operating parameters and ensure that unauthorized modifications cannot be made. This requirement is not applicable to his DTS device.
- (14) Contain at least one drawing or photograph showing the test set-up for each of the required types of tests applicable to the device for which certification is requested. These drawings or photographs must show enough detail to confirm other information contained in the test report. Any photographs used must be focused originals without glare or dark spots and must clearly show the test configuration used. This information is provided in this report and Test Setup Exhibits provided with the application filing.

Applicable Standards & Test Procedures

In accordance with the Federal Communications Code of Federal Regulations, dated April 10, 2019: Part 2, Subpart J, Paragraphs 2.907, 2.911, 2.913, 2.925, 2.926, 2.1031 through 2.1057, and applicable parts of paragraph 15C Paragraph 15.225, Industry Canada RSS-210 issue 9, and RSS-GEN issue 5, the following information is submitted. Test procedures used are the established Methods of Measurement of Radio-Noise Emissions as described in the ANSI C63.10-2013 Document.

Equipment Testing Procedures

AC Line Conducted Emission Test Procedure

Testing for the AC line-conducted emissions was performed as required in CFR47 15C, RSS-210 and specified in ANSI C63.10-2013. The test setup, including the EUT, was arranged in the test configurations as presented during testing. The test configuration was placed on a 1 x 1.5-meter bench, 0.8 meters high located in a screen room. The power lines of the system were isolated from the power source using a standard LISN with a 50- μ Hy choke. EMI was coupled to the spectrum analyzer through a 0.1 μ F capacitor internal to the LISN. The LISN was positioned on the floor beneath the wooden bench supporting the EUT. The power lines and cables were draped over the back edge of the table. Refer to diagram one showing typical test arrangement and photographs in exhibits for EUT placement used during testing.

Radiated Emission Test Procedure

Radiated emissions testing was performed as required in 47CFR 15C, RSS-210 and specified in ANSI C63.10-2013. The EUT was placed on a rotating 0.9 x 1.2-meter platform, elevated as required above the ground plane at a distance of 3 meters from the FSM antenna. EMI energy was maximized by equipment placement permitting orientation in three orthogonal axes, raising and lowering the FSM antenna, changing the antenna polarization, and by rotating the turntable. Each emission was maximized before data was taken and recorded. The frequency spectrum from 9 kHz to 25,000 MHz was searched for emissions during preliminary investigation. Refer to diagrams two and three showing typical test setup. Refer to photographs in the test setup exhibits for specific EUT placement during testing.

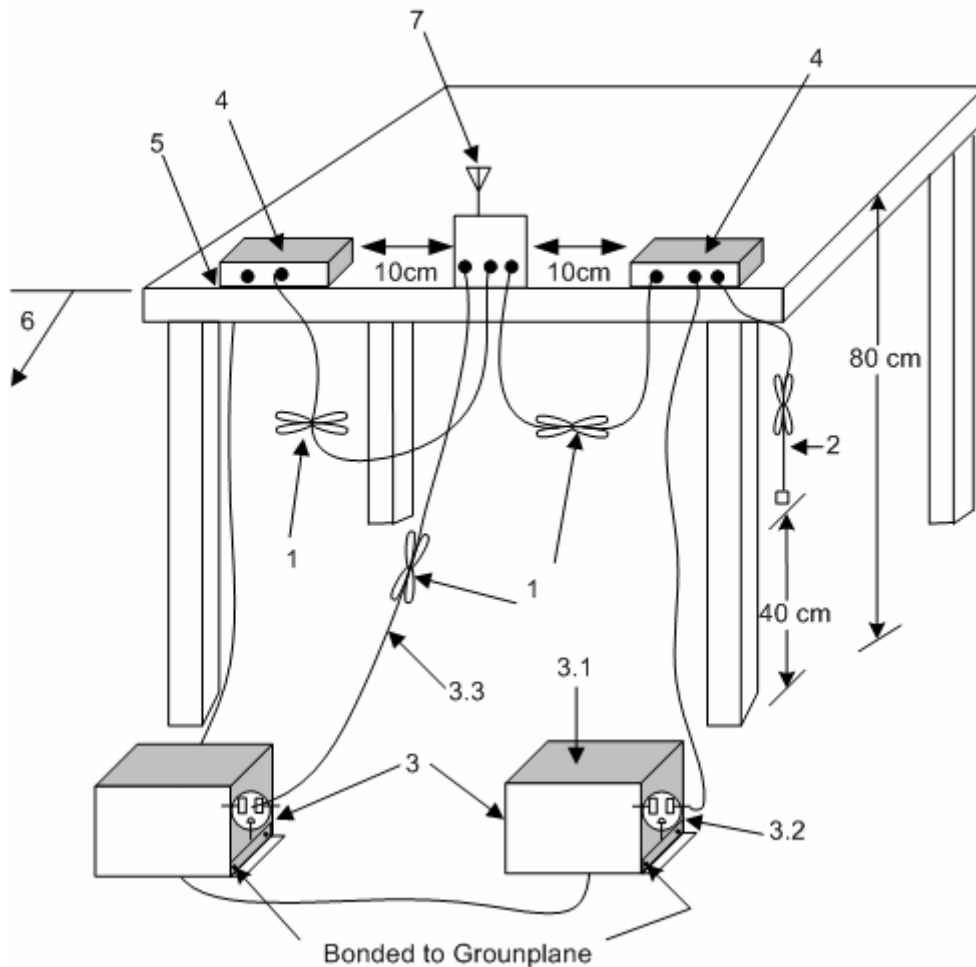

1. Interconnecting cables that hang closer than 40 cm to the ground plane shall be folded back and forth in the center forming a bundle 30 cm to 40 cm long see (see 6.2.3.1).
2. I/O cables that are not connected to an accessory shall be bundled in the center. The end of the cable may be terminated, if required, using the correct terminating impedance. The overall length shall not exceed 1 m (see 6.2.2).
3. EUT connected to one LISN. Unused LISN measuring port connectors shall be terminated in 50 Ω loads. LISN can be placed on top of, or immediately beneath, reference ground plane (see 6.2.2 and 6.2.3).
 - 3.1 All other equipment powered from additional LISN(s).
 - 3.2 Multiple-outlet strip can be used for multiple power cords of non-EUT equipment.
 - 3.3 LISN at least 80 cm from nearest part of EUT chassis.
4. Non-EUT components of EUT system being tested.
5. Rear of EUT, including peripherals, shall all be aligned and flush with rear of tabletop (see 6.2.3.1).
6. Edge of tabletop shall be 40 cm removed from a vertical conducting plane that is bonded to the ground plane (see 6.2.2 for options).
7. Antenna may be integral or detachable. If detachable, the antenna shall be attached for this test.

Diagram 1 Test arrangement for Conducted emissions

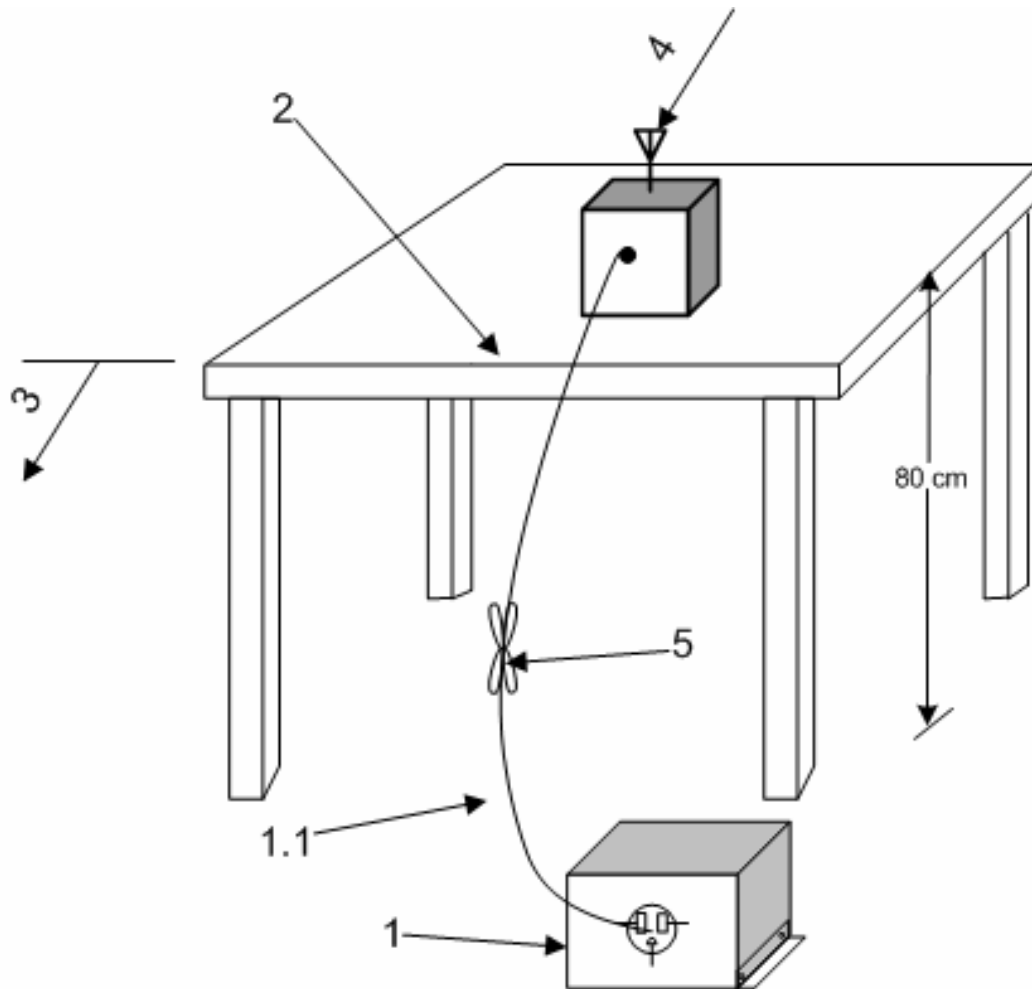

1—A LISN is optional for radiated measurements between 30 MHz and 1000 MHz but not allowed for measurements below 30 MHz and above 1000 MHz (see 6.3.1). If used, then connect EUT to one LISN. Unused LISN measuring port connectors shall be terminated in 50 Ω loads. The LISN may be placed on top of, or immediately beneath, the reference ground plane (see 6.2.2 and 6.2.3.2).

1.1—LISN spaced at least 80 cm from the nearest part of the EUT chassis.

2—Antenna can be integral or detachable, depending on the EUT (see 6.3.1).

3—Interconnecting cables that hang closer than 40 cm to the ground plane shall be folded back and forth in the center forming a bundle 30 cm to 40 cm long (see 6.3.1).

4—For emission measurements at or below 1 GHz, the table height shall be 80 cm. For emission measurements above 1 GHz, the table height shall be 1.5 m for measurements, except as otherwise specified (see 6.3.1 and 6.6.3.1).

Diagram 2 Test arrangement for radiated emissions of tabletop equipment

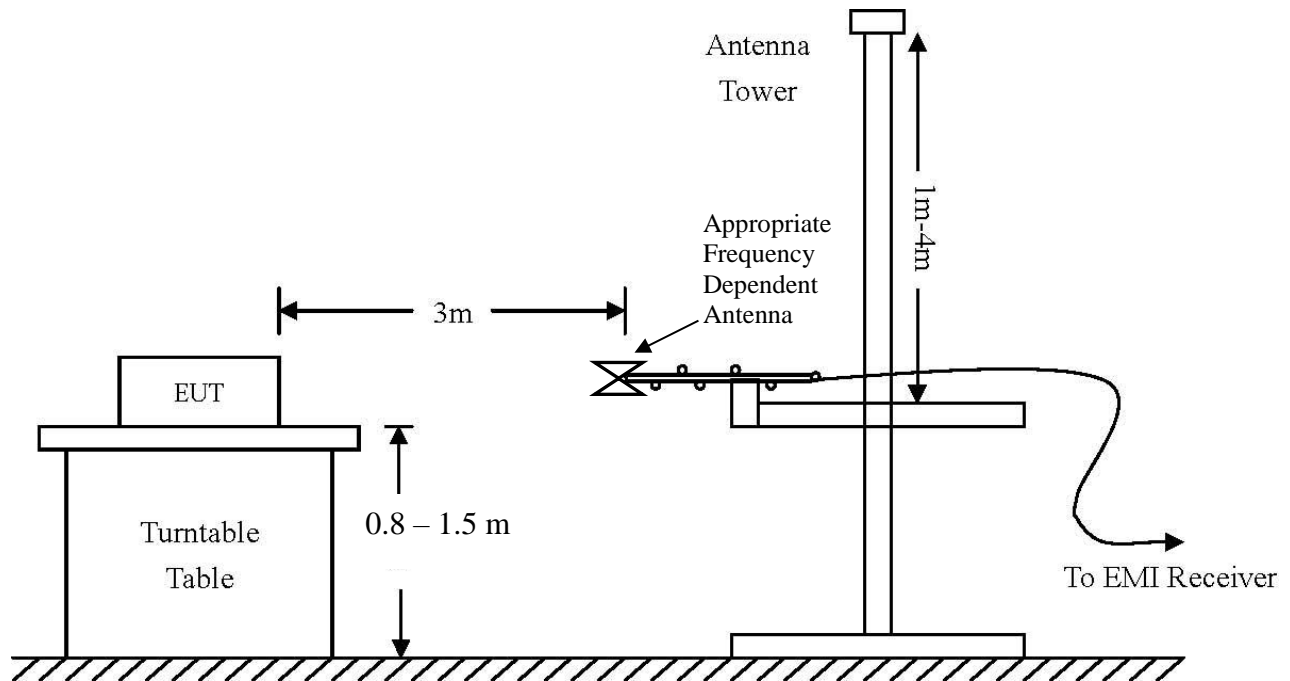

AC Line Conducted Emissions (0.150 -30 MHz)		
RBW	AVG. BW	Detector Function
9 kHz	30 kHz	Peak / Quasi Peak
Emissions (30-1000 MHz)		
RBW	AVG. BW	Detector Function
120 kHz	300 kHz	Peak / Quasi Peak
Emissions (Above 1000 MHz)		
RBW	Video BW	Detector Function
100 kHz	100 kHz	Peak
1 MHz	1 MHz	Peak / Average

Diagram 3 Test arrangement for radiated emissions tested on Open Area Test Site (OATS)

Test Site Locations

Conducted EMI The AC power line conducted emissions testing performed in a shielded screen room located at Rogers Labs, Inc., 4405 West 259th Terrace, Louisburg, KS

Radiated EMI The radiated emissions tests were performed at the 3 meters, Open Area Test Site (OATS) located at Rogers Labs, Inc., 4405 West 259th Terrace, Louisburg, KS

Registered Site information: FCC Site: US5305 and ISED #: 3041A, CAB Identifier: US0096

NVLAP Accreditation Lab code 200087-0

Rogers Labs, Inc.
4405 West 259th Terrace
Louisburg, KS 66053
Phone/Fax: (913) 837-3214
Revision 1

Garmin International, Inc.
Model: A03559
Test: 190410
Test to: CFR47 (15.225), RSS-210
File: A03559 NFC TstRpt 190410

SN's: 3991277219, 3992239593
FCC ID: IPH-03559
IC: 1792A-03559
Date: May 24, 2019
Page 14 of 38

List of Test Equipment

<u>Equipment</u>	<u>Manufacturer</u>	<u>Model (SN)</u>	<u>Band</u>	<u>Cal Date(m/d/y)</u>	<u>Due</u>
<input checked="" type="checkbox"/> LISN	FCC	FCC-LISN-50-25-10(1PA) (160611)	.15-30MHz	5/2/2018	5/2/2019
<input checked="" type="checkbox"/> LISN	Compliance Design	FCC-LISN-2.Mod.cd,(126)	.15-30MHz	10/16/2018	10/16/2019
<input checked="" type="checkbox"/> Cable	Huber & Suhner Inc.	Sucoflex102ea(L10M)(303073)	9kHz-40 GHz	10/16/2018	10/16/2019
<input checked="" type="checkbox"/> Cable	Huber & Suhner Inc.	Sucoflex102ea(1.5M)(303069)	9kHz-40 GHz	10/16/2018	10/16/2019
<input checked="" type="checkbox"/> Cable	Huber & Suhner Inc.	Sucoflex102ea(1.5M)(303071)	9kHz-40 GHz	10/16/2018	10/16/2019
<input checked="" type="checkbox"/> Cable	Belden	RG-58 (L1-CAT3-11509)	9kHz-30 MHz	10/16/2018	10/16/2019
<input checked="" type="checkbox"/> Cable	Belden	RG-58 (L2-CAT3-11509)	9kHz-30 MHz	10/16/2018	10/16/2019
<input type="checkbox"/> Antenna	ARA	BCD-235-B (169)	20-350MHz	10/16/2018	10/16/2019
<input type="checkbox"/> Antenna	EMCO	3147 (40582)	200-1000MHz	10/16/2018	10/16/2019
<input checked="" type="checkbox"/> Antenna	ETS-Lindgren	3117 (200389)	1-18 GHz	5/2/2018	5/2/2020
<input type="checkbox"/> Antenna	Com Power	AH-118 (10110)	1-18 GHz	10/16/2018	10/24/2019
<input checked="" type="checkbox"/> Antenna	Com Power	AH-840 (101046)	18-40 GHz	5/15/2017	5/15/2019
<input checked="" type="checkbox"/> Antenna	Com Power	AL-130 (121055)	.001-30 MHz	10/16/2018	10/16/2019
<input checked="" type="checkbox"/> Antenna	Sunol	JB-6 (A100709)	30-1000 MHz	10/16/2018	10/16/2019
<input checked="" type="checkbox"/> Analyzer	Rohde & Schwarz	ESU40 (100108)	20Hz-40GHz	5/2/2018	5/2/2019
<input checked="" type="checkbox"/> Analyzer	Rohde & Schwarz	ESW44 (101534)	20Hz-44GHz	1/31/2019	1/31/2020
<input type="checkbox"/> Analyzer	Rohde & Schwarz	FS-Z60, 90, 140, and 220	40GHz-220GHz	12/22/2017	12/22/2019
<input checked="" type="checkbox"/> Amplifier	Com-Power	PA-010 (171003)	100Hz-30MHz	10/16/2018	10/16/2019
<input checked="" type="checkbox"/> Amplifier	Com-Power	CPPA-102 (01254)	1-1000 MHz	10/16/2018	10/16/2019
<input checked="" type="checkbox"/> Amplifier	Com-Power	PAM-118A (551014)	0.5-18 GHz	10/16/2018	10/16/2019
<input checked="" type="checkbox"/> Amplifier	Com-Power	PAM-840A (461328)	18-40 GHz	10/16/2018	10/16/2019
<input type="checkbox"/> Power Meter	Agilent	N1911A with N1921A	0.05-40 GHz	5/2/2018	5/2/2019
<input type="checkbox"/> Generator	Rohde & Schwarz	SMB100A6 (100150)	20Hz-6 GHz	5/2/2018	5/2/2019
<input type="checkbox"/> Generator	Rohde & Schwarz	SMBV100A6 (260771)	20Hz-6 GHz	5/2/2018	5/2/2019
<input type="checkbox"/> RF Filter	Micro-Tronics	BRC50722 (009).9G notch	30-1800 MHz	5/2/2018	5/2/2019
<input type="checkbox"/> RF Filter	Micro-Tronics	HPM50114 (017)1.5G HPF	30-18000 MHz	5/2/2018	5/2/2019
<input type="checkbox"/> RF Filter	Micro-Tronics	HPM50117 (063) 3G HPF	30-18000 MHz	5/2/2018	5/2/2019
<input type="checkbox"/> RF Filter	Micro-Tronics	HPM50105 (059) 6G HPF	30-18000 MHz	5/2/2018	5/2/2019
<input type="checkbox"/> RF Filter	Micro-Tronics	BRM50702 (172) 2G notch	30-1800 MHz	5/2/2018	5/2/2019
<input type="checkbox"/> RF Filter	Micro-Tronics	BRC50703 (G102) 5G notch	30-1800 MHz	5/2/2018	5/2/2019
<input type="checkbox"/> RF Filter	Micro-Tronics	BRC50705 (024) 5G notch	30-1800 MHz	5/2/2018	5/2/2019
<input type="checkbox"/> Attenuator	Fairview	SA6NFN100W-14 (1625)	30-1800 MHz	5/2/2018	5/2/2019
<input checked="" type="checkbox"/> Attenuator	Mini-Circuits	VAT-3W2+ (1735)	30-6000 MHz	5/2/2018	5/2/2019
<input type="checkbox"/> Attenuator	Mini-Circuits	VAT-3W2+ (1436)	30-6000 MHz	5/2/2018	5/2/2019
<input type="checkbox"/> Attenuator	Mini-Circuits	VAT-3W2+ (14362)	30-6000 MHz	5/2/2018	5/2/2019
<input type="checkbox"/> Attenuator	Mini-Circuits	VAT-3W2+ (1445)	30-6000 MHz	5/2/2018	5/2/2019
<input type="checkbox"/> Attenuator	Mini-Circuits	VAT-3W2+ (14452)	30-6000 MHz	5/2/2018	5/2/2019
<input type="checkbox"/> Attenuator	Mini-Circuits	VAT-6W2+ (1438)	30-6000 MHz	5/2/2018	5/2/2019
<input type="checkbox"/> Attenuator	Mini-Circuits	VAT-6W2+ (1736)	30-6000 MHz	5/2/2018	5/2/2019
<input type="checkbox"/> Attenuator	JFW Industries	50FH-010-10 (1)	30-18000 MHz	5/2/2018	5/2/2019
<input checked="" type="checkbox"/> Weather station	Davis	6312 (A81120N075)		10/26/2018	10/26/2019

Units of Measurements

Conducted EMI Data is in dB μ V; dB referenced to one microvolt

Radiated EMI Data is in dB μ V/m; dB/m referenced to one microvolt per meter

Sample Calculation:

RFS = Radiated Field Strength, FSM = Field Strength Measured

A.F. = Receive antenna factor, Gain = amplification gains and/or cable losses

RFS (dB μ V/m @ 3m) = FSM (dB μ V) + A.F. (dB) - Gain (dB)

Environmental Conditions

Ambient Temperature 20.6° C

Relative Humidity 41%

Atmospheric Pressure 1015.4 mb

Statement of Modifications and Deviations

No modifications to the EUT were required for the equipment to demonstrate compliance with the CFR47 Part 15C, Industry Canada RSS-210 Issue 9, and RSS-GEN emission requirements. There were no deviations to the specifications.

Intentional Radiators

The following information is submitted supporting demonstration of compliance with the requirements of 47CFR, Subpart C, paragraph 15.225 and RSS-210 the following information is submitted.

Antenna Requirements

The EUT incorporates integral antenna system and offers no provision for connection to alternate system. The antenna connection point complies with the unique antenna connection requirements. The unique antenna connection requirements are fulfilled. There are no deviations or exceptions to the specification.

Restricted Bands of Operation

Spurious emissions falling in the restricted frequency bands of operation were measured at the OATS. The EUT utilizes frequency, determining circuitry, which generates harmonics falling in the restricted bands. Emissions were investigated at the OATS, using appropriate antennas or pyramidal horns, amplification stages, and a spectrum analyzer. Peak and average amplitudes of frequencies above 1000 MHz were compared to the required limits with worst-case data presented below. Test procedures of ANSI C63.10-2013 paragraph 6 were used during testing. No other significant emission was observed which fell into the restricted bands of operation. Computed emission values take into account the received radiated field strength, receive antenna correction factor, amplifier gain stage, and test system cable losses.

Table 1 Radiated Emissions in Restricted Bands Data

Frequency in MHz	Horizontal Peak (dBµV/m)	Horizontal Quasi-Peak (dBµV/m)	Horizontal Average (dBµV/m)	Vertical Peak (dBµV/m)	Vertical Quasi-Peak (dBµV/m)	Vertical Average (dBµV/m)	Limit @ 3m (dBµV/m)
117.5	26.0	19.3	N/A	19.3	18.1	N/A	43.5
133.5	26.7	22.7	N/A	22.7	14.7	N/A	43.5

Summary of Results for Radiated Emissions in Restricted Bands

The EUT demonstrated compliance with the radiated emissions requirements of CFR Title 47 Part 15C and RSS-210 Intentional Radiators. The EUT demonstrated a worst-case minimum margin of -24.3 dB below the radiated emissions requirements in restricted frequency bands. Peak, Quasi-peak, and average amplitudes were checked for compliance with the regulations. Worst-case emissions are reported with other emissions found in the restricted frequency bands at least 20 dB below the requirements.

AC Line Conducted EMI Procedure

The EUT was arranged in typical equipment configurations operating from AC power adapter. Testing was performed with the EUT placed on a 1 x 1.5-meter wooden bench 80 cm above the conducting ground plane, floor of a screen room. The bench was positioned 40 cm away from the wall of the screen room. The LISN was positioned on the floor of the screen room 80-cm from the rear of the EUT. Testing for the line-conducted emissions were the procedures of ANSI C63.10-2013 paragraph 6. The AC adapter for the EUT was connected to the LISN for line-conducted emissions testing. A second LISN was positioned on the floor of the screen room 80-cm from the rear of the supporting equipment of the EUT. All power cords except the EUT were then powered from the second LISN. EMI was coupled to the spectrum analyzer through a 0.1 μ F capacitor, internal to the LISN. Power line conducted emissions testing was carried out individually for each current carrying conductor of the EUT. The excess length of lead between the system and the LISN receptacle was folded back and forth to form a bundle not exceeding 40 cm in length. The screen room, conducting ground plane, analyzer, and LISN were bonded together to the protective earth ground. Preliminary testing was performed to identify the frequencies of each of the emissions, which demonstrated the highest amplitudes. The cables were repositioned to obtain maximum amplitude of measured EMI level. Once the worst-case configuration was identified, plots were made of the EMI from 0.15 MHz to 30 MHz then data was recorded with maximum conducted emissions levels.

Refer to figures one and two for plots of the EUT – USB Computer interface AC Line conducted emissions. Refer to figures three and four showing plots of the AC Adapter configuration worst-case line conducted emissions.

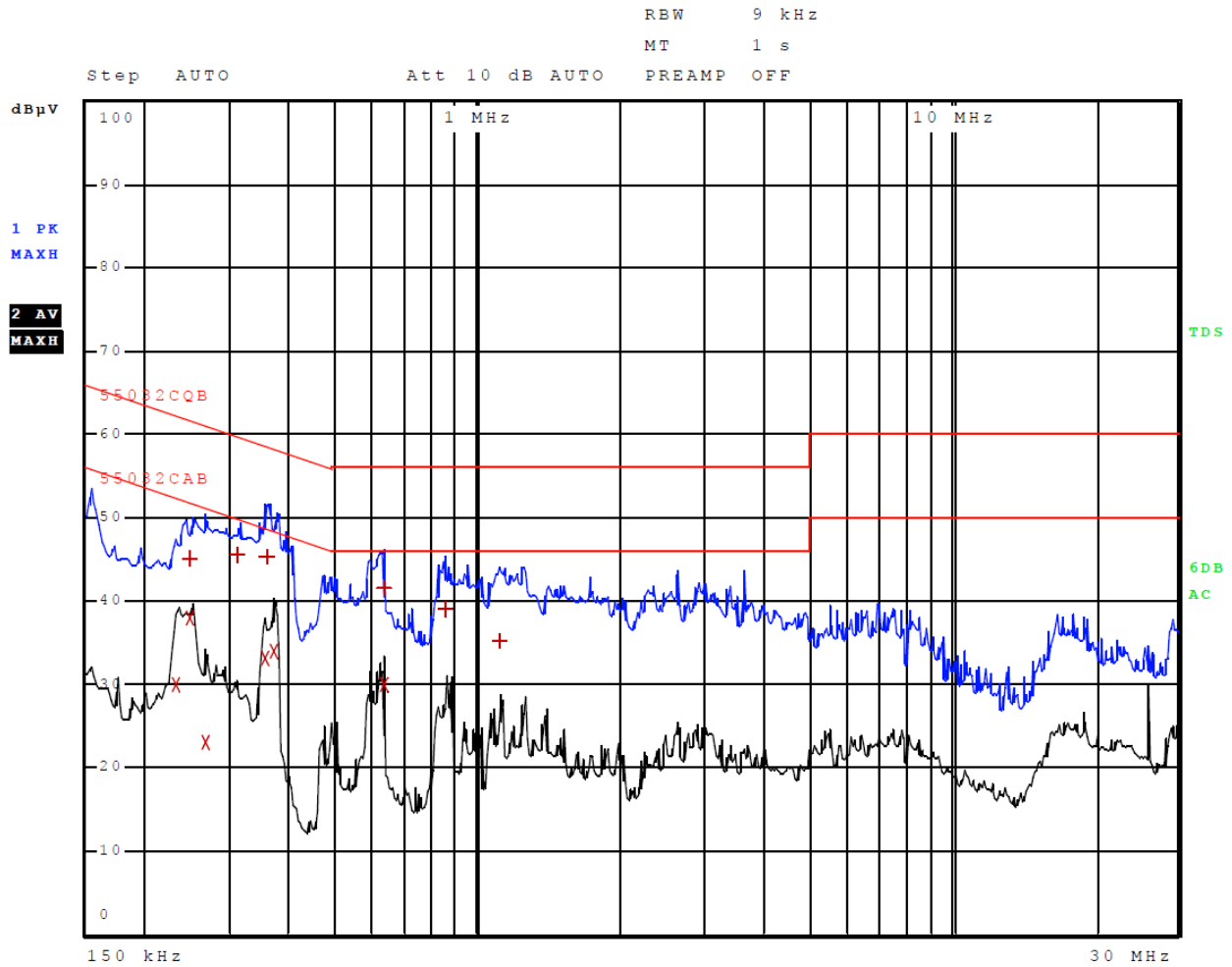

Figure 1 AC Line Conducted emissions of EUT line 1 (#2, EUT – Computer)

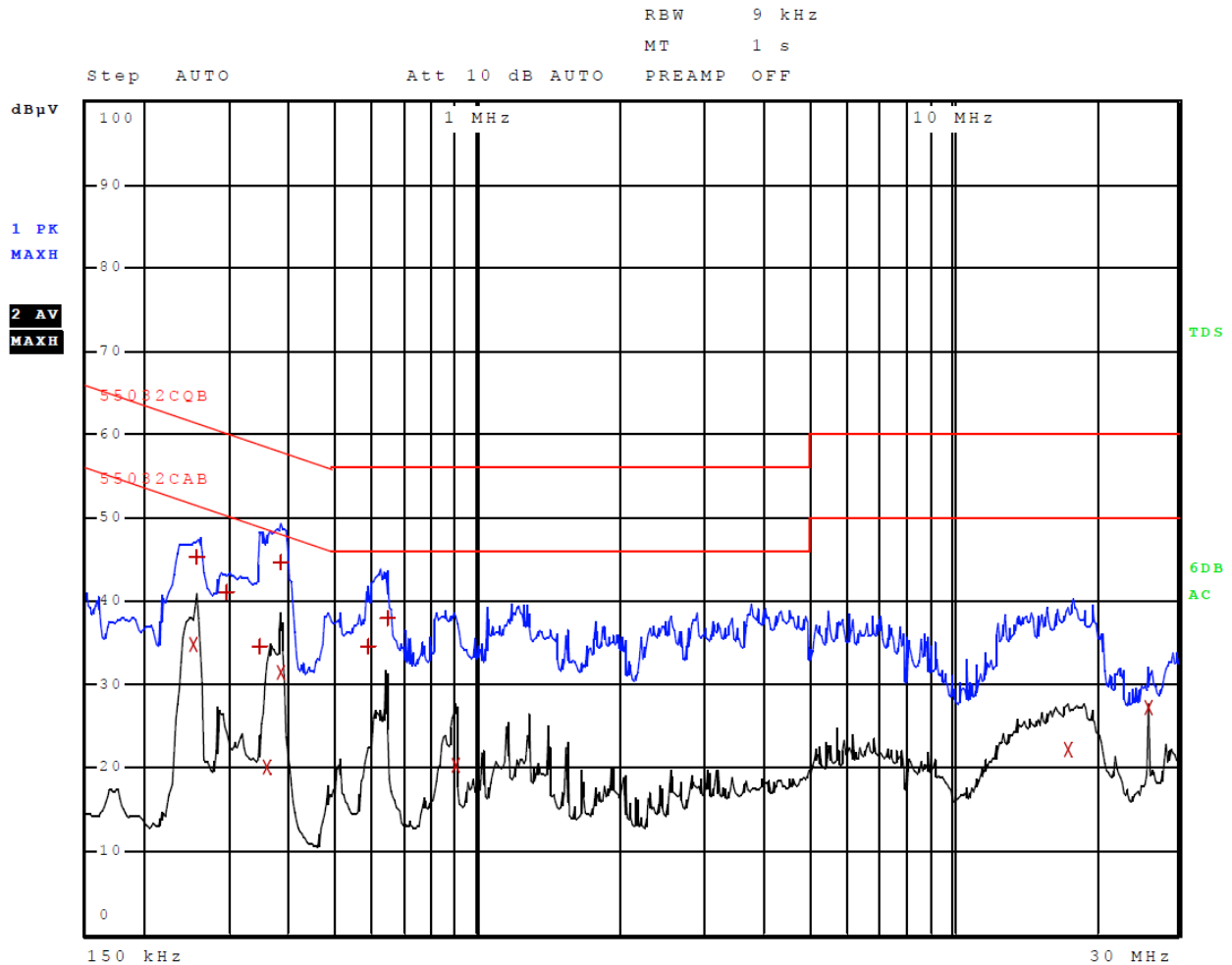

Figure 2 AC Line Conducted emissions of EUT line 2 (#2, EUT – Computer)

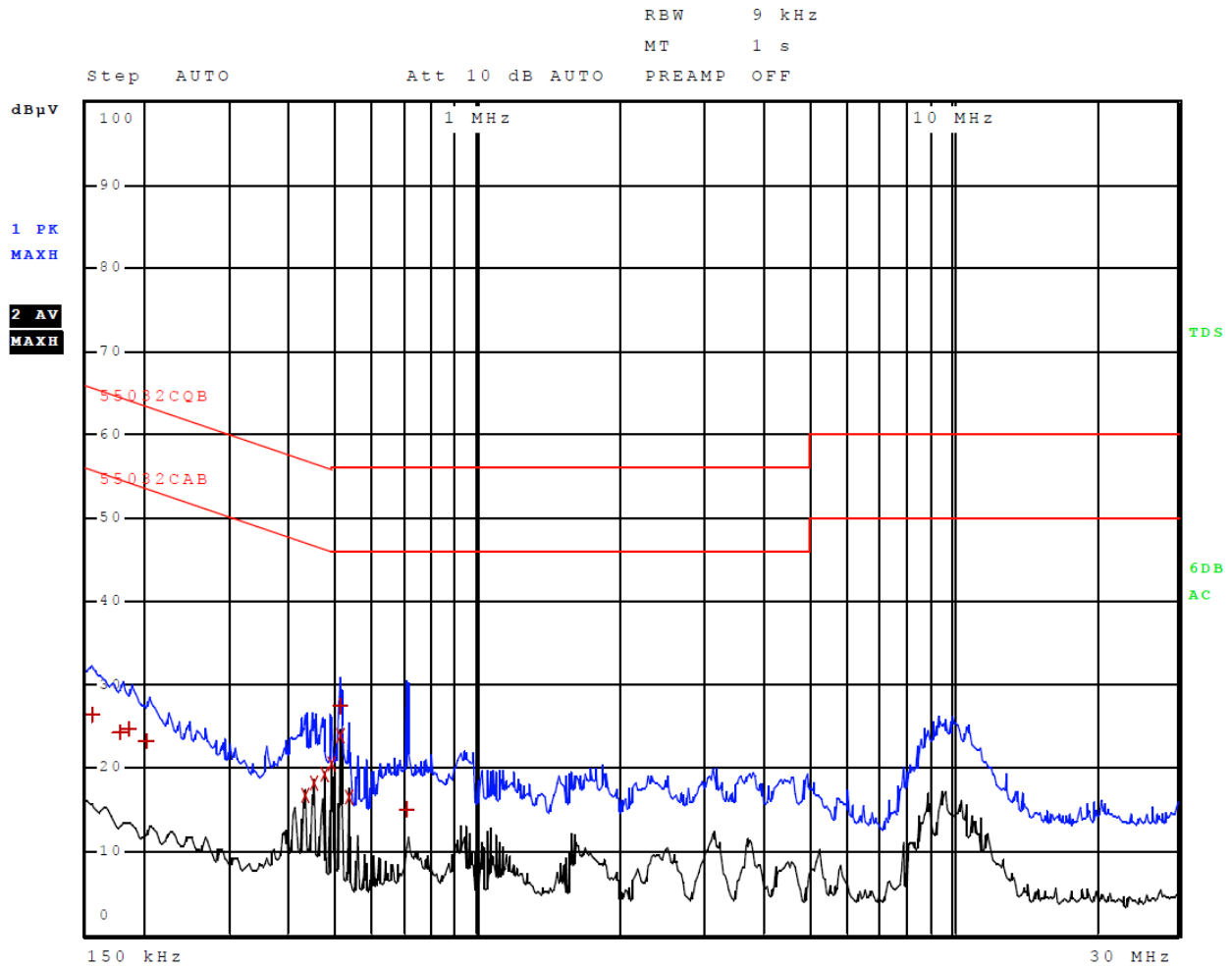

Figure 3 AC Line Conducted emissions of EUT line 1 (#3, EUT – 362-00091-00)

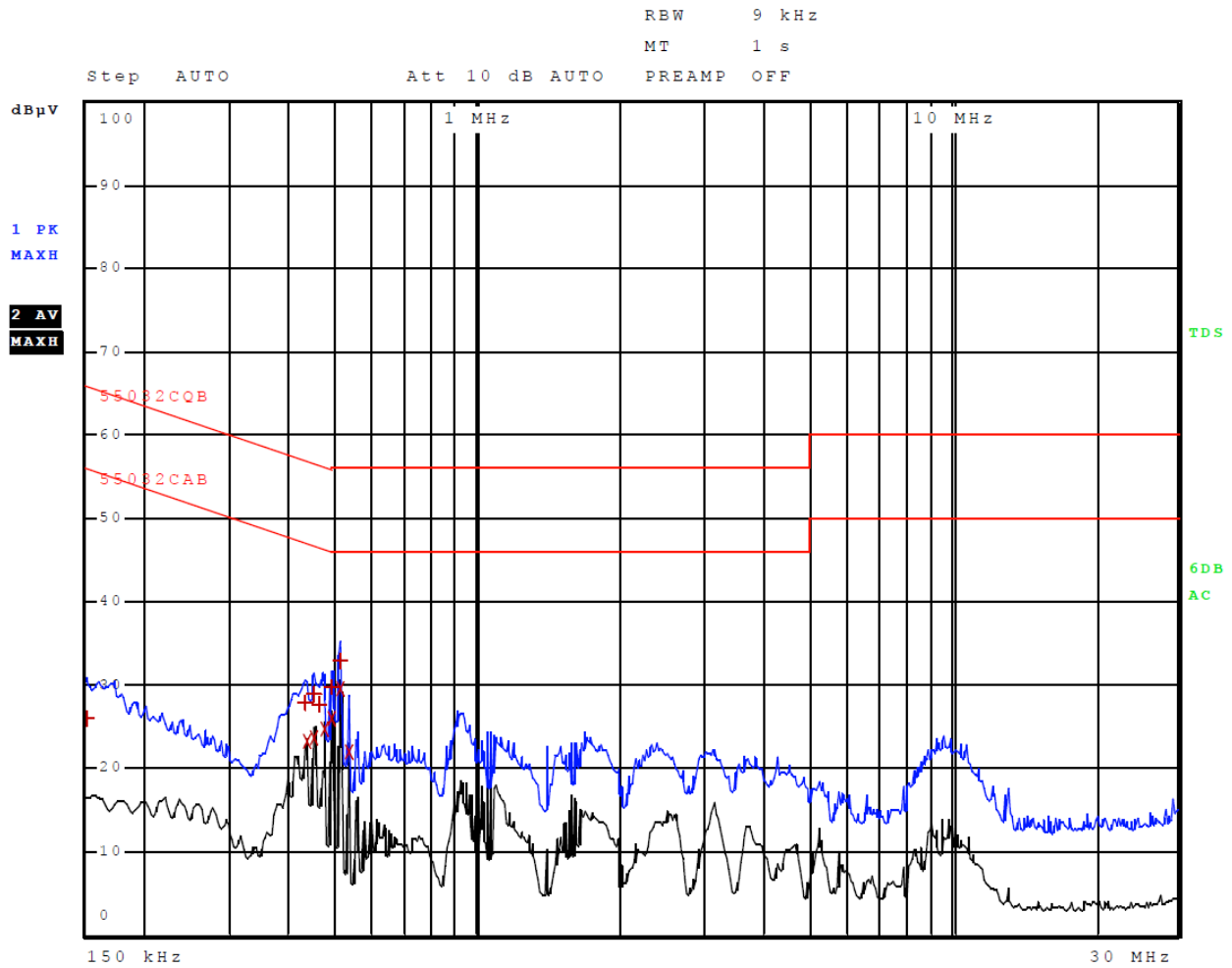

Figure 4 AC Line Conducted emissions of EUT line 2 (#3, EUT – 362-00091-00)

Table 2 AC Line Conducted Emissions Data L1 (configuration #2, EUT – Computer)

Trace	Frequency	Level (dBµV)	Detector	Delta Limit/dB
2	234.000000000 kHz	29.97	Average	-22.33
1	250.000000000 kHz	45.12	Quasi Peak	-16.64
2	250.000000000 kHz	38.02	Average	-13.73
2	266.000000000 kHz	23.10	Average	-28.14
1	314.000000000 kHz	45.47	Quasi Peak	-14.39
2	354.000000000 kHz	33.11	Average	-15.76
1	362.000000000 kHz	45.38	Quasi Peak	-13.30
2	370.000000000 kHz	34.01	Average	-14.49
2	630.000000000 kHz	30.00	Average	-16.00
1	630.000000000 kHz	41.56	Quasi Peak	-14.44
1	854.000000000 kHz	38.92	Quasi Peak	-17.08
1	1.106000000 MHz	35.12	Quasi Peak	-20.88

Other emissions present had amplitudes at least 20 dB below the limit.

Table 3 AC Line Conducted Emissions Data L2 (configuration #2, EUT – Computer)

Trace	Frequency	Level (dBµV)	Detector	Delta Limit/dB
2	254.000000000 kHz	34.80	Average	-16.82
1	258.000000000 kHz	45.27	Quasi Peak	-16.23
1	298.000000000 kHz	41.13	Quasi Peak	-19.17
1	346.000000000 kHz	34.63	Quasi Peak	-24.43
2	362.000000000 kHz	20.02	Average	-28.66
2	382.000000000 kHz	31.41	Average	-16.83
1	382.000000000 kHz	44.74	Quasi Peak	-13.49
1	586.000000000 kHz	34.46	Quasi Peak	-21.54
1	642.000000000 kHz	37.92	Quasi Peak	-18.08
2	894.000000000 kHz	20.21	Average	-25.79
2	17.552000000 MHz	22.17	Average	-27.83
2	25.872000000 MHz	27.30	Average	-22.70

Other emissions present had amplitudes at least 20 dB below the limit.

Table 4 AC Line Conducted Emissions Data L1 (configuration #3, EUT – 362-00091-00)

Trace	Frequency	Level (dBµV)	Detector	Delta Limit/dB
1	154.000000000 kHz	26.26	Quasi Peak	-39.52
1	178.000000000 kHz	24.32	Quasi Peak	-40.26
1	186.000000000 kHz	24.68	Quasi Peak	-39.54
1	202.000000000 kHz	23.23	Quasi Peak	-40.30
2	430.000000000 kHz	16.71	Average	-30.54
2	450.000000000 kHz	18.26	Average	-28.62
2	470.000000000 kHz	19.15	Average	-27.36
2	490.000000000 kHz	20.53	Average	-25.64
1	510.000000000 kHz	27.40	Quasi Peak	-28.60
2	510.000000000 kHz	23.93	Average	-22.07
2	534.000000000 kHz	16.50	Average	-29.50
1	706.000000000 kHz	15.02	Quasi Peak	-40.98

Other emissions present had amplitudes at least 20 dB below the limit.

Table 5 AC Line Conducted Emissions Data L2 (configuration #3, – 362-00091-00)

Trace	Frequency	Level (dBµV)	Detector	Delta Limit/dB
1	150.000000000 kHz	25.91	Quasi Peak	-40.09
1	430.000000000 kHz	27.74	Quasi Peak	-29.51
2	434.000000000 kHz	23.22	Average	-23.95
1	450.000000000 kHz	28.78	Quasi Peak	-28.09
2	450.000000000 kHz	23.65	Average	-23.22
1	466.000000000 kHz	27.60	Quasi Peak	-28.98
2	470.000000000 kHz	24.64	Average	-21.88
2	490.000000000 kHz	25.87	Average	-20.29
1	490.000000000 kHz	29.64	Quasi Peak	-26.53
2	510.000000000 kHz	29.51	Average	-16.49
1	510.000000000 kHz	32.93	Quasi Peak	-23.07
2	534.000000000 kHz	21.90	Average	-24.10

Other emissions present had amplitudes at least 20 dB below the limit.

Summary of Results for AC Line Conducted Emissions Results

The EUT demonstrated compliance with the AC Line Conducted Emissions requirements of 47CFR Part 15C and other applicable emissions requirements. The EUT configurations #2 worst-case configuration demonstrated a minimum margin of -13.4 dB below the requirement. The EUT configuration #3 worst-case configuration demonstrated a minimum margin of -16.4 dB below the requirement. Other emissions were present with amplitudes at least 20 dB below the limit and worst-case amplitudes recorded.

General Radiated Emissions Procedure

The EUT was arranged in a typical equipment configuration and operated through all available mode during testing. Preliminary testing was performed in a screen room with the EUT positioned 1 meter from the FSM. Radiated emissions measurements were performed to identify the frequencies, which produced the highest emissions. Each radiated emission was then maximized at the OATS location before final radiated measurements were performed. Final data was taken with the EUT located at the OATS at 3 meters distance between the EUT and the receiving antenna. The frequency spectrum from 9 kHz to 25,000 MHz was searched for general radiated emissions. Measured emission levels were maximized by EUT placement on the table, rotating the turntable through 360 degrees, varying the antenna height between 1 and 4 meters above the ground plane and changing antenna position between horizontal and vertical polarization. Antennas used were Loop from 9 kHz to 30 MHz, Broadband Biconical from 30 to 200 MHz, Biconilog from 30 to 1000 MHz, Log Periodic from 200 MHz to 1 GHz and or double Ridge or pyramidal horns and mixers above 1 GHz, notch filters and appropriate amplifiers and external mixers were utilized.

Table 6 General Radiated Emissions from EUT Data (Highest Emissions)

Frequency in MHz	Horizontal Peak (dBµV/m)	Horizontal Quasi-Peak (dBµV/m)	Horizontal Average (dBµV/m)	Vertical Peak (dBµV/m)	Vertical Quasi-Peak (dBµV/m)	Vertical Average (dBµV/m)	Limit @ 3m (dBµV/m)
58.5	28.2	23.4	N/A	23.4	26.7	N/A	40.0
117.5	26.0	19.3	N/A	19.3	18.1	N/A	40.0
133.5	26.7	22.7	N/A	22.7	14.7	N/A	40.0
141.9	27.3	22.8	N/A	22.8	19.3	N/A	40.0
149.6	37.0	17.5	N/A	17.5	29.4	N/A	40.0
154.0	29.6	18.0	N/A	18.0	18.8	N/A	40.0

Other emissions present had amplitudes at least 20 dB below the limit. Peak and Quasi-Peak amplitude emissions are recorded for frequency range below 1000 MHz. Peak and Average amplitude emissions are recorded for frequency range above 1000 MHz.

Summary of Results for General Radiated Emissions

The EUT demonstrated compliance with the radiated emissions requirements of CFR47 Part 15C paragraph 15.209, RSS-210 and RSS-GEN Intentional Radiators. The EUT demonstrated a minimum margin of -10.6 dB below the requirements. Other emissions were present with amplitudes at least 20 dB below the Limits.

Operation in the Band 13.110 - 14.010 MHz Band

The transmitter output power; harmonic and general emissions were measured on an open area test site at 3 and 10 meters. Test procedures of ANSI C63.10-2013 were used during testing. The EUT was placed on a turntable elevated as required above the ground plane and at a distance of 3 and 10 meters from the FSM antenna. The peak and quasi-peak amplitude of frequencies below 1000 MHz were measured using a spectrum analyzer. Plots were taken of transmitter performance for reference in this and other documentation. The amplitude of each radiated emission was measured on the OATS at a distance of 3 and/or 10 meters from the FSM antenna (OATS testing was performed on sample 1 representative of production equipment with integral antenna). The measured amplitude was then corrected for comparison with the limits. Measurements taken at 3 meters of the fundamental and emissions below 30 MHz were corrected using the square of an inverse linear distance extrapolation factor (40 dB/decade) as provided in the standards and requirements. The amplitude of each radiated emission was maximized by varying the FSM antenna height, polarization, and by rotating the turntable. A Loop antenna was used for measuring emissions from 0.009 to 30 MHz, Biconilog Antenna for 30 to 1000 MHz, Double-Ridge, and/or Pyramidal Horn Antennas from 1 GHz to 25 GHz. Emissions were measured in dB μ V/m @ 3 meters. Testing performed demonstrated compliance with the following requirements (per CFR47 15.225). Refer to figure five through nine showing the operation in the frequency band.

- (a) The field strength of any emissions within the band 13.553-13.567 MHz shall not exceed 15,848 microvolts/meter at 30 meters (84 dB μ V/M @ 30m).
- (b) Within the bands 13.410-13.553 MHz and 13.567-13.710 MHz, the field strength of any emissions shall not exceed 334 microvolts/meter at 30 meters (50.5 dB μ V/M @ 30m).
- (c) Within the bands 13.110-13.410 MHz and 13.710-14.010 MHz the field strength of any emissions shall not exceed 106 microvolts/meter at 30 meters (40.5 dB μ V/M @ 30m).
- (d) The field strength of any emissions appearing outside of the 13.110-14.010 MHz band shall not exceed the general radiated emission limits in § 15.209.
- (e) The frequency tolerance of the carrier signal shall be maintained within $\pm 0.01\%$ of the operating frequency over a temperature variation of -20 degrees to $+50$ degrees C at normal supply voltage, and for a variation in the primary supply voltage from 85% to 115% of the rated supply voltage at a temperature of 20 degrees C. For battery-operated equipment, the equipment tests shall be performed using a new battery.
- (f) In the case of radio frequency powered tags designed to operate with a device authorized under this section, the tag may be approved with the device or be considered as a separate device subject to its own authorization. Powered tags approved with a device under a single application shall be labeled with the same identification number as the device.

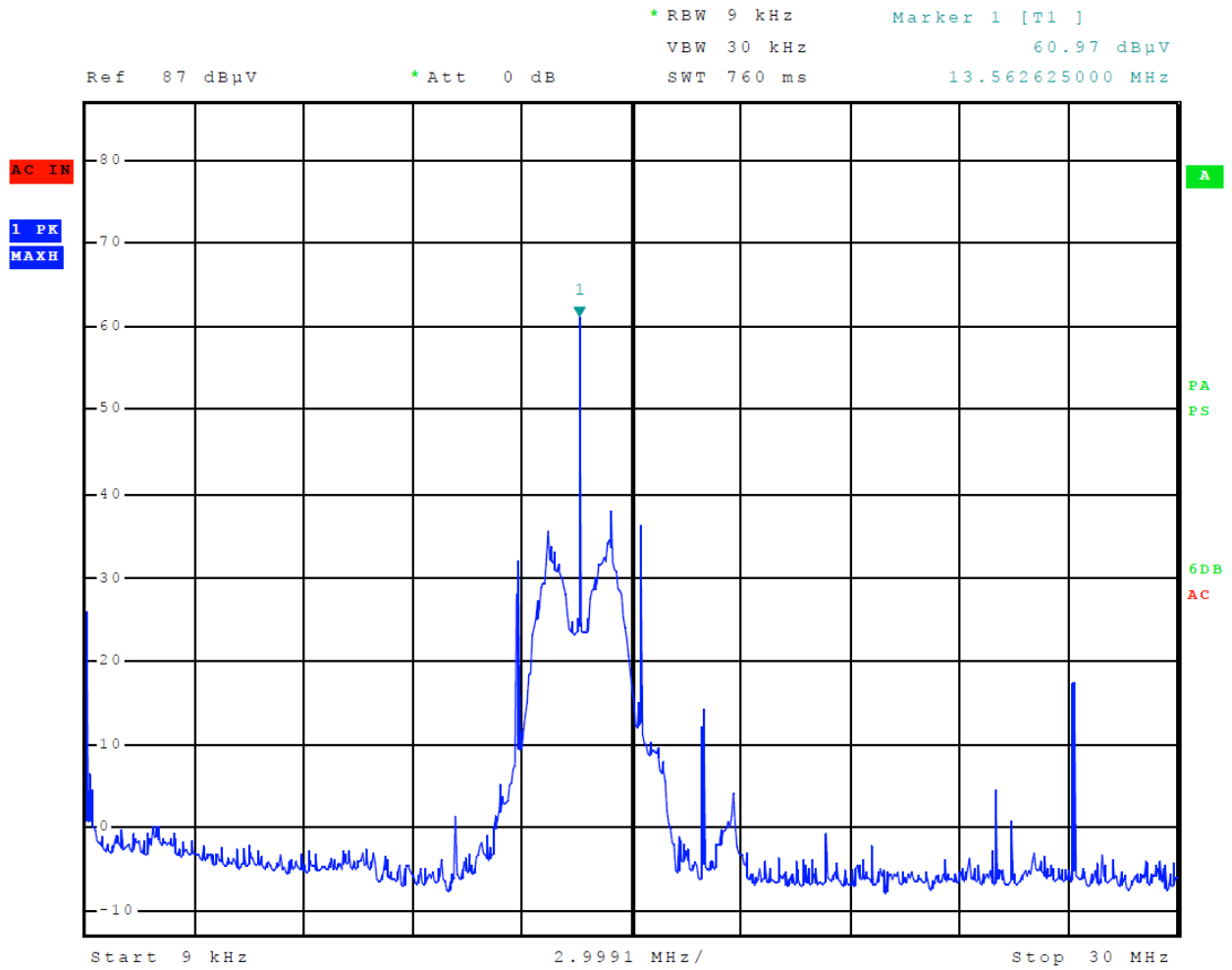

Figure 5 Plot of NFC Operation Across Frequency Spectrum

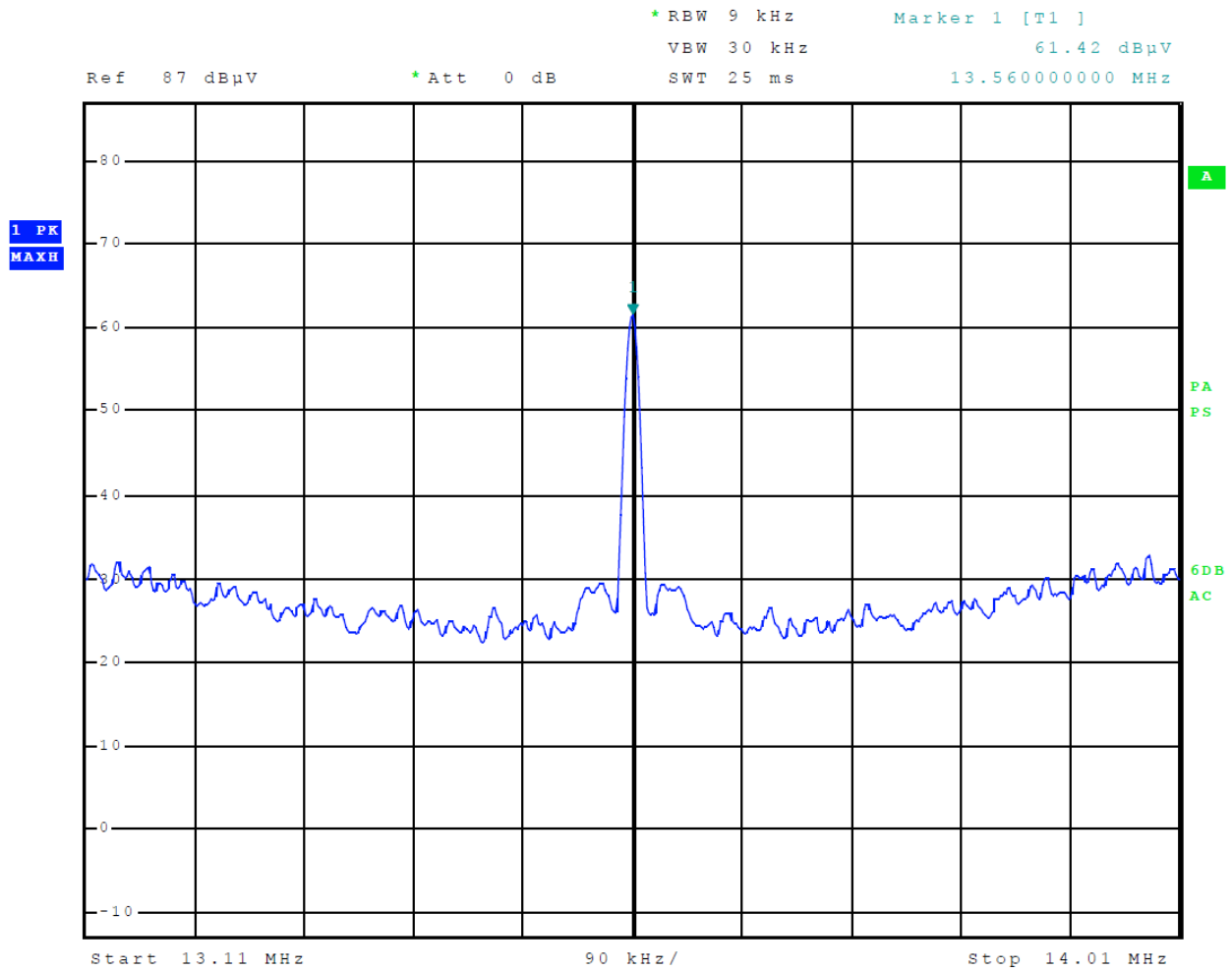

Figure 6 Plot of NFC Operation in Authorized Frequency Band

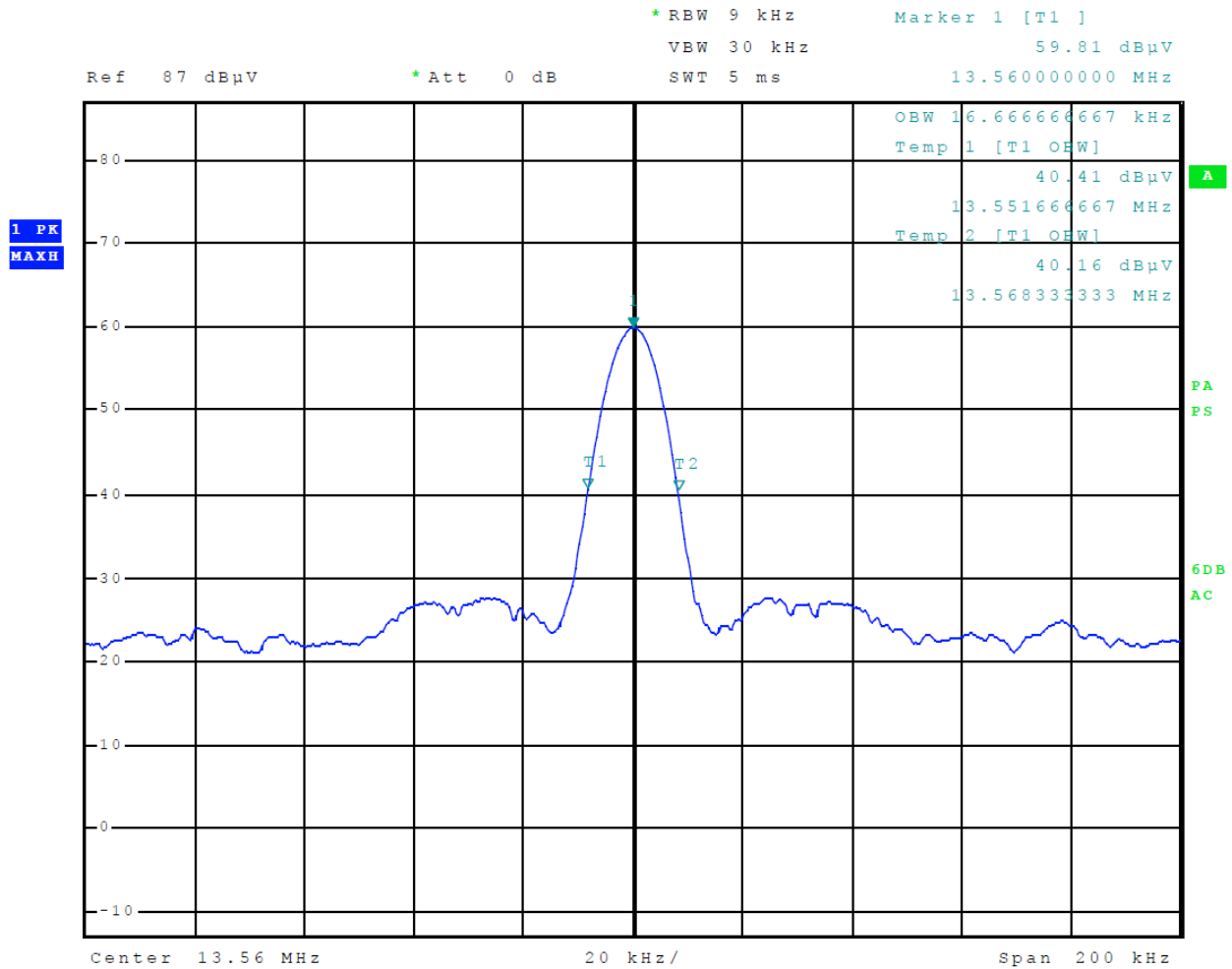

Figure 7 Plot of NFC 99 percent Occupied Bandwidth

Table 7 NFC Transmitter Emissions in Frequency Band 13.110-14.010 MHz

Frequency in MHz	Peak Level (dBμV/m)	Quasi-Peak Level (dBμV/m)	Limit (dBμV/m) @ 3m	Margin (dB)
13.560	62.7	57.8	124.0	-61.3

Other emissions present had amplitudes at least 20 dB below the limit. Peak and Quasi-Peak amplitude emissions are recorded above for frequencies below 1000 MHz. Peak and Average amplitude emissions are recorded above for frequency range above 1000 MHz.

NOTES:

1. Fundamental radiated emission measurements were performed using a loop antenna. The test sample was positioned in three orthogonal positions (X front, Y side, Z top) and the position with the highest emission level was recorded.
2. The EUT was positioned in three orthogonal planes to determine the orientation resulting in the worst-case emissions. The worst-case emission was found when the front of the EUT was facing the receive antenna.

3. Measurements were performed at 3m and the limit was extrapolated to the measurement distance of 3 m using the square of an inverse linear distance extrapolation factor (40 dB/decade) as specified in §15.31(f)(2). Extrapolation Factor = $20 \log_{10} (30/3)^2 = 40\text{dB}$
4. All measurements were recorded using a spectrum analyzer employing peak and quasi-peak detectors.
5. Field Strength Level [dBμV/m] = Level read from Analyzer [dBμV] + AFCL [dB/m] – Amplifier Gain (dB)
6. AFCL [dB/m] = Antenna Factor [dB/m] + Cable Loss [dB]
7. Margin [dB] = Field Strength Level [dBμV/m] – Limit [dBμV/m]

Table 8 Transmitter Harmonic Radiated Emissions Data

Frequency in MHz	Horizontal Peak (dBμV/m)	Horizontal Quasi-Peak (dBμV/m)	Horizontal Average (dBμV/m)	Vertical Peak (dBμV/m)	Vertical Quasi-Peak (dBμV/m)	Vertical Average (dBμV/m)	Limit @ 3m (dBμV/m)
40.7	32.4	27.6	N/A	37.5	32.1	N/A	40
54.2	35.8	32.2	N/A	37.3	32.5	N/A	40
67.8	29.3	23.5	N/A	28.5	22.3	N/A	40
81.3	33.3	28.9	N/A	34.4	26.7	N/A	40

Other emissions present had amplitudes at least 20 dB below the limit. Peak and Quasi-Peak amplitude emissions are recorded above for frequencies below 1000 MHz. Peak and Average amplitude emissions are recorded above for frequency range above 1000 MHz.

Summary of Results for Transmitter Radiated Emissions of Intentional Radiator

The EUT demonstrated compliance with the radiated emissions requirements of FCC 47 CFR Part 15.225, Industry Canada RSS-GEN issue 5, RSS-210 issue 9 Intentional Radiator regulations. The EUT worst-case configuration demonstrated minimum margin of -61.3 dB below the limit for the fundamental. The EUT worst-case configuration demonstrated minimum radiated harmonic emission margin of -7.5 dB below the limit. No other radiated emissions were found in the restricted bands less than 20 dB below limits than those recorded in this report. Other emissions were present with amplitudes at least 20 dB below the limits.

Frequency Stability

Measurements Required

The frequency stability shall be measured with variations of ambient temperature from -30° to +50° centigrade. Measurements shall be made at the extremes of the temperature range and at intervals of not more than 10° centigrade through the range. A period sufficient to stabilize all of the components of the oscillator circuit at each temperature level shall be allowed prior to frequency measurement. In addition to temperature stability, the frequency stability shall be measured with variation of primary supply voltage as follows:

- (1) Vary primary supply voltage from 85 to 115 percent of the nominal value.
- (2) The supply voltage shall be measured at the input to the cable normally provided with the equipment, or at the power supply terminals if cables are not normally provided.

Test Arrangement

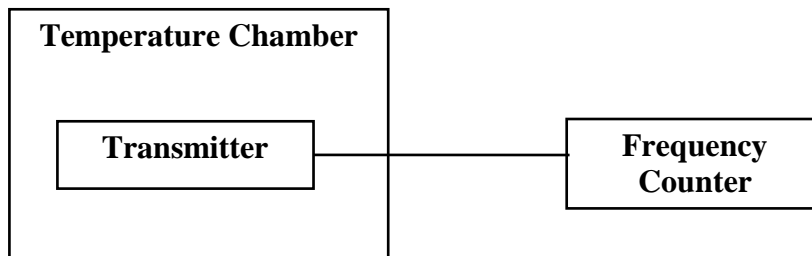

The measurement procedure outlined below shall be followed during measurement of frequency variation over temperature.

Step 1: The transmitter shall be installed in an environmental test chamber whose temperature is controllable. Provision shall be made to measure the frequency of the transmitter.

Step 2: With the transmitter inoperative (power switched “OFF”), the temperature of the test chamber shall be adjusted to +25°C. After a temperature stabilization period of one hour at +25°C, the transmitter shall be switched “ON” with standard test voltage applied.

Step 3: The carrier shall be keyed “ON”, and the transmitter shall be operated at full radio frequency power output at the duty cycle, for which it is rated, for duration of at least 5 minutes. The radio frequency carrier frequency shall be monitored, and measurements shall be recorded.

Step 4: The test procedures outlined in Steps 2 and 3, shall be repeated after stabilizing the transmitter at the environmental temperatures specified, -30°C to +50°C in 10-degree increments.

The frequency stability was measured with variations in the power supply voltage from 85 to 115 percent of the nominal value. An AC Power Supply was used during measurement of frequency variation over input power to the AC power adapter. The frequency was measured and the variation in parts per million calculated. Data was taken per CFR47 Paragraphs 2.1055 and applicable paragraphs of part 15.225 and RSS-210.

13.110 – 14.010 MHz Transmitter Emissions Data

Table 9 Frequency Stability vs. Temperature Results

Frequency 13.559899 MHz	Frequency Stability Vs. Temperature Ambient Frequency (13.559899 MHz)								
	Temperature °C	-30	-20	-10	0	+10	+20	+30	+40
Change (Hz)	65	65	64	67	11	-8	65	65	66
%	0.000	0.000	0.000	0.000	0.000	0.000	0.000	0.000	0.000
Limit (%)	±0.01	±0.01	±0.01	±0.01	±0.01	±0.01	±0.01	±0.01	±0.01

Table 10 Frequency Stability vs. Input Power Supply Voltage Results

Channel Frequency 13.559905 MHz	Frequency Stability Vs. Voltage Variation 120.0Vac volts nominal; Results In Hz change		
	Voltage V _{dc}	102.0	120.0
Change (Hz)	0	0	0
%	0.000	0.000	0.000
Limit (%)	±0.01	±0.01	±0.01

The EUT demonstrated compliance with specifications of CFR47 Paragraph 2.1046(a) and applicable Parts of 15.225 and RSS-210. There are no deviations or exceptions to the specifications.

Annex

- Annex A Measurement Uncertainty Calculations
- Annex B Additional Test Equipment List
- Annex C Rogers Qualifications
- Annex D Rogers Labs Certificate of Accreditation

Annex A Measurement Uncertainty Calculations

The measurement uncertainty was calculated for all measurements listed in this test report according To CISPR 16-4. Result of measurement uncertainty calculations are recorded below. Component and process variability of production devices similar to those tested may result in additional deviations. The manufacturer has the sole responsibility of continued compliance.

Measurement	Expanded Measurement Uncertainty $U_{(lab)}$
3 Meter Horizontal 0.009-1000 MHz Measurements	4.16
3 Meter Vertical 0.009-1000 MHz Measurements	4.33
3 Meter Measurements 1-18 GHz	5.14
3 Meter Measurements 18-40 GHz	5.16
10 Meter Horizontal Measurements 0.009-1000 MHz	4.15
10 Meter Vertical Measurements 0.009-1000 MHz	4.32
AC Line Conducted	1.75
Antenna Port Conducted power	1.17
Frequency Stability	1.00E-11
Temperature	1.6°C
Humidity	3%

Annex B Additional Test Equipment List

List of Test Equipment	Calibration	Date (m/d/y)	Due
Antenna: Schwarzbeck Model: BBA 9106/VHBB 9124 (9124-627)		5/2/2018	5/2/2019
Antenna: Schwarzbeck Model: VULP 9118 A (VULP 9118 A-534)		5/2/2018	5/2/2019
Antenna: EMCO 6509		10/16/2018	10/16/2020
Antenna: EMCO 3143 (9607-1277) 20-1200 MHz		5/2/2018	5/2/2019
Antenna: EMCO Dipole Set 3121C		2/22/2019	2/22/2020
Antenna: C.D. B-101		2/22/2019	2/22/2020
Antenna: Solar 9229-1 & 9230-1		2/22/2019	2/22/2020
Cable: Belden 8268 (L3)		10/16/2018	10/16/2019
Cable: Time Microwave: 4M-750HF290-750		10/16/2018	10/16/2019
Frequency Counter: Leader LDC-825 (8060153)		5/2/2018	5/2/2019
Oscilloscope Scope: Tektronix 2230		2/22/2019	2/22/2020
Wattmeter: Bird 43 with Load Bird 8085		2/22/2019	2/22/2020
R.F. Generator: SMB100A6 s/n 100623		5/2/2018	5/2/2019
R.F. Generator: SBMBV100A s/n: 260771		5/2/2018	5/2/2019
R.F. Generators: HP 606A, HP 8614A, HP 8640B		2/22/2019	2/22/2020
R.F. Power Amp 65W Model: 470-A-1010		2/22/2019	2/22/2020
R.F. Power Amp 50W M185- 10-501		2/22/2019	2/22/2020
R.F. Power Amp A.R. Model: 10W 1010M7		2/22/2019	2/22/2020
R.F. Power Amp EIN Model: A301		2/22/2019	2/22/2020
LISN: Compliance Eng. Model 240/20		5/2/2018	5/2/2019
LISN: Fischer Custom Communications Model: FCC-LISN-50-16-2-08		5/2/2018	5/2/2019
Audio Oscillator: H.P. 201CD		2/22/2019	2/22/2020
ESD Test Set 2010i		2/22/2019	2/22/2020
Oscilloscope Scope: Tektronix MDO 4104		2/22/2019	2/22/2020
EMC Transient Generator HVT TR 3000		2/22/2019	2/22/2020
AC Power Source (Ametech, California Instruments)		2/22/2019	2/22/2020
Fast Transient Burst Generator Model: EFT/B-101		2/22/2019	2/22/2020
Field Intensity Meter: EFM-018		2/22/2019	2/22/2020
KEYTEK Ecat Surge Generator		2/22/2019	2/22/2020
ESD Simulator: MZ-15		2/22/2019	2/22/2020
Shielded Room not required			

Annex C Rogers Qualifications

Scot D. Rogers, Engineer

Rogers Labs, Inc.

Mr. Rogers has approximately 30 years' experience in the field of electronics. Work experience includes six years working in the automated controls industry and remaining years working with the design, development and testing of radio communications and electronic equipment.

Positions Held:

Systems Engineer: A/C Controls Mfg. Co., Inc. 6 Years

Electrical Engineer: Rogers Consulting Labs, Inc. 5 Years

Electrical Engineer: Rogers Labs, Inc. Current

Educational Background:

- 1) Bachelor of Science Degree in Electrical Engineering from Kansas State University
- 2) Bachelor of Science Degree in Business Administration Kansas State University
- 3) Several Specialized Training courses and seminars pertaining to Microprocessors and Software programming.

Annex D Laboratory Certificate of Accreditation

United States Department of Commerce
National Institute of Standards and Technology



Certificate of Accreditation to ISO/IEC 17025:2005

NVLAP LAB CODE: 200087-0

Rogers Labs, Inc.

Louisburg, KS

*is accredited by the National Voluntary Laboratory Accreditation Program for specific services,
listed on the Scope of Accreditation, for:*

Electromagnetic Compatibility & Telecommunications

*This laboratory is accredited in accordance with the recognized International Standard ISO/IEC 17025:2005.
This accreditation demonstrates technical competence for a defined scope and the operation of a laboratory quality
management system (refer to joint ISO-ILAC-IAF Communique dated January 2009).*

2018-02-21 through 2019-03-31

Effective Dates

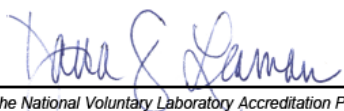

For the National Voluntary Laboratory Accreditation Program

Rogers Labs, Inc.
4405 West 259th Terrace
Louisburg, KS 66053
Phone/Fax: (913) 837-3214
Revision 1

Garmin International, Inc.
Model: A03559
Test: 190410
Test to: CFR47 (15.225), RSS-210
File: A03559 NFC TstRpt 190410

SN's: 3991277219, 3992239593
FCC ID: IPH-03559
IC: 1792A-03559
Date: May 24, 2019
Page 38 of 38