

Application For Grant of Certification

FOR

Model: A03521
2412-2462 MHz (DTS)
Broadband Digital Transmission System
FCC ID: IPH-03521
IC: 1792A-03521

FOR

Garmin International, Inc.

1200 East 151st Street
Olathe, KS 66062

FCC Designation: US5305
IC Test Site Registration: 3041A-1

Test Report Number: 181211

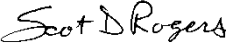
Authorized Signatory: 
Scot D. Rogers

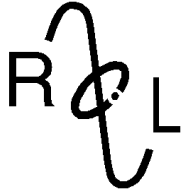

ROGERS LABS, INC.

4405 West 259th Terrace
Louisburg, KS 66053
Phone / Fax (913) 837-3214

Engineering Test Report For Grant of Certification Application

FOR
47 CFR, PART 15C - Intentional Radiators
47 CFR Paragraph 15.247 and
Industry Canada RSS-GEN and RSS-247
License Exempt Intentional Radiator

For
Garmin International, Inc.

1200 East 151st Street
Olathe, KS 66062

Digital Transmission System
Model: A03521

Frequency Range 2412-2462 MHz
FCC ID: IPH-03521
IC: 1792A-03521

Test Date: December 11, 2018

Certifying Engineer: *Scot D. Rogers*
Scot D. Rogers
Rogers Labs, Inc.
4405 West 259th Terrace
Louisburg, KS 66053
Telephone/Facsimile: (913) 837-3214

This report shall not be reproduced except in full, without the written approval of the laboratory.
This report must not be used by the client to claim product certification, approval, or
endorsement by NVLAP, NIST, or any agency of the Federal Government.

Rogers Labs, Inc.	Garmin International, Inc.	SN's: 3986187656, 3986187638
4405 W. 259th Terrace	Model: A03521	FCC ID: IPH-03521
Louisburg, KS 66053	Test #: 181211	IC: 1792A-03521
Phone/Fax: (913) 837-3214	Test to: CFR47 15C, RSS-Gen RSS-247	Date: January 18, 2019
Revision 1	File: A03521 DTS TstRpt 181211	Page 2 of 48

Table of Contents

TABLE OF CONTENTS.....	3
REVISIONS.....	5
FOREWORD.....	6
OPINION / INTERPRETATION OF RESULTS	6
EQUIPMENT TESTED.....	8
Equipment Function and Configuration.....	9
Equipment Configuration.....	10
APPLICATION FOR CERTIFICATION.....	11
APPLICABLE STANDARDS & TEST PROCEDURES.....	12
TESTING PROCEDURES	12
AC Line Conducted Emission Test Procedure	12
Radiated Emission Test Procedure.....	12
Antenna Port Conducted Emission Test Procedure.....	13
Diagram 1 Test arrangement for Conducted emissions	14
Diagram 2 Test arrangement for radiated emissions of tabletop equipment.....	15
Diagram 3 Test arrangement for radiated emissions tested on Open Area Test Site (OATS).....	16
Diagram 4 Test arrangement for Antenna Port Conducted emissions	17
TEST SITE LOCATIONS	17
LIST OF TEST EQUIPMENT	18
UNITS OF MEASUREMENTS	19
ENVIRONMENTAL CONDITIONS.....	19
STATEMENT OF MODIFICATIONS AND DEVIATIONS	19
INTENTIONAL RADIATORS.....	19

Antenna Requirements19

Restricted Bands of Operation.....20

Table 1 Harmonic Radiated Emissions in Restricted Bands Data (802.11b, Worst-case).....20

Table 2 Harmonic Radiated Emissions in Restricted Bands Data (802.11g, Worst-case).....21

Table 3 Harmonic Radiated Emissions in Restricted Bands Data (802.11n, Worst-case).....22

Summary of Results for Radiated Emissions in Restricted Bands22

AC Line Conducted EMI Procedure23

Figure 1 AC Line Conducted emissions of EUT line 1 (#2, EUT – Computer).....24

Figure 2 AC Line Conducted emissions of EUT line 2 (#2, EUT – Computer).....24

Figure 3 AC Line Conducted emissions of EUT line 1 (#3, EUT – 362-00096-00)25

Figure 4 AC Line Conducted emissions of EUT line 2 (#3, EUT – 362-00096-00)25

Table 4 AC Line Conducted Emissions Data L1 (#2, EUT – Computer).....26

Table 5 AC Line Conducted Emissions Data L2 (#2, EUT – Computer).....26

Table 6 AC Line Conducted Emissions Data L1 (#3, EUT – 362-00091-00)27

Table 7 AC Line Conducted Emissions Data L2 (#3, – 362-00091-00).....27

Summary of Results for AC Line Conducted Emissions27

General Radiated Emissions Procedure.....28

Table 8 General Radiated Emissions Data29

Summary of Results for General Radiated Emissions29

Operation in the Band 2400 – 2483.5 MHz30

Figure 5 Plot of Transmitter Emissions in Operational Frequency (802.11 b-Mode)31

Figure 6 Plot of Transmitter Emissions in Operational Frequency (802.11 g-Mode)31

Figure 7 Plot of Transmitter Emissions in Operational Frequency (802.11 n-Mode)32

Figure 8 Plot of Lower Band Edge (802.11 b-mode)32

Figure 9 Plot of Lower Band Edge (802.11 g-mode)33

Figure 10 Plot of Lower Band Edge (802.11 n-mode)33

Figure 11 Plot of Upper Band Edge (802.11 b-mode).....34

Figure 12 Plot of Upper Band Edge (802.11 g-mode).....34

Figure 13 Plot of Upper Band Edge (802.11 n-mode).....35

Figure 14 Plot of Transmitter 6-dB Occupied Bandwidth (802.11 b-mode).....35

Figure 15 Plot of Transmitter 99% Occupied Bandwidth (802.11 b-mode).....36

Figure 16 Plot of Transmitter 6-dB Occupied Bandwidth (802.11 g-mode)36

Figure 17 Plot of Transmitter 99% Occupied Bandwidth (802.11 g-mode).....37

Figure 18 Plot of Transmitter 6-dB Occupied Bandwidth (802.11 n-mode)37

Figure 19 Plot of Transmitter 99% Occupied Bandwidth (802.11 n-mode).....38

Figure 20 Plot of Transmitter Power Spectral Density (802.11 b-mode)38

Figure 21 Plot of Transmitter Power Spectral Density (802.11 g-mode)39

Figure 22 Plot of Transmitter Power Spectral Density (802.11 n-mode)39

Transmitter Emissions Data.....40

Table 9 Transmitter Radiated Emission Worst-case Data 802.11b40

Table 10 Transmitter Radiated Emission Worst-case Data 802.11g41

Table 11 Transmitter Radiated Emission Worst-case Data 802.11n42

Table 12 Transmitter Antenna Port Data.....43

Summary of Results for Transmitter Radiated Emissions of Intentional Radiator43

ANNEX..... 44

Annex A Measurement Uncertainty Calculations.....45

Annex B Additional Test Equipment List46

Annex C Rogers Qualifications47

Annex D Laboratory Certificate of Accreditation.....48

Revisions

Revision 1 Issued January 18, 2019

Foreword

The following information is submitted for consideration in obtaining Grant of Certification for License Exempt Digital Transmission System Intentional Radiator operating under Code of Federal Regulations Title 47 (47 CFR) Paragraph 15.247 and Industry Canada RSS-GEN, Issue 5 and RSS-247 Issue 2, operation in the 2400 – 2483.5 MHz band.

Name of Applicant: Garmin International, Inc.
1200 East 151st Street
Olathe, KS 66062

M/N: A03521

FCC ID: IPH-03521 Industry Canada ID: 1792A-03521

Frequency Range: 2412-2462 MHz

Mode	Peak Power (Watts)	Average power (Watts)	99% OBW (kHz)
802.11b	0.128	0.076	14,460.0
802.11g	0.200	0.054	16,634.6
802.11n	0.204	0.054	17,788.5

Opinion / Interpretation of Results

Tests Performed	Margin (dB)	Results
Emissions 15.205, RSS-GEN	-15.4	Complies
Emissions as per 47 CFR paragraphs 2 and 15.207	-10.5	Complies
Emissions as per 47 CFR paragraphs 2 and 15.209	-17.6	Complies
Harmonic Emissions per 47 CFR 15.247		Complies
Power Spectral Density per 47 CFR 15.247		Complies

Tests performed include

47CFR

15.247 (a) (2) Systems using digital modulation techniques may operate in the 902-928 MHz, 2400-2483.5 MHz, and 5725-5850 MHz bands. The minimum 6 dB bandwidth shall be at least 500 kHz.

(b) The maximum peak conducted output power of the intentional radiator shall not exceed the following:

(3) For systems using digital modulation in the 902-928 MHz, 2400-2483.5 MHz, and 5725-5850 MHz bands: 1 Watt. As an alternative to a peak power measurement, compliance with the

Rogers Labs, Inc.
4405 W. 259th Terrace
Louisburg, KS 66053
Phone/Fax: (913) 837-3214
Revision 1

Garmin International, Inc.
Model: A03521
Test #: 181211
Test to: CFR47 15C, RSS-Gen RSS-247
File: A03521 DTS TstRpt 181211

SN's: 3986187656, 3986187638
FCC ID: IPH-03521
IC: 1792A-03521
Date: January 18, 2019
Page 6 of 48

one-Watt limit can be based on a measurement of the maximum conducted output power. Maximum Conducted Output Power is defined as the total transmit power delivered to all antennas and antenna elements averaged across all symbols in the signaling alphabet when the transmitter is operating at its maximum power control level. Power must be summed across all antennas and antenna elements. The average must not include any time intervals during which the transmitter is off or is transmitting at a reduced power level. If multiple modes of operation are possible (e.g., alternative modulation methods), the *maximum conducted output power* is the highest total transmit power occurring in any mode.

(d) In any 100 kHz bandwidth outside the frequency band in which the spread spectrum or digitally modulated intentional radiator is operating, the radio frequency power that is produced by the intentional radiator shall be at least 20 dB below that in the 100 kHz bandwidth within the band that contains the highest level of the desired power, based on either an RF conducted or a radiated measurement, provided the transmitter demonstrates compliance with the peak conducted power limits. If the transmitter complies with the conducted power limits based on the use of RMS averaging over a time interval, as permitted under paragraph (b)(3) of this section, the attenuation required under this paragraph shall be 30 dB instead of 20 dB. Attenuation below the general limits specified in §15.209(a) is not required. In addition, radiated emissions which fall in the restricted bands, as defined in §15.205(a), must also comply with the radiated emission limits specified in §15.209(a) (see §15.205(c)).

(e) For digitally modulated systems, the power spectral density conducted from the intentional radiator to the antenna shall not be greater than 8 dBm in any 3 kHz band during any time interval of continuous transmission. This power spectral density shall be determined in accordance with the provisions of paragraph (b) of this section. The same method of determining the conducted output power shall be used to determine the power spectral density.

RSS-247 Issue 2

5.2 Digital transmission systems

DTSs include systems that employ digital modulation techniques resulting in spectral characteristics similar to direct sequence systems. The following applies to the bands 902-928 MHz and 2400-2483.5 MHz

a) The minimum 6 dB bandwidth shall be 500 kHz.

b) The transmitter power spectral density conducted from the transmitter to the antenna shall not be greater than 8 dBm in any 3 kHz band during any time interval of continuous transmission. This power spectral density shall be determined in accordance with the provisions of section 5.4(d), (i.e. the power spectral density shall be determined using the same method as is used to determine the conducted output power).

5.4 Transmitter output power and equivalent isotropically radiated power (e.i.r.p.) requirements

d) For DTSs employing digital modulation techniques operating in the bands 902-928 MHz and 2400-2483.5 MHz, the maximum peak conducted output power shall not exceed 1W. The e.i.r.p. shall not exceed 4 W, except as provided in section 5.4(e).

5.5 Unwanted emissions

In any 100 kHz bandwidth outside the frequency band in which the spread spectrum or digitally modulated device is operating, the RF power that is produced shall be at least 20 dB below that in the 100 kHz bandwidth within the band that contains the highest level of the desired power, based on either an RF conducted or a radiated measurement, provided that the transmitter demonstrates compliance with the peak conducted power limits. If the transmitter complies with

the conducted power limits based on the use of root-mean-square averaging over a time interval, as permitted under section 5.4(d), the attenuation required shall be 30 dB instead of 20 dB. Attenuation below the general field strength limits specified in RSS-Gen is not required.

Equipment Tested

<u>Equipment</u>	<u>Model / PN</u>	<u>Serial Number</u>
EUT	A03521	3986187656
EUT#2	A03521	3986187638
USB Cable	320-01048-10	N/A
AC Adapter	362-00091-00	N/A
Laptop Computer	Latitude E6320	FCN03Q1
USB Printer	Dell 0N5819	5D1SL61

Software Versions 0.70 with ANT/BLE/BT ver 3.20

Test results in this report relate only to the items tested

Equipment Function and Configuration

The EUT is a body worn portable digital device. The device incorporates sensors to log movement and other functions and includes transmitter functions for communication with compatible equipment. The design provides a single unique connection point for use with the USB interface cradle and offers no other interface options as presented below in the configuration diagrams. The transmitters provide operation capability as Near Field Communications (NFC) and across the 2402-2480 MHz frequency band. The design provides wireless communications with compatible NFC, ANT, Bluetooth® (BT), and 802.11b/g/n (Wi-Fi) equipment. The product operates from internal rechargeable battery only and requires battery recharge through the provided USB interface cradle and compatible USB power source. The design utilizes internal fixed antenna systems and offers no provision for antenna replacement or modification. Two samples were provided for testing, one representative of production design, and the other modified for testing purposes replacing the integral 2.4 GHz antenna with RF connection port. The test samples were provided with test software (version 0.70 with ANT/BLE/BT ver 3.20) enabling testing personnel the ability to enable transmitter functions on defined modulations and channels. The antenna modification offered testing facility the ability to connect test equipment to the temporary antenna port for antenna port conducted emission testing. The EUT was arranged as described by the manufacturer emulating typical user configurations for testing purposes. For testing purposes, the EUT received powered from freshly charged internal battery and/or AC powered and configured to operate in available modes. As requested by the manufacturer and required by regulations, the equipment was tested for compliance using the available configurations with the worst-case data presented. The test software enabled extremely high duty cycles for testing purposes. The production product will not operate at these high of duty cycles as battery life is depleted. This report documents the performed testing and results for applicable configurations and product modes of operation. Test results in this report relate only to the products described in this report.

Equipment Configuration

- 1) Unit operating off internal battery



- 2) Unit connected to Computer USB port through cable assembly (GPN: 320-01048-10)



- 3) Unit connected to (and powered by) AC adapter through USB cable (GPN: 320-01048-10)



Application for Certification

- (1) Manufacturer: Garmin International, Inc.
1200 East 151st Street
Olathe, KS 66062
- (2) Identification: M/N: A03521
FCC ID: IPH-03521 IC: 1792A-03521
- (3) Instruction Book:
Refer to Exhibit for Instruction Manual.
- (4) Description of Circuit Functions:
Refer to Exhibit of Operational Description.
- (5) Block Diagram with Frequencies:
Refer to Exhibit of Operational Description.
- (6) Report of Measurements:
Report of measurements follows in this Report.
- (7) Photographs: Construction, Component Placement, etc.:
Refer to Exhibit for photographs of equipment.
- (8) List of Peripheral Equipment Necessary for operation. The equipment operates from direct current power provided from internal rechargeable battery. The design provides interface options with USB cradle and compliant equipment as presented in this filing. The EUT offers no other connection ports than those presented in this filing.
- (10) Not Applicable. The unit is not a scanning receiver.
- (11) Not Applicable. The EUT does not operate in the 59 – 64 GHz frequency band.
- (12) The equipment is not software defined and this section is not applicable.
- (13) Applications for certification of U-NII devices in the 5.15-5.35 GHz and the 5.47-5.85 GHz bands must include a high-level operational description of the security procedures that control the radio frequency operating parameters and ensure that unauthorized modifications cannot be made. This requirement is not applicable to his DTS device.
- (14) Contain at least one drawing or photograph showing the test set-up for each of the required types of tests applicable to the device for which certification is requested. These drawings or photographs must show enough detail to confirm other information contained in the test report. Any photographs used must be focused originals without glare or dark spots and must clearly show the test configuration used. This information is provided in this report and Test Setup Exhibits provided with the application filing.

Applicable Standards & Test Procedures

The following information is submitted in accordance with the eCFR Federal Communications Code of Federal Regulations, dated December 11, 2018, Part 2, Subpart J, Paragraphs 2.907, 2.911, 2.913, 2.925, 2.926, 2.1031 through 2.1057, and applicable parts of paragraph 15, Part 15C Paragraph 15.247, and Industry Canada RSS-GEN Issue 5, and RSS-247 Issue 2. Test procedures used are the established Methods of Measurement of Radio-Noise Emissions as described in ANSI C63.10-2013. This report documents compliance for the EUT operations as Digital Transmission Systems operation as 802.11b/g/n (Wi-Fi).

Testing Procedures

AC Line Conducted Emission Test Procedure

Testing for the AC line-conducted emissions was performed as defined in ANSI C63.10-2013. The test setup, including the EUT, was arranged in the test configurations as presented during testing. The test configuration was placed on a 1 x 1.5-meter bench, 0.8 meters high located in a screen room. The power lines of the system were isolated from the power source using a standard LISN with a 50- μ Hy choke. EMI was coupled to the spectrum analyzer through a 0.1 μ F capacitor internal to the LISN. The LISN was positioned on the floor beneath the wooden bench supporting the EUT. The power lines and cables were draped over the back edge of the table. Refer to diagram one showing typical test arrangement and photographs in exhibits for EUT placement used during testing.

Radiated Emission Test Procedure

Radiated emissions testing was performed as required in 47 CFR 15, KDB 558074 D01, v5, RSS-247 and specified in ANSI C63.10-2013. The EUT was placed on a rotating 0.9 x 1.2-meter platform, elevated as required above the ground plane at a distance of 3 meters from the FSM antenna. EMI energy was maximized by equipment placement permitting orientation in three orthogonal axes, raising and lowering the FSM antenna, changing the antenna polarization, and by rotating the turntable. Each emission was maximized before data was taken using a spectrum analyzer. The frequency spectrum from 9 kHz to 25,000 MHz was searched for during preliminary investigation. Refer to diagrams two and three showing typical test arrangement and photographs in the test setup exhibits for specific EUT placement during testing.

Antenna Port Conducted Emission Test Procedure

The EUT was assembled as required for operation placed on a benchtop. This configuration provided the ability to connect test equipment to the provided test antenna port. Antenna Port conducted emissions testing was performed presented in the regulations and specified in ANSI C63.10-2013. Testing was completed on a laboratory bench in a shielded room. The active antenna port of the device was connected to appropriate attenuation and the spectrum analyzer. Refer to diagram four showing typical test arrangement and photographs in the test setup exhibits for specific EUT placement during testing.

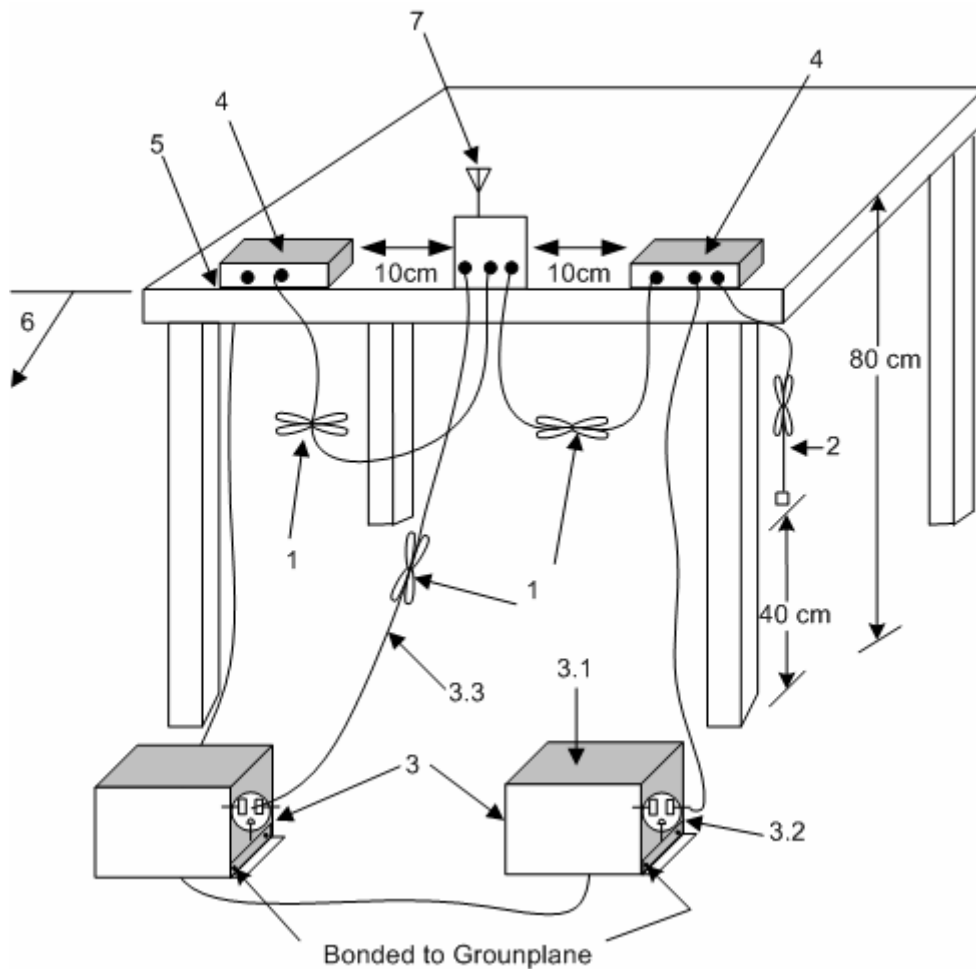

1. Interconnecting cables that hang closer than 40 cm to the ground plane shall be folded back and forth in the center forming a bundle 30 cm to 40 cm long see (see 6.2.3.1).
2. I/O cables that are not connected to an accessory shall be bundled in the center. The end of the cable may be terminated, if required, using the correct terminating impedance. The overall length shall not exceed 1 m (see 6.2.2).
3. EUT connected to one LISN. Unused LISN measuring port connectors shall be terminated in 50 Ω loads. LISN can be placed on top of, or immediately beneath, reference ground plane (see 6.2.2 and 6.2.3).
 - 3.1 All other equipment powered from additional LISN(s).
 - 3.2 Multiple-outlet strip can be used for multiple power cords of non-EUT equipment.
 - 3.3 LISN at least 80 cm from nearest part of EUT chassis.
4. Non-EUT components of EUT system being tested.
5. Rear of EUT, including peripherals, shall all be aligned and flush with rear of tabletop (see 6.2.3.1).
6. Edge of tabletop shall be 40 cm removed from a vertical conducting plane that is bonded to the ground plane (see 6.2.2 for options).
7. Antenna may be integral or detachable. If detachable, the antenna shall be attached for this test.

Diagram 1 Test arrangement for Conducted emissions

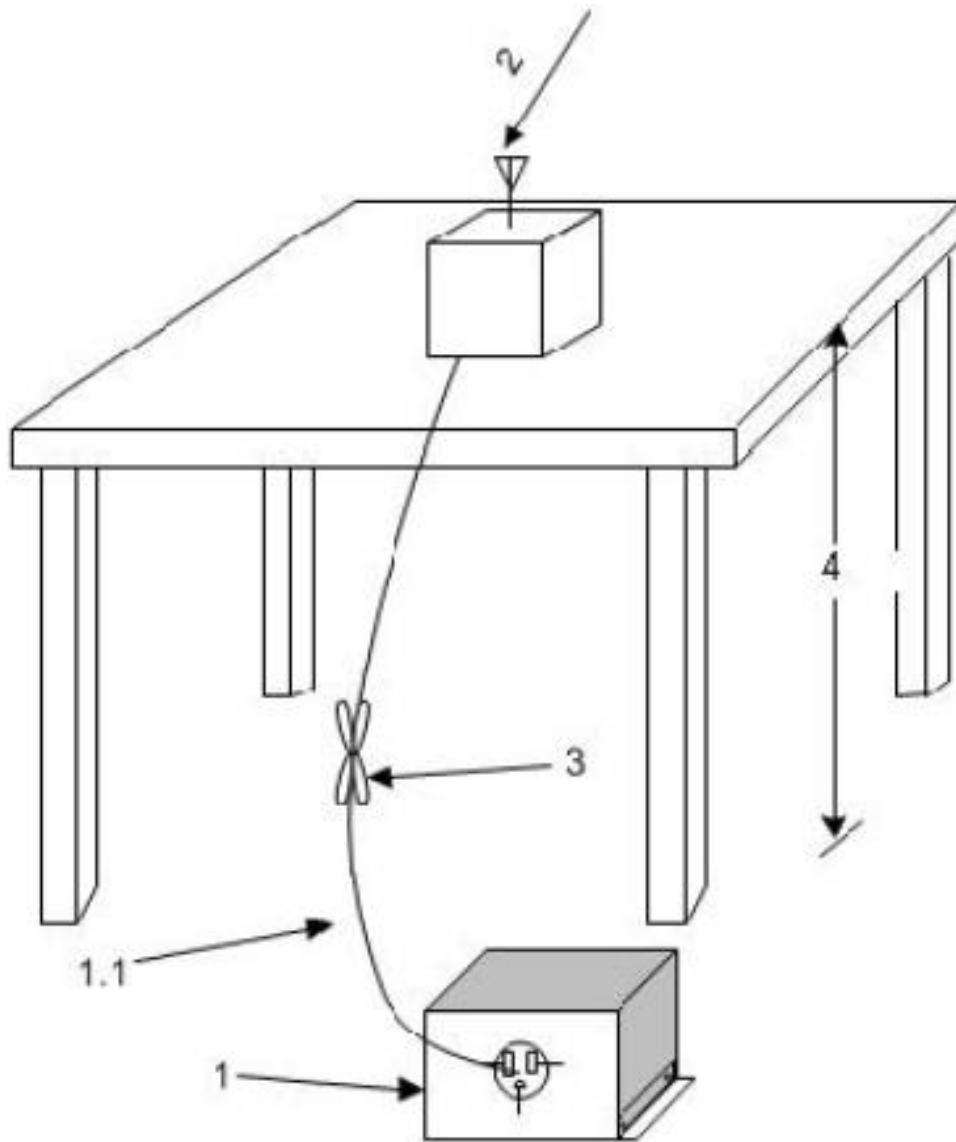

1—A LISN is optional for radiated measurements between 30 MHz and 1000 MHz but not allowed for measurements below 30 MHz and above 1000 MHz (see 6.3.1). If used, then connect EUT to one LISN. Unused LISN measuring port connectors shall be terminated in 50 Ω loads. The LISN may be placed on top of, or immediately beneath, the reference ground plane (see 6.2.2 and 6.2.3.2).

1.1—LISN spaced at least 80 cm from the nearest part of the EUT chassis.

2—Antenna can be integral or detachable, depending on the EUT (see 6.3.1).

3—Interconnecting cables that hang closer than 40 cm to the ground plane shall be folded back and forth in the center forming a bundle 30 cm to 40 cm long (see 6.3.1).

4—For emission measurements at or below 1 GHz, the table height shall be 80 cm. For emission measurements above 1 GHz, the table height shall be 1.5 m for measurements, except as otherwise specified (see 6.3.1 and 6.6.3.1).

Diagram 2 Test arrangement for radiated emissions of tabletop equipment

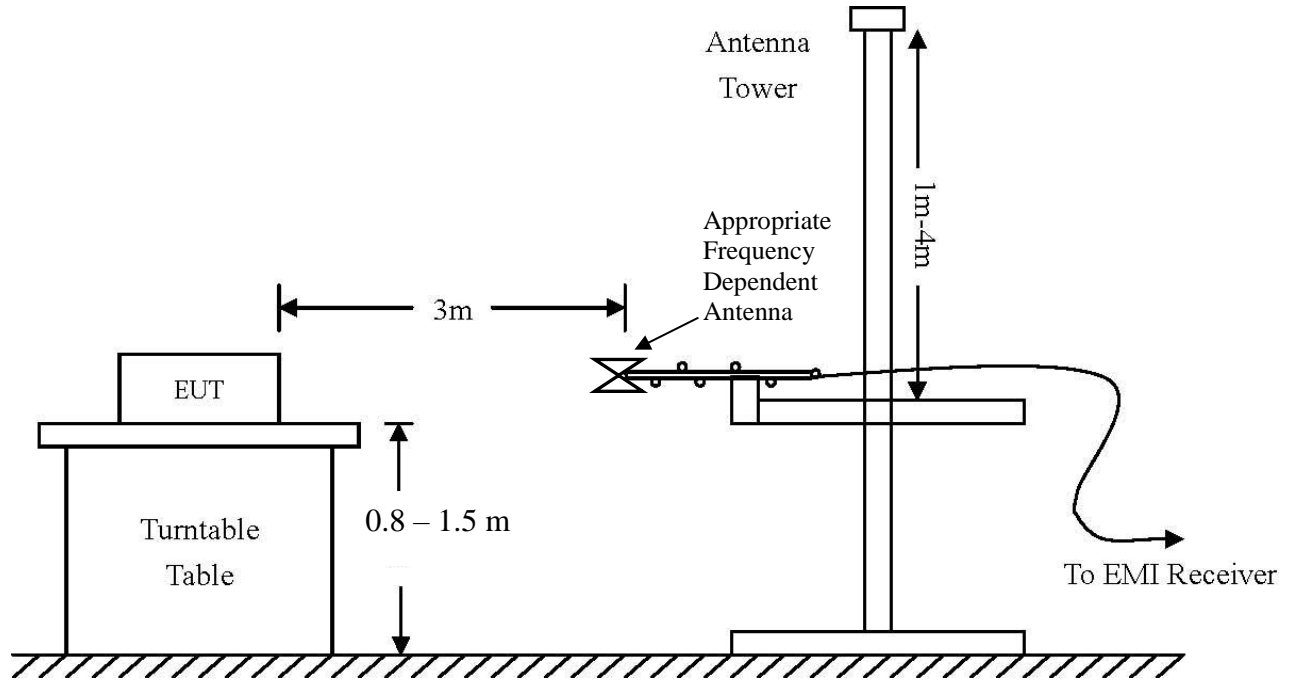

AC Line Conducted Emissions (0.150 -30 MHz)		
RBW	AVG. BW	Detector Function
9 kHz	30 kHz	Peak / Quasi Peak
Emissions (30-1000 MHz)		
RBW	AVG. BW	Detector Function
120 kHz	300 kHz	Peak / Quasi Peak
Emissions (Above 1000 MHz)		
RBW	Video BW	Detector Function
100 kHz	100 kHz	Peak
1 MHz	1 MHz	Peak / Average

Diagram 3 Test arrangement for radiated emissions tested on Open Area Test Site (OATS)

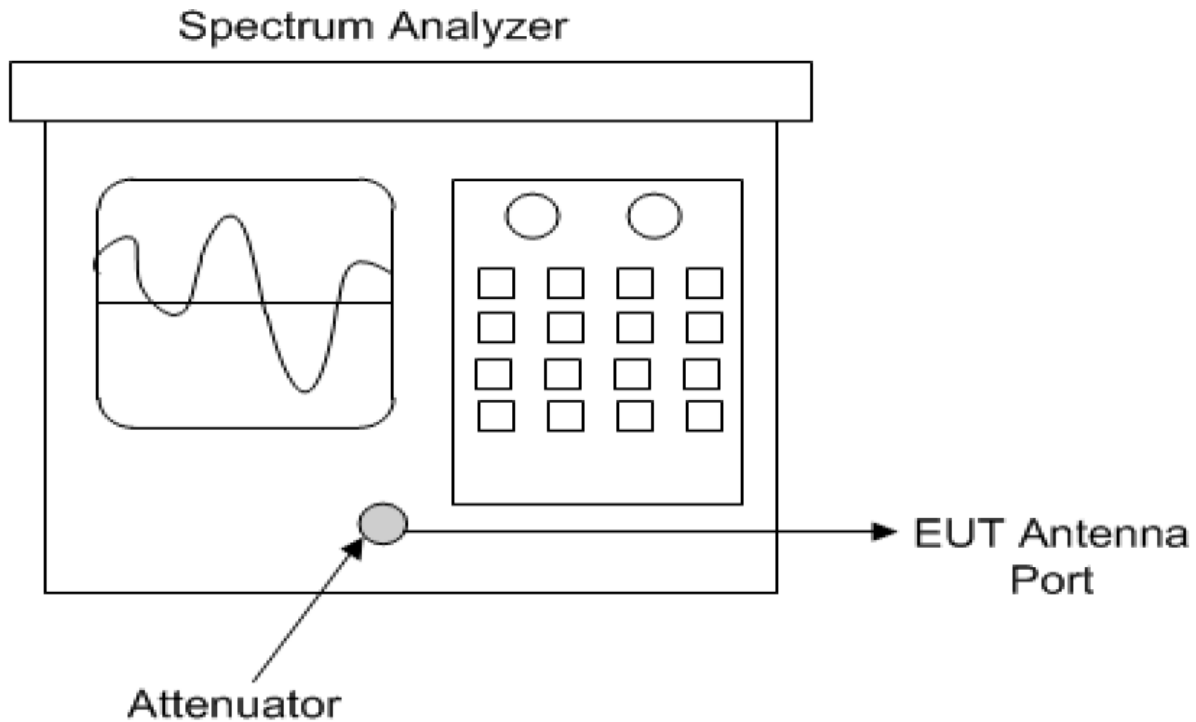

Diagram 4 Test arrangement for Antenna Port Conducted emissions

Test Site Locations

Conducted EMI	AC line conducted emissions testing performed in a shielded screen room located at Rogers Labs, Inc., 4405 West 259 th Terrace, Louisburg, KS
Radiated EMI	The radiated emissions tests were performed at the 3 meters, Open Area Test Site (OATS) located at Rogers Labs, Inc., 4405 West 259 th Terrace, Louisburg, KS
Registered Site #	FCC Site: US5305 and Industry Canada Registration: 3041A-1
NVLAP Accreditation	Lab code 200087-0

List of Test Equipment

<u>Equipment</u>	<u>Manufacturer</u>	<u>Model (SN)</u>	<u>Band</u>	<u>Cal Date(m/d/y)</u>	<u>Due</u>
<input checked="" type="checkbox"/> LISN	FCC	FCC-LISN-50-25-10(1PA) (160611)	.15-30MHz	5/2/2018	5/2/2019
<input checked="" type="checkbox"/> LISN	Compliance Design	FCC-LISN-2.Mod.cd,(126)	.15-30MHz	10/16/2018	10/16/2019
<input checked="" type="checkbox"/> Cable	Huber & Suhner Inc.	Sucoflex102ea(L10M)(303073)	9kHz-40 GHz	10/16/2018	10/16/2019
<input checked="" type="checkbox"/> Cable	Huber & Suhner Inc.	Sucoflex102ea(1.5M)(303069)	9kHz-40 GHz	10/16/2018	10/16/2019
<input checked="" type="checkbox"/> Cable	Huber & Suhner Inc.	Sucoflex102ea(1.5M)(303071)	9kHz-40 GHz	10/16/2018	10/16/2019
<input checked="" type="checkbox"/> Cable	Belden	RG-58 (L1-CAT3-11509)	9kHz-30 MHz	10/16/2018	10/16/2019
<input checked="" type="checkbox"/> Cable	Belden	RG-58 (L2-CAT3-11509)	9kHz-30 MHz	10/16/2018	10/16/2019
<input type="checkbox"/> Antenna	ARA	BCD-235-B (169)	20-350MHz	10/16/2018	10/16/2019
<input type="checkbox"/> Antenna	EMCO	3147 (40582)	200-1000MHz	10/16/2018	10/16/2019
<input checked="" type="checkbox"/> Antenna	ETS-Lindgren	3117 (200389)	1-18 GHz	5/2/2018	5/2/2020
<input type="checkbox"/> Antenna	Com Power	AH-118 (10110)	1-18 GHz	10/16/2018	10/24/2019
<input checked="" type="checkbox"/> Antenna	Com Power	AH-840 (101046)	18-40 GHz	5/15/2017	5/15/2019
<input checked="" type="checkbox"/> Antenna	Com Power	AL-130 (121055)	.001-30 MHz	10/16/2018	10/16/2019
<input checked="" type="checkbox"/> Antenna	Sunol	JB-6 (A100709)	30-1000 MHz	10/16/2018	10/16/2019
<input checked="" type="checkbox"/> Analyzer	Rohde & Schwarz	ESU40 (100108)	20Hz-40GHz	5/2/2018	5/2/2019
<input checked="" type="checkbox"/> Analyzer	Rohde & Schwarz	ESW44 (101534)	20Hz-44GHz	12/22/2017	12/22/2018
<input type="checkbox"/> Analyzer	Rohde & Schwarz	FS-Z60, 90, 140, and 220	40GHz-220GHz	12/22/2017	12/22/2019
<input checked="" type="checkbox"/> Amplifier	Com-Power	PA-010 (171003)	100Hz-30MHz	10/16/2018	10/16/2019
<input checked="" type="checkbox"/> Amplifier	Com-Power	CPPA-102 (01254)	1-1000 MHz	10/16/2018	10/16/2019
<input checked="" type="checkbox"/> Amplifier	Com-Power	PAM-118A (551014)	0.5-18 GHz	10/16/2018	10/16/2019
<input checked="" type="checkbox"/> Amplifier	Com-Power	PAM-840A (461328)	18-40 GHz	10/16/2018	10/16/2019
<input checked="" type="checkbox"/> Power Meter	Agilent	N1911A with N1921A	0.05-40 GHz	5/2/2018	5/2/2019
<input type="checkbox"/> Generator	Rohde & Schwarz	SMB100A6 (100150)	20Hz-6 GHz	5/2/2018	5/2/2019
<input type="checkbox"/> Generator	Rohde & Schwarz	SMBV100A6 (260771)	20Hz-6 GHz	5/2/2018	5/2/2019
<input type="checkbox"/> RF Filter	Micro-Tronics	BRC50722 (009).9G notch	30-1800 MHz	5/2/2018	5/2/2019
<input type="checkbox"/> RF Filter	Micro-Tronics	HPM50114 (017)1.5G HPF	30-18000 MHz	5/2/2018	5/2/2019
<input type="checkbox"/> RF Filter	Micro-Tronics	HPM50117 (063) 3G HPF	30-18000 MHz	5/2/2018	5/2/2019
<input type="checkbox"/> RF Filter	Micro-Tronics	HPM50105 (059) 6G HPF	30-18000 MHz	5/2/2018	5/2/2019
<input type="checkbox"/> RF Filter	Micro-Tronics	BRM50702 (172) 2G notch	30-1800 MHz	5/2/2018	5/2/2019
<input type="checkbox"/> RF Filter	Micro-Tronics	BRC50703 (G102) 5G notch	30-1800 MHz	5/2/2018	5/2/2019
<input type="checkbox"/> RF Filter	Micro-Tronics	BRC50705 (024) 5G notch	30-1800 MHz	5/2/2018	5/2/2019
<input type="checkbox"/> Attenuator	Fairview	SA6NFN100W-14 (1625)	30-1800 MHz	5/2/2018	5/2/2019
<input type="checkbox"/> Attenuator	Mini-Circuits	VAT-3W2+ (1735)	30-6000 MHz	5/2/2018	5/2/2019
<input type="checkbox"/> Attenuator	Mini-Circuits	VAT-3W2+ (1436)	30-6000 MHz	5/2/2018	5/2/2019
<input type="checkbox"/> Attenuator	Mini-Circuits	VAT-3W2+ (14362)	30-6000 MHz	5/2/2018	5/2/2019
<input type="checkbox"/> Attenuator	Mini-Circuits	VAT-3W2+ (1445)	30-6000 MHz	5/2/2018	5/2/2019
<input type="checkbox"/> Attenuator	Mini-Circuits	VAT-3W2+ (14452)	30-6000 MHz	5/2/2018	5/2/2019
<input type="checkbox"/> Attenuator	Mini-Circuits	VAT-6W2+ (1438)	30-6000 MHz	5/2/2018	5/2/2019
<input type="checkbox"/> Attenuator	Mini-Circuits	VAT-6W2+ (1736)	30-6000 MHz	5/2/2018	5/2/2019
<input type="checkbox"/> Attenuator	JFW Industries	50FH-010-10 (1)	30-18000 MHz	5/2/2018	5/2/2019
<input checked="" type="checkbox"/> Weather station	Davis	6312 (A81120N075)		10/26/2018	10/26/2019

Rogers Labs, Inc.
4405 W. 259th Terrace
Louisburg, KS 66053
Phone/Fax: (913) 837-3214
Revision 1

Garmin International, Inc.
Model: A03521
Test #: 181211
Test to: CFR47 15C, RSS-Gen RSS-247
File: A03521 DTS TstRpt 181211

SN's: 3986187656, 3986187638
FCC ID: IPH-03521
IC: 1792A-03521
Date: January 18, 2019
Page 18 of 48

Units of Measurements

Conducted EMI Data is in dB μ V; dB referenced to one microvolt

Radiated EMI Data is in dB μ V/m; dB/m referenced to one microvolt per meter

Sample Calculation:

RFS = Radiated Field Strength, FSM = Field Strength Measured

A.F. = Receive antenna factor, Gain = amplification gains and/or cable losses

$RFS (dB\mu V/m @ 3m) = FSM (dB\mu V) + A.F. (dB) - Gain (dB)$

Environmental Conditions

Ambient Temperature 19.6° C

Relative Humidity 41%

Atmospheric Pressure 1025.5 mb

Statement of Modifications and Deviations

No modifications to the EUT were required for the unit to demonstrate compliance with the 47 CFR Part 15C, RSS-Gen, and RSS-247 emission requirements. There were no deviations to the specifications.

Intentional Radiators

The following information is submitted in support demonstration of compliance with the requirements of 47 CFR, Subpart C, paragraph 15.247 and Industry Canada RSS-247 and RSS-Gen the following information is submitted.

Antenna Requirements

The EUT incorporates integral antenna system and offers no provision for connection to alternate antenna system. The antenna connection point complies with the unique antenna connection requirements. There are no deviations or exceptions to the specification.

Rogers Labs, Inc.
4405 W. 259th Terrace
Louisburg, KS 66053
Phone/Fax: (913) 837-3214
Revision 1

Garmin International, Inc.
Model: A03521
Test #: 181211
Test to: CFR47 15C, RSS-Gen RSS-247
File: A03521 DTS TstRpt 181211

SN's: 3986187656, 3986187638
FCC ID: IPH-03521
IC: 1792A-03521
Date: January 18, 2019
Page 19 of 48

Restricted Bands of Operation

Spurious emissions falling in the restricted frequency bands of operation were measured at the OATS. The EUT utilizes frequency, determining circuitry, which generates harmonics falling in the restricted bands. Emissions were investigated at the OATS, using appropriate antennas or pyramidal horns, amplification stages, and a spectrum analyzer. Peak and average amplitudes of frequencies above 1000 MHz were compared to the required limits with worst-case data presented below. Test procedures of ANSI C63.10-2013 were used during testing. No other significant emission was observed which fell into the restricted bands of operation. Computed emission values consider the received radiated field strength, receive antenna correction factor, amplifier gain stage, and test system cable losses.

Table 1 Harmonic Radiated Emissions in Restricted Bands Data (802.11b, Worst-case)

Frequency in MHz	Horizontal Peak (dB μ V/m)	Horizontal Quasi-Peak (dB μ V/m)	Horizontal Average (dB μ V/m)	Vertical Peak (dB μ V/m)	Vertical Quasi-Peak (dB μ V/m)	Vertical Average (dB μ V/m)	Limit @ 3m (dB μ V/m)
2390.0	45.4	N/A	33.5	47.5	N/A	33.4	54.0
2483.5	49.5	N/A	31.5	48.4	N/A	31.3	54.0
4824.0	46.4	N/A	34.8	45.3	N/A	32.6	54.0
4874.0	46.5	N/A	34.1	44.9	N/A	32.3	54.0
4924.0	48.4	N/A	38.7	46.1	N/A	33.4	54.0
7236.0	47.5	N/A	34.7	47.8	N/A	34.7	54.0
7311.0	47.2	N/A	34.1	47.3	N/A	34.1	54.0
7386.0	47.2	N/A	34.6	47.0	N/A	34.4	54.0
12060.0	50.4	N/A	37.9	51.6	N/A	37.9	54.0
12185.0	51.5	N/A	37.7	50.6	N/A	37.7	54.0
12310.0	49.7	N/A	37.0	50.5	N/A	37.1	54.0

Other emissions present had amplitudes at least 20 dB below the limit. Peak and Quasi-Peak amplitude emissions are recorded for frequency below 1000 MHz. Peak and Average amplitude emissions are recorded for frequency range above 1000 MHz.

Table 2 Harmonic Radiated Emissions in Restricted Bands Data (802.11g, Worst-case)

Frequency in MHz	Horizontal Peak (dBµV/m)	Horizontal Quasi-Peak (dBµV/m)	Horizontal Average (dBµV/m)	Vertical Peak (dBµV/m)	Vertical Quasi-Peak (dBµV/m)	Vertical Average (dBµV/m)	Limit @ 3m (dBµV/m)
2390.0	68.2	N/A	46.7	68.2	N/A	46.7	54.0
2483.5	66.3	N/A	44.5	65.1	N/A	43.6	54.0
4824.0	45.2	N/A	32.1	45.3	N/A	32.4	54.0
4874.0	45.8	N/A	32.7	45.9	N/A	32.6	54.0
4924.0	46.5	N/A	33.4	45.9	N/A	33.0	54.0
7236.0	47.7	N/A	34.6	47.9	N/A	34.7	54.0
7311.0	46.8	N/A	34.1	47.5	N/A	34.1	54.0
7386.0	47.4	N/A	34.4	47.4	N/A	34.4	54.0
12060.0	50.5	N/A	38.0	50.6	N/A	38.0	54.0
12185.0	50.5	N/A	37.7	50.7	N/A	37.7	54.0
12310.0	50.4	N/A	36.9	50.4	N/A	37.2	54.0

Other emissions present had amplitudes at least 20 dB below the limit. Peak and Quasi-Peak amplitude emissions are recorded for frequency below 1000 MHz. Peak and Average amplitude emissions are recorded for frequency range above 1000 MHz.

Table 3 Harmonic Radiated Emissions in Restricted Bands Data (802.11n, Worst-case)

Frequency in MHz	Horizontal Peak (dBµV/m)	Horizontal Quasi-Peak (dBµV/m)	Horizontal Average (dBµV/m)	Vertical Peak (dBµV/m)	Vertical Quasi-Peak (dBµV/m)	Vertical Average (dBµV/m)	Limit @ 3m (dBµV/m)
2390.0	69.7	N/A	48.6	68.3	N/A	47.9	54.0
2483.5	67.2	N/A	47.3	64.9	N/A	45.2	54.0
4824.0	45.0	N/A	32.4	45.6	N/A	32.5	54.0
4874.0	45.1	N/A	32.6	45.6	N/A	32.8	54.0
4924.0	46.1	N/A	33.2	46.4	N/A	33.1	54.0
7236.0	47.9	N/A	34.7	47.5	N/A	34.7	54.0
7311.0	47.1	N/A	34.1	46.8	N/A	34.1	54.0
7386.0	47.4	N/A	34.4	47.0	N/A	34.4	54.0
12060.0	50.8	N/A	38.0	51.0	N/A	38.0	54.0
12185.0	50.8	N/A	37.7	50.3	N/A	37.8	54.0
12310.0	49.9	N/A	36.8	50.2	N/A	36.8	54.0

Other emissions present had amplitudes at least 20 dB below the limit. Peak and Quasi-Peak amplitude emissions are recorded for frequency below 1000 MHz. Peak and Average amplitude emissions are recorded for frequency range above 1000 MHz.

Summary of Results for Radiated Emissions in Restricted Bands

The EUT demonstrated compliance with the radiated emissions requirements of 47 CFR Part 15C RSS-Gen, and RSS-247 Intentional Radiators. The EUT worst-case 802.11 mode demonstrated a minimum radiated emission margin of -5.4 dB below the requirements in restricted frequency bands. Peak, Quasi-peak, and average amplitudes were checked for compliance with the regulations. Worst-case emissions are reported with other emissions found in the restricted frequency bands at least 20 dB below the requirements.

AC Line Conducted EMI Procedure

The EUT was arranged in typical equipment configurations as offered by manufacturer and presented above in equipment configuration. AC Line Conducted emission testing was performed with the EUT placed on a 1 x 1.5-meter bench 80 cm above the conducting ground plane, floor of a screen room. The bench was positioned 40 cm away from the wall of the screen room. The LISN was positioned on the floor of the screen room 80-cm from the rear of the EUT. Testing for the AC line-conducted emissions followed the procedures of ANSI C63.10-2013. The EUT was configured as presented in the AC Line conducted configurations as directed by the manufacture and presented above in equipment configuration. The AC adapter for the EUT was connected to the LISN for AC line-conducted emissions testing. A second LISN was positioned on the floor of the screen room 80-cm from the rear of the supporting equipment of the test configuration. All power cords except the EUT were then powered from the second LISN. EMI was coupled to the spectrum analyzer through a 0.1 μ F capacitor, internal to the LISN. Power line conducted emissions testing was carried out individually for each current carrying conductor of the EUT. The excess length of lead between the system and the LISN receptacle was folded back and forth to form a bundle not exceeding 40 cm in length. The screen room, conducting ground plane, analyzer, and LISN were bonded together to the protective earth ground. Preliminary testing was performed to identify the frequencies of each of the emissions, which demonstrated the highest amplitudes. The cables were repositioned to obtain maximum amplitude of measured EMI level. Once the worst-case configuration was identified, plots were made of the EMI from 0.15 MHz to 30 MHz and data recorded.

Refer to figures one and two for plots of the EUT – USB Computer interface AC Line conducted emissions. Refer to figures three and four showing plots of the AC Adapter configuration worst-case line conducted emissions.

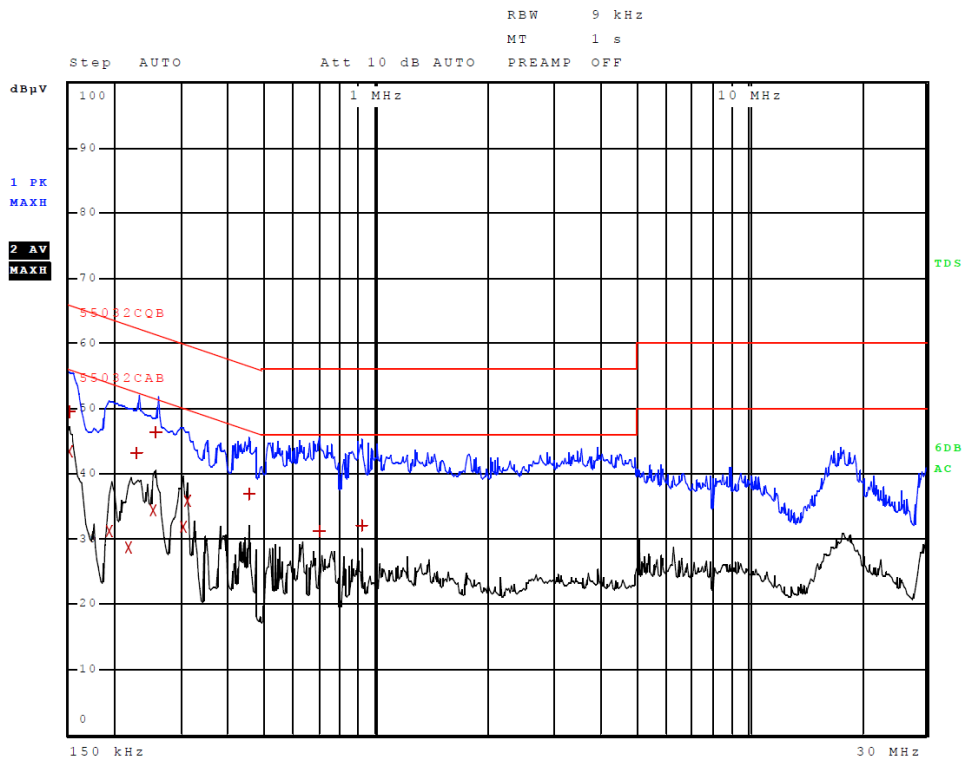

Figure 1 AC Line Conducted emissions of EUT line 1 (#2, EUT – Computer)

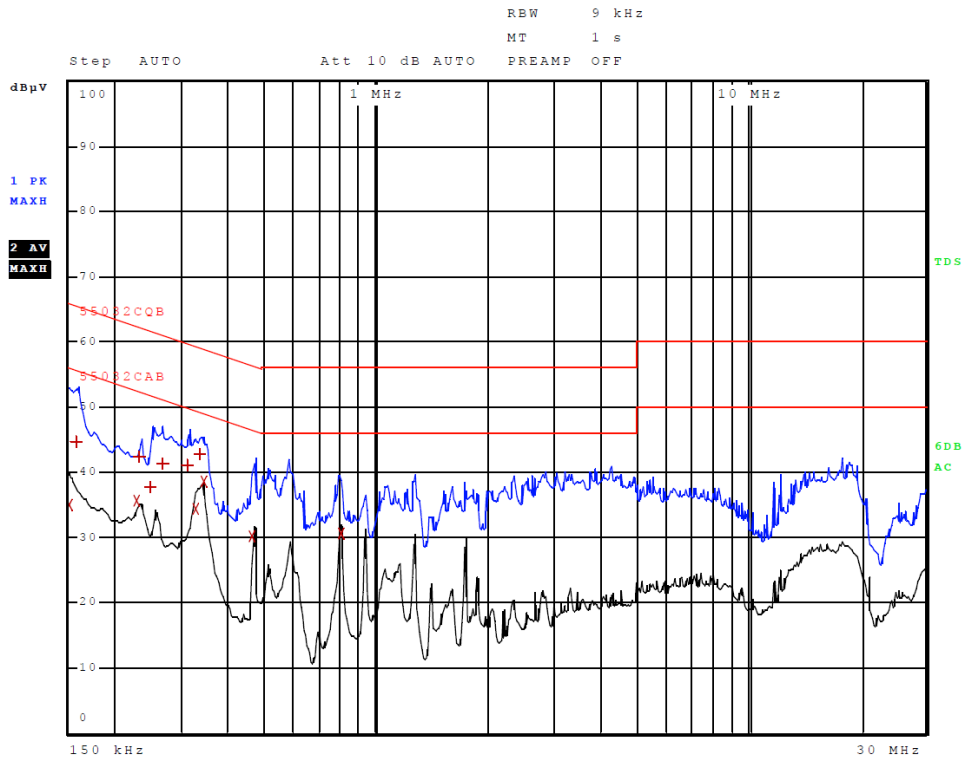

Figure 2 AC Line Conducted emissions of EUT line 2 (#2, EUT – Computer)

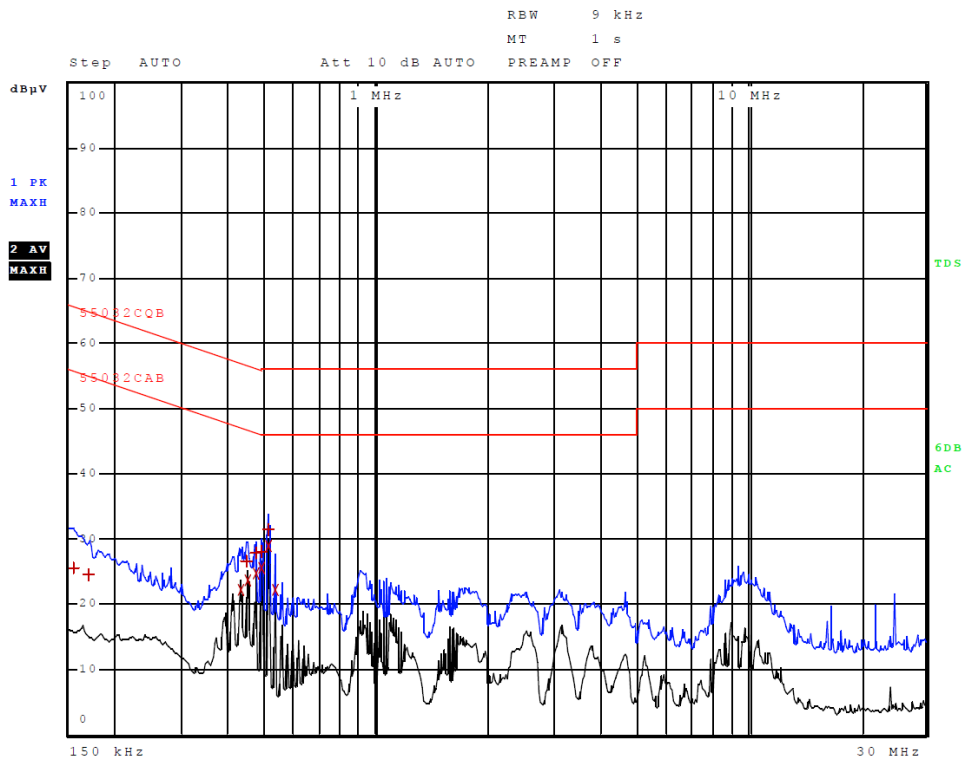

Figure 3 AC Line Conducted emissions of EUT line 1 (#3, EUT – 362-00096-00)

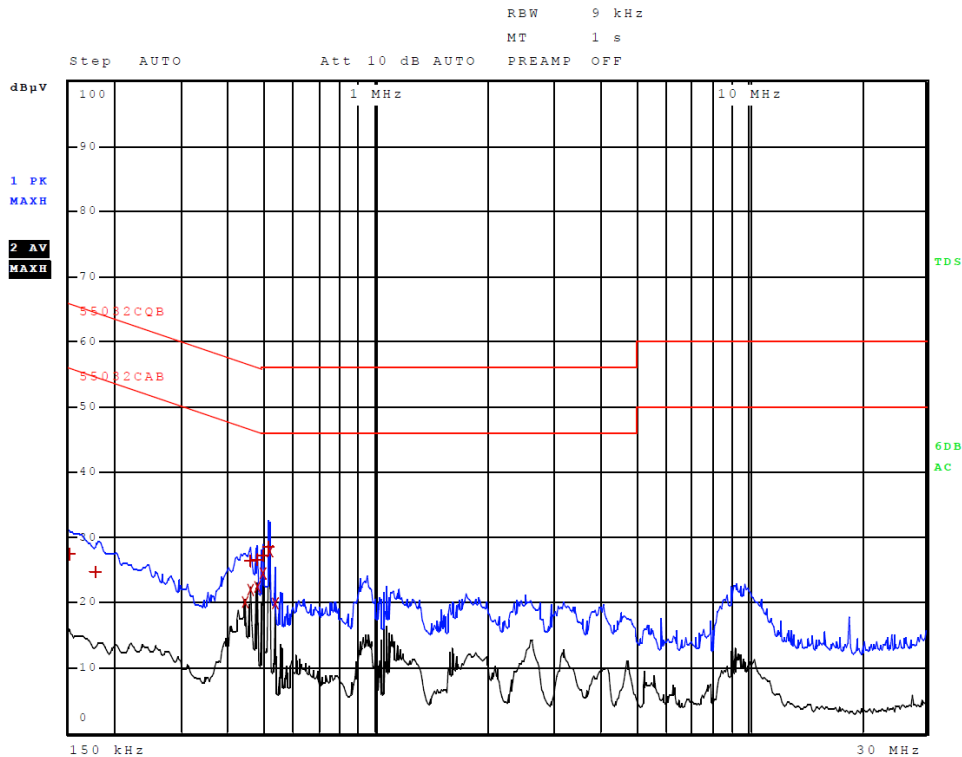

Figure 4 AC Line Conducted emissions of EUT line 2 (#3, EUT – 362-00096-00)

Table 4 AC Line Conducted Emissions Data L1 (#2, EUT – Computer)

Trace	Frequency	Level (dBµV)	Detector	Delta Limit/dB
1	150.000000000 kHz	49.38	Quasi Peak	-16.62
2	150.000000000 kHz	43.43	Average	-12.57
2	194.000000000 kHz	31.25	Average	-22.61
2	218.000000000 kHz	28.76	Average	-24.14
1	230.000000000 kHz	43.20	Quasi Peak	-19.25
2	254.000000000 kHz	34.42	Average	-17.20
1	258.000000000 kHz	46.24	Quasi Peak	-15.25
2	302.000000000 kHz	31.77	Average	-18.42
2	310.000000000 kHz	35.80	Average	-14.17
1	454.000000000 kHz	36.88	Quasi Peak	-19.92
1	698.000000000 kHz	31.23	Quasi Peak	-24.77
1	910.000000000 kHz	32.14	Quasi Peak	-23.86

Other emissions present had amplitudes at least 20 dB below the limit.

Table 5 AC Line Conducted Emissions Data L2 (#2, EUT – Computer)

Trace	Frequency	Level (dBµV)	Detector	Delta Limit/dB
2	150.000000000 kHz	34.94	Average	-21.06
1	158.000000000 kHz	44.72	Quasi Peak	-20.84
2	230.000000000 kHz	35.58	Average	-16.87
1	234.000000000 kHz	42.39	Quasi Peak	-19.91
1	250.000000000 kHz	37.79	Quasi Peak	-23.96
1	266.000000000 kHz	41.36	Quasi Peak	-19.88
1	314.000000000 kHz	41.17	Quasi Peak	-18.70
2	330.000000000 kHz	34.28	Average	-15.17
1	338.000000000 kHz	42.66	Quasi Peak	-16.59
2	342.000000000 kHz	38.60	Average	-10.56
2	466.000000000 kHz	30.14	Average	-16.45
2	802.000000000 kHz	30.65	Average	-15.35

Other emissions present had amplitudes at least 20 dB below the limit.

Table 6 AC Line Conducted Emissions Data L1 (#3, EUT – 362-00091-00)

Trace	Frequency	Level (dBµV)	Detector	Delta Limit/dB
1	154.000000000 kHz	25.56	Quasi Peak	-40.22
1	170.000000000 kHz	24.56	Quasi Peak	-40.40
2	430.000000000 kHz	22.09	Average	-25.16
1	446.000000000 kHz	26.62	Quasi Peak	-30.33
2	450.000000000 kHz	23.71	Average	-23.16
1	470.000000000 kHz	27.87	Quasi Peak	-28.64
2	470.000000000 kHz	24.73	Average	-21.78
1	490.000000000 kHz	28.14	Quasi Peak	-28.03
2	490.000000000 kHz	25.54	Average	-20.63
1	510.000000000 kHz	31.49	Quasi Peak	-24.51
2	510.000000000 kHz	28.90	Average	-17.10
2	534.000000000 kHz	22.17	Average	-23.83

Other emissions present had amplitudes at least 20 dB below the limit.

Table 7 AC Line Conducted Emissions Data L2 (#3, – 362-00091-00)

Trace	Frequency	Level (dBµV)	Detector	Delta Limit/dB
1	150.000000000 kHz	27.48	Quasi Peak	-38.52
1	178.000000000 kHz	24.72	Quasi Peak	-39.86
2	442.000000000 kHz	20.17	Average	-26.86
1	458.000000000 kHz	26.30	Quasi Peak	-30.43
2	458.000000000 kHz	22.06	Average	-24.67
2	478.000000000 kHz	22.42	Average	-23.95
1	478.000000000 kHz	26.58	Quasi Peak	-29.80
2	494.000000000 kHz	24.44	Average	-21.66
1	494.000000000 kHz	27.22	Quasi Peak	-28.88
1	510.000000000 kHz	28.57	Quasi Peak	-27.43
2	514.000000000 kHz	27.76	Average	-18.24
2	534.000000000 kHz	19.92	Average	-26.08

Other emissions present had amplitudes at least 20 dB below the limit.

Summary of Results for AC Line Conducted Emissions

The EUT demonstrated compliance with the AC Line Conducted Emissions requirements of 47CFR Part 15C, RSS-210 and RSS-Gen. The EUT configurations #2 worst-case configuration demonstrated a minimum margin of -10.5 dB below the requirement. The EUT configuration #3 worst-case configuration demonstrated a minimum margin of -17.1 dB below the requirement. Other emissions were present with amplitudes at least 20 dB below the limit and worst-case amplitudes recorded.

General Radiated Emissions Procedure

The EUT was arranged in a typical equipment configuration and operated through all available mode during testing. Preliminary testing was performed in a screen room with the EUT positioned 1 meter from the FSM. Radiated emissions measurements were performed to identify the frequencies, which produced the highest emissions. Each radiated emission was then maximized at the OATS location before final radiated measurements were performed. Final data was taken with the EUT located on the OATS at 3 meters distance between the EUT and the receiving antenna. The frequency spectrum from 9 kHz to 25,000 MHz was searched for general radiated emissions. Measured emission levels were maximized by EUT placement on the table, rotating the turntable through 360 degrees, varying the antenna height between 1 and 4 meters above the ground plane and changing antenna position between horizontal and vertical polarization. Antennas used were Loop from 9 kHz to 30 MHz, Broadband Biconical from 30 to 200 MHz, Biconilog from 30 to 1000 MHz, Log Periodic from 200 MHz to 1 GHz and or double Ridge or pyramidal horns and mixers above 1 GHz, notch filters and appropriate amplifiers and external mixers were utilized.

Table 8 General Radiated Emissions Data

Frequency in MHz	Horizontal Peak (dBµV/m)	Horizontal Quasi-Peak (dBµV/m)	Horizontal Average (dBµV/m)	Vertical Peak (dBµV/m)	Vertical Quasi-Peak (dBµV/m)	Vertical Average (dBµV/m)	Limit @ 3m (dBµV/m)
120.2	26.2	20.5	N/A	27.6	21.0	N/A	40.0
149.7	37.5	21.0	N/A	36.9	22.4	N/A	40.0
166.8	24.2	16.8	N/A	24.8	15.8	N/A	40.0
191.7	19.2	12.5	N/A	24.0	12.8	N/A	40.0
235.2	18.3	12.1	N/A	23.1	16.3	N/A	47.0
298.9	19.7	12.5	N/A	25.1	19.4	N/A	47.0

Other emissions present had amplitudes at least 20 dB below the limit. Peak and Quasi-Peak amplitude emissions are recorded for frequency range below 1000 MHz. Peak and Average amplitude emissions are recorded for frequency range above 1000 MHz.

Summary of Results for General Radiated Emissions

The EUT demonstrated compliance with the radiated emissions requirements of 47 CFR Part 15C paragraph 15.209, RSS-247 and RSS-GEN Intentional Radiators. The EUT demonstrated a minimum margin of -17.6 dB below the requirements. Other emissions were present with amplitudes at least 20 dB below the Limits.

Operation in the Band 2400 – 2483.5 MHz

Test procedures of ANSI C63.10-2013 paragraph 6, and KDB 558074 were used during transmitter testing. Test sample #2 was provided for testing antenna port conducted emissions. This sample was modified by replacing the internal antenna with a 50-ohm antenna port connector and attenuator for testing purposes. The transmitter peak and average power was measured at the antenna port using a wideband RF power meter as described in KDB 558074 and ANSI C63.10-2013. Average power measured did not include any time intervals during which the transmitter was off or transmitting at a reduced power level. The peak Power Spectral Density (PKPSD) was measured as defined in KDB 558074 and ANSI C63.10-2013. DTS Emission bandwidth was measured as described in KDB 558074 and ANSI C63.10-2013. The amplitude of each harmonic and general radiated emission was measured on the OATS at distance of 3 meters from the FSM antenna (radiated emission testing was performed on sample #1 representative of production equipment with integral antenna). The EUT was positioned on supporting turntable elevated as required above the ground plane, at a distance of 3 meters from the FSM antenna. Radiated emission investigations were performed from 9 kHz to 25,000 MHz. Each radiated emission was maximized by varying the FSM antenna height and polarization, and by rotating the turntable. The worst-case amplitude of each emission was then recorded from the analyzer display. The peak and quasi-peak amplitude of frequencies below 1000 MHz were measured using a spectrum analyzer. The peak and average amplitude of frequencies above 1000 MHz were measured using a spectrum analyzer. A Loop antenna was used for measuring emissions from 0.009 to 30 MHz, Biconilog Antenna for 30 to 1000 MHz, Double-Ridge, and/or Pyramidal Horn Antennas from 1 GHz to 25 GHz. Radiated Emissions were measured in dB μ V/m @ 3 meters. Plots were taken of transmitter performance (using sample #2) for reference in this and other documentation.

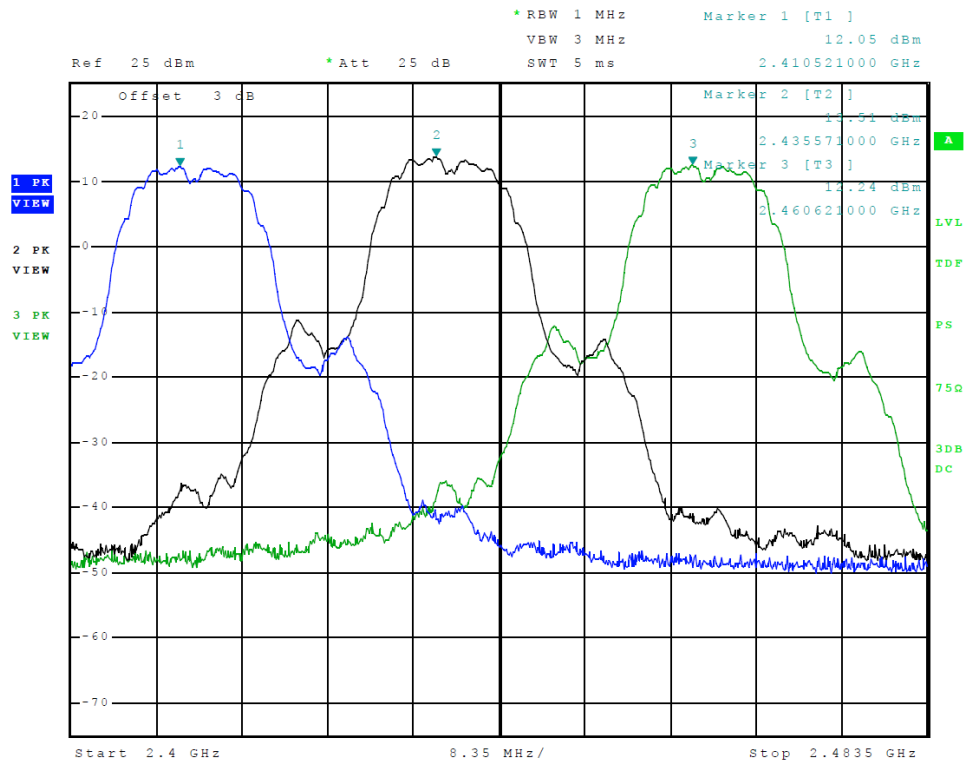

Figure 5 Plot of Transmitter Emissions in Operational Frequency (802.11 b-Mode)

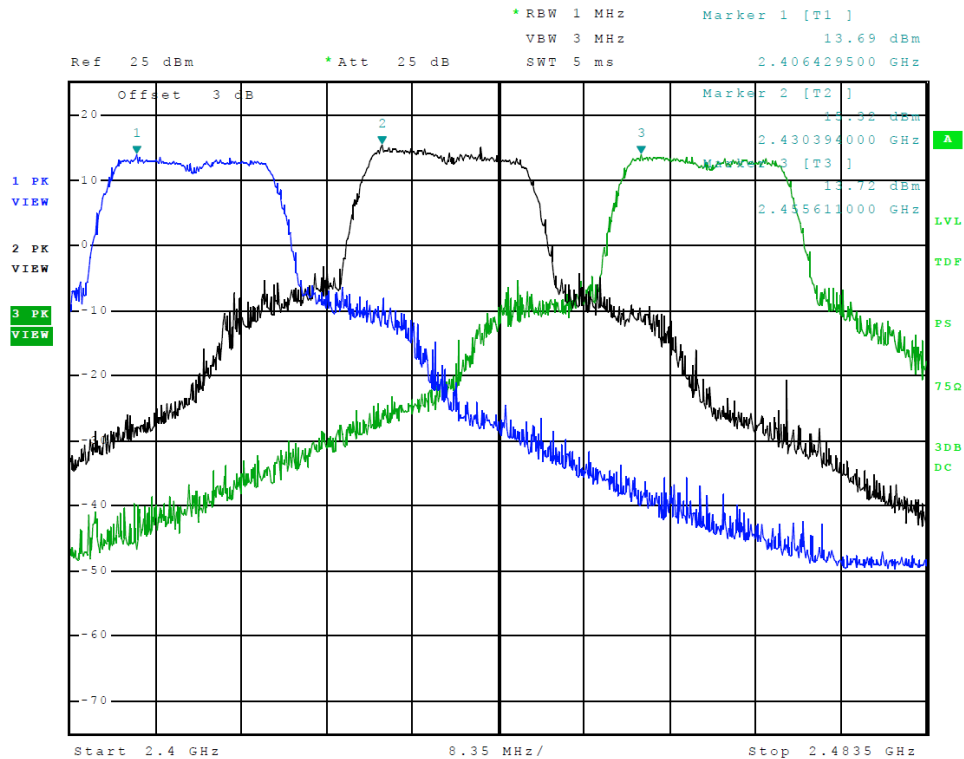

Figure 6 Plot of Transmitter Emissions in Operational Frequency (802.11 g-Mode)

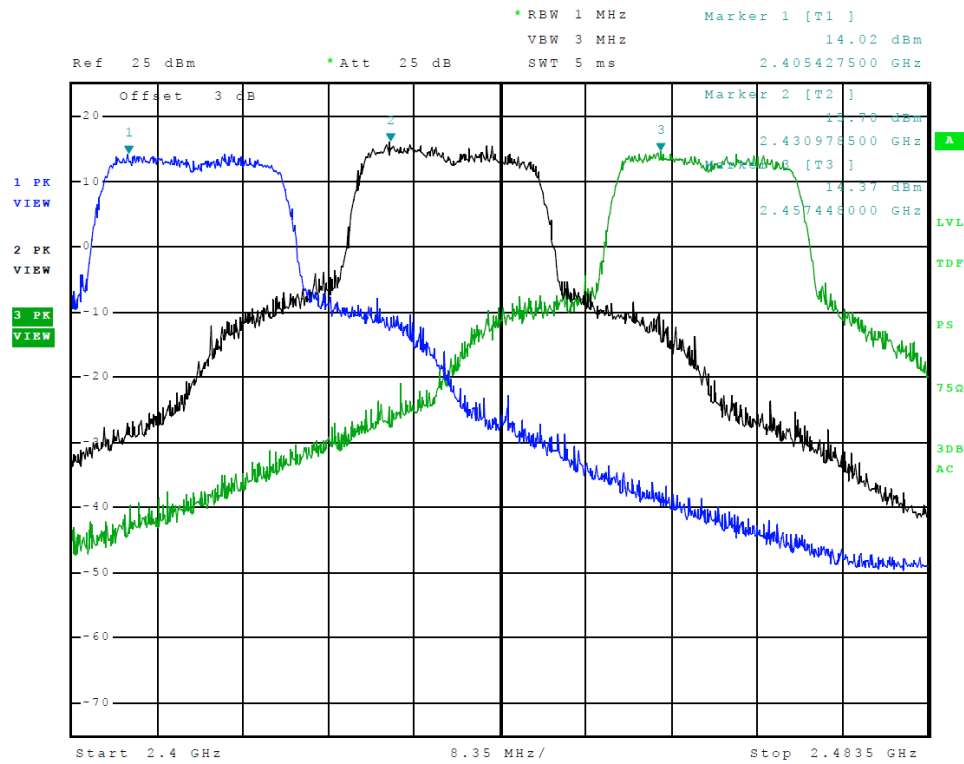

Figure 7 Plot of Transmitter Emissions in Operational Frequency (802.11 n-Mode)

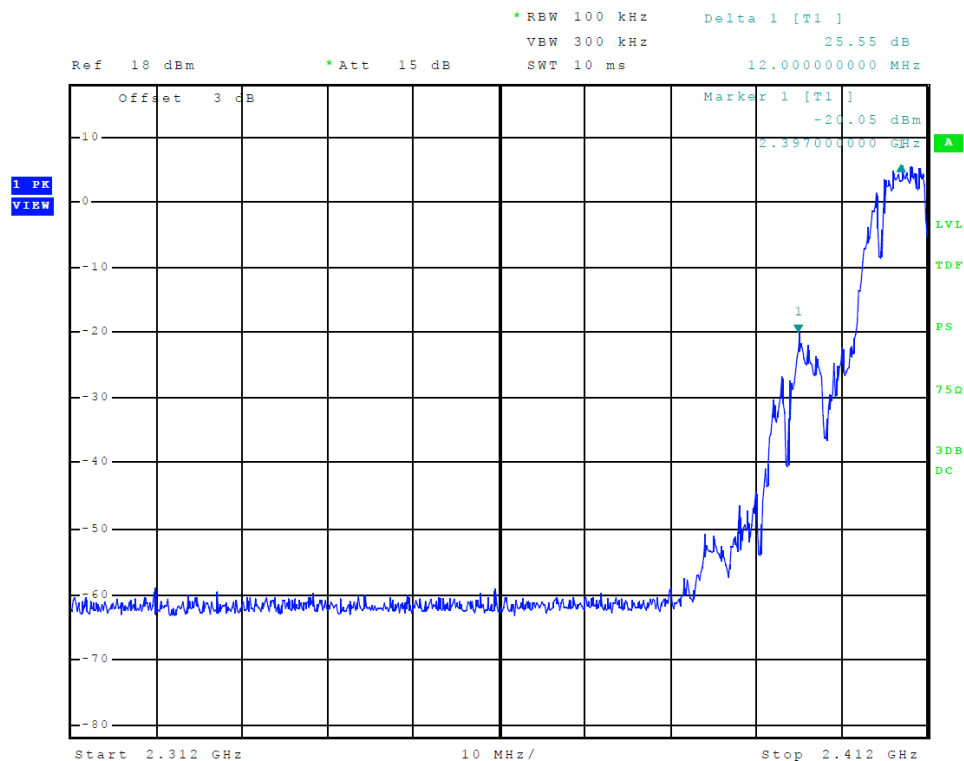

Figure 8 Plot of Lower Band Edge (802.11 b-mode)

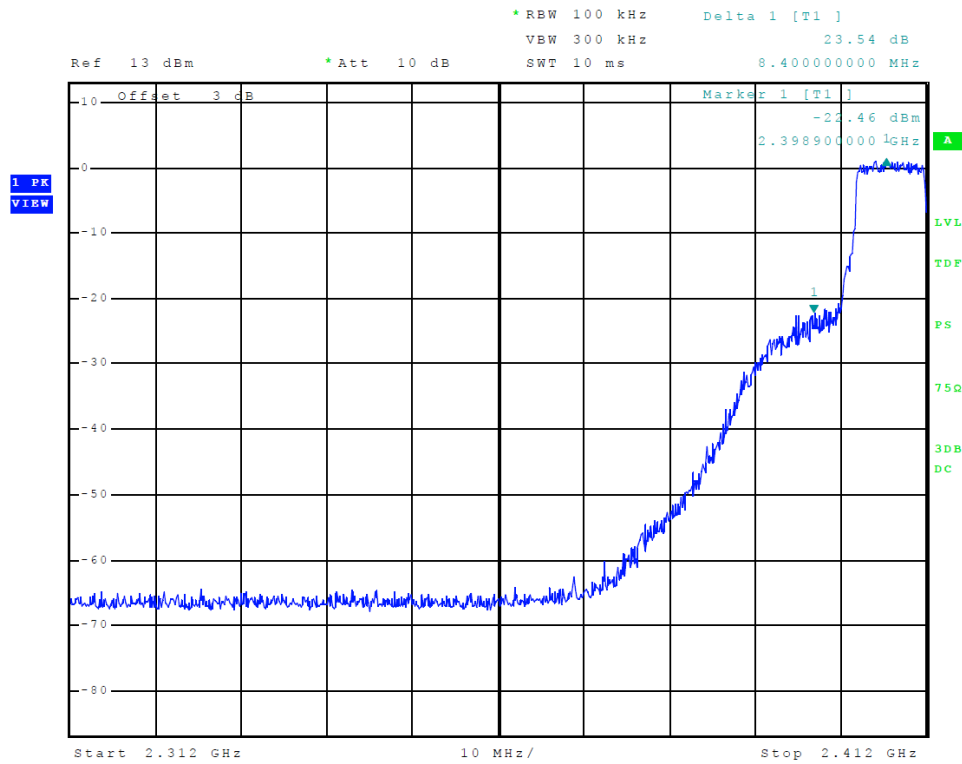

Figure 9 Plot of Lower Band Edge (802.11 g-mode)

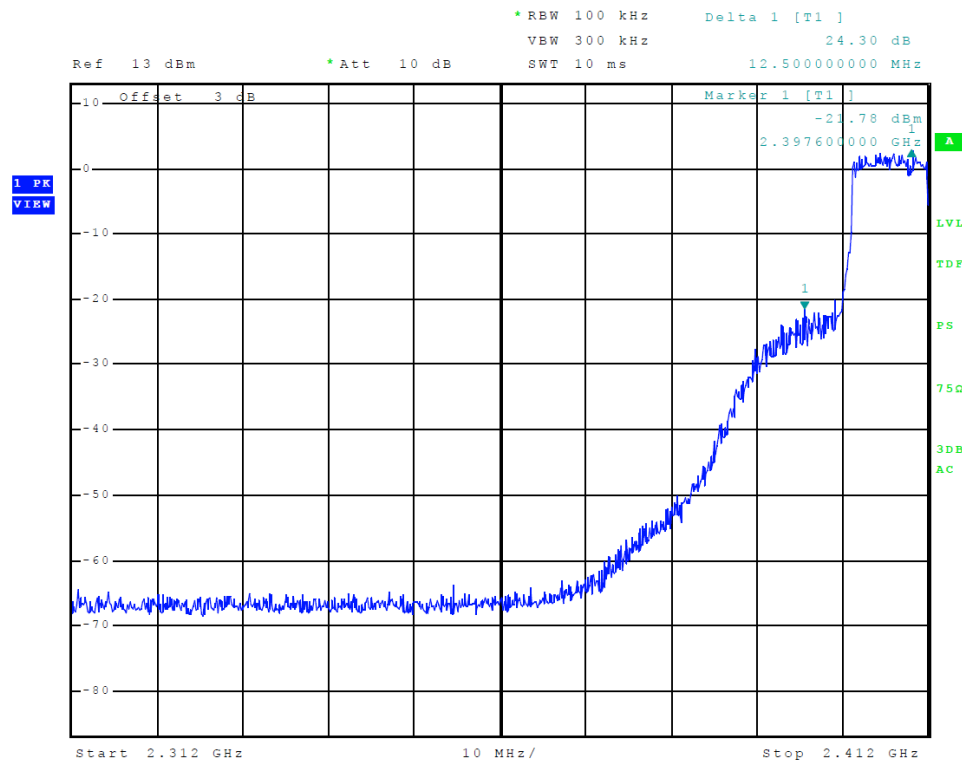

Figure 10 Plot of Lower Band Edge (802.11 n-mode)

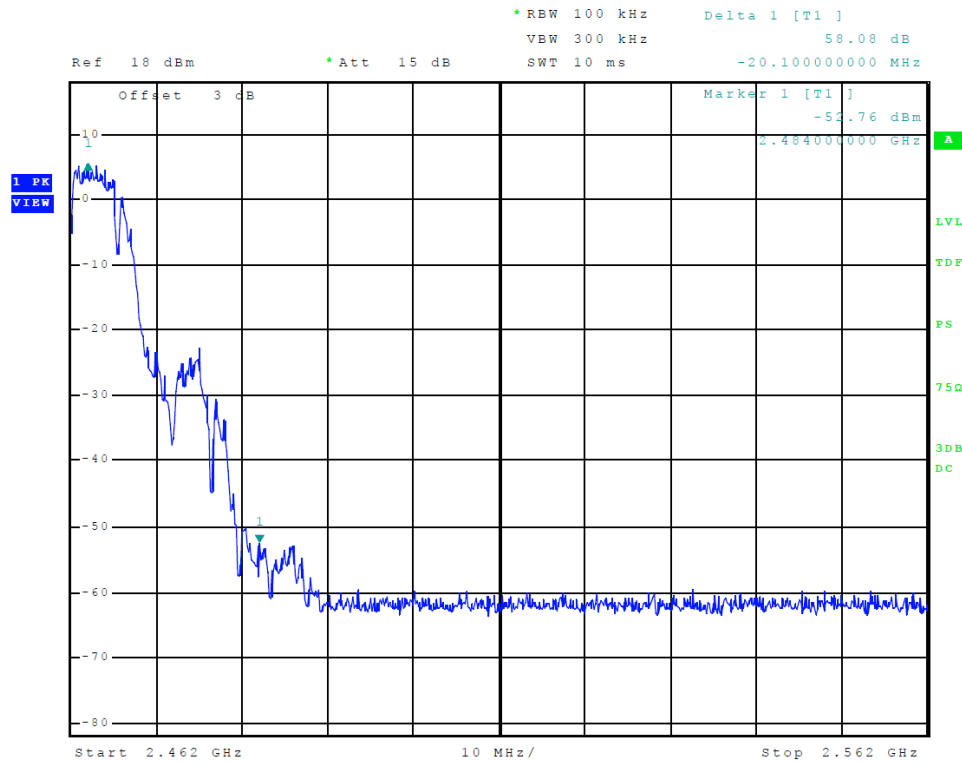

Figure 11 Plot of Upper Band Edge (802.11 b-mode)

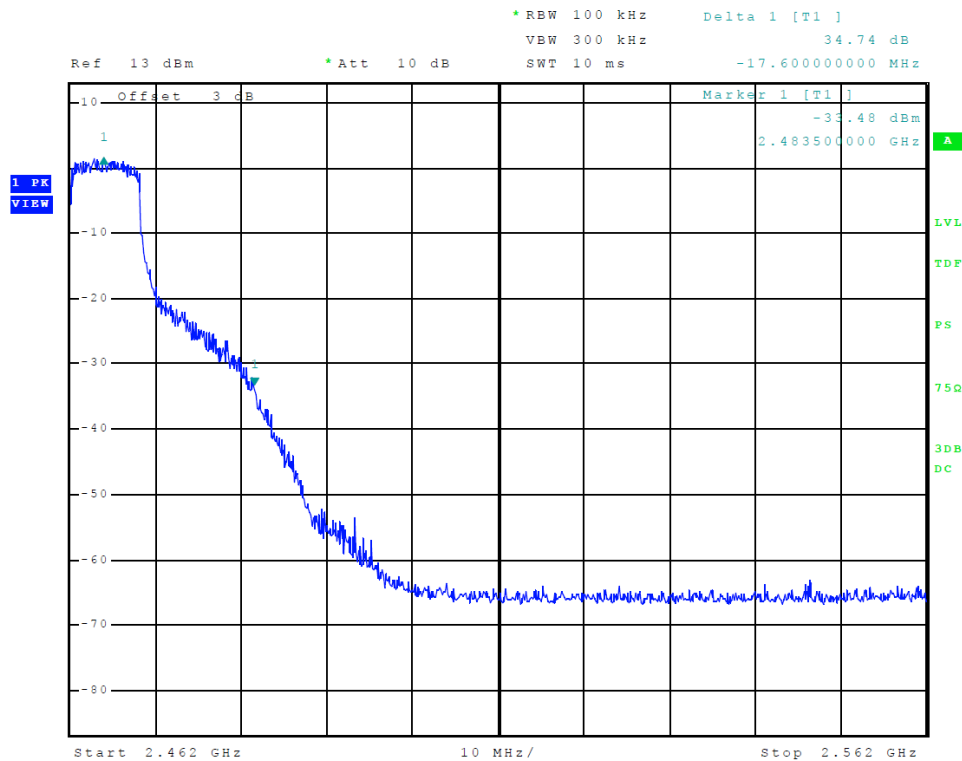

Figure 12 Plot of Upper Band Edge (802.11 g-mode)

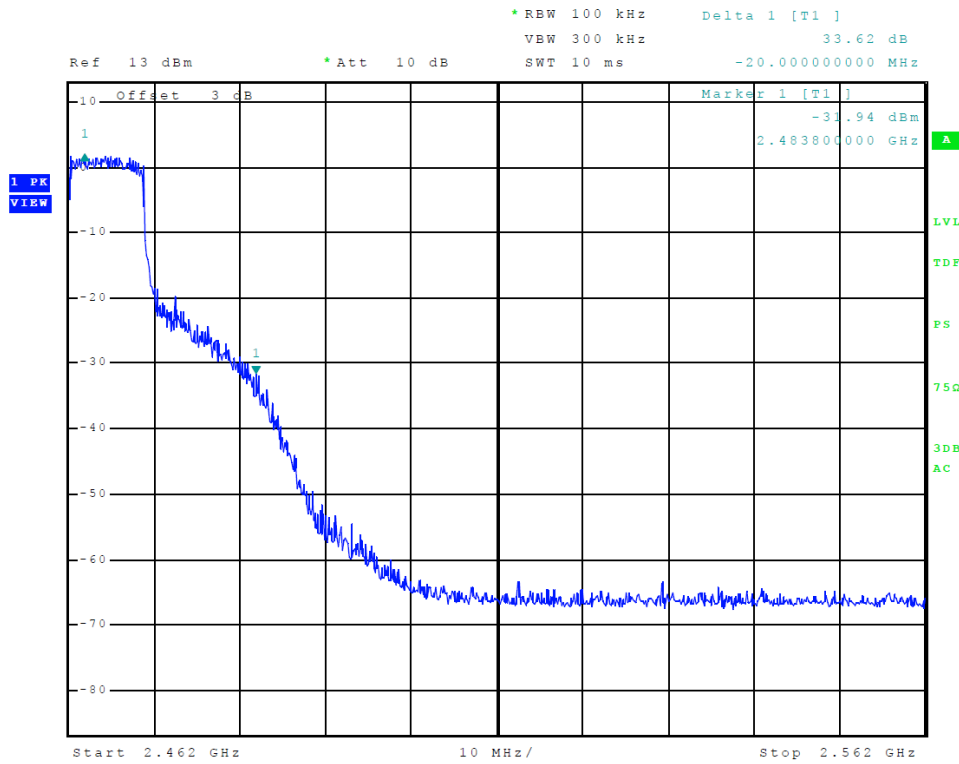

Figure 13 Plot of Upper Band Edge (802.11 n-mode)

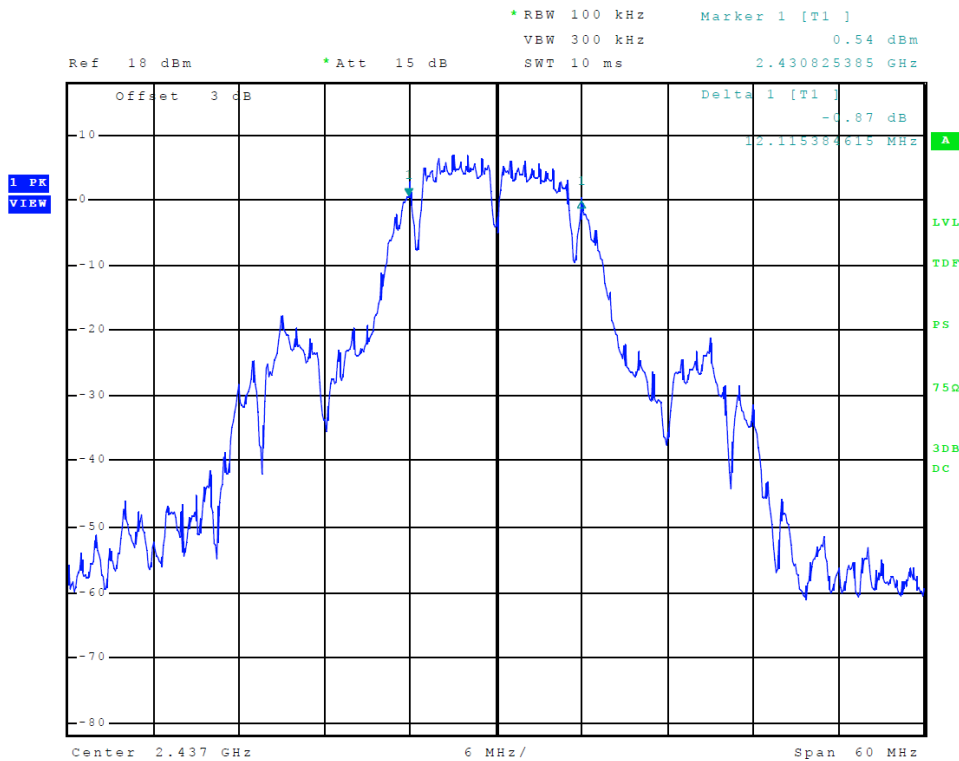

Figure 14 Plot of Transmitter 6-dB Occupied Bandwidth (802.11 b-mode)

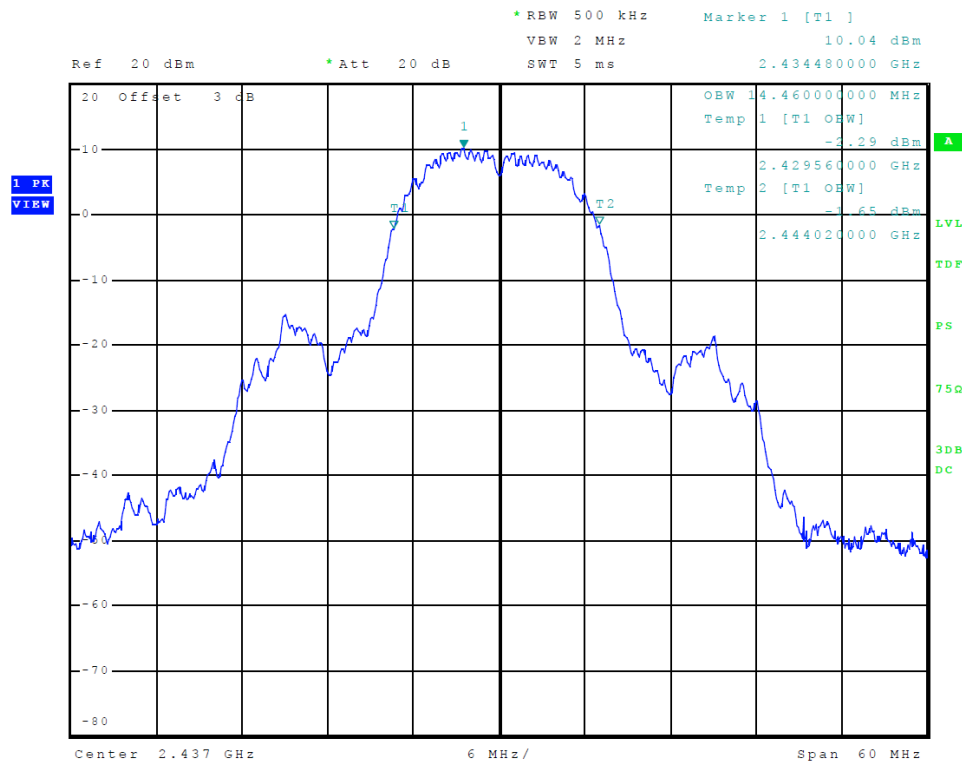

Figure 15 Plot of Transmitter 99% Occupied Bandwidth (802.11 b-mode)

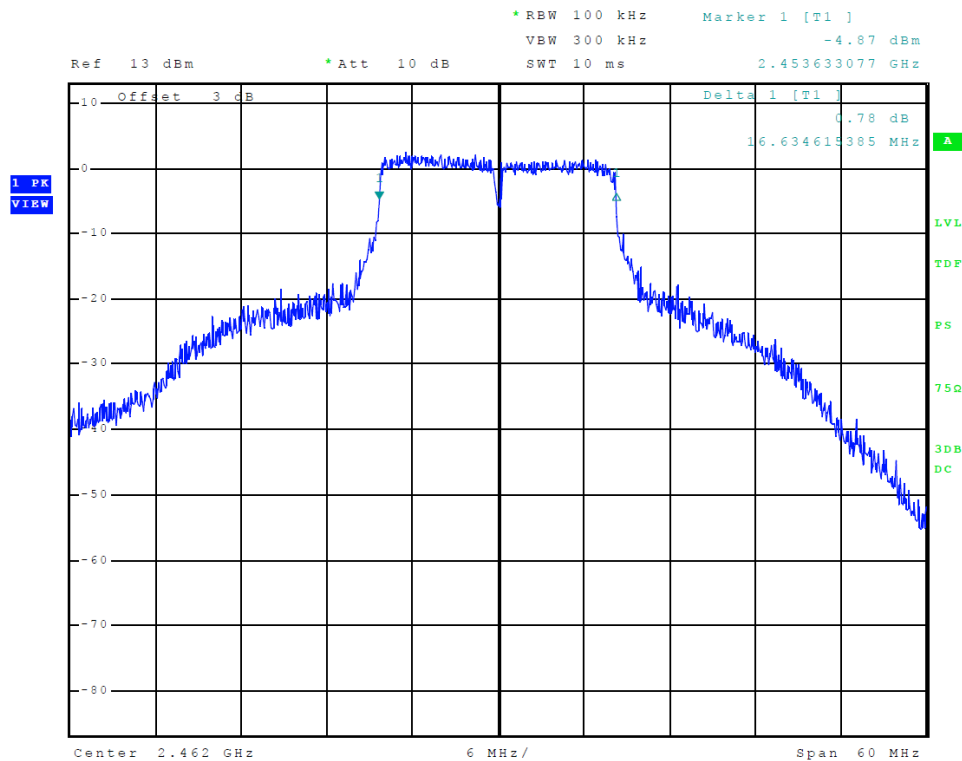

Figure 16 Plot of Transmitter 6-dB Occupied Bandwidth (802.11 g-mode)

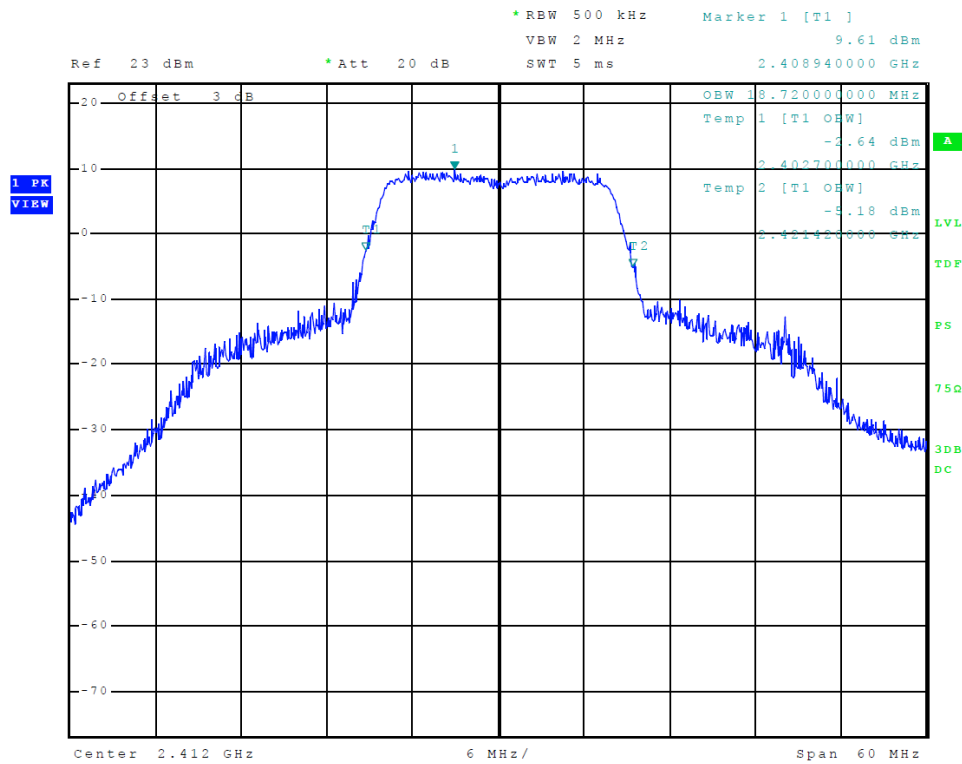

Figure 17 Plot of Transmitter 99% Occupied Bandwidth (802.11 g-mode)

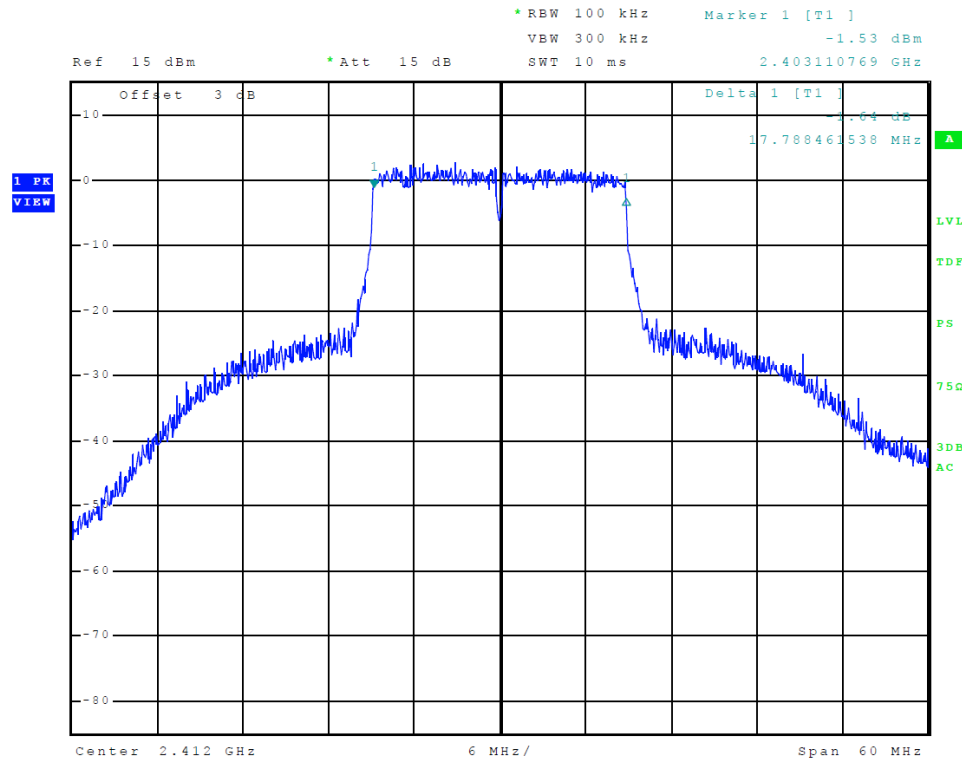

Figure 18 Plot of Transmitter 6-dB Occupied Bandwidth (802.11 n-mode)

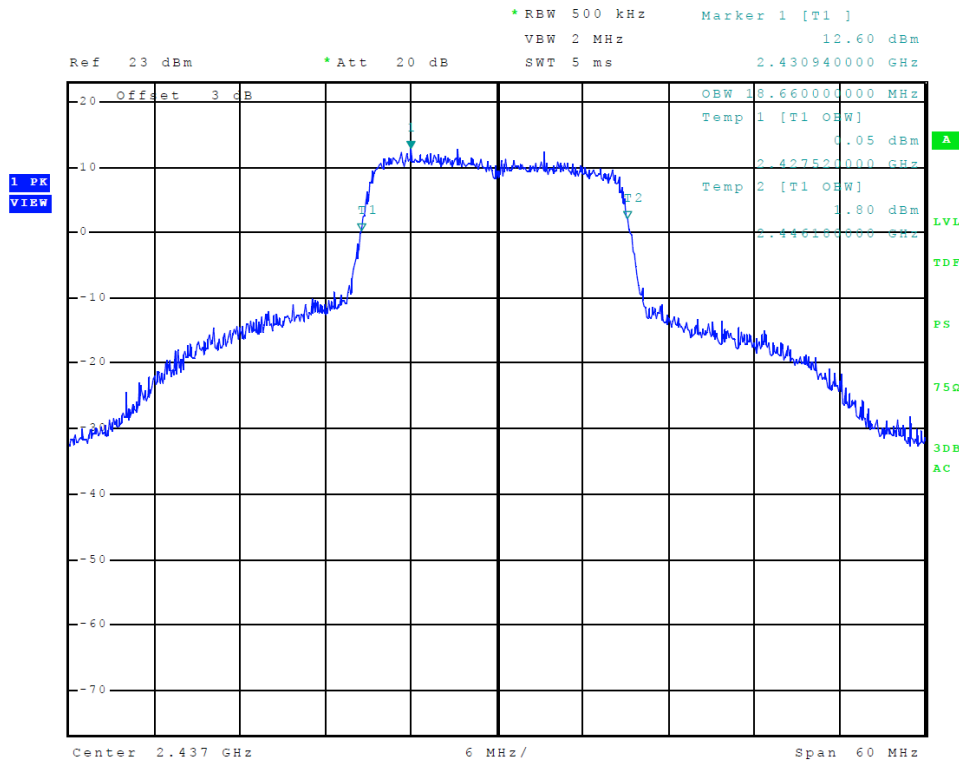

Figure 19 Plot of Transmitter 99% Occupied Bandwidth (802.11 n-mode)

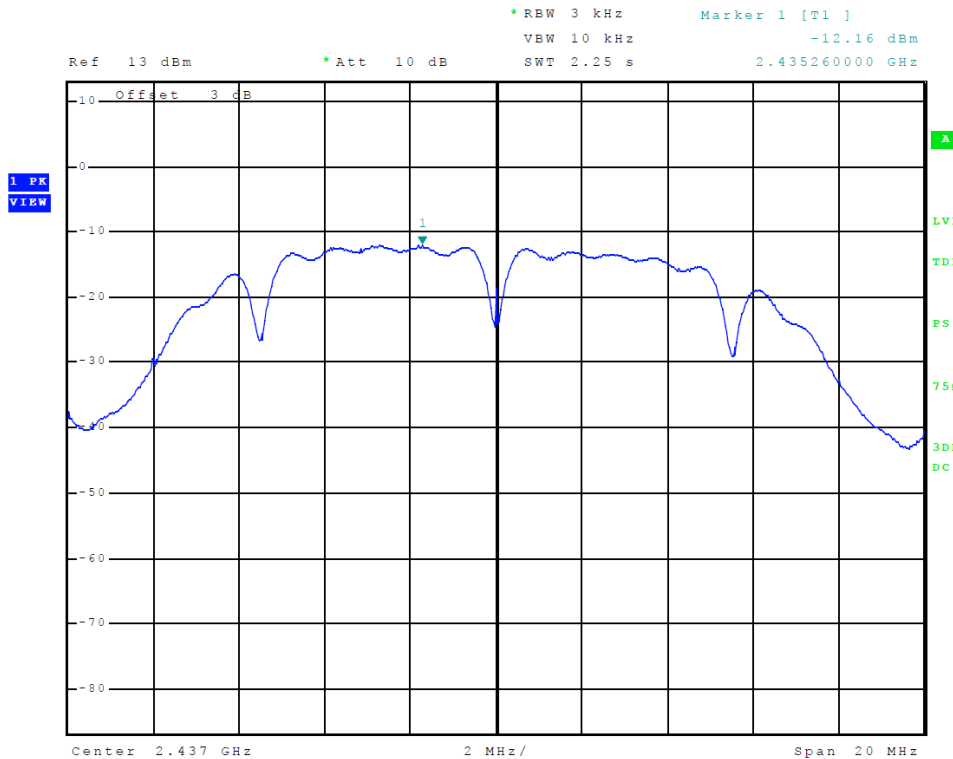

Figure 20 Plot of Transmitter Power Spectral Density (802.11 b-mode)

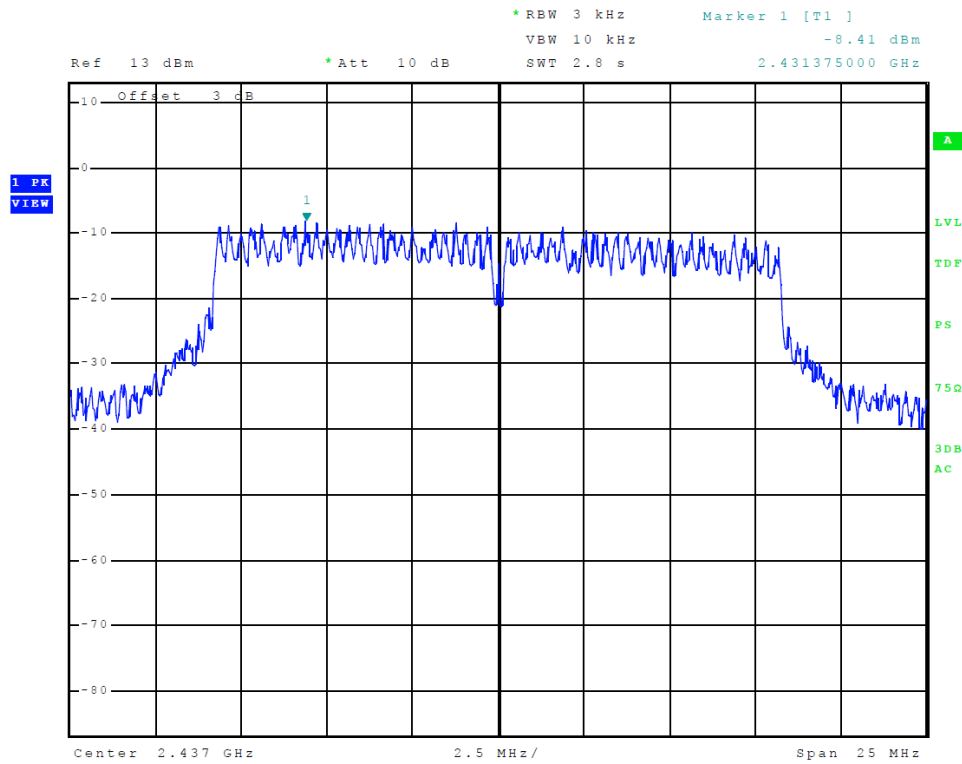

Figure 21 Plot of Transmitter Power Spectral Density (802.11 g-mode)

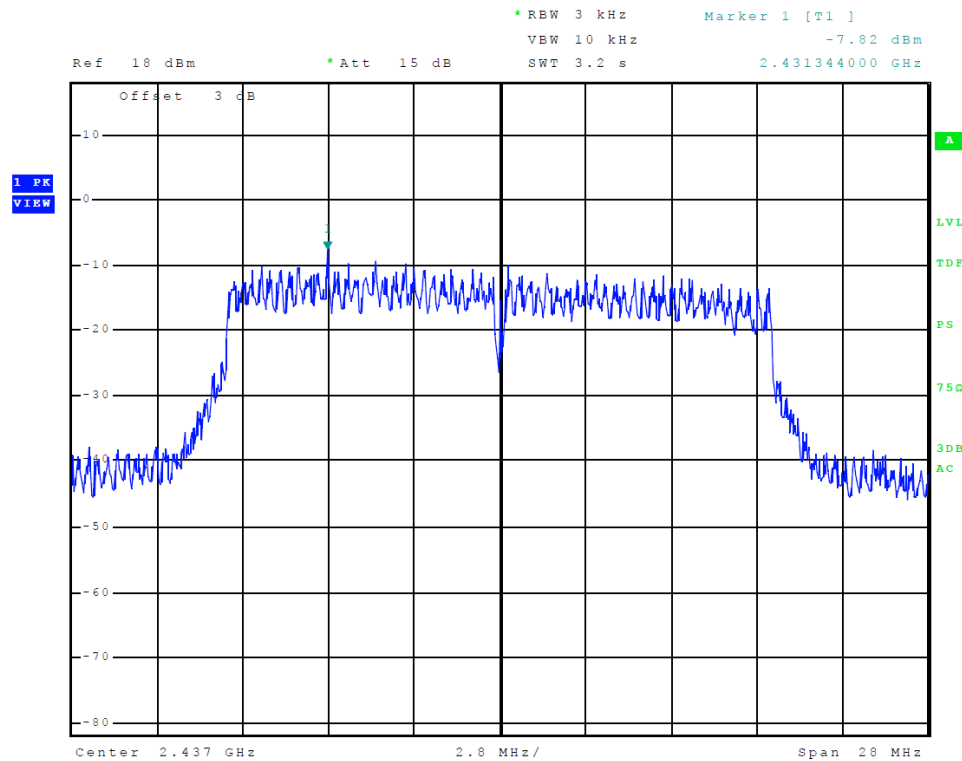

Figure 22 Plot of Transmitter Power Spectral Density (802.11 n-mode)

Transmitter Emissions Data

Table 9 Transmitter Radiated Emission Worst-case Data 802.11b

Frequency in MHz	Horizontal Peak (dBµV/m)	Horizontal Average (dBµV/m)	Vertical Peak (dBµV/m)	Vertical Average (dBµV/m)	Limit @ 3m (dBµV/m)
2412.0	--	--	--	--	--
4824.0	46.4	34.8	45.3	32.6	54.0
7236.0	47.5	34.7	47.8	34.7	54.0
9648.0	49.0	35.8	49.3	35.8	54.0
12060.0	50.4	37.9	51.6	37.9	54.0
14472.0	53.0	39.0	52.1	39.0	54.0
16884.0	56.6	43.7	56.6	43.9	54.0
2437.0	--	--	--	--	--
4874.0	46.5	34.1	44.9	32.3	54.0
7311.0	47.2	34.1	47.3	34.1	54.0
9748.0	48.9	35.9	48.4	35.9	54.0
12185.0	51.5	37.7	50.6	37.7	54.0
14622.0	53.3	39.9	52.4	39.9	54.0
17059.0	57.2	44.3	57.5	44.5	54.0
2462.0	--	--	--	--	--
4924.0	48.4	38.7	46.1	33.4	54.0
7386.0	47.2	34.6	47.0	34.4	54.0
9848.0	48.9	35.7	49.2	35.9	54.0
12310.0	49.7	37.0	50.5	37.1	54.0
14772.0	53.8	41.4	54.2	41.3	54.0
17234.0	55.7	42.6	55.6	42.6	54.0

Other emissions present had amplitudes at least 20 dB below the limit. Peak and Quasi-Peak amplitude emissions are recorded for frequency below 1000 MHz. Peak and Average amplitude emissions are recorded for frequency range above 1000 MHz.

Table 10 Transmitter Radiated Emission Worst-case Data 802.11g

Frequency in MHz	Horizontal Peak (dB μ V/m)	Horizontal Average (dB μ V/m)	Vertical Peak (dB μ V/m)	Vertical Average (dB μ V/m)	Limit @ 3m (dB μ V/m)
2412.0	--	--	--	--	--
4824.0	45.2	32.1	45.3	32.4	54.0
7236.0	47.7	34.6	47.9	34.7	54.0
9648.0	48.4	35.7	49.1	35.9	54.0
12060.0	50.5	38.0	50.6	38.0	54.0
14472.0	52.2	39.0	51.7	39.0	54.0
16884.0	56.9	44.0	56.6	44.0	54.0
2437.0	--	--	--	--	--
4874.0	45.8	32.7	45.9	32.6	54.0
7311.0	46.8	34.1	47.5	34.1	54.0
9748.0	49.4	35.9	49.4	35.9	54.0
12185.0	50.5	37.7	50.7	37.7	54.0
14622.0	52.6	39.9	52.8	39.5	54.0
17059.0	57.1	44.5	57.0	44.1	54.0
2462.0	--	--	--	--	--
4924.0	46.5	33.4	45.9	33.0	54.0
7386.0	47.4	34.4	47.4	34.4	54.0
9848.0	49.1	36.0	49.4	36.0	54.0
12310.0	50.4	36.9	50.4	37.2	54.0
14772.0	54.5	41.3	54.3	41.3	54.0
17234.0	55.5	42.6	55.6	42.6	54.0

Other emissions present had amplitudes at least 20 dB below the limit. Peak and Quasi-Peak amplitude emissions are recorded for frequency below 1000 MHz. Peak and Average amplitude emissions are recorded for frequency range above 1000 MHz.

Table 11 Transmitter Radiated Emission Worst-case Data 802.11n

Frequency in MHz	Horizontal Peak (dB μ V/m)	Horizontal Average (dB μ V/m)	Vertical Peak (dB μ V/m)	Vertical Average (dB μ V/m)	Limit @ 3m (dB μ V/m)
2412.0	--	--	--	--	--
4824.0	45.0	32.4	45.6	32.5	54.0
7236.0	47.9	34.7	47.5	34.7	54.0
9648.0	48.8	35.8	48.4	35.7	54.0
12060.0	50.8	38.0	51.0	38.0	54.0
14472.0	52.1	39.2	52.8	39.2	54.0
16884.0	57.3	44.2	57.3	44.2	54.0
2437.0	--	--	--	--	--
4874.0	45.1	32.6	45.6	32.8	54.0
7311.0	47.1	34.1	46.8	34.1	54.0
9748.0	49.1	36.1	49.2	36.0	54.0
12185.0	50.8	37.7	50.3	37.8	54.0
14622.0	53.6	40.0	53.3	40.0	54.0
17059.0	57.7	44.6	57.6	44.6	54.0
2462.0	--	--	--	--	--
4924.0	46.1	33.2	46.4	33.1	54.0
7386.0	47.4	34.4	47.0	34.4	54.0
9848.0	49.1	36.0	49.1	35.9	54.0
12310.0	49.9	36.8	50.2	36.8	54.0
14772.0	54.2	41.3	54.3	41.4	54.0
17234.0	55.2	42.6	55.1	42.6	54.0

Other emissions present had amplitudes at least 20 dB below the limit. Peak and Quasi-Peak amplitude emissions are recorded for frequency below 1000 MHz. Peak and Average amplitude emissions are recorded for frequency range above 1000 MHz.

Table 12 Transmitter Antenna Port Data

Frequency MHz	Antenna Port Output Peak / Average (Watts)	99% Occupied Bandwidth (kHz)	6-dB Occupied Bandwidth (kHz)	Peak Power Spectral Density (dBm)
802.11b				
2412	0.093 / 0.054	14,340.0	12,211.5	-13.8
2437	0.128 / 0.076	14,460.0	12,115.4	-12.2
2462	0.099 / 0.058	14,460.0	12,211.5	-13.6
802.11g				
2412	0.161 / 0.040	18,720.0	16,538.5	-10.8
2437	0.200 / 0.054	18,660.0	16,538.5	-8.4
2462	0.0175 / 0.042	18,720.0	16,634.6	-9.4
802.11n				
2412	0.169 / 0.040	18,600.0	17,788.5	-10.9
2437	0.204 / 0.054	18,660.0	17,788.5	-7.8
2462	0.181 / 0.043	18,660.0	17,788.5	-11.0

Summary of Results for Transmitter Radiated Emissions of Intentional Radiator

The EUT demonstrated compliance with the radiated and conducted emission requirements of 47CFR Part 15.247, RSS-GEN, and RSS-247 Digital Transmission Systems. Peak Output power of 0.204 Watts was measured at the antenna port and average output power of 0.076 Watts. The peak power spectral density measured at the antenna port presented a minimum margin of -15.8 dB below the requirements. The EUT demonstrated a minimum margin of 9.4 dB below the harmonic emissions requirements. There were no other significantly measurable emissions in the restricted bands other than those recorded in this report. Other emissions were present with amplitudes at least 20 dB below the requirements. There were no other deviations or exceptions to the requirements.

Annex

- Annex A Measurement Uncertainty Calculations
- Annex B Additional Test Equipment List
- Annex C Rogers Qualifications
- Annex D Rogers Labs Certificate of Accreditation

Annex A Measurement Uncertainty Calculations

The measurement uncertainty was calculated for all measurements listed in this test report according To CISPR 16-4. Result of measurement uncertainty calculations are recorded below. Component and process variability of production devices similar to those tested may result in additional deviations. The manufacturer has the sole responsibility of continued compliance.

Measurement	Expanded Measurement Uncertainty $U_{(lab)}$
3 Meter Horizontal 0.009-1000 MHz Measurements	4.16
3 Meter Vertical 0.009-1000 MHz Measurements	4.33
3 Meter Measurements 1-18 GHz	5.14
3 Meter Measurements 18-40 GHz	5.16
10 Meter Horizontal Measurements 0.009-1000 MHz	4.15
10 Meter Vertical Measurements 0.009-1000 MHz	4.32
AC Line Conducted	1.75
Antenna Port Conducted power	1.17
Frequency Stability	1.00E-11
Temperature	1.6°C
Humidity	3%

Annex B Additional Test Equipment List

List of Test Equipment	Calibration	<u>Date (m/d/y)</u>	<u>Due</u>
Antenna: Schwarzbeck Model: BBA 9106/VHBB 9124 (9124-627)		5/2/2018	5/2/2019
Antenna: Schwarzbeck Model: VULP 9118 A (VULP 9118 A-534)		5/2/2018	5/2/2019
Antenna: EMCO 6509		10/16/2018	10/16/2020
Antenna: EMCO 3143 (9607-1277) 20-1200 MHz		5/2/2018	5/2/2019
Antenna: EMCO Dipole Set 3121C		2/23/2018	2/23/2019
Antenna: C.D. B-101		2/23/2018	2/23/2019
Antenna: Solar 9229-1 & 9230-1		2/23/2018	2/23/2019
Cable: Belden 8268 (L3)		10/16/2018	10/16/2019
Cable: Time Microwave: 4M-750HF290-750		10/16/2018	10/16/2019
Frequency Counter: Leader LDC-825 (8060153)		5/2/2018	5/2/2019
Oscilloscope Scope: Tektronix 2230		2/23/2018	2/23/2019
Wattmeter: Bird 43 with Load Bird 8085		2/23/2018	2/23/2019
R.F. Generator: SMB100A6 s/n 100623		5/2/2018	5/2/2019
R.F. Generator: SBMBV100A s/n: 260771		5/2/2018	5/2/2019
R.F. Generators: HP 606A, HP 8614A, HP 8640B		2/23/2018	2/23/2019
R.F. Power Amp 65W Model: 470-A-1010		2/23/2018	2/23/2019
R.F. Power Amp 50W M185- 10-501		2/23/2018	2/23/2019
R.F. Power Amp A.R. Model: 10W 1010M7		2/23/2018	2/23/2019
R.F. Power Amp EIN Model: A301		2/23/2018	2/23/2019
LISN: Compliance Eng. Model 240/20		5/2/2018	5/2/2019
LISN: Fischer Custom Communications Model: FCC-LISN-50-16-2-08		5/2/2018	5/2/2019
Audio Oscillator: H.P. 201CD		2/23/2018	2/23/2019
ESD Test Set 2010i		2/23/2018	2/23/2019
Oscilloscope Scope: Tektronix MDO 4104		2/23/2018	2/23/2019
EMC Transient Generator HVT TR 3000		2/23/2018	2/23/2019
AC Power Source (Ametek, California Instruments)		2/23/2018	2/23/2019
Fast Transient Burst Generator Model: EFT/B-101		2/23/2018	2/23/2019
Field Intensity Meter: EFM-018		2/23/2018	2/23/2019
KEYTEK Ecat Surge Generator		2/23/2018	2/23/2019
ESD Simulator: MZ-15		2/23/2018	2/23/2019
Shielded Room not required			

Rogers Labs, Inc.
4405 W. 259th Terrace
Louisburg, KS 66053
Phone/Fax: (913) 837-3214
Revision 1

Garmin International, Inc.
Model: A03521
Test #: 181211
Test to: CFR47 15C, RSS-Gen RSS-247
File: A03521 DTS TstRpt 181211

SN's: 3986187656, 3986187638
FCC ID: IPH-03521
IC: 1792A-03521
Date: January 18, 2019
Page 46 of 48

Annex C Rogers Qualifications

Scot D. Rogers, Engineer

Rogers Labs, Inc.

Mr. Rogers has approximately 30 years' experience in the field of electronics. Work experience includes six years working in the automated controls industry and remaining years working with the design, development and testing of radio communications and electronic equipment.

Positions Held:

Systems Engineer: A/C Controls Mfg. Co., Inc. 6 Years

Electrical Engineer: Rogers Consulting Labs, Inc. 5 Years

Electrical Engineer: Rogers Labs, Inc. Current

Educational Background:

- 1) Bachelor of Science Degree in Electrical Engineering from Kansas State University
- 2) Bachelor of Science Degree in Business Administration Kansas State University
- 3) Several Specialized Training courses and seminars pertaining to Microprocessors and Software programming.

Annex D Laboratory Certificate of Accreditation

United States Department of Commerce
National Institute of Standards and Technology



Certificate of Accreditation to ISO/IEC 17025:2005

NVLAP LAB CODE: 200087-0

Rogers Labs, Inc.

Louisburg, KS

*is accredited by the National Voluntary Laboratory Accreditation Program for specific services,
listed on the Scope of Accreditation, for:*

Electromagnetic Compatibility & Telecommunications

*This laboratory is accredited in accordance with the recognized International Standard ISO/IEC 17025:2005.
This accreditation demonstrates technical competence for a defined scope and the operation of a laboratory quality
management system (refer to joint ISO-ILAC-IAF Communique dated January 2009).*

2018-02-21 through 2019-03-31
Effective Dates

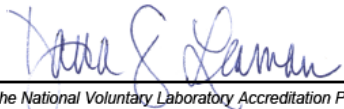

For the National Voluntary Laboratory Accreditation Program

Rogers Labs, Inc.
4405 W. 259th Terrace
Louisburg, KS 66053
Phone/Fax: (913) 837-3214
Revision 1

Garmin International, Inc.
Model: A03521
Test #: 181211
Test to: CFR47 15C, RSS-Gen RSS-247
File: A03521 DTS TstRpt 181211

SN's: 3986187656, 3986187638
FCC ID: IPH-03521
IC: 1792A-03521
Date: January 18, 2019
Page 48 of 48