

Application For Grant of Certification

FOR

Model: A03363
2412-2462 MHz (DTS)
Broadband Digital Transmission System
FCC ID: IPH-03363
IC: 1792A-03363

FOR

Garmin International, Inc.

1200 East 151st Street
Olathe, KS 66062

FCC Designation: US5305
IC Test Site Registration: 3041A-1

Test Report Number: 180827

Authorized Signatory: *Scot D Rogers*
Scot D. Rogers

Rogers Labs, Inc.
4405 W. 259th Terrace
Louisburg, KS 66053
Phone/Fax: (913) 837-3214
Revision 2

Garmin International, Inc. SN's: 5FK000182 / 5FK000158
Model: A03363
Test #: 180827
Test to: CFR47 15C, RSS-Gen RSS-247
File: A03363 DTS TstRpt 180827 r2

FCC ID: IPH-03363
IC: 1792A-03363
Date: September 8, 2018
Page 1 of 32

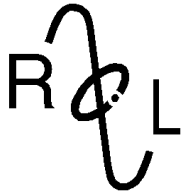

ROGERS LABS, INC.

4405 West 259th Terrace
Louisburg, KS 66053
Phone / Fax (913) 837-3214

Engineering Test Report For Grant of Certification Application

FOR
47 CFR, PART 15C - Intentional Radiators
47 CFR Paragraph 15.247 and
Industry Canada RSS-GEN and RSS-247
License Exempt Intentional Radiator

For
Garmin International, Inc.

1200 East 151st Street
Olathe, KS 66062

Digital Transmission System
Model: A03363

Frequency Range 2412-2462 MHz
FCC ID: IPH-03363
IC: 1792A-03363

Test Date: August 27, 2018

Certifying Engineer: *Scot D. Rogers*
Scot D. Rogers
Rogers Labs, Inc.
4405 West 259th Terrace
Louisburg, KS 66053
Telephone/Facsimile: (913) 837-3214

This report shall not be reproduced except in full, without the written approval of the laboratory.
This report must not be used by the client to claim product certification, approval, or
endorsement by NVLAP, NIST, or any agency of the Federal Government.

Rogers Labs, Inc.
4405 W. 259th Terrace
Louisburg, KS 66053
Phone/Fax: (913) 837-3214
Revision 2

Garmin International, Inc. SN's: 5FK000182 / 5FK000158
Model: A03363
Test #: 180827
Test to: CFR47 15C, RSS-Gen RSS-247
File: A03363 DTS TstRpt 180827 r2

FCC ID: IPH-03363
IC: 1792A-03363
Date: September 8, 2018
Page 2 of 32

Table of Contents

TABLE OF CONTENTS.....	3
REVISIONS.....	5
FOREWORD.....	6
OPINION / INTERPRETATION OF RESULTS	6
EQUIPMENT TESTED.....	6
EQUIPMENT FUNCTION AND CONFIGURATION.....	7
Equipment Configuration.....	7
APPLICATION FOR CERTIFICATION.....	8
APPLICABLE STANDARDS & TEST PROCEDURES	9
TESTING PROCEDURES	9
AC Line Conducted Emission Test Procedure	9
Radiated Emission Test Procedure.....	9
Diagram 1 Test arrangement for radiated emissions of tabletop equipment.....	10
Diagram 2 Test arrangement for radiated emissions tested on Open Area Test Site (OATS).....	11
TEST SITE LOCATIONS	11
LIST OF TEST EQUIPMENT	12
UNITS OF MEASUREMENTS	13
ENVIRONMENTAL CONDITIONS.....	13
STATEMENT OF MODIFICATIONS AND DEVIATIONS	13
INTENTIONAL RADIATORS.....	13
Antenna Requirements	13
Restricted Bands of Operation.....	14

Table 1 Harmonic Radiated Emissions in Restricted Bands Data (802.11, Worst-case).....14

Summary of Results for Radiated Emissions in Restricted Bands15

General Radiated Emissions Procedure.....15

Table 2 General Radiated Emissions Data16

Summary of Results for General Radiated Emissions16

Operation in the Band 2400 – 2483.5 MHz17

Figure 1 Plot of Transmitter Emissions in Operational Frequency (802.11 b-Mode)18

Figure 2 Plot of Transmitter Emissions in Operational Frequency (802.11 g-Mode)18

Figure 3 Plot of Transmitter Emissions in Operational Frequency (802.11 n-Mode)19

Figure 4 Plot of Lower Band Edge (802.11 b-mode)19

Figure 5 Plot of Lower Band Edge (802.11 g-mode)20

Figure 6 Plot of Lower Band Edge (802.11 n-mode)20

Figure 7 Plot of Upper Band Edge (802.11 b-mode).....21

Figure 8 Plot of Upper Band Edge (802.11 g-mode).....21

Figure 9 Plot of Upper Band Edge (802.11 n-mode).....22

Figure 10 Plot of Transmitter 6-dB Occupied Bandwidth (802.11 b-mode)22

Figure 11 Plot of Transmitter 99% Occupied Bandwidth (802.11 b-mode).....23

Figure 12 Plot of Transmitter 6-dB Occupied Bandwidth (802.11 g-mode)23

Figure 13 Plot of Transmitter 99% Occupied Bandwidth (802.11 g-mode).....24

Figure 14 Plot of Transmitter 6-dB Occupied Bandwidth (802.11 n-mode)24

Figure 15 Plot of Transmitter 99% Occupied Bandwidth (802.11 n-mode).....25

Figure 16 Plot of Transmitter Power Spectral Density (802.11 b-mode)25

Figure 17 Plot of Transmitter Power Spectral Density (802.11 g-mode)26

Figure 18 Plot of Transmitter Power Spectral Density (802.11 n-mode)26

Transmitter Emissions Data.....27

Table 3 Transmitter Radiated Emission Worst-case Data27

Table 4 Transmitter Antenna Port Data28

Summary of Results for Transmitter Radiated Emissions of Intentional Radiator28

ANNEX..... 29

Annex A Measurement Uncertainty Calculations30

Annex B Rogers Qualifications31

Annex C Rogers Labs Certificate of Accreditation32

Revisions

Revision 2 Issued September 8, 2018 – corrected Equipment list (page 12) and removed list in annex

Revision 1 Issued September 4, 2018

Foreword

The following information is submitted for consideration in obtaining Grant of Certification for License Exempt Digital Transmission System Intentional Radiator operating under Code of Federal Regulations Title 47 (47 CFR) Paragraph 15.247 and Industry Canada RSS-GEN, Issue 4 and RSS-247 Issue 2, operation in the 2400 – 2483.5 MHz band.

Name of Applicant: Garmin International, Inc.
1200 East 151st Street
Olathe, KS 66062

M/N: A03363

FCC ID: IPH-03363 Industry Canada ID: 1792A-03363

Frequency Range: 2402-2480 MHz and 2412-2462 MHz

Power and OBW: 802.11b/g/n (Wi-Fi) mode, 802.11b Peak output power 0.025W,
802.11g 0.020 W, 802.11n 0.020 W, (99% Occupied bandwidth 802.11b –
15,870 kHz, 802.11g – 16,720 kHz, 802.11n – 17,520 kHz)

Opinion / Interpretation of Results

Tests Performed	Margin (dB)	Results
Emissions 15.205, RSS-GEN	-16.8	Complies
Emissions as per 47 CFR paragraphs 2 and 15.207	N/A	Complies
Emissions as per 47 CFR paragraphs 2 and 15.209	-1.3	Complies
Harmonic Emissions per 47 CFR 15.247	-13.9	Complies
Power Spectral Density per 47 CFR 15.247	-12.9	Complies

Equipment Tested

<u>Equipment</u>	<u>Model / PN</u>	<u>Serial Number</u>	<u>FCC Identifier</u>	<u>IC Identifier</u>
EUT	A03363	5FK000182	IPH-03363	1792A-03363
EUT#2	A03363	5FK000158	IPH-03363	1792A-03363

Test results in this report relate only to the items tested

Equipment Function and Configuration

The EUT is a mobile mounted video system incorporating transmitter with operation capability in the 2402-2480 MHz frequency band. The design provides ability to view video on compatible equipment. The design incorporates two transmitters operating in one of two modes providing wireless interface capabilities. The design provides Digital Transmission System operation in a reduced frequency band of 2412-2462 MHz at approximately 13-dBm power. The other transmitter operates in a low power state across the 2402-2480 MHz frequency band. The product operates from replaceable AA batteries only and offers no provision for alternate power source. The design utilizes internal fixed antenna system and offers no provision for antenna replacement or modification. Two samples were provided for testing, one representative of production case design and the other modified for testing purposes replacing integral antenna with RF connection port. The samples were provided with test software providing testing personnel ability to enable transmitter function on defined channels and operational modes. The antenna modification offered testing facility ability to connect test equipment to the temporary antenna port for antenna port conducted emission testing. The EUT was arranged as described by the manufacturer for testing purposes. The EUT offers no other interface connections than those in the configuration options shown below as described by the manufacturer. For testing purposes, the EUT received power from new AA Batteries and configured to operate in available modes. As requested by the manufacturer and required by regulations, the equipment was tested for emissions compliance using the available configurations with the worst-case data presented. Test results in this report relate only to the products described in this report.

Equipment Configuration

- 1) Unit operating off 2 AA batteries mounted to NA Mount (GPN: 011-04517-00)

Unit under Test	NA Mount 010-12669-00
-----------------	--------------------------

- 2) Unit operating off 2 AA batteries mounted to EU Mount (GPN: 011-04517-10)

Unit under Test	NA Mount 010-12669-10
-----------------	--------------------------

Application for Certification

- (1) Manufacturer: Garmin International, Inc.
1200 East 151st Street
Olathe, KS 66062
- (2) Identification: M/N: A03363
FCC ID: IPH-03363 IC: 1792A-03363
- (3) Instruction Book:
Refer to Exhibit for Instruction Manual.
- (4) Description of Circuit Functions:
Refer to Exhibit of Operational Description.
- (5) Block Diagram with Frequencies:
Refer to Exhibit of Operational Description.
- (6) Report of Measurements:
Report of measurements follows in this Report.
- (7) Photographs: Construction, Component Placement, etc.:
Refer to Exhibit for photographs of equipment.
- (8) List of Peripheral Equipment Necessary for operation. The equipment operates from direct current power provided from replaceable batteries only. The EUT offers no other power option or connection ports than those presented in this filing.
- (9) Transition Provisions of 47 CFR 15.37 are not requested.
- (10) Not Applicable. The unit is not a scanning receiver.
- (11) Not Applicable. The EUT does not operate in the 59 – 64 GHz frequency band.
- (12) The equipment is not software defined and this section is not applicable.
- (13) Applications for certification of U-NII devices in the 5.15-5.35 GHz and the 5.47-5.85 GHz bands must include a high-level operational description of the security procedures that control the radio frequency operating parameters and ensure that unauthorized modifications cannot be made. This requirement is not applicable to his DTS device.
- (14) Contain at least one drawing or photograph showing the test set-up for each of the required types of tests applicable to the device for which certification is requested. These drawings or photographs must show enough detail to confirm other information contained in the test report. Any photographs used must be focused originals without glare or dark spots and must clearly show the test configuration used. This information is provided in this report and Test Setup Exhibits provided with the application filing.

Applicable Standards & Test Procedures

The following information is submitted in accordance with the eCFR Federal Communications Code of Federal Regulations, dated August 27, 2018, Part 2, Subpart J, Paragraphs 2.907, 2.911, 2.913, 2.925, 2.926, 2.1031 through 2.1057, and applicable parts of paragraph 15, Part 15C Paragraph 15.247, and Industry Canada RSS-GEN Issue 4, and RSS-247 Issue 2. Test procedures used are the established Methods of Measurement of Radio-Noise Emissions as described in ANSI C63.10-2013. This report documents compliance for the EUT operations in mode 4, 802.11b/g/n (Wi-Fi).

Testing Procedures

AC Line Conducted Emission Test Procedure

The EUT operates solely from direct current power supplied from replaceable internal batteries. Therefore, no AC line conducted emissions testing was required or performed.

Radiated Emission Test Procedure

Radiated emissions testing was performed as required in 47 CFR 15, RSS-247 and specified in ANSI C63.10-2013. The EUT was placed on a rotating 0.9 x 1.2-meter platform, elevated as required above the ground plane at a distance of 3 meters from the FSM antenna. EMI energy was maximized by equipment placement permitting orientation in three orthogonal axes, raising and lowering the FSM antenna, changing the antenna polarization, and by rotating the turntable. Each emission was maximized before data was taken using a spectrum analyzer. The frequency spectrum from 9 kHz to 25,000 MHz was searched for during preliminary investigation. Refer to diagrams one and two showing typical test arrangement and photographs in the test setup exhibits for specific EUT placement during testing.

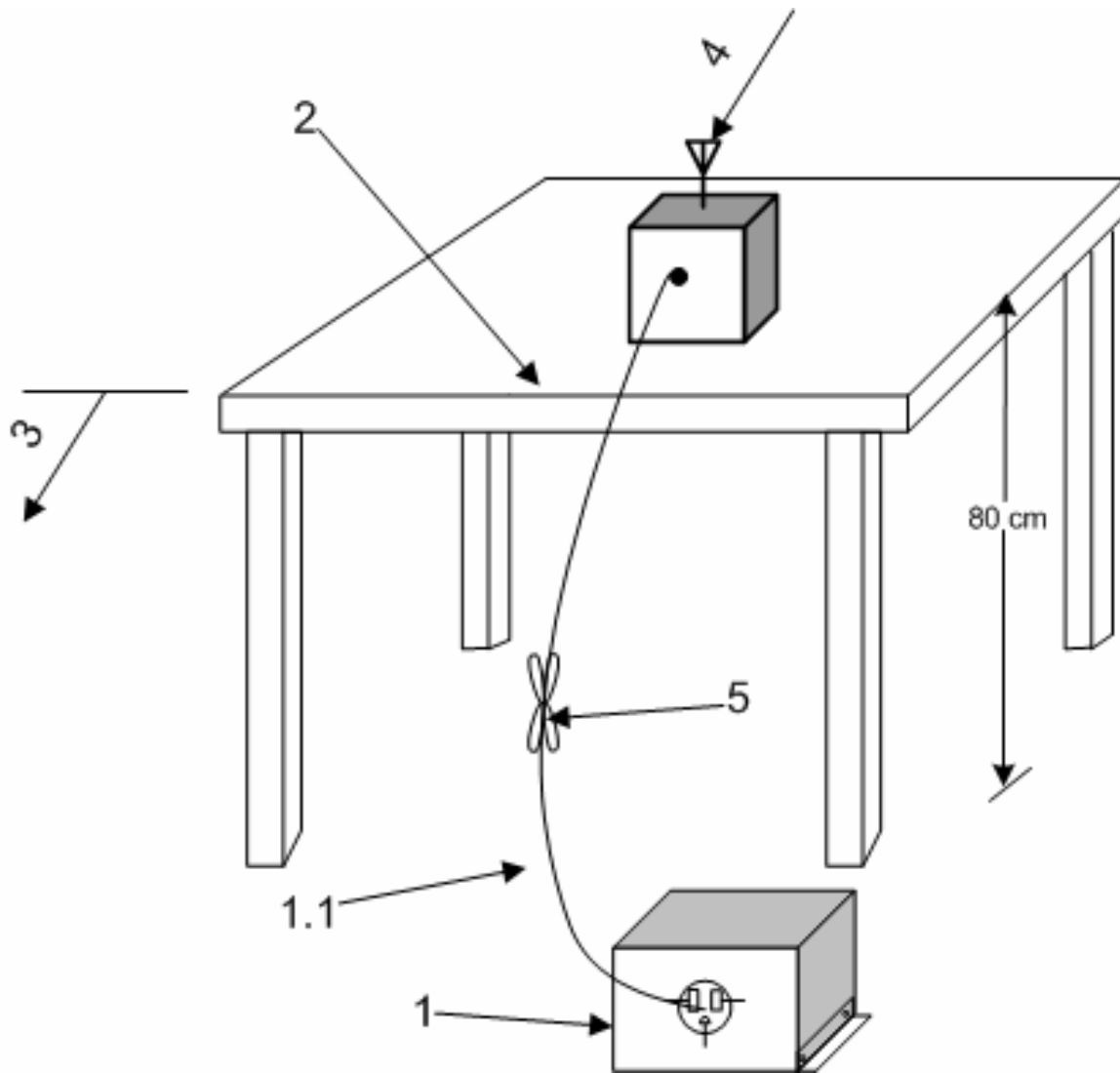

1. A LISN is optional for radiated measurements between 30 MHz to 1000 MHz, but not allowed for measurements below 30 MHz and above 1000 MHz. (See 6.4.3, 6.5.1, and 6.6.3.) If used, connect EUT to one LISN. Unused LISN measuring port connectors shall be terminated in 50Ω. LISN can be placed on top of, or immediately beneath, reference ground plane (see 6.2.2 and 6.2.3.1).
 - 1.1 LISN spaced at least 80 cm from nearest part of EUT chassis.
2. The EUT shall be placed in the center of the table to the extent possible. (See 6.2.3.1 and 6.3.4).
3. A vertical conducting plane, if used for conducted tests per 6.2.2, shall be removed for radiated emission tests.
4. Antenna may be integral or detachable, depending on the EUT.
5. Interconnecting cables that hang closer than 40 cm to the ground plane shall be folded back and forth in the center forming a bundle 30 cm to 40 cm long.

Diagram 1 Test arrangement for radiated emissions of tabletop equipment

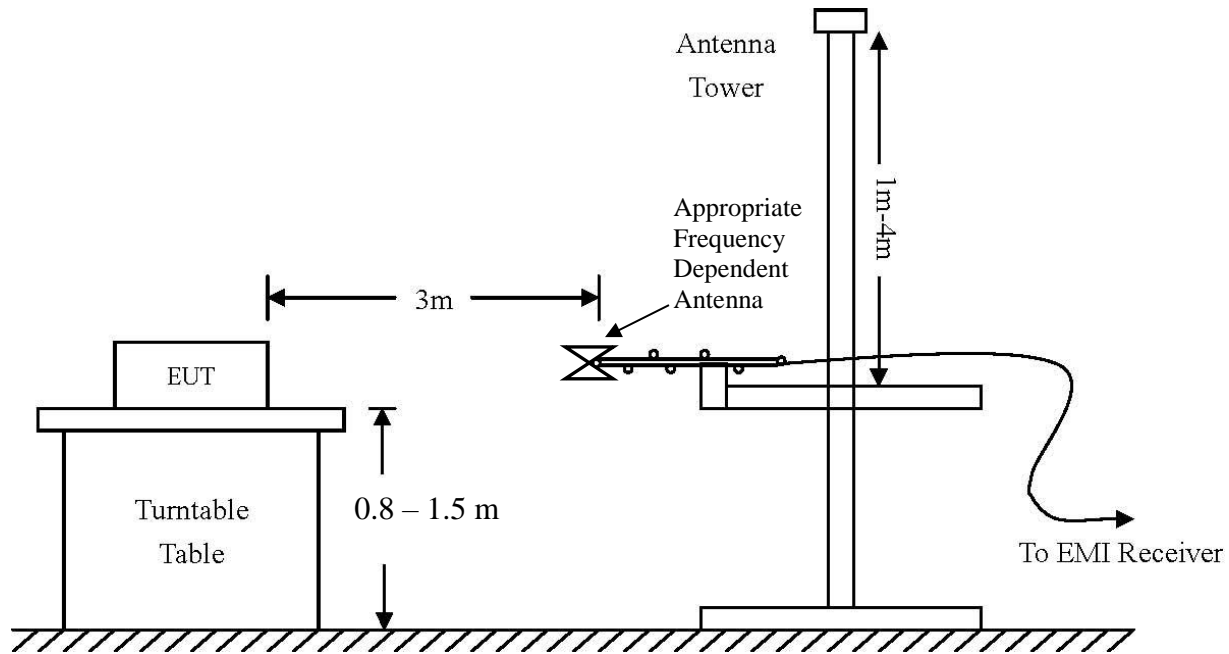

AC Line Conducted Emissions (0.150 -30 MHz)		
RBW	AVG. BW	Detector Function
9 kHz	30 kHz	Peak / Quasi Peak
Emissions (30-1000 MHz)		
RBW	AVG. BW	Detector Function
120 kHz	300 kHz	Peak / Quasi Peak
Emissions (Above 1000 MHz)		
RBW	Video BW	Detector Function
100 kHz	100 kHz	Peak
1 MHz	1 MHz	Peak / Average

Diagram 2 Test arrangement for radiated emissions tested on Open Area Test Site (OATS)

Test Site Locations

Conducted EMI AC power line conducted emissions testing performed in a shielded screen room located at Rogers Labs, Inc., 4405 West 259th Terrace, Louisburg, KS

Radiated EMI The radiated emissions tests were performed at the 3 meters, Open Area Test Site (OATS) located at Rogers Labs, Inc., 4405 West 259th Terrace, Louisburg, KS

Site Registration Refer to Annex for Site Registration Letters

NVLAP Accreditation Lab code 200087-0

Rogers Labs, Inc. 4405 W. 259th Terrace Louisburg, KS 66053 Phone/Fax: (913) 837-3214 Revision 2	Garmin International, Inc. Model: A03363 Test #: 180827 Test to: CFR47 15C, RSS-Gen RSS-247 File: A03363 DTS TstRpt 180827 r2	SN's: 5FK000182 / 5FK000158 FCC ID: IPH-03363 IC: 1792A-03363 Date: September 8, 2018 Page 11 of 32
--	---	---

List of Test Equipment

<u>Equipment</u>	<u>Manufacturer</u>	<u>Model (SN)</u>	<u>Band</u>	<u>Cal Date(m/d/y)</u>	<u>Due</u>
<input type="checkbox"/> LISN	FCC	FCC-LISN-50-2-10(1PA) (160611)	.15-30MHz	5/2/2018	5/2/2019
<input type="checkbox"/> LISN	Compliance Design	FCC-LISN-2.Mod.cd,	.15-30MHz	10/24/2017	10/24/2018
<input checked="" type="checkbox"/> Cable	Huber & Suhner Inc.	Sucoflex102ea(L10M)(303073)	9kHz-40 GHz	10/24/2017	10/24/2018
<input checked="" type="checkbox"/> Cable	Huber & Suhner Inc.	Sucoflex102ea(1.5M)(303069)	9kHz-40 GHz	10/24/2017	10/24/2018
<input type="checkbox"/> Cable	Huber & Suhner Inc.	Sucoflex102ea(1.5M)(303071)	9kHz-40 GHz	10/24/2017	10/24/2018
<input type="checkbox"/> Cable	Belden	RG-58 (L1-CAT3-11509)	9kHz-30 MHz	10/24/2017	10/24/2018
<input type="checkbox"/> Cable	Belden	RG-58 (L2-CAT3-11509)	9kHz-30 MHz	10/24/2017	10/24/2018
<input type="checkbox"/> Antenna	ARA	BCD-235-B (169)	20-350MHz	10/24/2017	10/24/2018
<input type="checkbox"/> Antenna	EMCO	3147 (40582)	200-1000MHz	10/24/2017	10/24/2018
<input checked="" type="checkbox"/> Antenna	ETS-Lindgren	3117 (200389)	1-18 GHz	5/2/2018	5/2/2020
<input type="checkbox"/> Antenna	Com Power	AH-118 (10110)	1-18 GHz	10/24/2017	10/24/2019
<input checked="" type="checkbox"/> Antenna	Com Power	AH-840 (101046)	18-40 GHz	5/15/2017	5/15/2019
<input checked="" type="checkbox"/> Antenna	Com Power	AL-130 (121055)	.001-30 MHz	10/24/2017	10/24/2018
<input checked="" type="checkbox"/> Antenna	Sunol	JB-6 (A100709)	30-1000 MHz	10/24/2017	10/24/2018
<input checked="" type="checkbox"/> Analyzer	Rohde & Schwarz	ESU40 (100108)	20Hz-40GHz	5/2/2018	5/2/2019
<input type="checkbox"/> Analyzer	Rohde & Schwarz	ESW44 (101534)	20Hz-44GHz	12/22/2017	12/22/2018
<input type="checkbox"/> Analyzer	Rohde & Schwarz	FS-Z60, 90, 140, and 220	40GHz-220GHz	12/22/2017	12/22/2019
<input type="checkbox"/> Analyzer	HP	8591EM (3628A00871)	9kHz-1.8GHz	5/2/2018	5/2/2019
<input type="checkbox"/> Analyzer	HP	8562A (3051A05950)	9kHz-125GHz	5/2/2018	5/2/2019
<input type="checkbox"/> Analyzer	HP External Mixers	11571, 11970	25GHz-110GHz	5/2/2018	5/2/2019
<input checked="" type="checkbox"/> Amplifier	Com-Power	PA-010 (171003)	100Hz-30MHz	10/24/2017	10/24/2018
<input checked="" type="checkbox"/> Amplifier	Com-Power	CPPA-102 (01254)	1-1000 MHz	10/24/2017	10/24/2018
<input checked="" type="checkbox"/> Amplifier	Com-Power	PAM-118A (551014)	0.5-18 GHz	10/24/2017	10/24/2018
<input checked="" type="checkbox"/> Power Meter	Agilent	N1911A with N1921A	0.05-40 GHz	5/2/2018	5/2/2019
<input type="checkbox"/> Generator	Rohde & Schwarz	SMB100A6 (100150)	20Hz-6 GHz	5/2/2018	5/2/2019
<input type="checkbox"/> Generator	Rohde & Schwarz	SMBV100A6 (260771)	20Hz-6 GHz	5/2/2018	5/2/2019
<input type="checkbox"/> RF Filter	Micro-Tronics	BRC50722 (009).9G notch	30-1800 MHz	5/2/2018	5/2/2019
<input type="checkbox"/> RF Filter	Micro-Tronics	HPM50114 (017)1.5G HPF	30-18000 MHz	5/2/2018	5/2/2019
<input type="checkbox"/> RF Filter	Micro-Tronics	HPM50117 (063) 3G HPF	30-18000 MHz	5/2/2018	5/2/2019
<input type="checkbox"/> RF Filter	Micro-Tronics	HPM50105 (059) 6G HPF	30-18000 MHz	5/2/2018	5/2/2019
<input checked="" type="checkbox"/> RF Filter	Micro-Tronics	BRM50702 (172) 2G notch	30-1800 MHz	5/2/2018	5/2/2019
<input type="checkbox"/> RF Filter	Micro-Tronics	BRC50703 (G102) 5G notch	30-1800 MHz	5/2/2018	5/2/2019
<input type="checkbox"/> RF Filter	Micro-Tronics	BRC50705 (024) 5G notch	30-1800 MHz	5/2/2018	5/2/2019
<input checked="" type="checkbox"/> Attenuator	Mini-Circuits	VAT-3W2+ (1735)	30-6000 MHz	5/2/2018	5/2/2019
<input type="checkbox"/> Attenuator	Mini-Circuits	VAT-3W2+ (1436)	30-6000 MHz	5/2/2018	5/2/2019
<input type="checkbox"/> Attenuator	Mini-Circuits	VAT-3W2+ (14362)	30-6000 MHz	5/2/2018	5/2/2019
<input type="checkbox"/> Attenuator	Mini-Circuits	VAT-3W2+ (1445)	30-6000 MHz	5/2/2018	5/2/2019
<input type="checkbox"/> Attenuator	Mini-Circuits	VAT-3W2+ (14452)	30-6000 MHz	5/2/2018	5/2/2019
<input type="checkbox"/> Attenuator	Mini-Circuits	VAT-6W2+ (1438)	30-6000 MHz	5/2/2018	5/2/2019
<input type="checkbox"/> Attenuator	Mini-Circuits	VAT-6W2+ (1736)	30-6000 MHz	5/2/2018	5/2/2019
<input checked="" type="checkbox"/> Weather station	Davis	6312 (A70927D44N)		10/24/2017	10/24/2018

Rogers Labs, Inc.
4405 W. 259th Terrace
Louisburg, KS 66053
Phone/Fax: (913) 837-3214
Revision 2

Garmin International, Inc.
Model: A03363
Test #: 180827
Test to: CFR47 15C, RSS-Gen RSS-247
File: A03363 DTS TstRpt 180827 r2

SN's: 5FK000182 / 5FK000158
FCC ID: IPH-03363
IC: 1792A-03363
Date: September 8, 2018
Page 12 of 32

Units of Measurements

Conducted EMI Data is in dB μ V; dB referenced to one microvolt

Radiated EMI Data is in dB μ V/m; dB/m referenced to one microvolt per meter

Sample Calculation:

RFS = Radiated Field Strength, FSM = Field Strength Measured

A.F. = Receive antenna factor, Gain = amplification gains and/or cable losses

RFS (dB μ V/m @ 3m) = FSM (dB μ V) + A.F. (dB) - Gain (dB)

Environmental Conditions

Ambient Temperature 21.4° C

Relative Humidity 46%

Atmospheric Pressure 1009.2 mb

Statement of Modifications and Deviations

No modifications to the EUT were required for the unit to demonstrate compliance with the 47 CFR Part 15C, RSS-Gen, and RSS-247 emission requirements. There were no deviations to the specifications.

Intentional Radiators

The following information is submitted in support demonstration of compliance with the requirements of 47 CFR, Subpart C, paragraph 15.247 and Industry Canada RSS-247 and RSS-Gen the following information is submitted.

Antenna Requirements

The EUT incorporates integral antenna system and offers no provision for connection to alternate antenna system. The antenna connection point complies with the unique antenna connection requirements. There are no deviations or exceptions to the specification.

Restricted Bands of Operation

Spurious emissions falling in the restricted frequency bands of operation were measured at the OATS. The EUT utilizes frequency, determining circuitry, which generates harmonics falling in the restricted bands. Emissions were investigated at the OATS, using appropriate antennas or pyramidal horns, amplification stages, and a spectrum analyzer. Peak and average amplitudes of frequencies above 1000 MHz were compared to the required limits with worst-case data presented below. Test procedures of ANSI C63.10-2013 were used during testing. No other significant emission was observed which fell into the restricted bands of operation. Computed emission values consider the received radiated field strength, receive antenna correction factor, amplifier gain stage, and test system cable losses.

Table 1 Harmonic Radiated Emissions in Restricted Bands Data (802.11, Worst-case)

Frequency in MHz	Horizontal Peak (dB μ V/m)	Horizontal Quasi-Peak (dB μ V/m)	Horizontal Average (dB μ V/m)	Vertical Peak (dB μ V/m)	Vertical Quasi-Peak (dB μ V/m)	Vertical Average (dB μ V/m)	Limit @ 3m (dB μ V/m)
2390.0	72.7	N/A	35.1	60.4	N/A	30.1	54.0
2483.5	73.3	N/A	36.2	64.0	N/A	30.7	54.0
4824.0	44.8	N/A	31.8	44.6	N/A	32.8	54.0
4884.0	44.4	N/A	31.3	45.0	N/A	31.7	54.0
4924.0	45.1	N/A	32.4	44.4	N/A	31.3	54.0
7236.0	47.1	N/A	34.2	44.4	N/A	32.7	54.0
7326.0	46.3	N/A	33.1	45.1	N/A	32.4	54.0
7386.0	46.4	N/A	33.4	46.5	N/A	33.3	54.0
12060.0	49.8	N/A	37.1	46.8	N/A	37.2	54.0
12210.0	47.9	N/A	35.0	49.1	N/A	36.2	54.0
12310.0	48.1	N/A	35.6	48.4	N/A	35.8	54.0

Other emissions present had amplitudes at least 20 dB below the limit. Peak and Quasi-Peak amplitude emissions are recorded for frequency below 1000 MHz. Peak and Average amplitude emissions are recorded for frequency range above 1000 MHz.

Summary of Results for Radiated Emissions in Restricted Bands

The EUT demonstrated compliance with the radiated emissions requirements of 47 CFR Part 15C RSS-Gen, and RSS-247 Intentional Radiators. The EUT worst-case 802.11 mode 4 demonstrated a minimum radiated emission margin of -16.8 dB below the requirements in restricted frequency bands. Peak, Quasi-peak, and average amplitudes were checked for compliance with the regulations. Worst-case emissions are reported with other emissions found in the restricted frequency bands at least 20 dB below the requirements.

General Radiated Emissions Procedure

The EUT was arranged in a typical equipment configuration and operated through all available mode during testing. Preliminary testing was performed in a screen room with the EUT positioned 1 meter from the FSM. Radiated emissions measurements were performed to identify the frequencies, which produced the highest emissions. Each radiated emission was then maximized at the OATS location before final radiated measurements were performed. Final data was taken with the EUT located on the OATS at 3 meters distance between the EUT and the receiving antenna. The frequency spectrum from 9 kHz to 25,000 MHz was searched for general radiated emissions. Measured emission levels were maximized by EUT placement on the table, rotating the turntable through 360 degrees, varying the antenna height between 1 and 4 meters above the ground plane and changing antenna position between horizontal and vertical polarization. Antennas used were Loop from 9 kHz to 30 MHz, Broadband Biconical from 30 to 200 MHz, Biconilog from 30 to 1000 MHz, Log Periodic from 200 MHz to 1 GHz and or double Ridge or pyramidal horns and mixers above 1 GHz, notch filters and appropriate amplifiers and external mixers were utilized.

Table 2 General Radiated Emissions Data

Frequency in MHz	Horizontal Peak (dBµV/m)	Horizontal Quasi-Peak (dBµV/m)	Horizontal Average (dBµV/m)	Vertical Peak (dBµV/m)	Vertical Quasi-Peak (dBµV/m)	Vertical Average (dBµV/m)	Limit @ 3m (dBµV/m)
65.5	31.6	22.7	N/A	32.5	21.3	N/A	40.0
80.0	37.1	27.2	N/A	32.5	25.2	N/A	40.0
100.0	32.2	30.3	N/A	28.3	23.7	N/A	40.0
160.0	38.2	21.2	29.1	23.8	17.4	N/A	40.0
192.1	30.8	26.6	36.6	18.5	14.4	N/A	40.0
209.0	19.8	11.3	30.5	16.6	11.1	N/A	40.0
600.0	47.3	45.7	35.5	34.1	31.3	N/A	47.0
648.0	41.0	38.8	31.8	32.2	28.0	N/A	47.0
696.0	38.2	36.5	N/A	29.4	25.8	N/A	47.0
1232.9	49.3	N/A	36.5	49.5	N/A	36.6	54.0
3779.5	45.3	N/A	35.0	45.4	N/A	34.5	54.0
4139.9	47.1	N/A	35.9	45.0	N/A	33.4	54.0

Other emissions present had amplitudes at least 20 dB below the limit. Peak and Quasi-Peak amplitude emissions are recorded for frequency range below 1000 MHz. Peak and Average amplitude emissions are recorded for frequency range above 1000 MHz.

Summary of Results for General Radiated Emissions

The EUT demonstrated compliance with the radiated emissions requirements of 47 CFR Part 15C paragraph 15.209, RSS-247 and RSS-GEN Intentional Radiators. The EUT demonstrated a minimum margin of -1.3 dB below the requirements. Other emissions were present with amplitudes at least 20 dB below the Limits.

Operation in the Band 2400 – 2483.5 MHz

Test procedures of ANSI C63.10-2013 paragraph 6, and KDB 558074 v04 were used during transmitter testing. Test sample #2 was provided for testing antenna port conducted emissions. This sample was modified by replacing the internal antenna with a 50-ohm antenna port connector and attenuator for testing purposes. The transmitter peak and average power was measured at the antenna port using a wideband RF power meter as described in KDB 558074 (9.1.3) and (9.2.3). The peak Power Spectral Density (PKPSD) was measured as defined in KDB 558074 (10.2). DTS Emission bandwidth was measured as described in KDB 558074 paragraph 8, and C63.10-2013. The amplitude of each harmonic and general radiated emission was measured on the OATS at distance of 3 meters from the FSM antenna (radiated emission testing was performed on sample #1 representative of production equipment with integral antenna). The EUT was positioned on supporting turntable elevated as required above the ground plane, at a distance of 3 meters from the FSM antenna. Radiated emission investigations were performed from 9 kHz to 25,000 MHz. Each radiated emission was maximized by varying the FSM antenna height and polarization, and by rotating the turntable. The worst-case amplitude of each emission was then recorded from the analyzer display. The peak and quasi-peak amplitude of frequencies below 1000 MHz were measured using a spectrum analyzer. The peak and average amplitude of frequencies above 1000 MHz were measured using a spectrum analyzer. A Loop antenna was used for measuring emissions from 0.009 to 30 MHz, Biconilog Antenna for 30 to 1000 MHz, Double-Ridge, and/or Pyramidal Horn Antennas from 1 GHz to 25 GHz. Radiated Emissions were measured in dB μ V/m @ 3 meters. Plots were taken of transmitter performance (using sample #2) for reference in this and other documentation.

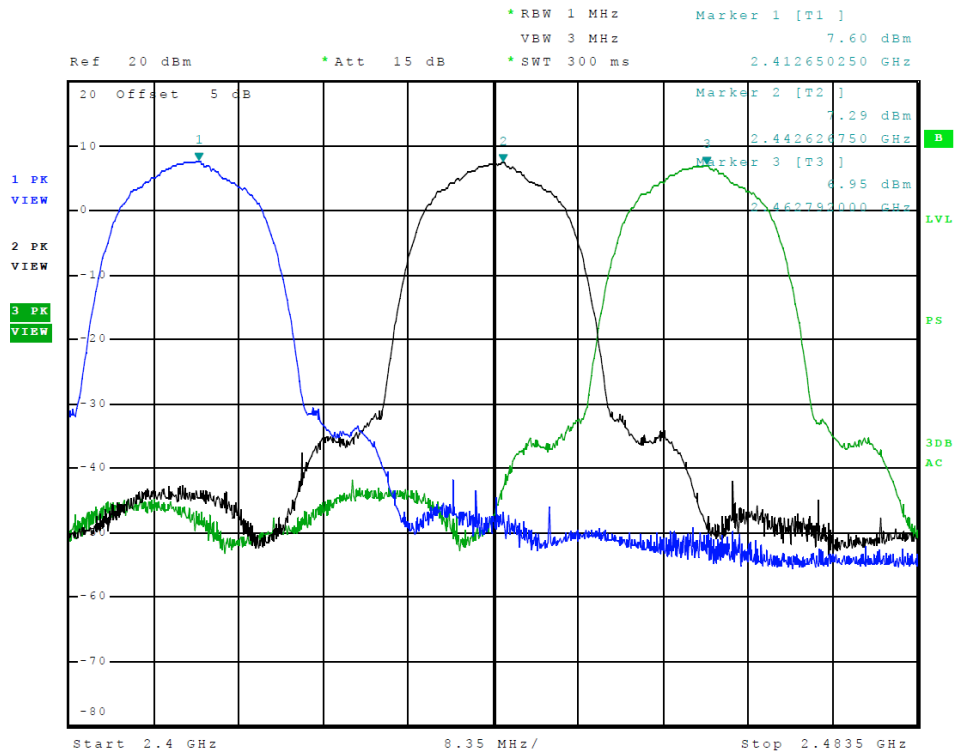

Figure 1 Plot of Transmitter Emissions in Operational Frequency (802.11 b-Mode)

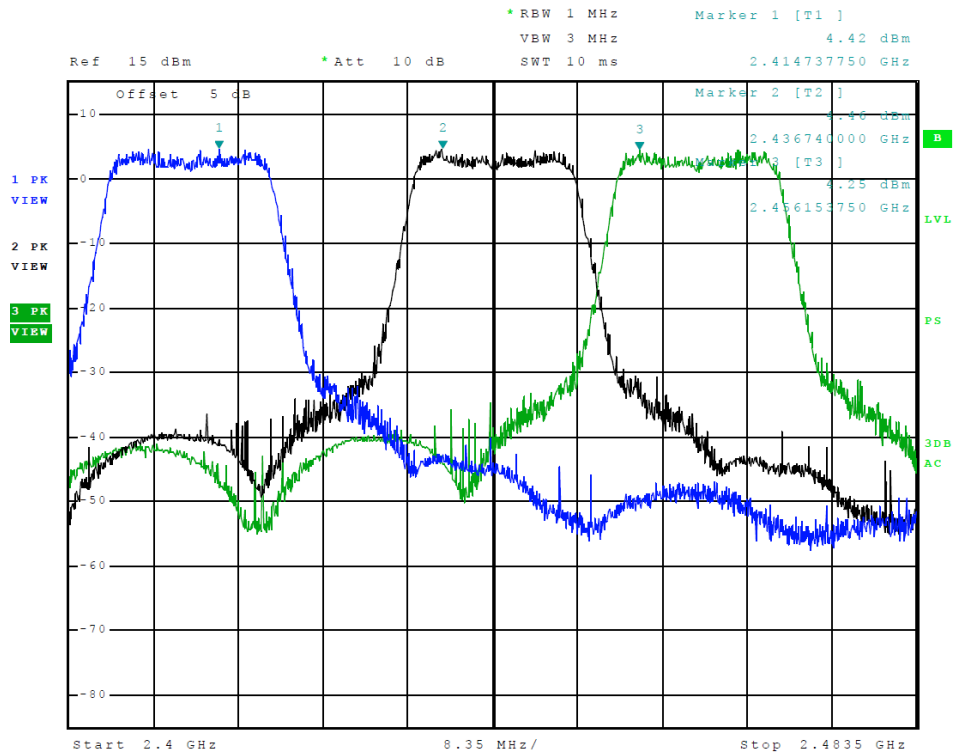

Figure 2 Plot of Transmitter Emissions in Operational Frequency (802.11 g-Mode)

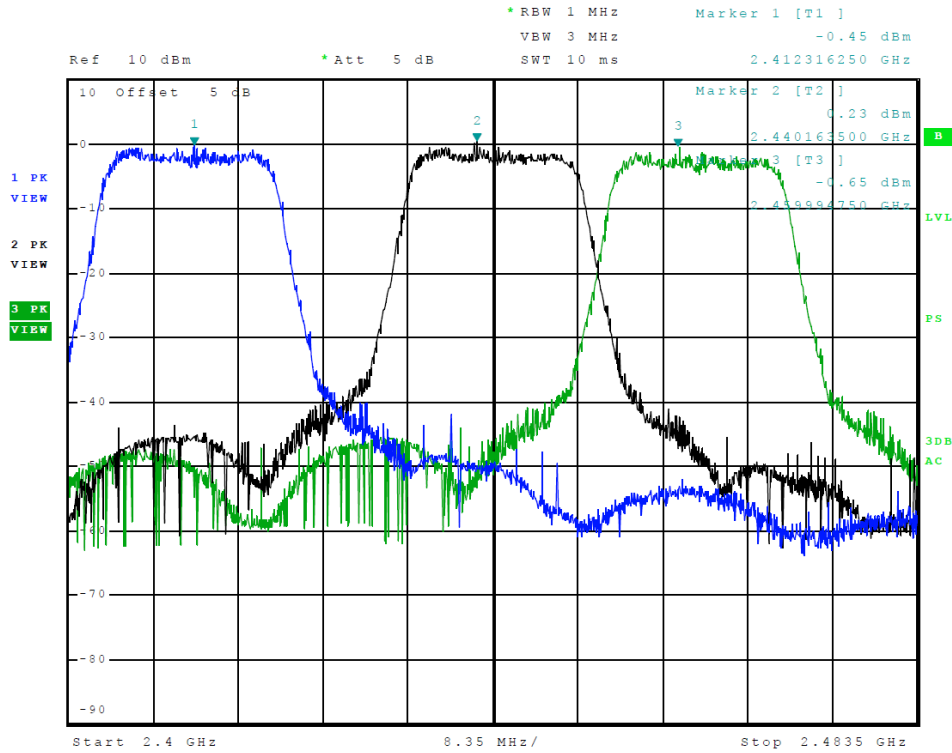

Figure 3 Plot of Transmitter Emissions in Operational Frequency (802.11 n-Mode)

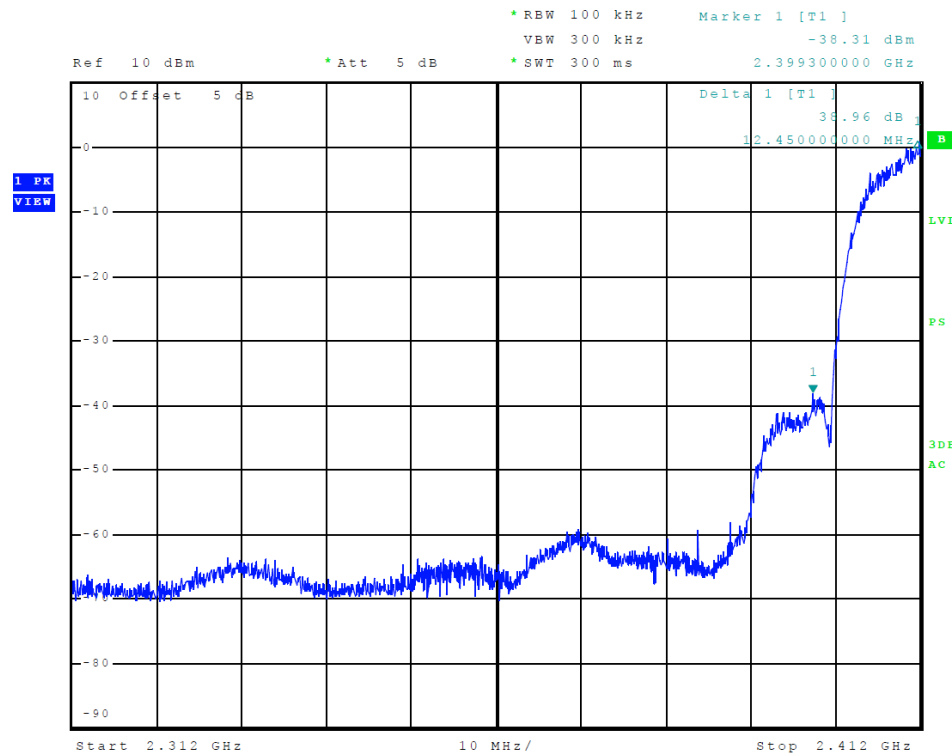

Figure 4 Plot of Lower Band Edge (802.11 b-mode)

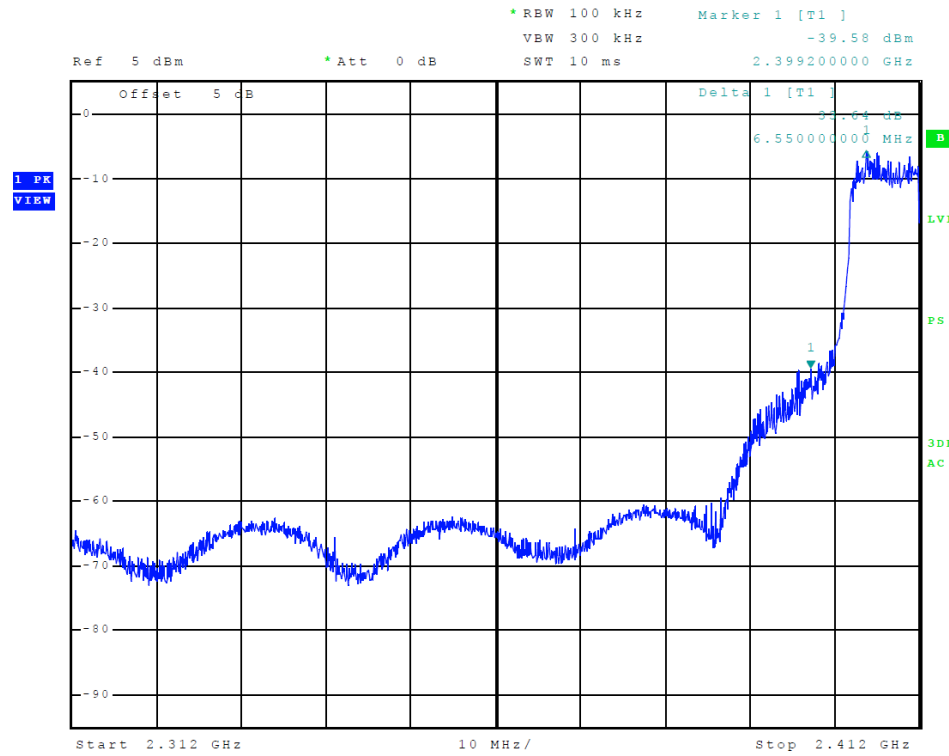

Figure 5 Plot of Lower Band Edge (802.11 g-mode)

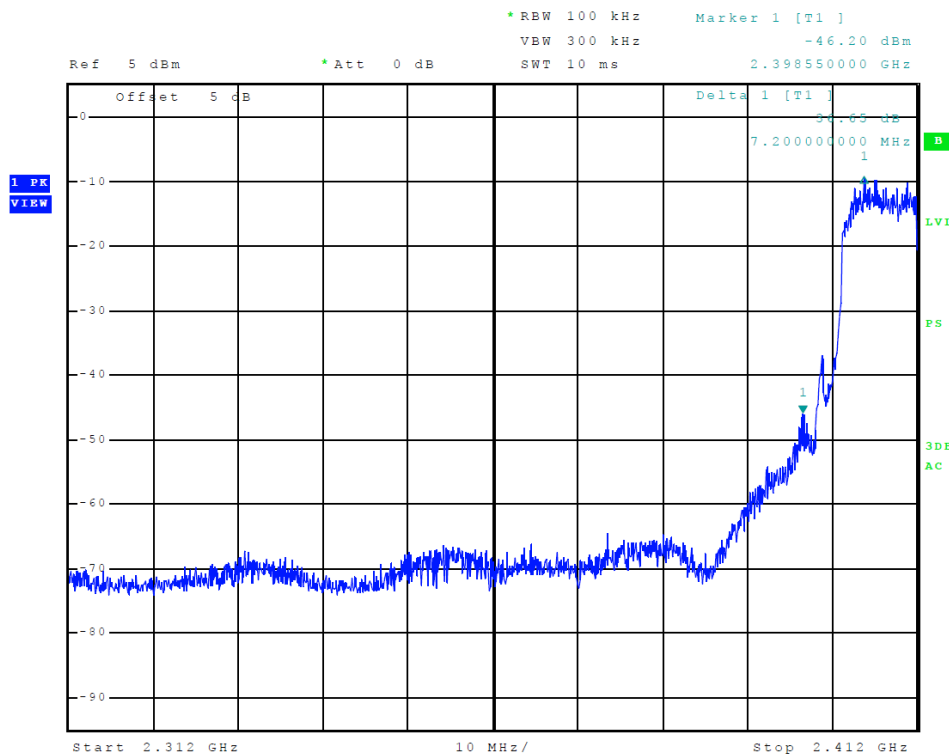

Figure 6 Plot of Lower Band Edge (802.11 n-mode)

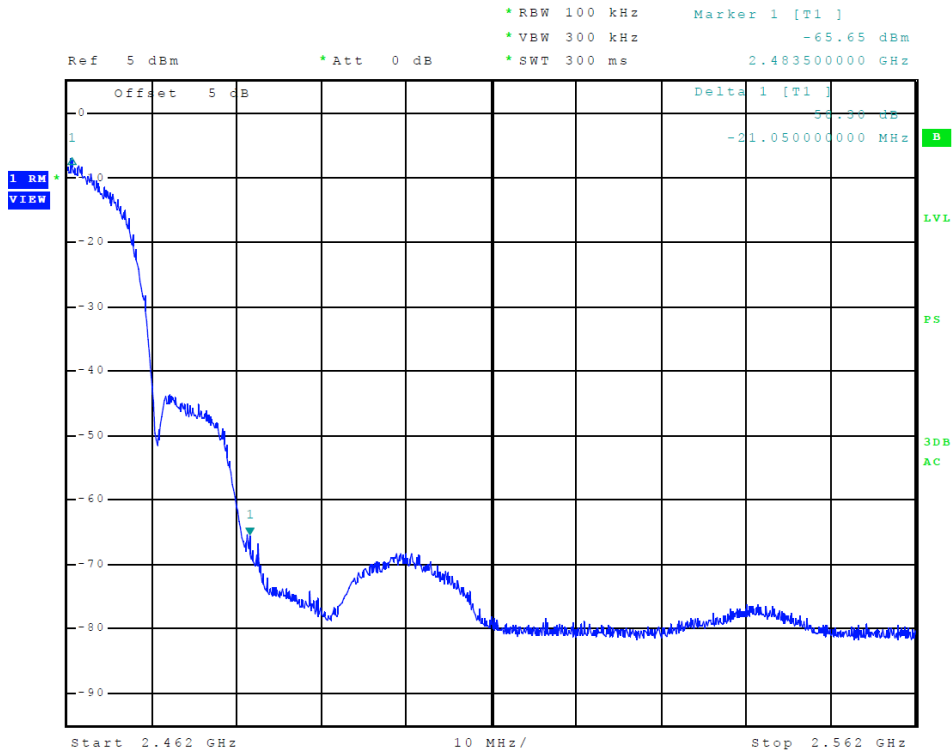

Figure 7 Plot of Upper Band Edge (802.11 b-mode)

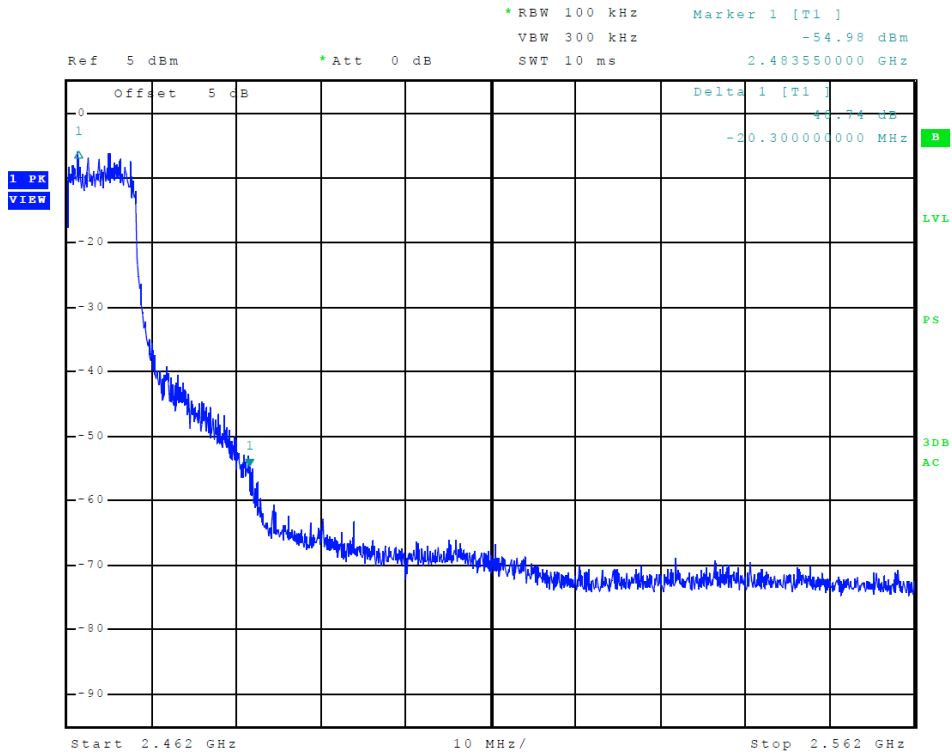

Figure 8 Plot of Upper Band Edge (802.11 g-mode)

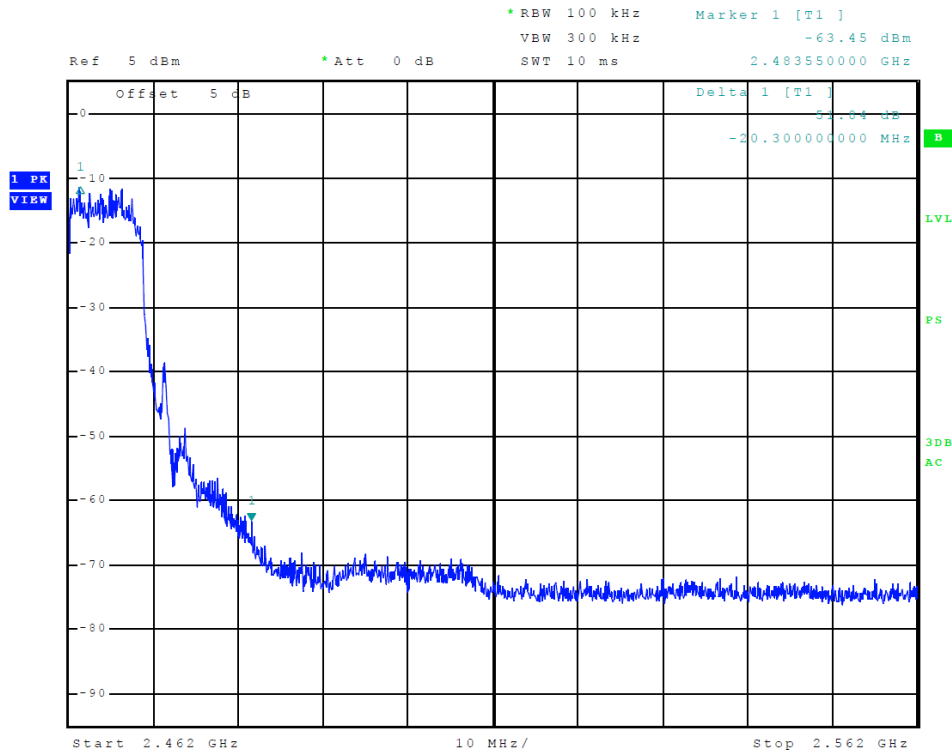

Figure 9 Plot of Upper Band Edge (802.11 n-mode)

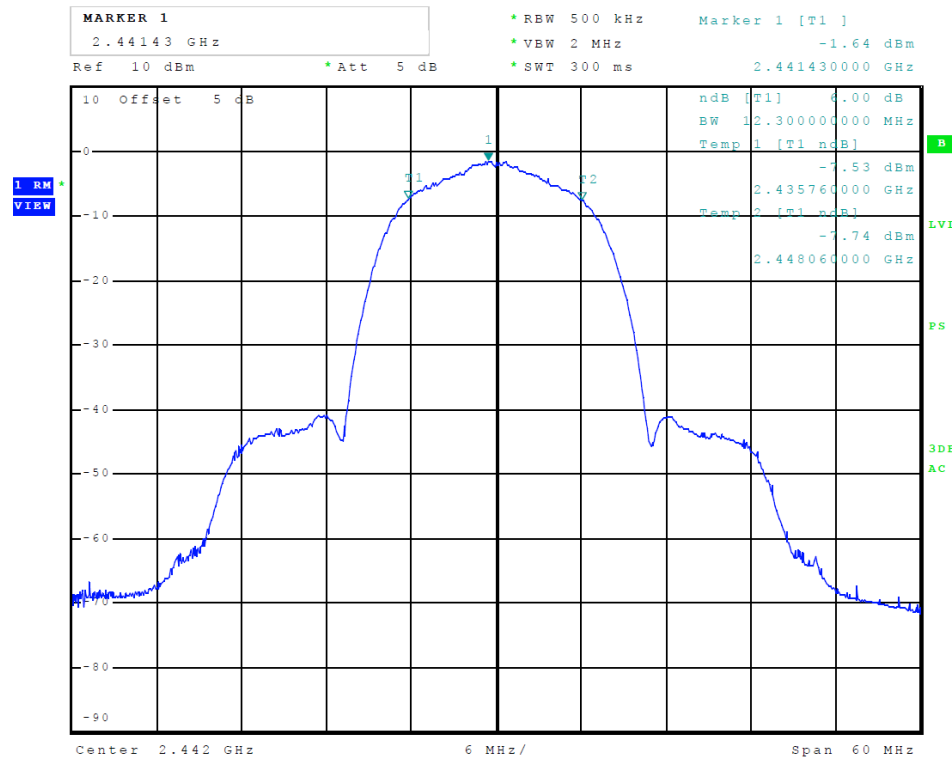

Figure 10 Plot of Transmitter 6-dB Occupied Bandwidth (802.11 b-mode)

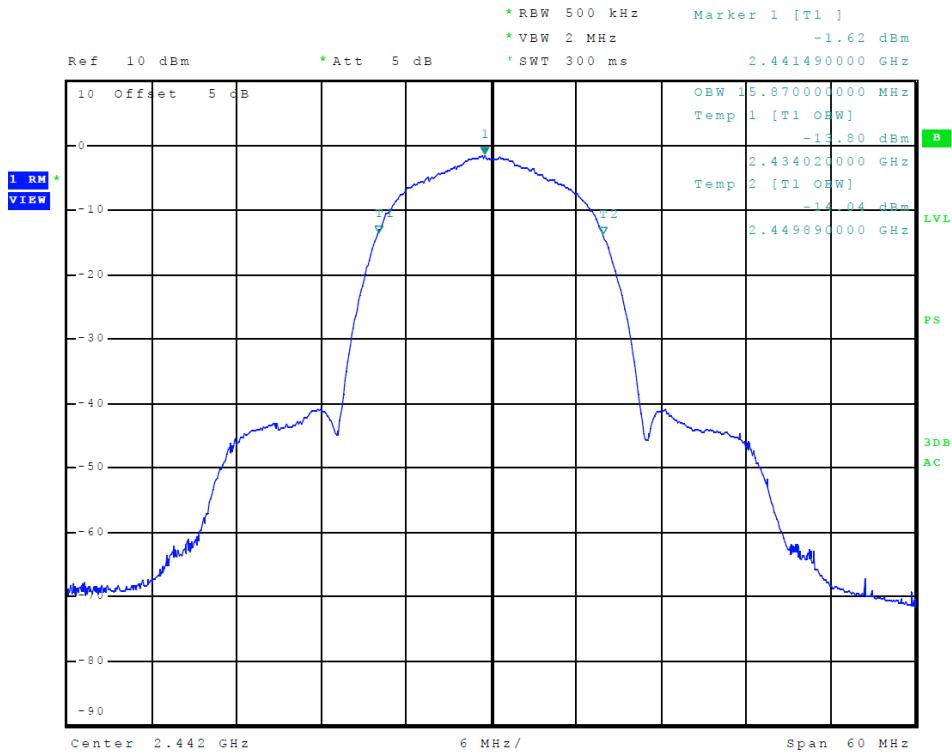

Figure 11 Plot of Transmitter 99% Occupied Bandwidth (802.11 b-mode)

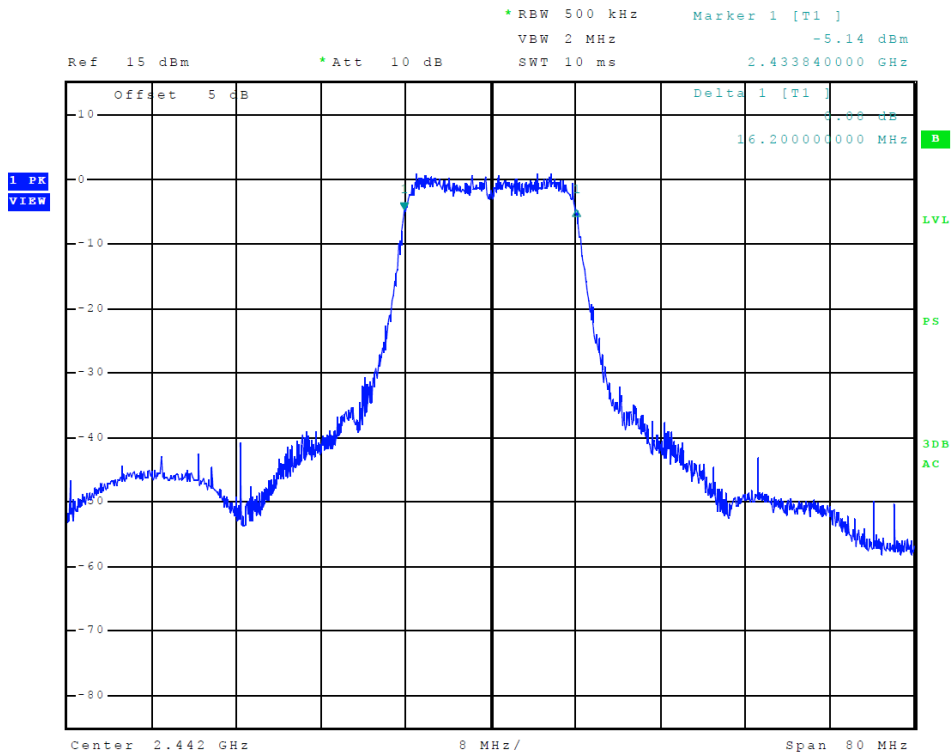

Figure 12 Plot of Transmitter 6-dB Occupied Bandwidth (802.11 g-mode)

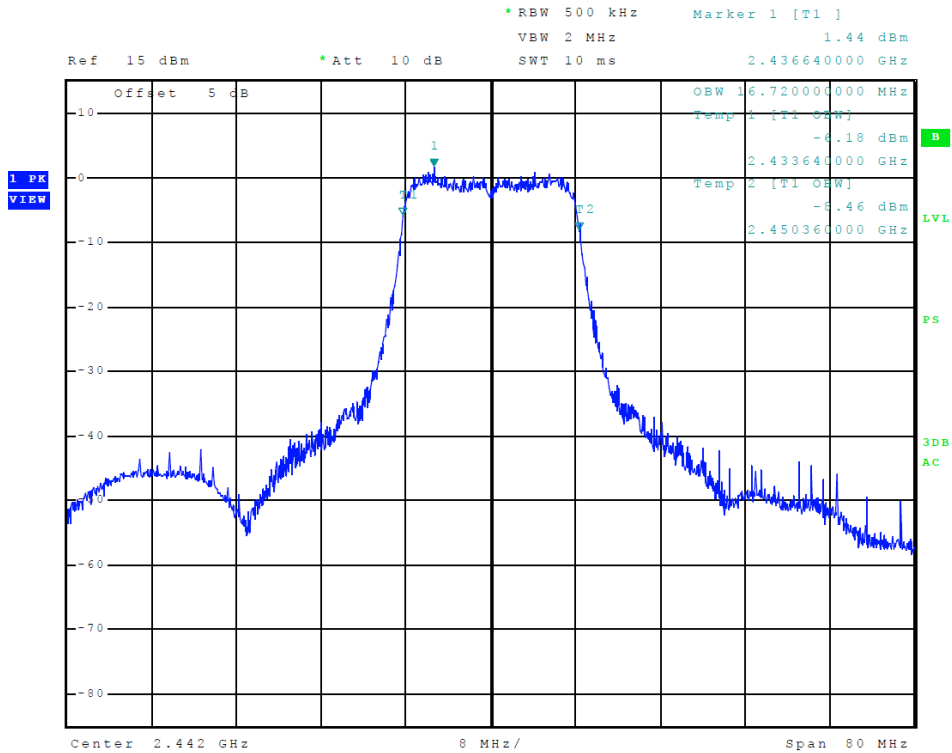

Figure 13 Plot of Transmitter 99% Occupied Bandwidth (802.11 g-mode)

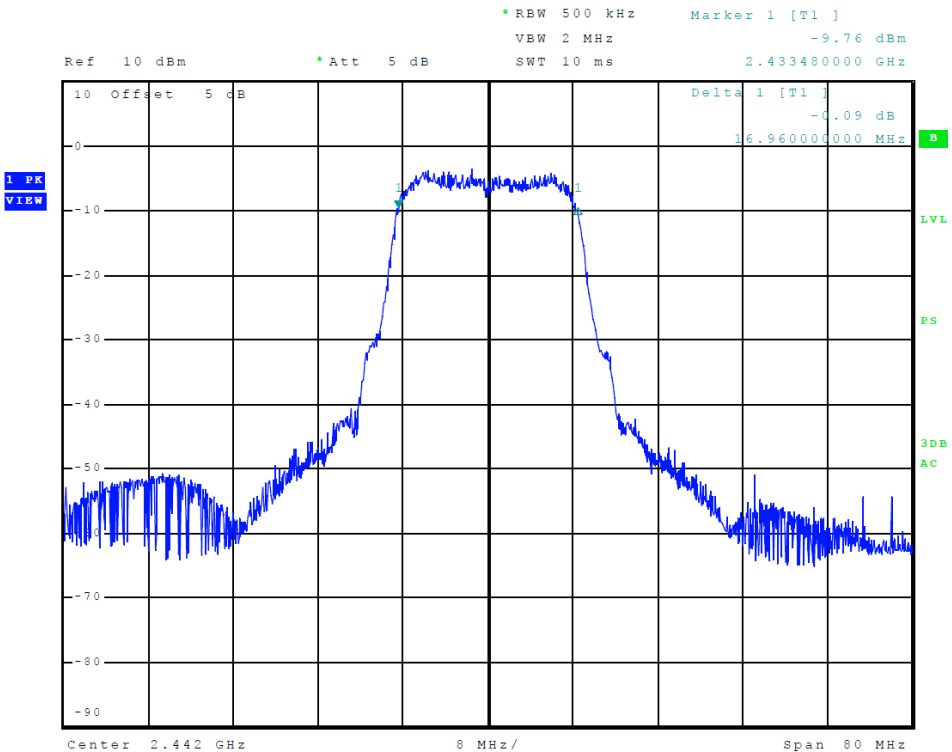

Figure 14 Plot of Transmitter 6-dB Occupied Bandwidth (802.11 n-mode)

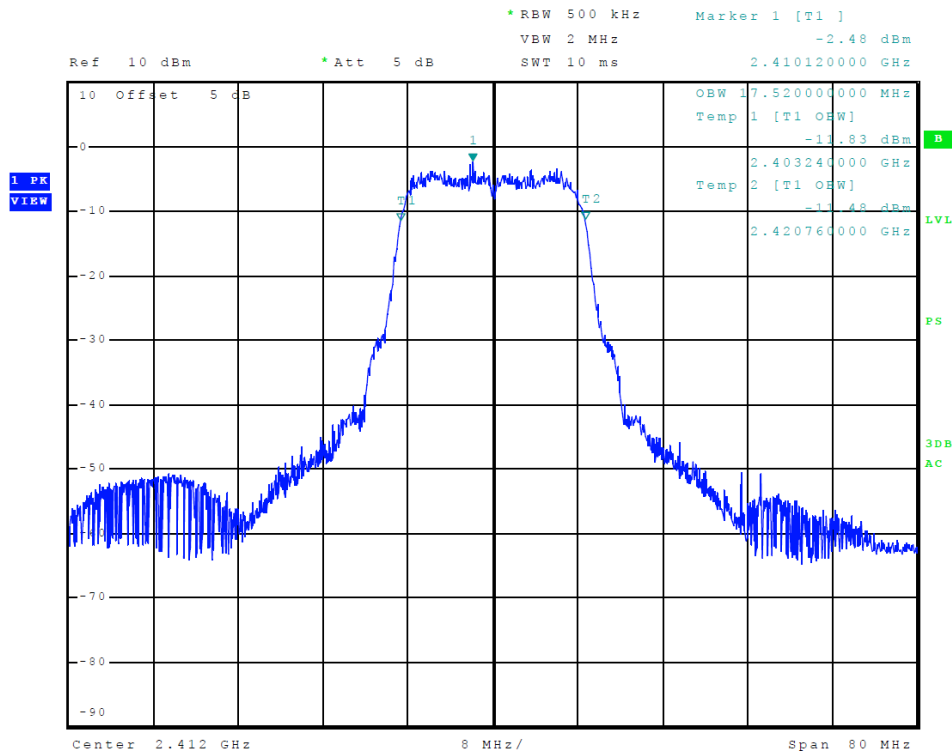

Figure 15 Plot of Transmitter 99% Occupied Bandwidth (802.11 n-mode)

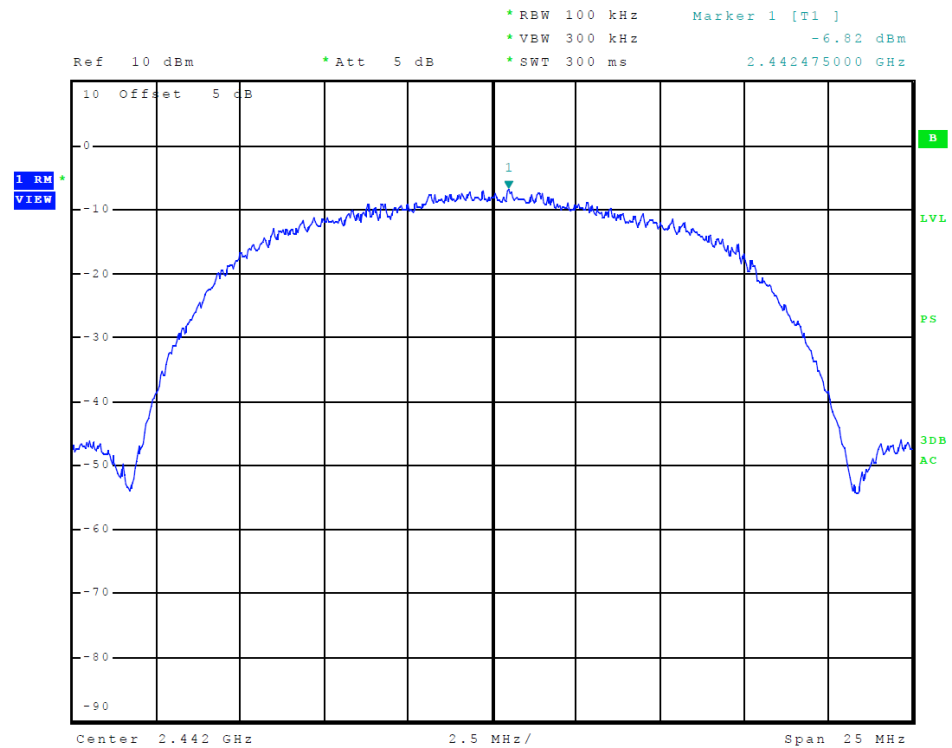

Figure 16 Plot of Transmitter Power Spectral Density (802.11 b-mode)

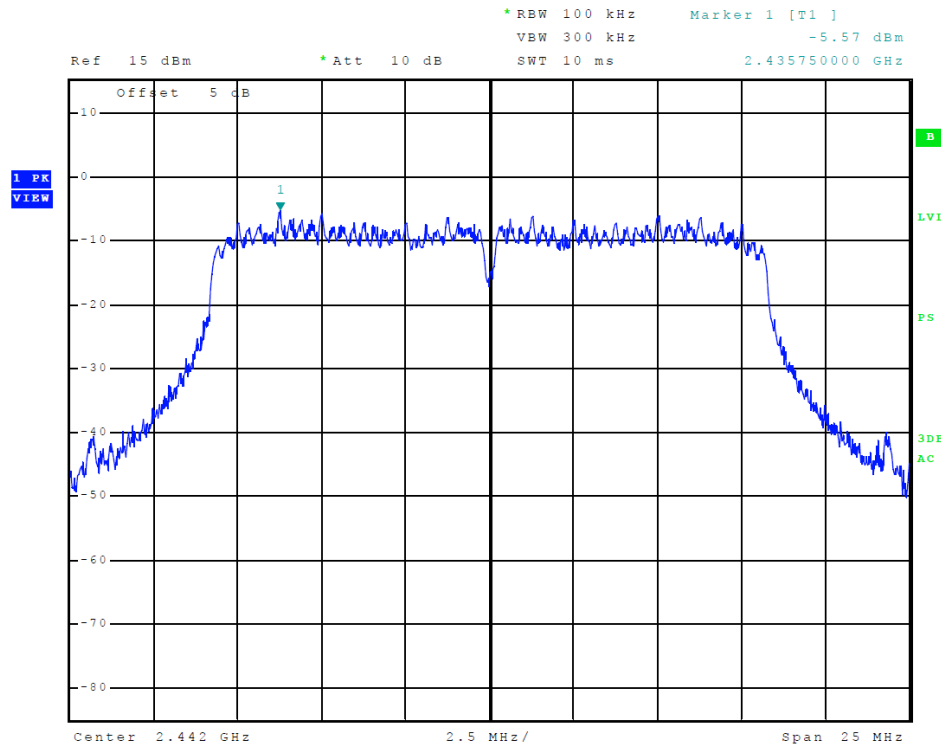

Figure 17 Plot of Transmitter Power Spectral Density (802.11 g-mode)

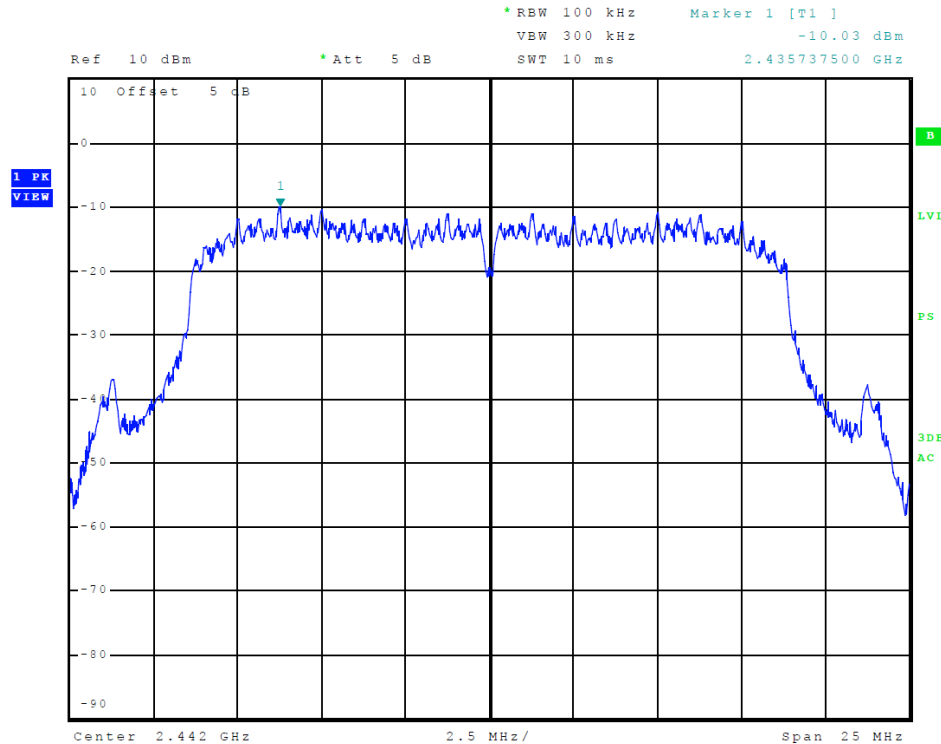

Figure 18 Plot of Transmitter Power Spectral Density (802.11 n-mode)

Transmitter Emissions Data

Table 3 Transmitter Radiated Emission Worst-case Data

Frequency in MHz	Horizontal Peak (dBµV/m)	Horizontal Average (dBµV/m)	Vertical Peak (dBµV/m)	Vertical Average (dBµV/m)	Limit @ 3m (dBµV/m)
2412.0	--	--	--	--	--
4824.0	44.8	31.8	44.6	32.8	54.0
7236.0	47.1	34.2	44.4	32.7	54.0
9648.0	47.4	34.2	47.3	34.0	54.0
12060.0	19.8	37.1	46.8	37.2	54.0
14472.0	49.9	36.6	49.3	36.6	54.0
16884.0	52.2	39.2	52.3	39.4	54.0
2442.0	--	--	--	--	--
4884.0	44.4	31.3	45.0	31.7	54.0
7326.0	46.3	33.1	45.1	32.4	54.0
9768.0	46.6	33.5	47.0	34.1	54.0
12210.0	47.9	35.0	49.1	36.2	54.0
14652.0	49.1	36.2	49.8	36.5	54.0
17094.0	53.1	40.1	54.1	40.1	54.0
2462.0	--	--	--	--	--
4924.0	45.1	32.4	44.4	31.3	54.0
7386.0	46.4	33.4	46.5	33.3	54.0
9848.0	46.7	33.9	46.9	34.2	54.0
12310.0	48.1	35.6	48.4	35.8	54.0
14772.0	50.1	37.7	50.2	37.8	54.0
17234.0	51.7	38.9	51.1	38.2	54.0

Other emissions present had amplitudes at least 20 dB below the limit. Peak and Quasi-Peak amplitude emissions are recorded for frequency below 1000 MHz. Peak and Average amplitude emissions are recorded for frequency range above 1000 MHz.

Table 4 Transmitter Antenna Port Data

Frequency MHz	Antenna Port Output Peak / Average (Watts)	99% Occupied Bandwidth (kHz)	6-dB Occupied Bandwidth (kHz)	Peak Power Spectral Density (dBm)
802.11b				
2412	0.025 / 0.019	15,840	12,450	-6.27
2442	0.024 / 0.011	15,870	12,300	-6.82
2462	0.024 / 0.013	15,840	12,150	-7.27
802.11g				
2412	0.020 / 0.014	16,640	16,280	-4.96
2442	0.018 / 0.007	16,720	16,200	-5.57
2462	0.018 / 0.009	16,720	16,240	-5.78
802.11n				
2412	0.020 / 0.013	17,520	16,320	-8.98
2442	0.018 / 0.009	17,520	16,960	-10.03
2462	0.018 / 0.009	17,480	16,680	-10.8

Summary of Results for Transmitter Radiated Emissions of Intentional Radiator

The EUT demonstrated compliance with the radiated and conducted emission requirements of 47CFR Part 15.247, RSS-GEN, and RSS-247 Digital Transmission Systems. Peak Output power of 0.025 Watts was measured at the antenna port and average output power of 0.019 Watts. The peak power spectral density measured at the antenna port presented a minimum margin of -12.9 dB below the requirements. The EUT demonstrated a minimum margin of -13.9 dB below the harmonic emissions requirements. There were no other significantly measurable emissions in the restricted bands other than those recorded in this report. Other emissions were present with amplitudes at least 20 dB below the requirements. There were no other deviations or exceptions to the requirements.

Annex

- Annex A Measurement Uncertainty Calculations
- Annex B Rogers Qualifications
- Annex C Rogers Labs Certificate of Accreditation

Annex A Measurement Uncertainty Calculations

The measurement uncertainty was calculated for all measurements listed in this test report according to CISPR 16-4. Result of measurement uncertainty calculations are recorded below. Component and process variability of production devices similar to those tested may result in additional deviations. The manufacturer has the sole responsibility of continued compliance.

Measurement	Expanded Measurement Uncertainty $U_{(lab)}$
3 Meter Horizontal 0.009-1000 MHz Measurements	4.16
3 Meter Vertical 0.009-1000 MHz Measurements	4.33
3 Meter Measurements 1-18 GHz	5.14
3 Meter Measurements 18-40 GHz	5.16
10 Meter Horizontal Measurements 0.009-1000 MHz	4.15
10 Meter Vertical Measurements 0.009-1000 MHz	4.32
AC Line Conducted	1.75
Antenna Port Conducted power	1.17
Frequency Stability	1.00E-11
Temperature	1.6°C
Humidity	3%

Annex B Rogers Qualifications

Scot D. Rogers, Engineer

Rogers Labs, Inc.

Mr. Rogers has approximately 27 years' experience in the field of electronics. Engineering experience includes six years in the automated controls industry and remaining years working with the design, development and testing of radio communications and electronic equipment.

Positions Held

Systems Engineer: A/C Controls Mfg. Co., Inc. 6 Years

Electrical Engineer: Rogers Consulting Labs, Inc. 5 Years

Electrical Engineer: Rogers Labs, Inc. Current

Educational Background

- 1) Bachelor of Science Degree in Electrical Engineering from Kansas State University.
- 2) Bachelor of Science Degree in Business Administration Kansas State University.
- 3) Several Specialized Training courses and seminars pertaining to Microprocessors and Software programming.

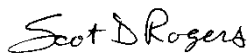

Scot D. Rogers

Annex C Rogers Labs Certificate of Accreditation

United States Department of Commerce
National Institute of Standards and Technology

NVLAP®

Certificate of Accreditation to ISO/IEC 17025:2005

NVLAP LAB CODE: 200087-0

Rogers Labs, Inc.
Louisburg, KS

*is accredited by the National Voluntary Laboratory Accreditation Program for specific services,
listed on the Scope of Accreditation, for:*

Electromagnetic Compatibility & Telecommunications

*This laboratory is accredited in accordance with the recognized International Standard ISO/IEC 17025:2005.
This accreditation demonstrates technical competence for a defined scope and the operation of a laboratory quality
management system (refer to joint ISO-ILAC-IAF Communique dated January 2009).*

2018-02-21 through 2019-03-31
Effective Dates



For the National Voluntary Laboratory Accreditation Program

Rogers Labs, Inc.
4405 W. 259th Terrace
Louisburg, KS 66053
Phone/Fax: (913) 837-3214
Revision 2

Garmin International, Inc. SN's: 5FK000182 / 5FK000158
Model: A03363
Test #: 180827
Test to: CFR47 15C, RSS-Gen RSS-247
File: A03363 DTS TstRpt 180827 r2

FCC ID: IPH-03363
IC: 1792A-03363
Date: September 8, 2018
Page 32 of 32