

Application For Grant of Certification

FOR

Model: A03272
2412-2462 MHz (DTS)
Broadband Digital Transmission System
FCC ID: IPH-03272
IC: 1792A-03272

FOR

Garmin International, Inc.

1200 East 151st Street
Olathe, KS 66062

FCC Designation: US5305
IC Test Site Registration: 3041A-1

Test Report Number: 170828 1206

Authorized Signatory: *Scot D Rogers*
Scot D. Rogers

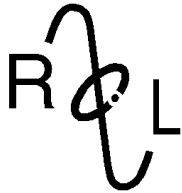

ROGERS LABS, INC.

4405 West 259th Terrace
Louisburg, KS 66053
Phone / Fax (913) 837-3214

Engineering Test Report For Grant of Certification Application

FOR
CFR 47, PART 15C - Intentional Radiators
CFR 47 Paragraph 15.247 and
Industry Canada RSS-GEN and RSS-247
License Exempt Intentional Radiator

For
Garmin International, Inc.

1200 East 151st Street
Olathe, KS 66062

Digital Transmission System
Model: A03272

Frequency Range 2412-2462 MHz
FCC ID: IPH-03272
IC: 1792A-03272

Test Date: December 6, 2017

Certifying Engineer: *Scot D. Rogers*
Scot D. Rogers
Rogers Labs, Inc.
4405 West 259th Terrace
Louisburg, KS 66053
Telephone/Facsimile: (913) 837-3214

This report shall not be reproduced except in full, without the written approval of the laboratory.
This report must not be used by the client to claim product certification, approval, or
endorsement by NVLAP, NIST, or any agency of the Federal Government.

Rogers Labs, Inc.
4405 West 259th Terrace
Louisburg, KS 66053
Phone/Fax: (913) 837-3214
Revision 1

Garmin International, Inc.
Model: A03272
Test #: 170828 1206
Test to: CFR47 15C, RSS-Gen RSS-247
File: A03272 DTS TstRpt 170828 1206

SN's: 3959315045 / 5054
FCC ID: IPH-03272
IC: 1792A-03272
Date: January 12, 2018
Page 2 of 41

Table of Contents

TABLE OF CONTENTS.....	3
REVISIONS.....	5
FOREWORD.....	6
OPINION / INTERPRETATION OF RESULTS	6
EQUIPMENT TESTED.....	6
Equipment Function	7
Equipment Configuration.....	8
APPLICATION FOR CERTIFICATION.....	9
APPLICABLE STANDARDS & TEST PROCEDURES	10
EQUIPMENT TESTING PROCEDURES	10
AC Line Conducted Emission Test Procedure	10
Radiated Emission Test Procedure.....	10
Diagram 1 Test arrangement for Conducted emissions	11
Diagram 2 Test arrangement for radiated emissions of tabletop equipment.....	12
Diagram 3 Test arrangement for radiated emissions tested on Open Area Test Site (OATS).....	13
TEST SITE LOCATIONS	13
LIST OF TEST EQUIPMENT	14
UNITS OF MEASUREMENTS	14
ENVIRONMENTAL CONDITIONS.....	15
STATEMENT OF MODIFICATIONS AND DEVIATIONS	15
INTENTIONAL RADIATORS.....	15
Antenna Requirements	15

Restricted Bands of Operation.....15

Table 1 Harmonic Radiated Emissions in Restricted Bands Data (Worst-case).....16

Summary of Results for Radiated Emissions in Restricted Bands16

AC Line Conducted Emissions Procedure17

Figure 1 AC Line Conducted emissions of EUT line 1 (#2, EUT – Computer).....18

Figure 2 AC Line Conducted emissions of EUT line 2 (#2, EUT – Computer).....18

Figure 3 AC Line Conducted emissions of EUT line 1 (#3, EUT – 320-00072-01)19

Figure 4 AC Line Conducted emissions of EUT line 2 (#3, EUT – 320-0008-201)19

Figure 5 AC Line Conducted emissions of EUT line 1 (#4, EUT – 320-00072-02)20

Figure 6 AC Line Conducted emissions of EUT line 2 (#4, EUT – 320-00072-02)20

Table 2 AC Line Conducted Emissions Data L1 (#2, EUT – Computer).....21

Table 3 AC Line Conducted Emissions Data L2 (#2, EUT – Computer).....21

Table 4 AC Line Conducted Emissions Data L1 (#3, EUT – 320-00072-01)22

Table 5 AC Line Conducted Emissions Data L2 (#3, EUT – 320-00072-01)22

Table 6 AC Line Conducted Emissions Data L1 (#4, EUT – 320-00072-02)23

Table 7 AC Line Conducted Emissions Data L2 (#3, EUT – 320-00072-02)23

Summary of Results for AC Line Conducted Emissions Results.....24

General Radiated Emissions Procedure.....24

Table 8 General Radiated Emissions Data25

Summary of Results for General Radiated Emissions25

Operation in the Band 2400 – 2483.5 MHz26

Figure 7 Plot of Transmitter Emissions in Operational Frequency (802.11 b-Mode)27

Figure 8 Plot of Transmitter Emissions in Operational Frequency (802.11 g-Mode)27

Figure 9 Plot of Transmitter Emissions in Operational Frequency (802.11 n-Mode)28

Figure 10 Plot of Lower Band Edge (802.11 b-mode)28

Figure 11 Plot of Lower Band Edge (802.11 g-mode)29

Figure 12 Plot of Lower Band Edge (802.11 n-mode)29

Figure 13 Plot of Upper Band Edge (802.11 b-mode).....30

Figure 14 Plot of Upper Band Edge (802.11 g-mode).....30

Figure 15 Plot of Upper Band Edge (802.11 n-mode).....31

Figure 16 Plot of Transmitter 6-dB Occupied Bandwidth (802.11 b-mode)31

Figure 17 Plot of Transmitter 99% Occupied Bandwidth (802.11 b-mode).....32

Figure 18 Plot of Transmitter 6-dB Occupied Bandwidth (802.11 g-mode)32

Figure 19 Plot of Transmitter 99% Occupied Bandwidth (802.11 g-mode).....33

Figure 20 Plot of Transmitter 6-dB Occupied Bandwidth (802.11 n-mode)33

Figure 21 Plot of Transmitter 99% Occupied Bandwidth (802.11 n-mode).....34

Transmitter Emissions Data.....35

Table 9 Transmitter Radiated Emission Worst-case Data35

Table 11 Transmitter Antenna Port Data36

Summary of Results for Transmitter Radiated Emissions of Intentional Radiator.....36

ANNEX..... 37

Annex A Measurement Uncertainty Calculations.....38

Annex B Rogers Labs Test Equipment List.....39

Annex C Rogers Qualifications40

Annex D Rogers Labs Certificate of Accreditation41

Revisions

Revision 1 Issued January 12, 2018

Foreword

The following information is submitted for consideration in obtaining Grant of Certification for License Exempt Digital Transmission System Intentional Radiator operating under Code of Federal Regulations Title 47 (CFR 47) Paragraph 15.247 and Industry Canada RSS-GEN, Issue 4 and RSS-247 Issue 2, operation in the 2400 – 2483.5 MHz band.

Name of Applicant: Garmin International, Inc.
1200 East 151st Street
Olathe, KS 66062

M/N: A03272

FCC ID: IPH-03272 Industry Canada ID: 1792A-03272

Frequency Range: 2412-2462 MHz (20 MHz channels), Average output power 0.022 W,
(99% Occupied bandwidth 802.11b - 13890, 802.11g – 17400,
802.11n - 18240 kHz)

Opinion / Interpretation of Results

Tests Performed	Margin (dB)	Results
Emissions 15.205, RSS-GEN	-7.2	Complies
Emissions as per CFR 47 paragraphs 2 and 15.207	-12.0	Complies
Emissions as per CFR 47 paragraphs 2 and 15.209	-11.9	Complies
Harmonic Emissions per CFR 47 15.247	-13.3	Complies
Power Spectral Density per CFR 47 15.247	-20.0	Complies

Equipment Tested

<u>Equipment</u>	<u>Model / PN</u>	<u>Serial Number</u>
EUT #1	A03272	3959315045
EUT #2	A03272	3959315054
USB interface cable	320-01069-00	N/A
AC/DC Adapter	362-00072-01	Z100531802A2
AC/DC Adapter	362-00072-02	N/A
Laptop Computer	Latitude E6320	FCN03Q1
USB Printer	Dell 0N5819	5D1SL61

Test results in this report relate only to the items tested.

Rogers Labs, Inc.
4405 West 259th Terrace
Louisburg, KS 66053
Phone/Fax: (913) 837-3214
Revision 1

Garmin International, Inc.
Model: A03272
Test #: 170828 1206
Test to: CFR47 15C, RSS-Gen RSS-247
File: A03272 DTS TstRpt 170828 1206

SN's: 3959315045 / 5054
FCC ID: IPH-03272
IC: 1792A-03272
Date: January 12, 2018
Page 6 of 41

Equipment Function

The EUT is a portable digital device. The device incorporates sensors to log movement and other functions, and includes low power transmitters for communication with compatible equipment. The design offers no other interface options as described by the manufacture and presented below in the configuration diagrams. The design provides lower transmitter functions at 13.56 MHz (NFC), and 2402-2480 MHz (ANT and BLE) and higher output power operation across the 2412-2462 MHz (802.11b,g,n). The design provides wireless communications in one of four modes (mode 1 Near Field Communications (NFC), mode 2 ANT; mode 3, BLE; and mode 4, 802.11b,g,n) providing wireless interface capabilities with compatible equipment. The product operates from internal rechargeable battery only and offers no provision for alternate power sources. The design utilizes internal fixed antenna system and offers no provision for antenna replacement or modification. Two samples were provided for testing, one representative of production design, and the other modified for testing purposes replacing the integral antennas with RF connection port. The test samples were provided with test software enabling testing personnel ability to enable transmitter function on defined channels. The antenna modification offered testing facility the ability to connect test equipment to the temporary antenna port for antenna port conducted emission testing. The EUT was arranged as described by the manufacturer emulating typical user configurations for testing purposes. For testing purposes, the EUT received powered from freshly charged internal battery and configured to operate in available modes. As requested by the manufacturer and required by regulations, the equipment was tested for emissions compliance using the available configurations with the worst-case data presented. The test software enabled extremely high duty cycles approaching 100% transmission for testing purposes. The production product will not operate at these high duty cycles. This report documents compliance testing and results for applicable product modes of operation. Test results in this report relate only to the products described in this report.

Equipment Configuration

- 1) Unit operating off internal battery

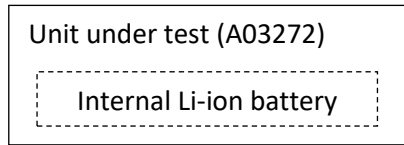

- 2) Battery charged via USB cable (GPN: 320-01069-00) connected to Computer

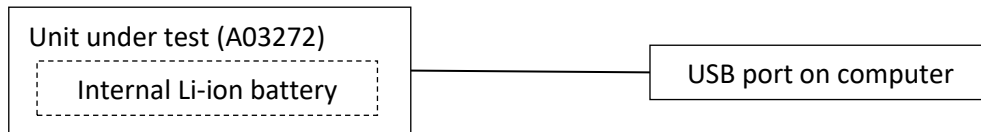

- 3) Battery charged via USB cable (GPN: 320-01069-00) connected to AC adapter (US)

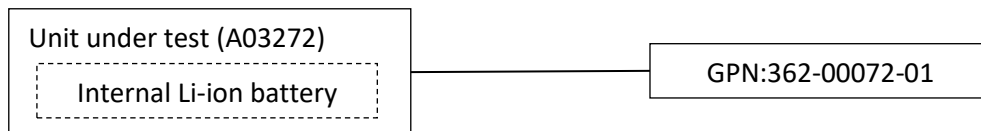

- 4) Battery charged via USB cable (GPN: 320-01069-00) connected to AC adapter (Europe)

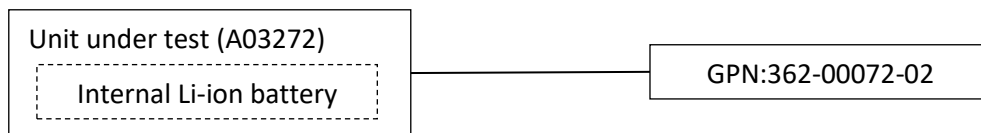

- 5) Battery charged via USB cable (GPN: 320-01069-00) connected to vehicle adapter

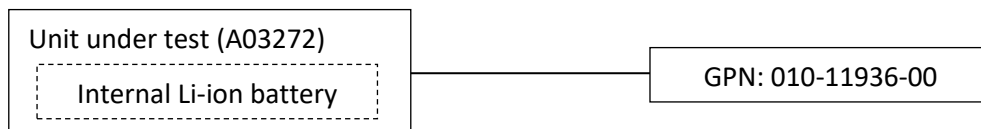

- 6) Unit powered by internal battery transmitting NFC at 13.56 MHz, ANT/BLE/Wi-Fi wireless data @ 2.4 GHz

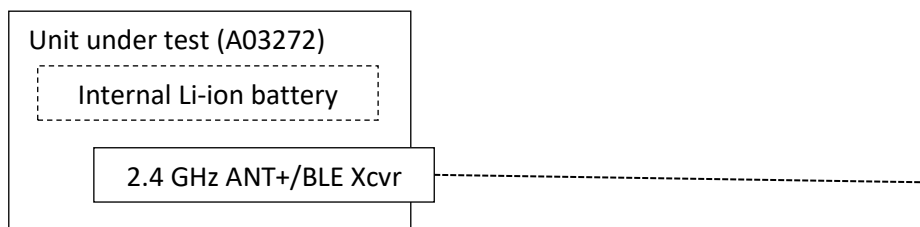

Application for Certification

- (1) Manufacturer: Garmin International, Inc.
1200 East 151st Street
Olathe, KS 66062
- (2) Identification: M/N: A03272
FCC ID: IPH-03272 IC: 1792A-03272
- (3) Instruction Book:
Refer to Exhibit for Instruction Manual.
- (4) Description of Circuit Functions:
Refer to Exhibit of Operational Description.
- (5) Block Diagram with Frequencies:
Refer to Exhibit of Operational Description.
- (6) Report of Measurements:
Report of measurements follows in this Report.
- (7) Photographs: Construction, Component Placement, etc.:
Refer to Exhibit for photographs of equipment.
- (8) List of Peripheral Equipment Necessary for operation. The equipment operates from direct current power provided from internal rechargeable battery. The design provides interface options with cradle and USB compliant equipment as presented in this filing. The EUT offers no other connection ports than those presented in this filing.
- (9) Transition Provisions of CFR47 15.37 are not requested.
- (10) Not Applicable. The unit is not a scanning receiver.
- (11) Not Applicable. The EUT does not operate in the 59 – 64 GHz frequency band.
- (12) The equipment is not software defined and this section is not applicable.
- (13) Applications for certification of U-NII devices in the 5.15-5.35 GHz and the 5.47-5.85 GHz bands must include a high-level operational description of the security procedures that control the radio frequency operating parameters and ensure that unauthorized modifications cannot be made. This requirement is not applicable to his DTS device.
- (14) Contain at least one drawing or photograph showing the test set-up for each of the required types of tests applicable to the device for which certification is requested. These drawings or photographs must show enough detail to confirm other information contained in the test report. Any photographs used must be focused originals without glare or dark spots and must clearly show the test configuration used. This information is provided in this report and Test Setup Exhibits provided with the application filing.

Applicable Standards & Test Procedures

The following information is submitted in accordance with the eCFR Federal Communications Code of Federal Regulations, dated August 28, 2017, Part 2, Subpart J, Paragraphs 2.907, 2.911, 2.913, 2.925, 2.926, 2.1031 through 2.1057, and applicable parts of paragraph 15, Part 15C Paragraph 15.247, and Industry Canada RSS-GEN Issue 4, and RSS-247 Issue 2. Test procedures used are the established Methods of Measurement of Radio-Noise Emissions as described in ANSI C63.10-2013.

Equipment Testing Procedures

AC Line Conducted Emission Test Procedure

Testing for the AC line-conducted emissions was performed as required in 47CFR 15C, RSS-247 and specified in ANSI C63.10-2013. The test setup, including the EUT, was arranged in the test configurations as presented during testing. The test configuration was placed on a 1 x 1.5-meter bench, 0.8 meters high located in a screen room. The power lines of the system were isolated from the power source using a standard LISN with a 50- μ Hy choke. EMI was coupled to the spectrum analyzer through a 0.1 μ F capacitor internal to the LISN. The LISN was positioned on the floor beneath the wooden bench supporting the EUT. The power lines and cables were draped over the back edge of the table. Refer to diagram one showing typical test arrangement and photographs in exhibits for EUT placement used during testing.

Radiated Emission Test Procedure

Radiated emissions testing was performed as required in CFR47 15, RSS-247 and specified in ANSI C63.10-2013. The EUT was placed on a rotating 0.9 x 1.2-meter platform, elevated as required above the ground plane at a distance of 3 meters from the FSM antenna. EMI energy was maximized by equipment placement permitting orientation in three orthogonal axes, raising and lowering the FSM antenna, changing the antenna polarization, and by rotating the turntable. Each emission was maximized before data was taken using a spectrum analyzer. The frequency spectrum from 9 kHz to 25,000 MHz was searched for during preliminary investigation. Refer to diagrams two and three showing typical test arrangement and photographs in the test setup exhibits for specific EUT placement during testing.

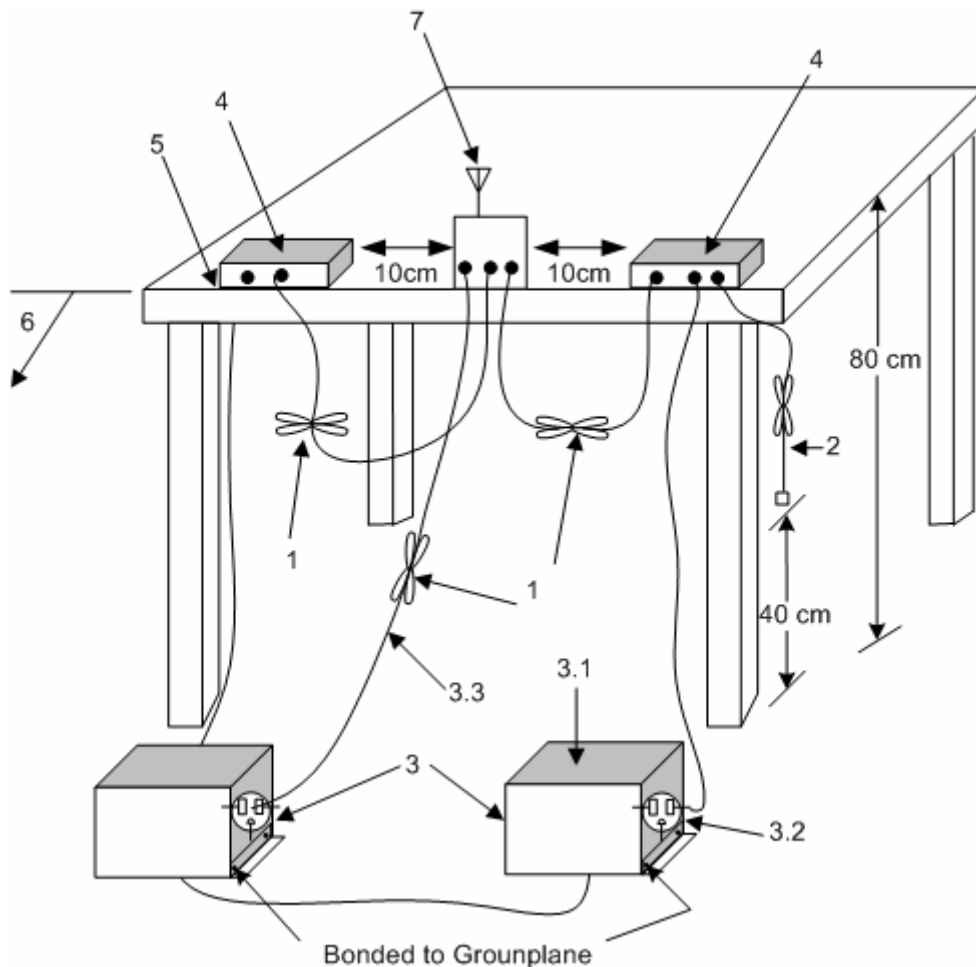

1. Interconnecting cables that hang closer than 40 cm to the ground plane shall be folded back and forth in the center forming a bundle 30 cm to 40 cm long see (see 6.2.3.1).
2. I/O cables that are not connected to an accessory shall be bundled in the center. The end of the cable may be terminated, if required, using the correct terminating impedance. The overall length shall not exceed 1 m (see 6.2.2).
3. EUT connected to one LISN. Unused LISN measuring port connectors shall be terminated in 50 Ω loads. LISN can be placed on top of, or immediately beneath, reference ground plane (see 6.2.2 and 6.2.3).
 - 3.1 All other equipment powered from additional LISN(s).
 - 3.2 Multiple-outlet strip can be used for multiple power cords of non-EUT equipment.
 - 3.3 LISN at least 80 cm from nearest part of EUT chassis.
4. Non-EUT components of EUT system being tested.
5. Rear of EUT, including peripherals, shall all be aligned and flush with rear of tabletop (see 6.2.3.1).
6. Edge of tabletop shall be 40 cm removed from a vertical conducting plane that is bonded to the ground plane (see 6.2.2 for options).
7. Antenna may be integral or detachable. If detachable, the antenna shall be attached for this test.

Diagram 1 Test arrangement for Conducted emissions

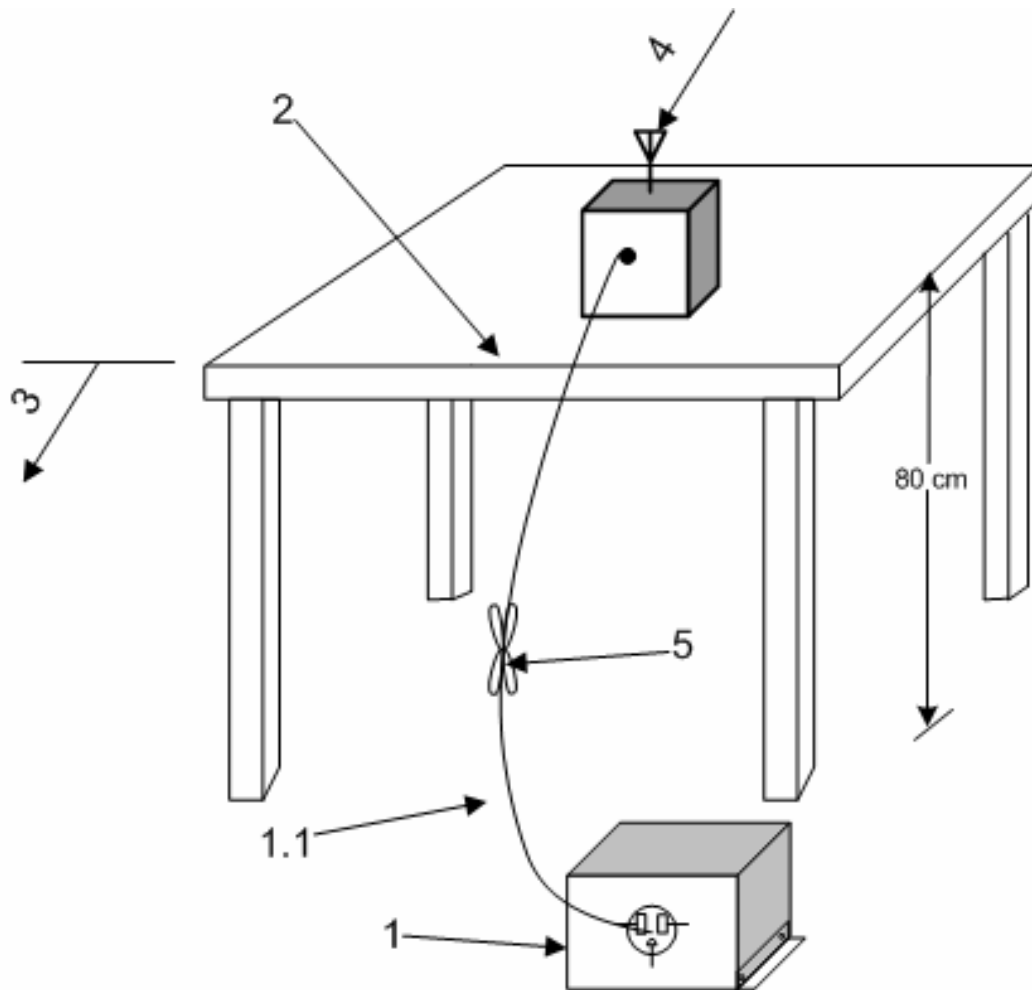

1. A LISN is optional for radiated measurements between 30 MHz to 1000 MHz, but not allowed for measurements below 30 MHz and above 1000 MHz. (See 6.4.3, 6.5.1, and 6.6.3.) If used, connect EUT to one LISN. Unused LISN measuring port connectors shall be terminated in 50Ω. LISN can be placed on top of, or immediately beneath, reference ground plane (see 6.2.2 and 6.2.3.1).
 - 1.1 LISN spaced at least 80 cm from nearest part of EUT chassis.
2. The EUT shall be placed in the center of the table to the extent possible. (See 6.2.3.1 and 6.3.4).
3. A vertical conducting plane, if used for conducted tests per 6.2.2, shall be removed for radiated emission tests.
4. Antenna may be integral or detachable, depending on the EUT.
5. Interconnecting cables that hang closer than 40 cm to the ground plane shall be folded back and forth in the center forming a bundle 30 cm to 40 cm long.

Diagram 2 Test arrangement for radiated emissions of tabletop equipment

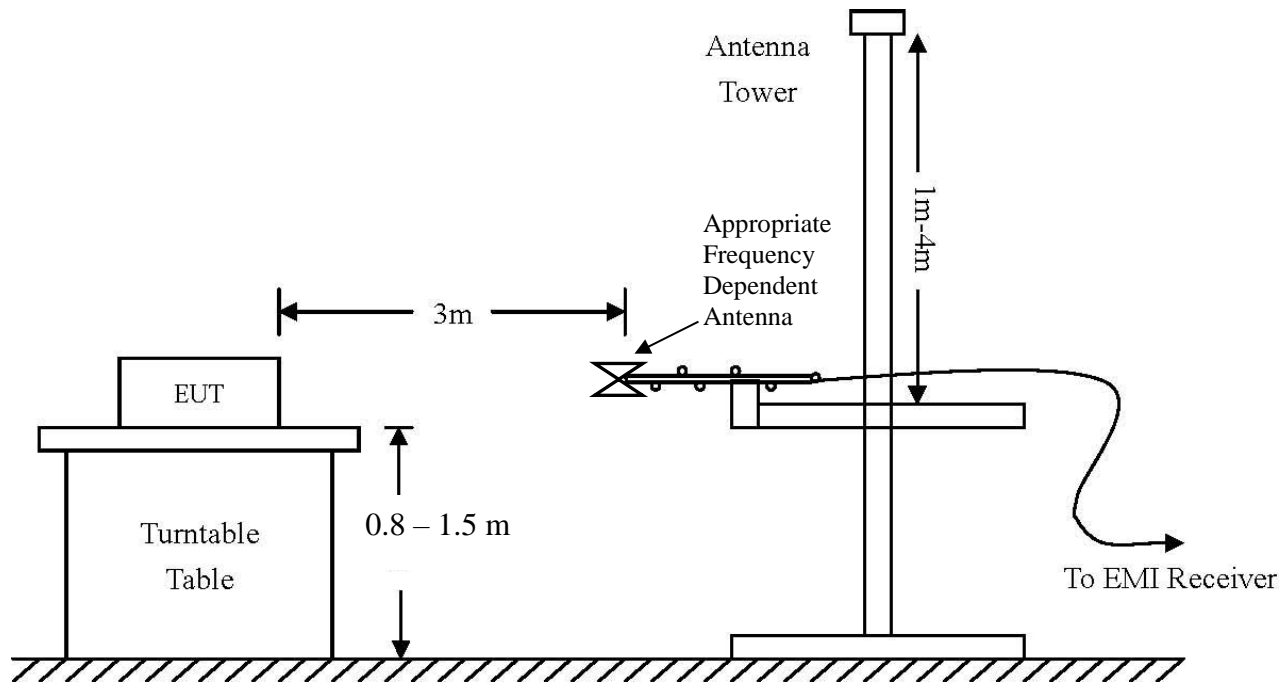

AC Line Conducted Emissions (0.150 -30 MHz)		
RBW	AVG. BW	Detector Function
9 kHz	30 kHz	Peak / Quasi Peak
Emissions (30-1000 MHz)		
RBW	AVG. BW	Detector Function
120 kHz	300 kHz	Peak / Quasi Peak
Emissions (Above 1000 MHz)		
RBW	Video BW	Detector Function
100 kHz	100 kHz	Peak
1 MHz	1 MHz	Peak / Average

Diagram 3 Test arrangement for radiated emissions tested on Open Area Test Site (OATS)

Test Site Locations

Conducted EMI The AC power line conducted emissions testing performed in a shielded screen room located at Rogers Labs, Inc., 4405 West 259th Terrace, Louisburg, KS

Radiated EMI The radiated emissions tests were performed at the 3 meters, Open Area Test Site (OATS) located at Rogers Labs, Inc., 4405 West 259th Terrace, Louisburg, KS

Site Registration Refer to Annex for Site Registration Letters

NVLAP Accreditation Lab code 200087-0

Rogers Labs, Inc.
4405 West 259th Terrace
Louisburg, KS 66053
Phone/Fax: (913) 837-3214
Revision 1

Garmin International, Inc.
Model: A03272
Test #: 170828 1206
Test to: CFR47 15C, RSS-Gen RSS-247
File: A03272 DTS TstRpt 170828 1206

SN's: 3959315045 / 5054
FCC ID: IPH-03272
IC: 1792A-03272
Date: January 12, 2018
Page 13 of 41

List of Test Equipment

<u>Equipment</u>	<u>Manufacturer</u>	<u>Model (SN)</u>	<u>Band</u>	<u>Cal Date</u>	<u>Due</u>
<input checked="" type="checkbox"/> LISN	FCC	FCC-LISN-50-2-10(1PA) (160611)	.15-30MHz	5/17	5/18
<input checked="" type="checkbox"/> Cable	Time Microwave	750HF290-750 (L10M)	9kHz-40 GHz	10/17	10/18
<input checked="" type="checkbox"/> Cable	Belden	RG-58 (L1-CAT3-11509)	9kHz-30 MHz	10/17	10/18
<input checked="" type="checkbox"/> Cable	Belden	RG-58 (L2-CAT3-11509)	9kHz-30 MHz	10/17	10/18
<input type="checkbox"/> Antenna	ARA	BCD-235-B (169)	20-350MHz	10/17	10/18
<input type="checkbox"/> Antenna	EMCO	3147 (40582)	200-1000MHz	10/17	10/18
<input checked="" type="checkbox"/> Antenna	ETS-Lindgren	3117 (200389)	1-18 GHz	5/17	5/18
<input type="checkbox"/> Antenna	Com Power	AH-118 (10110)	1-18 GHz	10/17	10/19
<input checked="" type="checkbox"/> Antenna	Com Power	AH-840 (101046)	18-40 GHz	5/17	5/19
<input checked="" type="checkbox"/> Antenna	Com Power	AL-130 (121055)	.001-30 MHz	10/17	10/18
<input checked="" type="checkbox"/> Antenna	Sunol	JB-6 (A100709)	30-1000 MHz	10/17	10/18
<input type="checkbox"/> Antenna	EMCO	3143 (9607-1277)	20-1200 MHz	5/17	5/18
<input type="checkbox"/> Analyzer	HP	8591EM (3628A00871)	9kHz-1.8GHz	5/17	5/18
<input type="checkbox"/> Analyzer	HP	8562A (3051A05950)	9kHz-110GHz	5/17	5/18
<input type="checkbox"/> Analyzer	HP External Mixers	11571, 11970	25GHz-110GHz	5/17	5/18
<input checked="" type="checkbox"/> Analyzer	Rohde & Schwarz	ESU40 (100108)	20Hz-40GHz	5/17	5/18
<input checked="" type="checkbox"/> Amplifier	Com-Power	PA-010 (171003)	100Hz-30MHz	10/17	10/18
<input checked="" type="checkbox"/> Amplifier	Com-Power	CPPA-102 (01254)	1-1000 MHz	10/17	10/18
<input checked="" type="checkbox"/> Amplifier	Com-Power	PAM-118A (551014)	0.5-18 GHz	10/17	10/18
<input checked="" type="checkbox"/> Power Mtr	Agilent	N1911A with N1921A	0.05-18 GHz	5/17	5/18

Units of Measurements

Conducted EMI Data is in dB μ V; dB referenced to one microvolt

Radiated EMI Data is in dB μ V/m; dB/m referenced to one microvolt per meter

Sample Calculation:

RFS = Radiated Field Strength, FSM = Field Strength Measured

A.F. = Receive antenna factor, Gain = amplification gains and/or cable losses

RFS (dB μ V/m @ 3m) = FSM (dB μ V) + A.F. (dB) - Gain (dB)

Environmental Conditions

Ambient Temperature 21.2° C

Relative Humidity 32%

Atmospheric Pressure 1019.2 mb

Statement of Modifications and Deviations

No modifications to the EUT were required for the unit to demonstrate compliance with the CFR47 Part 15C, RSS-Gen, and RSS-247 emission requirements. There were no deviations to the specifications.

Intentional Radiators

The following information is submitted in support demonstration of compliance with the requirements of CFR47, Subpart C, paragraph 15.247 and Industry Canada RSS-247 and RSS-Gen the following information is submitted.

Antenna Requirements

The EUT incorporates integral antenna system and offers no provision for connection to alternate antenna system. The antenna connection point complies with the unique antenna connection requirements. There are no deviations or exceptions to the specification.

Restricted Bands of Operation

Spurious emissions falling in the restricted frequency bands of operation were measured at the OATS. The EUT utilizes frequency, determining circuitry, which generates harmonics falling in the restricted bands. Emissions were investigated at the OATS, using appropriate antennas or pyramidal horns, amplification stages, and a spectrum analyzer. Peak and average amplitudes of frequencies above 1000 MHz were compared to the required limits with worst-case data presented below. Test procedures of ANSI C63.10-2013 paragraph 6 and KDB 558074 paragraph 10.2 were used during testing. No other significant emission was observed which fell into the restricted bands of operation. Computed emission values consider the received radiated field strength, receive antenna correction factor, amplifier gain stage, and test system cable losses.

Table 1 Harmonic Radiated Emissions in Restricted Bands Data (Worst-case)

Frequency in MHz	Horizontal Peak (dB μ V/m)	Horizontal Quasi-Peak (dB μ V/m)	Horizontal Average (dB μ V/m)	Vertical Peak (dB μ V/m)	Vertical Quasi-Peak (dB μ V/m)	Vertical Average (dB μ V/m)	Limit @ 3m (dB μ V/m)
2390.0	57.2	N/A	46.8	47.3	N/A	35.8	54.0
2483.5	507.0	N/A	39.9	46.1	N/A	30.4	54.0
4824.0	42.5	N/A	29.5	45.0	N/A	31.7	54.0
4874.0	46.4	N/A	32.8	44.9	N/A	31.9	54.0
4924.0	43.7	N/A	30.5	42.8	N/A	30.2	54.0
7236.0	46.0	N/A	33.3	47.5	N/A	34.3	54.0
7311.0	46.5	N/A	33.2	45.6	N/A	32.8	54.0
7386.0	45.9	N/A	32.8	46.1	N/A	32.6	54.0
12060.0	48.3	N/A	35.6	50.3	N/A	37.5	54.0
12185.0	49.1	N/A	35.8	48.8	N/A	36.2	54.0
12310.0	50.5	N/A	36.6	49.2	N/A	36.2	54.0

Other emissions present had amplitudes at least 20 dB below the limit. Peak and Quasi-Peak amplitude emissions are recorded for frequency below 1000 MHz. Peak and Average amplitude emissions are recorded for frequency range above 1000 MHz.

Summary of Results for Radiated Emissions in Restricted Bands

The EUT demonstrated compliance with the radiated emissions requirements of CFR 47 Part 15C RSS-Gen, and RSS-247 Intentional Radiators. The EUT demonstrated a worst-case minimum harmonic margin of -7.2 dB below the radiated emissions requirements in restricted frequency bands. Peak, Quasi-peak, and average amplitudes were checked for compliance with the regulations. Worst-case emissions are reported with other emissions found in the restricted frequency bands at least 20 dB below the requirements.

AC Line Conducted Emissions Procedure

The EUT was arranged in typical equipment configurations operating from AC power adapter. Testing was performed with the EUT placed on a 1 x 1.5-meter wooden bench 80 cm above the conducting ground plane, floor of a screen room. The bench was positioned 40 cm away from the wall of the screen room. The LISN was positioned on the floor of the screen room 80-cm from the rear of the EUT. Testing for the line-conducted emissions were the procedures of ANSI C63.10-2013 paragraph 6. The AC adapter for the EUT was connected to the LISN for line-conducted emissions testing. A second LISN was positioned on the floor of the screen room 80-cm from the rear of the supporting equipment of the EUT. All power cords except the EUT were then powered from the second LISN. EMI was coupled to the spectrum analyzer through a 0.1 μ F capacitor, internal to the LISN. Power line conducted emissions testing was carried out individually for each current carrying conductor of the EUT. The excess length of lead between the system and the LISN receptacle was folded back and forth to form a bundle not exceeding 40 cm in length. The screen room, conducting ground plane, analyzer, and LISN were bonded together to the protective earth ground. Preliminary testing was performed to identify the frequencies of each of the emissions, which demonstrated the highest amplitudes. The cables were repositioned to obtain maximum amplitude of measured EMI level. Once the worst-case configuration was identified, plots were made of the EMI from 0.15 MHz to 30 MHz then data was recorded with maximum conducted emissions levels.

Refer to figures one through two showing plots of the computer configuration line conducted emissions and figures three through six for plots of the AC adapter AC Line conducted emissions.

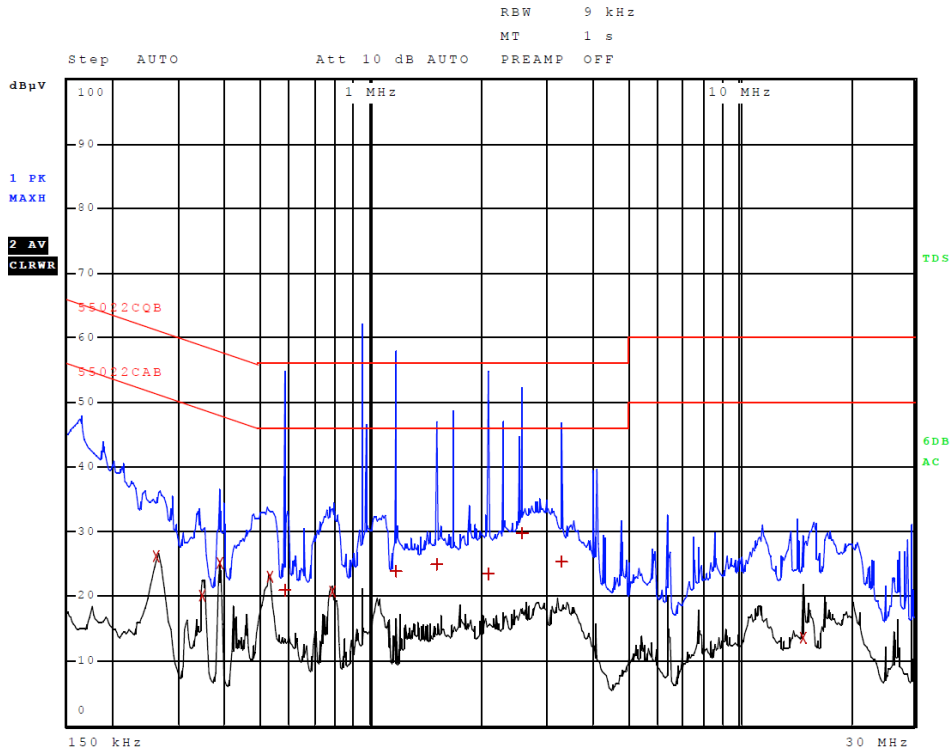

Figure 1 AC Line Conducted emissions of EUT line 1 (#2, EUT – Computer)

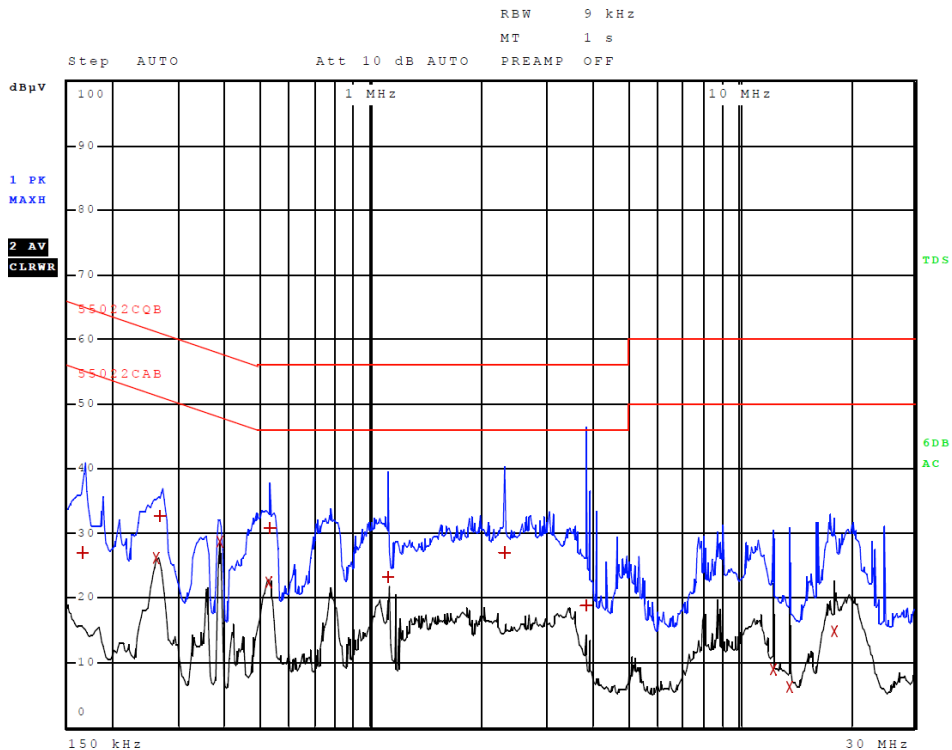

Figure 2 AC Line Conducted emissions of EUT line 2 (#2, EUT – Computer)

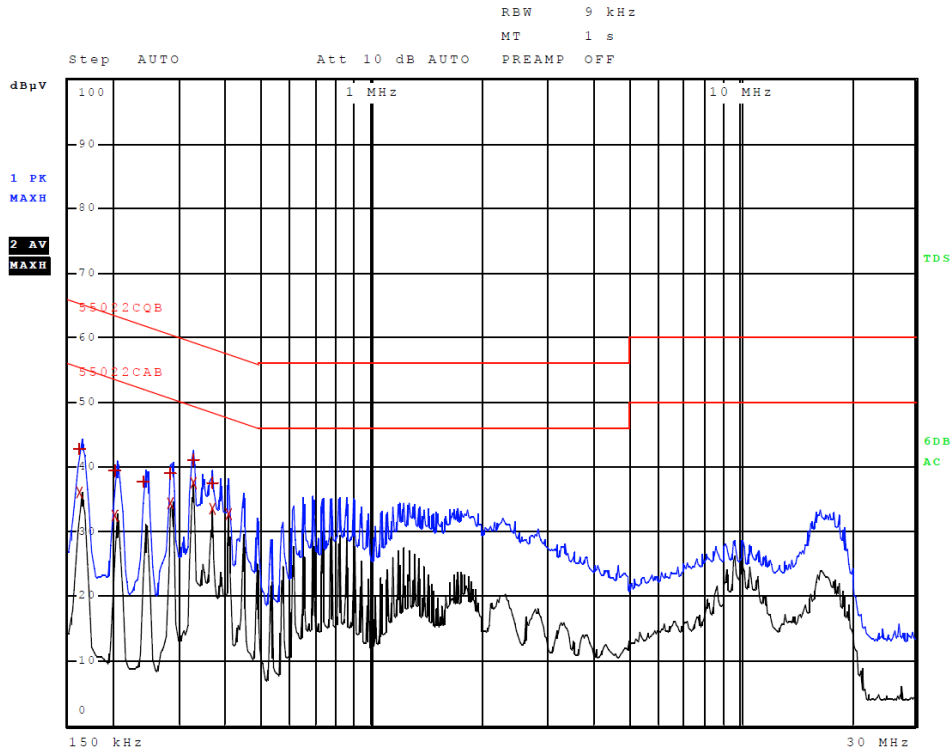

Figure 3 AC Line Conducted emissions of EUT line 1 (#3, EUT – 320-00072-01)

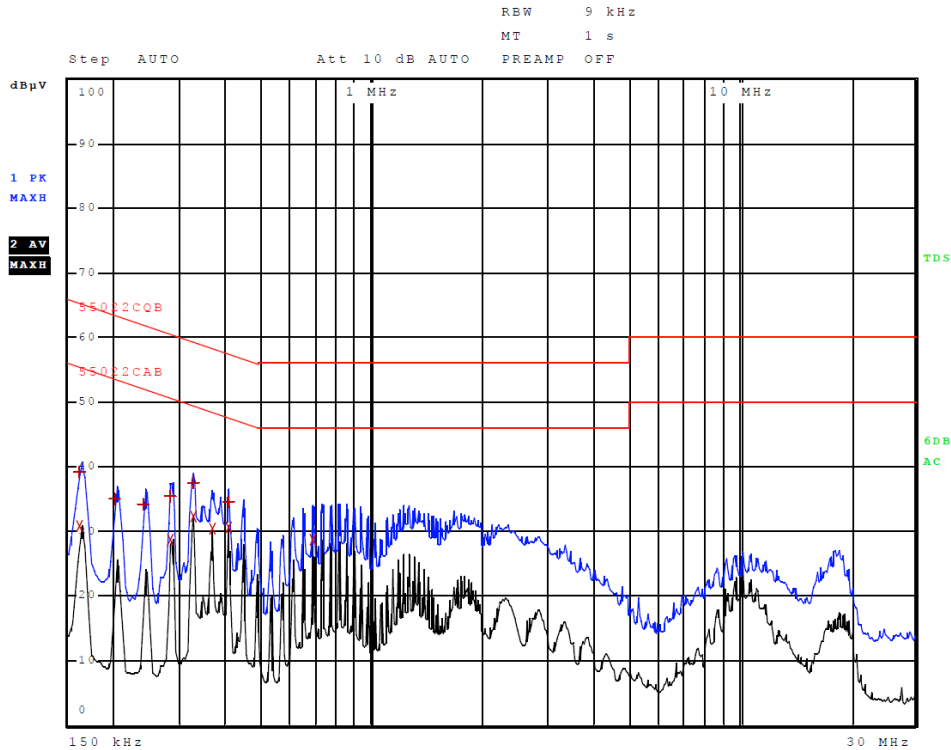

Figure 4 AC Line Conducted emissions of EUT line 2 (#3, EUT – 320-0008-201)

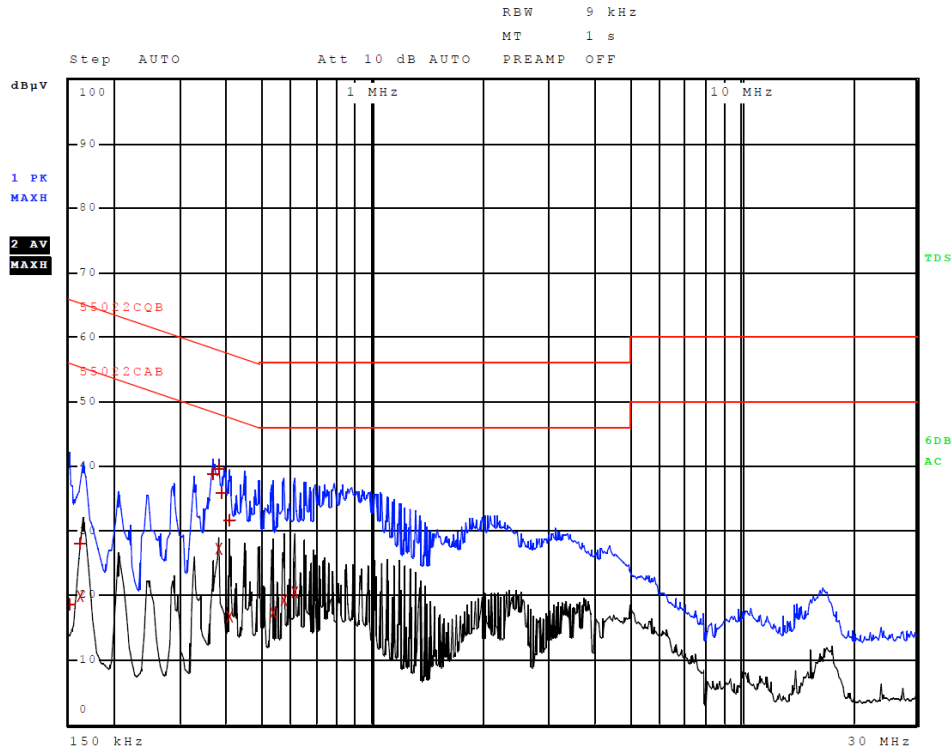

Figure 5 AC Line Conducted emissions of EUT line 1 (#4, EUT – 320-00072-02)

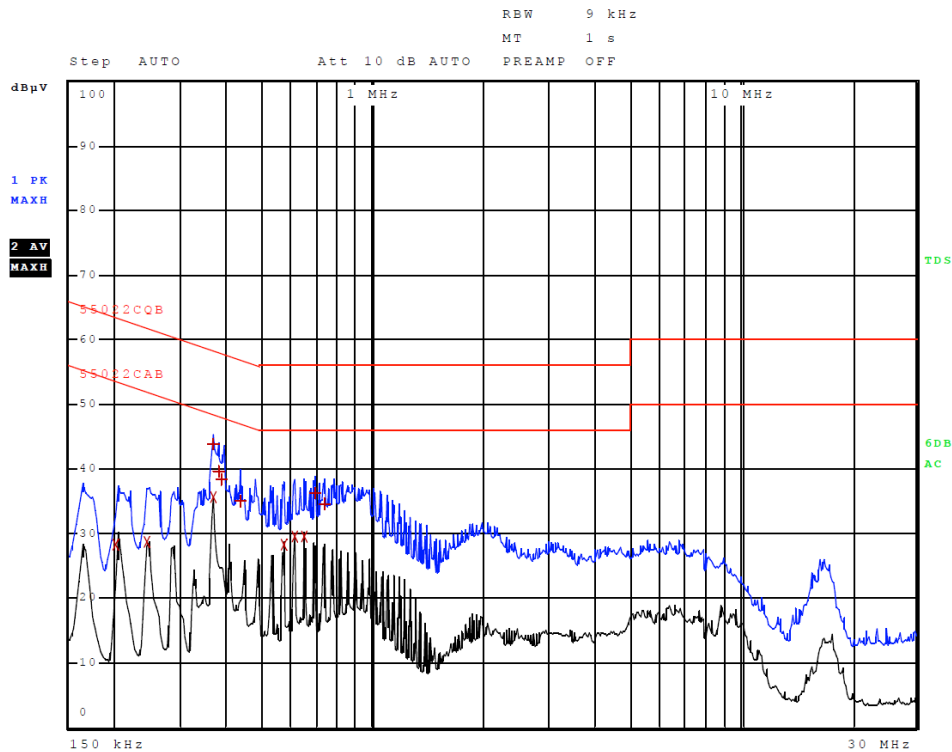

Figure 6 AC Line Conducted emissions of EUT line 2 (#4, EUT – 320-00072-02)

Table 2 AC Line Conducted Emissions Data L1 (#2, EUT – Computer)

Trace	Frequency	Level (dBµV)	Detector	Delta Limit/dB
2	262.000000000 kHz	26.09	Average	-25.28
2	346.000000000 kHz	19.99	Average	-29.07
2	386.000000000 kHz	25.10	Average	-23.05
2	526.000000000 kHz	23.00	Average	-23.00
1	582.000000000 kHz	20.84	Quasi Peak	-35.16
2	782.000000000 kHz	20.77	Average	-25.23
1	1.166000000 MHz	23.91	Quasi Peak	-32.09
1	1.506000000 MHz	24.95	Quasi Peak	-31.05
1	2.090000000 MHz	23.52	Quasi Peak	-32.48
1	2.566000000 MHz	29.76	Quasi Peak	-26.24
1	3.306000000 MHz	25.40	Quasi Peak	-30.60
2	15.008000000 MHz	13.54	Average	-36.46

Other emissions present had amplitudes at least 20 dB below the limit.

Table 3 AC Line Conducted Emissions Data L2 (#2, EUT – Computer)

Trace	Frequency	Level (dBµV)	Detector	Delta Limit/dB
1	166.000000000 kHz	27.09	Quasi Peak	-38.07
2	262.000000000 kHz	26.21	Average	-25.15
1	270.000000000 kHz	32.69	Quasi Peak	-28.43
2	386.000000000 kHz	28.57	Average	-19.58
2	522.000000000 kHz	22.44	Average	-23.56
1	526.000000000 kHz	30.80	Quasi Peak	-25.20
1	1.106000000 MHz	23.27	Quasi Peak	-32.73
1	2.298000000 MHz	26.99	Quasi Peak	-29.01
1	3.846000000 MHz	18.71	Quasi Peak	-37.29
2	12.360000000 MHz	8.89	Average	-41.11
2	13.752000000 MHz	6.23	Average	-43.77
2	18.144000000 MHz	14.89	Average	-35.11

Other emissions present had amplitudes at least 20 dB below the limit.

Table 4 AC Line Conducted Emissions Data L1 (#3, EUT – 320-00072-01)

Trace	Frequency	Level (dBµV)	Detector	Delta Limit/dB
1	162.000000000 kHz	42.82	Quasi Peak	-22.54
2	162.000000000 kHz	35.94	Average	-19.42
1	202.000000000 kHz	39.40	Quasi Peak	-24.13
2	202.000000000 kHz	32.56	Average	-20.97
1	242.000000000 kHz	37.67	Quasi Peak	-24.36
2	286.000000000 kHz	34.38	Average	-16.25
1	286.000000000 kHz	39.02	Quasi Peak	-21.62
2	326.000000000 kHz	37.52	Average	-12.03
1	326.000000000 kHz	41.05	Quasi Peak	-18.50
2	366.000000000 kHz	33.50	Average	-15.09
1	366.000000000 kHz	37.52	Quasi Peak	-21.07
2	406.000000000 kHz	32.70	Average	-15.03

Other emissions present had amplitudes at least 20 dB below the limit.

Table 5 AC Line Conducted Emissions Data L2 (#3, EUT – 320-00072-01)

Trace	Frequency	Level (dBµV)	Detector	Delta Limit/dB
1	162.000000000 kHz	39.24	Quasi Peak	-26.12
2	162.000000000 kHz	30.71	Average	-24.65
1	202.000000000 kHz	35.02	Quasi Peak	-28.51
1	242.000000000 kHz	34.13	Quasi Peak	-27.89
2	286.000000000 kHz	28.58	Average	-22.06
1	286.000000000 kHz	35.50	Quasi Peak	-25.14
2	326.000000000 kHz	32.30	Average	-17.25
1	326.000000000 kHz	37.54	Quasi Peak	-22.01
2	366.000000000 kHz	30.26	Average	-18.33
2	406.000000000 kHz	30.66	Average	-17.07
1	406.000000000 kHz	34.64	Quasi Peak	-23.09
2	690.000000000 kHz	28.66	Average	-17.34

Other emissions present had amplitudes at least 20 dB below the limit.

Table 6 AC Line Conducted Emissions Data L1 (#4, EUT – 320-00072-02)

Trace	Frequency	Level (dBµV)	Detector	Delta Limit/dB
1	150.000000000 kHz	18.69	Quasi Peak	-47.31
2	162.000000000 kHz	19.92	Average	-35.44
1	162.000000000 kHz	28.07	Quasi Peak	-37.29
1	366.000000000 kHz	38.66	Quasi Peak	-19.93
2	378.000000000 kHz	27.25	Average	-21.07
1	378.000000000 kHz	39.65	Quasi Peak	-18.67
1	390.000000000 kHz	35.85	Quasi Peak	-22.22
2	406.000000000 kHz	16.67	Average	-31.06
1	406.000000000 kHz	31.65	Quasi Peak	-26.08
2	530.000000000 kHz	17.34	Average	-28.66
2	570.000000000 kHz	19.27	Average	-26.73
2	610.000000000 kHz	20.54	Average	-25.46

Other emissions present had amplitudes at least 20 dB below the limit.

Table 7 AC Line Conducted Emissions Data L2 (#3, EUT – 320-00072-02)

Trace	Frequency	Level (dBµV)	Detector	Delta Limit/dB
2	202.000000000 kHz	28.20	Average	-25.33
2	246.000000000 kHz	28.66	Average	-23.23
2	366.000000000 kHz	35.54	Average	-13.05
1	366.000000000 kHz	43.70	Quasi Peak	-14.89
1	378.000000000 kHz	39.60	Quasi Peak	-18.73
1	390.000000000 kHz	38.43	Quasi Peak	-19.63
1	434.000000000 kHz	34.88	Quasi Peak	-22.29
2	570.000000000 kHz	28.25	Average	-17.75
2	610.000000000 kHz	29.47	Average	-16.53
2	650.000000000 kHz	29.52	Average	-16.48
1	694.000000000 kHz	36.29	Quasi Peak	-19.71
1	738.000000000 kHz	34.48	Quasi Peak	-21.52

Other emissions present had amplitudes at least 20 dB below the limit.

Summary of Results for AC Line Conducted Emissions Results

The EUT demonstrated compliance with the AC Line Conducted Emissions requirements of 47CFR Part 15B and other applicable emissions requirements. The worst-case EUT CPU configuration demonstrated a minimum margin of -19.5 dB below the FCC/IC requirements. The worst-case EUT AC adapter configuration #3 demonstrated a minimum margin of -12.0 dB below the FCC/IC requirements. The worst-case EUT AC adapter configuration #4 demonstrated a minimum margin of -13.0 dB below the FCC/IC requirements. Other emissions were present with amplitudes at least 20 dB below the limit and worst-case amplitudes recorded.

General Radiated Emissions Procedure

The EUT was arranged in a typical equipment configuration and operated through all available mode during testing. Preliminary testing was performed in a screen room with the EUT positioned 1 meter from the FSM. Radiated emissions measurements were performed to identify the frequencies, which produced the highest emissions. Each radiated emission was then maximized at the OATS location before final radiated measurements were performed. Final data was taken with the EUT located on the OATS at 3 meters distance between the EUT and the receiving antenna. The frequency spectrum from 9 kHz to 25,000 MHz was searched for general radiated emissions. Measured emission levels were maximized by EUT placement on the table, rotating the turntable through 360 degrees, varying the antenna height between 1 and 4 meters above the ground plane and changing antenna position between horizontal and vertical polarization. Antennas used were Loop from 9 kHz to 30 MHz, Broadband Biconical from 30 to 200 MHz, Biconilog from 30 to 1000 MHz, Log Periodic from 200 MHz to 1 GHz and or double Ridge or pyramidal horns and mixers above 1 GHz, notch filters and appropriate amplifiers and external mixers were utilized.

Table 8 General Radiated Emissions Data

Frequency in MHz	Horizontal Peak (dBµV/m)	Horizontal Quasi-Peak (dBµV/m)	Horizontal Average (dBµV/m)	Vertical Peak (dBµV/m)	Vertical Quasi-Peak (dBµV/m)	Vertical Average (dBµV/m)	Limit @ 3m (dBµV/m)
52.0	29.7	22.5	N/A	32.1	27.0	N/A	40.0
78.0	30.1	22.6	N/A	36.0	28.1	N/A	40.0
79.4	33.9	25.1	N/A	35.2	25.5	N/A	40.0
113.5	30.6	23.1	N/A	30.2	21.1	N/A	40.0
119.0	30.9	21.6	N/A	26.9	19.7	N/A	40.0
170.2	28.5	16.4	N/A	24.6	20.2	N/A	40.0

Other emissions present had amplitudes at least 20 dB below the limit. Peak and Quasi-Peak amplitude emissions are recorded for frequency range below 1000 MHz. Peak and Average amplitude emissions are recorded for frequency range above 1000 MHz.

Summary of Results for General Radiated Emissions

The EUT demonstrated compliance with the radiated emissions requirements of CFR47 Part 15C paragraph 15.209, RSS-247 and RSS-GEN Intentional Radiators. The EUT demonstrated a minimum margin of -11.9 dB below the requirements. Other emissions were present with amplitudes at least 20 dB below the Limits.

Operation in the Band 2400 – 2483.5 MHz

Test procedures of ANSI C63.10-2013 paragraph 6, and KDB 558074 v04 were used during transmitter testing. The wideband transmitter power was measured at the antenna port using a wideband RF power meter as described in KDB 558074 (9.2.3). The average Power Spectral Density (AVGPSD) was measured as defined in KDB 558074 (10.3). Emission DTS bandwidth was measured as described in KDB 558074 paragraph 8, and C63.10-2013. The amplitude of each harmonic and general radiated emission was measured on the OATS at distance of 3 meters from the FSM antenna (testing was performed on sample 1 representative of production equipment with integral antenna). The EUT was positioned on supporting turntable elevated as required above the ground plane, at a distance of 3 meters from the FSM antenna. Radiated emission investigations were performed from 9 kHz to 25,000 MHz. Each radiated emission was maximized by varying the FSM antenna height and polarization, and by rotating the turntable. The worst-case amplitude of each emission was then recorded from the analyzer display. The peak and quasi-peak amplitude of frequencies below 1000 MHz were measured using a spectrum analyzer. The peak and average amplitude of frequencies above 1000 MHz were measured using a spectrum analyzer. A Loop antenna was used for measuring emissions from 0.009 to 30 MHz, Biconilog Antenna for 30 to 1000 MHz, Double-Ridge, and/or Pyramidal Horn Antennas from 1 GHz to 25 GHz. Radiated Emissions were measured in dB μ V/m @ 3 meters. Test sample #2 was provided for testing antenna port conducted emissions. This sample was modified by replacing the internal antenna with a 50-ohm antenna port connector for testing purposes. Plots were taken of transmitter performance (using sample #2) for reference in this and other documentation.

Refer to figures seven through twenty-one showing plots taken of the transmitter performance displaying compliance with the specifications.

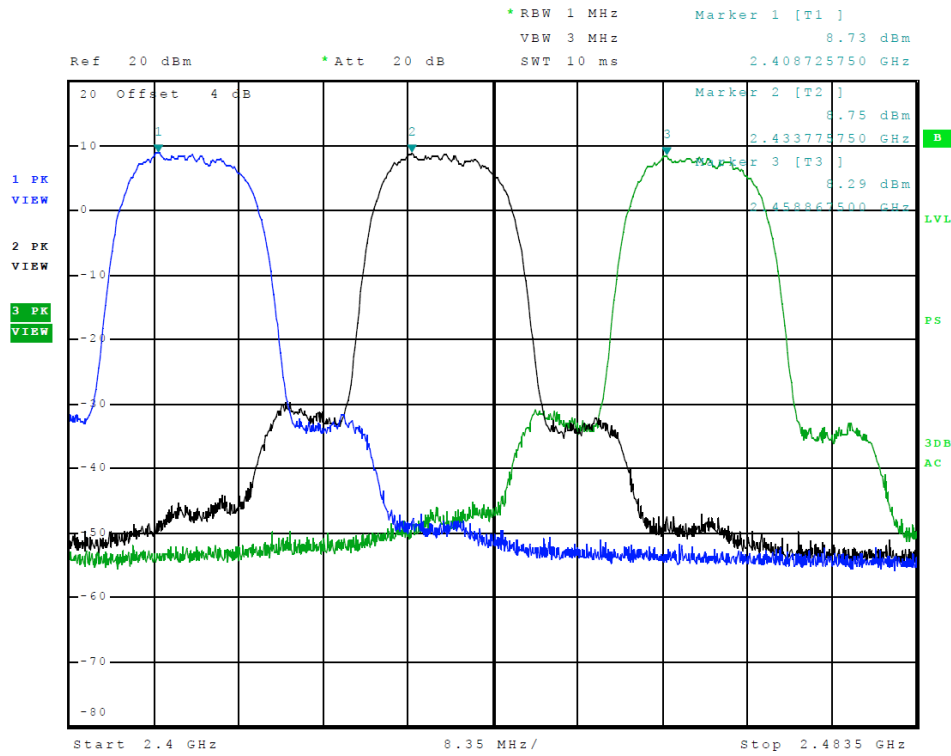

Figure 7 Plot of Transmitter Emissions in Operational Frequency (802.11 b-Mode)

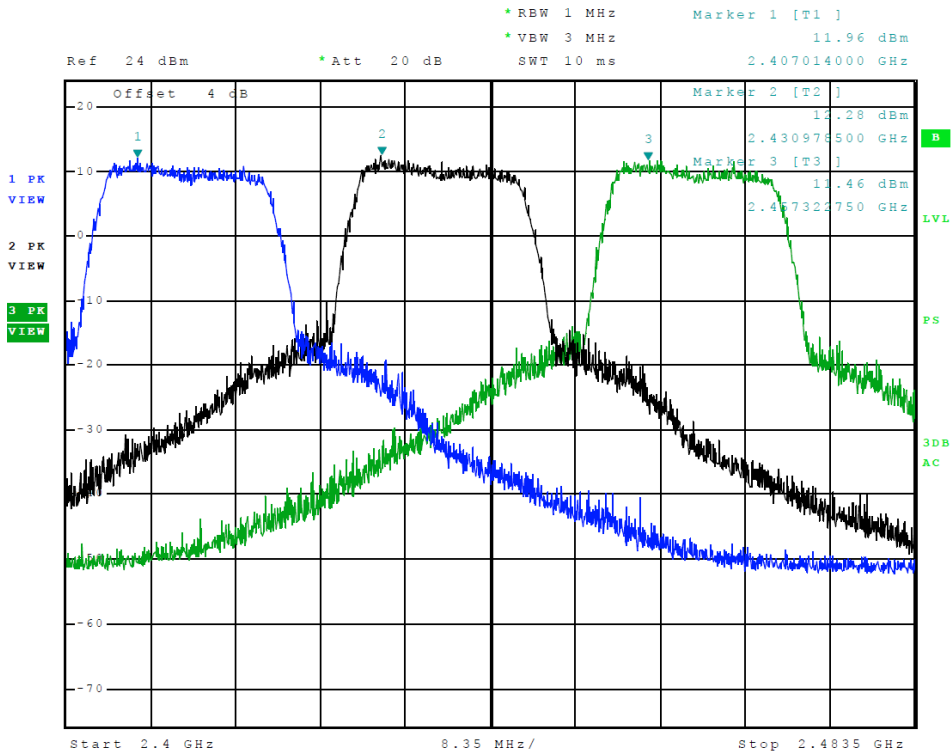

Figure 8 Plot of Transmitter Emissions in Operational Frequency (802.11 g-Mode)

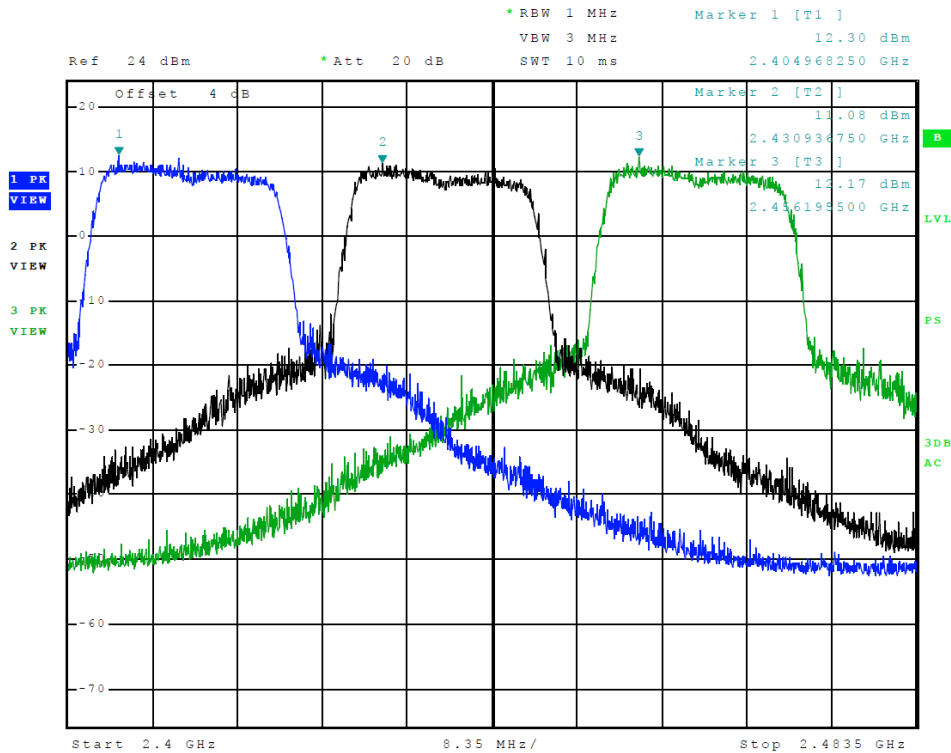

Figure 9 Plot of Transmitter Emissions in Operational Frequency (802.11 n-Mode)

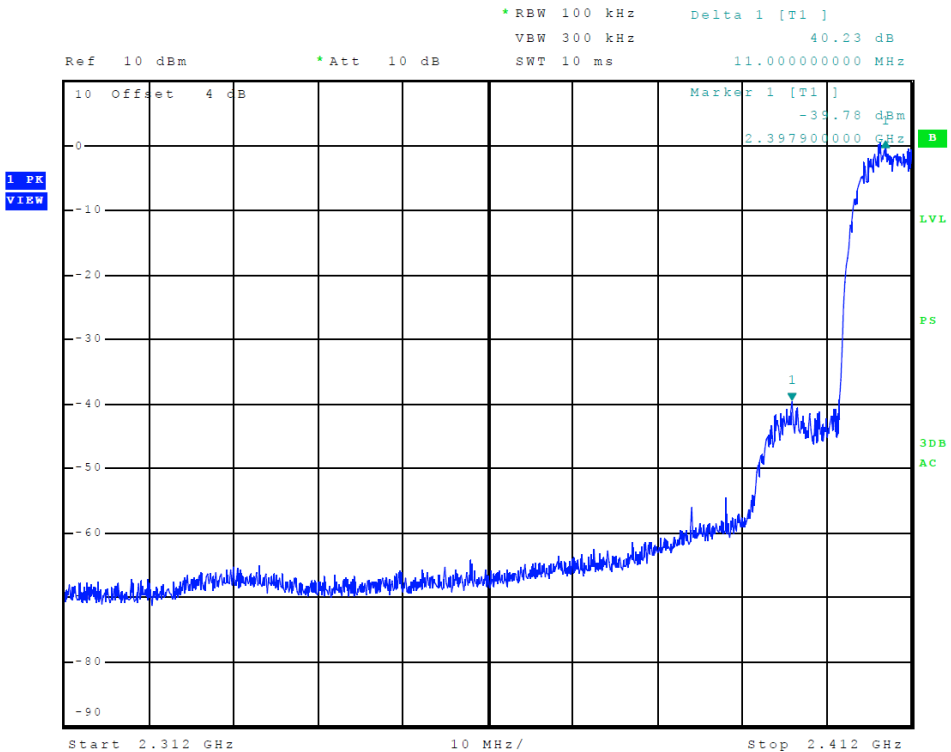

Figure 10 Plot of Lower Band Edge (802.11 b-mode)

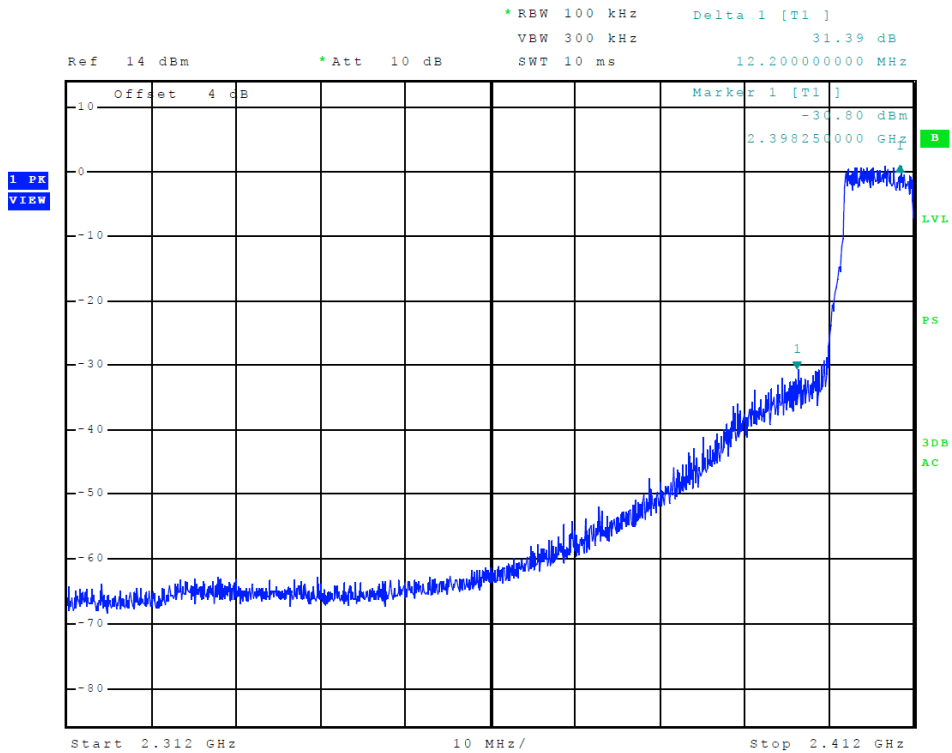

Figure 11 Plot of Lower Band Edge (802.11 g-mode)

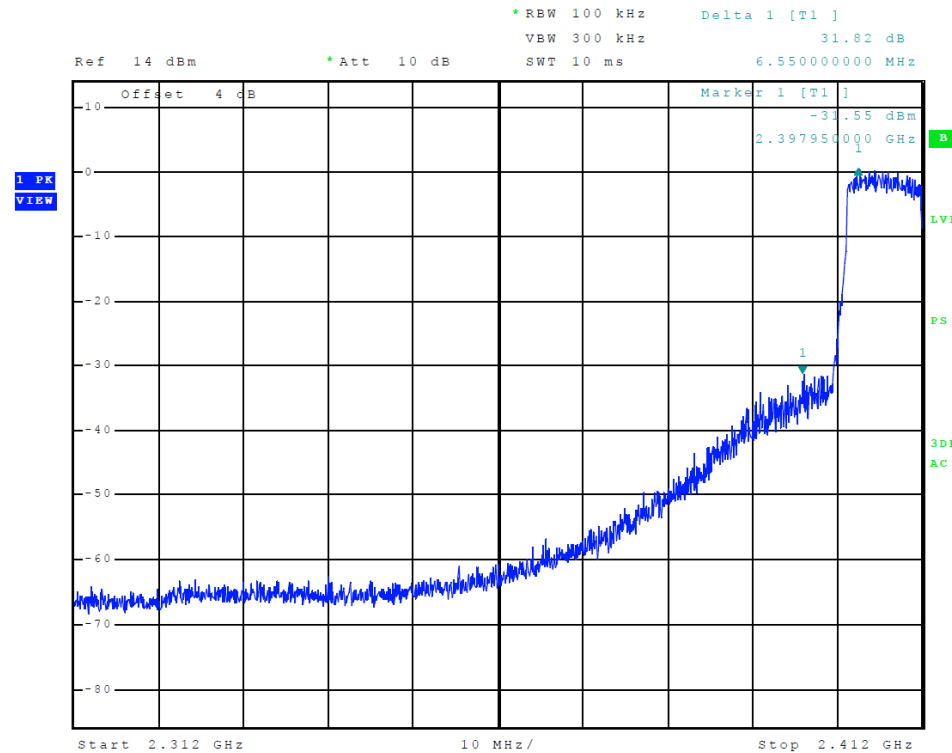

Figure 12 Plot of Lower Band Edge (802.11 n-mode)

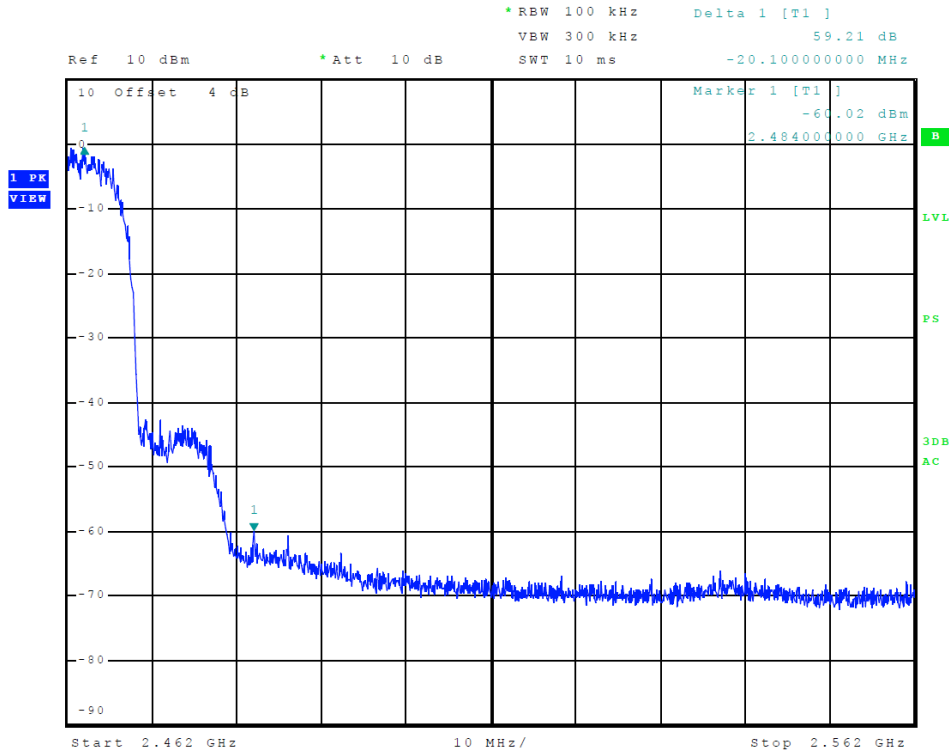

Figure 13 Plot of Upper Band Edge (802.11 b-mode)

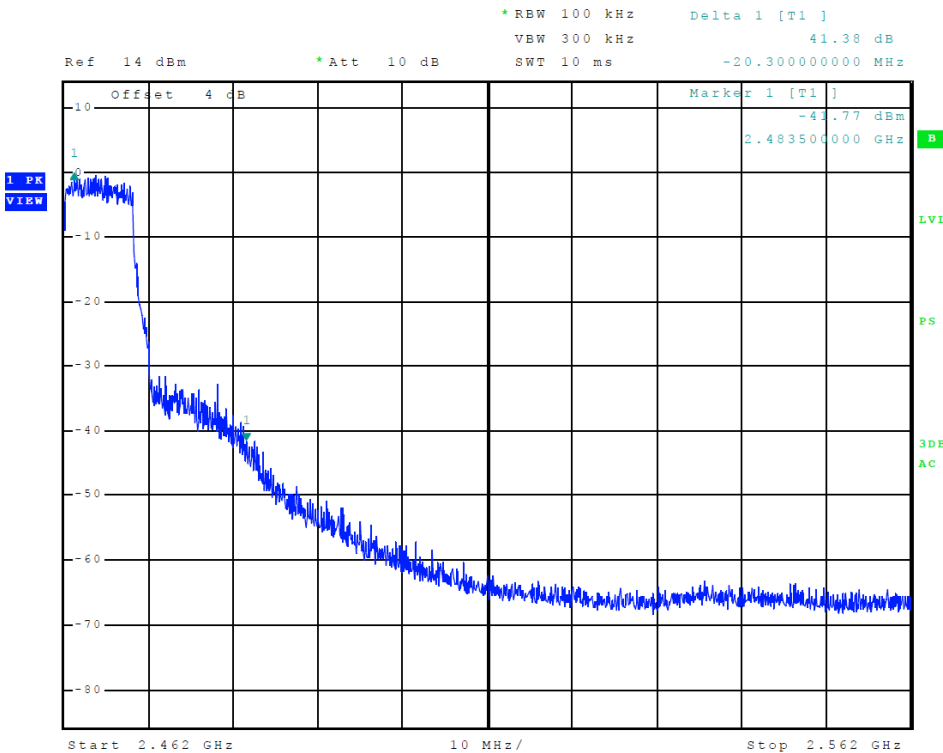

Figure 14 Plot of Upper Band Edge (802.11 g-mode)

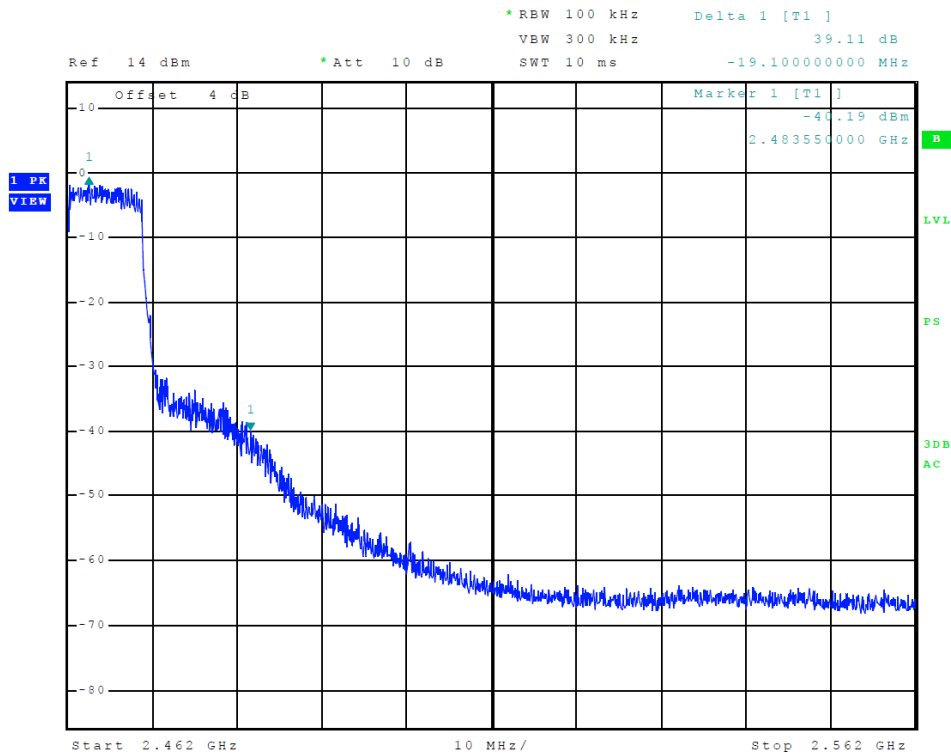

Figure 15 Plot of Upper Band Edge (802.11 n-mode)

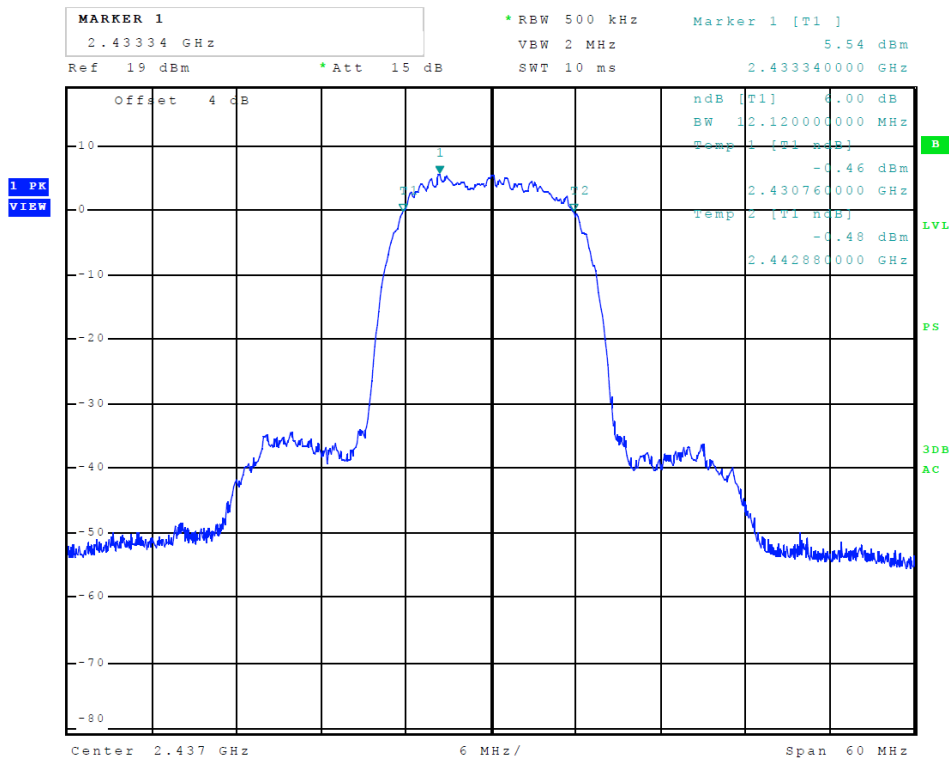

Figure 16 Plot of Transmitter 6-dB Occupied Bandwidth (802.11 b-mode)

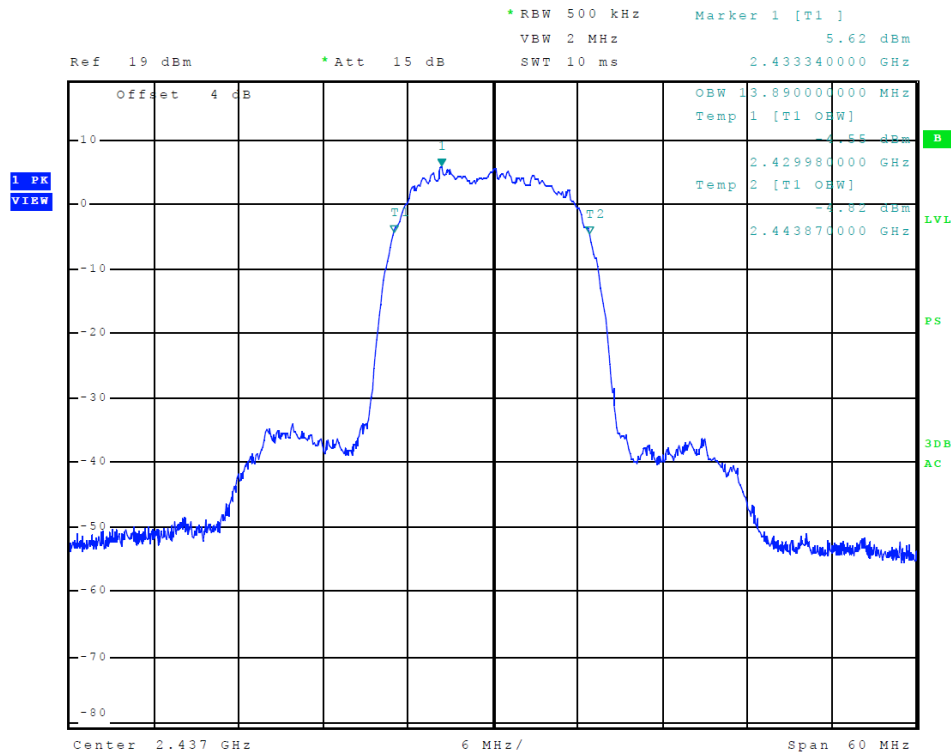

Figure 17 Plot of Transmitter 99% Occupied Bandwidth (802.11 b-mode)

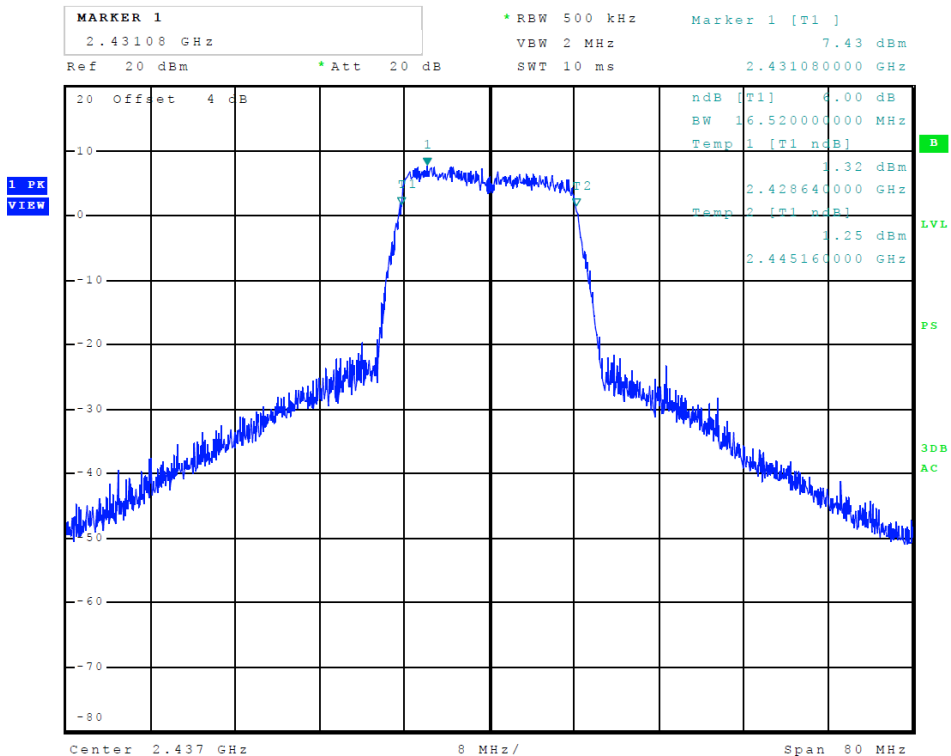

Figure 18 Plot of Transmitter 6-dB Occupied Bandwidth (802.11 g-mode)

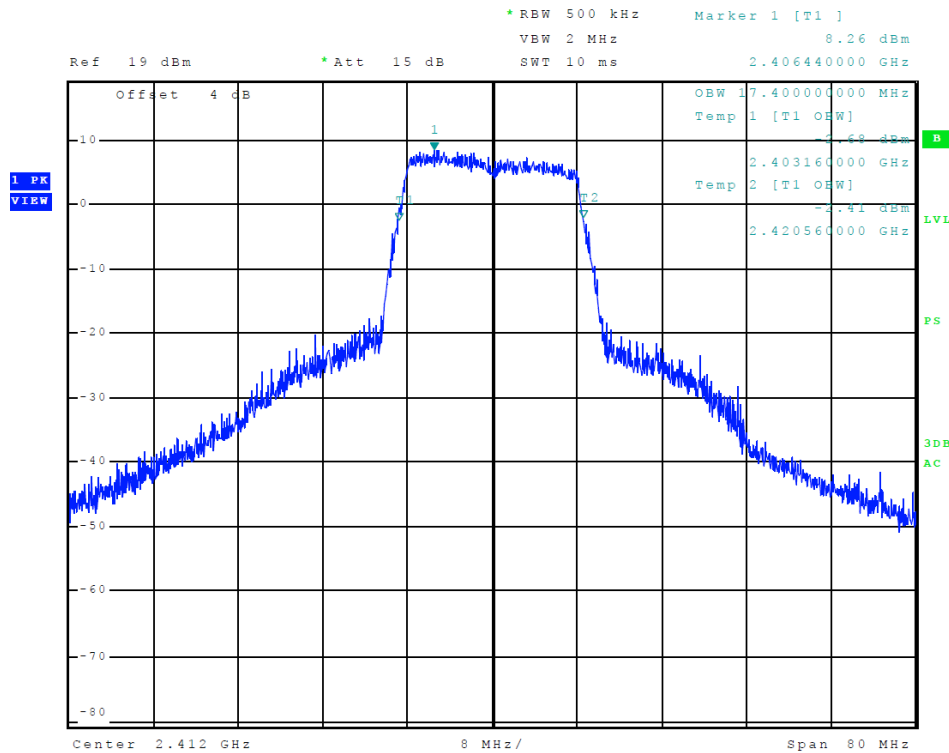

Figure 19 Plot of Transmitter 99% Occupied Bandwidth (802.11 g-mode)

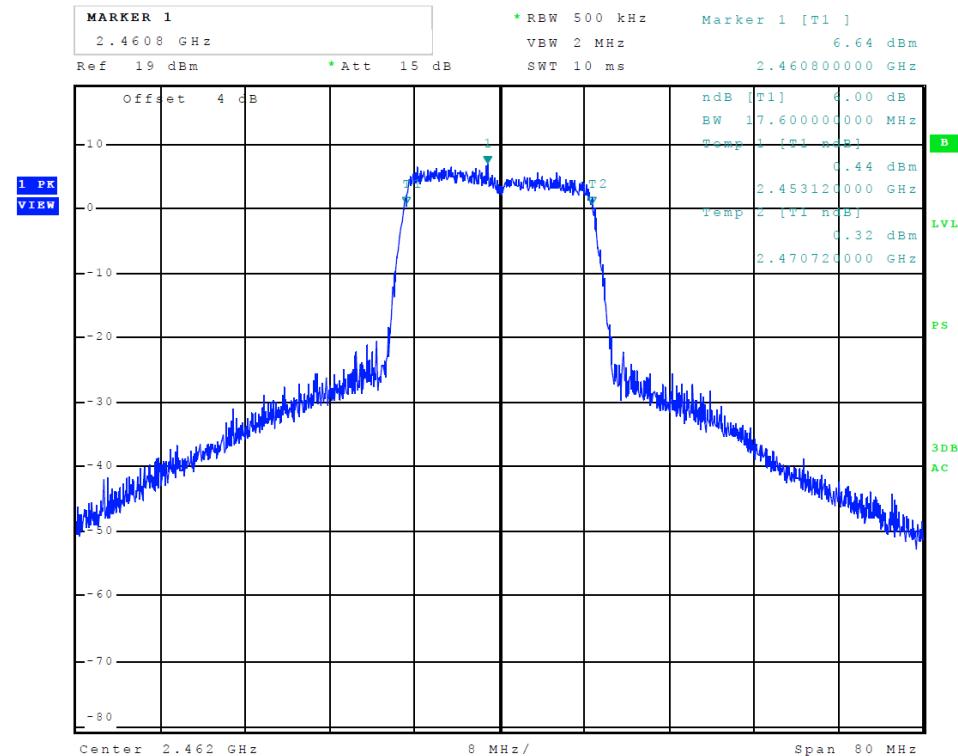

Figure 20 Plot of Transmitter 6-dB Occupied Bandwidth (802.11 n-mode)

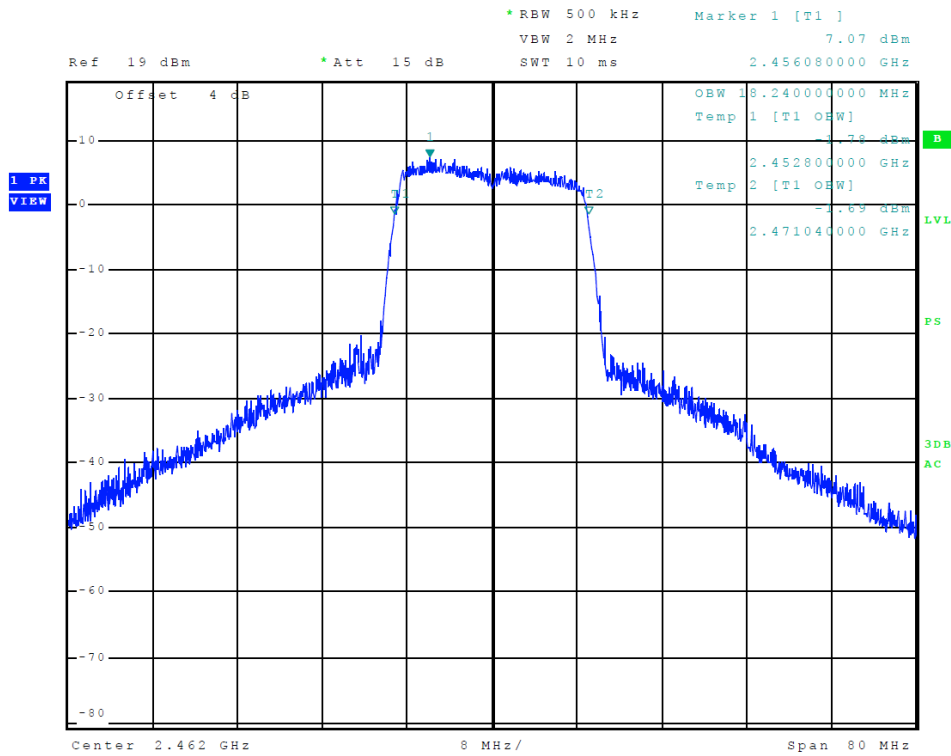

Figure 21 Plot of Transmitter 99% Occupied Bandwidth (802.11 n-mode)

Transmitter Emissions Data

Table 9 Transmitter Radiated Emission Worst-case Data

Frequency in MHz	Horizontal Peak (dBµV/m)	Horizontal Average (dBµV/m)	Vertical Peak (dBµV/m)	Vertical Average (dBµV/m)	Limit @ 3m (dBµV/m)
2412.0	--	--	--	--	--
4824.0	42.5	29.5	45.0	31.7	54.0
7236.0	46.0	33.3	47.5	34.3	54.0
9648.0	46.3	33.3	47.7	35.8	54.0
12060.0	48.3	35.6	50.3	37.5	54.0
14472.0	50.4	37.2	49.1	36.2	54.0
16884.0	52.2	39.2	52.9	39.8	54.0
2437.0	--	--	--	--	--
4874.0	46.4	32.8	44.9	31.9	54.0
7311.0	46.5	33.2	45.6	32.8	54.0
9748.0	45.7	32.2	49.1	37.9	54.0
12185.0	49.1	35.8	48.8	36.2	54.0
14622.0	50.3	37.5	49.3	36.3	54.0
17059.0	53.9	40.7	53.7	40.7	54.0
2462.0	--	--	--	--	--
4924.0	43.7	30.5	42.8	30.2	54.0
7386.0	45.9	32.8	46.1	32.6	54.0
9848.0	47.7	34.5	48.0	34.9	54.0
12310.0	50.5	36.6	49.2	36.2	54.0
14772.0	51.6	38.2	51.0	38.1	54.0
17234.0	51.6	38.7	52.4	39.9	54.0

Other emissions present had amplitudes at least 20 dB below the limit. Peak and Quasi-Peak amplitude emissions are recorded for frequency below 1000 MHz. Peak and Average amplitude emissions are recorded for frequency range above 1000 MHz.

Table 11 Transmitter Antenna Port Data

Frequency MHz	Antenna Port Average Output Peak (Watts)	99% Occupied Bandwidth (kHz)	6-dB Occupied Bandwidth (kHz)	Power Spectral Density (dBm/3kHz)
802.11b				
2412	0.015	13890.0	12120.0	-12.42
2437	0.016	13890.0	12120.0	-12.63
2462	0.014	13890.0	12090.0	-12.63
802.11g				
2412	0.022	17400.0	16320.0	-12.00
2437	0.020	17360.0	16520.0	-13.03
2462	0.018	17400.0	16360.0	-12.51
802.11n				
2412	0.020	18160.0	17480.0	-12.94
2437	0.019	18160.0	17600.0	-13.70
2462	0.018	18240.0	17600.0	-13.84

Summary of Results for Transmitter Radiated Emissions of Intentional Radiator

The EUT demonstrated compliance with the radiated emissions requirements of CFR47 Part 15.247, RSS-GEN, and RSS-247 Digital Transmission Systems. Antenna port conducted output power of 0.022 Watts was measured at the temporary antenna port of the EUT. The average power spectral density measured at the antenna port presented a minimum margin of -20.0 dB below the requirements. The EUT demonstrated a minimum margin of -13.3 dB below the harmonic emissions requirements. There were no other significantly measurable emissions in the restricted bands other than those recorded in this report. Other emissions were present with amplitudes at least 20 dB below the requirements. There were no other deviations or exceptions to the requirements.

Annex

- Annex A Measurement Uncertainty Calculations
- Annex B Rogers Labs Test Equipment List
- Annex C Rogers Qualifications
- Annex D Rogers Labs Certificate of Accreditation

Annex A Measurement Uncertainty Calculations

Measurement uncertainty calculations were made for the laboratory. Result of measurement uncertainty calculations are recorded below for AC line conducted and radiated emission measurements.

Measurement Uncertainty	$U_{(E)}$	$U_{(lab)}$
3 Meter Horizontal 30-200 MHz Measurements	2.08	4.16
3 Meter Vertical 30-200 MHz Measurements	2.16	4.33
3 Meter Vertical Measurements 200-1000 MHz	2.99	5.97
10 Meter Horizontal Measurements 30-200 MHz	2.07	4.15
10 Meter Vertical Measurements 30-200 MHz	2.06	4.13
10 Meter Horizontal Measurements 200-1000 MHz	2.32	4.64
10 Meter Vertical Measurements 200-1000 MHz	2.33	4.66
3 Meter Measurements 1-6 GHz	2.57	5.14
3 Meter Measurements 6-18 GHz	2.58	5.16
AC Line Conducted	1.72	3.43

Annex B Rogers Labs Test Equipment List

List of Test Equipment	Calibration	Date	Due
Spectrum Analyzer: Rohde & Schwarz ESU40		5/17	5/18
Spectrum Analyzer: HP 8562A, HP Adapters: 11518, 11519, and 11520		5/17	5/18
Mixers: 11517A, 11970A, 11970K, 11970U, 11970V, 11970W			
Spectrum Analyzer: HP 8591EM		5/17	5/18
Antenna: EMCO Biconilog Model: 3143		5/17	5/18
Antenna: Sunol Biconilog Model: JB6		10/17	10/18
Antenna: EMCO Log Periodic Model: 3147		10/17	10/18
Antenna: Com Power Model: AH-118		10/17	10/18
Antenna: Com Power Model: AH-840		5/17	5/18
Antenna: Antenna Research Biconical Model: BCD 235		10/17	10/18
Antenna: Com Power Model: AL-130		10/17	10/18
Antenna: EMCO 6509		10/17	10/18
LISN: Compliance Design Model: FCC-LISN-2.Mod.cd, 50 μ Hy/50 ohms/0.1 μ f		10/17	10/18
R.F. Preamp CPPA-102		10/17	10/18
Attenuator: HP Model: HP11509A		10/17	10/18
Attenuator: Mini Circuits Model: CAT-3		10/17	10/18
Attenuator: Mini Circuits Model: CAT-3		10/17	10/18
Cable: Belden RG-58 (L1)		10/17	10/18
Cable: Belden RG-58 (L2)		10/17	10/18
Cable: Belden 8268 (L3)		10/17	10/18
Cable: Time Microwave: 4M-750HF290-750		10/17	10/18
Cable: Time Microwave: 10M-750HF290-750		10/17	10/18
Frequency Counter: Leader LDC825		2/17	2/18
Oscilloscope Scope: Tektronix 2230		2/17	2/18
Wattmeter: Bird 43 with Load Bird 8085		2/17	2/18
Power Supplies: Sorensen SRL 20-25, SRL 40-25, DCR 150, DCR 140		2/17	2/18
R.F. Generators: HP 606A, HP 8614A, HP 8640B		2/17	2/18
R.F. Power Amp 65W Model: 470-A-1010		2/17	2/18
R.F. Power Amp 50W M185- 10-501		2/17	2/18
R.F. Power Amp A.R. Model: 10W 1010M7		2/17	2/18
R.F. Power Amp EIN Model: A301		2/17	2/18
LISN: Compliance Eng. Model 240/20		2/17	2/18
LISN: Fischer Custom Communications Model: FCC-LISN-50-16-2-08		2/17	2/18
Antenna: EMCO Dipole Set 3121C		2/17	2/18
Antenna: C.D. B-101		2/17	2/18
Antenna: Solar 9229-1 & 9230-1		2/17	2/18
Audio Oscillator: H.P. 201CD		2/17	2/18
ESD Test Set 2010i		2/17	2/18
Fast Transient Burst Generator Model: EFT/B-101		2/17	2/18
Field Intensity Meter: EFM-018		2/17	2/18
KEYTEK Ecat Surge Generator		2/17	2/18
Shielded Room 5 M x 3 M x 3.0 M			

Annex C Rogers Qualifications

Scot D. Rogers, Engineer

Rogers Labs, Inc.

Mr. Rogers has approximately 17 years' experience in the field of electronics. Engineering experience includes six years in the automated controls industry and remaining years working with the design, development and testing of radio communications and electronic equipment.

Positions Held

Systems Engineer: A/C Controls Mfg. Co., Inc. 6 Years

Electrical Engineer: Rogers Consulting Labs, Inc. 5 Years

Electrical Engineer: Rogers Labs, Inc. Current

Educational Background

- 1) Bachelor of Science Degree in Electrical Engineering from Kansas State University.
- 2) Bachelor of Science Degree in Business Administration Kansas State University.
- 3) Several Specialized Training courses and seminars pertaining to Microprocessors and Software programming.

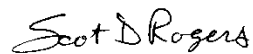

Scot D. Rogers

Annex D Rogers Labs Certificate of Accreditation

<p>United States Department of Commerce National Institute of Standards and Technology</p>  <hr/> <p>Certificate of Accreditation to ISO/IEC 17025:2005</p> <hr/> <p>NVLAP LAB CODE: 200087-0</p> <p>Rogers Labs, Inc. Louisburg, KS</p> <p><i>is accredited by the National Voluntary Laboratory Accreditation Program for specific services, listed on the Scope of Accreditation, for:</i></p> <p>Electromagnetic Compatibility & Telecommunications</p> <p><i>This laboratory is accredited in accordance with the recognized International Standard ISO/IEC 17025:2005. This accreditation demonstrates technical competence for a defined scope and the operation of a laboratory quality management system (refer to joint ISO-ILAC-IAF Communique dated January 2009).</i></p> <hr/> <table border="0" style="width: 100%;"><tr><td style="width: 33%; text-align: center;"><p>2017-03-01 through 2018-03-31 <i>Effective Dates</i></p></td><td style="width: 33%; text-align: center;"></td><td style="width: 33%; text-align: center;"> <i>For the National Voluntary Laboratory Accreditation Program</i></td></tr></table>			<p>2017-03-01 through 2018-03-31 <i>Effective Dates</i></p>		 <i>For the National Voluntary Laboratory Accreditation Program</i>
<p>2017-03-01 through 2018-03-31 <i>Effective Dates</i></p>		 <i>For the National Voluntary Laboratory Accreditation Program</i>			

Rogers Labs, Inc.
4405 West 259th Terrace
Louisburg, KS 66053
Phone/Fax: (913) 837-3214
Revision 1

Garmin International, Inc.
Model: A03272
Test #: 170828 1206
Test to: CFR47 15C, RSS-Gen RSS-247
File: A03272 DTS TstRpt 170828 1206

SN's: 3959315045 / 5054
FCC ID: IPH-03272
IC: 1792A-03272
Date: January 12, 2018
Page 41 of 41