

Application For Grant of Certification

Model: A03220
2402-2480 MHz
47CFR 15.249 and RSS-210
Low Power Transmitter

FCC ID: IPH-03220
IC: 1792A-03220

FOR

Garmin International, Inc.

1200 East 151st Street
Olathe, KS 66062

FCC Site Registration: 90910, 315994
IC Test Site Registration: 3041A-1
Test Report Number: 170612

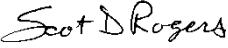
Authorized Signatory: 
Scot D. Rogers

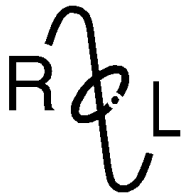

ROGERS LABS, INC.

4405 West 259th Terrace
Louisburg, KS 66053
Phone / Fax (913) 837-3214

Engineering Test Report For Grant of Certification Application

FOR
47 CFR, PART 15C - Intentional Radiators Paragraph 15.249 and
Industry Canada RSS-210 Issue 9, RSS-GEN Issue 4
License Exempt Intentional Radiator

For
Garmin International, Inc.

1200 East 151st Street
Olathe, KS 66062

Model: A03220

Low Power Transmitter

Frequency Range 2402-2480 MHz
FCC ID#: IPH-03220
IC: 1792A-03220

Test Date: June 12, 2017

Certifying Engineer: *Scot D. Rogers*
Scot D. Rogers
Rogers Labs, Inc.
4405 West 259th Terrace
Louisburg, KS 66053
Telephone/Facsimile: (913) 837-3214

This report shall not be reproduced except in full, without the written approval of the laboratory. This report must not be used by the client to claim product certification, approval, or endorsement by NVLAP, NIST, or any agency of the Federal Government.

Rogers Labs, Inc.
4405 West 259th Terrace
Louisburg, KS 66053
Phone/Fax: (913) 837-3214
Revision 1

Garmin International, Inc.
Model: A03220
Test #: 170612
Test to: CFR47 15C, RSS-Gen, RSS-210
File: A03220 TstRpt 170612

SN's: 91606 / 91588
FCC ID: IPH-03220
IC: 1792A-03220
Date: July 18, 2017
Page 2 of 29

Table Of Contents

TABLE OF CONTENTS.....	3
REVISIONS.....	4
FOREWORD.....	5
OPINION / INTERPRETATION OF RESULTS	5
EQUIPMENT TESTED.....	5
Equipment Function	6
Equipment Configuration.....	6
APPLICATION FOR CERTIFICATION.....	7
APPLICABLE STANDARDS & TEST PROCEDURES	8
EQUIPMENT TESTING PROCEDURES	8
AC Line Conducted Emission Test Procedure	8
Radiated Emission Test Procedure.....	8
Diagram 1 Test arrangement for radiated emissions of tabletop equipment.....	9
Diagram 2 Test arrangement for radiated emissions tested on Open Area Test Site (OATS).....	10
TEST SITE LOCATIONS	10
LIST OF TEST EQUIPMENT	11
UNITS OF MEASUREMENTS	12
ENVIRONMENTAL CONDITIONS.....	12
STATEMENT OF MODIFICATIONS AND DEVIATIONS	12
INTENTIONAL RADIATORS.....	12
Antenna Requirements	12
Restricted Bands of Operation.....	13
Table 1 Radiated Emissions in Restricted Frequency Bands Data (ANT Worst-case).....	13
Table 2 Radiated Emissions in Restricted Frequency Bands Data (BT Worst-case).....	14

Summary of Results for Radiated Emissions in Restricted Bands14

General Radiated Emissions Procedure.....15

 Table 3 General Radiated Emissions Data15

Summary of Results for General Radiated Emissions16

Operation in the Band 2400 – 2483.5 MHz16

 Figure 1 Plot of Transmitter Emissions (Operation in 2402-2480 MHz, ANT GFSK).....17

 Figure 2 Plot of Transmitter Emissions (99% Occupied Bandwidth, ANT)17

 Figure 3 Plot of Transmitter Emissions (Low Band Edge, ANT).....18

 Figure 4 Plot of Transmitter Emissions (High Band Edge, ANT).....18

 Figure 5 Plot of Transmitter Emissions (Operation in 2402-2480 MHz, BLE).....19

 Figure 6 Plot of Transmitter Emissions (99% Occupied Bandwidth, BLE)19

 Figure 7 Plot of Transmitter Emissions (Low Band Edge, BLE)20

 Figure 8 Plot of Transmitter Emissions (High Band Edge, BLE).....20

Transmitter Emissions Data.....21

 Table 4 Transmitter Radiated Emissions (Worst-case) ANT21

 Table 5 Transmitter Radiated Emissions (Worst-case) BLE22

Summary of Results for Transmitter Radiated Emissions of Intentional Radiator23

ANNEX..... 24

Annex A Measurement Uncertainty Calculations.....25

Annex B Rogers Labs Test Equipment List.....26

Annex C Rogers Qualifications27

Annex D FCC Site Registration Letter28

Annex E Industry Canada Site Registration Letter29

Revisions

Revision 1 Issued July 18, 2017

Foreword

The following information is submitted for consideration in obtaining Grant of Certification for low power intentional radiator per 47 CFR Paragraph 15.249, Industry Canada RSS-210 Issue 9 and RSS-GEN Issue 4, low power digital device transmitter operations in the 2400 – 2483.5 MHz frequency band.

Name of Applicant: Garmin International, Inc.
1200 East 151st Street
Olathe, KS 66062

M/N: A03220 HVID: PMN:

FCC ID: IPH-03220 IC: 1792A-03220

Operating power: 2402-2480 MHz Maximum Average power ANT 90.2 dB μ V/m @ 3 meters, BLE 83.3 dB μ V/m @ 3, (and peak 92.1 dB μ V/m @ 3 meters), [99% OBW, ANT 934.0 kHz, BLE 1,060.0 kHz]

Opinion / Interpretation of Results

Tests Performed	Margin (dB)	Results
Restricted Bands 47CFR 15.205, RSS-210 2.2	-17.2	Complies
AC Line Conducted 47CFR 15.207, RSS-GEN 8.8	N/A	Complies
Radiated Emissions 47CFR 15.209, RSS-GEN 8.9	-14.9	Complies
Harmonic Emissions per 47CFR 15.249, RSS-210 A2.9	-11.6	Complies

Equipment Tested

<u>Equipment</u>	<u>Model / PN</u>	<u>Serial Number</u>
EUT #1	A03220	91606
EUT #2	A03220	91588

Test results in this report relate only to the items tested.

Equipment Function

The EUT is a bicycle pedal mounted transducer incorporating low power transmitter. The transmitter offers short-range communications in the 2400-2480 MHz frequency band. The design provides communication capability with compatible equipment. The design provides communications in two modulation modes ANT and BLE. The EUT was arranged as the manufacturer directed for testing purposes. The EUT operates from internal replaceable batteries only and offers no provision for connection to external power sources. Two samples were offered for test, sample 1 representing production sample and sample 2 modified to provide access to antenna port for antenna port conducted measurements. As requested by the manufacturer and required by regulations, the equipment was tested for emissions compliance using the available configurations with the worst-case data presented. Test results in this report relate only to the products described in this report.

Equipment Configuration

Unit powered by internal battery transmitting ANT+/BLE wireless data @ 2.4 GHz

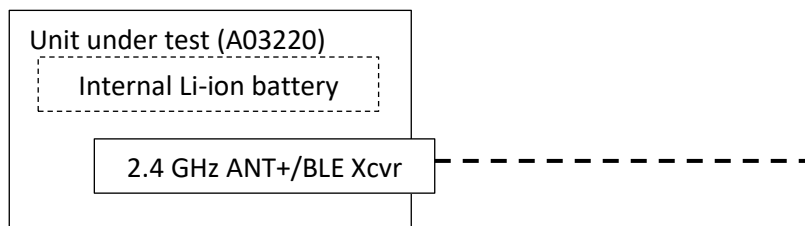

Application for Certification

- (1) Manufacturer: Garmin International, Inc.
1200 East 151st Street
Olathe, KS 66062
- (2) Identification: M/N: A03220 HVIN: PMN:
FCC ID: IPH-03220 IC: 1792A-03220
- (3) Instruction Book:
Refer to Exhibit for Instruction Manual.
- (4) Description of Circuit Functions:
Refer to Exhibit of Operational Description.
- (5) Block Diagram with Frequencies:
Refer to Exhibit of Operational Description.
- (6) Report of Measurements:
Report of measurements follows in this Report.
- (7) Photographs: Construction, Component Placement, etc.:
Refer to Exhibit for photographs of equipment.
- (8) List of Peripheral Equipment Necessary for operation. The equipment operates from direct current power provided from internal replaceable battery only. The EUT offers no other power option or connection ports than those presented in this filing.
- (9) Transition Provisions of CFR47 15.37 are not requested.
- (10) Not Applicable. The unit is not a scanning receiver.
- (11) Not Applicable. The EUT does not operate in the 59 – 64 GHz frequency band.
- (12) The equipment is not software defined and this section is not applicable.
- (13) Applications for certification of U-NII devices in the 5.15-5.35 GHz and the 5.47-5.85 GHz bands must include a high-level operational description of the security procedures that control the radio frequency operating parameters and ensure that unauthorized modifications cannot be made. This requirement is not applicable to his DTS device.
- (14) Contain at least one drawing or photograph showing the test set-up for each of the required types of tests applicable to the device for which certification is requested. These drawings or photographs must show enough detail to confirm other information contained in the test report. Any photographs used must be focused originals without glare or dark spots and must clearly show the test configuration used. This information is provide in this report and Test Setup Exhibits provided with the application filing.

Applicable Standards & Test Procedures

In accordance with the Federal Communications Code of Federal Regulations, dated June 12, 2017: Part 2, Subpart J, Paragraphs 2.907, 2.911, 2.913, 2.925, 2.926, 2.1031 through 2.1057, and applicable parts of paragraph 15, Part 15C Paragraph 15.249, Industry Canada RSS-210 issue 9, and RSS-GEN issue 4 operation in the 2400 – 2483.5 MHz Frequency band. Test procedures used are the established Methods of Measurement of Radio-Noise Emissions as described in ANSI C63.10-2013.

Equipment Testing Procedures

AC Line Conducted Emission Test Procedure

The EUT operates solely from direct current power supplied from replaceable batteries. Therefore, no AC line conducted emissions testing was required or performed.

Radiated Emission Test Procedure

The EUT was placed on a rotating 0.9 x 1.2-meter platform, elevated as required above the ground plane at a distance of 3 meters from the FSM antenna. Radiated emissions testing was performed as required in the regulations and specified in ANSI C63.10-2013. EMI energy was maximized by equipment placement permitting orientation in three orthogonal axes, raising and lowering the FSM antenna, changing the antenna polarization, and by rotating the turntable. Each emission was maximized before data was taken and recorded. The frequency spectrum from 9 kHz to 25,000 MHz was searched for emissions during preliminary investigation. Refer to diagrams one and two showing typical test setup. Refer to photographs in the test setup exhibits for specific EUT placement during testing.

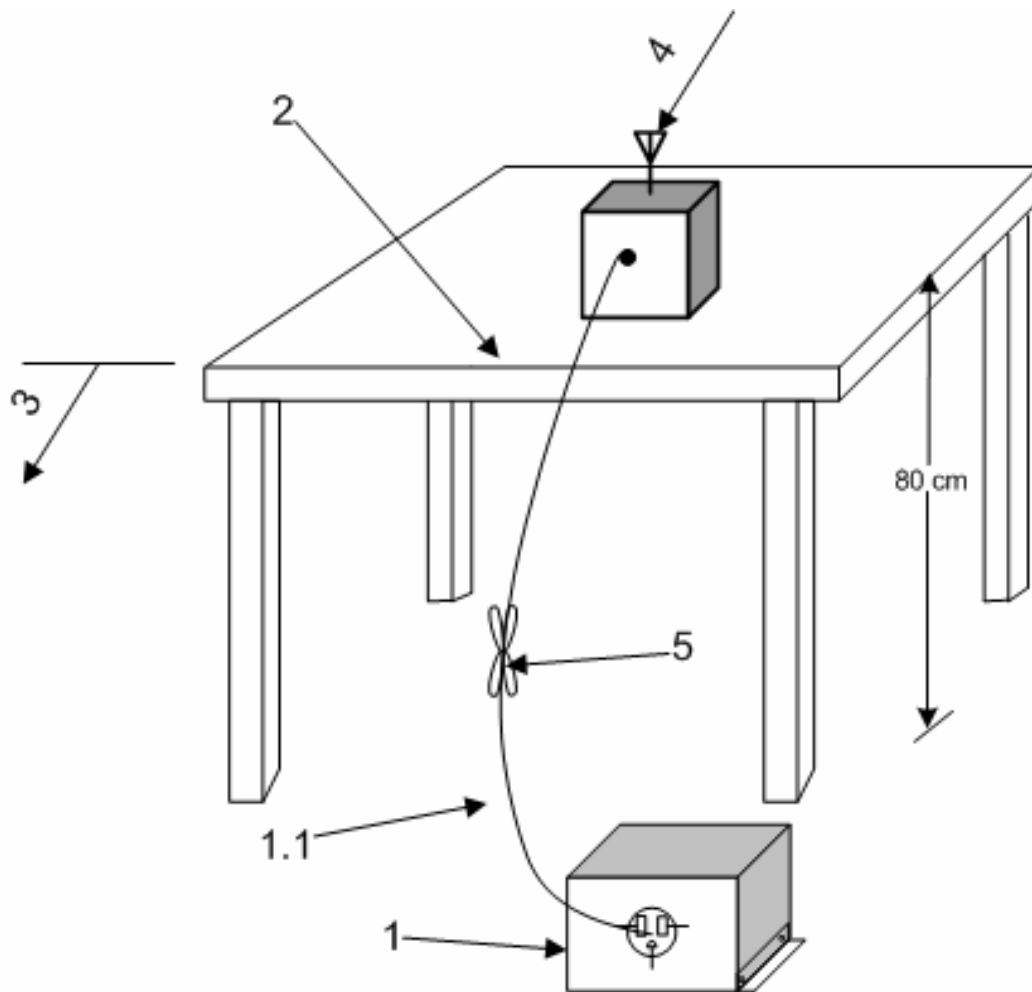

1—A LISN is optional for radiated measurements between 30 MHz and 1000 MHz but not allowed for measurements below 30 MHz and above 1000 MHz (see 6.3.1). If used, then connect EUT to one LISN. Unused LISN measuring port connectors shall be terminated in 50 Ω loads. The LISN may be placed on top of, or immediately beneath, the reference ground plane (see 6.2.2 and 6.2.3.2).

1.1—LISN spaced at least 80 cm from the nearest part of the EUT chassis.

2—Antenna can be integral or detachable, depending on the EUT (see 6.3.1).

3—Interconnecting cables that hang closer than 40 cm to the ground plane shall be folded back and forth in the center forming a bundle 30 cm to 40 cm long (see 6.3.1).

4—For emission measurements at or below 1 GHz, the table height shall be 80 cm. For emission measurements above 1 GHz, the table height shall be 1.5 m for measurements, except as otherwise specified (see 6.3.1 and 6.6.3.1).

Diagram 1 Test arrangement for radiated emissions of tabletop equipment

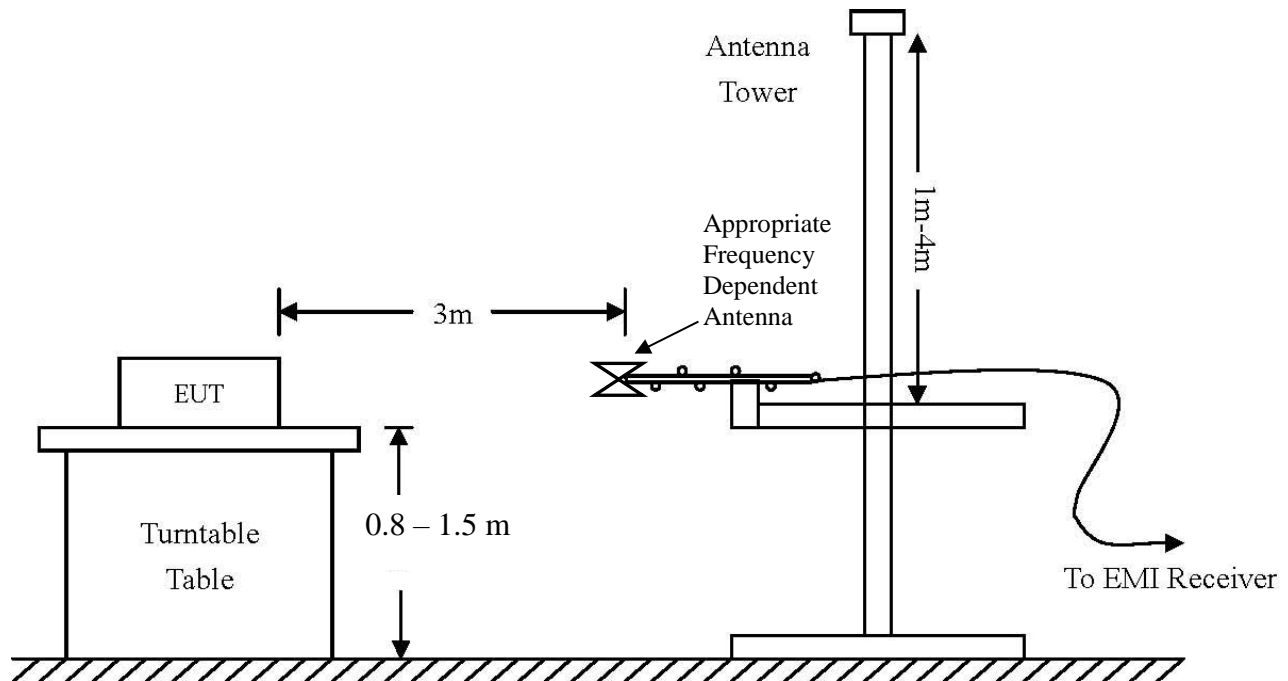

Diagram 2 Test arrangement for radiated emissions tested on Open Area Test Site (OATS)

Test Site Locations

Conducted EMI The AC power line conducted emissions testing performed in a shielded screen room located at Rogers Labs, Inc., 4405 West 259th Terrace, Louisburg, KS

Radiated EMI The radiated emissions tests were performed at the 3 meters, Open Area Test Site (OATS) located at Rogers Labs, Inc., 4405 West 259th Terrace, Louisburg, KS

Site Registration Refer to Annex for Site Registration Letters

NVLAP Accreditation Lab code 200087-0

List of Test Equipment

A Rohde and Schwarz ESU40 and/or Hewlett Packard 8591EM was used as the measuring device for the emissions testing of frequencies below 1 GHz. A Rohde and Schwarz ESU40 and/or Hewlett Packard 8562A Spectrum Analyzer was used as the measuring device for testing the emissions at frequencies above 1 GHz. The analyzer settings used are described in the following table. Refer to the appendix for a complete list of test equipment.

AC Line Conducted Emissions (0.150 -30 MHz)		
RBW	AVG. BW	Detector Function
9 kHz	30 kHz	Peak / Quasi Peak
Emissions (30-1000 MHz)		
RBW	AVG. BW	Detector Function
120 kHz	300 kHz	Peak / Quasi Peak
Emissions (Above 1000 MHz)		
RBW	Video BW	Detector Function
100 kHz	100 kHz	Peak
1 MHz	1 MHz	Peak / Average

<u>Equipment</u>	<u>Manufacturer</u>	<u>Model (SN)</u>	<u>Band</u>	<u>Cal Date</u>	<u>Due</u>
<input type="checkbox"/> LISN	FCC	FCC-LISN-50-2-10(1PA) (160611)	.15-30MHz	5/17	5/18
<input checked="" type="checkbox"/> Cable	Time Microwave	750HF290-750 (L10M)	9kHz-40 GHz	10/16	10/17
<input type="checkbox"/> Cable	Belden	RG-58 (L1-CAT3-11509)	9kHz-30 MHz	10/16	10/17
<input type="checkbox"/> Cable	Belden	RG-58 (L2-CAT3-11509)	9kHz-30 MHz	10/16	10/17
<input type="checkbox"/> Antenna	ARA	BCD-235-B (169)	20-350MHz	10/16	10/17
<input type="checkbox"/> Antenna	EMCO	3147 (40582)	200-1000MHz	10/16	10/17
<input checked="" type="checkbox"/> Antenna	ETS-Lindgren	3117 (200389)	1-18 GHz	5/17	5/18
<input type="checkbox"/> Antenna	Com Power	AH-118 (10110)	1-18 GHz	10/15	10/17
<input checked="" type="checkbox"/> Antenna	Com Power	AH-840 (101046)	18-40 GHz	5/17	5/18
<input checked="" type="checkbox"/> Antenna	Com Power	AL-130 (121055)	.001-30 MHz	10/16	10/17
<input checked="" type="checkbox"/> Antenna	Sunol	JB-6 (A100709)	30-1000 MHz	10/16	10/17
<input type="checkbox"/> Antenna	EMCO	3143 (9607-1277)	20-1200 MHz	5/17	5/18
<input type="checkbox"/> Analyzer	HP	8591EM (3628A00871)	9kHz-1.8GHz	5/17	5/18
<input type="checkbox"/> Analyzer	HP	8562A (3051A05950)	9kHz-110GHz	5/17	5/18
<input type="checkbox"/> Analyzer	HP External Mixers	11571, 11970	25GHz-110GHz	5/17	5/18
<input checked="" type="checkbox"/> Analyzer	Rohde & Schwarz	ESU40 (100108)	20Hz-40GHz	5/17	5/18
<input checked="" type="checkbox"/> Amplifier	Com-Power	PA-010 (171003)	100Hz-30MHz	10/16	10/17
<input checked="" type="checkbox"/> Amplifier	Com-Power	CPPA-102 (01254)	1-1000 MHz	10/16	10/17
<input checked="" type="checkbox"/> Amplifier	Com-Power	PAM-118A (551014)	0.5-18 GHz	10/16	10/17
<input type="checkbox"/> Power Meter	Agilent	N1911A with N1921A	0.05-18 GHz	5/17	5/18

Rogers Labs, Inc.
4405 West 259th Terrace
Louisburg, KS 66053
Phone/Fax: (913) 837-3214
Revision 1

Garmin International, Inc.
Model: A03220
Test #: 170612
Test to: CFR47 15C, RSS-Gen, RSS-210
File: A03220 TstRpt 170612

SN's: 91606 / 91588
FCC ID: IPH-03220
IC: 1792A-03220
Date: July 18, 2017
Page 11 of 29

Units of Measurements

Conducted EMI Data is in dB μ V; dB referenced to one microvolt

Radiated EMI Data is in dB μ V/m; dB/m referenced to one microvolt per meter

Sample Calculation:

RFS = Radiated Field Strength, FSM = Field Strength Measured

A.F. = Receive antenna factor, Gain = amplification gains and/or cable losses

RFS (dB μ V/m @ 3m) = FSM (dB μ V) + A.F. (dB) - Gain (dB)

Environmental Conditions

Ambient Temperature 22.7° C

Relative Humidity 50%

Atmospheric Pressure 1012.1 mb

Statement of Modifications and Deviations

No modifications to the EUT were required for the equipment to demonstrate compliance with the CFR47 Part 15C, Industry Canada RSS-210 Issue 9, and RSS-GEN emission requirements. There were no deviations to the specifications.

Intentional Radiators

The following information is submitted in support demonstration of compliance with the requirements of 47CFR, Subpart C, paragraph 15.249, Industry Canada RSS-210 Issue 9 and RSS-GEN Issue 4.

Antenna Requirements

The EUT incorporates integral antenna system. Production equipment offers no provision for connection to alternate antenna system. The antenna connection point complies with the unique antenna connection requirements. There are no deviations or exceptions to the specification.

Restricted Bands of Operation

Spurious emissions falling in the restricted frequency bands of operation were measured at the OATS. The EUT utilizes frequency, determining circuitry, which generates harmonics falling in the restricted bands. Emissions were investigated at the OATS, using appropriate antennas or pyramidal horns, amplification stages, and a spectrum analyzer. Peak and average amplitudes of frequencies above 1000 MHz were compared to the required limits with worst-case data presented below. Test procedures of ANSI C63.10-2013 were used during testing. No other significant emission was observed which fell into the restricted bands of operation. Computed emission values take into account the received radiated field strength, receive antenna correction factor, amplifier gain stage, and test system cable losses.

Table 1 Radiated Emissions in Restricted Frequency Bands Data (ANT Worst-case)

Frequency in MHz	Horizontal Peak (dB μ V/m)	Horizontal Quasi-Peak (dB μ V/m)	Horizontal Average (dB μ V/m)	Vertical Peak (dB μ V/m)	Vertical Quasi-Peak (dB μ V/m)	Vertical Average (dB μ V/m)	Limit @ 3m (dB μ V/m)
2390.0	45.3	N/A	28.7	41.8	N/A	28.7	54.0
2483.5	49.7	N/A	30.0	45.7	N/A	29.3	54.0
4804.0	45.0	N/A	32.3	44.3	N/A	31.6	54.0
4882.0	45.5	N/A	32.5	45.2	N/A	32.2	54.0
4960.0	44.9	N/A	32.0	45.3	N/A	32.4	54.0
7206.0	45.5	N/A	32.4	45.9	N/A	34.0	54.0
7323.0	46.1	N/A	33.0	45.9	N/A	33.6	54.0
7440.0	46.3	N/A	33.4	46.7	N/A	34.5	54.0
12010.0	49.2	N/A	36.6	49.7	N/A	36.8	54.0
12205.0	49.2	N/A	36.0	49.1	N/A	35.9	54.0
12400.0	49.8	N/A	36.6	49.8	N/A	36.7	54.0

Other emissions present had amplitudes at least 20 dB below the limit. Peak and Quasi-Peak amplitude emissions are recorded for frequency range below 1000 MHz. Peak and Average amplitude emissions are recorded for frequency range above 1000 MHz.

Table 2 Radiated Emissions in Restricted Frequency Bands Data (BT Worst-case)

Frequency in MHz	Horizontal Peak (dBμV/m)	Horizontal Quasi-Peak (dBμV/m)	Horizontal Average (dBμV/m)	Vertical Peak (dBμV/m)	Vertical Quasi-Peak (dBμV/m)	Vertical Average (dBμV/m)	Limit @ 3m (dBμV/m)
2390.0	41.6	N/A	28.7	41.5	N/A	28.7	54.0
2483.5	47.1	N/A	29.3	42.7	N/A	29.1	54.0
4804.0	43.1	N/A	31.0	44.2	N/A	31.2	54.0
4880.0	44.5	N/A	31.7	45.1	N/A	31.4	54.0
4960.0	44.2	N/A	31.5	44.2	N/A	31.6	54.0
7206.0	46.0	N/A	33.1	45.8	N/A	33.1	54.0
7320.0	42.2	N/A	29.2	49.4	N/A	35.6	54.0
7440.0	47.1	N/A	33.9	47.0	N/A	34.2	54.0
12010.0	49.1	N/A	36.3	49.1	N/A	36.3	54.0
12200.0	48.4	N/A	35.6	48.1	N/A	35.4	54.0
12400.0	49.4	N/A	36.6	50.4	N/A	36.6	54.0

Other emissions present had amplitudes at least 20 dB below the limit. Peak and Quasi-Peak amplitude emissions are recorded for frequency range below 1000 MHz. Peak and Average amplitude emissions are recorded for frequency range above 1000 MHz.

Summary of Results for Radiated Emissions in Restricted Bands

The EUT demonstrated compliance with the radiated emissions requirements of 47CFR Part 15C and RSS-210 Intentional Radiator requirements. The EUT ANT mode demonstrated a worst-case minimum margin of -17.2 dB below the emissions requirements in restricted frequency bands. The EUT ANT mode demonstrated a worst-case minimum margin of -17.4 dB below the emissions requirements in restricted frequency bands. Peak, Quasi-peak, and average amplitudes were checked for compliance with the regulations. Worst-case emissions are reported with other emissions found in the restricted frequency bands at least 20 dB below the requirements.

General Radiated Emissions Procedure

The EUT was arranged in a typical equipment configuration and operated through all available mode during testing. Preliminary testing was performed in a screen room with the EUT positioned 1 meter from the FSM. Radiated emissions measurements were performed to identify the frequencies, which produced the highest emissions. Each radiated emission was then maximized at the OATS location before final radiated measurements were performed. Final data was taken with the EUT located at the OATS at a distance of 3 meters between the EUT and the receiving antenna. The frequency spectrum from 9 kHz to 25,000 MHz was searched for general radiated emissions. Measured emission levels were maximized by EUT placement on the table, rotating the turntable through 360 degrees, varying the antenna height between 1 and 4 meters above the ground plane and changing antenna position between horizontal and vertical polarization. Antennas used were Loop from 9 kHz to 30 MHz, Broadband Biconical from 30 to 200 MHz, Biconilog from 30 to 1000 MHz, Log Periodic from 200 MHz to 1 GHz and or double Ridge or pyramidal horns and mixers above 1 GHz, notch filters and appropriate amplifiers and external mixers were utilized.

Table 3 General Radiated Emissions Data

Frequency in MHz	Horizontal Peak (dBµV/m)	Horizontal Quasi-Peak (dBµV/m)	Horizontal Average (dBµV/m)	Vertical Peak (dBµV/m)	Vertical Quasi-Peak (dBµV/m)	Vertical Average (dBµV/m)	Limit @ 3m (dBµV/m)
48.0	34.3	27.3	N/A	32.2	25.7	N/A	40.0
72.1	34.1	25.0	N/A	38.0	24.7	N/A	40.0
120.0	31.6	25.1	N/A	26.3	21.0	N/A	40.0
144.1	30.8	19.3	N/A	26.1	20.5	N/A	40.0
166.3	25.9	18.0	N/A	25.1	14.1	N/A	40.0
167.0	24.3	17.3	N/A	27.4	13.9	N/A	40.0

Other emissions present had amplitudes at least 20 dB below the limit. Peak and Quasi-Peak amplitude emissions are recorded for frequency range below 1000 MHz. Peak and Average amplitude emissions are recorded for frequency range above 1000 MHz.

Summary of Results for General Radiated Emissions

The EUT demonstrated compliance with the radiated emissions requirements of CFR47 Part 15C paragraph 15.209, RSS-210 and RSS-GEN Intentional Radiators. The EUT demonstrated a minimum margin of -14.9 dB below the requirements. Other emissions were present with amplitudes at least 20 dB below the Limits.

Operation in the Band 2400 – 2483.5 MHz

The transmitter output power; harmonic and general emissions were measured on an open area test site @ 3 meters. The EUT was placed on a turntable elevated as required above the ground plane and at a distance of 3 meters from the FSM antenna. The peak and quasi-peak amplitude of frequencies below 1000 MHz were measured using a spectrum analyzer. The peak and average amplitude of frequencies above 1000 MHz were measured using a spectrum analyzer. The amplitude of each emission was then recorded from the analyzer display. Emissions radiated outside of the specified bands, except for harmonics, shall be attenuated by at least 50 dB below the level of the fundamental or to the general radiated emission limits, whichever is the lesser attenuation. Antenna port emission plots were taken of transmitter performance for reference in this and other documentation using test sample #2. The amplitude of each radiated emission was measured on the OATS at a distance of 3 meters from the FSM antenna testing was performed on sample representative of production with integral antenna (sample #1) with worse case data provided. The amplitude of each radiated emission was maximized by equipment placement on the turn table, raising and lowering the FSM (Field Strength Measuring) antenna, changing the FSM antenna polarization, and by rotating the turntable. A Loop antenna was used for measuring emissions from 0.009 to 30 MHz, Biconilog Antenna for 30 to 1000 MHz, Double-Ridge, and/or Pyramidal Horn Antennas from 1 GHz to 25 GHz. Emissions were measured in dB μ V/m @ 3 meters.

Refer to figures one through four showing plots taken of the 2402-2480 MHz, ANT modulation, and figures five through eight showing plots of the BLE modulation performance displaying compliance with the specifications.

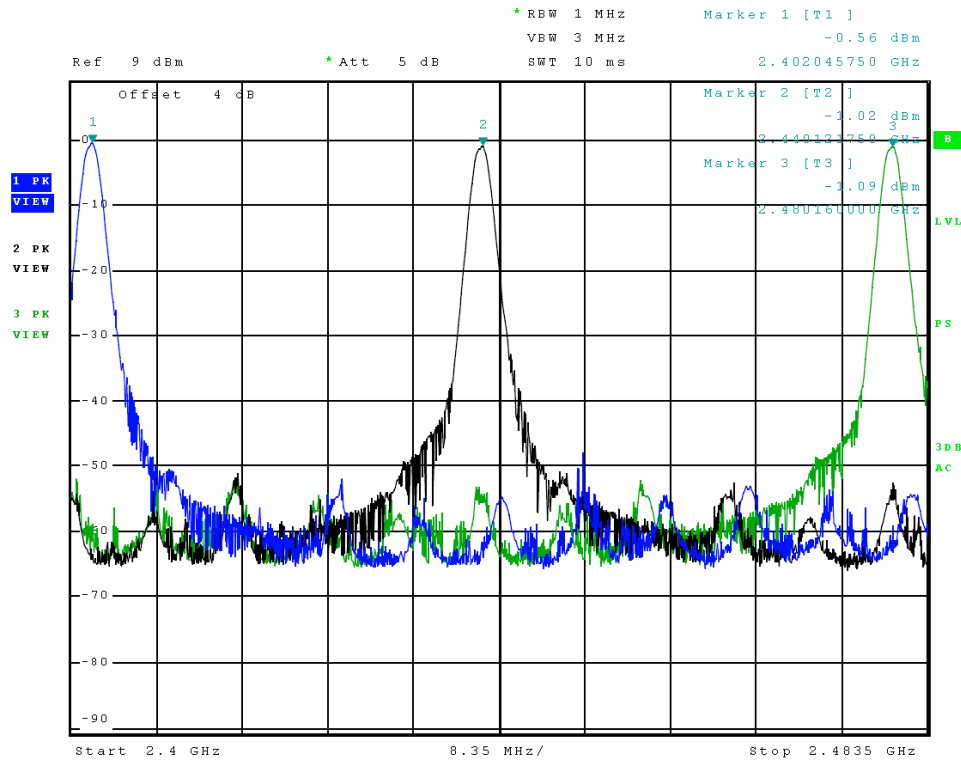

Figure 1 Plot of Transmitter Emissions (Operation in 2402-2480 MHz, ANT GFSK)

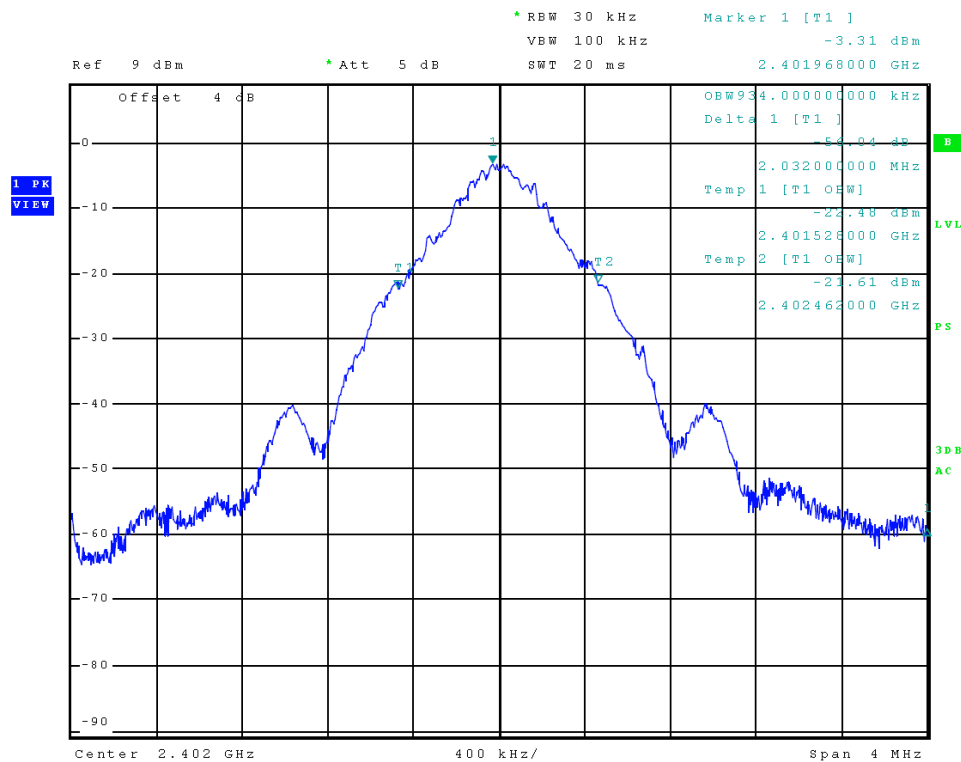

Figure 2 Plot of Transmitter Emissions (99% Occupied Bandwidth, ANT)

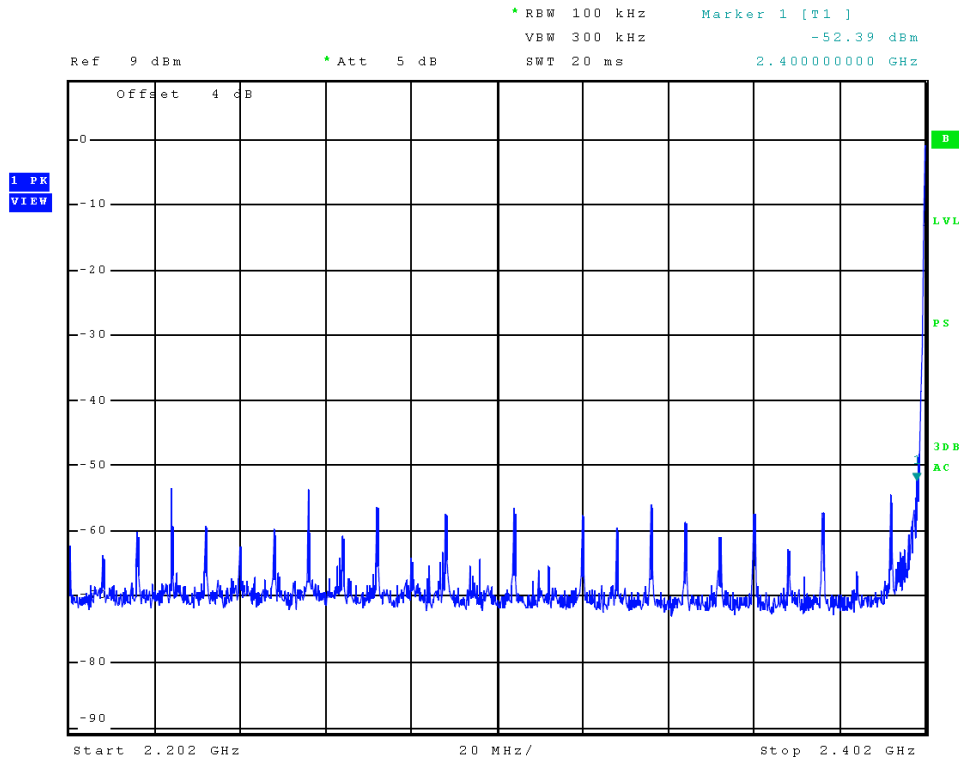

Figure 3 Plot of Transmitter Emissions (Low Band Edge, ANT)

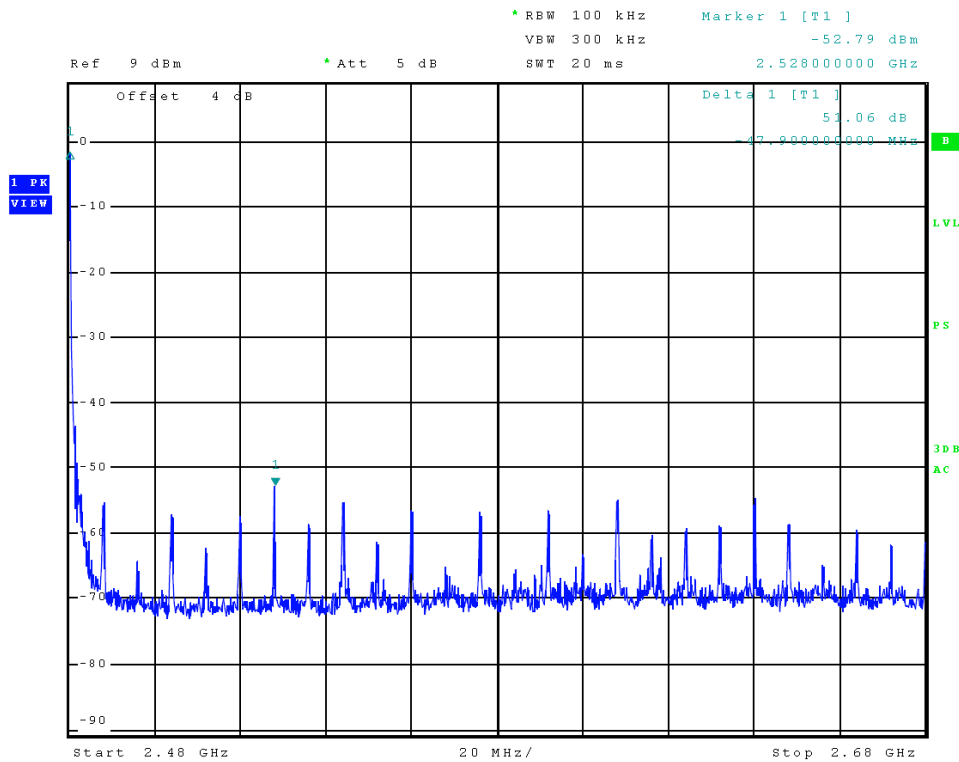

Figure 4 Plot of Transmitter Emissions (High Band Edge, ANT)

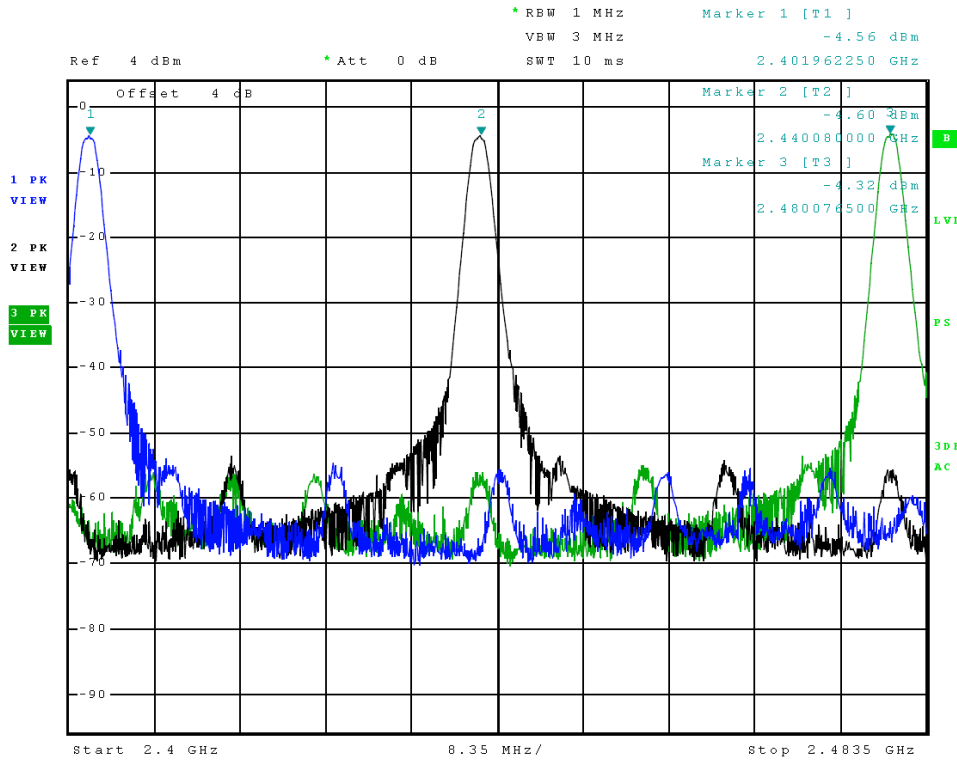

Figure 5 Plot of Transmitter Emissions (Operation in 2402-2480 MHz, BLE)

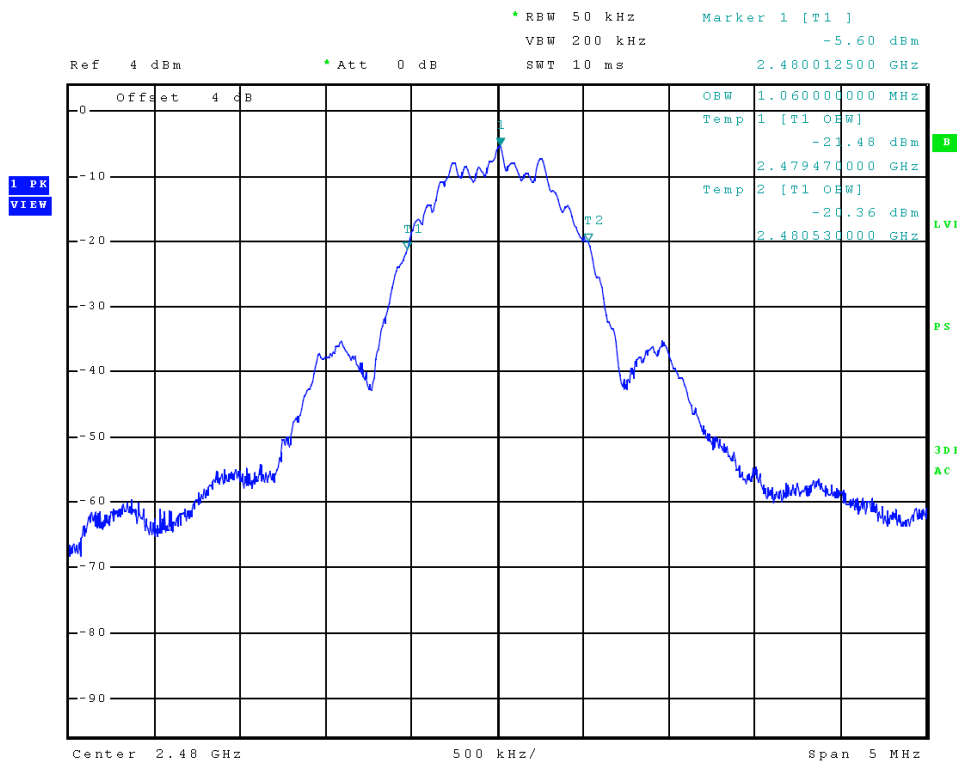

Figure 6 Plot of Transmitter Emissions (99% Occupied Bandwidth, BLE)

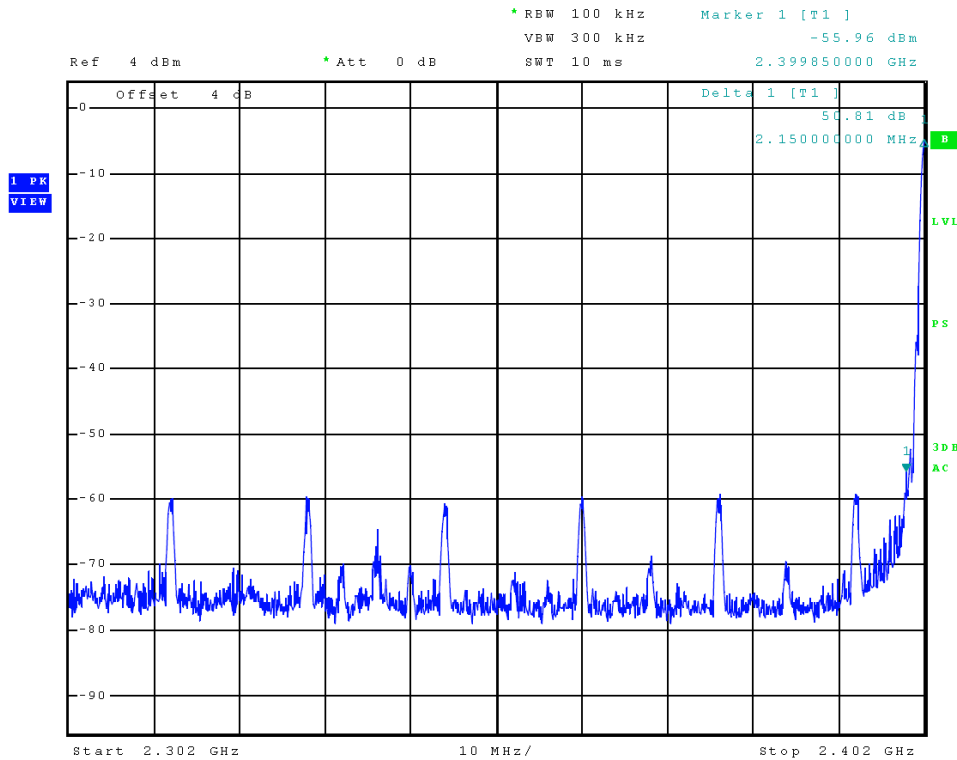

Figure 7 Plot of Transmitter Emissions (Low Band Edge, BLE)

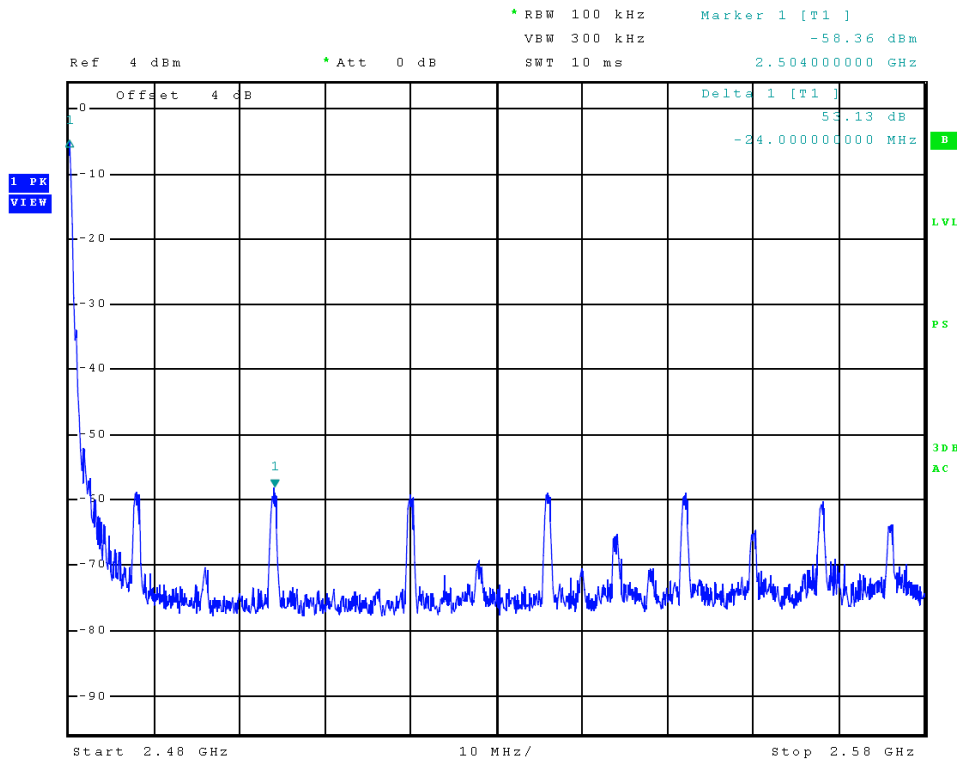

Figure 8 Plot of Transmitter Emissions (High Band Edge, BLE)

Transmitter Emissions Data

Table 4 Transmitter Radiated Emissions (Worst-case) ANT

Frequency in MHz	Horizontal Peak (dB μ V/m)	Horizontal Quasi-Peak (dB μ V/m)	Horizontal Average (dB μ V/m)	Vertical Peak (dB μ V/m)	Vertical Quasi-Peak (dB μ V/m)	Vertical Average (dB μ V/m)	Limit @ 3m (dB μ V/m)
2402.0	91.8	N/A	90.2	85.0	N/A	82.9	94.0
4804.0	45.0	N/A	32.3	44.3	N/A	31.6	54.0
7206.0	45.5	N/A	32.4	45.9	N/A	34.0	54.0
9608.0	46.6	N/A	33.4	46.4	N/A	33.6	54.0
12010.0	49.2	N/A	36.6	49.7	N/A	36.8	54.0
14412.0	51.2	N/A	38.2	50.9	N/A	38.0	54.0
16814.0	53.5	N/A	40.5	53.6	N/A	40.7	54.0
2441.0	92.1	N/A	89.8	84.9	N/A	82.5	94.0
4882.0	45.5	N/A	32.5	45.2	N/A	32.2	54.0
7323.0	46.1	N/A	33.0	45.9	N/A	33.6	54.0
9764.0	46.6	N/A	33.1	46.4	N/A	33.2	54.0
12205.0	49.2	N/A	36.0	49.1	N/A	35.9	54.0
14646.0	51.1	N/A	37.4	50.6	N/A	37.4	54.0
17087.0	55.1	N/A	42.0	55.2	N/A	42.4	54.0
2480.0	89.2	N/A	88.2	82.9	N/A	81.7	94.0
4960.0	44.9	N/A	32.0	45.3	N/A	32.4	54.0
7440.0	46.3	N/A	33.4	46.7	N/A	34.5	54.0
9920.0	46.0	N/A	33.1	46.7	N/A	33.0	54.0
12400.0	49.8	N/A	36.6	49.8	N/A	36.7	54.0
14880.0	49.8	N/A	36.7	49.9	N/A	36.5	54.0
17360.0	53.4	N/A	40.5	53.9	N/A	40.9	54.0

Other emissions present had amplitudes at least 20 dB below the limit. Peak and Quasi-Peak amplitude emissions are recorded for frequency range below 1000 MHz. Peak and Average amplitude emissions are recorded for frequency range above 1000 MHz.

Table 5 Transmitter Radiated Emissions (Worst-case) BLE

Frequency in MHz	Horizontal Peak (dB μ V/m)	Horizontal Quasi-Peak (dB μ V/m)	Horizontal Average (dB μ V/m)	Vertical Peak (dB μ V/m)	Vertical Quasi-Peak (dB μ V/m)	Vertical Average (dB μ V/m)	Limit @ 3m (dB μ V/m)
2402.0	87.3	N/A	80.0	82.2	N/A	72.4	94.0
4804.0	43.1	N/A	31.0	44.2	N/A	31.2	54.0
7206.0	46.0	N/A	33.1	45.8	N/A	33.1	54.0
9608.0	47.2	N/A	34.3	46.5	N/A	34.0	54.0
12010.0	49.1	N/A	36.3	49.1	N/A	36.3	54.0
14412.0	50.7	N/A	38.0	51.2	N/A	38.2	54.0
16814.0	53.1	N/A	40.2	53.4	N/A	40.6	54.0
2440.0	91.6	N/A	83.3	85.0	N/A	77.4	94.0
4880.0	44.5	N/A	31.7	45.1	N/A	31.4	54.0
7320.0	42.2	N/A	29.2	49.4	N/A	35.6	54.0
9760.0	47.4	N/A	33.9	46.8	N/A	33.8	54.0
12200.0	48.4	N/A	35.6	48.1	N/A	35.4	54.0
14640.0	50.3	N/A	36.3	49.4	N/A	36.4	54.0
17080.0	52.7	N/A	39.6	52.8	N/A	40.1	54.0
2480.0	84.0	N/A	76.7	83.7	N/A	76.4	94.0
4960.0	44.2	N/A	31.5	44.2	N/A	31.6	54.0
7440.0	47.1	N/A	33.9	47.0	N/A	34.2	54.0
9920.0	46.5	N/A	33.8	43.9	N/A	30.8	54.0
12400.0	49.4	N/A	36.6	50.4	N/A	36.6	54.0
14880.0	49.1	N/A	36.3	49.5	N/A	36.5	54.0
17360.0	54.4	N/A	41.5	54.2	N/A	41.3	54.0

Other emissions present had amplitudes at least 20 dB below the limit. Peak and Quasi-Peak amplitude emissions are recorded for frequency range below 1000 MHz. Peak and Average amplitude emissions are recorded for frequency range above 1000 MHz.

Summary of Results for Transmitter Radiated Emissions of Intentional Radiator

The EUT demonstrated compliance with the radiated emissions requirements of FCC 47 CFR Part 15.249, Industry Canada RSS-GEN issue 4, RSS-210 issue 9 Intentional Radiator regulations. The EUT ANT modulation worst-case test sample configuration demonstrated minimum average margin of -3.8 dB below the average emission limit for the fundamental. The EUT BLE modulation worst-case test sample configuration demonstrated minimum average margin of -10.7 dB below the average emission limit for the fundamental. The EUT worst-case configuration demonstrated minimum radiated harmonic emission margin of -11.6 dB below the limit. No other radiated emissions were found in the restricted bands less than 20 dB below limits than those recorded in this report. Other emissions were present with amplitudes at least 20 dB below the limits.

Annex

- Annex A Measurement Uncertainty Calculations
- Annex B Rogers Labs Test Equipment List
- Annex C Rogers Qualifications
- Annex D FCC Site Registration Letter
- Annex E Industry Canada Site Registration Letter

Annex A Measurement Uncertainty Calculations

Measurement uncertainty calculations were made for the laboratory. Result of measurement uncertainty calculations are recorded below for AC line conducted and radiated emission measurements.

Measurement Uncertainty	U _(E)	U _(lab)
3 Meter Horizontal 30-200 MHz Measurements	2.08	4.16
3 Meter Vertical 30-200 MHz Measurements	2.16	4.33
3 Meter Vertical Measurements 200-1000 MHz	2.99	5.97
10 Meter Horizontal Measurements 30-200 MHz	2.07	4.15
10 Meter Vertical Measurements 30-200 MHz	2.06	4.13
10 Meter Horizontal Measurements 200-1000 MHz	2.32	4.64
10 Meter Vertical Measurements 200-1000 MHz	2.33	4.66
3 Meter Measurements 1-6 GHz	2.57	5.14
3 Meter Measurements 6-18 GHz	2.58	5.16
AC Line Conducted	1.72	3.43

Annex B Rogers Labs Test Equipment List

List of Test Equipment	Calibration	Date	Due
Spectrum Analyzer: Rohde & Schwarz ESU40		5/17	5/18
Spectrum Analyzer: HP 8562A, HP Adapters: 11518, 11519, and 11520 Mixers: 11517A, 11970A, 11970K, 11970U, 11970V, 11970W		5/17	5/18
Spectrum Analyzer: HP 8591EM		5/17	5/18
Antenna: EMCO Biconilog Model: 3143		5/17	5/18
Antenna: Sunol Biconilog Model: JB6		10/16	10/17
Antenna: EMCO Log Periodic Model: 3147		10/16	10/17
Antenna: Com Power Model: AH-118		10/16	10/17
Antenna: Com Power Model: AH-840		5/17	5/18
Antenna: Antenna Research Biconical Model: BCD 235		10/16	10/17
Antenna: Com Power Model: AL-130		10/16	10/17
Antenna: EMCO 6509		10/16	10/17
LISN: Compliance Design Model: FCC-LISN-2.Mod.cd, 50 µHy/50 ohm/0.1 µf		10/16	10/17
R.F. Preamp CPPA-102		10/16	10/17
Attenuator: HP Model: HP11509A		10/16	10/17
Attenuator: Mini Circuits Model: CAT-3		10/16	10/17
Attenuator: Mini Circuits Model: CAT-3		10/16	10/17
Cable: Belden RG-58 (L1)		10/16	10/17
Cable: Belden RG-58 (L2)		10/16	10/17
Cable: Belden 8268 (L3)		10/16	10/17
Cable: Time Microwave: 4M-750HF290-750		10/16	10/17
Cable: Time Microwave: 10M-750HF290-750		10/16	10/17
Frequency Counter: Leader LDC825		2/17	2/18
Oscilloscope Scope: Tektronix 2230		2/17	2/18
Wattmeter: Bird 43 with Load Bird 8085		2/17	2/18
Power Supplies: Sorensen SRL 20-25, SRL 40-25, DCR 150, DCR 140		2/17	2/18
R.F. Generators: HP 606A, HP 8614A, HP 8640B		2/17	2/18
R.F. Power Amp 65W Model: 470-A-1010		2/17	2/18
R.F. Power Amp 50W M185- 10-501		2/17	2/18
R.F. Power Amp A.R. Model: 10W 1010M7		2/17	2/18
R.F. Power Amp EIN Model: A301		2/17	2/18
LISN: Compliance Eng. Model 240/20		2/17	2/18
LISN: Fischer Custom Communications Model: FCC-LISN-50-16-2-08		2/17	2/18
Antenna: EMCO Dipole Set 3121C		2/17	2/18
Antenna: C.D. B-101		2/17	2/18
Antenna: Solar 9229-1 & 9230-1		2/17	2/18
Audio Oscillator: H.P. 201CD		2/17	2/18
ESD Test Set 2010i		2/17	2/18
Fast Transient Burst Generator Model: EFT/B-101		2/17	2/18
Field Intensity Meter: EFM-018		2/17	2/18
KEYTEK Ecat Surge Generator		2/17	2/18
Shielded Room 5 M x 3 M x 3.0 M			

Annex C Rogers Qualifications

Scot D. Rogers, Engineer

Rogers Labs, Inc.

Mr. Rogers has approximately 17 years' experience in the field of electronics. Engineering experience includes six years in the automated controls industry and remaining years working with the design, development and testing of radio communications and electronic equipment.

Positions Held

Systems Engineer: A/C Controls Mfg. Co., Inc. 6 Years

Electrical Engineer: Rogers Consulting Labs, Inc. 5 Years

Electrical Engineer: Rogers Labs, Inc. Current

Educational Background

- 1) Bachelor of Science Degree in Electrical Engineering from Kansas State University.
- 2) Bachelor of Science Degree in Business Administration Kansas State University.
- 3) Several Specialized Training courses and seminars pertaining to Microprocessors and Software programming.

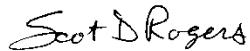

Scot D. Rogers

Annex D FCC Site Registration Letter

FEDERAL COMMUNICATIONS COMMISSION

**Laboratory Division
7435 Oakland Mills Road
Columbia, MD 21046**

April 16, 2015

Registration Number: 90910

Rogers Labs, Inc.
4405 West 259th Terrace
Louisburg, KS 66053

Attention: Scot Rogers,

Re: Measurement facility located at Louisburg
3 & 10 meter site
Date of Renewal: April 16, 2015

Dear Sir or Madam:

Your request for renewal of the registration of the subject measurement facility has been received. The information submitted has been placed in your file and the registration has been renewed. The name of your organization will remain on the list of facilities whose measurement data will be accepted in conjunction with applications for Certification under Parts 15 or 18 of the Commission's Rules. Please note that the file must be updated for any changes made to the facility and the registration must be renewed at least every three years.

Measurement facilities that have indicated that they are available to the public to perform measurement services on a fee basis may be found on the FCC website www.fcc.gov under E-Filing, OET Equipment Authorization Electronic Filing, Test Firms.

Sincerely,

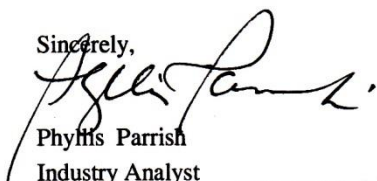

Phyllis Parrish
Industry Analyst

Rogers Labs, Inc.
4405 West 259th Terrace
Louisburg, KS 66053
Phone/Fax: (913) 837-3214
Revision 1

Garmin International, Inc.
Model: A03220
Test #: 170612
Test to: CFR47 15C, RSS-Gen, RSS-210
File: A03220 TstRpt 170612

SN's: 91606 / 91588
FCC ID: IPH-03220
IC: 1792A-03220
Date: July 18, 2017
Page 28 of 29

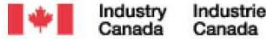
Annex E Industry Canada Site Registration Letter



June 08, 2015

OUR FILE: 46405-3041
Authorization No: 010277847-001

Rogers Labs Inc.
4405 West 259th Terrace
Louisburg, KS
USA
66053

Attention: Mr. Scot D. Rogers

Dear Sir:

The Bureau has received your application for the renewal of 3m OATS. Be advised that the information received was satisfactory to Industry Canada. The following number(s) is now associated to the site(s) for which registration / renewal was sought (**Site# 3041A-1**). Please reference the appropriate site number in the body of test reports containing measurements performed on the site. In addition, please keep for your records the following information;

- The company address code associated to the site(s) located at the above address is: **3041A**

Furthermore, to obtain or renew a unique site number, the applicant shall demonstrate that the site has been accredited to ANSI C63.4-2009 or later. A scope of accreditation indicating the accreditation by a recognized accreditation body to ANSI C63.4-2009 or later shall be accepted. Please indicate in a letter the previous assigned site number if applicable and the type of site (example: 3 metre OATS or 3 metre chamber). If the test facility is not accredited to ANSI C63.4-2009 or later, the test facility shall submit test data demonstrating full compliance with the ANSI standard. The Bureau will evaluate the filing to determine if recognition shall be granted.

The frequency for re-validation of the test site and the information that is required to be filed or retained by the testing party shall comply with the requirements established by the accrediting organization. However, in all cases, test site re-validation shall occur on an interval not to exceed **three years**. There is no fee or form associated with an OATS filing. OATS submissions are encouraged to be submitted electronically to the Bureau using the following URL; http://strategis.ic.gc.ca/epic/internet/inceb-bhst.nsf/en/h_tt00052e.html.

If you have any questions, you may contact the Bureau by e-mail at certification.bureau@ic.gc.ca Please reference our file and submission number above for all correspondence.

Yours sincerely,

A handwritten signature in black ink, appearing to read "Bill Payn".

Bill Payn
For: Wireless Laboratory Manager
Certification and Engineering Bureau
3701 Carling Ave., Building 94
P.O. Box 11490, Station AH@
Ottawa, Ontario K2H 8S2
Email: certification.bureau@ic.gc.ca

Rogers Labs, Inc.
4405 West 259th Terrace
Louisburg, KS 66053
Phone/Fax: (913) 837-3214
Revision 1

Garmin International, Inc.
Model: A03220
Test #: 170612
Test to: CFR47 15C, RSS-Gen, RSS-210
File: A03220 TstRpt 170612

SN's: 91606 / 91588
FCC ID: IPH-03220
IC: 1792A-03220
Date: July 18, 2017
Page 29 of 29