

# Application For Grant of Certification

FOR

FOR

Model: A03069  
2402-2480 MHz  
47CFR 15.249 and RSS-210  
Low Power Transmitter  
FCC ID: IPH-03069  
IC: 1792A-03069

FOR

## Garmin International, Inc.

1200 East 151st Street  
Olathe, KS 66062

Test Report Number: 160712  
IC Test Site Registration: 3041A-1

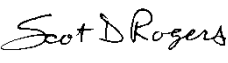
Authorized Signatory:   
Scot D. Rogers

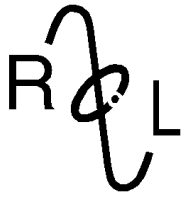

## **ROGERS LABS, INC.**

4405 West 259<sup>th</sup> Terrace  
Louisburg, KS 66053  
Phone / Fax (913) 837-3214

# Engineering Test Report For Grant of Certification Application

FOR

47 CFR, PART 15C - Intentional Radiators Paragraph 15.249 and  
Industry Canada RSS-210 Issue 9, RSS-GEN Issue 4  
License Exempt Intentional Radiator

For

## **Garmin International, Inc.**

1200 East 151st Street  
Olathe, KS 66062

Model: A03069

### **Low Power Transmitter**

Frequency Range 2402-2480 MHz  
FCC ID#: IPH-03069  
IC: 1792A-03069

Test Date: July 12, 2016

Certifying Engineer: *Scot D. Rogers*

Scot D. Rogers  
Rogers Labs, Inc.  
4405 West 259<sup>th</sup> Terrace  
Louisburg, KS 66053  
Telephone/Facsimile: (913) 837-3214

This report shall not be reproduced except in full, without the written approval of the laboratory.  
This report must not be used by the client to claim product certification, approval, or endorsement by  
NVLAP, NIST, or any agency of the Federal Government.

Rogers Labs, Inc.  
4405 West 259<sup>th</sup> Terrace  
Louisburg, KS 66053  
Phone/Fax: (913) 837-3214  
Revision 1

Garmin International, Inc.  
Model: A03069  
Test #: 160712  
Test to: CFR47 15C, RSS-Gen RSS-210  
File: A03069 TstRpt 160712

SN's: 79279b, 79286b  
FCC ID: IPH-03069  
IC: 1792A-03069  
Date: January 5, 2017  
Page 2 of 37

## Table Of Contents

<b>TABLE OF CONTENTS.....</b>	<b>3</b>
<b>REVISIONS.....</b>	<b>5</b>
<b>FORWARD .....</b>	<b>6</b>
<b>OPINION / INTERPRETATION OF RESULTS .....</b>	<b>6</b>
<b>EQUIPMENT TESTED.....</b>	<b>6</b>
<b>Equipment Function .....</b>	<b>7</b>
<b>Equipment Configuration.....</b>	<b>8</b>
<b>APPLICATION FOR CERTIFICATION.....</b>	<b>9</b>
<b>APPLICABLE STANDARDS &amp; TEST PROCEDURES .....</b>	<b>10</b>
<b>EQUIPMENT TESTING PROCEDURES .....</b>	<b>10</b>
<b>AC Line Conducted Emission Test Procedure .....</b>	<b>10</b>
<b>Radiated Emission Test Procedure.....</b>	<b>10</b>
Diagram 1 Test arrangement for Conducted emissions .....	11
Diagram 2 Test arrangement for radiated emissions of tabletop equipment.....	12
Diagram 3 Test arrangement for radiated emissions tested on Open Area Test Site (OATS).....	13
<b>TEST SITE LOCATIONS .....</b>	<b>13</b>
<b>LIST OF TEST EQUIPMENT .....</b>	<b>14</b>
<b>UNITS OF MEASUREMENTS .....</b>	<b>15</b>
<b>ENVIRONMENTAL CONDITIONS.....</b>	<b>15</b>
<b>INTENTIONAL RADIATORS.....</b>	<b>15</b>
<b>Antenna Requirements .....</b>	<b>15</b>
<b>Restricted Bands of Operation.....</b>	<b>15</b>
Table 1 Radiated Emissions in Restricted Frequency Bands Data (Mode 1) .....	16

Table 2 Radiated Emissions in Restricted Frequency Bands Data (Mode 2) ..... 17

**Summary of Results for Radiated Emissions in Restricted Bands ..... 17**

**AC Line Conducted Emissions Procedure ..... 18**

Figure 1 AC Line Conducted emissions of EUT line 1 (#4, EUT USB CPU Adapter)..... 19

Figure 2 AC Line Conducted emissions of EUT line 2 (#4, EUT USB CPU Adapter)..... 19

Figure 3 AC Line Conducted emissions of EUT line 1 (#5, EUT AC Adapter 362-00086-01)..... 20

Figure 4 AC Line Conducted emissions of EUT line 2 (#5, EUT AC Adapter 362-00086-01)..... 20

Table 3 AC Line Conducted Emissions Data L1 (#4, EUT USB CPU Adapter) ..... 21

Table 4 AC Line Conducted Emissions Data L2 (#42, EUT USB CPU Adapter) ..... 21

Table 5 AC Line Conducted Emissions Data L1 (#5, EUT -AC Adapter 362-00072-00) ..... 22

Table 6 AC Line Conducted Emissions Data L2 (#5, EUT -AC Adapter 362-00072-00) ..... 22

**Summary of Results for AC Line Conducted Emissions Results ..... 22**

**General Radiated Emissions Procedure ..... 23**

Table 7 General Radiated Emissions Data (worst-case)..... 23

**Summary of Results for General Radiated Emissions ..... 24**

**Operation in the Band 2400 – 2483.5 MHz ..... 24**

Figure 7 Plot of Transmitter Emissions (Mode 1, Operation in 2402-2480 MHz) ..... 25

Figure 8 Plot of Transmitter Emissions (Mode 1, 99% Occupied Bandwidth) ..... 25

Figure 9 Plot of Transmitter Emissions (Mode 1, Low Band Edge) ..... 26

Figure 10 Plot of Transmitter Emissions (Mode 1, High Band Edge)..... 26

Figure 11 Plot of Transmitter Emissions (Mode 2 Operation in 2402-2480 MHz)..... 27

Figure 12 Plot of Transmitter Emissions (Mode 2, 99% Occupied Bandwidth) ..... 27

Figure 13 Plot of Transmitter Emissions (Mode 2, Low Band Edge) ..... 28

Figure 14 Plot of Transmitter Emissions (Mode 2, High Band Edge)..... 28

**Transmitter Emissions Data..... 29**

Table 8 Transmitter Radiated Emissions (Mode 1, Mode 1).....29

Table 9 Transmitter Radiated Emissions (Mode 2) .....30

**Summary of Results for Transmitter Radiated Emissions of Intentional Radiator.....31**

**STATEMENT OF MODIFICATIONS AND DEVIATIONS ..... 31**

**ANNEX..... 32**

**Annex A Measurement Uncertainty Calculations.....33**

**Annex B Rogers Labs Test Equipment List.....34**

**Annex C Rogers Qualifications .....35**

**Annex D FCC Site Registration Letter.....36**

**Annex E Industry Canada Site Registration Letter .....37**

**Revisions**

Revision 1 Issued January 5, 2017

## Forward

The following information is submitted for consideration in obtaining Grant of Certification for low power intentional radiator per 47 CFR Paragraph 15.249, Industry Canada RSS-210 Issue 9 and RSS-GEN Issue 4, low power digital device transmitter operations in the 2400 – 2483.5 MHz frequency band.

Name of Applicant: Garmin International, Inc.  
1200 East 151st Street  
Olathe, KS 66062

Model: A03069

FCC ID: IPH-03069 IC: 1792A-03069

Operating power: 2402-2480 MHz Maximum Average power 93.4 dB $\mu$ V/m @ 3 meters (and peak 93.7 dB $\mu$ V/m @ 3 meters, 871.5 kHz (99% OBW)

## Opinion / Interpretation of Results

Tests Performed	Margin (dB)	Results
Restricted Bands 47CFR 15.205, RSS-210 2.2	-13.5	Complies
AC Line Conducted 47CFR 15.207, RSS-GEN 8.8	-9.6	Complies
Radiated Emissions 47CFR 15.209, RSS-GEN 8.9	-15.6	Complies
Harmonic Emissions per 47CFR 15.249, RSS-210 A2.9	-9.6	Complies

## Equipment Tested

<u>Equipment</u>	<u>Model / PN</u>	<u>Serial Number</u>
EUT	A03069	79279b
EUT #2	A03069	79286b
USB cable	320-00559-01	N/A
Laptop Computer	studio XPS (PP35L)	921LBN1
USB Printer	Dell 0N5819	5D1SL61
AC Adapter	362-00086-01	N/A
DC Adapter (CLA)	320-00753-00	N/A
Automotive Interface cable	011-02320-10	N/A
Automotive Interface cable	011-02989-00	N/A

Test results in this report relate only to the items tested.

Rogers Labs, Inc.  
4405 West 259<sup>th</sup> Terrace  
Louisburg, KS 66053  
Phone/Fax: (913) 837-3214  
Revision 1

Garmin International, Inc.  
Model: A03069  
Test #: 160712  
Test to: CFR47 15C, RSS-Gen RSS-210  
File: A03069 TstRpt 160712

SN's: 79279b, 79286b  
FCC ID: IPH-03069  
IC: 1792A-03069  
Date: January 5, 2017  
Page 6 of 37

## ***Equipment Function***

The EUT is a GPS receiver and display unit offering reception and display of location, navigation, and other information for the user. The GPS design offers use as a hand-held, transportation mount or portable configuration for use in navigational applications. The design incorporates a low power transmitter with operation capability in the 2402-2480 MHz frequency band. The design offers interface capabilities with compatible equipment and installations (for power), wirelessly (two modes available), through USB communications port, or automotive interface cabling. The EUT was arranged as described by the manufacturer emulating typical user configurations for testing purposes. The EUT offers no other interface connections than those in the configuration options shown below as described by the manufacturer. The EUT operates from internal battery or external power received from compatible installations. For testing purposes, the EUT received powered from internal battery and/or external AC or DC supply and support equipment. During testing, the test system was configured to operate in available modes. Some configurations offered are not applicable for this report and have been tested and documented in other relevant documentation. Two samples were provided for testing, one representative of production hardware design, and the other modified for testing purposes replacing integral antenna with RF connection port. The antenna modification offered testing facility the ability to connect test equipment to the temporary antenna port for antenna port conducted emission testing. The test samples were provided with test software enabling testing personnel the ability to enable transmitter functions on defined channels and modes. As requested by the manufacturer and required by regulations, the equipment was tested for emissions compliance using the available configurations with the worst-case data presented. Test results in this report relate only to the products described in this report.

**Equipment Configuration**

1. A03069 (GPN: 011-04105-xx) connected to vehicle adaptor GPN: 011-02023-10

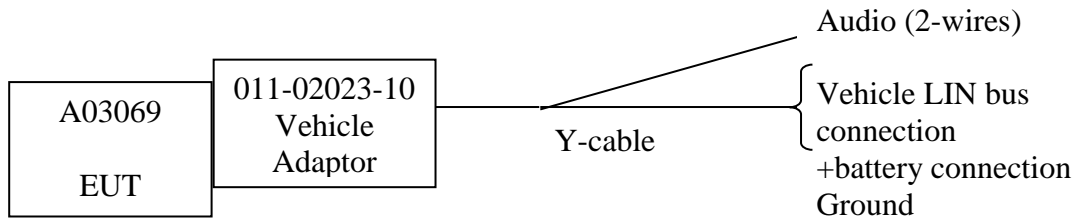

2. A03069 (GPN: 011-02023-10) connected to vehicle adaptor GPN: 011-02989-00

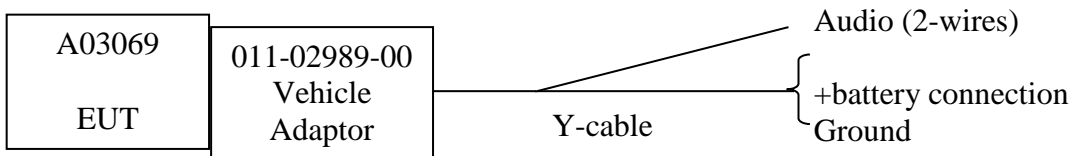

3. A03069 (GPN: 011-02023-10) connected to vehicle adaptor (GPN: 011-02990-01 and cigarette lighter adaptor (CLA) GPN: 320-00753-00)

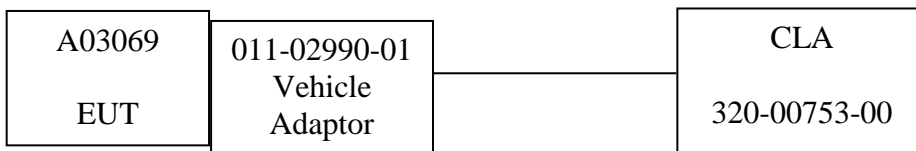

4. A03069 (GPN: 011-02023-10) connected to computer via USB micro cable.

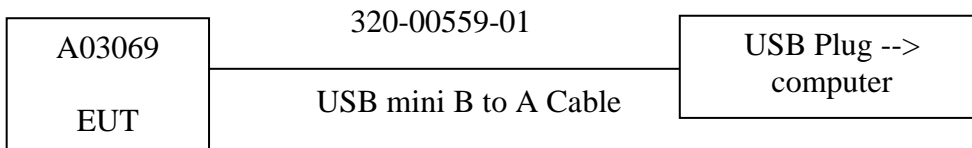

5. A03069 (GPN: 011-02023-10) charged by the AC wall brick power supply (PSA|10R-050Q, GPN: 362-00086-01)

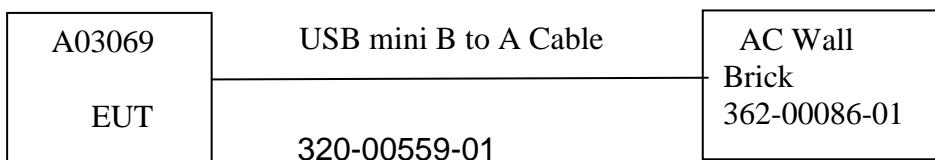



## Application for Certification

- (1) Manufacturer: Garmin International, Inc.  
1200 East 151st Street  
Olathe, KS 66062
- (2) Identification: Model: A03069  
FCC ID: IPH-03069 IC: 1792A-03069
- (3) Instruction Book:  
Refer to Exhibit for Instruction Manual.
- (4) Description of Circuit Functions:  
Refer to Exhibit of Operational Description.
- (5) Block Diagram with Frequencies:  
Refer to Exhibit of Operational Description.
- (6) Report of Measurements:  
Report of measurements follows in this Report.
- (7) Photographs: Construction, Component Placement, etc.:  
Refer to Exhibit for photographs of equipment.
- (8) List of Peripheral Equipment Necessary for operation. The equipment operates from direct current power from internal rechargeable battery or external power sources as documented in this report. The design provides USB interface port for use with compatible equipment for communications and battery recharge. The EUT offers no other connection ports than those presented in this filing.
- (9) Transition Provisions of CFR47 15.37 are not requested.
- (10) Not Applicable. The unit is not a scanning receiver.
- (11) Not Applicable. The EUT does not operate in the 59 – 64 GHz frequency band.
- (12) The equipment is not software defined and this section is not applicable.
- (13) Applications for certification of U-NII devices in the 5.15-5.35 GHz and the 5.47-5.85 GHz bands must include a high-level operational description of the security procedures that control the radio frequency operating parameters and ensure that unauthorized modifications cannot be made. Not applicable to this filing
- (14) Contain at least one drawing or photograph showing the test set-up for each of the required types of tests applicable to the device for which certification is requested. These drawings or photographs must show enough detail to confirm other information contained in the test report. Any photographs used must be focused originals without glare or dark spots and must clearly show the test configuration used. Information is provide in Test Setup Exhibit

## Applicable Standards & Test Procedures

In accordance with the Federal Communications Code of Federal Regulations, dated October 1, 2015: Part 2, Subpart J, Paragraphs 2.907, 2.911, 2.913, 2.925, 2.926, 2.1031 through 2.1057, and applicable parts of paragraph 15, Part 15C Paragraph 15.249, Industry Canada RSS-210 Issue 9, and RSS-GEN issue 4 operation in the 2400 – 2483.5 MHz Frequency band. Test procedures used are the established Methods of Measurement of Radio-Noise Emissions as described in ANSI C63.10-2013.

## Equipment Testing Procedures

### ***AC Line Conducted Emission Test Procedure***

Testing for the AC line-conducted emissions was performed as required in CFR47 15C, RSS-210 and specified in ANSI C63.10-2013. The test setup, including the EUT, was arranged in the test configurations as presented during testing. The test configuration was placed on a 1 x 1.5-meter bench, 0.8 meters high located in a screen room. The power lines of the system were isolated from the power source using a standard LISN with a 50- $\mu$ Hy choke. EMI was coupled to the spectrum analyzer through a 0.1  $\mu$ F capacitor internal to the LISN. The LISN was positioned on the floor beneath the wooden bench supporting the EUT. The power lines and cables were draped over the back edge of the table. Refer to diagram one showing typical test arrangement and photographs in exhibits for EUT placement used during testing.

### ***Radiated Emission Test Procedure***

The EUT was placed on a rotating 0.9 x 1.2-meter platform, elevated as required above the ground plane at a distance of 3 meters from the FSM antenna. Radiated emissions testing was performed as required in the regulations and specified in ANSI C63.10-2013. EMI energy was maximized by equipment placement permitting orientation in three orthogonal axes, raising and lowering the FSM antenna, changing the antenna polarization, and by rotating the turntable. Each emission was maximized before data was taken and recorded. The frequency spectrum from 9 kHz to 25,000 MHz was searched for emissions during preliminary investigation. Refer to diagrams two and three showing typical test setup. Refer to photographs in the test setup exhibits for specific EUT placement during testing.

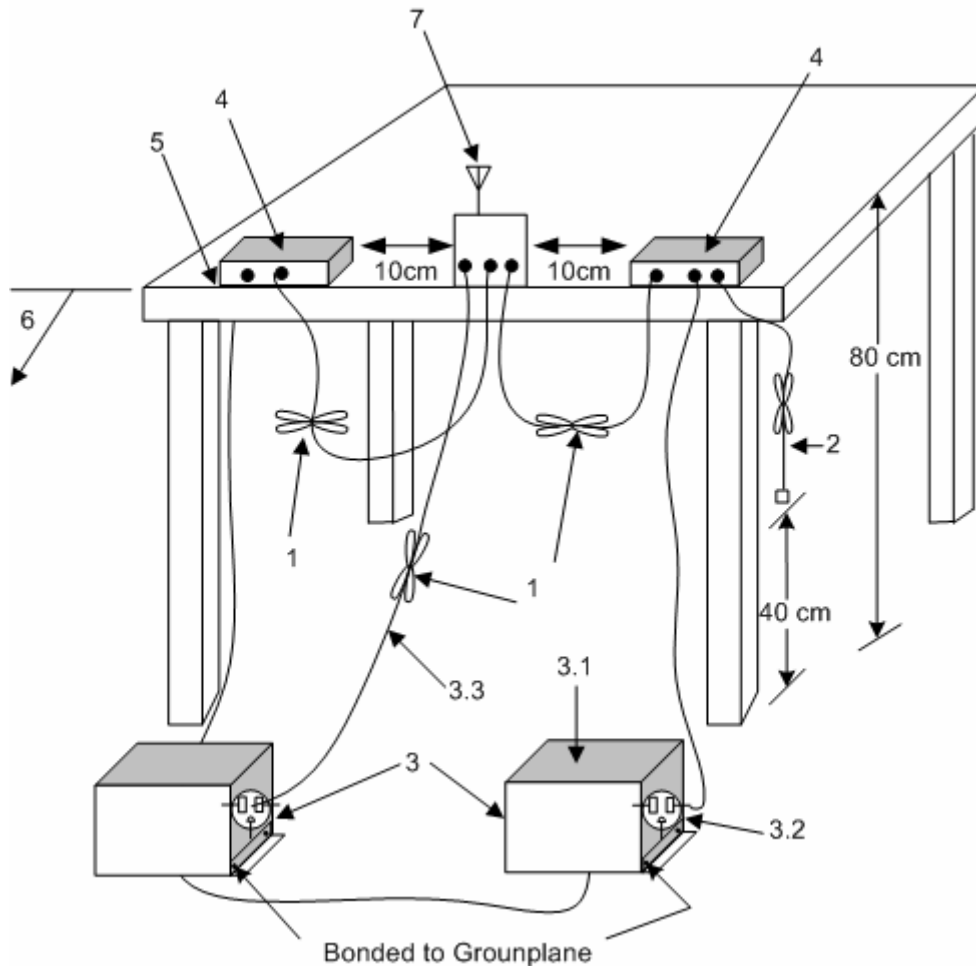

1. Interconnecting cables that hang closer than 40 cm to the ground plane shall be folded back and forth in the center forming a bundle 30 cm to 40 cm long see (see 6.2.3.1).
2. I/O cables that are not connected to an accessory shall be bundled in the center. The end of the cable may be terminated, if required, using the correct terminating impedance. The overall length shall not exceed 1 m (see 6.2.2).
3. EUT connected to one LISN. Unused LISN measuring port connectors shall be terminated in 50  $\Omega$  loads. LISN can be placed on top of, or immediately beneath, reference ground plane (see 6.2.2 and 6.2.3).
  - 3.1 All other equipment powered from additional LISN(s).
  - 3.2 Multiple-outlet strip can be used for multiple power cords of non-EUT equipment.
  - 3.3 LISN at least 80 cm from nearest part of EUT chassis.
4. Non-EUT components of EUT system being tested.
5. Rear of EUT, including peripherals, shall all be aligned and flush with rear of tabletop (see 6.2.3.1).
6. Edge of tabletop shall be 40 cm removed from a vertical conducting plane that is bonded to the ground plane (see 6.2.2 for options).
7. Antenna may be integral or detachable. If detachable, the antenna shall be attached for this test.

**Diagram 1 Test arrangement for Conducted emissions**

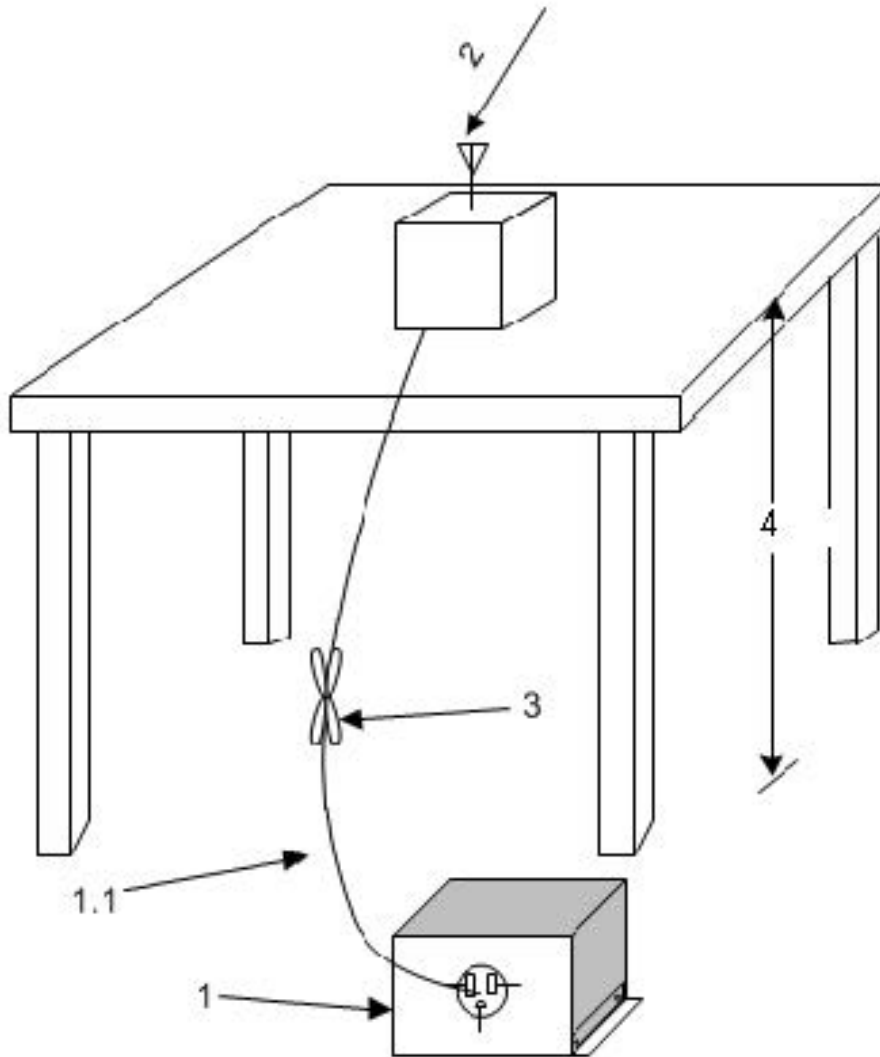

1—A LISN is optional for radiated measurements between 30 MHz and 1000 MHz but not allowed for measurements below 30 MHz and above 1000 MHz (see 6.3.1). If used, then connect EUT to one LISN. Unused LISN measuring port connectors shall be terminated in 50  $\Omega$  loads. The LISN may be placed on top of, or immediately beneath, the reference ground plane (see 6.2.2 and 6.2.3.2).

1.1—LISN spaced at least 80 cm from the nearest part of the EUT chassis.

2—Antenna can be integral or detachable, depending on the EUT (see 6.3.1).

3—Interconnecting cables that hang closer than 40 cm to the ground plane shall be folded back and forth in the center forming a bundle 30 cm to 40 cm long (see 6.3.1).

4—For emission measurements at or below 1 GHz, the table height shall be 80 cm. For emission measurements above 1 GHz, the table height shall be 1.5 m for measurements, except as otherwise specified (see 6.3.1 and 6.6.3.1).

**Diagram 2 Test arrangement for radiated emissions of tabletop equipment**

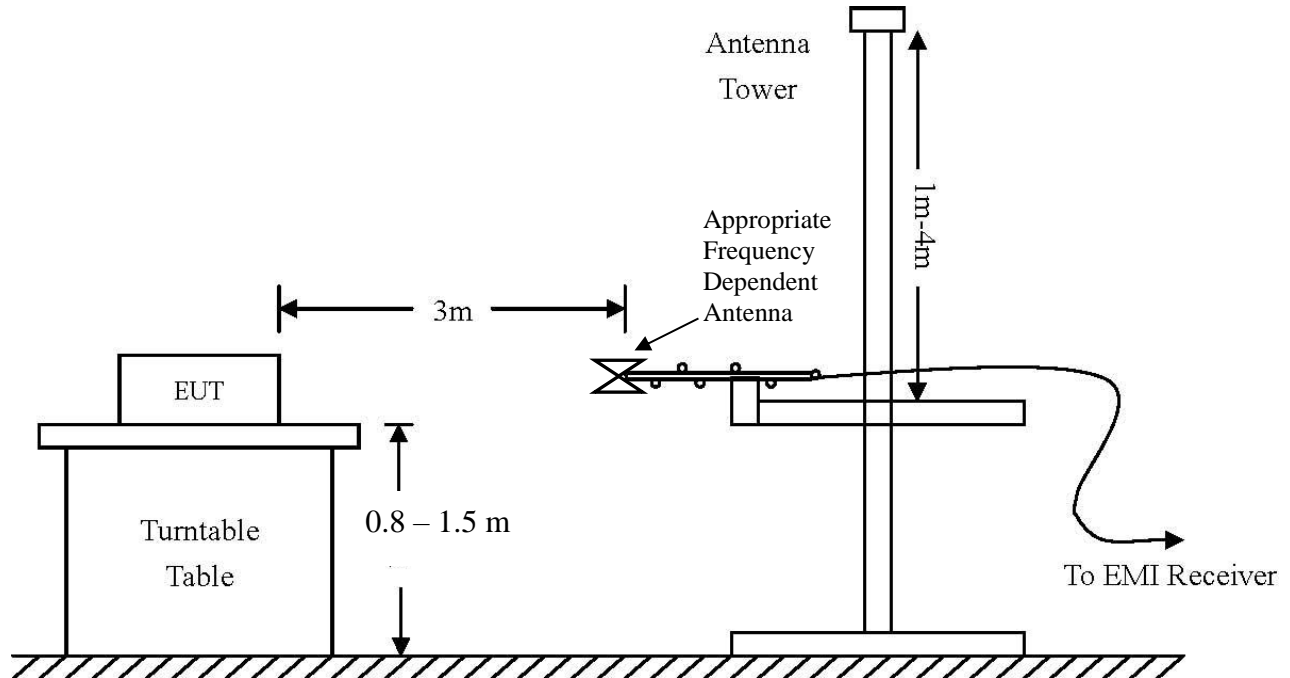

**Diagram 3 Test arrangement for radiated emissions tested on Open Area Test Site (OATS)**

## Test Site Locations

Conducted EMI	The AC power line conducted emissions testing performed in a shielded screen room located at Rogers Labs, Inc., 4405 West 259 <sup>th</sup> Terrace, Louisburg, KS
Radiated EMI	The radiated emissions tests were performed at the 3 meters, Open Area Test Site (OATS) located at Rogers Labs, Inc., 4405 West 259 <sup>th</sup> Terrace, Louisburg, KS
Site Registration	Refer to Annex for Site Registration Letters
NVLAP Accreditation	Lab code 200087-0

## List of Test Equipment

A Rohde and Schwarz ESU40 and/or Hewlett Packard 8591EM was used as the measuring device for the emissions testing of frequencies below 1 GHz. A Rohde and Schwarz ESU40 and/or Hewlett Packard 8562A Spectrum Analyzer was used as the measuring device for testing the emissions at frequencies above 1 GHz. The analyzer settings used are described in the following table.

Frequency: 9 kHz-30 MHz	Frequency: 30 MHz- 1 GHZ	Frequency: Above 1 GHz
Loop Antenna	Broadband Biconilog	Horn
RBW = 9 kHz	RBW = 120 kHz	RBW = 1 MHz
VBW = 30 kHz	VBW = 500 kHz	VBW = 3 MHz
Sweep time = Auto	Sweep time = Auto	Sweep time = Auto
Detector = PK, QP	Detector = PK, QP	Detector = PK, AV
Antenna Height 1m	Antenna Height 1-4m	Antenna Height 1-4m

<u>Equipment</u>	<u>Manufacturer</u>	<u>Model (SN)</u>	<u>Band</u>	<u>Cal Date</u>	<u>Due</u>
<input checked="" type="checkbox"/> LISN	FCC	FCC-LISN-50-2-10(1PA) (160611)	.15-30MHz	5/16	5/17
<input checked="" type="checkbox"/> Cable	Time Microwave	750HF290-750 (L10M)	9kHz-40 GHz	10/15	10/16
<input checked="" type="checkbox"/> Cable	Belden	RG-58 (L1-CAT3-11509)	9kHz-30 MHz	10/15	10/16
<input checked="" type="checkbox"/> Cable	Belden	RG-58 (L2-CAT3-11509)	9kHz-30 MHz	10/15	10/16
<input type="checkbox"/> Antenna	ARA	BCD-235-B (169)	20-350MHz	10/15	10/16
<input type="checkbox"/> Antenna	EMCO	3147 (40582)	200-1000MHz	10/15	10/16
<input checked="" type="checkbox"/> Antenna	ETS-Lindgren	3117 (200389)	1-18 GHz	5/16	5/18
<input type="checkbox"/> Antenna	Com Power	AH-118 (10110)	1-18 GHz	10/15	10/16
<input checked="" type="checkbox"/> Antenna	Com Power	AH-840 (101046)	18-40 GHz	5/16	5/18
<input checked="" type="checkbox"/> Antenna	EMCO	6509 (9502-1374)	.001-30 MHz	10/15	10/16
<input checked="" type="checkbox"/> Antenna	Sunol	JB-6 (A100709)	30-1000 MHz	10/15	10/16
<input type="checkbox"/> Antenna	EMCO	3143 (9607-1277)	20-1200 MHz	5/16	5/17
<input type="checkbox"/> Analyzer	HP	8591EM (3628A00871)	9kHz-1.8GHz	5/16	5/17
<input type="checkbox"/> Analyzer	HP	8562A (3051A05950)	9kHz-110GHz	5/16	5/17
<input type="checkbox"/> Analyzer	HP External Mixers	11571, 11970	25GHz-110GHz	5/16	5/17
<input checked="" type="checkbox"/> Analyzer	Rohde & Schwarz	ESU40 (100108)	20Hz-40GHz	5/16	5/17
<input checked="" type="checkbox"/> Amplifier	Com-Power	PA-010 (171003)	100Hz-30MHz	10/15	10/16
<input checked="" type="checkbox"/> Amplifier	Com-Power	CPPA-102 (01254)	1-1000 MHz	10/15	10/16
<input checked="" type="checkbox"/> Amplifier	Com-Power	PAM-118A (551014)	0.5-18 GHz	10/15	10/16

## Units of Measurements

Conducted EMI            Data is in dB $\mu$ V; dB referenced to one microvolt

Radiated EMI            Data is in dB $\mu$ V/m; dB/m referenced to one microvolt per meter

Sample Calculation:

RFS = Radiated Field Strength, FSM = Field Strength Measured

A.F. = Receive antenna factor, Gain = amplification gains and/or cable losses

RFS (dB $\mu$ V/m @ 3m) = FSM (dB $\mu$ V) + A.F. (dB) - Gain (dB)

## Environmental Conditions

Ambient Temperature	23.1° C
Relative Humidity	53%
Atmospheric Pressure	1015.4 mb

## Intentional Radiators

The following information is submitted in support demonstration of compliance with the requirements of 47CFR, Subpart C, paragraph 15.249, Industry Canada RSS-210 Issue 9 and RSS-GEN Issue 4.

### ***Antenna Requirements***

The EUT incorporates integral antenna system and offers no provision for connection to alternate antenna system. The antenna connection point complies with the unique antenna connection requirements. The unique antenna connection requirements are fulfilled. There are no deviations or exceptions to the specification.

### ***Restricted Bands of Operation***

Spurious emissions falling in the restricted frequency bands of operation were measured at the OATS. The EUT utilizes frequency, determining circuitry, which generates harmonics falling in the restricted bands. Emissions were investigated at the OATS, using appropriate antennas or pyramidal horns, amplification stages, and a spectrum analyzer. Peak and average amplitudes of frequencies above 1000 MHz were compared to the required limits with worst-case data presented below. Test procedures of ANSI C63.10-2013 were used during testing. No other significant emission was observed which fell into the restricted bands of operation. Computed emission values take into account the received radiated field strength, receive antenna correction factor, amplifier gain stage, and test system cable losses.

**Table 1 Radiated Emissions in Restricted Frequency Bands Data (Mode 1)**

Frequency in MHz	Horizontal Peak (dBµV/m)	Horizontal Quasi-Peak (dBµV/m)	Horizontal Average (dBµV/m)	Vertical Peak (dBµV/m)	Vertical Quasi-Peak (dBµV/m)	Vertical Average (dBµV/m)	Limit @ 3m (dBµV/m)
2390.0	41.2	N/A	27.6	42.5	N/A	27.7	54.0
2483.5	45.2	N/A	32.3	53.9	N/A	40.5	54.0
4804.0	42.7	N/A	30.1	43.3	N/A	30.4	54.0
4882.0	43.6	N/A	30.5	43.8	N/A	30.8	54.0
4960.0	45.4	N/A	33.8	43.1	N/A	30.6	54.0
7206.0	15.8	N/A	33.0	46.8	N/A	33.1	54.0
7323.0	45.6	N/A	33.1	46.1	N/A	33.5	54.0
7440.0	45.6	N/A	32.7	46.0	N/A	32.7	54.0
12010.0	50.6	N/A	37.7	50.6	N/A	37.7	54.0
12205.0	50.6	N/A	37.4	50.3	N/A	37.3	54.0
12400.0	49.8	N/A	37.0	49.9	N/A	37.0	54.0

Other emissions present had amplitudes at least 20 dB below the limit. Peak and Quasi-Peak amplitude emissions are recorded for frequency range below 1000 MHz. Peak and Average amplitude emissions are recorded for frequency range above 1000 MHz.



**Table 2 Radiated Emissions in Restricted Frequency Bands Data (Mode 2)**

Frequency in MHz	Horizontal Peak (dB $\mu$ V/m)	Horizontal Quasi-Peak (dB $\mu$ V/m)	Horizontal Average (dB $\mu$ V/m)	Vertical Peak (dB $\mu$ V/m)	Vertical Quasi-Peak (dB $\mu$ V/m)	Vertical Average (dB $\mu$ V/m)	Limit @ 3m (dB $\mu$ V/m)
2390.0	40.4	N/A	27.2	43.9	N/A	29.1	54.0
2483.5	45.2	N/A	32.2	53.4	N/A	40.6	54.0
4804.0	43.6	N/A	31.6	42.9	N/A	29.9	54.0
4882.0	44.3	N/A	31.3	44.4	N/A	32.0	54.0
4960.0	45.6	N/A	33.4	45.1	N/A	32.7	54.0
7206.0	46.4	N/A	33.0	46.2	N/A	32.9	54.0
7323.0	46.5	N/A	33.7	46.3	N/A	33.5	54.0
7440.0	45.5	N/A	32.5	45.3	N/A	32.6	54.0
12010.0	50.8	N/A	37.7	50.3	N/A	37.7	54.0
12205.0	50.3	N/A	37.5	50.2	N/A	37.4	54.0
12400.0	50.2	N/A	36.9	50.1	N/A	37.0	54.0

Other emissions present had amplitudes at least 20 dB below the limit. Peak and Quasi-Peak amplitude emissions are recorded for frequency range below 1000 MHz. Peak and Average amplitude emissions are recorded for frequency range above 1000 MHz.

### **Summary of Results for Radiated Emissions in Restricted Bands**

The EUT demonstrated compliance with the radiated emissions requirements of 47CFR Part 15C and RSS-210 Intentional Radiator requirements. The EUT demonstrated a worst-case minimum margin of -13.5 dB below the emissions requirements in restricted frequency bands. Peak, Quasi-peak, and average amplitudes were checked for compliance with the regulations. Worst-case emissions are reported with other emissions found in the restricted frequency bands at least 20 dB below the requirements.

## ***AC Line Conducted Emissions Procedure***

The EUT was arranged in typical equipment configurations operating from AC power adapter. Testing was performed with the EUT placed on a 1 x 1.5-meter wooden bench 80 cm above the conducting ground plane, floor of a screen room. The bench was positioned 40 cm away from the wall of the screen room. The LISN was positioned on the floor of the screen room 80-cm from the rear of the EUT. Testing for the line-conducted emissions were the procedures of ANSI C63.10-2013 paragraph 6. The AC adapter for the EUT was connected to the LISN for line-conducted emissions testing. A second LISN was positioned on the floor of the screen room 80-cm from the rear of the supporting equipment of the EUT. All power cords except the EUT were then powered from the second LISN. EMI was coupled to the spectrum analyzer through a 0.1  $\mu$ F capacitor, internal to the LISN. Power line conducted emissions testing was carried out individually for each current carrying conductor of the EUT. The excess length of lead between the system and the LISN receptacle was folded back and forth to form a bundle not exceeding 40 cm in length. The screen room, conducting ground plane, analyzer, and LISN were bonded together to the protective earth ground. Preliminary testing was performed to identify the frequencies of each of the emissions, which demonstrated the highest amplitudes. The cables were repositioned to obtain maximum amplitude of measured EMI level. Once the worst-case configuration was identified, plots were made of the EMI from 0.15 MHz to 30 MHz then data was recorded with maximum conducted emissions levels.

Refer to figures one and two showing plots of the AC Line conducted emissions of the CPU USB configuration (#4) while operating the EUT. Refer to figures three and four showing plots of the AC Line conducted emissions of the AC Adapter configuration (#5) while powering the EUT.

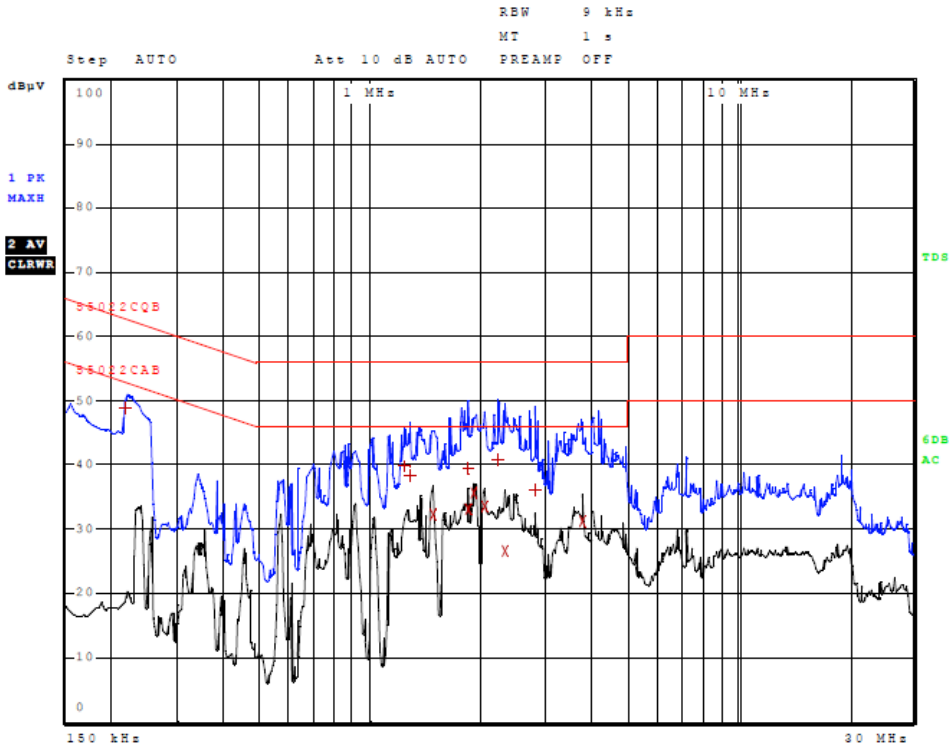

Figure 1 AC Line Conducted emissions of EUT line 1 (#4, EUT USB CPU Adapter)

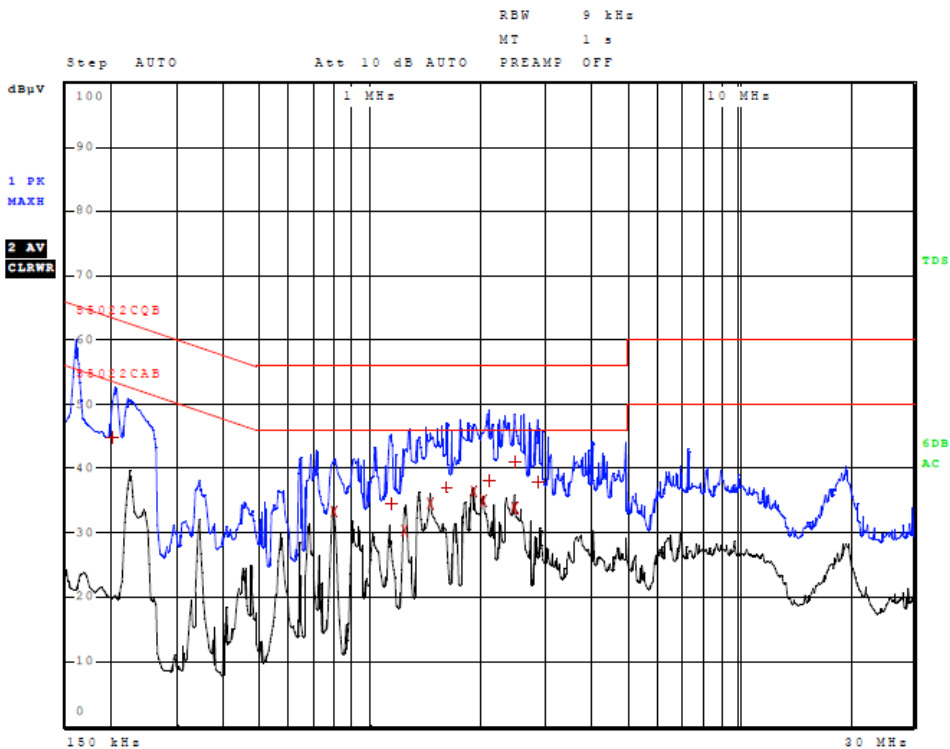

Figure 2 AC Line Conducted emissions of EUT line 2 (#4, EUT USB CPU Adapter)

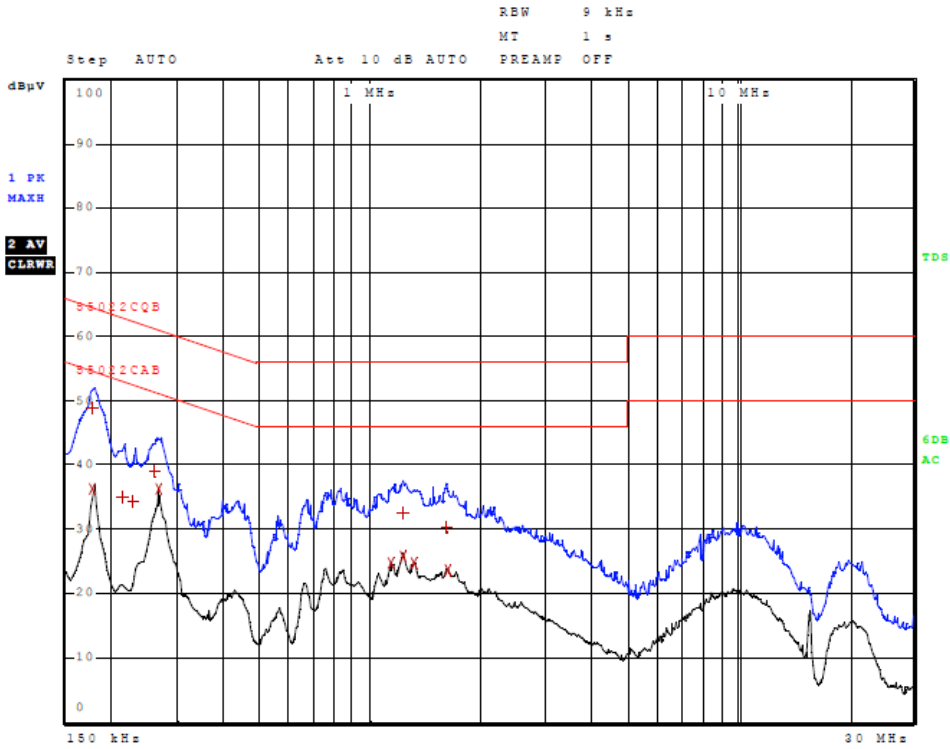

Figure 3 AC Line Conducted emissions of EUT line 1 (#5, EUT AC Adapter 362-00086-01)

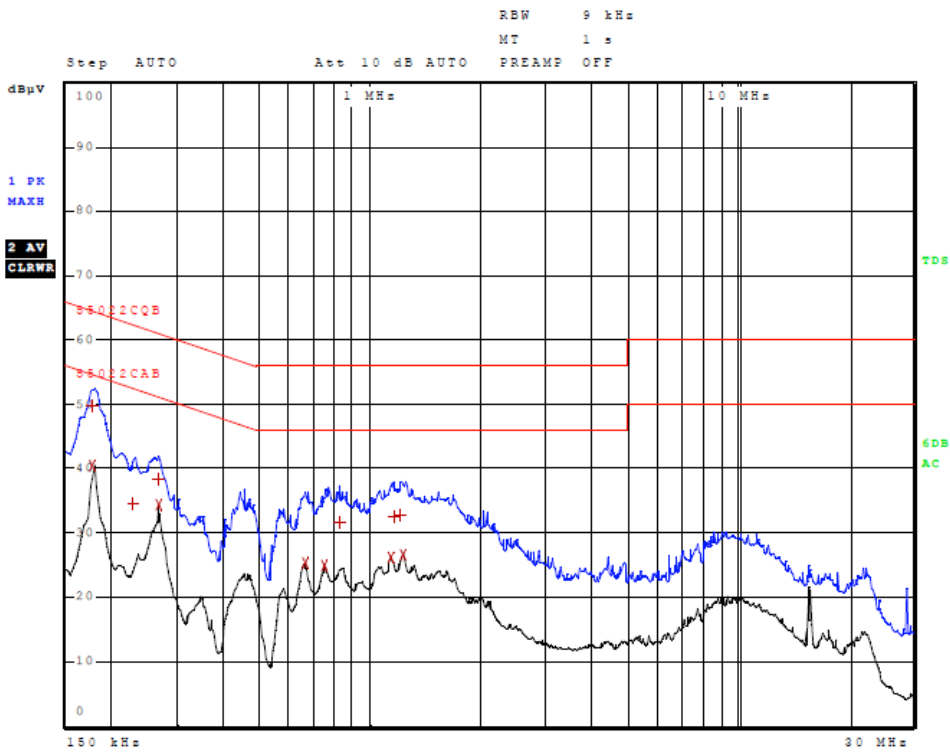

Figure 4 AC Line Conducted emissions of EUT line 2 (#5, EUT AC Adapter 362-00086-01)

**Table 3 AC Line Conducted Emissions Data L1 (#4, EUT USB CPU Adapter)**

Trace	Frequency	Level (dBµV)	Detector	Delta Limit/dB
1	218.000000000 kHz	48.79	Quasi Peak	-14.10
1	1.242000000 MHz	39.73	Quasi Peak	-16.27
1	1.282000000 MHz	38.28	Quasi Peak	-17.72
2	1.482000000 MHz	32.22	Average	-13.78
2	1.850000000 MHz	33.00	Average	-13.00
1	1.850000000 MHz	39.43	Quasi Peak	-16.57
2	1.918000000 MHz	35.67	Average	-10.33
2	2.050000000 MHz	33.50	Average	-12.50
1	2.234000000 MHz	40.76	Quasi Peak	-15.24
2	2.326000000 MHz	26.62	Average	-19.38
1	2.802000000 MHz	35.94	Quasi Peak	-20.06
2	3.770000000 MHz	31.14	Average	-14.86

Other emissions present had amplitudes at least 20 dB below the limit.

**Table 4 AC Line Conducted Emissions Data L2 (#42, EUT USB CPU Adapter)**

Trace	Frequency	Level (dBµV)	Detector	Delta Limit/dB
1	202.000000000 kHz	44.76	Quasi Peak	-18.77
2	794.000000000 kHz	33.20	Average	-12.80
1	1.134000000 MHz	34.63	Quasi Peak	-21.37
2	1.246000000 MHz	30.29	Average	-15.71
2	1.458000000 MHz	34.59	Average	-11.41
1	1.618000000 MHz	37.08	Quasi Peak	-18.92
2	1.906000000 MHz	36.38	Average	-9.62
2	2.026000000 MHz	34.95	Average	-11.05
1	2.094000000 MHz	38.17	Quasi Peak	-17.83
2	2.470000000 MHz	33.87	Average	-12.13
1	2.474000000 MHz	41.07	Quasi Peak	-14.93
1	2.858000000 MHz	37.82	Quasi Peak	-18.18

Other emissions present had amplitudes at least 20 dB below the limit.

**Table 5 AC Line Conducted Emissions Data L1 (#5, EUT -AC Adapter 362-00072-00)**

Trace	Frequency	Level (dBµV)	Detector	Delta Limit/dB
2	178.000000000 kHz	36.28	Average	-18.30
1	178.000000000 kHz	48.88	Quasi Peak	-15.70
1	214.000000000 kHz	34.95	Quasi Peak	-28.10
1	230.000000000 kHz	34.40	Quasi Peak	-28.05
1	262.000000000 kHz	38.99	Quasi Peak	-22.38
2	266.000000000 kHz	36.29	Average	-14.95
2	1.142000000 MHz	24.67	Average	-21.33
2	1.226000000 MHz	25.70	Average	-20.30
1	1.230000000 MHz	32.54	Quasi Peak	-23.46
2	1.314000000 MHz	24.73	Average	-21.27
1	1.618000000 MHz	30.25	Quasi Peak	-25.75
2	1.626000000 MHz	23.59	Average	-22.41

Other emissions present had amplitudes at least 20 dB below the limit.

**Table 6 AC Line Conducted Emissions Data L2 (#5, EUT -AC Adapter 362-00072-00)**

Trace	Frequency	Level (dBµV)	Detector	Delta Limit/dB
2	178.000000000 kHz	40.36	Average	-14.21
1	178.000000000 kHz	49.78	Quasi Peak	-14.79
1	230.000000000 kHz	34.54	Quasi Peak	-27.91
2	266.000000000 kHz	34.32	Average	-16.92
1	266.000000000 kHz	38.43	Quasi Peak	-22.81
2	666.000000000 kHz	25.22	Average	-20.78
2	750.000000000 kHz	24.86	Average	-21.14
1	826.000000000 kHz	31.67	Quasi Peak	-24.33
2	1.138000000 MHz	26.09	Average	-19.91
1	1.158000000 MHz	32.52	Quasi Peak	-23.48
1	1.206000000 MHz	32.64	Quasi Peak	-23.36
2	1.230000000 MHz	26.52	Average	-19.48

Other emissions present had amplitudes at least 20 dB below the limit.

**Summary of Results for AC Line Conducted Emissions Results**

The EUT demonstrated compliance with the AC Line Conducted Emissions requirements of 47CFR Part 15B and other applicable Class B emissions requirements. The worst-case EUT USB CPU configuration demonstrated a minimum margin of -9.6 dB below the FCC/IC requirements. The worst-case EUT AC Adapter configuration #3 demonstrated a minimum margin of -14.2 dB below the FCC/IC requirements. Other emissions were present with amplitudes at least 20 dB below the limit and worst-case amplitudes recorded.

### General Radiated Emissions Procedure

The EUT was arranged in a typical equipment configuration and operated through all available modes during testing. Preliminary testing was performed in a screen room with the EUT positioned 1 meter from the FSM. Radiated emissions measurements were performed to identify the frequencies, which produced the highest emissions. Each radiated emission was then maximized at the OATS location before final radiated emissions measurements were performed. Final data was taken with the EUT located at the OATS at a distance of 3 meters between the EUT and the receiving antenna. The frequency spectrum from 9 kHz to 25,000 MHz was searched for general radiated emissions. Measured emission levels were maximized by EUT placement on the table, rotating the turntable through 360 degrees, varying the antenna height between 1 and 4 meters above the ground plane and changing antenna position between horizontal and vertical polarization. Antennas used were Loop from 9 kHz to 30 MHz, Broadband Biconical from 30 to 200 MHz, Biconilog from 30 to 1000 MHz, Log Periodic from 200 MHz to 1 GHz and or double Ridge or pyramidal horns and mixers above 1 GHz, notch filters and appropriate amplifiers and external mixers were utilized.

**Table 7 General Radiated Emissions Data (worst-case)**

Frequency in MHz	Horizontal Peak (dBµV/m)	Horizontal Quasi-Peak (dBµV/m)	Horizontal Average (dBµV/m)	Vertical Peak (dBµV/m)	Vertical Quasi-Peak (dBµV/m)	Vertical Average (dBµV/m)	Limit @ 3m (dBµV/m)
52.3	31.1	24.4	N/A	27.7	21.9	N/A	40.0
72.1	28.4	20.0	N/A	27.1	21.0	N/A	40.0
150.0	25.6	19.8	N/A	23.1	18.2	N/A	43.5
166.3	27.3	23.0	N/A	29.1	25.0	N/A	43.5
167.0	26.9	23.0	N/A	27.1	22.7	N/A	43.5
192.2	26.2	21.5	N/A	17.3	10.9	N/A	43.5

Other emissions present had amplitudes at least 20 dB below the limit. Peak and Quasi-Peak amplitude emissions are recorded for frequency range below 1000 MHz. Peak and Average amplitude emissions are recorded for frequency range above 1000 MHz.

## **Summary of Results for General Radiated Emissions**

The EUT demonstrated compliance with the radiated emissions requirements of CFR47 Part 15C paragraph 15.209 and RSS-210 Intentional Radiators. The EUT demonstrated a minimum margin of -15.6 dB below the requirements. Other emissions were present with amplitudes at least 20 dB below the Limits.

### **Operation in the Band 2400 – 2483.5 MHz**

The transmitter output power; harmonic and general emissions were measured on an open area test site @ 3 meters. The EUT was placed on a turntable elevated as required above the ground plane and at a distance of 3 meters from the FSM antenna. The table permitted orientation of the EUT in each of three orthogonal axis positions during testing. The peak and quasi-peak amplitude of frequencies below 1000 MHz were measured using a spectrum analyzer. The peak and average amplitude of frequencies above 1000 MHz were measured using a spectrum analyzer. The amplitude of each emission was then recorded from the analyzer display. Emissions radiated outside of the specified bands, except for harmonics, shall be attenuated by at least 50 dB below the level of the fundamental or to the general radiated emission limits, whichever is the lesser attenuation. Plots were taken of transmitter performance for reference in this and other documentation. The amplitude of each radiated emission was measured on the OATS at a distance of 3 meters from the FSM antenna testing was performed on sample representative of production with integral antenna with worse case data provided. The amplitude of each radiated emission was maximized by equipment placement (orientation in three orthogonal axis), raising, and lowering the FSM antenna, changing the antenna polarization, and by rotating the turntable by varying the FSM antenna height, polarization, and by rotating the turntable. A Loop antenna was used for measuring emissions from 0.009 to 30 MHz, Biconilog Antenna for 30 to 1000 MHz, Double-Ridge, and/or Pyramidal Horn Antennas from 1 GHz to 25 GHz. Emissions were measured in dB $\mu$ V/m @ 3 meters.

Refer to figures seven through fourteen showing plots taken of the 2402-2480 MHz performance displaying compliance with the specifications.



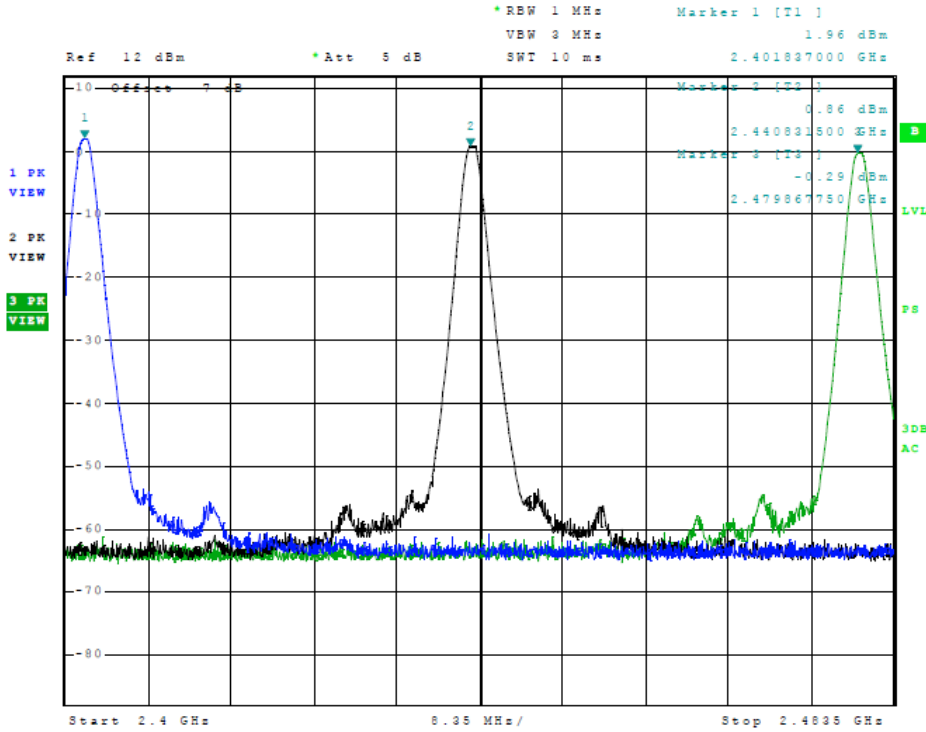

Figure 7 Plot of Transmitter Emissions (Mode 1, Operation in 2402-2480 MHz)

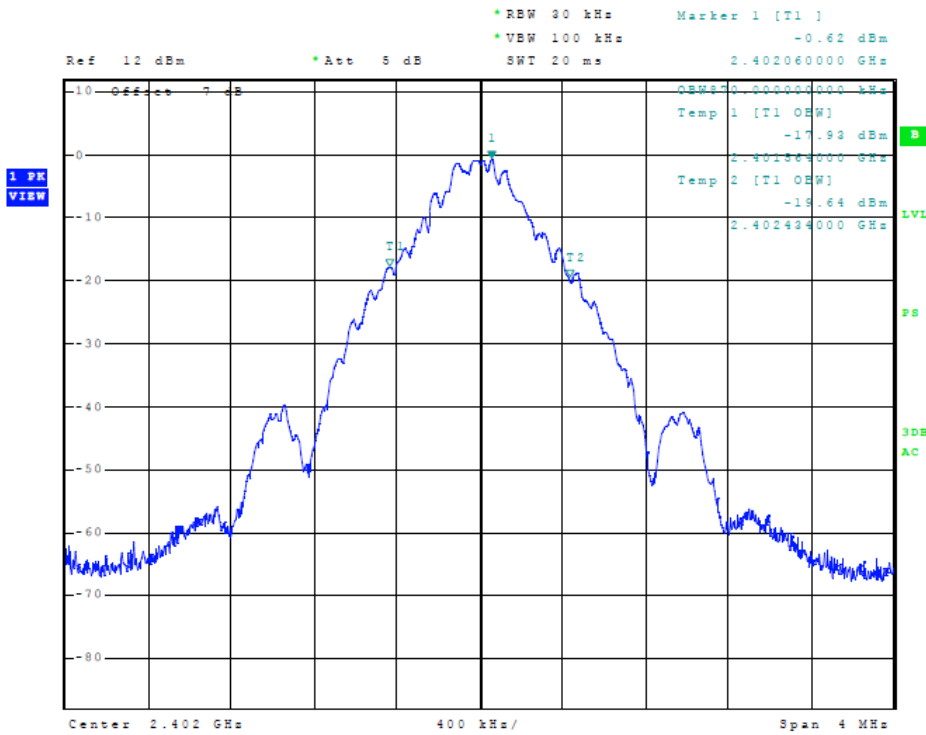

Figure 8 Plot of Transmitter Emissions (Mode 1, 99% Occupied Bandwidth)

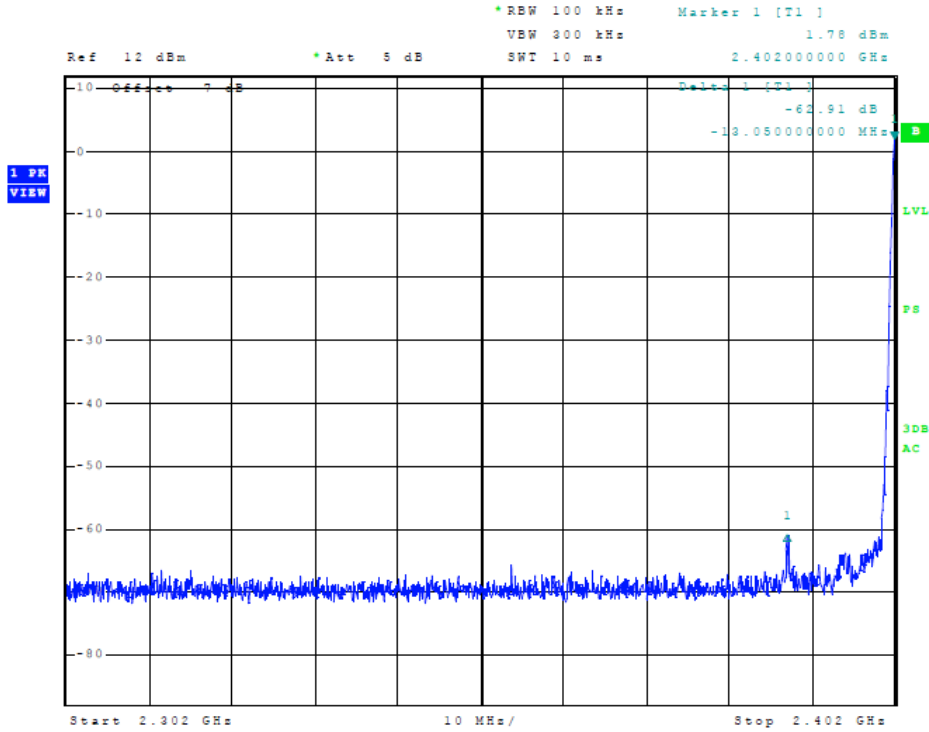

Figure 9 Plot of Transmitter Emissions (Mode 1, Low Band Edge)

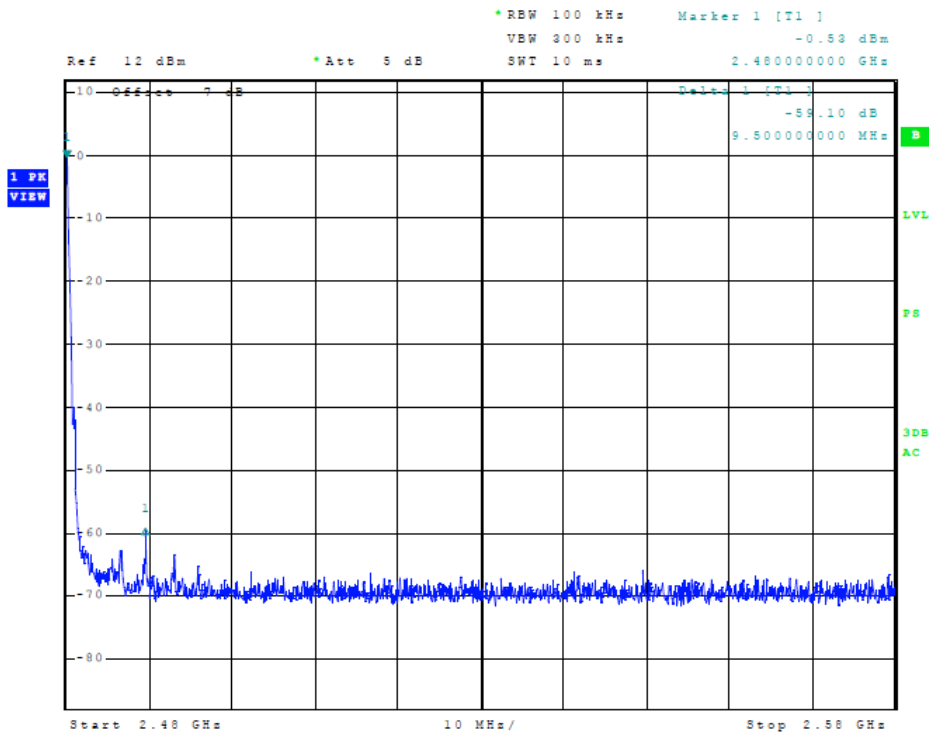

Figure 10 Plot of Transmitter Emissions (Mode 1, High Band Edge)

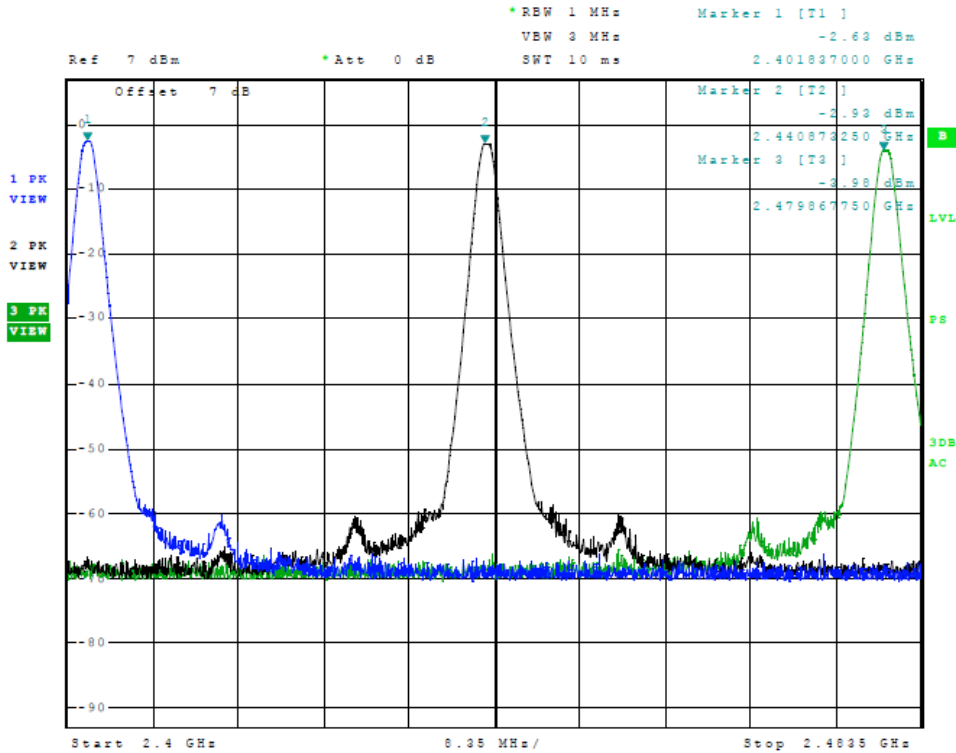

Figure 11 Plot of Transmitter Emissions (Mode 2 Operation in 2402-2480 MHz)

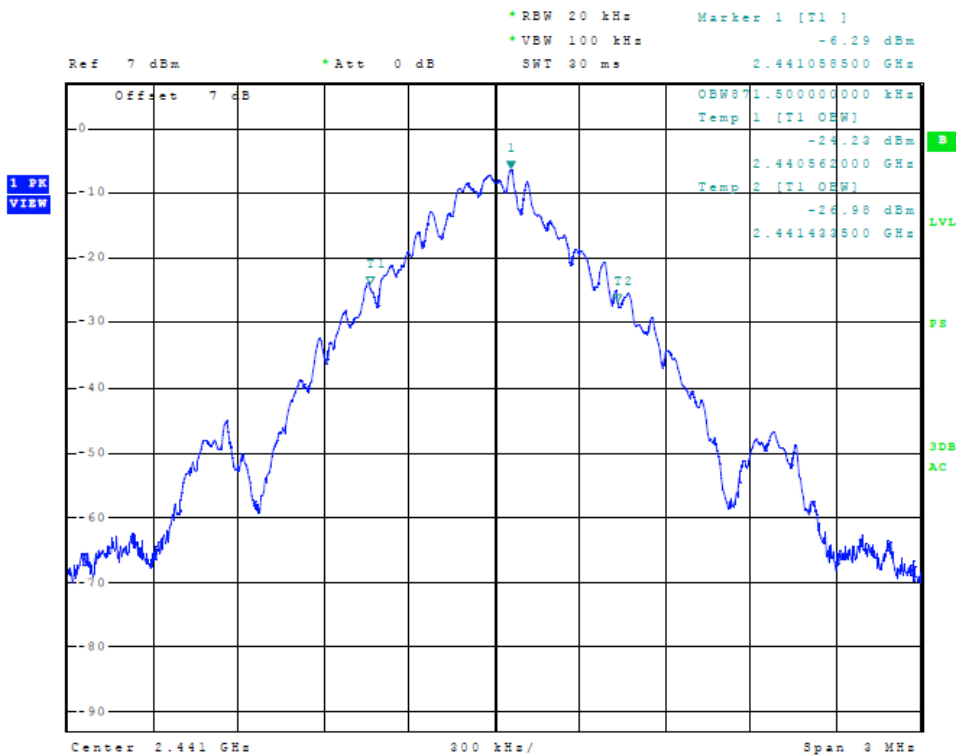

Figure 12 Plot of Transmitter Emissions (Mode 2, 99% Occupied Bandwidth)

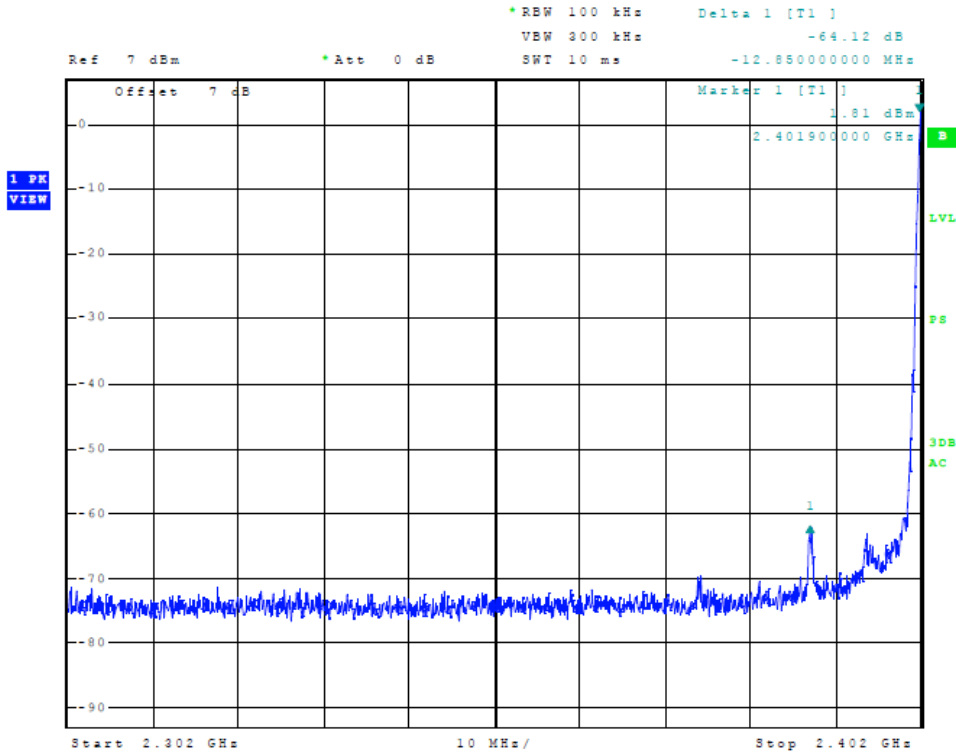

Figure 13 Plot of Transmitter Emissions (Mode 2, Low Band Edge)

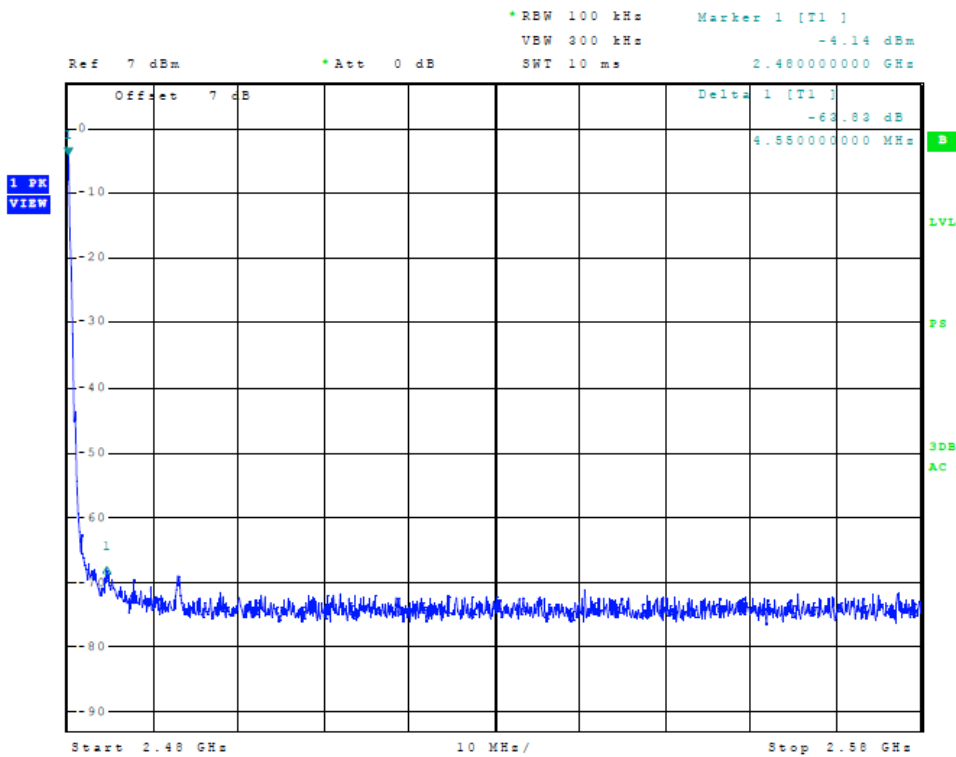

Figure 14 Plot of Transmitter Emissions (Mode 2, High Band Edge)

## Transmitter Emissions Data

**Table 8 Transmitter Radiated Emissions (Mode 1, Mode 1)**

Frequency in MHz	Horizontal Peak (dB $\mu$ V/m)	Horizontal Quasi-Peak (dB $\mu$ V/m)	Horizontal Average (dB $\mu$ V/m)	Vertical Peak (dB $\mu$ V/m)	Vertical Quasi-Peak (dB $\mu$ V/m)	Vertical Average (dB $\mu$ V/m)	Limit @ 3m (dB $\mu$ V/m)
2402.0	87.3	N/A	86.8	93.7	N/A	93.1	94.0
4804.0	42.7	N/A	30.1	43.3	N/A	30.4	54.0
7206.0	15.8	N/A	33.0	46.8	N/A	33.1	54.0
9608.0	47.0	N/A	33.8	47.0	N/A	33.8	54.0
12010.0	50.6	N/A	37.7	50.6	N/A	37.7	54.0
14412.0	52.3	N/A	39.3	52.5	N/A	39.3	54.0
16814.0	55.2	N/A	42.3	55.8	N/A	42.5	54.0
2441.0	86.8	N/A	86.5	93.7	N/A	93.4	94.0
4882.0	43.6	N/A	30.5	43.8	N/A	30.8	54.0
7323.0	45.6	N/A	33.1	46.1	N/A	33.5	54.0
9764.0	47.3	N/A	34.7	48.1	N/A	34.8	54.0
12205.0	50.6	N/A	37.4	50.3	N/A	37.3	54.0
14646.0	52.1	N/A	39.0	52.2	N/A	39.0	54.0
17087.0	57.0	N/A	44.2	57.2	N/A	44.3	54.0
2480.0	85.1	N/A	84.7	93.5	N/A	93.1	94.0
4960.0	45.4	N/A	33.8	43.1	N/A	30.6	54.0
7440.0	45.6	N/A	32.7	46.0	N/A	32.7	54.0
9920.0	47.1	N/A	34.7	47.9	N/A	34.6	54.0
12400.0	49.8	N/A	37.0	49.9	N/A	37.0	54.0
14880.0	52.1	N/A	39.4	51.9	N/A	39.5	54.0
17360.0	56.2	N/A	43.3	56.1	N/A	43.4	54.0

Other emissions present had amplitudes at least 20 dB below the limit. Peak and Quasi-Peak amplitude emissions are recorded for frequency range below 1000 MHz. Peak and Average amplitude emissions are recorded for frequency range above 1000 MHz.

**Table 9 Transmitter Radiated Emissions (Mode 2)**

Frequency in MHz	Horizontal Peak (dBµV/m)	Horizontal Quasi-Peak (dBµV/m)	Horizontal Average (dBµV/m)	Vertical Peak (dBµV/m)	Vertical Quasi-Peak (dBµV/m)	Vertical Average (dBµV/m)	Limit @ 3m (dBµV/m)
2402.0	85.8	N/A	85.3	93.6	N/A	93.3	94.0
4804.0	43.6	N/A	31.6	42.9	N/A	29.9	54.0
7206.0	46.4	N/A	33.0	46.2	N/A	32.9	54.0
9608.0	46.7	N/A	33.8	47.0	N/A	34.1	54.0
12010.0	50.8	N/A	37.7	50.3	N/A	37.7	54.0
14412.0	52.5	N/A	39.2	52.4	N/A	39.6	54.0
16814.0	55.0	N/A	42.3	56.1	N/A	42.6	54.0
2441.0	83.8	N/A	83.5	92.1	N/A	91.7	94.0
4882.0	44.3	N/A	31.3	44.4	N/A	32.0	54.0
7323.0	46.5	N/A	33.7	46.3	N/A	33.5	54.0
9764.0	47.7	N/A	34.8	48.4	N/A	34.8	54.0
12205.0	50.3	N/A	37.5	50.2	N/A	37.4	54.0
14646.0	51.8	N/A	39.0	52.2	N/A	39.1	54.0
17087.0	57.0	N/A	44.3	57.3	N/A	44.4	54.0
2480.0	83.0	N/A	82.7	91.0	N/A	90.7	94.0
4960.0	45.6	N/A	33.4	45.1	N/A	32.7	54.0
7440.0	45.5	N/A	32.5	45.3	N/A	32.6	54.0
9920.0	47.7	N/A	34.9	47.5	N/A	34.6	54.0
12400.0	50.2	N/A	36.9	50.1	N/A	37.0	54.0
14880.0	52.5	N/A	39.5	52.4	N/A	39.6	54.0
17360.0	56.3	N/A	43.2	55.8	N/A	42.8	54.0

Other emissions present had amplitudes at least 20 dB below the limit. Peak and Quasi-Peak amplitude emissions are recorded for frequency range below 1000 MHz. Peak and Average amplitude emissions are recorded for frequency range above 1000 MHz.

## ***Summary of Results for Transmitter Radiated Emissions of Intentional Radiator***

The EUT demonstrated compliance with the radiated emissions requirements of FCC 47CFR Part 15.249, Industry Canada RSS-GEN issue 4, RSS-210 Issue 9 Intentional Radiator regulations. The EUT worst-case test sample configuration demonstrated minimum average margin of -0.6 below the average emission limit for the fundamental. The EUT worst-case configuration demonstrated minimum radiated harmonic emission margin of -9.6 dB below the limit. No other radiated emissions were found in the restricted bands less than 20 dB below limits than those recorded in this report. Other emissions were present with amplitudes at least 20 dB below the limits.

## **Statement of Modifications and Deviations**

No modifications to the EUT were required for the equipment to demonstrate compliance with the CFR47 Part 15C , Industry Canada RSS-210, and RSS-GEN emission requirements. There were no deviations to the specifications.

## Annex

- Annex A Measurement Uncertainty Calculations
- Annex B Rogers Labs Test Equipment List
- Annex C Rogers Qualifications
- Annex D FCC Site Registration Letter
- Annex E Industry Canada Site Registration Letter



### **Annex A Measurement Uncertainty Calculations**

Measurement uncertainty calculations were made for the laboratory. Result of measurement uncertainty calculations are recorded below for AC line conducted and radiated emission measurements.

Measurement Uncertainty	$U_{(E)}$	$U_{(lab)}$
3 Meter Horizontal 30-200 MHz Measurements	2.08	4.16
3 Meter Vertical 30-200 MHz Measurements	2.16	4.33
3 Meter Vertical Measurements 200-1000 MHz	2.99	5.97
10 Meter Horizontal Measurements 30-200 MHz	2.07	4.15
10 Meter Vertical Measurements 30-200 MHz	2.06	4.13
10 Meter Horizontal Measurements 200-1000 MHz	2.32	4.64
10 Meter Vertical Measurements 200-1000 MHz	2.33	4.66
3 Meter Measurements 1-6 GHz	2.57	5.14
3 Meter Measurements 6-18 GHz	2.58	5.16
AC Line Conducted	1.72	3.43

## Annex B Rogers Labs Test Equipment List

List of Test Equipment	Calibration	Date	Due
Spectrum Analyzer: Rohde & Schwarz ESU40		5/16	5/17
Spectrum Analyzer: HP 8562A, HP Adapters: 11518, 11519, and 11520		5/16	5/17
Mixers: 11517A, 11970A, 11970K, 11970U, 11970V, 11970W			
Spectrum Analyzer: HP 8591EM		5/16	5/17
Antenna: EMCO Biconilog Model: 3143		5/16	5/17
Antenna: Sunol Biconilog Model: JB6		10/15	10/16
Antenna: EMCO Log Periodic Model: 3147		10/15	10/16
Antenna: Com Power Model: AH-118		10/15	10/16
Antenna: Com Power Model: AH-840		5/16	5/18
Antenna: Antenna Research Biconical Model: BCD 235		10/15	10/16
Antenna: EMCO 6509		10/15	10/16
LISN: Compliance Design Model: FCC-LISN-2.Mod.cd, 50 $\mu$ Hy/50 ohm/0.1 $\mu$ f		10/15	10/16
R.F. Preamp CPPA-102		10/15	10/16
Attenuator: HP Model: HP11509A		10/15	10/16
Attenuator: Mini Circuits Model: CAT-3		10/15	10/16
Attenuator: Mini Circuits Model: CAT-3		10/15	10/16
Cable: Belden RG-58 (L1)		10/15	10/16
Cable: Belden RG-58 (L2)		10/15	10/16
Cable: Belden 8268 (L3)		10/15	10/16
Cable: Time Microwave: 4M-750HF290-750		10/15	10/16
Cable: Time Microwave: 10M-750HF290-750		10/15	10/16
Frequency Counter: Leader LDC825		2/16	2/17
Oscilloscope Scope: Tektronix 2230		2/16	2/17
Wattmeter: Bird 43 with Load Bird 8085		2/16	2/17
Power Supplies: Sorensen SRL 20-25, SRL 40-25, DCR 150, DCR 140		2/16	2/17
R.F. Generators: HP 606A, HP 8614A, HP 8640B		2/16	2/17
R.F. Power Amp 65W Model: 470-A-1010		2/16	2/17
R.F. Power Amp 50W M185- 10-501		2/16	2/17
R.F. Power Amp A.R. Model: 10W 1010M7		2/16	2/17
R.F. Power Amp EIN Model: A301		2/16	2/17
LISN: Compliance Eng. Model 240/20		2/16	2/17
LISN: Fischer Custom Communications Model: FCC-LISN-50-16-2-08		2/16	2/17
Antenna: EMCO Dipole Set 3121C		2/16	2/17
Antenna: C.D. B-101		2/16	2/17
Antenna: Solar 9229-1 & 9230-1		2/16	2/17
Audio Oscillator: H.P. 201CD		2/16	2/17
ELGAR Model: 1751		2/16	2/17
ELGAR Model: TG 704A-3D		2/16	2/17
ESD Test Set 2010i		2/16	2/17
Fast Transient Burst Generator Model: EFT/B-101		2/16	2/17
Field Intensity Meter: EFM-018		2/16	2/17
KEYTEK Ecat Surge Generator		2/16	2/17
Shielded Room 5 M x 3 M x 3.0 M			

## **Annex C Rogers Qualifications**

**Scot D. Rogers, Engineer**

### **Rogers Labs, Inc.**

Mr. Rogers has approximately 17 years' experience in the field of electronics. Engineering experience includes six years in the automated controls industry and remaining years working with the design, development and testing of radio communications and electronic equipment.

#### Positions Held

Systems Engineer: A/C Controls Mfg. Co., Inc. 6 Years

Electrical Engineer: Rogers Consulting Labs, Inc. 5 Years

Electrical Engineer: Rogers Labs, Inc. Current

#### Educational Background

- 1) Bachelor of Science Degree in Electrical Engineering from Kansas State University.
- 2) Bachelor of Science Degree in Business Administration Kansas State University.
- 3) Several Specialized Training courses and seminars pertaining to Microprocessors and Software programming.

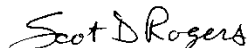

Scot D. Rogers



**Annex D FCC Site Registration Letter**

**FEDERAL COMMUNICATIONS COMMISSION**

**Laboratory Division  
7435 Oakland Mills Road  
Columbia, MD 21046**

April 16, 2015

Registration Number: 90910

Rogers Labs, Inc.  
4405 West 259th Terrace  
Louisburg, KS 66053

Attention: Scot Rogers,

Re: Measurement facility located at Louisburg  
3 & 10 meter site  
Date of Renewal: April 16, 2015

Dear Sir or Madam:

Your request for renewal of the registration of the subject measurement facility has been received. The information submitted has been placed in your file and the registration has been renewed. The name of your organization will remain on the list of facilities whose measurement data will be accepted in conjunction with applications for Certification under Parts 15 or 18 of the Commission's Rules. Please note that the file must be updated for any changes made to the facility and the registration must be renewed at least every three years.

Measurement facilities that have indicated that they are available to the public to perform measurement services on a fee basis may be found on the FCC website [www.fcc.gov](http://www.fcc.gov) under E-Filing, OET Equipment Authorization Electronic Filing, Test Firms.

Sincerely,

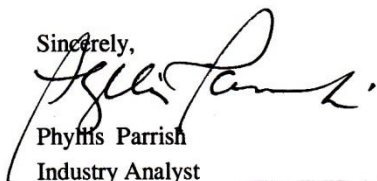
  
Phyllis Parrish  
Industry Analyst

Rogers Labs, Inc.  
4405 West 259<sup>th</sup> Terrace  
Louisburg, KS 66053  
Phone/Fax: (913) 837-3214  
Revision 1

Garmin International, Inc.  
Model: A03069  
Test #: 160712  
Test to: CFR47 15C, RSS-Gen RSS-210  
File: A03069 TstRpt 160712

SN's: 79279b, 79286b  
FCC ID: IPH-03069  
IC: 1792A-03069  
Date: January 5, 2017  
Page 36 of 37

## Annex E Industry Canada Site Registration Letter

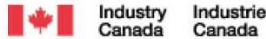

June 08, 2015

OUR FILE: 46405-3041  
Authorization No: 010277847-001

Rogers Labs Inc.  
4405 West 259th Terrace  
Louisburg, KS  
USA  
66053

**Attention:** Mr. Scot D. Rogers

Dear Sir:

The Bureau has received your application for the renewal of 3m OATS. Be advised that the information received was satisfactory to Industry Canada. The following number(s) is now associated to the site(s) for which registration / renewal was sought ( **Site# 3041A-1** ). Please reference the appropriate site number in the body of test reports containing measurements performed on the site. In addition, please keep for your records the following information;

- The company address code associated to the site(s) located at the above address is: **3041A**

Furthermore, to obtain or renew a unique site number, the applicant shall demonstrate that the site has been accredited to ANSI C63.4-2009 or later. A scope of accreditation indicating the accreditation by a recognized accreditation body to ANSI C63.4-2009 or later shall be accepted. Please indicate in a letter the previous assigned site number if applicable and the type of site (example: 3 metre OATS or 3 metre chamber). If the test facility is not accredited to ANSI C63.4-2009 or later, the test facility shall submit test data demonstrating full compliance with the ANSI standard. The Bureau will evaluate the filing to determine if recognition shall be granted.

The frequency for re-validation of the test site and the information that is required to be filed or retained by the testing party shall comply with the requirements established by the accrediting organization. However, in all cases, test site re-validation shall occur on an interval not to exceed **three years**. There is no fee or form associated with an OATS filing. OATS submissions are encouraged to be submitted electronically to the Bureau using the following URL; [http://strategis.ic.gc.ca/epic/internet/inceb-bhst.nsf/en/h\\_tt00052e.html](http://strategis.ic.gc.ca/epic/internet/inceb-bhst.nsf/en/h_tt00052e.html).

If you have any questions, you may contact the Bureau by e-mail at [certification.bureau@ic.gc.ca](mailto:certification.bureau@ic.gc.ca) Please reference our file and submission number above for all correspondence.

Yours sincerely,

A handwritten signature in black ink, appearing to read "Bill Payn".

Bill Payn  
For: Wireless Laboratory Manager  
Certification and Engineering Bureau  
3701 Carling Ave., Building 94  
P.O. Box 11490, Station AH@  
Ottawa, Ontario K2H 8S2  
Email: [certification.bureau@ic.gc.ca](mailto:certification.bureau@ic.gc.ca)

Rogers Labs, Inc.  
4405 West 259<sup>th</sup> Terrace  
Louisburg, KS 66053  
Phone/Fax: (913) 837-3214  
Revision 1

Garmin International, Inc.  
Model: A03069  
Test #: 160712  
Test to: CFR47 15C, RSS-Gen RSS-210  
File: A03069 TstRpt 160712

SN's: 79279b, 79286b  
FCC ID: IPH-03069  
IC: 1792A-03069  
Date: January 5, 2017  
Page 37 of 37