



SAR Test Setup Photographs

A non-standard test setup was used for SAR testing based on guidance from the FCC. The operational description contains additional information.

EUT Side Definition	
Mode	Side
1	Front
2	Back





Phantom Position : Flat	EUT side : Front
Spacing to phantom : Li-ion battery pack_25mm	Accessory : N/A

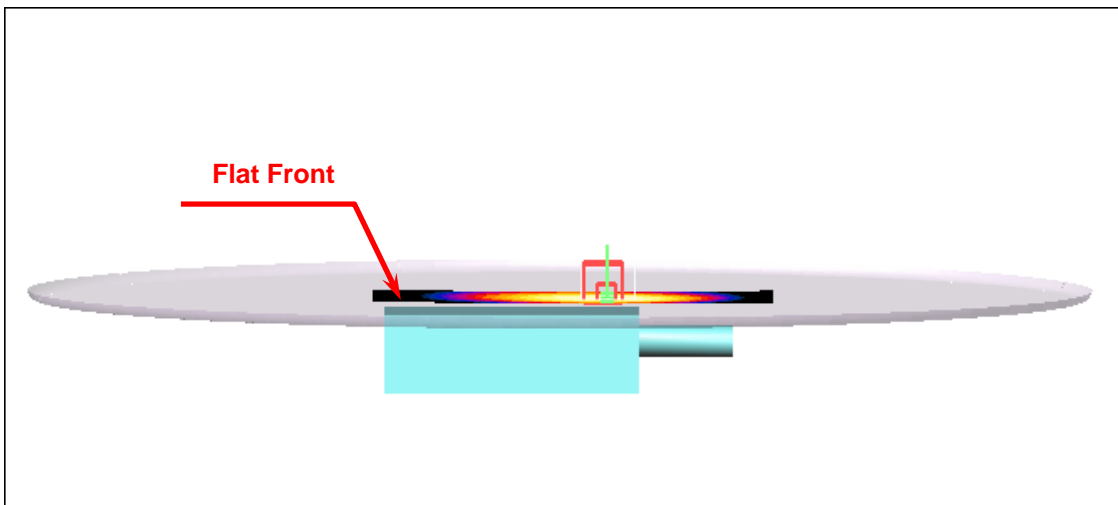
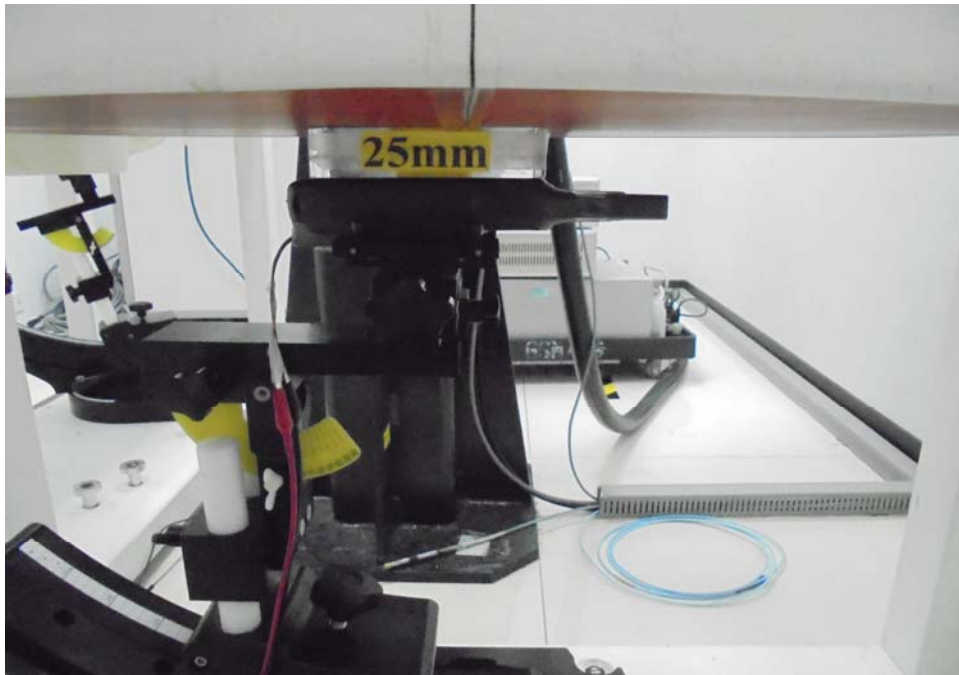

Phantom Position : Flat	EUT side : Front
Spacing to phantom : Alkaline pack_25mm	Accessory : N/A

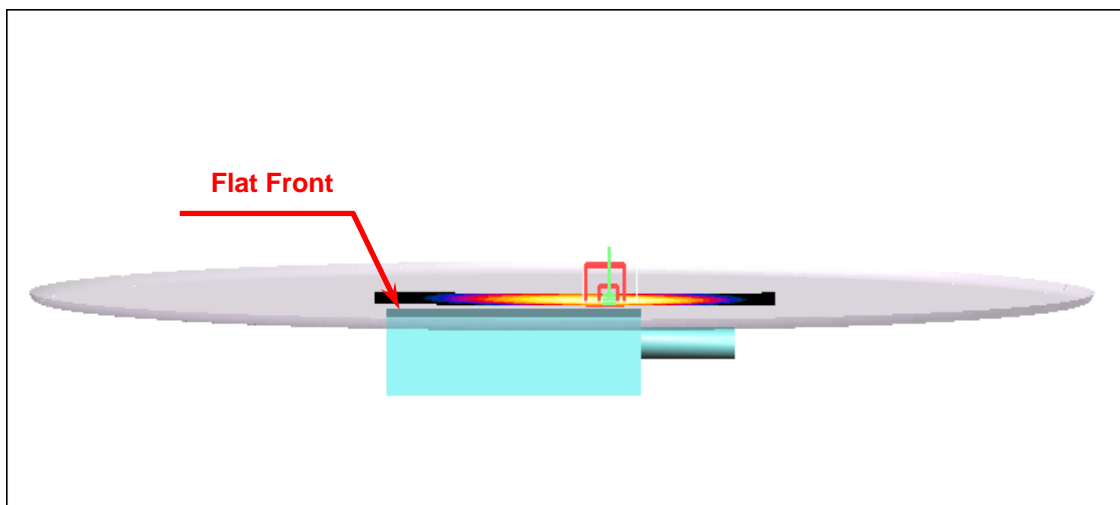
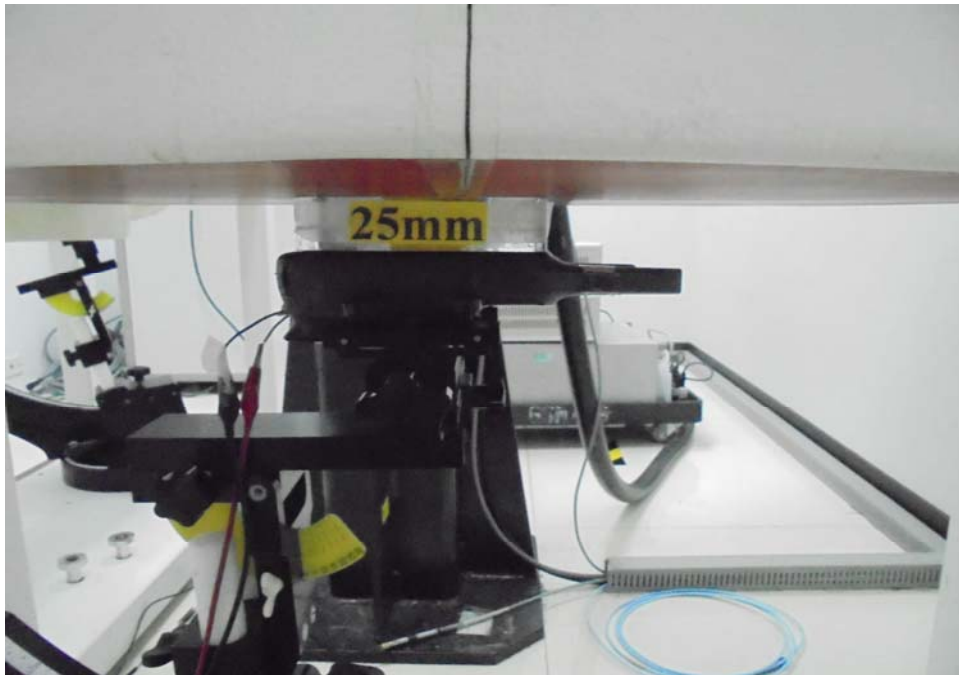

Phantom Position : Flat	EUT side : Back
Spacing to phantom : Li-ion battery pack_10mm	Accessory : 010-10347-00- Headset

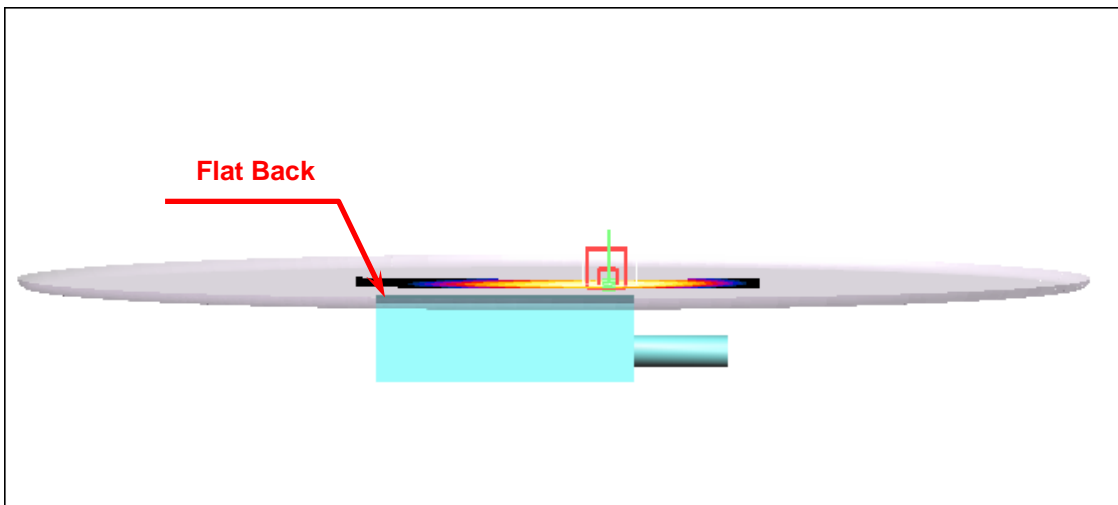
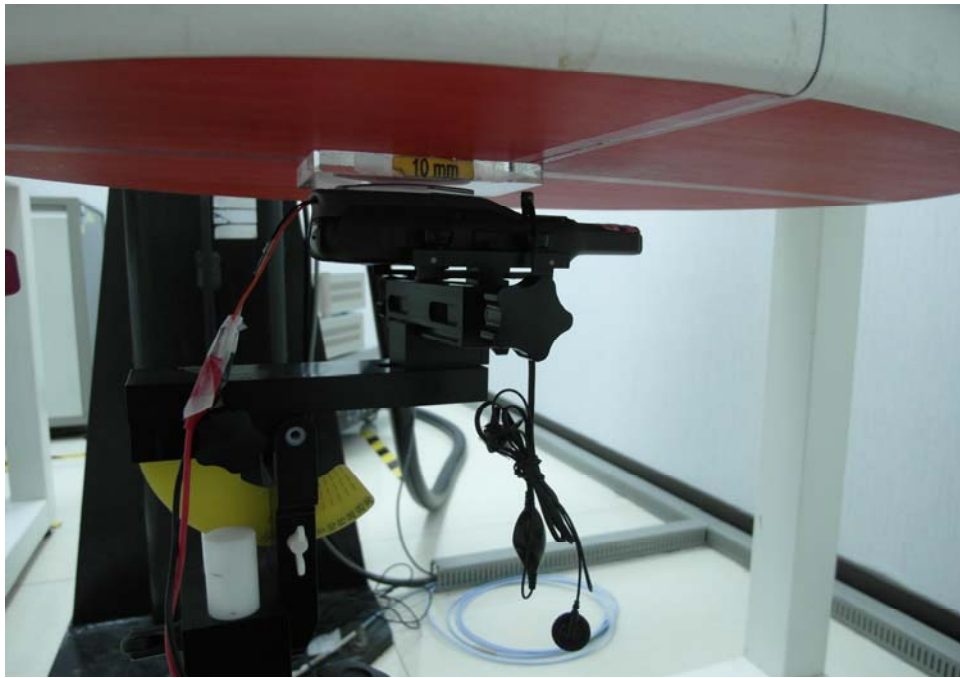

Phantom Position : Flat	EUT side : Back
Spacing to phantom : Li-ion battery pack_10mm	Accessory : 010-11757-00- Headset

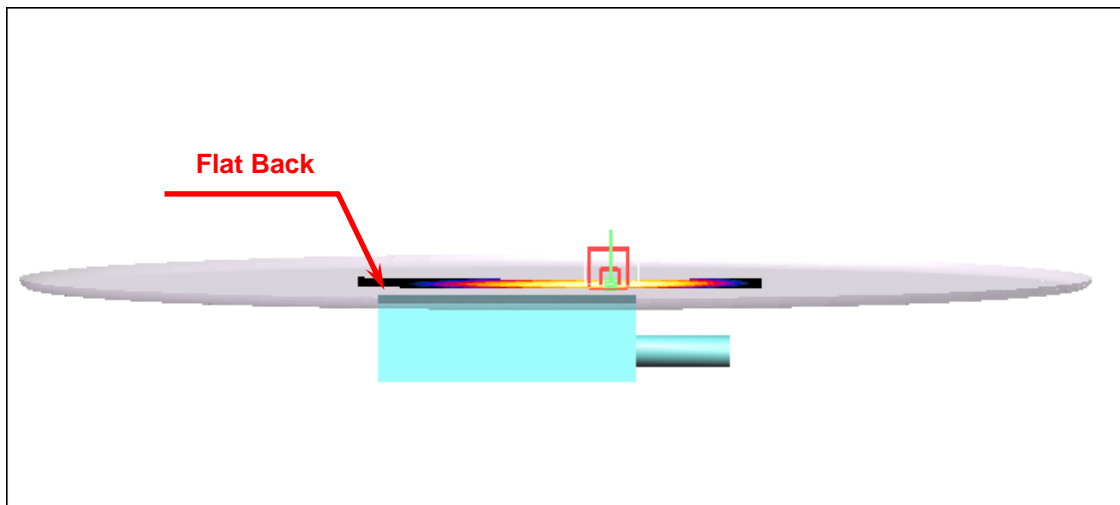
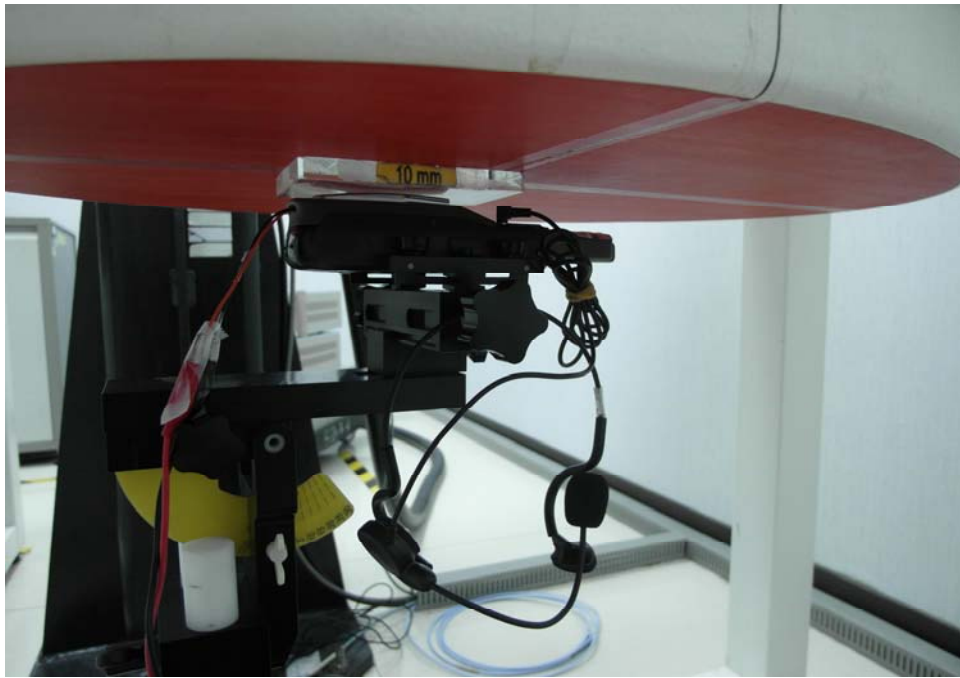

Phantom Position : Flat	EUT side : Back
Spacing to phantom : Li-ion battery pack_10mm	Accessory : 010-10346-00- Headset

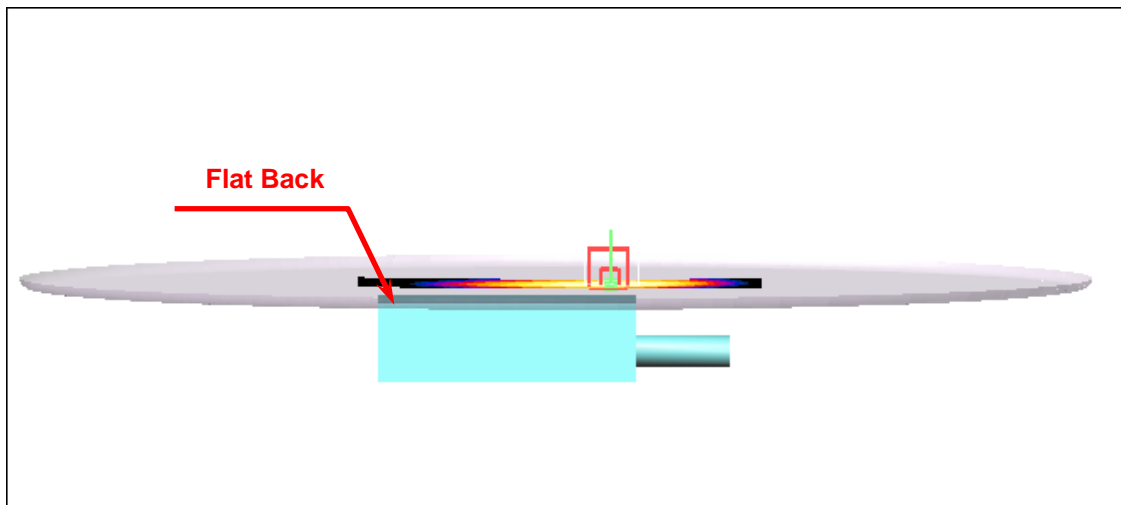
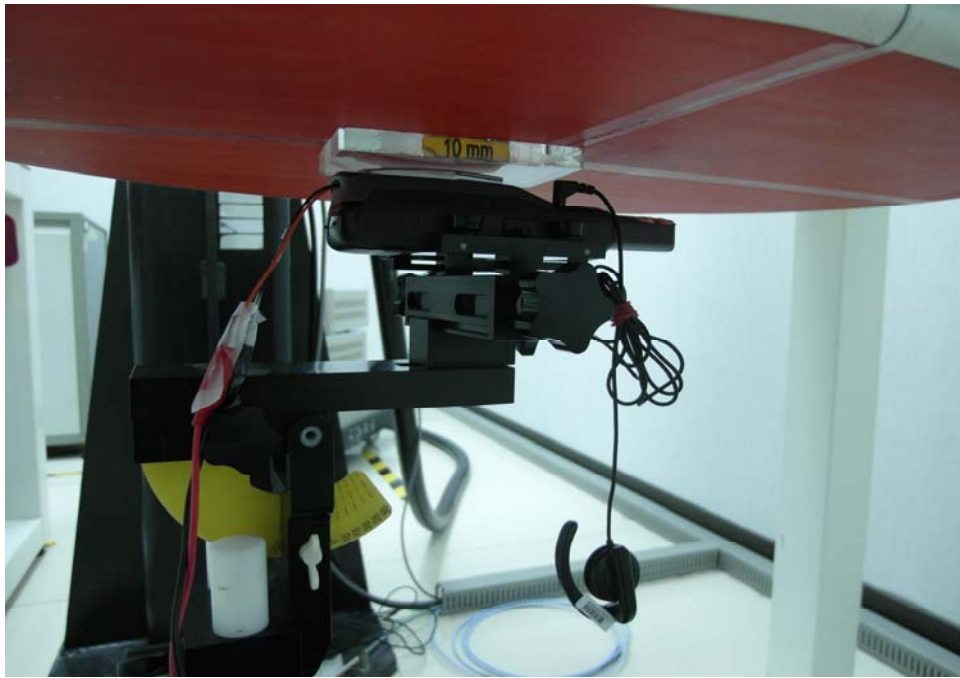

Phantom Position : Flat	EUT side : Back
Spacing to phantom : Alkaline battery pack_10mm	Accessory : 010-10347-00- Headset

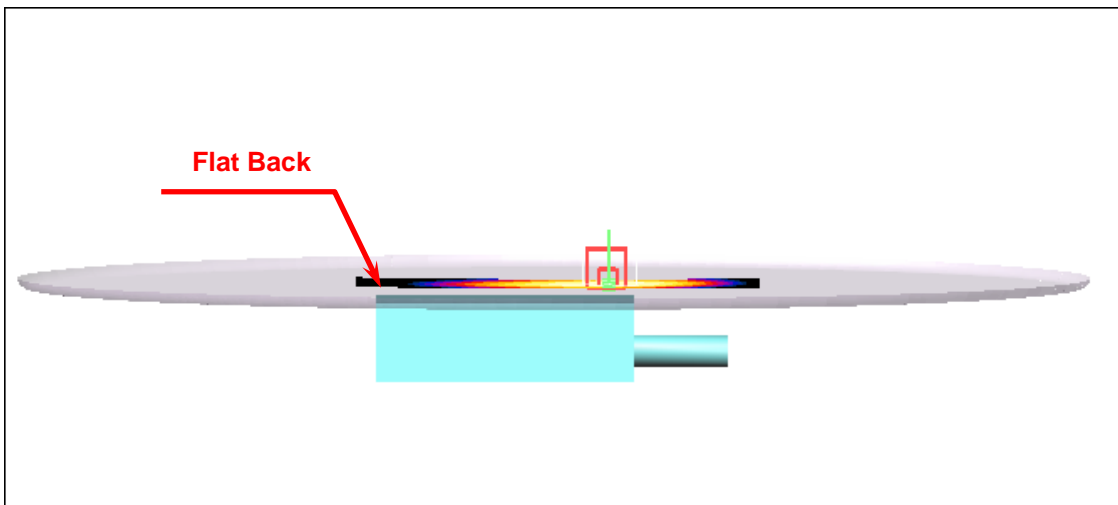

Phantom Position : Flat	EUT side : Back
Spacing to phantom : Li-ion battery pack_0mm	Accessory : 010-11734-20-Belt clip & 010-10347-00-Headset

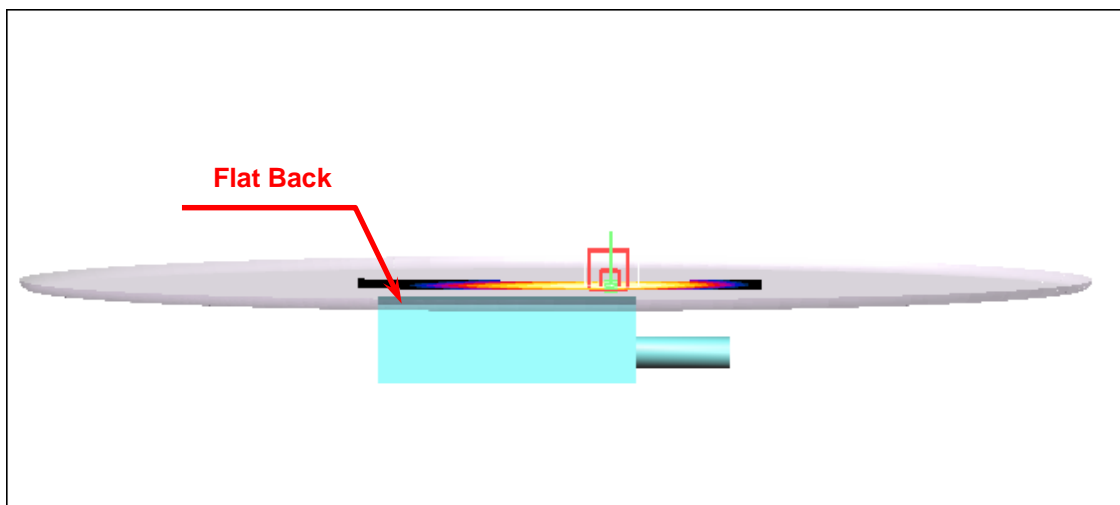

Phantom Position : Flat	EUT side : Back
Spacing to phantom : Li-ion battery_0mm	Accessory : 010-11022-20 -Belt clip & 010-10347-00-Headset

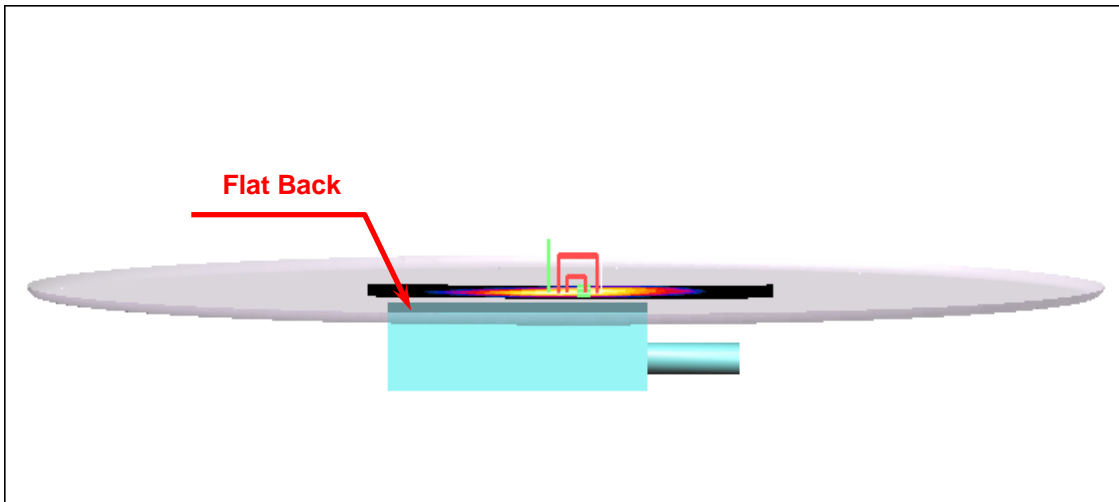

Phantom Position : Flat	EUT side : Back
Spacing to phantom : Li-ion battery pack_0mm	Accessory : 145-01383-00 + 013-00063-00 -Belt clip & 010-10347-00-Headset

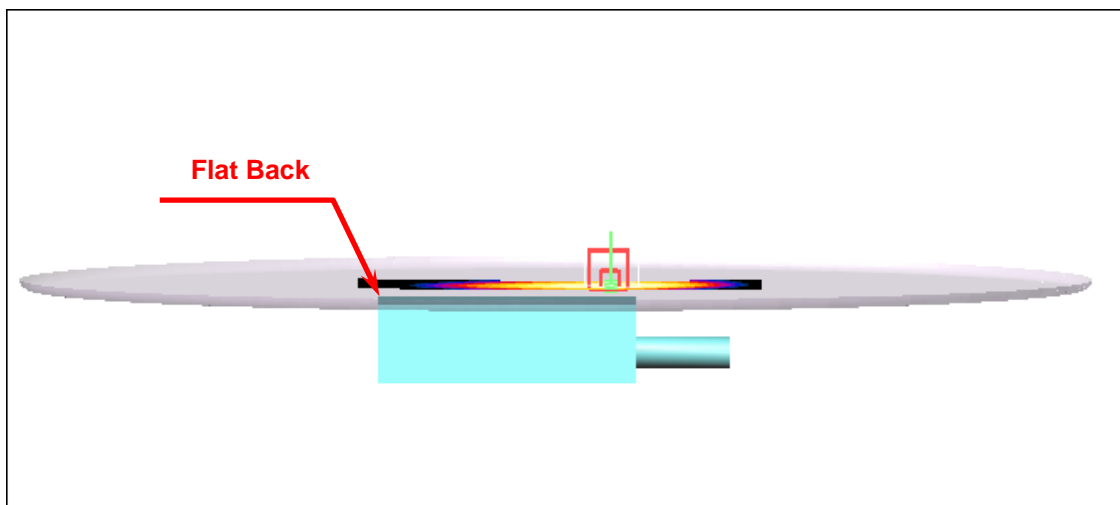
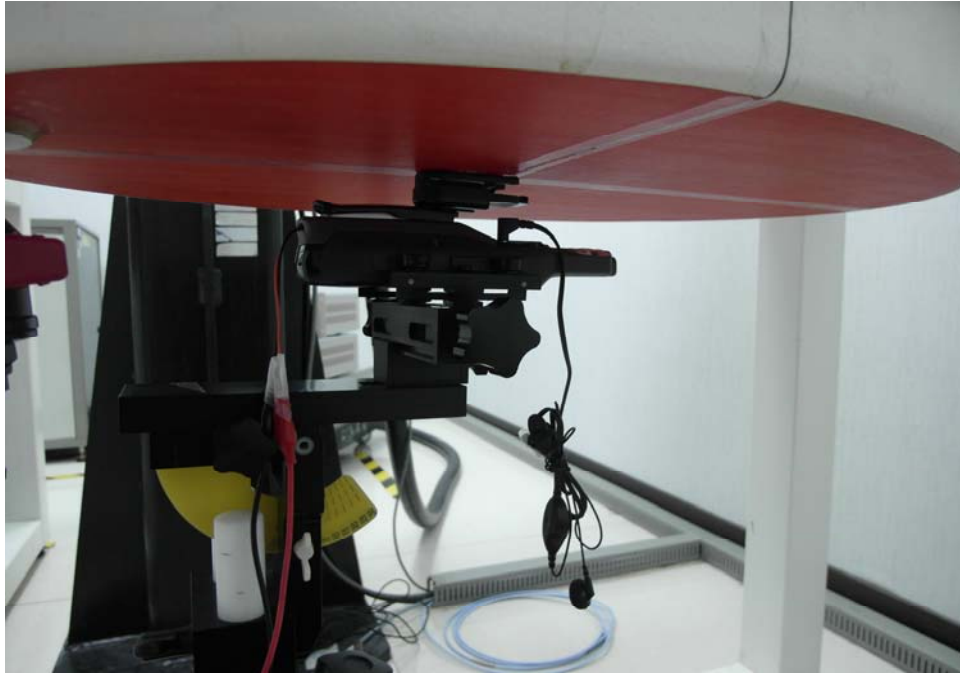

Phantom Position : Flat	EUT side : Back
Spacing to phantom : Alkaline battery_0mm	Accessory : 010-11022-20 -Belt clip & 010-10347-00-Headset

