

# Application For Grant of Certification

FOR

FOR

Model: A02564  
2402-2480 MHz  
Low Power Transmitter  
FCC ID: IPH-02564  
IC: 1792A-02564

FOR

## Garmin International, Inc.

1200 East 151st Street  
Olathe, KS 66062

Test Report Number: 141010

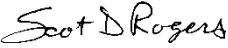
Authorized Signatory:   
Scot D. Rogers

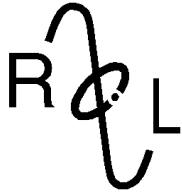

**ROGERS LABS, INC.**

4405 West 259<sup>th</sup> Terrace  
 Louisburg, KS 66053  
 Phone / Fax (913) 837-3214

**Engineering Test Report For  
 Grant of Certification Application**

FOR  
**CFR 47, PART 15C - Intentional Radiators**  
**CFR 47 Paragraph 15.249**  
**License Exempt Intentional Radiator**

For

**Garmin International, Inc.**

1200 East 151st Street  
 Olathe, KS 66062

**Model: A02564**

**Low Power Transmitter**

Frequency Range 2402-2480 MHz  
 FCC ID#: IPH-02564  
 IC: 1792A-02564

Test Date: October 10, 2014

Certifying Engineer: *Scot D. Rogers*  
 Scot D. Rogers  
 Rogers Labs, Inc.  
 4405 West 259<sup>th</sup> Terrace  
 Louisburg, KS 66053  
 Telephone/Facsimile: (913) 837-3214

This report shall not be reproduced except in full, without the written approval of the laboratory.  
 This report must not be used by the client to claim product certification, approval, or  
 endorsement by NVLAP, NIST, or any agency of the Federal Government.



# Table Of Contents

**TABLE OF CONTENTS..... 3**

**REVISIONS..... 4**

**FORWARD ..... 5**

**OPINION / INTERPRETATION OF RESULTS ..... 5**

**EQUIPMENT TESTED..... 5**

**EQUIPMENT FUNCTION AND CONFIGURATION..... 6**

    Equipment Configuration.....7

**APPLICATION FOR CERTIFICATION..... 8**

**APPLICABLE STANDARDS & TEST PROCEDURES ..... 9**

**EQUIPMENT TESTING PROCEDURES ..... 9**

    AC Line Conducted Emission Test Procedure .....9

    Radiated Emission Test Procedure.....9

        Diagram 1 Test arrangement for Conducted emissions ..... 10

        Diagram 2 Test arrangement for radiated emissions of tabletop equipment..... 11

        Diagram 3 Test arrangement for radiated emissions tested on Open Area Test Site (OATS)..... 12

**TEST SITE LOCATIONS ..... 12**

**LIST OF TEST EQUIPMENT ..... 13**

**UNITS OF MEASUREMENTS ..... 14**

**ENVIRONMENTAL CONDITIONS..... 14**

**INTENTIONAL RADIATORS..... 14**

    Antenna Requirements .....14

    Restricted Bands of Operation.....14

        Table 1 Radiated Emissions in Restricted Frequency Bands Data ..... 15

    Summary of Results for Radiated Emissions in Restricted Bands .....16

    AC Line Conducted EMI Procedure .....16

        Figure 1 AC Line Conducted emissions of EUT line 1 (EUT AC Adapter) ..... 17



Figure 2 AC Line Conducted emissions of EUT line 2 (EUT AC Adapter) .....17

Figure 3 AC Line Conducted emissions of EUT line 1 (EUT-USB-CPU).....18

Figure 4 AC Line Conducted emissions of EUT line 2 (EUT-USB-CPU).....18

Table 2 AC Line Conducted Emissions Data L1 (EUT-AC Adapter).....19

Table 3 AC Line Conducted Emissions Data L2 (EUT-AC Adapter).....19

Table 4 AC Line Conducted Emissions Data L1 (EUT-USB-CPU) .....20

Table 5 AC Line Conducted Emissions Data L2 (EUT-USB-CPU) .....20

**Summary of Results for AC Line Conducted Emissions Results .....20**

**General Radiated Emissions Procedure .....21**

Table 6 General Radiated Emissions from EUT Data .....21

**Summary of Results for General Radiated Emissions .....21**

**Operation in the Band 2400 – 2483.5 MHz .....22**

Figure 5 Plot of Transmitter Emissions (In 2402-2480 MHz Band, Mode 1) .....23

Figure 6 Plot of Transmitter Emissions (99% Occupied Bandwidth, Mode 1) .....23

Figure 7 Plot of Transmitter Emissions (In 2402-2480 MHz Band, Mode 2) .....24

Figure 8 Plot of Transmitter Emissions (99% Occupied Bandwidth, Mode 2) .....24

Figure 9 Plot of Transmitter Emissions (Low Band Edge).....25

Figure 10 Plot of Low Band Edge (High Band Edge) .....25

**Transmitter Emissions Data.....26**

Table 7 Transmitter Radiated Emissions (2402-2480 MHz Band mode 1).....26

Table 8 Transmitter Radiated Emissions (2402-2480 MHz Band mode 2).....27

**Summary of Results for Transmitter Radiated Emissions of Intentional Radiator .....28**

**STATEMENT OF MODIFICATIONS AND DEVIATIONS ..... 28**

**ANNEX..... 29**

**Annex A Measurement Uncertainty Calculations.....30**

**Annex B Rogers Labs Test Equipment List.....31**

**Annex C Rogers Qualifications .....32**

**Annex D FCC Site Registration Letter.....33**

**Annex E Industry Canada Site Registration Letter .....34**

## Revisions

Revision 1 Issued June 12, 2015



## Forward

The following information is submitted for consideration in obtaining Grant of Certification for low power intentional radiator per CFR 47 Paragraph 15.249, and Industry Canada RSS-210, operation in the 2400 – 2483.5 MHz band.

Name of Applicant: Garmin International, Inc.  
1200 East 151st Street  
Olathe, KS 66062

Model: A02564

FCC I.D.: IPH-02564 Industry Canada ID: 1792A-02564

Frequency Range: 2402-2480 MHz

Operating power: 2402-2480 Maximum Average power 91.8 dB $\mu$ V/m @ 3 meters (and peak 92.4 dB $\mu$ V/m @ 3 meters, 1,045 kHz (99% OBW)

## Opinion / Interpretation of Results

| Tests Performed                                 | Margin (dB) | Results  |
|---|-------------|----------|
| Emissions as per CFR 47 paragraphs 2 and 15.205 | -5.9        | Complies |
| Emissions as per CFR 47 paragraphs 2 and 15.207 | -8.9        | Complies |
| Emissions as per CFR 47 paragraphs 2 and 15.209 | -12.8       | Complies |
| Harmonic Emissions per CFR 47 15.249            | -5.9        | Complies |

## Equipment Tested

| <u>Equipment</u> | <u>Model / PN</u>  | <u>Serial Number</u> |
|------------------|--------------------|----------------------|
| EUT              | A02564             | 3980059915           |
| EUT (#2)         | A02564             | 3892059873           |
| AC Adapter       | 362-00072-00       | P122423699A4         |
| CLA              | 013-00434-00       | E1322001315          |
| USB Cable        | 320-00911-00       | N/A                  |
| Laptop Computer  | studio XPS (PP35L) | 921LBN1              |
| USB Printer      | Dell 0N5819        | 5D1SL61              |
| DC Power supply  | 1670A              | N961313540           |

Test results in this report relate only to the items tested.

## Equipment Function and Configuration

The EUT is a portable GPS navigation computer system providing mapping display and interface options as presented below in configuration diagrams. The design offers end user opportunity to utilize GPS information for display of location and navigational aid and incorporates wireless connectivity. The EUT incorporates low power transmitter with multiple protocol operation capability in the 2402-2480 MHz frequency band. The design offers interface capabilities wirelessly or through USB communications port with compliant equipment or power adapters. The EUT was arranged as described by the manufacturer emulating typical user configurations for testing purposes. The EUT offers no other interface connections than those in the configuration options shown below as described by the manufacturer. The EUT operates from internal battery or external power received through compliant equipment. For testing purposes, the EUT received powered from internal battery, external AC and DC power adapters, and support equipment. The test system was configured as manufacturer directed and operated in manufacturer-defined modes. As requested by the manufacturer and required by regulations, the equipment was tested for emissions compliance using the available configurations with the worst-case data presented. Test results in this report relate only to the products described in this report.

### Equipment Configuration

1. A02564 operating off internal Li-Ion Battery

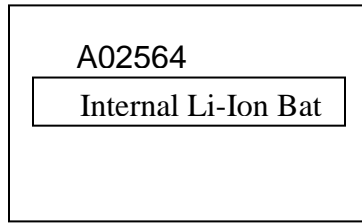

2. A02564 internal battery charged by PC through mini B USB cable

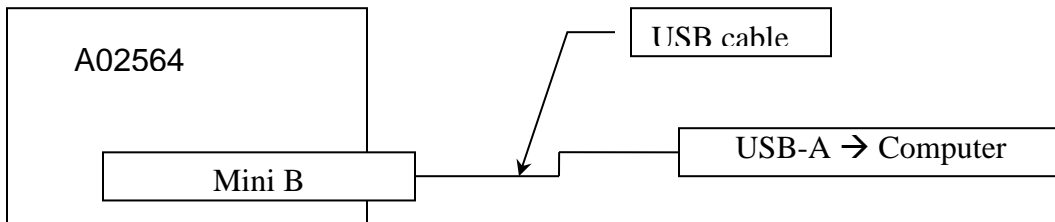

3. A02564 internal battery charged by AC adapter through mini B USB cable

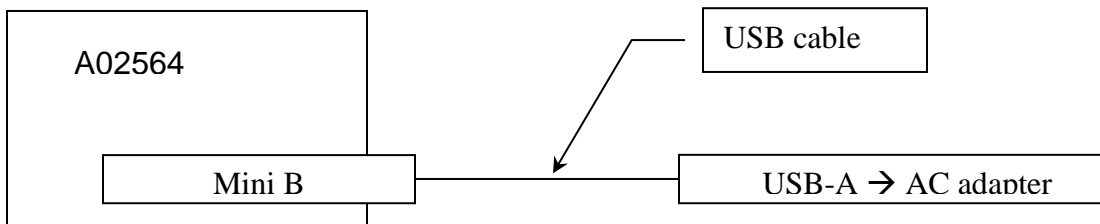

4. A02564 internal battery charged by external cigarette lighter adaptor accessory through mini B USB cable

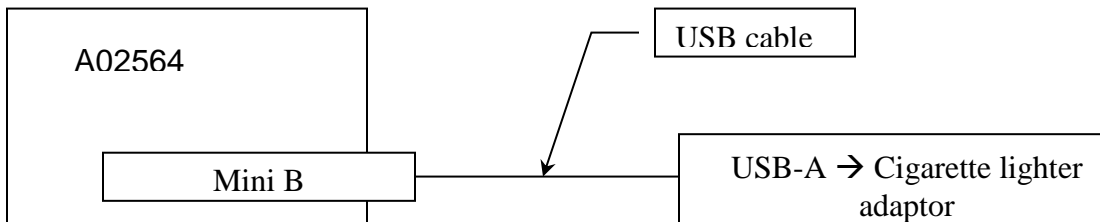

5. A02564 transmitting data through wireless 2.4 GHz communication (see test procedure document) and powered by internal battery

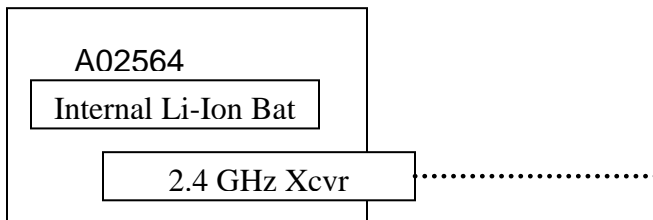



## Application for Certification

- (1) Manufacturer: Garmin International, Inc.  
1200 East 151st Street  
Olathe, KS 66062
  
- (2) Identification: Model: A02564  
FCC I.D.: IPH-02564 IC ID: 1792A-02564
  
- (3) Instruction Book:  
Refer to Exhibit for Instruction Manual.
  
- (4) Description of Circuit Functions:  
Refer to Exhibit of Operational Description.
  
- (5) Block Diagram with Frequencies:  
Refer to Exhibit of Operational Description.
  
- (6) Report of Measurements:  
Report of measurements follows in this Report.
  
- (7) Photographs: Construction, Component Placement, etc.:  
Refer to Exhibit for photographs of equipment.
  
- (8) List of Peripheral Equipment Necessary for operation. The equipment operates from internal rechargeable battery only and provides USB interface connection port for use with compliant computer systems, AC, or DC power adapters. The EUT offers no other connection ports than those presented in this filing.
  
- (9) Transition Provisions of CFR47 15.37 are not requested.
  
- (10) Not Applicable. The unit is not a scanning receiver.
  
- (11) Not Applicable. The EUT does not operate in the 59 – 64 GHz frequency band.
  
- (12) The equipment is not software defined and this section is not applicable.



## Applicable Standards & Test Procedures

In accordance with the Federal Communications Code of Federal Regulations, dated October 1, 2013, Part 2, Subpart J, Paragraphs 2.907, 2.911, 2.913, 2.925, 2.926, 2.1031 through 2.1057, and applicable parts of paragraph 15, Part 15C Paragraph 15.249 the following information is submitted. Test procedures used are the established Methods of Measurement of Radio-Noise Emissions as described in ANSI C63.10-2009.

## Equipment Testing Procedures

### ***AC Line Conducted Emission Test Procedure***

Testing for the AC line-conducted emissions was performed as defined in ANSI C63.10-2009. The test setup, including the EUT, was arranged in the test configurations as presented during testing. The test configuration was placed on a 1 x 1.5-meter wooden bench, 0.8 meters high located in a screen room. The power lines of the system were isolated from the power source using a standard LISN with a 50- $\mu$ Hy choke. EMI was coupled to the spectrum analyzer through a 0.1  $\mu$ F capacitor internal to the LISN. The LISN was positioned on the floor beneath the wooden bench supporting the EUT. The power lines and cables were draped over the back edge of the table. Refer to diagram 1 showing typical test arrangement and photographs in exhibits for EUT placement used during testing.

### ***Radiated Emission Test Procedure***

The EUT was placed on a rotating 1 x 1.5-meter wooden platform, 0.8 meters above the ground plane at a distance of 3 meters from the FSM antenna. Radiated emissions testing was performed as required in CFR47 15 and specified in ANSI C63.10-2009. EMI energy was maximized by equipment placement permitting orientation in three orthogonal axis, raising and lowering the FSM antenna, changing the antenna polarization, and by rotating the turntable. Each emission was maximized before data was taken using a spectrum analyzer. The frequency spectrum from 9 kHz to 25,000 MHz was searched for during preliminary investigation. Refer to diagrams 2 and 3 showing typical test arrangement and photographs in the test setup exhibits for specific EUT placement during testing.

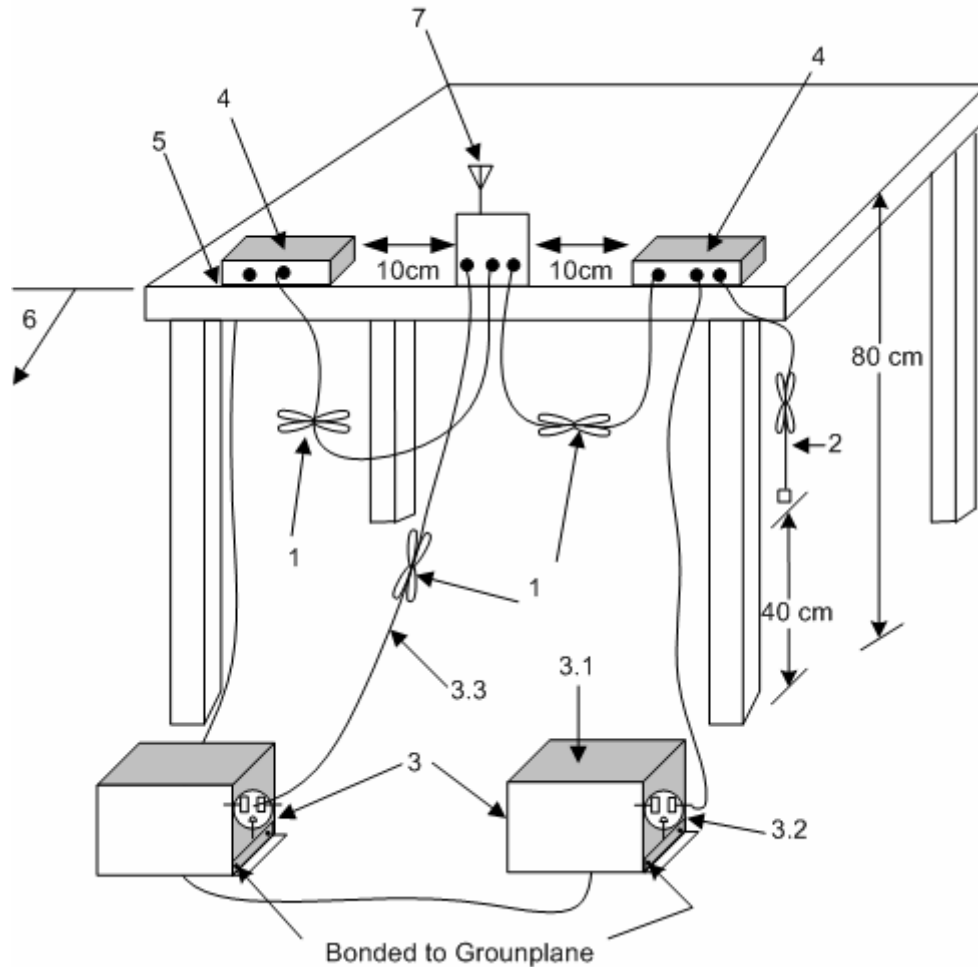

1. Interconnecting cables that hang closer than 40 cm to the ground plane shall be folded back and forth in the center forming a bundle 30 cm to 40 cm long see (see 6.2.3.1).
2. I/O cables that are not connected to an accessory shall be bundled in the center. The end of the cable may be terminated, if required, using the correct terminating impedance. The overall length shall not exceed 1 m (see 6.2.2).
3. EUT connected to one LISN. Unused LISN measuring port connectors shall be terminated in 50 Ω loads. LISN can be placed on top of, or immediately beneath, reference ground plane (see 6.2.2 and 6.2.3).
  - 3.1 All other equipment powered from additional LISN(s).
  - 3.2 Multiple-outlet strip can be used for multiple power cords of non-EUT equipment.
  - 3.3 LISN at least 80 cm from nearest part of EUT chassis.
4. Non-EUT components of EUT system being tested.
5. Rear of EUT, including peripherals, shall all be aligned and flush with rear of tabletop (see 6.2.3.1).
6. Edge of tabletop shall be 40 cm removed from a vertical conducting plane that is bonded to the ground plane (see 6.2.2 for options).
7. Antenna may be integral or detachable. If detachable, the antenna shall be attached for this test.

**Diagram 1 Test arrangement for Conducted emissions**

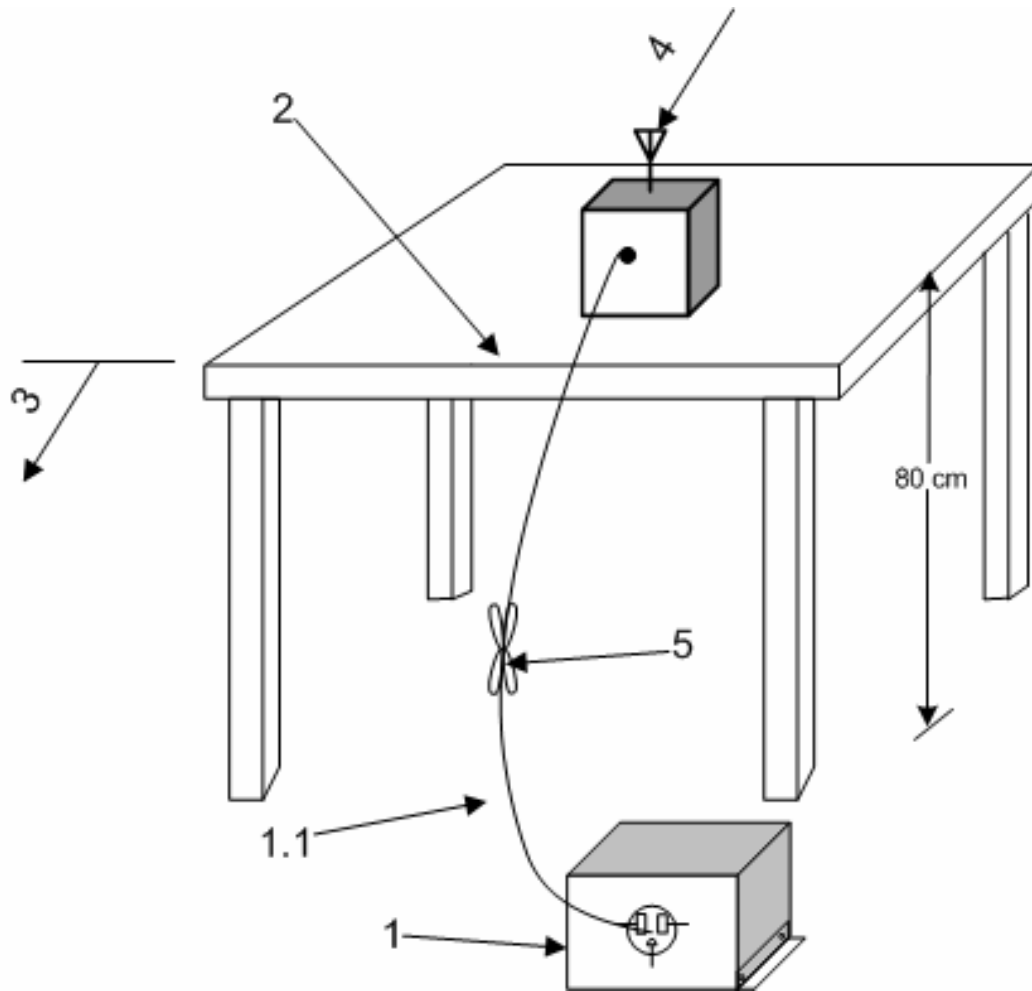

1. A LISN is optional for radiated measurements between 30 MHz to 1000 MHz, but not allowed for measurements below 30 MHz and above 1000 MHz. (See 6.4.3, 6.5.1, and 6.6.3.) If used, connect EUT to one LISN. Unused LISN measuring port connectors shall be terminated in 50Ω. LISN can be placed on top of, or immediately beneath, reference ground plane (see 6.2.2 and 6.2.3.1).
  - 1.1 LISN spaced at least 80 cm from nearest part of EUT chassis.
2. The EUT shall be placed in the center of the table to the extent possible. (See 6.2.3.1 and 6.3.4).
3. A vertical conducting plane, if used for conducted tests per 6.2.2, shall be removed for radiated emission tests.
4. Antenna may be integral or detachable, depending on the EUT.
5. Interconnecting cables that hang closer than 40 cm to the ground plane shall be folded back and forth in the center forming a bundle 30 cm to 40 cm long.

**Diagram 2 Test arrangement for radiated emissions of tabletop equipment**

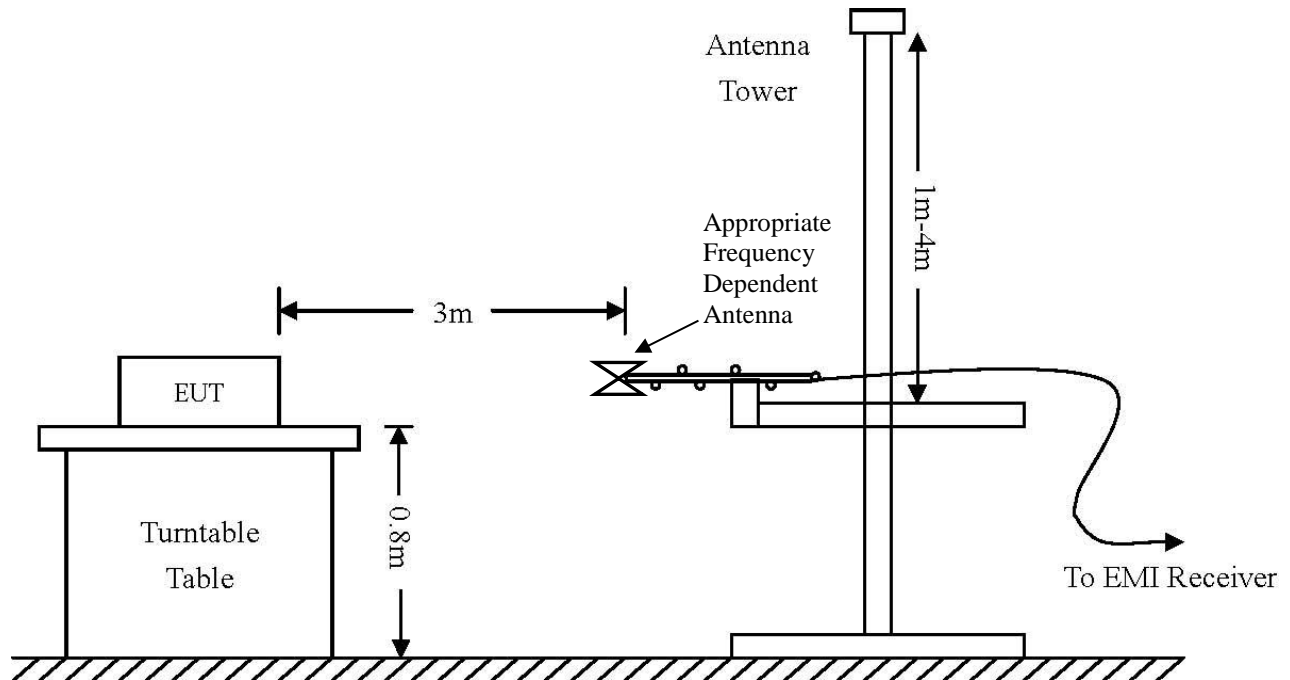

| Frequency: 9 kHz-30 MHz | Frequency: 30 MHz- 1 GHZ | Frequency: Above 1 GHz |
|-------------------------|--------------------------|------------------------|
| Loop Antenna            | Broadband Biconilog      | Horn                   |
| RBW = 9 kHz             | RBW = 120 kHz            | RBW = 1 MHz            |
| VBW = 30 kHz            | VBW = 120 kHz            | VBW = 1 MHz            |
| Sweep time = Auto       | Sweep time = Auto        | Sweep time = Auto      |
| Detector = PK, QP       | Detector = PK, QP        | Detector = PK, AV      |
| Antenna Height 1m       | Antenna Height 1-4m      | Antenna Height 1-4m    |

**Diagram 3 Test arrangement for radiated emissions tested on Open Area Test Site (OATS)**

### Test Site Locations

**Conducted EMI**      The AC power line conducted emissions testing performed in a shielded screen room located at Rogers Labs, Inc., 4405 W. 259<sup>th</sup> Terrace, Louisburg, KS

**Radiated EMI**      The radiated emissions tests were performed at the 3 meters, Open Area Test Site (OATS) located at Rogers Labs, Inc., 4405 W. 259<sup>th</sup> Terrace, Louisburg, KS

**Site Registration**      Refer to Annex for Site Registration Letters

**NVLAP Accreditation**      Lab code 200087-0

Rogers Labs, Inc.  
4405 W. 259th Terrace  
Louisburg, KS 66053  
Phone/Fax: (913) 837-3214  
Revision 1

Garmin International, Inc.  
Model: A02564  
Test #: 141010  
Test to: CFR47 (15.249), RSS-210  
File: Garmin A02564 FCC TstRpt 141010

SN: 3892059915  
FCC ID#: IPH-02564  
IC: 1792A-02564  
Date: June 12, 2015  
Page 12 of 34

## List of Test Equipment

A Rohde and Schwarz ESU40 and/or Hewlett Packard 8591EM was used as the measuring device for the emissions testing of frequencies below 1 GHz. A Rohde and Schwarz ESU40 and/or Hewlett Packard 8562A Spectrum Analyzer was used as the measuring device for testing the emissions at frequencies above 1 GHz. The analyzer settings used are described in the following table. Refer to the appendix for a complete list of test equipment.

| AC Line Conducted Emissions (0.150 -30 MHz) |          |                   |
|---|----------|-------------------|
| RBW   | AVG. BW  | Detector Function |
| 9 kHz                                       | 30 kHz   | Peak / Quasi Peak |
| Emissions (30-1000 MHz)                     |          |                   |
| RBW   | AVG. BW  | Detector Function |
| 120 kHz                                     | 300 kHz  | Peak / Quasi Peak |
| Emissions (Above 1000 MHz)                  |          |                   |
| RBW   | Video BW | Detector Function |
| 100 kHz                                     | 100 kHz  | Peak              |
| 1 MHz                                       | 1 MHz    | Peak / Average    |

| <u>Equipment</u>                              | <u>Manufacturer</u> | <u>Model (SN)</u>       | <u>Band</u> | <u>Cal Date</u> | <u>Due</u> |
|---|---------------------|-------------------------|-------------|-----------------|------------|
| <input checked="" type="checkbox"/> LISN      | Comp. Design        | FCC-LISN-2-MOD.CD (126) | .15-30MHz   | 10/14           | 10/15      |
| <input checked="" type="checkbox"/> Cable     | Time Microwave      | 750HF290-750 (L10M)     | 9kHz-40 GHz | 10/14           | 10/15      |
| <input checked="" type="checkbox"/> Cable     | Belden              | RG-58 (L1-CAT3-11509)   | 9kHz-30 MHz | 10/14           | 10/15      |
| <input checked="" type="checkbox"/> Cable     | Belden              | RG-58 (L2-CAT3-11509)   | 9kHz-30 MHz | 10/14           | 10/15      |
| <input type="checkbox"/> Antenna              | ARA                 | BCD-235-B (169)         | 20-350MHz   | 10/14           | 10/15      |
| <input type="checkbox"/> Antenna              | EMCO                | 3147 (40582)            | 200-1000MHz | 10/14           | 10/15      |
| <input checked="" type="checkbox"/> Antenna   | Com Power           | AH-118 (10110)          | 1-18 GHz    | 10/14           | 10/15      |
| <input checked="" type="checkbox"/> Antenna   | Com Power           | AH-840 (101046)         | 18-40 GHz   | 5/14            | 5/15       |
| <input checked="" type="checkbox"/> Antenna   | EMCO                | 6509 (9502-1374)        | .001-30 MHz | 10/14           | 10/15      |
| <input checked="" type="checkbox"/> Antenna   | Sunol               | JB-6 (A100709)          | 30-1000 MHz | 10/14           | 10/15      |
| <input checked="" type="checkbox"/> Antenna   | Standard            | FXRY638A (621786)       | 10-18 GHz   | 5/14            | 5/15       |
| <input type="checkbox"/> Antenna              | EMCO                | 3143 (9607-1277)        | 20-1200 MHz | 5/14            | 5/15       |
| <input type="checkbox"/> Analyzer             | HP                  | 8591EM (3628A00871)     | 9kHz-1.8GHz | 5/14            | 5/15       |
| <input type="checkbox"/> Analyzer             | HP                  | 8562A (3051A05950)      | 9kHz-110GHz | 5/14            | 5/15       |
| <input checked="" type="checkbox"/> Analyzer  | Rohde & Schwarz     | ESU40 (100108)          | 20Hz-40GHz  | 5/14            | 5/15       |
| <input checked="" type="checkbox"/> Amplifier | Com-Power           | PA-010 (171003)         | 100Hz-30MHz | 10/14           | 10/15      |
| <input checked="" type="checkbox"/> Amplifier | Com-Power           | CPPA-102 (01254)        | 1-1000 MHz  | 10/14           | 10/15      |
| <input checked="" type="checkbox"/> Amplifier | Com-Power           | PAM-118A (551014)       | 0.5-18 GHz  | 10/14           | 10/15      |



## Units of Measurements

Conducted EMI            Data is in dB $\mu$ V; dB referenced to one microvolt

Radiated EMI            Data is in dB $\mu$ V/m; dB/m referenced to one microvolt per meter

Sample Calculation:

RFS = Radiated Field Strength, FSM = Field Strength Measured

A.F. = Receive antenna factor, Gain = amplification gains and/or cable losses

RFS (dB $\mu$ V/m @ 3m) = FSM (dB $\mu$ V) + A.F. (dB) - Gain (dB)

## Environmental Conditions

|                      |           |
|----------------------|-----------|
| Ambient Temperature  | 23.4° C   |
| Relative Humidity    | 43%       |
| Atmospheric Pressure | 1014.5 mb |

## Intentional Radiators

As per CFR47, Subpart C, paragraph 15.249 the following information is submitted for demonstration of compliance with requirements.

### ***Antenna Requirements***

The EUT incorporates integral antenna system and offers no provision for connection to alternate system. The antenna connection point complies with the unique antenna connection requirements. The unique antenna connection requirements are fulfilled. There are no deviations or exceptions to the specification.

### ***Restricted Bands of Operation***

Spurious emissions falling in the restricted frequency bands of operation were measured at the OATS. The EUT utilizes frequency, determining circuitry, which generates harmonics falling in the restricted bands. Emissions were investigated at the OATS, using appropriate antennas or pyramidal horns, amplification stages, and a spectrum analyzer. Peak and average amplitudes of frequencies above 1000 MHz were compared to the required limits with worst-case data presented below. Test procedures of ANSI C63.10-2009 were used during testing. No other significant emission was observed which fell into the restricted bands of operation. Computed emission values take into account the received radiated field strength, receive antenna correction factor, amplifier gain stage, and test system cable losses.

**Table 1 Radiated Emissions in Restricted Frequency Bands Data**

| Frequency in MHz | Horizontal Peak (dBµV/m) | Horizontal Quasi-Peak (dBµV/m) | Horizontal Average (dBµV/m) | Vertical Peak (dBµV/m) | Vertical Quasi-Peak (dBµV/m) | Vertical Average (dBµV/m) | Limit @ 3m (dBµV/m) |
|------------------|--------------------------|--------------------------------|-----------------------------|------------------------|------------------------------|---------------------------|---------------------|
| <b>Mode 1</b>    |                          |                                |                             |                        |                              |                           |                     |
| 2390.0           | 37.2                     | N/A                            | 23.6                        | 35.5                   | N/A                          | 23.3                      | 54.0                |
| 2483.5           | 36.8                     | N/A                            | 24.3                        | 35.9                   | N/A                          | 23.6                      | 54.0                |
| 4804.0           | 41.0                     | N/A                            | 28.4                        | 40.9                   | N/A                          | 28.3                      | 54.0                |
| 4914.0           | 42.0                     | N/A                            | 29.1                        | 42.8                   | N/A                          | 29.1                      | 54.0                |
| 4960.0           | 43.9                     | N/A                            | 30.8                        | 42.8                   | N/A                          | 30.5                      | 54.0                |
| 7206.0           | 53.5                     | N/A                            | 48.1                        | 48.6                   | N/A                          | 38.9                      | 54.0                |
| 7371.0           | 51.8                     | N/A                            | 45.8                        | 47.8                   | N/A                          | 35.2                      | 54.0                |
| 7440.0           | 48.1                     | N/A                            | 36.2                        | 47.3                   | N/A                          | 34.9                      | 54.0                |
| 12010.0          | 54.4                     | N/A                            | 43.2                        | 54.3                   | N/A                          | 40.4                      | 54.0                |
| 12285.0          | 54.1                     | N/A                            | 43.3                        | 53.9                   | N/A                          | 41.1                      | 54.0                |
| 12400.0          | 55.3                     | N/A                            | 43.5                        | 54.4                   | N/A                          | 42.8                      | 54.0                |
| <b>Mode 2</b>    |                          |                                |                             |                        |                              |                           |                     |
| 2390.0           | 40.6                     | N/A                            | 26.8                        | 36.7                   | N/A                          | 23.4                      | 54.0                |
| 2483.5           | 38.1                     | N/A                            | 25.3                        | 36.3                   | N/A                          | 24.5                      | 54.0                |
| 4804.0           | 40.6                     | N/A                            | 27.9                        | 40.7                   | N/A                          | 27.9                      | 54.0                |
| 4880.0           | 41.1                     | N/A                            | 28.4                        | 40.8                   | N/A                          | 28.3                      | 54.0                |
| 4960.0           | 43.1                     | N/A                            | 30.0                        | 43.2                   | N/A                          | 29.9                      | 54.0                |
| 7206.0           | 50.0                     | N/A                            | 39.3                        | 46.5                   | N/A                          | 34.0                      | 54.0                |
| 7320.0           | 49.3                     | N/A                            | 37.3                        | 47.5                   | N/A                          | 34.1                      | 54.0                |
| 7440.0           | 49.2                     | N/A                            | 37.1                        | 47.8                   | N/A                          | 34.2                      | 54.0                |
| 12010.0          | 52.4                     | N/A                            | 39.9                        | 51.9                   | N/A                          | 39.5                      | 54.0                |
| 12200.0          | 52.1                     | N/A                            | 39.3                        | 51.5                   | N/A                          | 38.8                      | 54.0                |
| 12400.0          | 52.8                     | N/A                            | 40.0                        | 53.2                   | N/A                          | 40.6                      | 54.0                |

Other emissions present had amplitudes at least 20 dB below the limit. Peak and Quasi-Peak amplitude emissions are recorded for frequency range below 1000 MHz. Peak and Average amplitude emissions are recorded for frequency range above 1000 MHz.

### **Summary of Results for Radiated Emissions in Restricted Bands**

The EUT demonstrated compliance with the radiated emissions requirements of CFR 47 Part 15C Intentional Radiators. The EUT demonstrated a worst-case minimum margin of -5.9 dB below the emissions requirements in restricted frequency bands. Peak, Quasi-peak, and average amplitudes were checked for compliance with the regulations. Worst-case emissions are reported with other emissions found in the restricted frequency bands at least 20 dB below the requirements.

### **AC Line Conducted EMI Procedure**

The EUT was arranged in typical equipment configurations as offered by manufacturer. Testing was performed with the EUT placed on a 1 x 1.5-meter wooden bench 80 cm above the conducting ground plane, floor of a screen room. The bench was positioned 40 cm away from the wall of the screen room. The LISN was positioned on the floor of the screen room 80-cm from the rear of the EUT. Testing for the line-conducted emissions were the procedures of ANSI C63.10-2009 paragraph 6. The AC adapter for the EUT was connected to the LISN for line-conducted emissions testing. A second LISN was positioned on the floor of the screen room 80-cm from the rear of the supporting equipment of the EUT. All power cords except the EUT were then powered from the second LISN. EMI was coupled to the spectrum analyzer through a 0.1  $\mu$ F capacitor, internal to the LISN. Power line conducted emissions testing was carried out individually for each current carrying conductor of the EUT. The excess length of lead between the system and the LISN receptacle was folded back and forth to form a bundle not exceeding 40 cm in length. The screen room, conducting ground plane, analyzer, and LISN were bonded together to the protective earth ground. Preliminary testing was performed to identify the frequencies of each of the emissions, which demonstrated the highest amplitudes. The cables were repositioned to obtain maximum amplitude of measured EMI level. Once the worst-case configuration was identified, plots were made of the EMI from 0.15 MHz to 30 MHz then data was recorded with maximum conducted emissions levels. Refer to figures one and two showing plots of the worst-case AC Line conducted emissions of the AC Adapter while charging the EUT. Refer to figures three and four showing plots of the worst-case AC Line conducted emissions of the EUT-USB-CPU configuration.



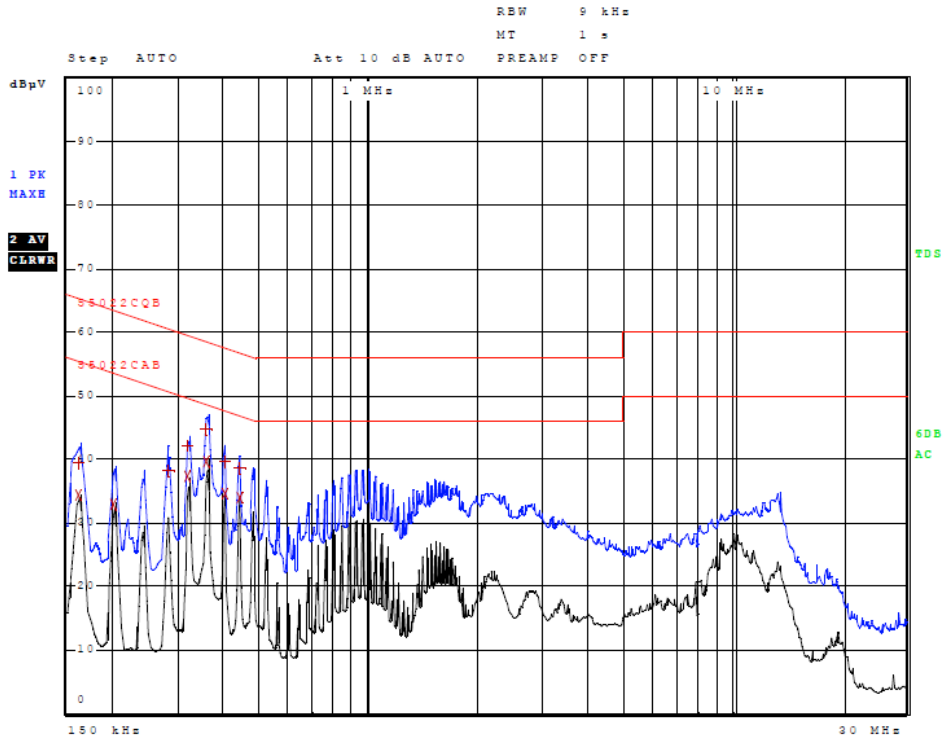

Figure 1 AC Line Conducted emissions of EUT line 1 (EUT AC Adapter)

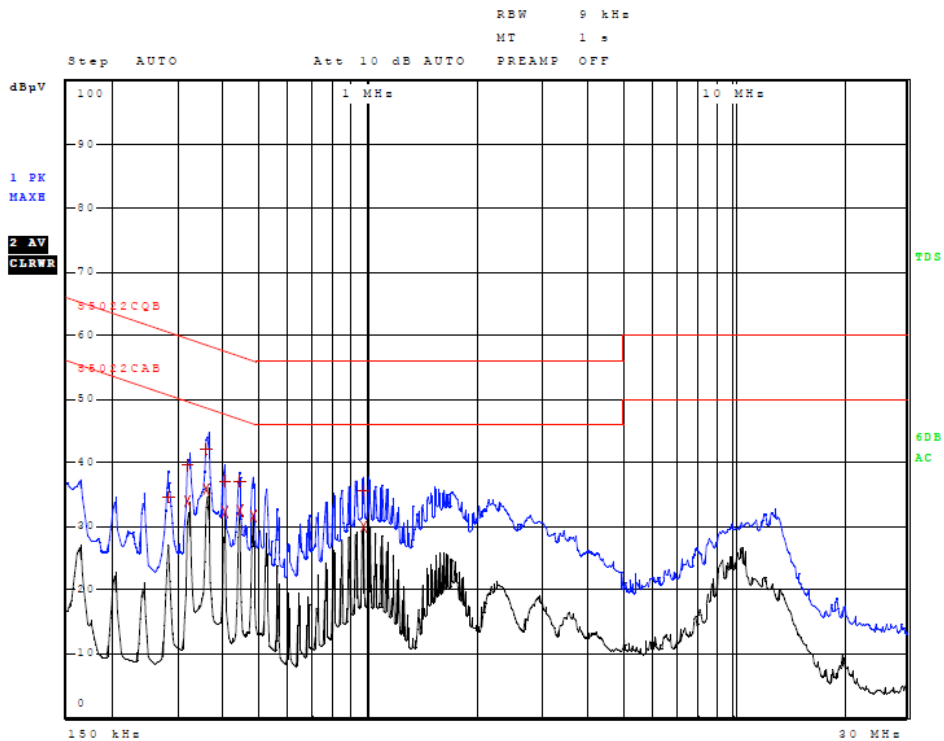

Figure 2 AC Line Conducted emissions of EUT line 2 (EUT AC Adapter)

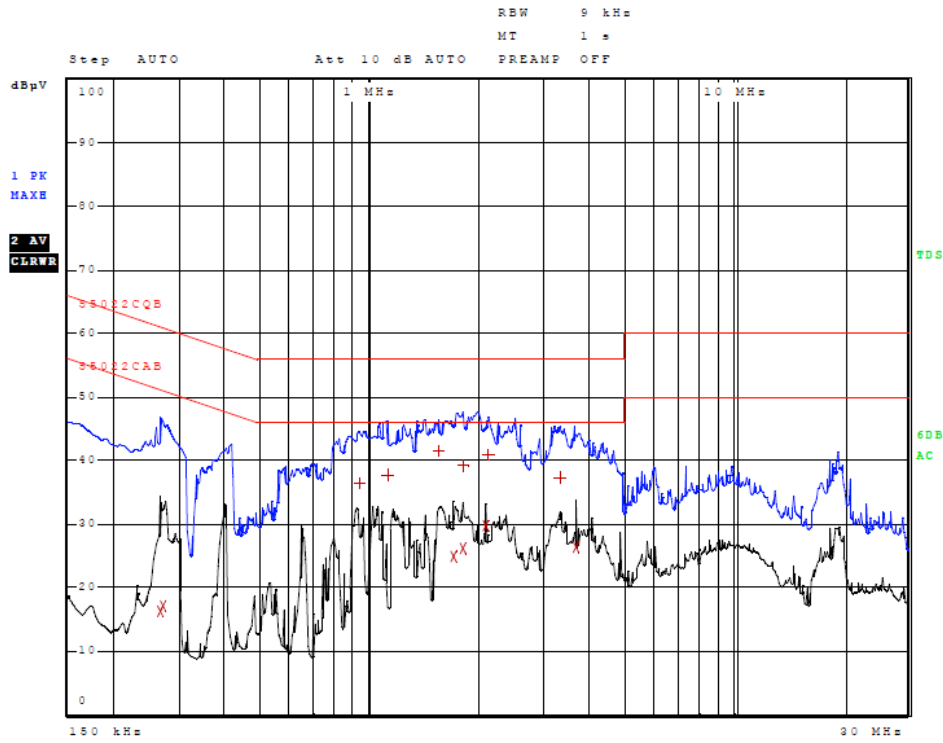

Figure 3 AC Line Conducted emissions of EUT line 1 (EUT-USB-CPU)

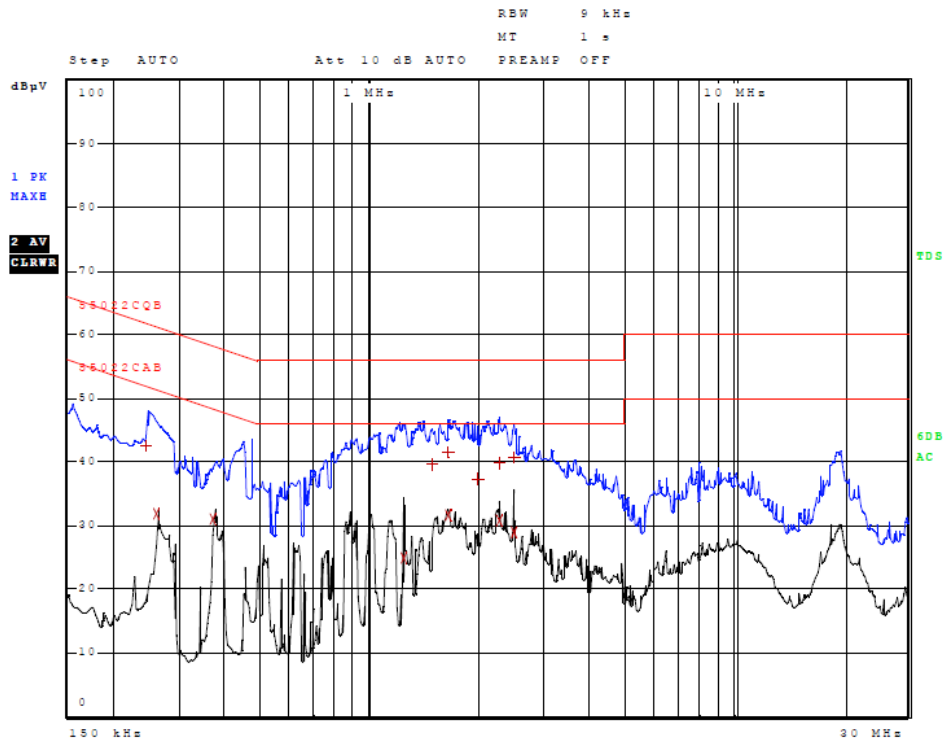

Figure 4 AC Line Conducted emissions of EUT line 2 (EUT-USB-CPU)



**Table 2 AC Line Conducted Emissions Data L1 (EUT-AC Adapter)**

| Trace | Frequency         | Level (dBµV) | Detector   | Delta Limit/dB |
|-------|-------------------|--------------|------------|----------------|
| 1     | 162.000000000 kHz | 39.31        | Quasi Peak | -26.06         |
| 2     | 162.000000000 kHz | 34.34        | Average    | -21.02         |
| 2     | 202.000000000 kHz | 32.96        | Average    | -20.57         |
| 1     | 282.000000000 kHz | 38.05        | Quasi Peak | -22.70         |
| 2     | 322.000000000 kHz | 37.30        | Average    | -12.35         |
| 1     | 322.000000000 kHz | 42.09        | Quasi Peak | -17.56         |
| 2     | 362.000000000 kHz | 39.70        | Average    | -8.99          |
| 1     | 362.000000000 kHz | 44.73        | Quasi Peak | -13.96         |
| 2     | 402.000000000 kHz | 34.62        | Average    | -13.19         |
| 1     | 402.000000000 kHz | 39.65        | Quasi Peak | -18.17         |
| 2     | 442.000000000 kHz | 33.97        | Average    | -13.06         |
| 1     | 442.000000000 kHz | 38.45        | Quasi Peak | -18.57         |

Other emissions present had amplitudes at least 20 dB below the limit.

**Table 3 AC Line Conducted Emissions Data L2 (EUT-AC Adapter)**

| Trace | Frequency         | Level (dBµV) | Detector   | Delta Limit/dB |
|-------|-------------------|--------------|------------|----------------|
| 1     | 282.000000000 kHz | 34.49        | Quasi Peak | -26.27         |
| 2     | 322.000000000 kHz | 33.87        | Average    | -15.78         |
| 1     | 322.000000000 kHz | 39.53        | Quasi Peak | -20.13         |
| 2     | 362.000000000 kHz | 35.84        | Average    | -12.84         |
| 1     | 362.000000000 kHz | 42.10        | Quasi Peak | -16.58         |
| 2     | 402.000000000 kHz | 32.15        | Average    | -15.67         |
| 1     | 402.000000000 kHz | 37.16        | Quasi Peak | -20.65         |
| 2     | 442.000000000 kHz | 32.39        | Average    | -14.64         |
| 1     | 442.000000000 kHz | 37.03        | Quasi Peak | -19.99         |
| 2     | 482.000000000 kHz | 31.53        | Average    | -14.77         |
| 2     | 966.000000000 kHz | 29.95        | Average    | -16.05         |
| 1     | 966.000000000 kHz | 35.56        | Quasi Peak | -20.44         |

Other emissions present had amplitudes at least 20 dB below the limit.



**Table 4 AC Line Conducted Emissions Data L1 (EUT-USB-CPU)**

| Trace | Frequency         | Level (dBµV) | Detector   | Delta Limit/dB |
|-------|-------------------|--------------|------------|----------------|
| 2     | 266.000000000 kHz | 16.38        | Average    | -34.86         |
| 2     | 274.000000000 kHz | 17.08        | Average    | -33.92         |
| 1     | 938.000000000 kHz | 36.43        | Quasi Peak | -19.57         |
| 1     | 1.114000000 MHz   | 37.69        | Quasi Peak | -18.31         |
| 1     | 1.550000000 MHz   | 41.53        | Quasi Peak | -14.47         |
| 2     | 1.690000000 MHz   | 24.89        | Average    | -21.11         |
| 2     | 1.798000000 MHz   | 26.11        | Average    | -19.89         |
| 1     | 1.798000000 MHz   | 39.11        | Quasi Peak | -16.89         |
| 2     | 2.082000000 MHz   | 29.71        | Average    | -16.29         |
| 1     | 2.122000000 MHz   | 40.85        | Quasi Peak | -15.15         |
| 1     | 3.330000000 MHz   | 37.30        | Quasi Peak | -18.70         |
| 2     | 3.682000000 MHz   | 26.45        | Average    | -19.55         |

Other emissions present had amplitudes at least 20 dB below the limit.

**Table 5 AC Line Conducted Emissions Data L2 (EUT-USB-CPU)**

| Trace | Frequency         | Level (dBµV) | Detector   | Delta Limit/dB |
|-------|-------------------|--------------|------------|----------------|
| 1     | 246.000000000 kHz | 42.48        | Quasi Peak | -19.41         |
| 2     | 262.000000000 kHz | 31.74        | Average    | -19.63         |
| 2     | 374.000000000 kHz | 30.96        | Average    | -17.45         |
| 2     | 1.242000000 MHz   | 24.87        | Average    | -21.13         |
| 1     | 1.478000000 MHz   | 39.55        | Quasi Peak | -16.45         |
| 2     | 1.642000000 MHz   | 31.62        | Average    | -14.38         |
| 1     | 1.642000000 MHz   | 41.56        | Quasi Peak | -14.44         |
| 1     | 1.998000000 MHz   | 37.31        | Quasi Peak | -18.69         |
| 2     | 2.258000000 MHz   | 30.86        | Average    | -15.14         |
| 1     | 2.270000000 MHz   | 39.84        | Quasi Peak | -16.16         |
| 2     | 2.498000000 MHz   | 28.90        | Average    | -17.10         |
| 1     | 2.498000000 MHz   | 40.66        | Quasi Peak | -15.34         |

Other emissions present had amplitudes at least 20 dB below the limit.

**Summary of Results for AC Line Conducted Emissions Results**

The EUT demonstrated compliance with the AC Line Conducted Emissions requirements of CFR 47 Part 15B and other applicable Class B emissions requirements. The EUT AC Adapter worst-case configuration demonstrated a minimum margin of -8.9 dB below the FCC/CISPR Class B limit. The EUT-USB-CPU worst-case configuration demonstrated a minimum margin of -14.3 dB below the FCC/CISPR Class B limit. Other emissions were present with amplitudes at least 20 dB below the limit and worst-case amplitudes recorded.

**General Radiated Emissions Procedure**

The EUT was arranged in a typical equipment configuration and operated through all available modes with worst-case data recorded. Preliminary testing was performed in a screen room with the EUT positioned 1 meter from the FSM. Radiated emissions measurements were performed to identify the frequencies, which produced the highest emissions. Each radiated emission was then maximized at the OATS location before final radiated emissions measurements were performed. Final data was taken with the EUT located at the OATS at a distance of 3 meters between the EUT and the receiving antenna. The frequency spectrum from 9 kHz to 25,000 MHz was searched for general radiated emissions. Measured emission levels were maximized by EUT placement on the table, rotating the turntable through 360 degrees, varying the antenna height between 1 and 4 meters above the ground plane and changing antenna position between horizontal and vertical polarization. Antennas used were Loop from 9 kHz to 30 MHz, Broadband Biconical from 30 to 200 MHz, Biconilog from 30 to 1000 MHz, Log Periodic from 200 MHz to 1 GHz and or double Ridge or pyramidal horns and mixers from 1 GHz to 40 GHz, notch filters and appropriate amplifiers and external mixers were utilized.

**Table 6 General Radiated Emissions from EUT Data**

| Frequency in MHz | Horizontal Peak (dBµV/m) | Horizontal Quasi-Peak (dBµV/m) | Horizontal Average (dBµV/m) | Vertical Peak (dBµV/m) | Vertical Quasi-Peak (dBµV/m) | Vertical Average (dBµV/m) | Limit @ 3m (dBµV/m) |
|------------------|--------------------------|--------------------------------|-----------------------------|------------------------|------------------------------|---------------------------|---------------------|
| 72.0             | 27.1                     | 20.2                           | N/A                         | 27.9                   | 22.9                         | N/A                       | 40.0                |
| 96.0             | 29.1                     | 24.5                           | N/A                         | 34.6                   | 29.4                         | N/A                       | 43.5                |
| 120.0            | 31.0                     | 25.4                           | N/A                         | 30.5                   | 25.1                         | N/A                       | 43.5                |
| 132.9            | 35.1                     | 30.7                           | N/A                         | 25.5                   | 19.2                         | N/A                       | 43.5                |
| 150.1            | 35.0                     | 28.1                           | N/A                         | 31.2                   | 25.6                         | N/A                       | 43.5                |

Other emissions present had amplitudes at least 20 dB below the limit. Peak and Quasi-Peak amplitude emissions are recorded for frequency range below 1000 MHz. Peak and Average amplitude emissions are recorded for frequency range above 1000 MHz.

**Summary of Results for General Radiated Emissions**

The EUT demonstrated compliance with the radiated emissions requirements of CFR47 Part 15C paragraph 15.209 Intentional Radiators. The EUT demonstrated a minimum margin of -12.8 dB below the requirements. Other emissions were present with amplitudes at least 20 dB below the Limits.



### **Operation in the Band 2400 – 2483.5 MHz**

The transmitter output power; harmonic and general emissions were measured on an open area test site @ 3 meters. The EUT was placed on a wooden turntable 0.8 meters above the ground plane and at a distance of 3 meters from the FSM antenna. The table permitted orientation of the EUT in each of three orthogonal axis positions during testing. The peak and quasi-peak amplitude of frequencies below 1000 MHz were measured using a spectrum analyzer. The peak and average amplitude of frequencies above 1000 MHz were measured using a spectrum analyzer. The amplitude of each emission was then recorded from the analyzer display. Emissions radiated outside of the specified bands, except for harmonics, shall be attenuated by at least 50 dB below the level of the fundamental or to the general radiated emission limits, whichever is the lesser attenuation. Plots were taken of transmitter performance for reference in this and other documentation. Refer to figures five through ten showing plots taken of the 2402-2480 MHz transmitter performance displaying compliance with the specifications. The amplitude of each radiated emission was measured on the OATS at a distance of 3 meters from the FSM antenna (testing was performed on sample 1 representative of production with integral antenna). The amplitude of each radiated emission was maximized by varying the FSM antenna height, polarization, and by rotating the turntable. A Loop antenna was used for measuring emissions from 0.009 to 30 MHz, Biconilog Antenna for 30 to 1000 MHz, Double-Ridge, and/or Pyramidal Horn Antennas from 1 GHz to 25 GHz. Emissions were measured in dB $\mu$ V/m @ 3 meters.

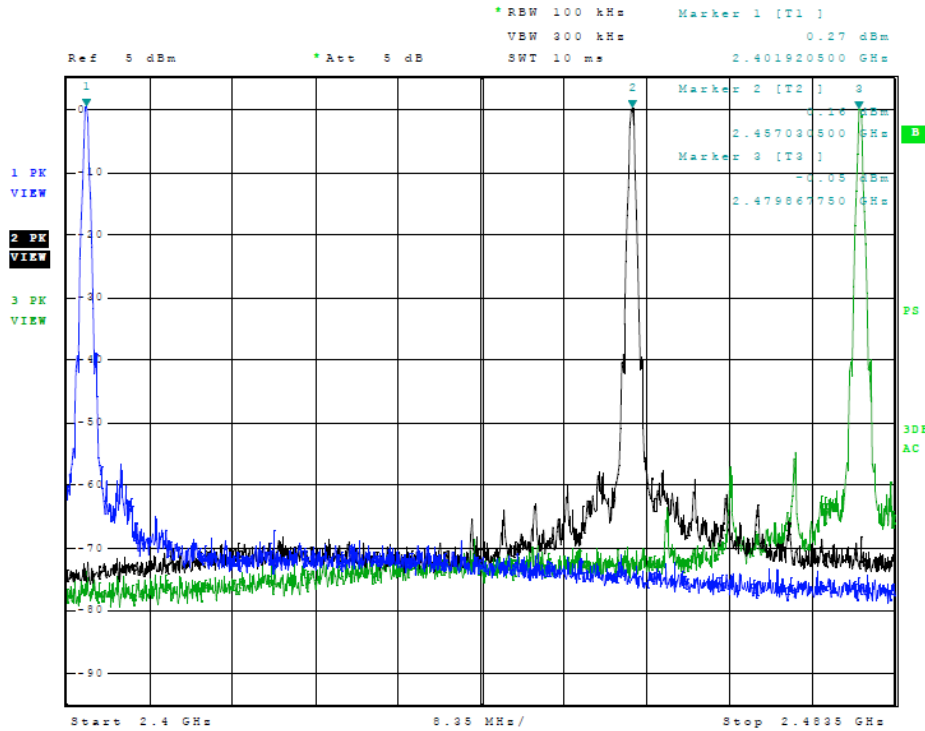

Figure 5 Plot of Transmitter Emissions (In 2402-2480 MHz Band, Mode 1)

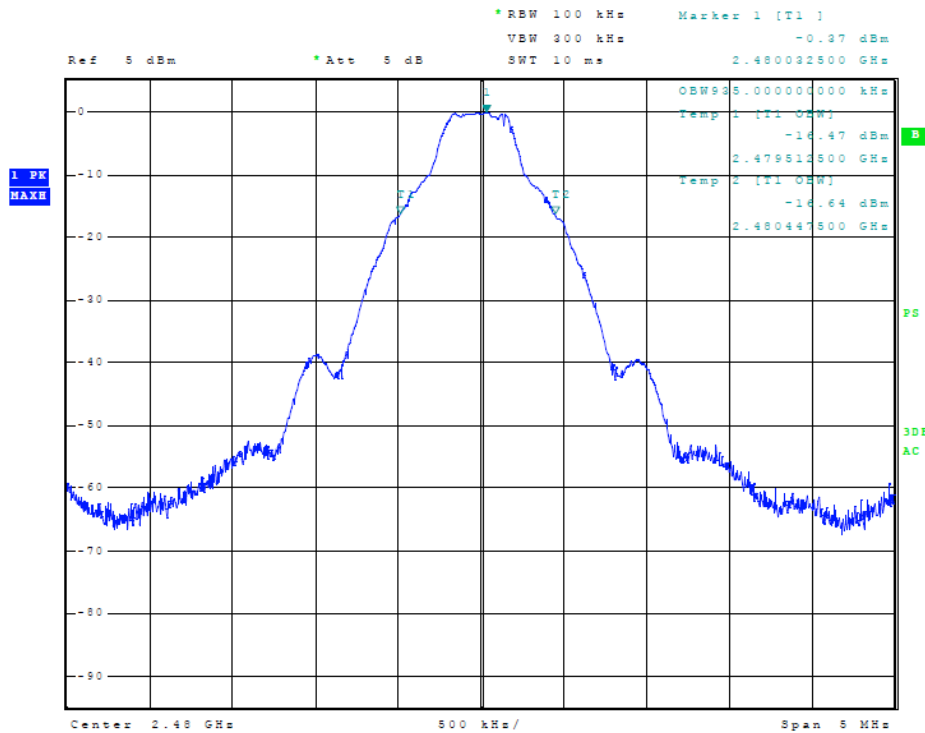

Figure 6 Plot of Transmitter Emissions (99% Occupied Bandwidth, Mode 1)

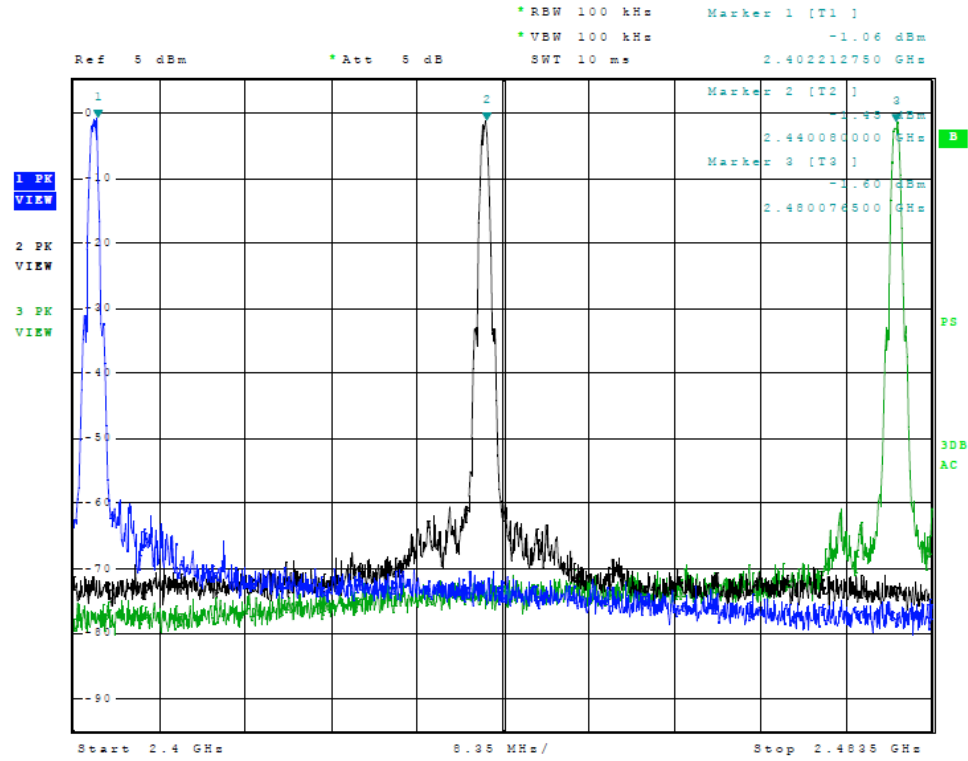

Figure 7 Plot of Transmitter Emissions (In 2402-2480 MHz Band, Mode 2)

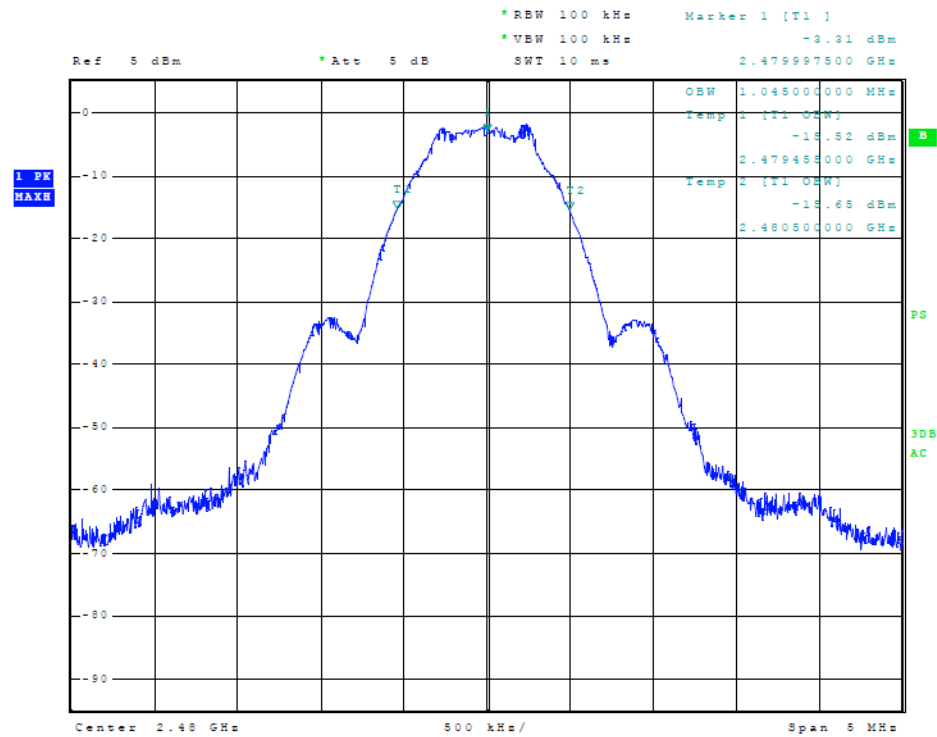

Figure 8 Plot of Transmitter Emissions (99% Occupied Bandwidth, Mode 2)



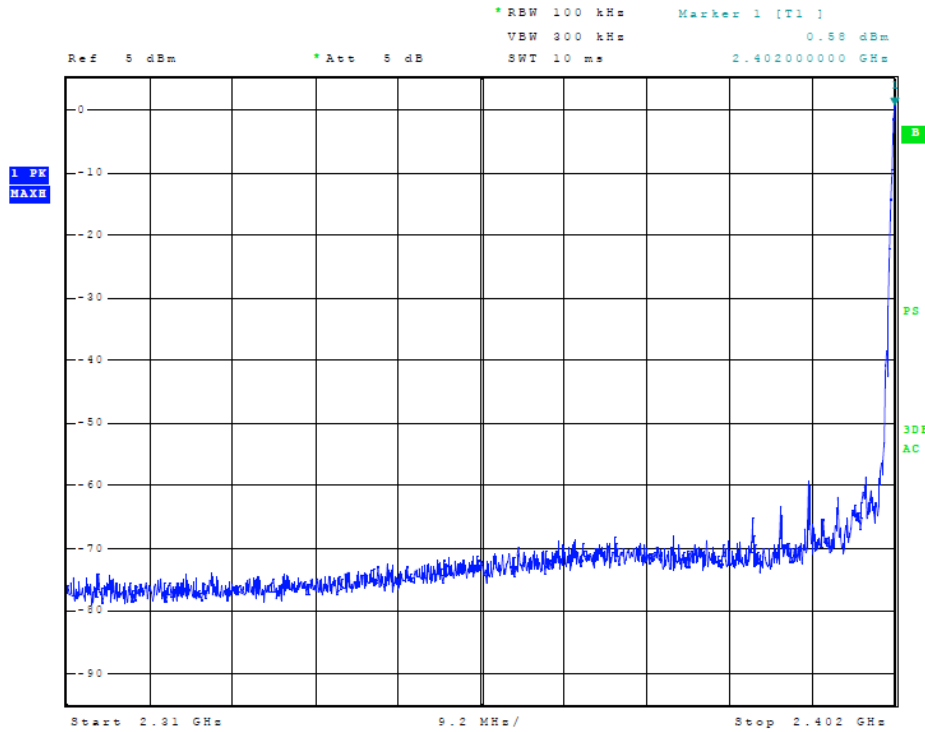

Figure 9 Plot of Transmitter Emissions (Low Band Edge)

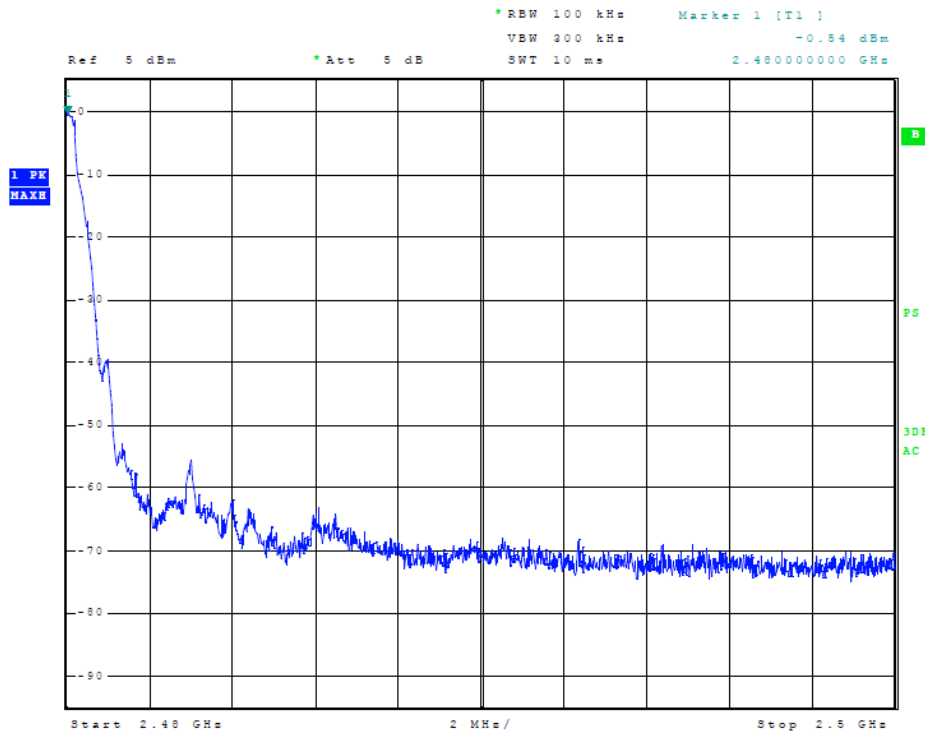

Figure 10 Plot of Low Band Edge (High Band Edge)

**Transmitter Emissions Data**

**Table 7 Transmitter Radiated Emissions (2402-2480 MHz Band mode 1)**

| Frequency in MHz | Horizontal Peak (dBμV/m) | Horizontal Quasi-Peak (dBμV/m) | Horizontal Average (dBμV/m) | Vertical Peak (dBμV/m) | Vertical Quasi-Peak (dBμV/m) | Vertical Average (dBμV/m) | Limit @ 3m (dBμV/m) |
|------------------|--------------------------|--------------------------------|-----------------------------|------------------------|------------------------------|---------------------------|---------------------|
| 2402.0           | 92.3                     | N/A                            | 91.8                        | 90.9                   | N/A                          | 90.3                      | 94.0                |
| 4804.0           | 41.0                     | N/A                            | 28.4                        | 40.9                   | N/A                          | 28.3                      | 54.0                |
| 7206.0           | 53.5                     | N/A                            | 48.1                        | 48.6                   | N/A                          | 38.9                      | 54.0                |
| 9608.0           | 50.0                     | N/A                            | 36.9                        | 50.0                   | N/A                          | 36.8                      | 54.0                |
| 12010.0          | 54.4                     | N/A                            | 43.2                        | 54.3                   | N/A                          | 40.4                      | 54.0                |
| 14412.0          | 59.6                     | N/A                            | 46.9                        | 59.2                   | N/A                          | 46.8                      | 54.0                |
| 2457.0           | 91.3                     | N/A                            | 90.6                        | 89.2                   | N/A                          | 88.8                      | 94.0                |
| 4914.0           | 42.0                     | N/A                            | 29.1                        | 42.8                   | N/A                          | 29.1                      | 54.0                |
| 7371.0           | 51.8                     | N/A                            | 45.8                        | 47.8                   | N/A                          | 35.2                      | 54.0                |
| 9828.0           | 48.4                     | N/A                            | 35.9                        | 49.1                   | N/A                          | 35.7                      | 54.0                |
| 12285.0          | 54.1                     | N/A                            | 43.3                        | 53.9                   | N/A                          | 41.1                      | 54.0                |
| 14742.0          | 57.6                     | N/A                            | 44.4                        | 57.5                   | N/A                          | 44.0                      | 54.0                |
| 2480.0           | 91.9                     | N/A                            | 91.0                        | 88.3                   | N/A                          | 88.2                      | 94.0                |
| 4960.0           | 43.9                     | N/A                            | 30.8                        | 42.8                   | N/A                          | 30.5                      | 54.0                |
| 7440.0           | 48.1                     | N/A                            | 36.2                        | 47.3                   | N/A                          | 34.9                      | 54.0                |
| 9920.0           | 50.4                     | N/A                            | 36.8                        | 49.8                   | N/A                          | 36.7                      | 54.0                |
| 12400.0          | 55.3                     | N/A                            | 43.5                        | 54.4                   | N/A                          | 42.8                      | 54.0                |
| 14880.0          | 56.7                     | N/A                            | 43.4                        | 57.2                   | N/A                          | 43.3                      | 54.0                |

Other emissions present had amplitudes at least 20 dB below the limit. Peak and Quasi-Peak amplitude emissions are recorded for frequency range below 1000 MHz. Peak and Average amplitude emissions are recorded for frequency range above 1000 MHz.

**Table 8 Transmitter Radiated Emissions (2402-2480 MHz Band mode 2)**

| Frequency in MHz | Horizontal Peak (dBµV/m) | Horizontal Quasi-Peak (dBµV/m) | Horizontal Average (dBµV/m) | Vertical Peak (dBµV/m) | Vertical Quasi-Peak (dBµV/m) | Vertical Average (dBµV/m) | Limit @ 3m (dBµV/m) |
|------------------|--------------------------|--------------------------------|-----------------------------|------------------------|------------------------------|---------------------------|---------------------|
| 2402.0           | 92.4                     | N/A                            | 91.0                        | 90.2                   | N/A                          | 89.7                      | 94.0                |
| 4804.0           | 40.6                     | N/A                            | 27.9                        | 40.7                   | N/A                          | 27.9                      | 54.0                |
| 7206.0           | 50.0                     | N/A                            | 39.3                        | 46.5                   | N/A                          | 34.0                      | 54.0                |
| 9608.0           | 49.5                     | N/A                            | 36.6                        | 49.9                   | N/A                          | 36.6                      | 54.0                |
| 12010.0          | 52.4                     | N/A                            | 39.9                        | 51.9                   | N/A                          | 39.5                      | 54.0                |
| 14412.0          | 59.0                     | N/A                            | 46.7                        | 58.8                   | N/A                          | 46.7                      | 54.0                |
| 2440.0           | 90.8                     | N/A                            | 89.4                        | 89.3                   | N/A                          | 88.5                      | 94.0                |
| 4880.0           | 41.1                     | N/A                            | 28.4                        | 40.8                   | N/A                          | 28.3                      | 54.0                |
| 7320.0           | 49.3                     | N/A                            | 37.3                        | 47.5                   | N/A                          | 34.1                      | 54.0                |
| 9760.0           | 48.6                     | N/A                            | 36.1                        | 48.2                   | N/A                          | 36.0                      | 54.0                |
| 12200.0          | 52.1                     | N/A                            | 39.3                        | 51.5                   | N/A                          | 38.8                      | 54.0                |
| 14640.0          | 57.9                     | N/A                            | 45.0                        | 57.3                   | N/A                          | 44.6                      | 54.0                |
| 2480.0           | 90.5                     | N/A                            | 89.8                        | 88.0                   | N/A                          | 87.3                      | 94.0                |
| 4960.0           | 43.1                     | N/A                            | 30.0                        | 43.2                   | N/A                          | 29.9                      | 54.0                |
| 7440.0           | 49.2                     | N/A                            | 37.1                        | 47.8                   | N/A                          | 34.2                      | 54.0                |
| 9920.0           | 48.8                     | N/A                            | 36.5                        | 49.4                   | N/A                          | 36.6                      | 54.0                |
| 12400.0          | 52.8                     | N/A                            | 40.0                        | 53.2                   | N/A                          | 40.6                      | 54.0                |
| 14880.0          | 55.3                     | N/A                            | 42.6                        | 55.1                   | N/A                          | 42.8                      | 54.0                |

Other emissions present had amplitudes at least 20 dB below the limit. Peak and Quasi-Peak amplitude emissions are recorded for frequency range below 1000 MHz. Peak and Average amplitude emissions are recorded for frequency range above 1000 MHz.



### ***Summary of Results for Transmitter Radiated Emissions of Intentional Radiator***

The EUT demonstrated compliance with the radiated emissions requirements of FCC CFR 47 Part 15.249 and other applicable standards for Intentional Radiators. The EUT worst-case test sample configuration demonstrated minimum peak margin of -1.6 dB below the limit for average emission limit. The EUT worst-case configuration demonstrated minimum radiated harmonic emission margin of -5.9 dB below the limits. No other radiated emissions were found in the restricted bands less than 20 dB below limits than those recorded in this report. Other emissions were present with amplitudes at least 20 dB below the limits.

### **Statement of Modifications and Deviations**

No modifications to the EUT were required for the equipment to demonstrate compliance with the CFR47 Part 15C emissions requirements. There were no deviations to the specifications.



NVLAP Lab Code 200087-0

## Annex

- Annex A Measurement Uncertainty Calculations
- Annex B Rogers Labs Test Equipment List
- Annex C Rogers Qualifications
- Annex D FCC Site Registration Letter
- Annex E Industry Canada Site Registration Letter

**Annex A Measurement Uncertainty Calculations**

Measurement uncertainty calculations were made for the laboratory. Result of measurement uncertainty calculations are recorded below for AC line conducted and radiated emission measurements.

| Measurement Uncertainty                       | $U_{(E)}$ | $U_{(lab)}$ |
|---|-----------|-------------|
| 3 Meter Horizontal 30-200 MHz Measurements    | 2.08      | 4.16        |
| 3 Meter Vertical 30-200 MHz Measurements      | 2.16      | 4.33        |
| 3 Meter Vertical Measurements 200-1000 MHz    | 2.99      | 5.97        |
| 10 Meter Horizontal Measurements 30-200 MHz   | 2.07      | 4.15        |
| 10 Meter Vertical Measurements 30-200 MHz     | 2.06      | 4.13        |
| 10 Meter Horizontal Measurements 200-1000 MHz | 2.32      | 4.64        |
| 10 Meter Vertical Measurements 200-1000 MHz   | 2.33      | 4.66        |
| 3 Meter Measurements 1-6 GHz                  | 2.57      | 5.14        |
| 3 Meter Measurements 6-18 GHz                 | 2.58      | 5.16        |
| AC Line Conducted                             | 1.72      | 3.43        |



**Annex B Rogers Labs Test Equipment List**

| List of Test Equipment  | Calibration Date |
|---|------------------|
| Spectrum Analyzer: Rohde & Schwarz ESU40  | 5/14             |
| Spectrum Analyzer: HP 8562A, HP Adapters: 11518, 11519, and 11520<br>Mixers: 11517A, 11970A, 11970K, 11970U, 11970V, 11970W | 5/14             |
| Spectrum Analyzer: HP 8591EM  | 5/14             |
| Antenna: EMCO Biconilog Model: 3143   | 5/14             |
| Antenna: Sunol Biconilog Model: JB6   | 10/14            |
| Antenna: EMCO Log Periodic Model: 3147  | 10/14            |
| Antenna: Com Power Model: AH-118  | 10/14            |
| Antenna: Com Power Model: AH-840  | 10/14            |
| Antenna: Antenna Research Biconical Model: BCD 235  | 10/14            |
| Antenna: EMCO 6509  | 10/14            |
| LISN: Compliance Design Model: FCC-LISN-2.Mod.cd, 50 µHy/50 ohm/0.1 µf  | 10/14            |
| R.F. Preamp CPPA-102  | 10/14            |
| Attenuator: HP Model: HP11509A  | 10/14            |
| Attenuator: Mini Circuits Model: CAT-3  | 10/14            |
| Attenuator: Mini Circuits Model: CAT-3  | 10/14            |
| Cable: Belden RG-58 (L1)  | 10/14            |
| Cable: Belden RG-58 (L2)  | 10/14            |
| Cable: Belden 8268 (L3)   | 10/14            |
| Cable: Time Microwave: 4M-750HF290-750  | 10/14            |
| Cable: Time Microwave: 10M-750HF290-750   | 10/14            |
| Frequency Counter: Leader LDC825  | 2/14             |
| Oscilloscope Scope: Tektronix 2230  | 2/14             |
| Wattmeter: Bird 43 with Load Bird 8085  | 2/14             |
| Power Supplies: Sorensen SRL 20-25, SRL 40-25, DCR 150, DCR 140   | 2/14             |
| R.F. Generators: HP 606A, HP 8614A, HP 8640B  | 2/14             |
| R.F. Power Amp 65W Model: 470-A-1010  | 2/14             |
| R.F. Power Amp 50W M185- 10-501   | 2/14             |
| R.F. Power Amp A.R. Model: 10W 1010M7   | 2/14             |
| R.F. Power Amp EIN Model: A301  | 2/14             |
| LISN: Compliance Eng. Model 240/20  | 2/14             |
| LISN: Fischer Custom Communications Model: FCC-LISN-50-16-2-08  | 2/14             |
| Antenna: EMCO Dipole Set 3121C  | 2/14             |
| Antenna: C.D. B-101   | 2/14             |
| Antenna: Solar 9229-1 & 9230-1  | 2/14             |
| Audio Oscillator: H.P. 201CD  | 2/14             |
| ELGAR Model: 1751   | 2/14             |
| ELGAR Model: TG 704A-3D   | 2/14             |
| ESD Test Set 2010i  | 2/14             |
| Fast Transient Burst Generator Model: EFT/B-101   | 2/14             |
| Field Intensity Meter: EFM-018  | 2/14             |
| KEYTEK Ecat Surge Generator   | 2/14             |
| Shielded Room 5 M x 3 M x 3.0 M   |                  |



## ***Annex C Rogers Qualifications***

***Scot D. Rogers, Engineer***

### **Rogers Labs, Inc.**

Mr. Rogers has approximately 17 years' experience in the field of electronics. Engineering experience includes six years in the automated controls industry and remaining years working with the design, development and testing of radio communications and electronic equipment.

#### Positions Held

Systems Engineer: A/C Controls Mfg. Co., Inc. 6 Years

Electrical Engineer: Rogers Consulting Labs, Inc. 5 Years

Electrical Engineer: Rogers Labs, Inc. Current

#### Educational Background

- 1) Bachelor of Science Degree in Electrical Engineering from Kansas State University.
- 2) Bachelor of Science Degree in Business Administration Kansas State University.
- 3) Several Specialized Training courses and seminars pertaining to Microprocessors and Software programming.

Scot D. Rogers





NVLAP Lab Code 200087-0

**Annex D FCC Site Registration Letter**

**FEDERAL COMMUNICATIONS COMMISSION**

**Laboratory Division  
7435 Oakland Mills Road  
Columbia, MD 21046**

June 28, 2013

Registration Number: 90910

Rogers Labs, Inc.  
4405 West 259th Terrace,  
Louisburg, KS 66053

Attention: Scot Rogers,

Re: Measurement facility located at Louisburg  
3 & 10 meter site  
Date of Renewal: June 28, 2013

Dear Sir or Madam:

Your request for renewal of the registration of the subject measurement facility has been received. The information submitted has been placed in your file and the registration has been renewed. The name of your organization will remain on the list of facilities whose measurement data will be accepted in conjunction with applications for Certification under Parts 15 or 18 of the Commission's Rules. Please note that the file must be updated for any changes made to the facility and the registration must be renewed at least every three years.

Measurement facilities that have indicated that they are available to the public to perform measurement services on a fee basis may be found on the FCC website [www.fcc.gov](http://www.fcc.gov) under E-Filing, OET Equipment Authorization Electronic Filing, Test Firms.

Sincerely,

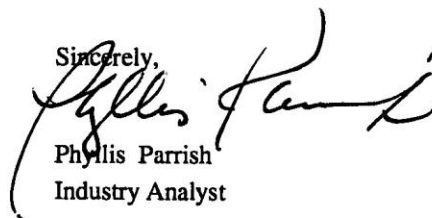

Phyllis Parrish  
Industry Analyst

Rogers Labs, Inc.  
4405 W. 259th Terrace  
Louisburg, KS 66053  
Phone/Fax: (913) 837-3214  
Revision 1

Garmin International, Inc.  
Model: A02564  
Test #: 141010  
Test to: CFR47 (15.249), RSS-210  
File: Garmin A02564 FCC TstRpt 141010

SN: 3892059915  
FCC ID#: IPH-02564  
IC: 1792A-02564  
Date: June 12, 2015  
Page 33 of 34



NVLAP Lab Code 200087-0

## Annex E Industry Canada Site Registration Letter

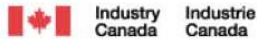

June 19, 2013

OUR FILE: 46405-3041

Submission No: 168037

Rogers Labs Inc.  
4405 West 259th Terrace  
Louisburg  
KS, USA  
66053

**Attention:** Mr. Scot D. Rogers

Dear Sir:

The Bureau has received your application for the renewal of 3/10m OATS. Be advised that the information received was satisfactory to Industry Canada. The following number(s) is now associated to the site(s) for which registration / renewal was sought (**Site# 3041A-1**). Please reference the appropriate site number in the body of test reports containing measurements performed on the site. In addition, please keep for your records the following information;

- The company address code associated to the site(s) located at the above address is: **3041A**

Furthermore, to obtain or renew a unique site number, the applicant shall demonstrate that the site has been accredited to ANSI C63.4-2003 or later. A scope of accreditation indicating the accreditation by a recognized accreditation body to ANSI C63.4-2003 or later shall be accepted. Please indicate in a letter the previous assigned site number if applicable and the type of site (example: 3 metre OATS or 3 metre chamber). If the test facility is not accredited to ANSI C63.4-2003 or later, the test facility shall submit test data demonstrating full compliance with the ANSI standard. The Bureau will evaluate the filing to determine if recognition shall be granted.

The frequency for re-validation of the test site and the information that is required to be filed or retained by the testing party shall comply with the requirements established by the accrediting organization. However, in all cases, test site re-validation shall occur on an interval not to **exceed three years**. There is no fee or form associated with an OATS filing. OATS submissions are encouraged to be submitted electronically to the Bureau using the following URL;

[http://strategis.ic.gc.ca/epic/internet/inceb-bhst.nsf/en/h\\_tt00052e.html](http://strategis.ic.gc.ca/epic/internet/inceb-bhst.nsf/en/h_tt00052e.html).

If you have any questions, you may contact the Bureau by e-mail at [certification.bureau@ic.gc.ca](mailto:certification.bureau@ic.gc.ca) Please reference our file and submission number above for all correspondence.

Yours sincerely,

Bill Payn  
For: Wireless Laboratory Manager  
**Certification and Engineering Bureau**  
3701 Carling Ave., Building 94  
P.O. Box 11490, Station "H"  
Ottawa, Ontario K2H 8S2  
Email: [Bill.Payn@ic.gc.ca](mailto:Bill.Payn@ic.gc.ca)  
Tel. No. (613) 990-3639  
Fax. No. (613) 990-4752

Rogers Labs, Inc.  
4405 W. 259th Terrace  
Louisburg, KS 66053  
Phone/Fax: (913) 837-3214  
Revision 1

Garmin International, Inc.  
Model: A02564  
Test #: 141010  
Test to: CFR47 (15.249), RSS-210  
File: Garmin A02564 FCC TstRpt 141010

SN: 3892059915  
FCC ID#: IPH-02564  
IC: 1792A-02564  
Date: June 12, 2015  
Page 34 of 34