

Application For Grant of Certification

FOR

Model: **GLO**

GPN 011-02921-xx

Low Power Transmitter

FCC ID: IPH-01156

IC: 1792A-01156

FOR

GARMIN INTERNATIONAL, INC.

1200 East 151st Street

Olathe, KS 66062

Test Report Number 120508

Authorized Signatory: *Scot D Rogers*

Scot D. Rogers

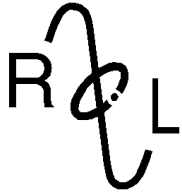

ROGERS LABS, INC.

4405 West 259th Terrace
Louisburg, KS 66053
Phone / Fax (913) 837-3214

Test Report for Application of Certification

For

GARMIN INTERNATIONAL, INC.

1200 East 151st Street
Olathe, KS 66062

Phone: (913) 397-8200

Mr. Van Ruggles
Director of Quality Assurance

Model: GLO
GPN 011-02921-xx
Low Power Transmitter

Frequency Range: 2,402-2,480 MHz

FCC ID: IPH-01156
IC: 1792A-01156

Test Report Number: 120508

Test Date: May 8, 2012

Authorized Signatory: *Scot D. Rogers*

Scot D. Rogers
Rogers Labs, Inc.
4405 West 259th Terrace
Louisburg, KS 66053
Telephone/Facsimile: (913) 837-3214

This report shall not be reproduced except in full, without the written approval of the laboratory. This report must not be used by the client to claim product endorsement by NVLAP, NIST, or any agency of the Federal Government.



Table of Contents

TABLE OF CONTENTS..... 3

FORWARD 5

APPLICABLE STANDARDS & TEST PROCEDURES 5

OPINION / INTERPRETATION OF RESULTS 5

STATEMENT OF MODIFICATIONS AND DEVIATIONS 6

ENVIRONMENTAL CONDITIONS..... 6

UNITS OF MEASUREMENTS 6

TEST SITE LOCATIONS 6

LIST OF TEST EQUIPMENT 7

APPLICATION FOR CERTIFICATION 8

EQUIPMENT TESTED SETUP, FUNCTION AND CONFIGURATIONS 9

 Equipment Function and Test Setup.....9

 EUT Configuration Options10

SUBPART C - INTENTIONAL RADIATORS 10

 AC Line Conducted Emission Test Procedure.....10

 Radiated Emission Test Procedure11

ANTENNA REQUIREMENTS 11

RESTRICTED BANDS OF OPERATION 11

 Radiated Emissions in Restricted Bands Data12

 Summary of Results for Radiated Emissions in Restricted Bands12

 AC Line Conducted EMI Procedure.....13

 Figure One AC Line Conducted emissions of EUT line 1 (EUT AC Adapter) 14

 Figure Two AC Line Conducted emissions of EUT line 2 (EUT AC Adapter)..... 14

 Figure Three AC Line Conducted emissions of EUT line 1 (EUT USB to CPU)..... 15



Figure Four AC Line Conducted emissions of EUT line 2 (EUT USB to CPU) 15
 Data AC Line Conducted Emissions 16

Summary of Results for AC Line Conducted Emissions 17

General Radiated EMI Testing Procedure 18

General Radiated Emissions Data (worst-case) 18

Summary of Results for General Radiated Emissions 19

OPERATION IN THE BAND 2,400-2,483.5 MHZ 19

Figure Five output measured at temporary antenna terminal 20
 Figure Six output measured at temporary antenna terminal 20
 Figure Seven output measured at temporary antenna terminal 21
 Figure Eight output measured at temporary antenna terminal 21
 Figure Nine output measured at temporary antenna terminal 22
 Figure Ten output measured at temporary antenna terminal 22
 Figure Eleven Occupied Bandwidth (low channel) 23
 Figure Twelve Occupied Bandwidth (middle channel) 23
 Figure Thirteen Occupied Bandwidth (high channel) 24
 Figure Fourteen Operation across frequency band 24
 Figure Fifteen Low Frequency Band Edge 25
 Figure Sixteen High Frequency Band Edge 25

Transmitter Radiated Emissions Data 26

Transmitter Antenna Port Conducted Emissions Data 26
 Transmitter Radiated Emissions 26

Summary of Results for Transmitter Radiated Emissions 27

ANNEX 28

Annex A Measurement Uncertainty Calculations 29

Annex B Rogers Labs Test Equipment List 31

Annex C Rogers Qualifications 32

Annex D FCC Test Site Registration Letter 33

Annex E Industry Canada Test Site Registration Letter 34



Forward

The following information in this document is submitted for consideration in obtaining Grant of Certification for low power intentional radiator per CFR 47 Paragraph 15.249, and Industry Canada RSS-210, operation in the 2400 – 2483.5 MHz band.

Name of Applicant: Garmin International, Inc.
1200 East 151st Street
Olathe, KS 66062

Model: GLO, GPN 011-02921-xx

FCC ID: IPH-01156 Industry Canada ID: 1792A-01156

Frequency Range: 2402-2480 MHz

Operating Power: Less than 2 mW measured maximum peak power 89.1 dB μ V/m @ 3 meters (and average 70.2 dB μ V/m @ 3 meters), 6-dB occupied bandwidth 455.0 kHz

Applicable Standards & Test Procedures

In accordance with the Federal Communications Commission and Code of Federal Regulations CFR 47, dated October 1, 2011, Part 2, Subpart J, Paragraphs 2.907, 2.911, 2.913, 2.925, 2.926, 2.1031 through 2.1057, applicable parts of paragraph 15, Part 15C paragraph 15.249, and Industry Canada RSS-210, the following information is submitted. Test procedures used are the established Methods of Measurement of Radio-Noise Emissions as described in the ANSI C63.4-2009 Document.

Opinion / Interpretation of Results

Test Performed	Minimum Margin (dB)	Results
Antenna requirement per CFR 47 15.203, RSS-210	NA	Complies
Restricted Bands Emissions as per CFR 47 15.205	-17.7	Complies
AC Line Conducted Emissions as per CFR 47 15.207	-9.6	Complies
Radiated Emissions as per CFR 47 15.209	-9.3	Complies
Emissions per CFR 47 15.249 (Harmonics)	-10.1	Complies
Emissions per RSS-210	As Documented	Complies



Statement of Modifications and Deviations

No modifications to the EUT were required for the equipment to demonstrate compliance with CFR 47 Part 15C, or RSS-210 Emissions Requirements. There were no deviations or modification to the specifications.

Environmental Conditions

Ambient Temperature	21.5° C
Relative Humidity	47%
Atmospheric Pressure	1016.9 mb

Units of Measurements

Conducted EMI: Data is in dBµV; dB referenced to one microvolt.

Radiated EMI: Data is in dBµV/m; dB/m referenced to one microvolt per meter.

Radiated Emissions Calculations:

Note: The limit is expressed for a measurement in dBµV/m when the measurement is taken at a distance of 3 meters. Data taken for this report was taken at a distance of 3 meters.

$$\text{dB}\mu\text{V/m @ 3m} = \text{FSM}(\text{dB}\mu\text{V}) + \text{A.F.}(\text{dB/m}) - \text{Amp Gain}(\text{dB})$$

Test Site Locations

Conducted EMI Rogers Labs, Inc. located at 4405 W. 259th Terrace, Louisburg, KS.

Radiated EMI Performed at Rogers Labs, Inc. 3 meters Open Area Test Site (OATS) located at 4405 W. 259th Terrace, Louisburg, KS.

Site Registration Refer to Annex for FCC Site Registration Letter, Reference 90910, Industry Canada Site Registration Reference 3041A-1

Accreditation NVLAP Accreditation Lab Code 200087-0

List of Test Equipment

A Rohde and Schwarz ESU40, Hewlett Packard 8591EM and or 8562A Spectrum Analyzer was used as the measuring equipment for emissions testing. The analyzer settings used are described in the following table. Refer to the annex for a complete list of Test Equipment.

Spectrum Analyzer Settings		
AC Line Conducted Emissions		
RBW	AVG. BW	Detector Function
9 kHz	30 kHz	Peak/Quasi Peak
Radiated Emissions (30 – 1000 MHz)		
RBW	AVG. BW	Detector Function
120 kHz	300 kHz	Peak/Quasi Peak
Spectrum Analyzer Settings		
Radiated Emissions (1 – 40 GHz)		
RBW	AVG. BW	Detector Function
1 MHz	1 MHz	Peak/Average
Antenna Conducted Emissions		
RBW	AVG. BW	Detector Function
120 kHz	300 kHz	Peak

<u>Equipment</u>	<u>Manufacturer</u>	<u>Model</u>	<u>Calibration Date</u>	<u>Due</u>
LISN	Comp. Design	FCC-LISN-2-MOD.CD	10/11	10/12
Antenna	ARA	BCD-235-B	10/11	10/12
Antenna	EMCO	3147	10/11	10/12
Antenna	EMCO	3143	5/11	5/12
Analyzer	HP	8591EM	5/11	5/12
Analyzer	HP	8562A	5/11	5/12
Analyzer	Rohde & Schwarz	ESU40	5/11	5/12



Application for Certification

- (1) Manufacturer: Garmin International, Inc.
 1200 East 151st Street
 Olathe, KS 66062
 Telephone: (913) 397-8200

- (2) Identification: FCC I.D.: IPH-01156 IC: 1792A-01156

- (3) Copy of the installation and operating manual: Refer to exhibit for Draft Instruction Manual.

- (4) Description of Circuit Functions, Device Operation: Refer to operational description exhibit for circuit device operation.

- (5) Block Diagram with Frequencies: Refer to exhibit for Block Diagram

- (6) Report of measurements demonstrating compliance with the pertinent FCC/IC technical requirements provided in this report.

- (7) Photographs of equipment are provided in other application exhibits.

- (8) Peripheral equipment or accessories for the equipment. Optional equipment available for the EUT includes AC power supply, DC cigarette lighter adapter, and USB cable for computer interface. The available configuration options were investigated for this and other reports in compliance with required standards with worst-case data presented.

- (9) Transition Provisions of 15.37 are not being requested

- (10) The equipment is not a scanning receiver.

- (11) The equipment is not a transmitter operating in the 59-64 GHz frequency range.

- (12) The equipment is not software defined and this section is not applicable.

Equipment Tested Setup, Function and Configurations

<u>Equipment</u>	<u>Model/GPN</u>	<u>Serial Number</u>	<u>FCC ID</u>
GLO (EUT)	011-02921-xx	3845646906b	IPH-01156
GLO (Sample 2)	011-02921-xx	3845646922b	IPH-01156
CLA (DC/DC Adapter)	320-00239-04	N/A	N/A
AC CLA Adapter	010-10723-08	N/A	N/A
USB Interface Cable	320-00541-01	N/A	N/A
Laptop Computer	Dell Studio XPS	921LBBN1	N/A
USB Printer	Dell 0N5819	5D1SL61	N/A

Equipment Function and Test Setup

The EUT is a GPS receiver offering reception of location, navigation, and other information for the user. The design incorporates a low power transmitter with operation capability in the 2402-2480 MHz frequency band (CFR 47 15.249 and RSS-210). The GPS design offers use as a portable configuration for use in navigational applications. The equipment offers communication capability with compliant 2402-2480 MHz equipment. Two samples were supplied for testing one production design and the other modified for testing purposes replacing integral antenna with RF connection port. Both samples were provided with test software enabling testing personnel ability to enable transmitter on defined channels. The antenna modification offered testing facility ability to connect transmitter antenna port to test equipment for antenna port conducted emissions testing. The EUT was arranged as typical user equipment configurations for testing purposes. The transmitter offers no other interface connections than those in the configuration diagrams shown below. The unit operates from internal battery or external power received from external power supply options as presented. Some configurations offered are not applicable for this report and have been tested and documented in other relevant documentation. As requested by the manufacturer and required by regulations, the equipment was tested for emissions compliance using the available configurations with the worst-case data presented. Test results in this report relate only to the products described in this report.

EUT Configuration Options

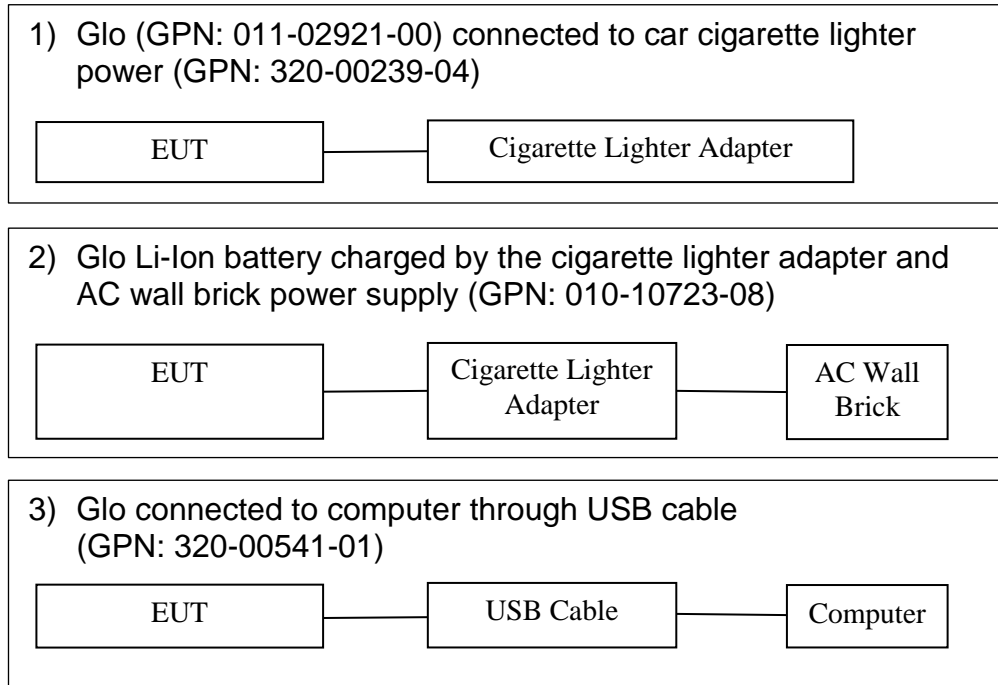

Subpart C - Intentional Radiators

As per CFR 47 Part 15, Subpart C and RSS-210 the following information is submitted for consideration in obtaining grant of certification for unlicensed intentional radiators.

AC Line Conducted Emission Test Procedure

Testing for the AC line-conducted emissions was performed as defined in sections 7.2.4 and 13.3 of ANSI C63.4-2009. The test setup, including the EUT, was arranged in the test configurations as presented during testing. The test configuration was placed on a 1 x 1.5-meter wooden bench, 0.8 meters high located in a screen room. The power lines of the system were isolated from the power source using a standard LISN with a 50- μ Hy choke. EMI was coupled to the spectrum analyzer through a 0.1 μ F capacitor internal to the LISN. The LISN was positioned on the floor beneath the wooden bench supporting the EUT. The power lines and cables were draped over the back edge of the table. Refer to photographs in exhibits for EUT placement used during testing.



Radiated Emission Test Procedure

Testing for the radiated emissions was performed as defined in sections 8.3 and 13.1 of ANSI C63.4-2009. The EUT was arranged in the test configurations as shown above during testing. The test configuration was placed on a rotating 1 x 1.5-meter wooden platform 0.8 meters above the ground plane at a distance of 3 meters from the FSM antenna. EMI energy was maximized by equipment placement, raising and lowering the FSM antenna, changing the antenna polarization, and by rotating the turntable. Each emission was maximized before final data was taken using a spectrum analyzer. Refer to photographs in exhibits for EUT placement used during testing.

Antenna Requirements

The unit is produced with permanently attached transmitter antenna located inside the sealed case. No provisions for modification or alterations of the antenna configuration are available to the end user. The EUT demonstrates compliance with the unique antenna connection requirements of CFR47 15.203 and other relevant standards. There are no deviations or exceptions to the specification.

Restricted Bands of Operation

Spurious emissions falling in the restricted frequency bands of operation were measured at the OATS. The EUT utilizes frequency, determining circuitry, which generates harmonics falling in the restricted bands. Emissions were investigated at the OATS, using appropriate antennas or pyramidal horns, amplification stages, and a spectrum analyzer. Peak and average amplitudes of frequencies above 1000 MHz were compared to the required limits with worst-case data presented below. Test procedures of ANSI C63.4-2009 paragraphs 13.1 and 8.3.1.2 were used during testing. No other significant emission was observed which fell into the restricted bands of operation. Computed emission values take into account the received radiated field strength, receive antenna correction factor, amplifier gain stage, and test system cable losses.

Radiated Emissions in Restricted Bands Data

Frequency in MHz	Horizontal Peak (dBµV/m)	Horizontal Quasi-Peak (dBµV/m)	Horizontal Average (dBµV/m)	Vertical Peak (dBµV/m)	Vertical Quasi-Peak (dBµV/m)	Vertical Average (dBµV/m)	Limit @ 3m (dBµV/m)
117.0	30.2	25.7	N/A	33.7	32.2	N/A	43.5
267.5	26.7	24.1	N/A	30.1	27.1	N/A	46.0
273.0	26.7	23.9	N/A	27.7	25.0	N/A	46.0
2390.0	43.0	N/A	29.6	43.9	N/A	29.6	54.0
2483.5	43.4	N/A	30.9	44.3	N/A	30.9	54.0
4804.0	49.2	N/A	36.3	49.1	N/A	36.2	54.0
4882.0	49.7	N/A	35.8	48.0	N/A	35.6	54.0
4960.0	48.0	N/A	35.3	48.6	N/A	35.6	54.0
7206.0	47.4	N/A	34.6	46.9	N/A	34.4	54.0
7323.0	44.9	N/A	32.1	45.2	N/A	32.3	54.0
7440.0	44.4	N/A	32.0	44.9	N/A	32.0	54.0
12010.0	47.5	N/A	35.2	47.9	N/A	35.3	54.0
12205.0	47.1	N/A	33.7	45.8	N/A	33.4	54.0
12400.0	47.2	N/A	34.7	46.8	N/A	34.3	54.0

Other emissions present had amplitudes at least 20 dB below the limit.

Peak and Quasi-Peak amplitude emissions are recorded above for frequency range of 26-1000 MHz. Peak and Average amplitude emissions are recorded above for frequency range above 1000 MHz.

Summary of Results for Radiated Emissions in Restricted Bands

The EUT demonstrated compliance with the radiated emissions requirements of FCC CFR 47 Part 15.205 and RSS-210 restricted bands of operation. The EUT worst-case configuration demonstrated minimum margin of -17.7 dB below the CFR 47 and RSS-210 limits. Other emissions were present with amplitudes at least 20 dB below the required limits.

AC Line Conducted EMI Procedure

The EUT was arranged in typical equipment configurations as offered by manufacturer. Testing was performed with the EUT placed on a 1 x 1.5-meter wooden bench 80 cm above the conducting ground plane, floor of a screen room. The bench was positioned 40 cm away from the wall of the screen room. The LISN was positioned on the floor of the screen room 80-cm from the rear of the EUT. Testing for the line-conducted emissions were the procedures of ANSI C63.4-2009 paragraphs 13.3 and 7.2.4. The AC adapter for the EUT was connected to the LISN for line-conducted emissions testing. A second LISN was positioned on the floor of the screen room 80-cm from the rear of the supporting equipment of the EUT. All power cords except the EUT were then powered from the second LISN. EMI was coupled to the spectrum analyzer through a 0.1 μ F capacitor, internal to the LISN. Power line conducted emissions testing was carried out individually for each current carrying conductor of the EUT. The excess length of lead between the system and the LISN receptacle was folded back and forth to form a bundle not exceeding 40 cm in length. The screen room, conducting ground plane, analyzer, and LISN were bonded together to the protective earth ground. Preliminary testing was performed to identify the frequencies of each of the emissions, which demonstrated the highest amplitudes. The cables were repositioned to obtain maximum amplitude of measured EMI level. Once the worst-case configuration was identified, plots were made of the EMI from 0.15 MHz to 30 MHz then data was recorded with maximum conducted emissions levels. Refer to figures one and two showing plots of the worst-case AC Line conducted emissions of the AC Adapter options while charging the EUT. Refer to figures three and four showing plots of the worst-case AC Line conducted emissions of the CPU AC Adapter while EUT was interfaced to computer through USB cable.

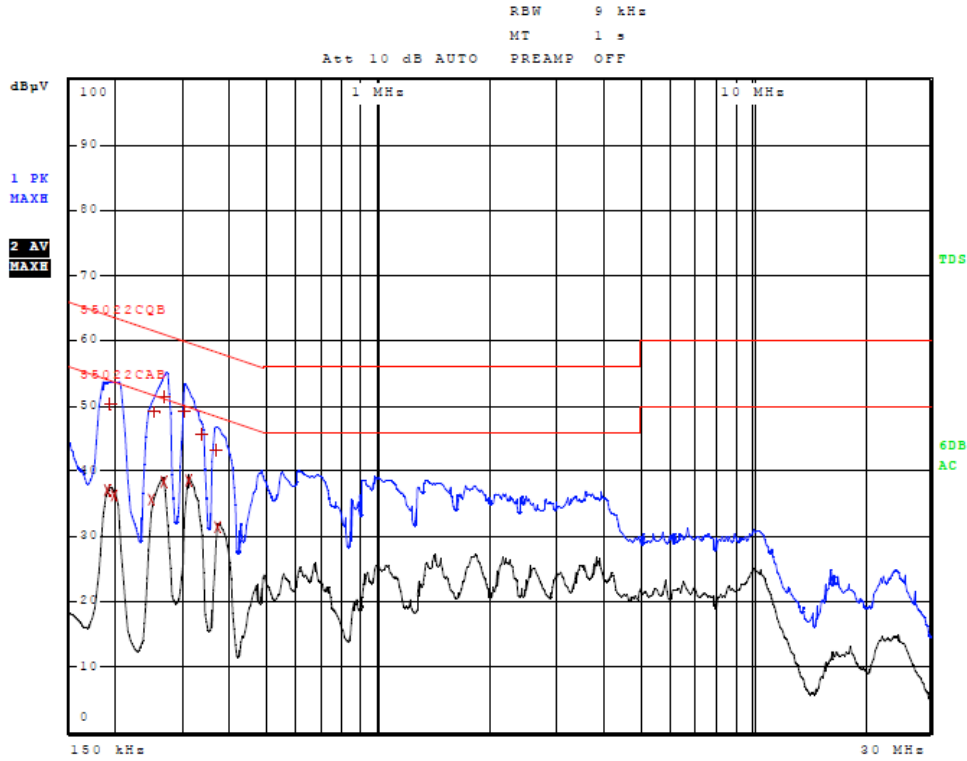

Figure One AC Line Conducted emissions of EUT line 1 (EUT AC Adapter)

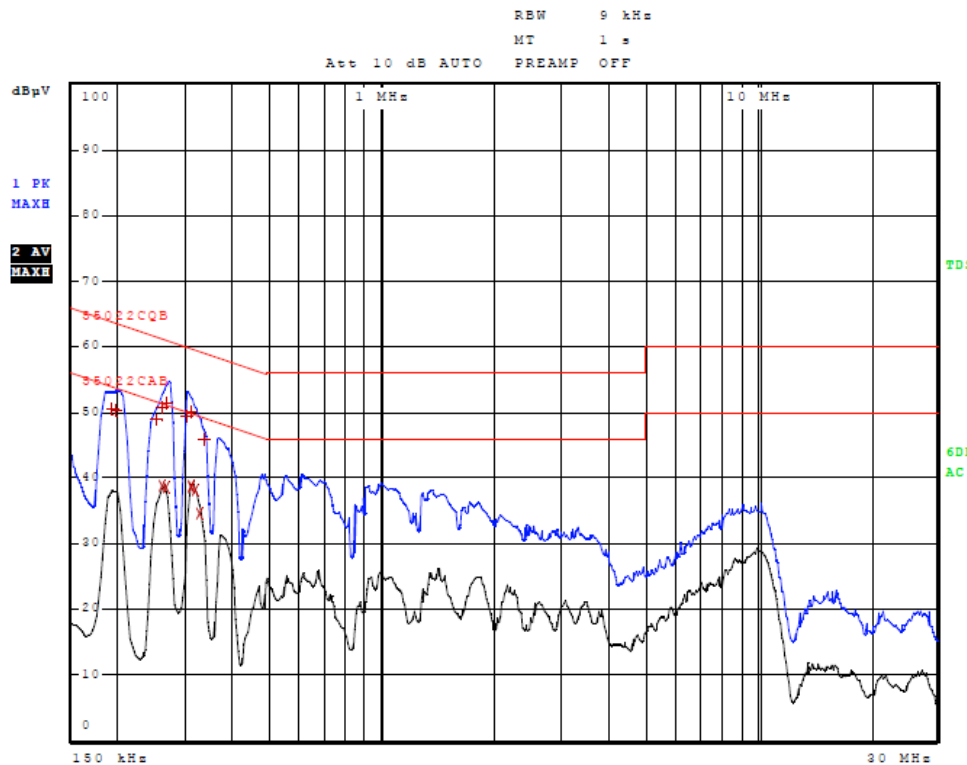

Figure Two AC Line Conducted emissions of EUT line 2 (EUT AC Adapter)

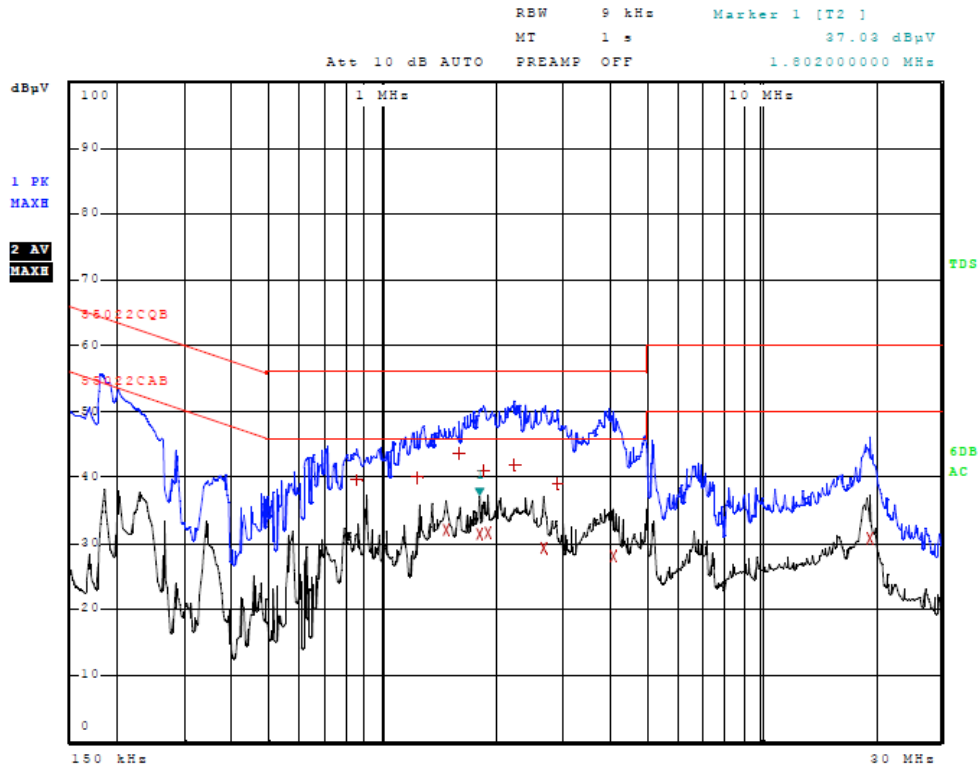

Figure Three AC Line Conducted emissions of EUT line 1 (EUT USB to CPU)

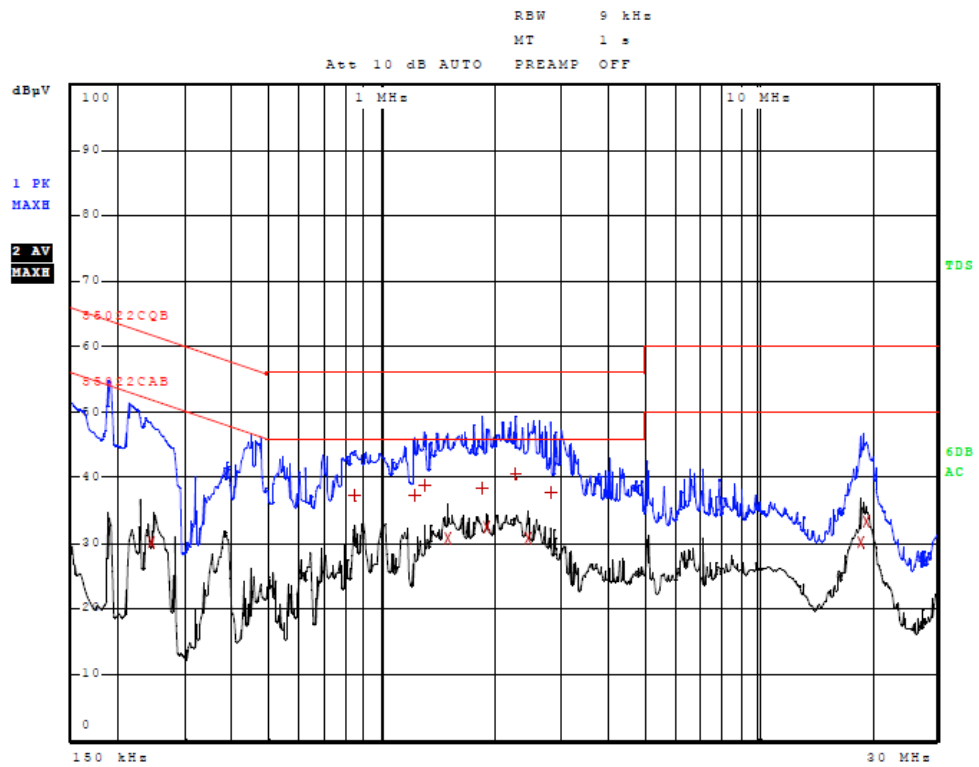

Figure Four AC Line Conducted emissions of EUT line 2 (EUT USB to CPU)



Data AC Line Conducted Emissions

Line 1 (EUT AC Adapter)

Trace	Frequency	Level (dBµV)	Detector	Delta Limit/dB
2	190.000000000 kHz	37.01	Average	-17.02
1	194.000000000 kHz	50.36	Quasi Peak	-13.50
2	198.000000000 kHz	36.19	Average	-17.50
2	250.000000000 kHz	35.63	Average	-16.12
1	254.000000000 kHz	48.98	Quasi Peak	-12.65
2	266.000000000 kHz	38.34	Average	-12.90
1	270.000000000 kHz	51.45	Quasi Peak	-9.67
1	302.000000000 kHz	49.23	Quasi Peak	-10.95
2	310.000000000 kHz	38.54	Average	-11.43
1	334.000000000 kHz	45.63	Quasi Peak	-13.72
1	366.000000000 kHz	43.16	Quasi Peak	-15.43
2	374.000000000 kHz	31.37	Average	-17.05

Other emissions present had amplitudes at least 20 dB below the limit.

Line 2 (EUT AC Adapter)

Trace	Frequency	Level (dBµV)	Detector	Delta Limit/dB
1	194.000000000 kHz	50.45	Quasi Peak	-13.42
1	198.000000000 kHz	50.30	Quasi Peak	-13.39
1	254.000000000 kHz	48.81	Quasi Peak	-12.81
1	262.000000000 kHz	50.75	Quasi Peak	-10.62
2	262.000000000 kHz	38.70	Average	-12.67
2	266.000000000 kHz	38.46	Average	-12.79
1	270.000000000 kHz	51.45	Quasi Peak	-9.66
1	302.000000000 kHz	49.38	Quasi Peak	-10.81
2	310.000000000 kHz	38.79	Average	-11.18
1	310.000000000 kHz	50.15	Quasi Peak	-9.82
2	314.000000000 kHz	38.54	Average	-11.32
2	318.000000000 kHz	38.07	Average	-11.69
2	330.000000000 kHz	34.66	Average	-14.79
1	334.000000000 kHz	45.81	Quasi Peak	-13.54

Other emissions present had amplitudes at least 20 dB below the limit.



Line 1 (EUT USB to CPU)

Trace	Frequency	Level (dBµV)	Detector	Delta Limit/dB
1	854.000000000 kHz	39.50	Quasi Peak	-16.50
1	1.230000000 MHz	39.95	Quasi Peak	-16.05
2	1.474000000 MHz	32.03	Average	-13.97
1	1.586000000 MHz	43.64	Quasi Peak	-12.36
2	1.802000000 MHz	31.43	Average	-14.57
1	1.854000000 MHz	41.15	Quasi Peak	-14.85
2	1.894000000 MHz	31.58	Average	-14.42
1	2.230000000 MHz	42.00	Quasi Peak	-14.00
2	2.670000000 MHz	29.32	Average	-16.68
1	2.890000000 MHz	38.88	Quasi Peak	-17.12
2	4.062000000 MHz	28.07	Average	-17.93
2	19.404000000 MHz	30.85	Average	-19.15

Other emissions present had amplitudes at least 20 dB below the limit.

Line 2 (EUT USB to CPU)

Trace	Frequency	Level (dBµV)	Detector	Delta Limit/dB
2	246.000000000 kHz	30.13	Average	-21.76
1	842.000000000 kHz	37.34	Quasi Peak	-18.66
1	1.214000000 MHz	37.21	Quasi Peak	-18.79
1	1.290000000 MHz	38.72	Quasi Peak	-17.28
2	1.494000000 MHz	30.79	Average	-15.21
1	1.846000000 MHz	38.26	Quasi Peak	-17.74
2	1.902000000 MHz	32.44	Average	-13.56
1	2.270000000 MHz	40.71	Quasi Peak	-15.29
2	2.442000000 MHz	30.76	Average	-15.24
1	2.810000000 MHz	37.63	Quasi Peak	-18.37
2	18.808000000 MHz	30.18	Average	-19.82
2	19.468000000 MHz	33.35	Average	-16.65

Other emissions present had amplitudes at least 20 dB below the limit.

Summary of Results for AC Line Conducted Emissions

The EUT demonstrated compliance with the AC Line Conducted Emissions requirements of CFR 47 Part 15B, RSS-GEN, and other applicable standards. The EUT worst-case configuration demonstrated a minimum margin of -9.6 dB below the limit. Other emissions were present with amplitudes at least 20 dB below the limit and worst-case amplitudes recorded.

General Radiated EMI Testing Procedure

The EUT was investigated while arranged in all typical equipment configurations and operated through all applicable modes. Preliminary testing was performed in a screen room with the EUT positioned 1 meter from the FSM. Investigations were performed to identify the frequencies, which produced the highest radiated emissions. Radiated emission investigations were performed from 9 kHz to 25,000 MHz with the EUT positioned in three orthogonal axes per regulations. Frequencies of interest were recorded for use during testing on the OATS. Each emission was then maximized at the OATS site before final radiated emissions measurements were performed. Final data was taken with the EUT located at the open field test site at a distance of 3 meters between the EUT and the receiving antenna. Test procedures of ANSI C63.4-2009 paragraphs 13.1 and 8.3.1.2 were used during radiated emissions testing. Peak and average amplitudes of frequencies above 1000 MHz were compared to the required limits with worst-case data presented below. Measured emission levels were maximized by EUT placement on the table, changing cable location, rotating the turntable through 360 degrees, varying the antenna height between 1 and 4 meters above the ground plane and changing antenna polarization between horizontal and vertical. Antennas used were Loop from 0.09 to 30 MHz, Broadband Biconical from 30 MHz to 200 MHz, Log Periodic from 200 MHz to 1 GHz, and/or Biconilog from 30 MHz to 1000 MHz, Double-Ridge, and/or Pyramidal Horns from 1 GHz to 25 GHz, and amplification stages.

General Radiated Emissions Data (worst-case)

Frequency in MHz	Horizontal Peak (dBµV/m)	Horizontal Quasi-Peak (dBµV/m)	Horizontal Average (dBµV/m)	Vertical Peak (dBµV/m)	Vertical Quasi-Peak (dBµV/m)	Vertical Average (dBµV/m)	Limit @ 3m (dBµV/m)
75.3	31.5	19.6	N/A	36.3	30.7	N/A	40.0
117.0	30.2	25.7	N/A	33.7	32.2	N/A	43.5
267.5	26.7	24.1	N/A	30.1	27.1	N/A	46.0
273.0	26.7	23.9	N/A	27.7	25.0	N/A	46.0

Other emissions present had amplitudes at least 20 dB below the limit.

Peak and Quasi-Peak amplitude emissions are recorded above for frequency range of 9 kHz to 1000 MHz. Peak and Average amplitude emissions are recorded above for frequency range above 1000 MHz.

Summary of Results for General Radiated Emissions

The EUT demonstrated compliance with the general radiated emissions requirements of FCC Part 15C, RSS-210 and other applicable standards for Intentional Radiators. The EUT worst-case configuration demonstrated minimum margin of -9.3 dB below the general radiated emissions limit. Other emissions were present with amplitudes at least 20 dB below the Limits.

Operation in the Band 2,400-2,483.5 MHz

The power output was measured on an open area test site @ 3 meters. Test procedures of ANSI C63.4-2009 paragraphs 13.1 and 8.3.1.2 were used during testing. The EUT was placed on a wooden turntable 0.8 meters above the ground plane and at a distance of 3 meters from the FSM antenna. The peak and quasi-peak amplitude of frequencies below 1000 MHz were measured using a spectrum analyzer. The peak and average amplitude of frequencies above 1000 MHz were measured using a spectrum analyzer. The amplitude of each emission was then recorded from the analyzer display. Emissions radiated outside of the specified bands, except for harmonics, shall be attenuated by at least 50 dB below the level of the fundamental or to the general radiated emission limits in 15.209, whichever is the lesser attenuation. Refer to figures five through sixteen showing the frequency and amplitude of emission displayed on the spectrum analyzer as measured at the temporary test antenna port (performed on sample #2). The amplitude of each emission was measured on the OATS at a distance of 3 meters from the FSM antenna (testing was performed on sample 1 representative of production with integral antenna). The amplitude of each radiated emission was maximized by varying the FSM antenna height, polarization, and by rotating the turntable. A Loop antenna was used for measuring emissions from 0.009 to 30 MHz, Biconilog Antenna for 30 to 1000 MHz, Double-Ridge, and/or Pyramidal Horn Antennas from 1 GHz to 25 GHz. Emissions were measured in dBµV/m @ 3 meters.

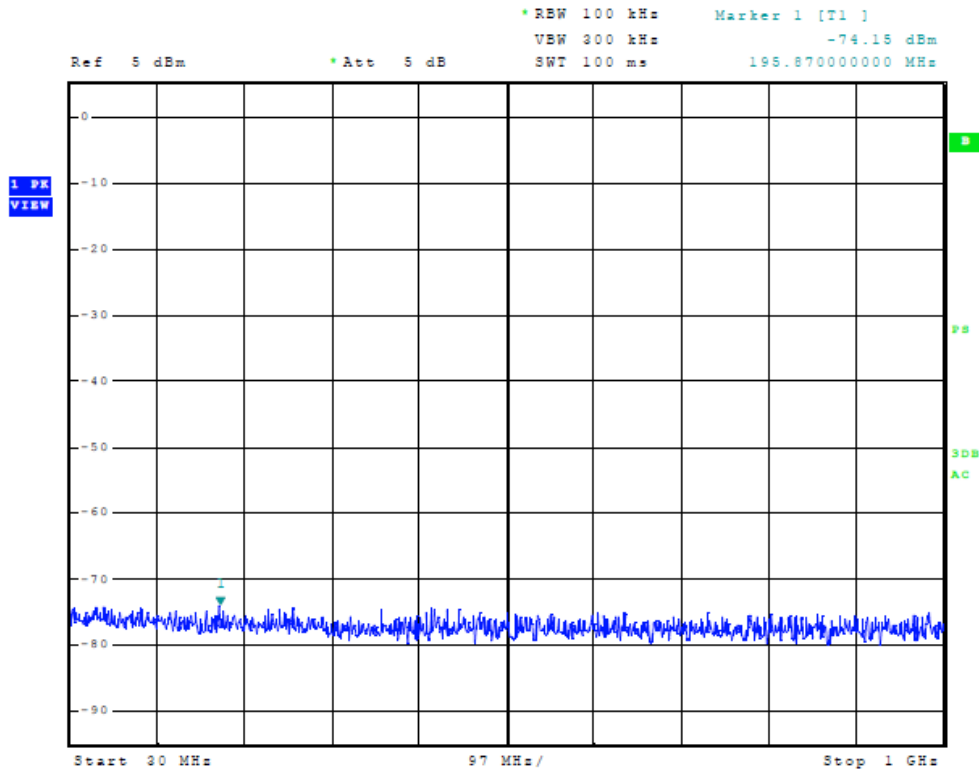

Figure Five output measured at temporary antenna terminal

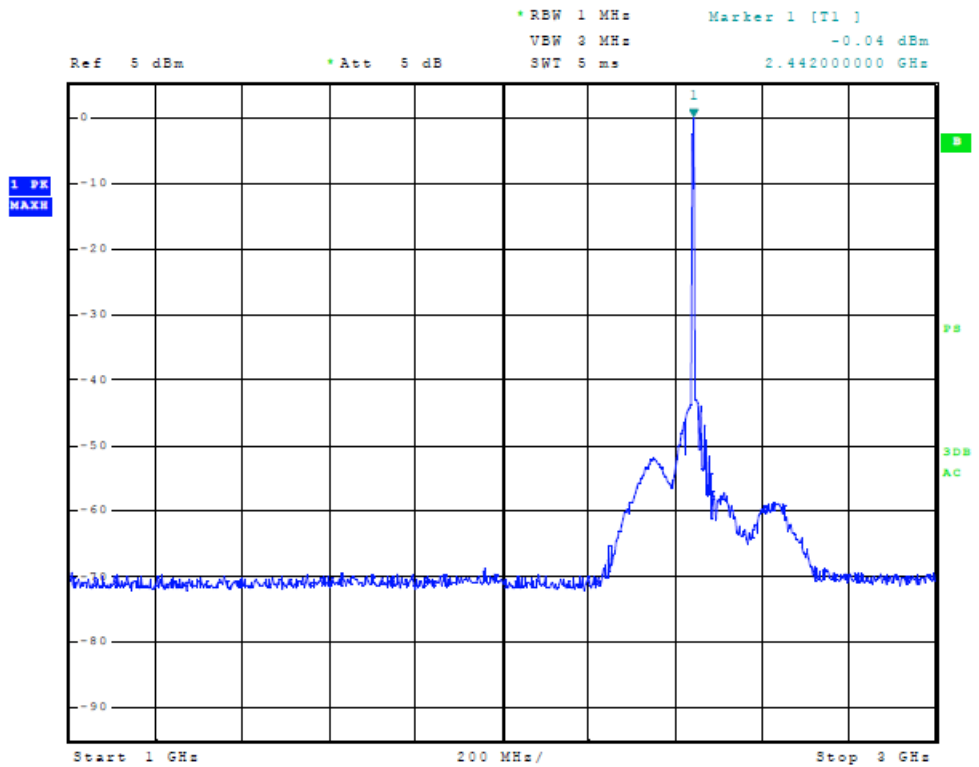

Figure Six output measured at temporary antenna terminal

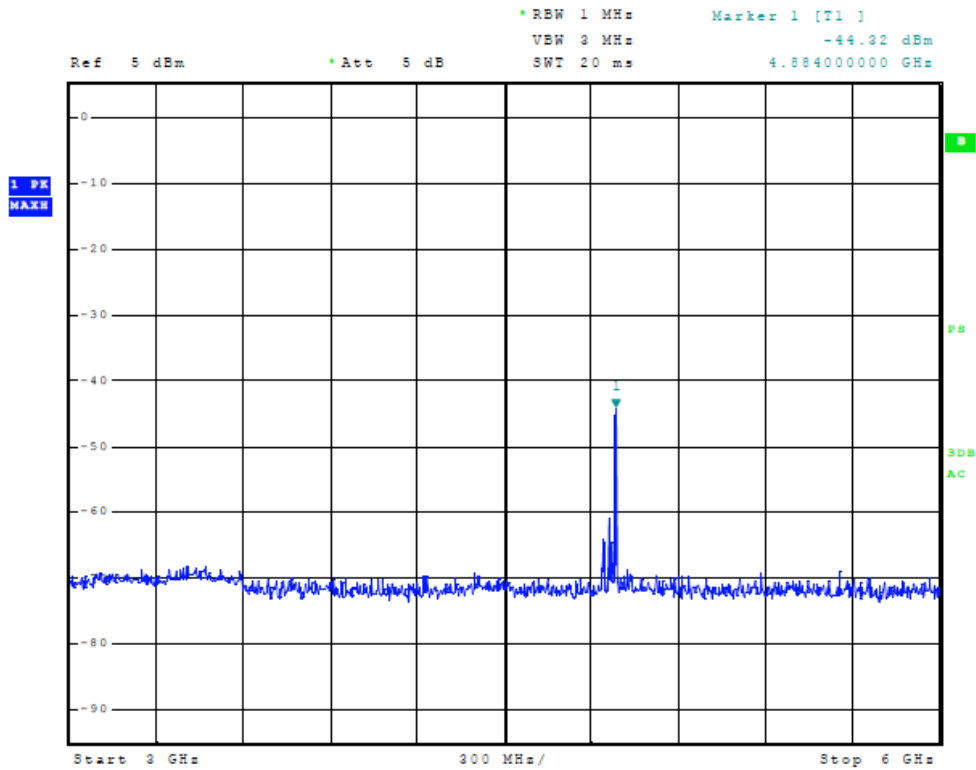

Figure Seven output measured at temporary antenna terminal

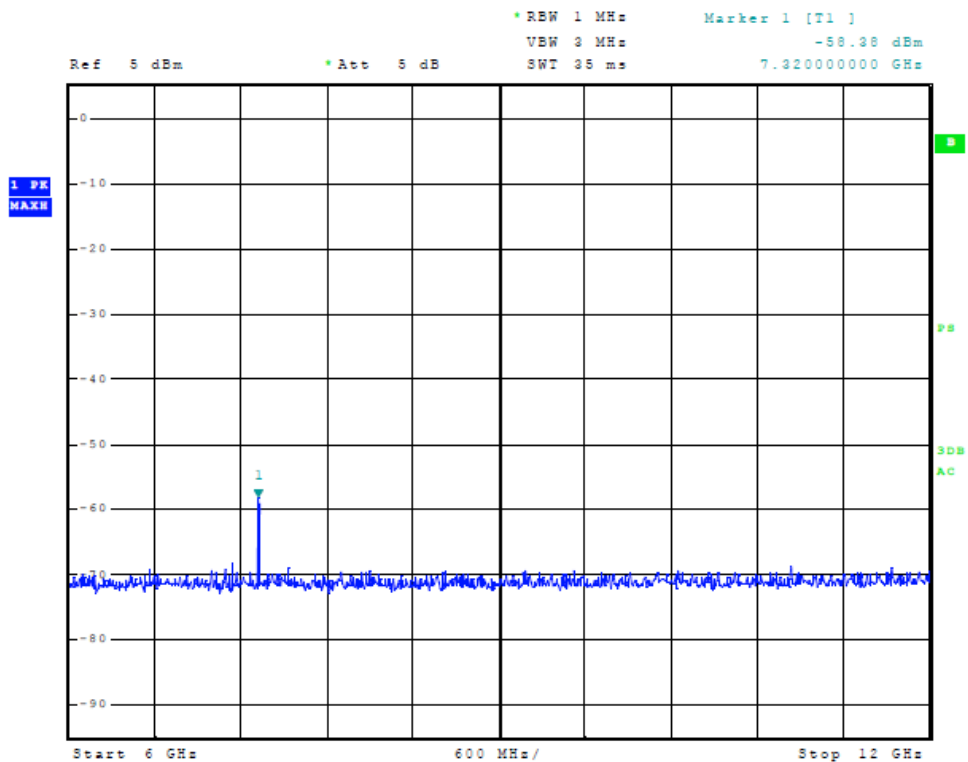

Figure Eight output measured at temporary antenna terminal

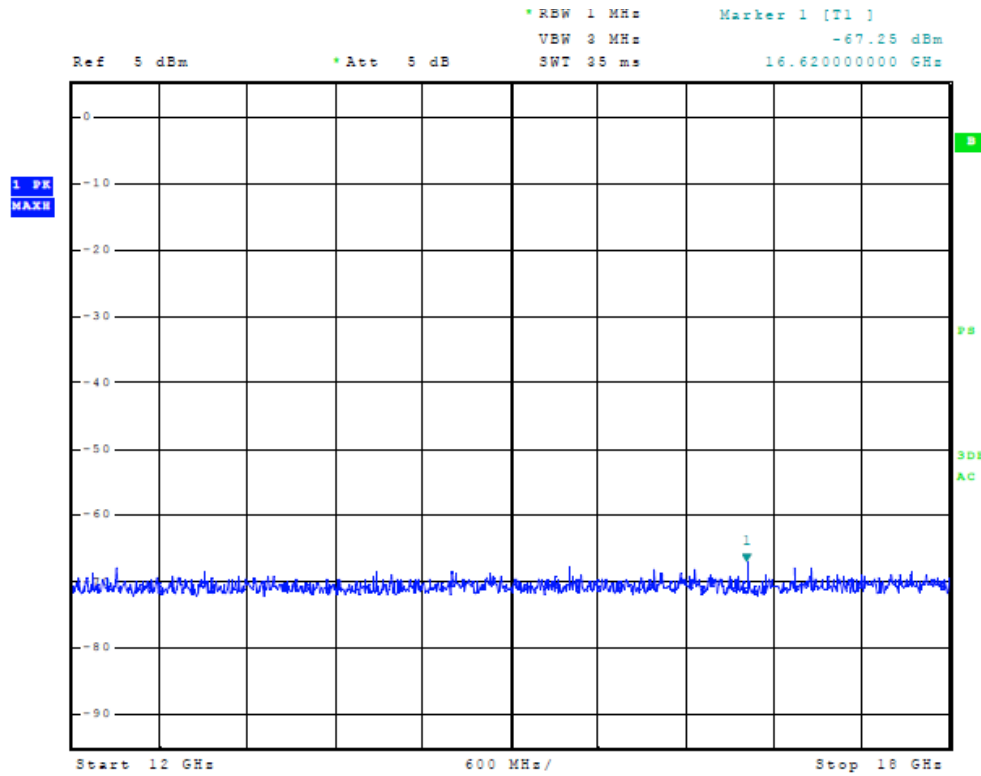

Figure Nine output measured at temporary antenna terminal

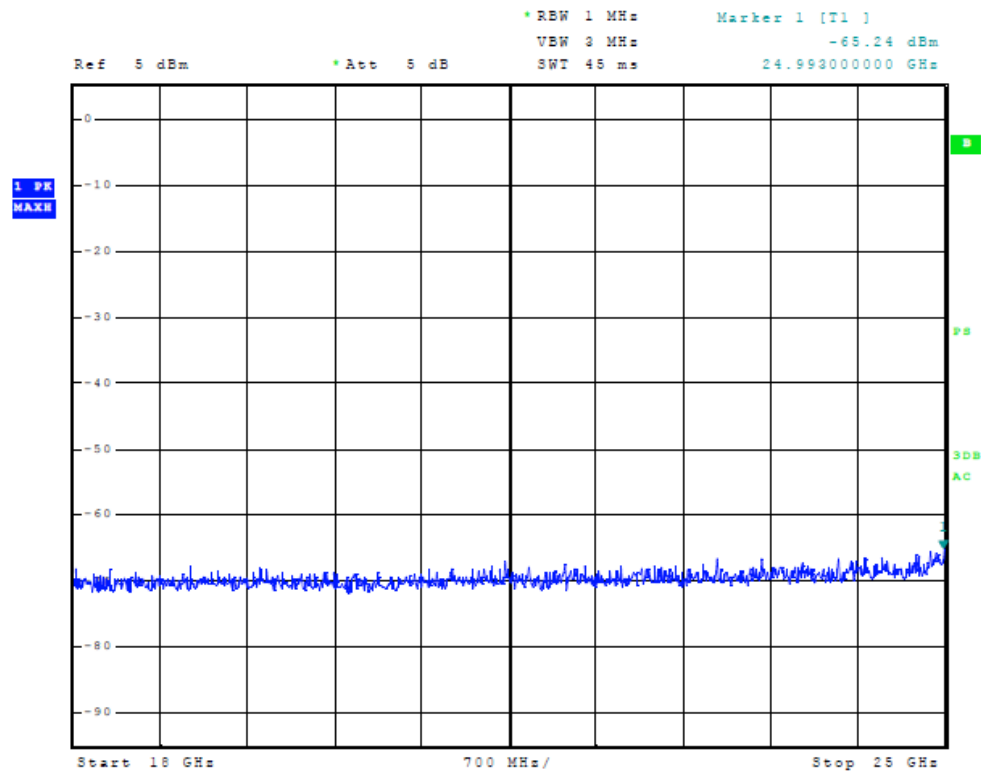

Figure Ten output measured at temporary antenna terminal

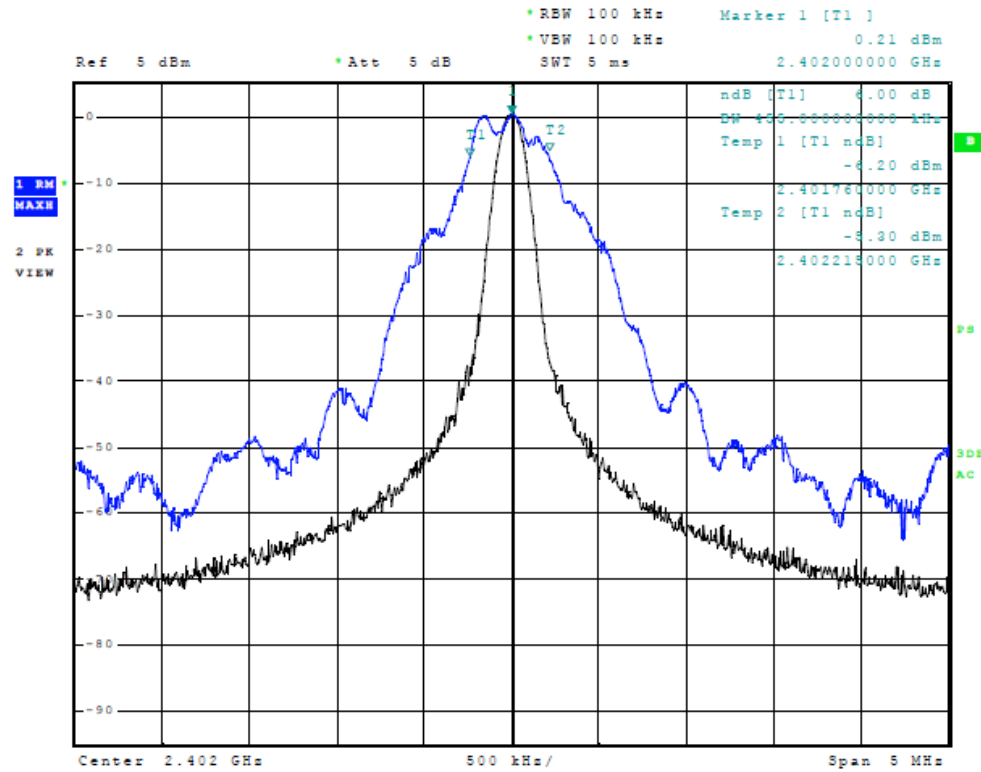

Figure Eleven Occupied Bandwidth (low channel)

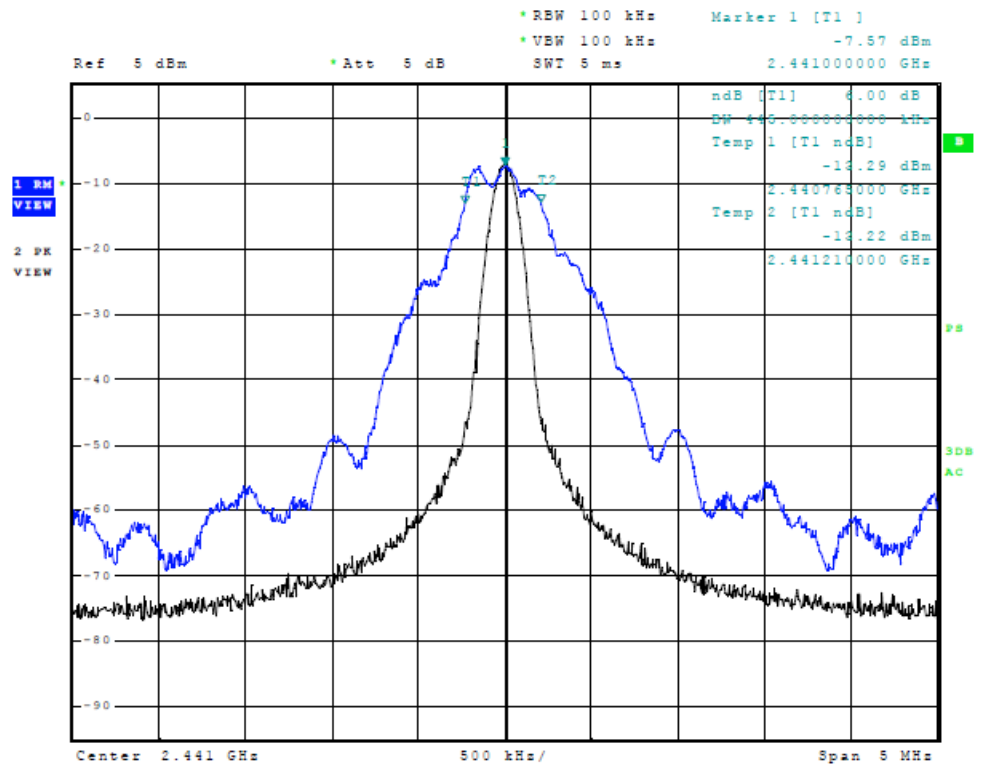

Figure Twelve Occupied Bandwidth (middle channel)

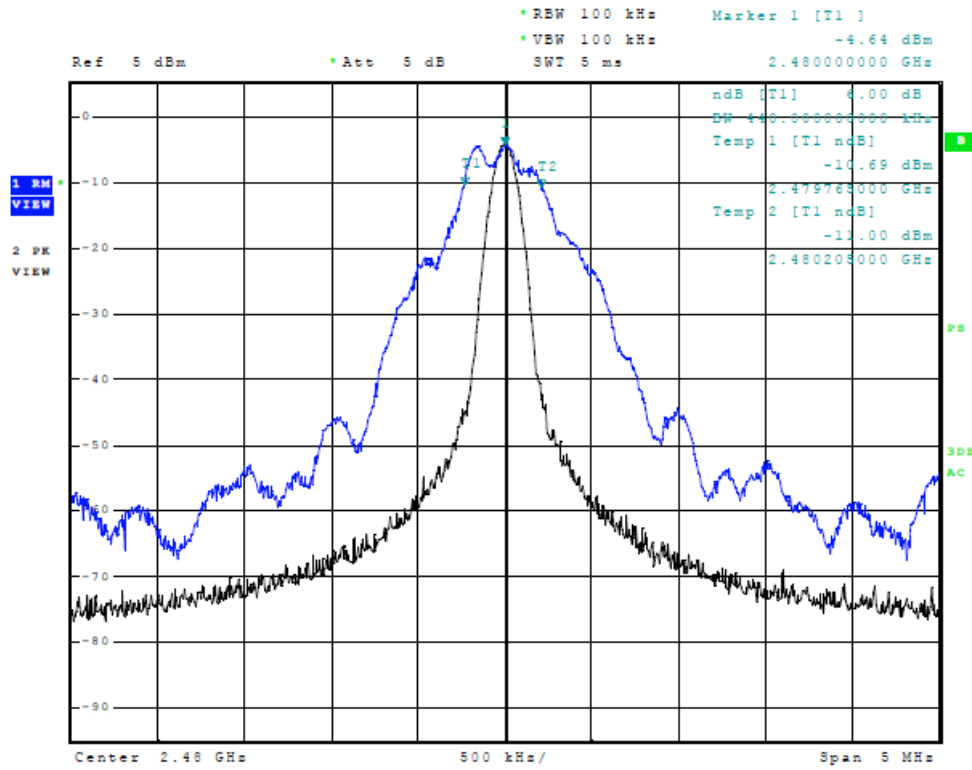

Figure Thirteen Occupied Bandwidth (high channel)

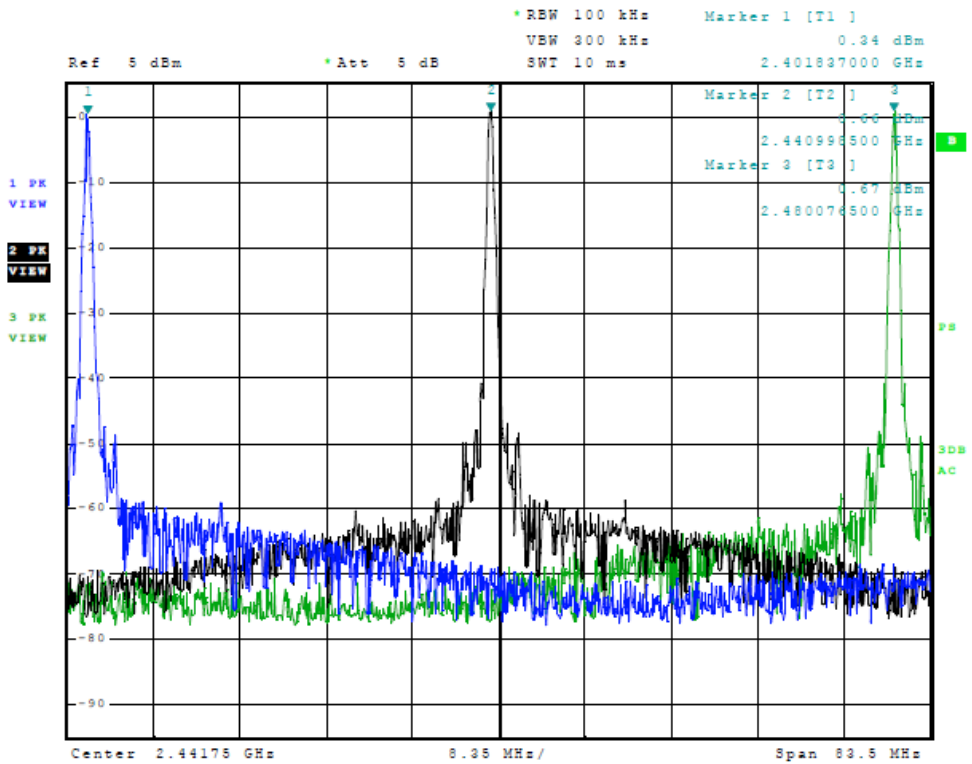

Figure Fourteen Operation across frequency band

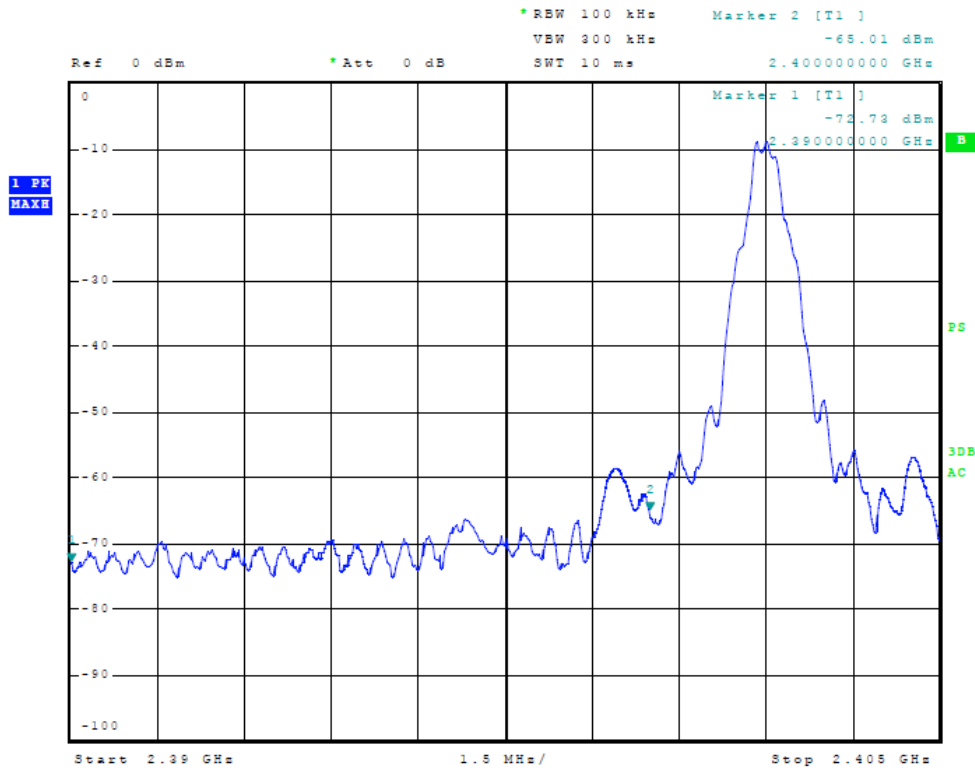

Figure Fifteen Low Frequency Band Edge



Figure Sixteen High Frequency Band Edge

Transmitter Radiated Emissions Data

Transmitter Antenna Port Conducted Emissions Data

Frequency MHz	Antenna Conducted Output Power dBm	Occupied Bandwidth kHz
2402.0	0.34	455.0
2441.0	0.66	445.0
2480.0	0.67	440.0

Transmitter Radiated Emissions

Frequency in MHz	Horizontal Peak (dBμV/m)	Horizontal Quasi-Peak (dBμV/m)	Horizontal Average (dBμV/m)	Vertical Peak (dBμV/m)	Vertical Quasi-Peak (dBμV/m)	Vertical Average (dBμV/m)	Limit @ 3m (dBμV/m)
2402.0	87.2	N/A	69.5	89.1	N/A	70.2	94.0
4804.0	49.2	N/A	36.3	49.1	N/A	36.2	54.0
7206.0	47.4	N/A	34.6	46.9	N/A	34.4	54.0
9608.0	48.1	N/A	36.0	48.7	N/A	36.2	54.0
12010.0	47.5	N/A	35.2	47.9	N/A	35.3	54.0
14412.0	53.1	N/A	40.8	53.2	N/A	40.7	54.0
2441.0	86.1	N/A	67.8	88.0	N/A	69.7	94.0
4882.0	49.7	N/A	35.8	48.0	N/A	35.6	54.0
7323.0	44.9	N/A	32.1	45.2	N/A	32.3	54.0
9764.0	48.2	N/A	36.0	49.4	N/A	35.9	54.0
12205.0	47.1	N/A	33.7	45.8	N/A	33.4	54.0
14646.0	56.2	N/A	43.9	56.2	N/A	43.5	54.0
2480.0	82.6	N/A	65.1	81.9	N/A	64.2	94.0
4960.0	48.0	N/A	35.3	48.6	N/A	35.6	54.0
7440.0	44.4	N/A	32.0	44.9	N/A	32.0	54.0
9920.0	48.4	N/A	36.1	48.8	N/A	36.1	54.0
12400.0	47.2	N/A	34.7	46.8	N/A	34.3	54.0
14880.0	53.3	N/A	41.0	53.4	N/A	40.8	54.0

Other emissions present had amplitudes at least 20 dB below the limit.

Peak and Quasi-Peak amplitude emissions are recorded above for frequency range of 26-1000 MHz. Peak and Average amplitude emissions are recorded above for frequency range above 1000 MHz.



Summary of Results for Transmitter Radiated Emissions

The EUT demonstrated compliance with the radiated emissions requirements of FCC CFR 47 Part 15.249, RSS-210 and other applicable standards for Intentional Radiators. The EUT worst-case configuration demonstrated minimum margin of -9.3 dB below the limit for general emissions. The EUT worst-case configuration demonstrated minimum radiated harmonic emission margin of -10.1 dB below the limits. No other radiated emissions were found in the restricted bands less than 20 dB below limits than those recorded in this report. Other emissions were present with amplitudes at least 20 dB below the limits.



NVLAP Lab Code 200087-0

Annex

- Annex A Measurement Uncertainty Calculations
- Annex B Rogers Labs Test Equipment List
- Annex C Rogers Qualifications
- Annex D FCC Test Site Registration Letter
- Annex E Industry Canada Test Site Registration Letter

Annex A Measurement Uncertainty Calculations

Radiated Emissions Measurement Uncertainty Calculation

Measurement of vertically polarized radiated field strength over the frequency range 30 MHz to 1 GHz on an open area test site at 3m and 10m includes following uncertainty:

Contribution	Probability Distribution	Uncertainty (dB)
Antenna factor calibration	normal (k = 2)	±0.58
Cable loss calibration	normal (k = 2)	±0.2
Receiver specification	rectangular	±1.0
Antenna directivity	rectangular	±0.1
Antenna factor variation with height	rectangular	±2.0
Antenna factor frequency interpolation	rectangular	±0.1
Measurement distance variation	rectangular	±0.2
Site Imperfections	rectangular	±1.5

Combined standard uncertainty $u_c(y)$ is

$$U_c(y) = \pm \sqrt{\left[\frac{1.0}{2}\right]^2 + \left[\frac{0.2}{2}\right]^2 + \left[\frac{1.0^2 + 0.1^2 + 2.0^2 + 0.1^2 + 0.2^2 + 1.5^2}{3}\right]}$$

$$U_c(y) = \pm 1.6 \text{ dB}$$

It is probable that $u_c(y) / s(q_k) > 3$, where $s(q_k)$ is estimated standard deviation from a sample of n readings unless the repeatability of the EUT is particularly poor, and a coverage factor of $k = 2$ will ensure that the level of confidence will be approximately 95%, therefore:

$$s(q_k) = \sqrt{\frac{1}{(n-1)} \sum_{k=1}^n (q_k - \bar{q})^2}$$

$$U = 2 U_c(y) = 2 \times \pm 1.6 \text{ dB} = \pm 3.2 \text{ dB}$$

Notes:

- 1.1 Uncertainties for the antenna and cable were estimated, based on a normal probability distribution with $k = 2$.
- 1.2 The receiver uncertainty was obtained from the manufacturer's specification for which a rectangular distribution was assumed.

- 1.3 The antenna factor uncertainty does not take account of antenna directivity.
- 1.4 The antenna factor varies with height and since the height was not always the same in use as when the antenna was calibrated an additional uncertainty is added.
- 1.5 The uncertainty in the measurement distance is relatively small but has some effect on the received signal strength. The increase in measurement distance as the antenna height is increased is an inevitable consequence of the test method and is therefore not considered a contribution to uncertainty.
- 1.6 Site imperfections are difficult to quantify but may include the following contributions:
 - Unwanted reflections from adjacent objects.
 - Ground plane imperfections: reflection coefficient, flatness, and edge effects.
 - Losses or reflections from "transparent" cabins for the EUT or site coverings.
 - Earth currents in antenna cable (mainly effect Biconical antennas).

The specified limits for the difference between measured site attenuation and the theoretical value (± 4 dB) were not included in total since the measurement of site attenuation includes uncertainty contributions already allowed for in this budget, such as antenna factor.

Conducted Measurements Uncertainty Calculation

Measurement of conducted emissions over the frequency range 9 kHz to 30 MHz includes following uncertainty:

Contribution	Probability Distribution	Uncertainty (dB)
Receiver specification	rectangular	± 1.5
LISN coupling specification	rectangular	± 1.5
Cable and input attenuator calibration	normal (k=2)	± 0.5

Combined standard uncertainty $u_c(y)$ is

$$U_c(y) = \pm \sqrt{\left[\frac{0.5}{2}\right]^2 + \frac{1.5^2 + 1.5^2}{3}}$$

$$U_c(y) = \pm 1.2 \text{ dB}$$

As with radiated field strength uncertainty, it is probable that $u_c(y) / s(q_k) > 3$ and a coverage factor of $k = 2$ will suffice, therefore:

$$U = 2 U_c(y) = 2 \times \pm 1.2 \text{ dB} = \pm 2.4 \text{ dB}$$



Annex B Rogers Labs Test Equipment List

List of Test Equipment	Calibration Date
Spectrum Analyzer: Rohde & Schwarz ESU40	5/11
Spectrum Analyzer: HP 8562A, HP Adapters: 11518, 11519, and 11520	5/11
Mixers: 11517A, 11970A, 11970K, 11970U, 11970V, 11970W	
Spectrum Analyzer: HP 8591EM	5/11
Antenna: EMCO Biconilog Model: 3143	5/11
Antenna: Sunol Biconilog Model: JB6	10/11
Antenna: EMCO Log Periodic Model: 3147	10/11
Antenna: Com Power Model: AH-118	10/11
Antenna: Antenna Research Biconical Model: BCD 235	10/11
LISN: Compliance Design Model: FCC-LISN-2.Mod.cd, 50 µHy/50 ohm/0.1 µf	10/11
R.F. Preamp CPPA-102	10/11
Attenuator: HP Model: HP11509A	10/11
Attenuator: Mini Circuits Model: CAT-3	10/11
Attenuator: Mini Circuits Model: CAT-3	10/11
Cable: Belden RG-58 (L1)	10/11
Cable: Belden RG-58 (L2)	10/11
Cable: Belden 8268 (L3)	10/11
Cable: Time Microwave: 4M-750HF290-750	10/11
Cable: Time Microwave: 10M-750HF290-750	10/11
Frequency Counter: Leader LDC825	2/12
Oscilloscope Scope: Tektronix 2230	2/12
Wattmeter: Bird 43 with Load Bird 8085	2/12
Power Supplies: Sorensen SRL 20-25, SRL 40-25, DCR 150, DCR 140	2/12
R.F. Generators: HP 606A, HP 8614A, HP 8640B	2/12
R.F. Power Amp 65W Model: 470-A-1010	2/12
R.F. Power Amp 50W M185- 10-501	2/12
R.F. Power Amp A.R. Model: 10W 1010M7	2/12
R.F. Power Amp EIN Model: A301	2/12
LISN: Compliance Eng. Model 240/20	2/12
LISN: Fischer Custom Communications Model: FCC-LISN-50-16-2-08	2/12
Antenna: EMCO Dipole Set 3121C	2/12
Antenna: C.D. B-101	2/12
Antenna: Solar 9229-1 & 9230-1	2/12
Antenna: EMCO 6509	2/12
Audio Oscillator: H.P. 201CD	2/12
ELGAR Model: 1751	2/12
ELGAR Model: TG 704A-3D	2/12
ESD Test Set 2010i	2/12
Fast Transient Burst Generator Model: EFT/B-101	2/12
Field Intensity Meter: EFM-018	2/12
KEYTEK Ecat Surge Generator	2/12
Shielded Room 5 M x 3 M x 3.0 M	



Annex C Rogers Qualifications

Scot D. Rogers, Engineer

Rogers Labs, Inc.

Mr. Rogers has approximately 17-years' experience in the field of electronics. Six years working in the automated controls industry and 6 years working with the design, development and testing of radio communications and electronic equipment.

Positions Held

Systems Engineer: A/C Controls Mfg. Co., Inc. 6 Years

Electrical Engineer: Rogers Consulting Labs, Inc. 5 Years

Electrical Engineer: Rogers Labs, Inc. Current

Educational Background

Bachelor of Science Degree in Electrical Engineering from Kansas State University

Bachelor of Science Degree in Business Administration Kansas State University

Several Specialized Training courses and seminars pertaining to Microprocessors and Software programming



NVLAP Lab Code 200087-0

Annex D FCC Test Site Registration Letter

FEDERAL COMMUNICATIONS COMMISSION

**Laboratory Division
7435 Oakland Mills Road
Columbia, MD 21046**

November 01, 2011

Registration Number: 90910

Rogers Labs, Inc.
4405 West 259th Terrace,
Louisburg, KS 66053

Attention: Scot Rogers,

Re: Measurement facility located at Louisburg
3 & 10 meter site
Date of Renewal: November 01, 2011

Dear Sir or Madam:

Your request for renewal of the registration of the subject measurement facility has been received. The information submitted has been placed in your file and the registration has been renewed. The name of your organization will remain on the list of facilities whose measurement data will be accepted in conjunction with applications for Certification under Parts 15 or 18 of the Commission's Rules. Please note that the file must be updated for any changes made to the facility and the registration must be renewed at least every three years.

Measurement facilities that have indicated that they are available to the public to perform measurement services on a fee basis may be found on the FCC website www.fcc.gov under E-Filing, OET Equipment Authorization Electronic Filing, Test Firms.

Sincerely,

Phyllis Parrish
Industry Analyst

Rogers Labs, Inc.
4405 West 259th Terrace
Louisburg, KS 66053
Phone/Fax: (913) 837-3214
Revision 1

Garmin International, Inc.
Model: GLO
Test #: 120508 SN: 3845646906b
Test to: FCC CFR 47 15.249, RSS 210
File: GLO TstRpt 120508

FCC ID: IPH-01156
IC: 1792A-01156
GPN: 011-02921-xx
Date: June 4, 2012
Page 33 of 34



NVLAP Lab Code 200087-0

Annex E Industry Canada Test Site Registration Letter

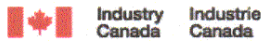

December 28, 2011

OUR FILE: 46405-3041
Submission No: 152685

Rogers Labs Inc.
4405 West 259th Terrace
Louisburg, KS, 66053
USA

Attention: Mr. Scot D. Rogers

Dear Sir/Madame:

The Bureau has received your application for the renewal of 3/10m OATS. Be advised that the information received was satisfactory to Industry Canada. The following number(s) is now associated to the site(s) for which registration / renewal was sought (**Site# 3041A-1**). Please reference the appropriate site number in the body of test reports containing measurements performed on the site. In addition, please keep for your records the following information;

- The company address code associated to the site(s) located at the above address is: **3041A**

Furthermore, to obtain or renew a unique site number, the applicant shall demonstrate that the site has been accredited to ANSI C63.4-2003 or later. A scope of accreditation indicating the accreditation by a recognized accreditation body to ANSI C63.4-2003 or later shall be accepted. Please indicate in a letter the previous assigned site number if applicable and the type of site (example: 3 metre OATS or 3 metre chamber). If the test facility is not accredited to ANSI C63.4-2003 or later, the test facility shall submit test data demonstrating full compliance with the ANSI standard. The Bureau will evaluate the filing to determine if recognition shall be granted.

The frequency for re-validation of the test site and the information that is required to be filed or retained by the testing party shall comply with the requirements established by the accrediting organization. However, in all cases, test site re-validation shall occur on an interval not to **exceed three years**. There is no fee or form associated with an OATS filing. OATS submissions are encouraged to be submitted electronically to the Bureau using the following URL;

http://strategis.ic.gc.ca/epic/internet/inceb-bhst.nsf/en/h_tt00052e.html.

If you have any questions, you may contact the Bureau by e-mail at certification.bureau@ic.gc.ca Please reference our file and submission number above for all correspondence.

Yours sincerely,

Dalwinder Gill
For: Wireless Laboratory Manager
Certification and Engineering Bureau
3701 Carling Ave., Building 94
P.O. Box 11490, Station "H"
Ottawa, Ontario K2H 8S2
Email: dalwinder.gill@ic.gc.ca
Tel. No. (613) 998-8363
Fax. No. (613) 990-4752

Rogers Labs, Inc.
4405 West 259th Terrace
Louisburg, KS 66053
Phone/Fax: (913) 837-3214
Revision 1

Garmin International, Inc.
Model: GLO
Test #: 120508 SN: 3845646906b
Test to: FCC CFR 47 15.249, RSS 210
File: GLO TstRpt 120508

FCC ID: IPH-01156
IC: 1792A-01156
GPN: 011-02921-xx
Date: June 4, 2012
Page 34 of 34