

Circuit Diagram

| CON No. | Name | Description | Date | Sign. |
|---------|------|-------------|------|-------|
| | | | | |
| | | | | |
| | | | | |
| | | | | |

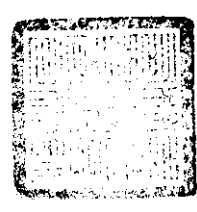
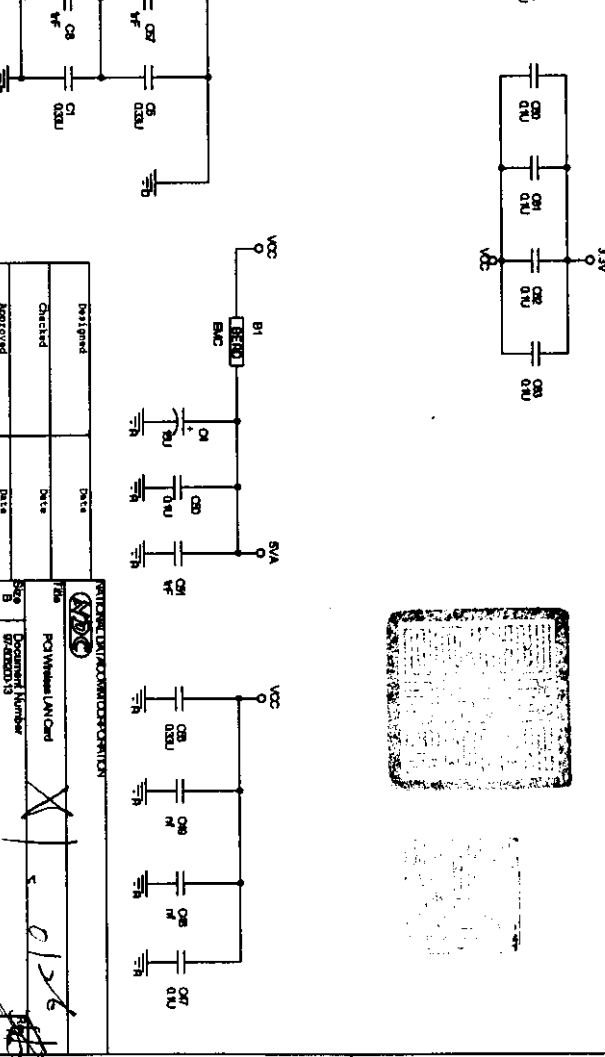
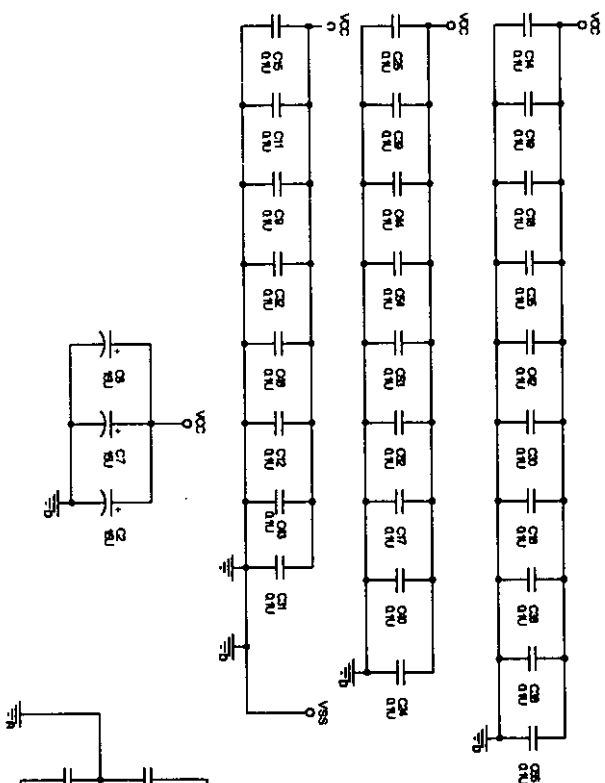
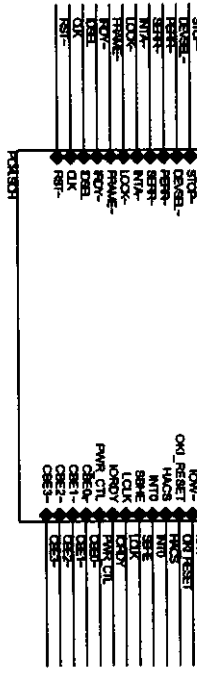
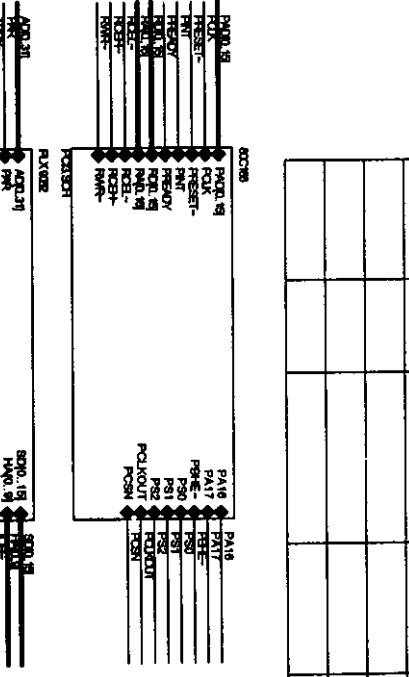
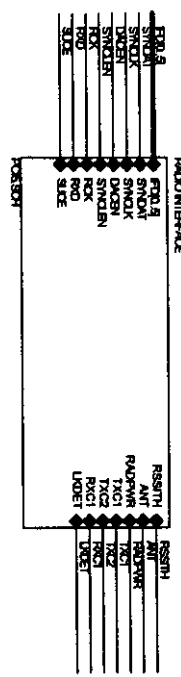
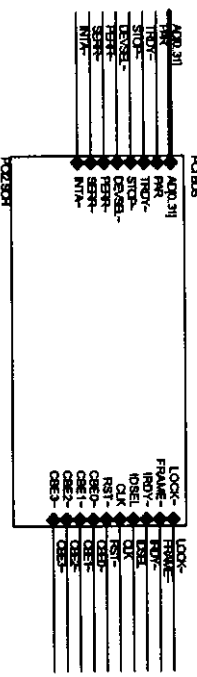
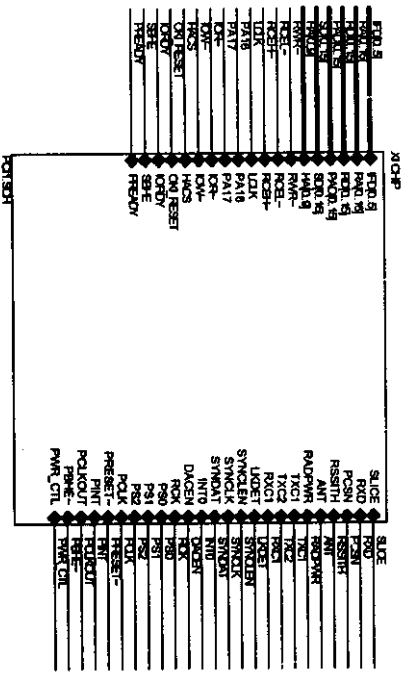

ARTIFICIAL INTELLIGENCE/COMPARISON/CONTROL

PO Worksheet/DocId

Document Number

Approved

Date

Date

Date

0126

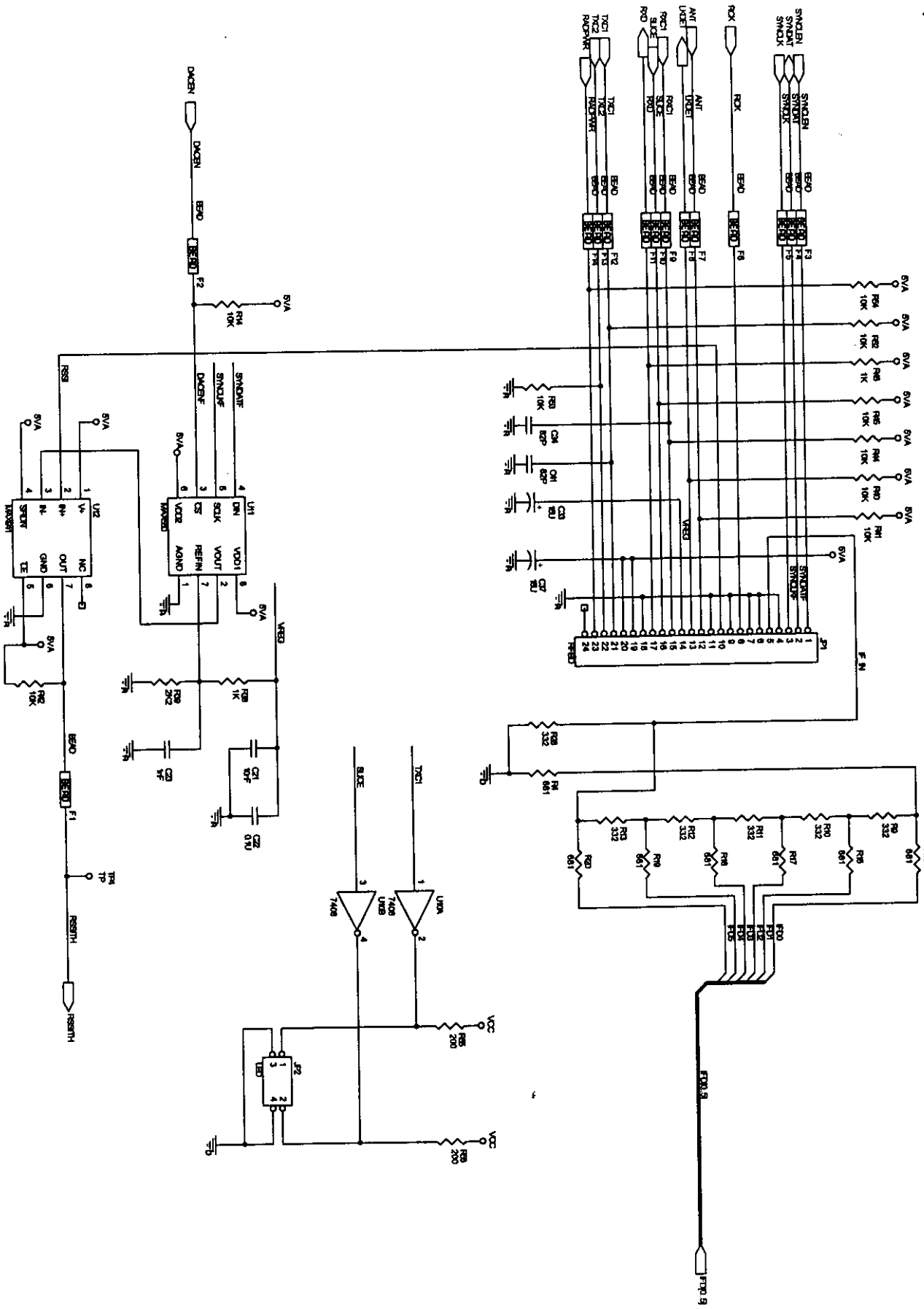

RAYTHEON CORPORATION
 THE
 Radio Receiver
 Document Number
 72-200-13
 11/28/67, REVISED 1/68
 Sheet 2 of 8
 Part A1

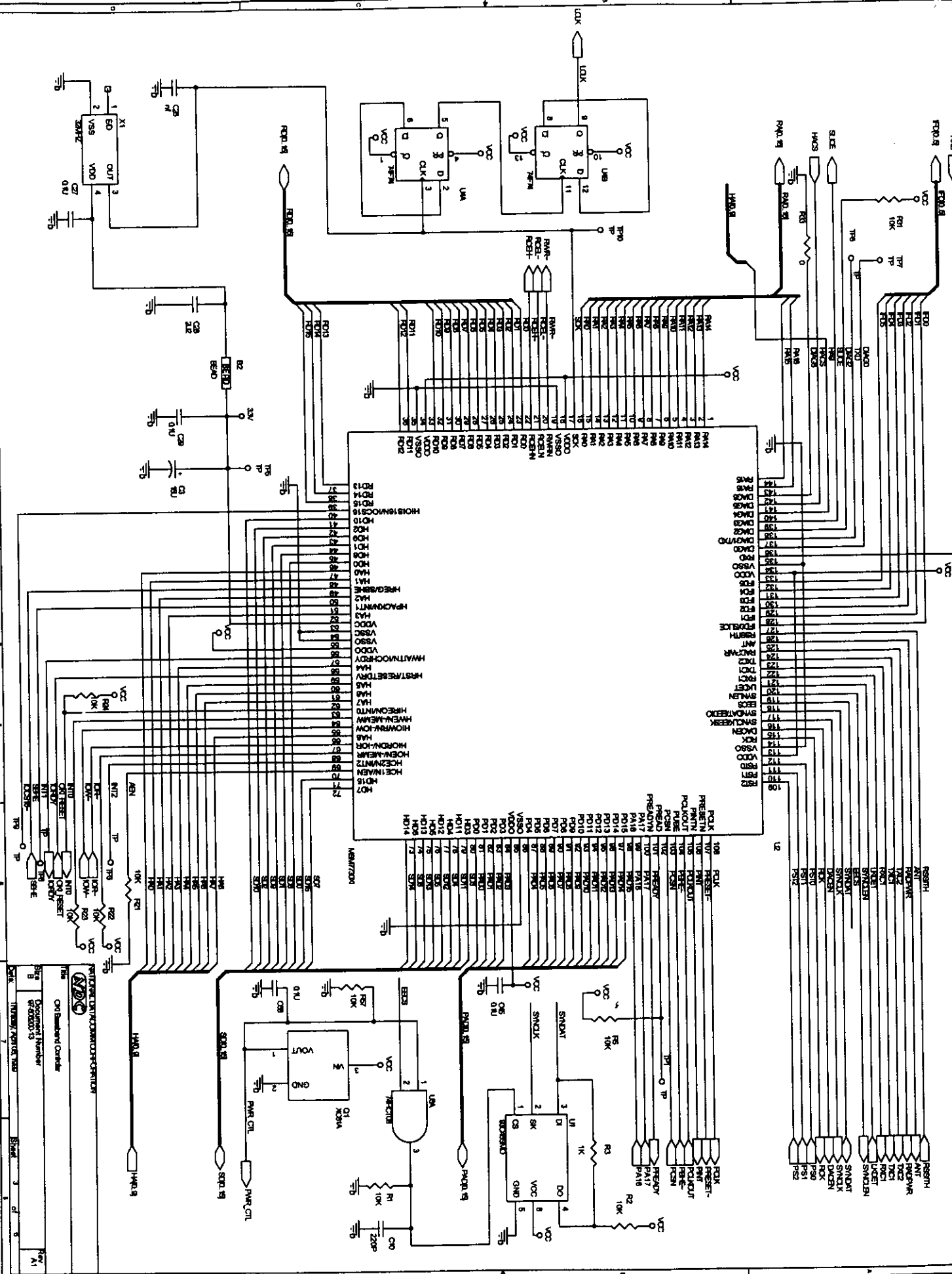

PART NUMBER AND COMPANY IDENTIFIER

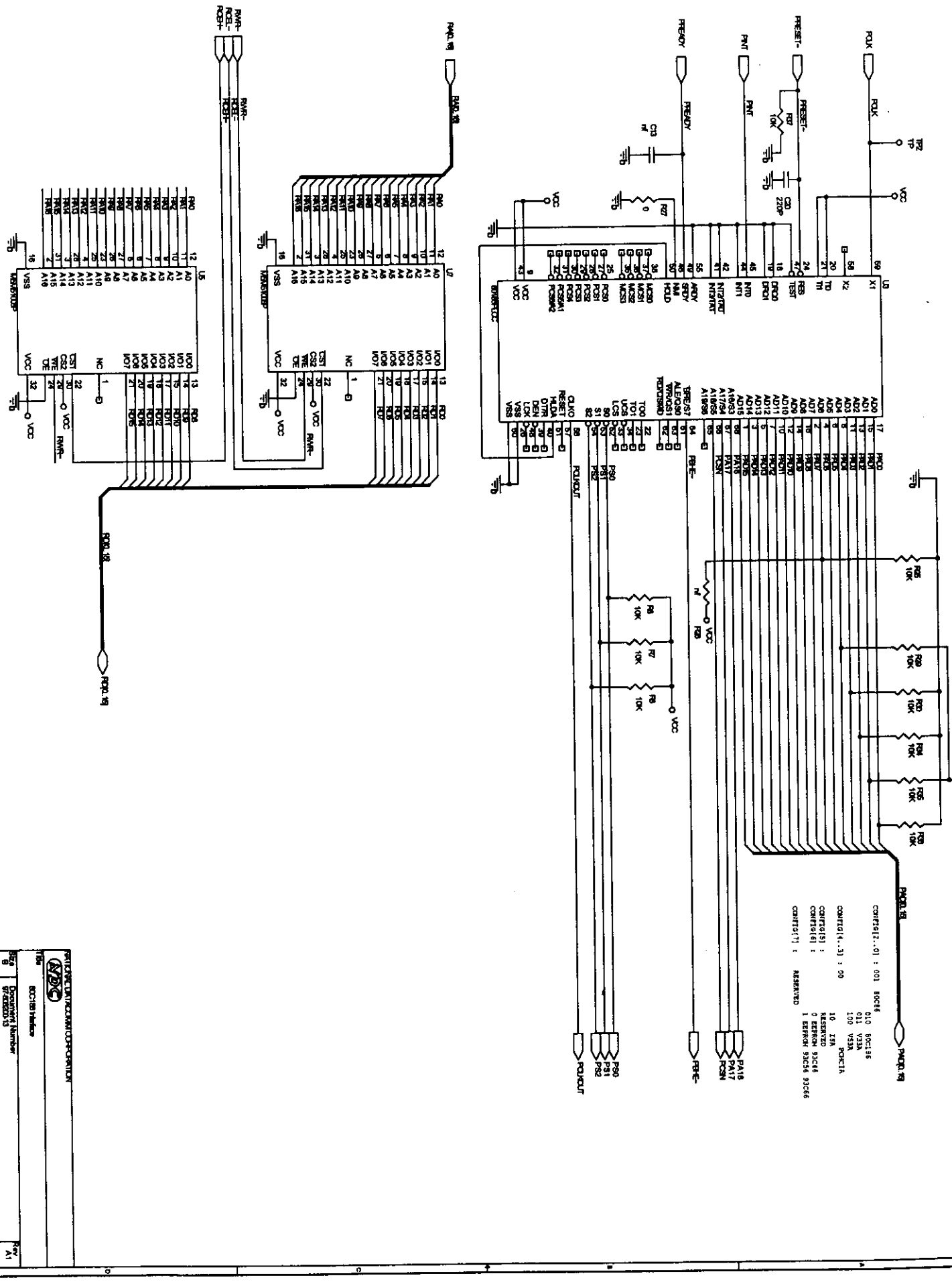
 On Board Control
 Document Number
 674200013
 17/0000/4/21/2008
 3 of 8
 Rev. A1



CONTROL[2..0] : 001 80C16
 CONTROL[4..3] : 00 101 V33A
 CONTROL[5] : 10 101 V33A
 CONTROL[6] : 00 101 V33A
 CONTROL[7] : 00 101 V33A
 CONTROL[8] : 00 101 V33A
 CONTROL[9] : 00 101 V33A
 CONTROL[10] : 00 101 V33A
 CONTROL[11] : 00 101 V33A
 CONTROL[12] : 00 101 V33A
 CONTROL[13] : 00 101 V33A
 CONTROL[14] : 00 101 V33A
 CONTROL[15] : 00 101 V33A



TEXAS INSTRUMENTS
 80C163 Index
 Document Number
 77400013
 1987

Rev A1
 4 of 9

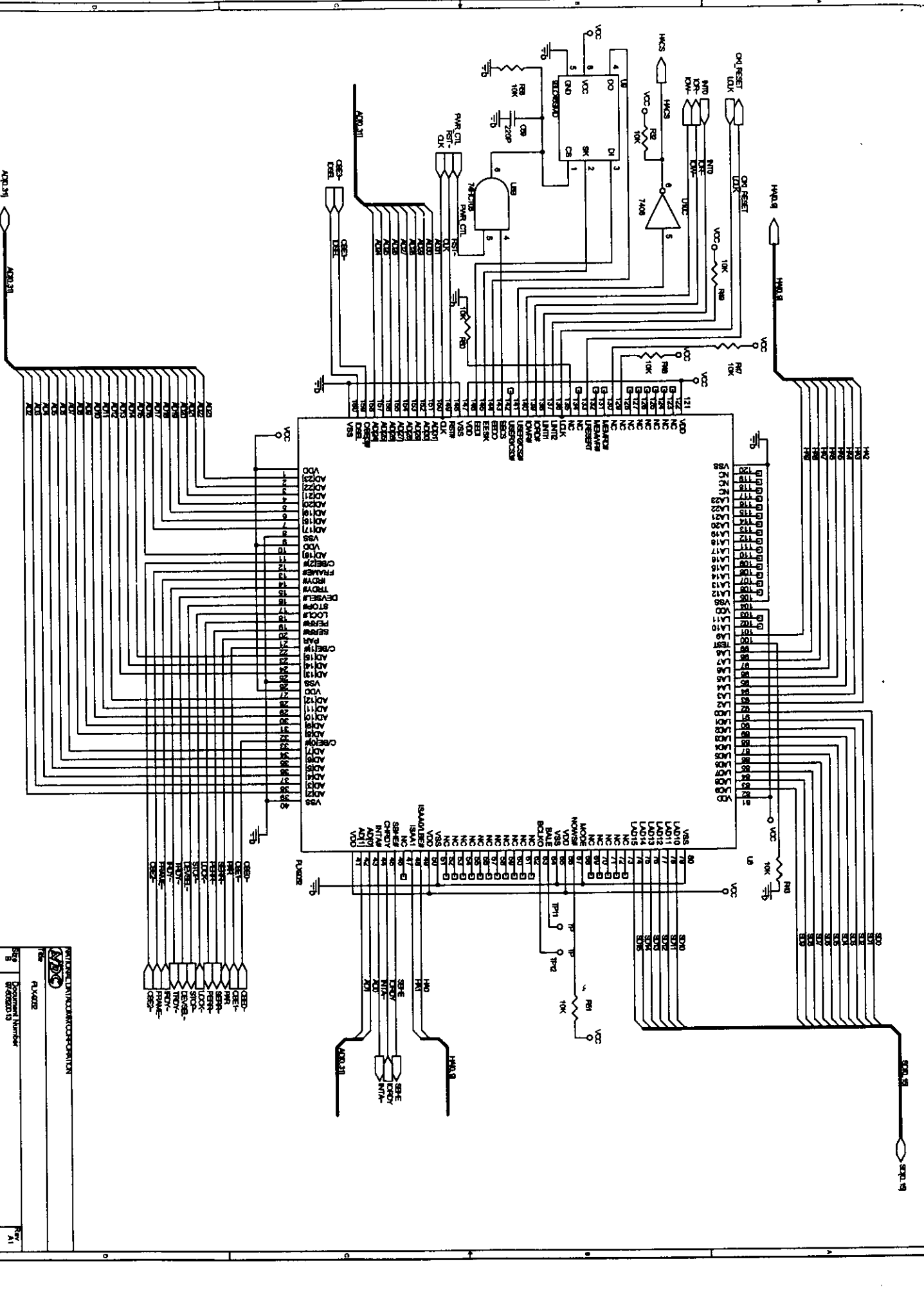

WITTENBERG ELECTRONIC CORPORATION
 File: FV4022

Doc: 8
 Document Number: 8-00000010
 Title: INTERNAL TEST BOARD
 Rev: 1

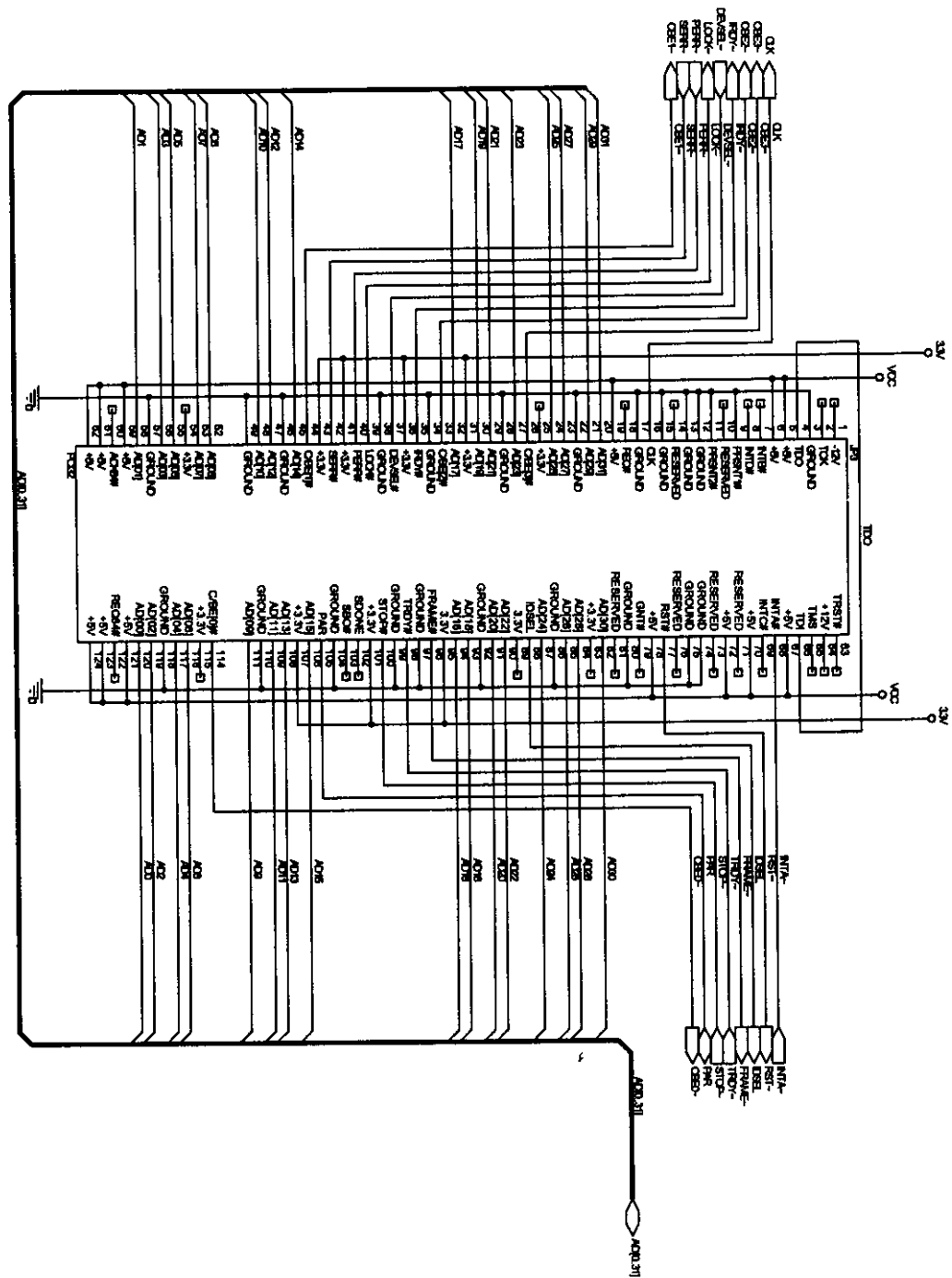

NATIONAL INSTRUMENT CORPORATION
 THE PDS-8 Interface
 Document Number 77-6500-3
 DATE: 11/28/81
 SIZE: B
 SHEET: 8 OF 8
 REV: A1

| ECN NO. | REV | DESCRIPTION | DATE | SICR |
|---------|-----|--------------|----------|------|
| | A1 | SEE ECN 0664 | 12-13-97 | |
| | | | | |
| | | | | |

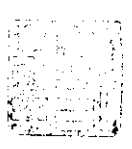
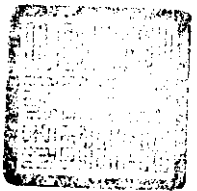
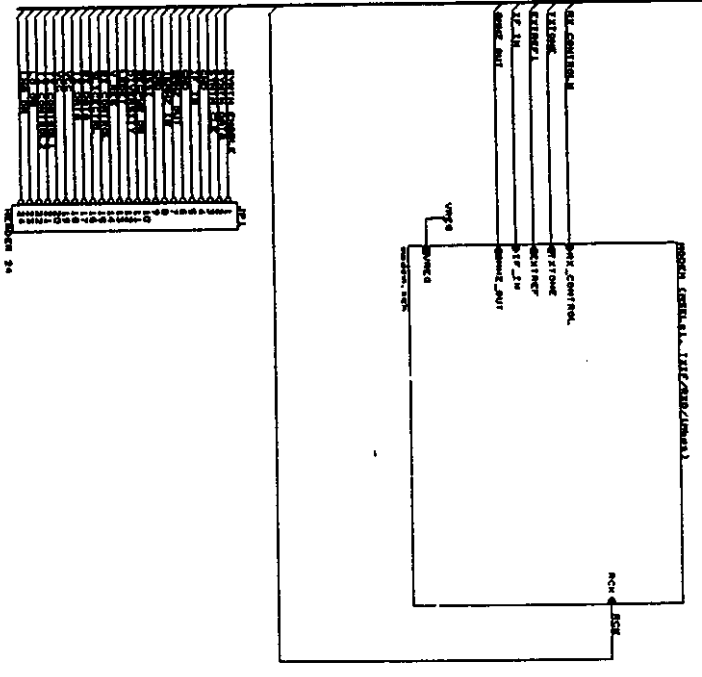
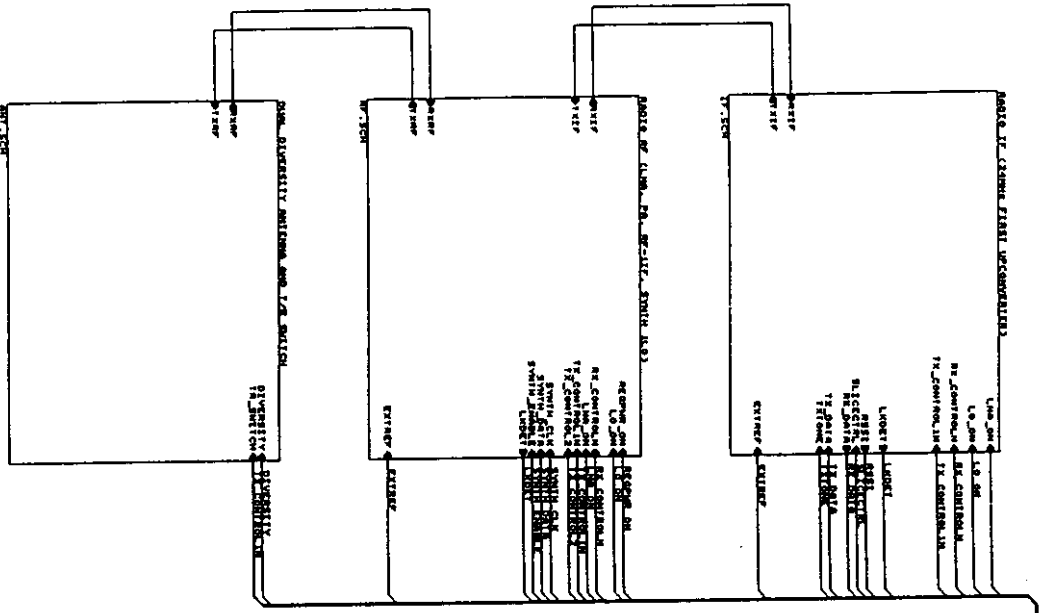

| DATE | BY | NO. NATIONAL DATA/COMM CORPORATION |
|----------|-----|------------------------------------|
| 12/13/97 | ... | ... |
| ... | ... | ... |
| ... | ... | ... |

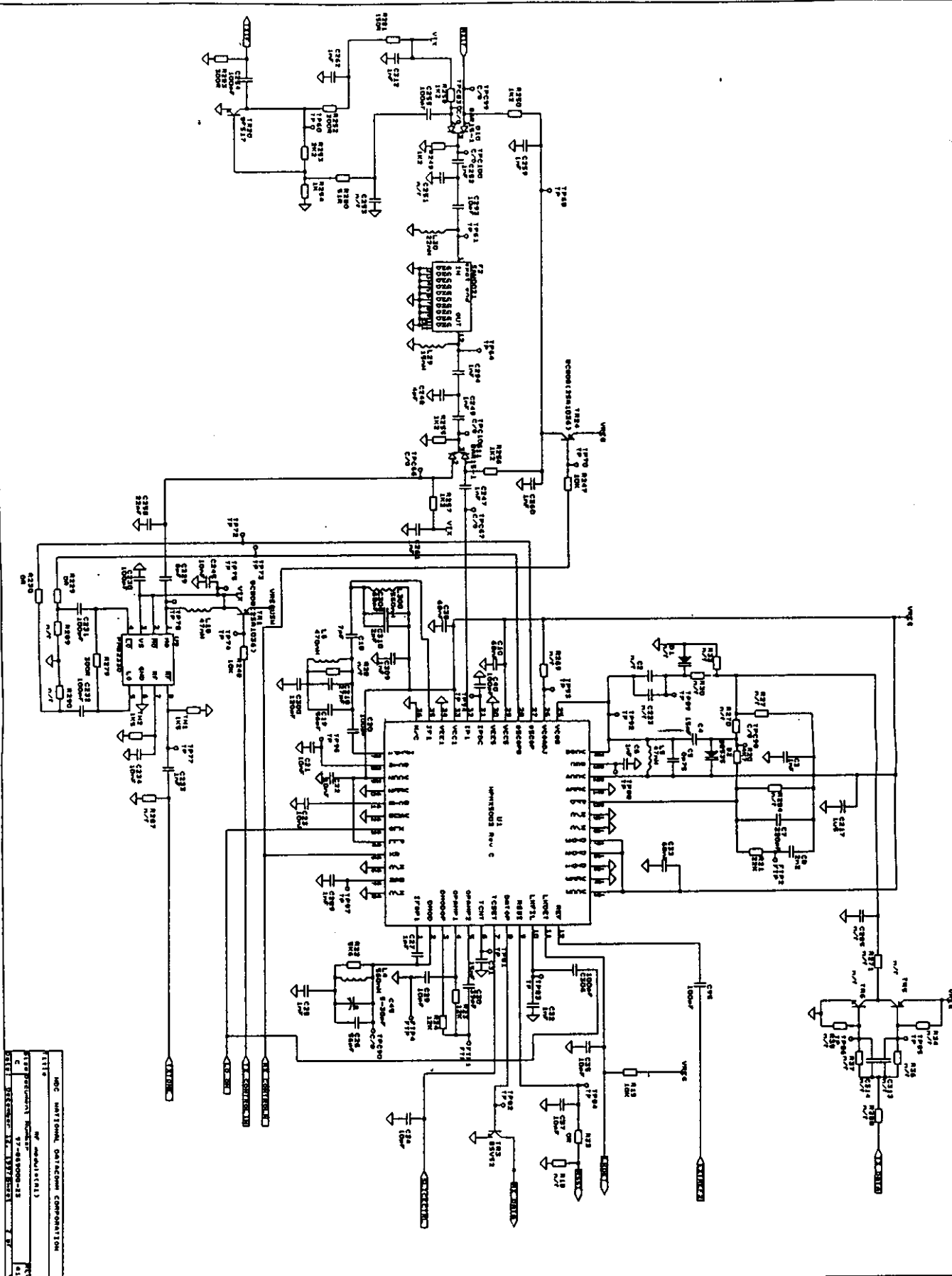

1119
 REC. NATIONAL DEFENSES CORPORATION
 1175 PINE BLVD. NEW YORK 17, N.Y.
 C. 1175 PINE BLVD. NEW YORK 17, N.Y.
 1119

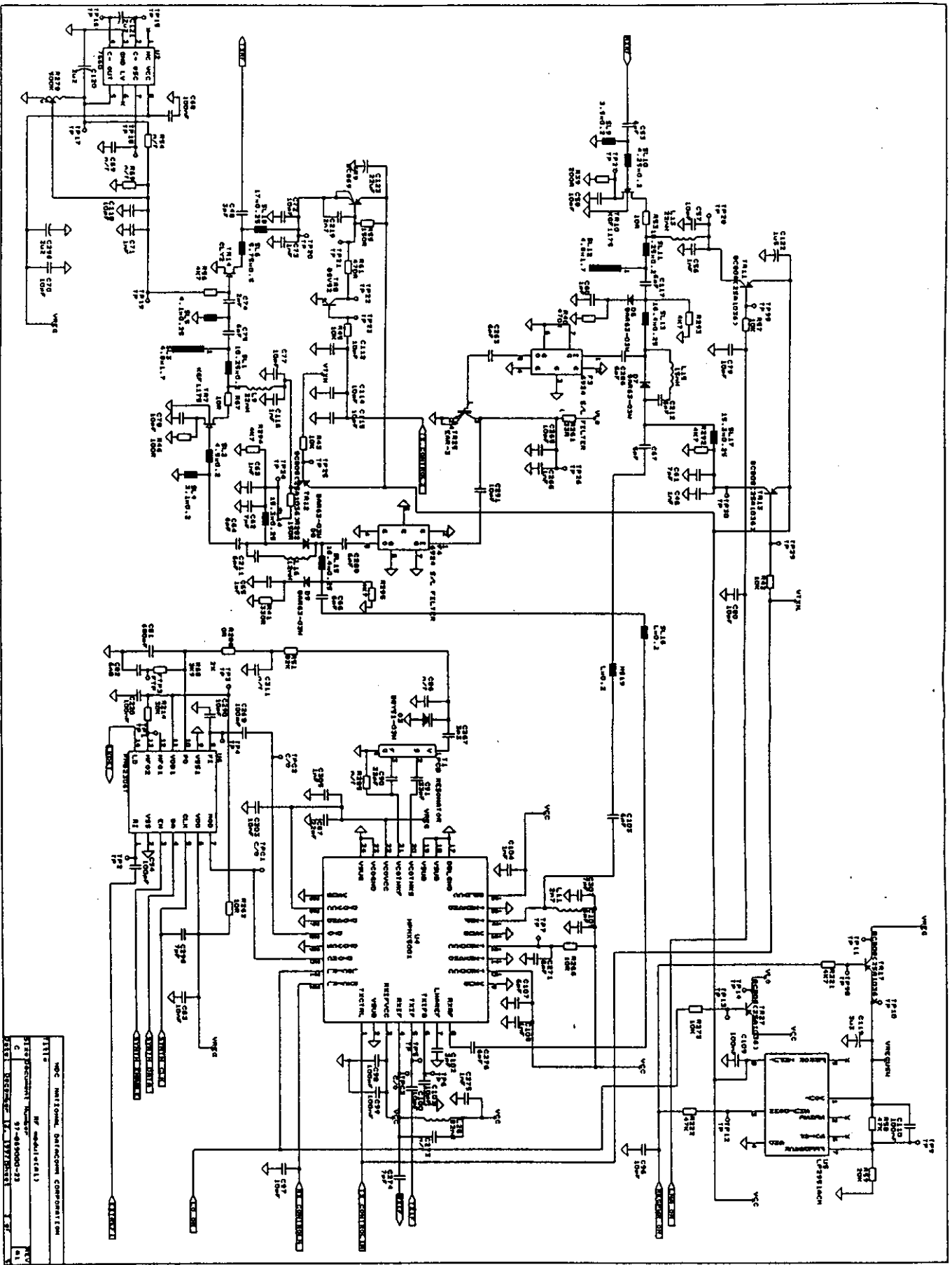

WGC NATIONAL DATACOM COMPUTER
 TITLE: WGC NATIONAL DATACOM COMPUTER
 DRAWING NUMBER: WGC-44000-23
 DATE: 12-11-64
 BY: J. S. WILSON

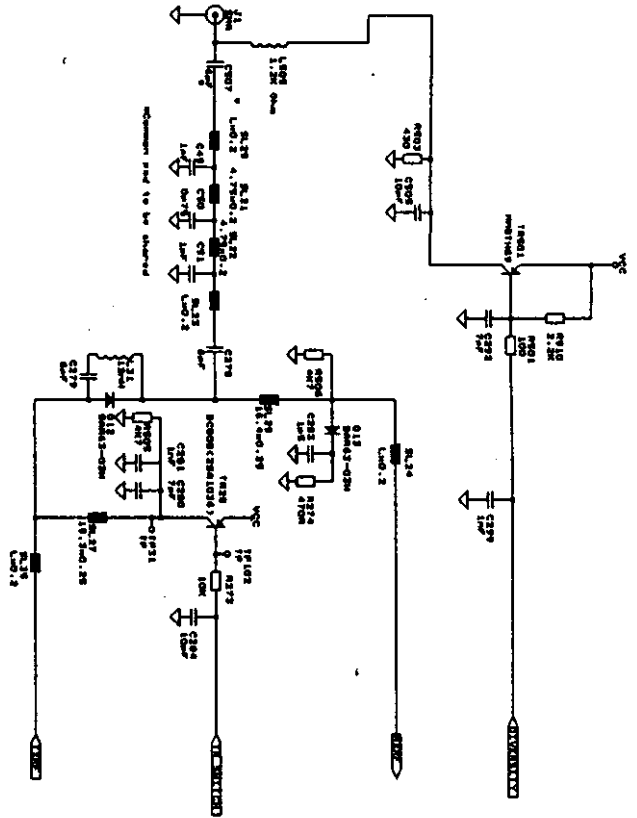

HQC NATIONAL ORFKOCOM CORPORATION
 4115
 47-48-1000-28
 47-48-1000-28
 47-48-1000-28
 47-48-1000-28
 47-48-1000-28

- REVISIONS BY COMMENTS
- 1. 11/18/54
- 2. 11/18/54
- 3. 11/18/54
- 4. 11/18/54
- 5. 11/18/54
- 6. 11/18/54
- 7. 11/18/54
- 8. 11/18/54
- 9. 11/18/54
- 10. 11/18/54

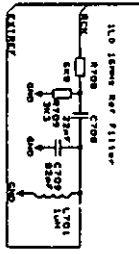
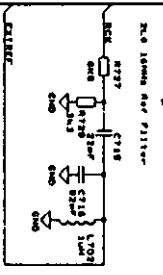
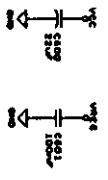
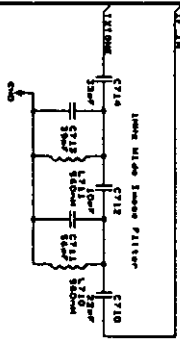

| | |
|---------------------------------------|------------|
| WDC NATIONAL DISTRIBUTION CORPORATION | |
| DATE | 11/18/54 |
| REV | 1 |
| BY | WDC |
| CHKD | WDC |
| APP'D | WDC |
| TITLE | RF FILTERS |
| WDC NATIONAL DISTRIBUTION CORPORATION | |
| 1735 Wisconsin Avenue, N.W. | |
| Washington, D.C. 20007-4292 | |