

# TEST REPORT

of

## SAR

New Application;  Class I PC;  Class II PC

**Product:** Wireless Lan USB Adapter  
**Brand:** JVC KENWOOD  
**Mode:** W02-5613  
**Model Difference:** N/A  
**FCC ID:** IOMW025613  
**IC:** 282C-W025613  
**Standard:** FCC 47 CFR Part2(2.1093)  
RSS102 Issue 4:2010  
IEEE C95.1-1999; IEEE 1528  
FCC OET 65 Supplement C(Edition 01-10)  
**Applicant:** JVC KENWOOD Corporation  
**Address:** 2967-3, Ishikawa-machi Hachioji-shi, Tokyo,  
192-8525 Japan

**Test Performed by:**  
**International Standards Laboratory**

<Lung-Tan LAB>

\*Site Registration No.: TAF: 0997

\*Address:

No. 120, Lane 180, San Ho Tsuen, Hsin Ho Rd.

Lung-Tan Hsiang, Tao Yuan County 325, Taiwan

\*Tel : 886-3-407-1718; Fax: 886-3-407-1738

**Report No.: ISL-12LR171FSAR**

**Issue Date : 2012/11/06**



Test results given in this report apply only to the specific sample(s) tested and are traceable to national or international standard through calibration of the equipment and evaluating measurement uncertainty herein.

This report MUST not be used to claim product endorsement by TAF or any agency of the Government.

This test report shall not be reproduced except in full, without the written approval of International Standards Laboratory.

## VERIFICATION OF COMPLIANCE

**Applicant:** JVC KENWOOD Corporation  
**Product:** Wireless Lan USB Adapter  
**Brand Name:** JVC KENWOOD  
**Model No.:** W02-5613  
**Model Difference:** N/A  
**FCC ID:** IOMW025613  
**IC:** 282C-W025613  
**Date of Receipt:** Oct. 23, 2012  
**Date of Test:** Oct. 30, 2012 – Oct. 30, 2012  
**Standard:** FCC 47 CFR Part2(2.1093)  
RSS102 Issue 4:2010  
IEEE C95.1-1999; IEEE 1528  
FCC OET 65 Supplement C(Edition 01-10)

### We hereby certify that:

All the tests in this report have been performed and recorded in accordance with the standards described above and performed by an independent electromagnetic compatibility consultant, International Standards Laboratory.

The test results contained in this report accurately represent the measurements of the characteristics and the energy generated by sample equipment under test at the time of the test. The sample equipment tested as described in this report is in compliance with the limits of above standards.

**Test By:** Arno Hsieh **Date:** 2012/11/06

*Arno Hsieh / Supervisor*

**Prepared By:** Arno Hsieh **Date:** 2012/11/06

*Arno Hsieh / Supervisor*

**Approved By:** Vincent Su **Date:** 2012/11/06

*Vincent Su / Technical Manager*

### Version

Version No.	Date	Description
00	2012/11/06	Initial creation of document

## Table of Contents

<b>1</b>	<b>STATEMENT OF COMPLIANCE.....</b>	<b>5</b>
<b>2</b>	<b>GENERAL INFORMATION.....</b>	<b>6</b>
2.1	DESCRIPTION OF DEVICE UNDER TEST (DUT).....	6
2.2	DUT PHOTOS.....	7
2.3	APPLIED STANDARDS.....	7
2.4	DEVICE CATEGORY AND SAR LIMITS.....	7
2.5	TEST ENVIRONMENT.....	7
2.6	TEST CONFIGURATION.....	7
<b>3</b>	<b>SPECIFIC ABSORPTION RATE (SAR) .....</b>	<b>8</b>
3.1	INTRODUCTION.....	8
3.2	SAR DEFINITION.....	8
<b>4</b>	<b>SAR MEASUREMENT SYSTEM.....</b>	<b>9</b>
4.1	ALSAS-10U SYSTEM DESCRIPTION.....	9
4.2	E-FIELD PROBE ALS-E-020S.....	10
4.3	DAQ-PAQ (ANALOG TO DIGITAL ELECTRONICS) ALS-DAQ-PAQ-3 BOUNDARY DETECTION UNIT ALS-PMDPS-3.....	12
4.4	AXIS ARTICULATED ROBOT ALS-F3.....	14
4.5	ALSAS UNIVERSAL WORKSTATION ALS-UWS.....	14
4.6	SAM PHANTOMS ALS-P-SAM-L / ALS-P-SAM-R.....	15
4.7	UNIVERSAL DEVICE POSITIONER.....	17
4.8	TEST EQUIPMENT LIST.....	18
<b>5</b>	<b>TISSUE SIMULATING LIQUIDS.....</b>	<b>19</b>
<b>6</b>	<b>SAR MEASUREMENT EVALUATION.....</b>	<b>20</b>
<b>7</b>	<b>DUT TESTING POSITION.....</b>	<b>22</b>
<b>8</b>	<b>SAR TEST RESULTS.....</b>	<b>27</b>
8.1	CONDUCTED POWER TABLE:.....	27
8.2	TEST RECORDS FOR BODY SAR TEST.....	28
<b>9</b>	<b>EXPOSURE ASSESSMENT MEASUREMENT UNCERTAINTY.....</b>	<b>29</b>
<b>APPENDIX A</b>	<b>TEST SETUP PHOTOS.....</b>	<b>30</b>
<b>APPENDIX B</b>	<b>DUT PHOTOS.....</b>	<b>34</b>
	<i>EXTERNAL OF EUT – 1</i> .....	35
<b>APPENDIX C:</b>	<b>SYSTEM PERFORMANCE CHECK.....</b>	<b>40</b>
<b>APPENDIX D:</b>	<b>SAR MEASUREMENT DATA.....</b>	<b>40</b>
<b>APPENDIX E:</b>	<b>PROBE CALIBRATION CERTIFICATE.....</b>	<b>40</b>
<b>APPENDIX F:</b>	<b>DIPOLE CALIBRATION CERTIFICATE.....</b>	<b>40</b>

## 1 Statement of Compliance

The maximum results of Specific Absorption Rate (SAR) were found during testing for EUT, which are as follows (with expanded uncertainty 21.4 % for 300 MHz to 3 GHz).

Type	Position	SAR <sub>1g</sub> (W/kg)
802.11b	Body, 0.5cm distance	<b>1.363</b>
802.11n 20MHz	Body, 0.5cm distance	0.397
802.11n 40MHz	Body, 0.5cm distance	0.349

They are in compliance with Specific Absorption Rate (SAR) for general population /uncontrolled exposure limits (1.6 W/kg) specified in FCC 47 CFR part 2 (2.1093), RSS102 Issue4:2010 and ANSI/IEEE C95.1-1999, and had been tested in accordance with the measurement methods and procedures specified in IEEE 1528-2003 and FCC OET Bulletin 65 Supplement C (Edition 01-01).

## 2 General Information

### 2.1 Description of Device Under Test (DUT)

General:

Product Name	Wireless Lan USB Adapter	
Brand Name	JVC KENWOOD	
Model Name	W02-5613	
Model Difference	N/A	
Power Supply	5 Vdc from Host PC	
	Battery:	N/A
	Adapter:	N/A

WLAN:

Frequency Range:	802.11b/g/n HT20: 2412 – 2462MHz
Channel number:	802.11b/g/n HT20: 11 channels 802.11n HT40: 7 channels
Transmit Power:	802.11b: 20.56(PK); 16.47dBm(AV) 802.11g: 22.23(PK);13.22dBm(AV) 802.11n HT20: 20.67(PK);13.33dBm(AV) 802.11n HT40: 20.31(PK);13.38dBm(AV)
Modulation Technology	11b/g: DSSS, OFDM 11n: OFDM
Modulation type:	CCK, DQPSK, DBPSK for DSSS 64QAM, 16QAM, QPSK, BPSK for OFDM
Transition Rate:	802.11 b: 1/2/5.5/11 Mbps 802.11 g: 6/9/12/18/24/36/48/54 Mbps 802.11 n : 6.5 – 150Mbps
Antenna Designation:	PIFA Antenna, 0dBi

The EUT is compliance with IEEE 802.11 b/g/n Standard.

**Remark:** The above DUT's information was declared by manufacturer. Please refer to the specifications or user's manual for more detailed description.

## 2.2 DUT Photos

Please refer to Appendix B.

## 2.3 Applied Standards

The Specific Absorption Rate (SAR) testing specification, method and procedure for this Notebook Computer is in accordance with the following standards:

FCC 47 CFR Part 2 (2.1093)  
 RSS102 Issue4:2010  
 IEEE C95.1-1999  
 IEEE 1528-2003  
 FCC OET Bulletin 65 Supplement C (Edition 01-01)  
 FCC KDB 447498 D01 / D02  
 FCC KDB 248227

## 2.4 Device Category and SAR Limits

This device belongs to **portable** device category because its radiating structure is allowed to be used within 20 centimeters of the body of the user. Limit for **General Population/Uncontrolled** exposure should be applied for this device, it is **1.6 W/kg** as averaged over any 1 gram of tissue.

Limits for General Population/Uncontrolled Exposure (W/kg)

Type Exposure	Uncontrolled Environment Limit
Spatial Peak SAR (1g cube tissue for brain or body)	1.60 W/kg
Spatial Average SAR (whole body)	0.08 W/kg
Spatial Peak SAR (10g for hands, feet, ankles and wrist)	4.00 W/kg

## 2.5 Test Environment

Item	Required	Actual
Temperature (°C)	18-25°C	20 to 24 °C
Humidity (%RH)	30-70 %	< 60 %

## 2.6 Test Configuration

The device was controlled by using a test software to transmit TX power level at max continuously. Modulation type and Channel number are selected by software also.

### 3 Specific Absorption Rate (SAR)

#### 3.1 Introduction

SAR is related to the rate at which energy is absorbed per unit mass in an object exposed to a radio field. The SAR distribution in a biological body is complicated and is usually carried out by experimental techniques or numerical modeling. The standard recommends limits for two tiers of groups, occupational/controlled and general population/uncontrolled, based on a person's awareness and ability to exercise control over his or her exposure. In general, occupational/controlled exposure limits are higher than the limits for general population/uncontrolled.

#### 3.2 SAR Definition

The SAR definition is the time derivative (rate) of the incremental energy (dW) absorbed by (dissipated in) an incremental mass (dm) contained in a volume element (dv) of a given density ( $\rho$ ). The equation description is as below:

$$SAR = \frac{d}{dt} \left( \frac{dW}{dm} \right) = \frac{d}{dt} \left( \frac{dW}{\rho dV} \right)$$

SAR is expressed in units of Watts per kilogram (W/kg)

SAR measurement can be either related to the temperature elevation in tissue by

$$SAR = C \left( \frac{\delta T}{\delta t} \right)$$

Where: C is the specific heat capacity,  $\delta T$  is the temperature rise and  $\delta t$  is the exposure duration, or related to the electrical field in the tissue by

$$SAR = \frac{\sigma |E|^2}{\rho}$$

Where:  $\sigma$  is the conductivity of the tissue,  $\rho$  is the mass density of the tissue and E is the RMS electrical field strength.

However for evaluating SAR of low power transmitter, electrical field measurement is typically applied.



## 4 SAR Measurement System

### 4.1 ALSAS-10U System Description

APREL Laboratories ALSAS-10U is fully optimized for the dosimetric evaluation of a broad range of wireless transceivers and antennas. Developed in line with the latest methodologies it is fully compliant with the technical and scientific requirements of IEEE 1528, IEC 62209 Part 1 & 2 (draft), CENELEC, ARIB, ACA, and the Federal Communications Commission. The system comprises of a six axes articulated robot which utilizes a dedicated controller.

ALSAS-10U uses the latest methodologies and FDTD modeling to provide a platform which is repeatable with minimum uncertainty.

#### Applications

ALSAS-10U is designed to cover the frequency range from 30MHz to 6GHz as per the IEC 62209 Part II (draft) standard. There is no limiting factor to the operating RF carrier frequency range for the ALSAS-10U system other than the phantoms chosen for testing. The ALSAS-10U has been designed to be modular and phantoms are integrated onto the Universal Workstation™ so as to allow for complete flexibility of the measurement process. This unique design allows for a fully flexible system which can be built around the exact needs of the user.



#### Area Scans

Area scans are defined prior to the measurement process being executed with a user defined variable spacing between each measurement point (integral) allowing low uncertainty measurements to be conducted. Scans defined for FCC applications utilize a 10mm<sup>2</sup> step integral, with 1mm interpolation used to locate the peak SAR area used for zoom scan assessments.

Where the system identifies multiple SAR peaks (which are within 25% of peak value) the system will provide the user with the option of assessing each peak location individually for zoom scan averaging.

### Zoom Scan (Cube Scan Averaging)

The averaging zoom scan volume utilized in the ALSAS-10U software is in the shape of a cube and the side dimension of a 1 g or 10 g mass is dependent on the density of the liquid representing the simulated tissue. A density of 1000 kg/m<sup>3</sup> is used to represent the head and body tissue density and not the phantom liquid density, in order to be consistent with the definition of the liquid dielectric properties, i.e. the side length of the 1 g cube is 10mm, with the side length of the 10 g cube 21,5mm.

When the cube intersects with the surface of the phantom, it is oriented so that 3 vertices touch the surface of the shell or the center of a face is tangent to the surface. The face of the cube closest to the surface is modified in order to conform to the tangent surface.

The zoom scan integer steps can be user defined so as to reduce uncertainty, but normal practice for typical test applications (including FCC) utilize a physical step of 5x5x8 (8mmx8mmx5mm) providing a volume of 32mm in the X & Y axis, and 35mm in the Z axis.

### ALSAS-10U Interpolation and Extrapolation Uncertainty

The overall uncertainty for the methodology and algorithms the used during the SAR calculation was evaluated using the data from IEEE 1528 based on the example f3 algorithm:

$$f_3(x, y, z) = A \frac{a^2}{\frac{a^2}{4} + x'^2 + y'^2} \cdot \left( e^{-\frac{2z}{a}} + \frac{a^2}{2(a + 2z)^2} \right)$$

Refer to raw data for measurement uncertainty

## 4.2 E-Field Probe ALS-E-020S

The isotropic E-Field probe has been fully calibrated and assessed for isotropicity, and boundary effect within a controlled environment. Depending on the frequency for which the probe is calibrated the method utilized for calibration will change. A number of methods is used for calibrating probes, and these are outlined in the table below:

The E-Field probe utilizes a triangular sensor arrangement as detailed in the diagram below:

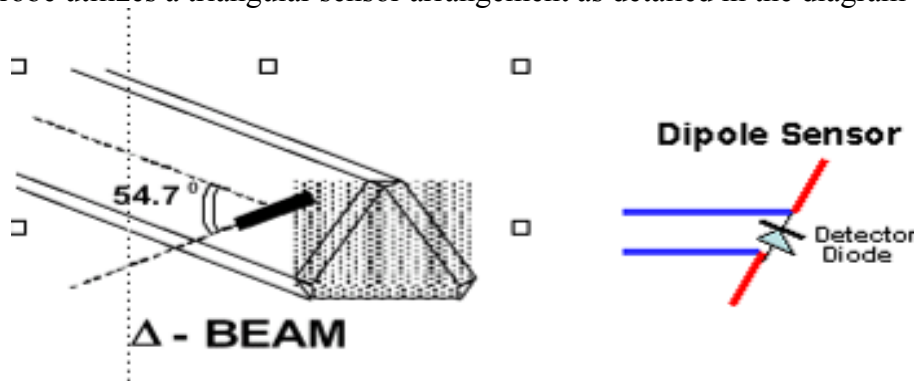

SAR is assessed with a calibrated probe which moves at a default height of 5mm from the center of the diode, which is mounted to the sensor, to the phantom surface (in the Z Axis). The 5mm offset height has been selected so as to minimize any resultant boundary effect due to the probe being in close proximity to the phantom surface.

The following algorithm is an example of the function used by the system for linearization of the output from the probe when measuring complex modulation schemes.

$$V_i = U_i + U_i^2 \cdot \frac{cf}{dcp_i}$$

#### 4.2.1 E-Field Probe Specification

##### **Model: ALS-E-020S**

Compliant Standards	IEEE 1528, IEC 62209 Part 1 & 2 (draft)
Frequency Range	30 MHz ~ 6 GHz
Sensitivity	Better than 0.8 $\mu\text{V}/(\text{V}/\text{m})^2$
Dynamic Range SAR	0.001 W/kg to 100 W/kg
Isotropic Response Axial	Typically $\pm 0.1\text{dB}$
Hemispherical isotropy	$\pm 0.3\text{ dB}$ or better
Linearity	$\pm 0.2\text{ dB}$ or better
Probe Tip Radius	User selectable all $< 5\text{ mm}$
Sensor Offset	1.56 ( $\pm 0.02\text{ mm}$ )
Probe Length	290 mm
Video Bandwidth	@ 500 Hz: 1 dB @ 1K Hz: 3 dB
Boundary Effect	Less than 2% for distances greater than 2.4 mm
Material	Ertalyte™
Connector	6 Pin Bayonet

##### **E-Field Probe Calibration**

Each probe needs to be calibrated according to a dosimetric assessment procedure with accuracy better than  $\pm 10\%$ . The spherical isotropy shall be evaluated and within  $\pm 0.25\text{ dB}$ . The sensitivity parameters (NormX, NormY, and NormZ), the diode compression parameter (DCP) and the conversion factor (ConvF) of the probe are tested. The calibration data can be referred to appendix C of this report.

##### **Boundary Detection Unit and Probe Mounting Device**

ALSAS-10U incorporates a boundary detection unit with a sensitivity of 0.05mm for detecting all types of surfaces. The robust design allows for detection during probe tilt (probe normalize) exercises, and utilizes a second stage emergency stop. The signal electronics are fed directly into the robot controller for high accuracy surface detection in lateral and axial detection modes (X, Y, & Z).

The probe is mounted directly onto the Boundary Detection unit for accurate tooling and displacement calculations controlled by the robot kinematics. The probe is connect to an isolated probe interconnect where the output stage of the probe is fed directly into the amplifier stage of the Daq-Paq.

### 4.3 DAQ-PAQ (Analog to Digital Electronics) ALS-DAQ-PAQ-3 Boundary Detection Unit ALS-PMDPS-3

ALSAS-10U incorporates a fully calibrated Daq-Paq (analog to digital conversion system) which has a 4 channel input stage, sent via a 2 stage auto-set amplifier module. The input signal is amplified accordingly so as to offer a dynamic range from 4  $\mu\text{V}$  to 330 mV. Integration of the fields measured is carried out at board level utilizing a Co-Processor which then sends the measured fields down into the main computational module in digitized form via an RS232 communications port. Probe linearity and duty cycle compensation is carried out within the main Daq-Paq module.

PMDPS is used to hold a probe and to detect complex boundary locations (curved and flat surfaces) during a SAR or HAC assessment process. It utilizes relative movements of internal components to trigger integrated micro-sensor mechanisms in order to detect boundary(s) and consequently position the probe at the specified distance relative to a boundary in order to achieve accurate and repeatable measurements.

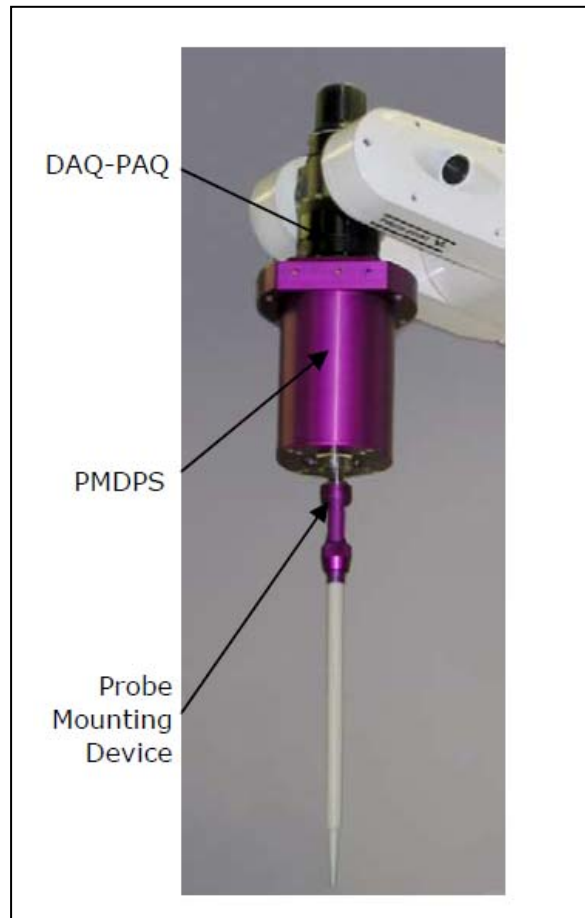

Amplifier Range	4 $\mu$ V to 330 mV
ADC	16 Bit optically isolated
Built-in E-Stop Feature	Emergency Stop feature to prevent damage of equipment and for user safety purposes
Field Integration	Local Co-Processor utilizing proprietary integration algorithms
SAR Dynamic Range	0.001 W/kg -100 W/kg.
Ambient Noise	Below 0.001 W/kg measured with probe in tissue
LED Indication	Boundary detection and DAQ-PAQ State
Number of Input Channels	4 in total 3 dedicated and 1 spare for future upgrades (when and if needed)
Communication	Optically isolated packet data via RS232
Robot Arm Integration	DAQ-PAQ and Boundary Detection Unit are mounted directly onto joint 6 of the F3 arm utilizing joint 6 tool (ISO Standard M8 Mounting Plate) to allow easy integration and removal (no angular interface)
Supply	DC supply powered by an isolated external supply unit (no battery required)
LED Indicators	Probe status (amplifier on) and boundary detection

### PMDPS Specification details

Accuracy of Positioning	Better than 10 $\mu$ m at 6GHz
SAR Uncertainty	Better than 0.01 W/kg SAR at 6Gz
Detection Mechanism	2 x 360° Stage Axial and Lateral Detection at 6GHz
Emergency Stop	4 Stage 360° Axial and Lateral Detection at 6GHz
Probe Mounting	6 Pin Bayonet for Fast Probe Change
Calibration	Every PMDPS is Calibrated to 0.01 W/kg SAR at 6GHz
Reliability Expectations	Better Than 10,000,000 Cycles

#### 4.4 Axis Articulated Robot ALS-F3



ALSAS-10U utilizes a six axis articulated robot, which is controlled using a Pentium based real-time movement controller. The movement kinematics engine utilizes proprietary (Thermo CRS) interpolation and extrapolation algorithms, which allow full freedom of movement for each of the six joints within the working envelope. Utilization of joint 6 allows for full probe rotation with a tolerance better than 0.05mm around the central axis.

Robot/Controller Manufacturer	Thermo CRS
Number of Axis	Six independently controlled axis
Positioning Resolution	0.05mm
Controller Type	Single phase Pentium based C500C
Robot Reach	710mm
Repeatability	0.05mm or better
Communication	RS232 and LAN compatible

#### 4.5 ALSAS Universal Workstation ALS-UWS

ALSAS Universal workstation allows for repeatability and fast adaptability. It allows users to do calibration, testing and measurements using different types of phantoms with one set up, which significantly speeds up the measurement process.



Workstation.  
Top view (rendering)



Workstation  
without robot (rendering)



#### 4.6 SAM Phantoms ALS-P-SAM-L / ALS-P-SAM-R

The ALSAS-10U allows the integration of multiple phantom types. SAM Phantoms fully compliant with IEEE 1528, Universal Phantom, and Universal Flat.

##### APREL SAM Phantoms

The SAM phantoms developed using the IEEE SAM CAD file. They are fully compliant with the requirements for both IEEE 1528 and FCC Supplement C. Both the left and right SAM phantoms are interchangeable, transparent and include the IEEE 1528 grid with visible NF and MB lines.

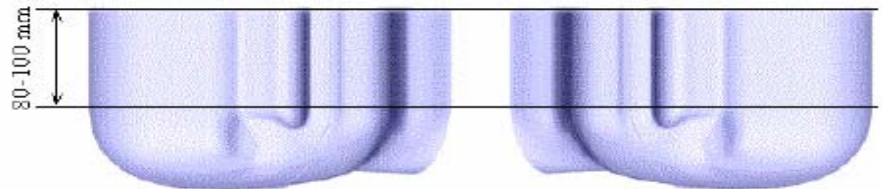

Compliant Standards	IEEE-1528, IEC 62209 Part 1 & 2 (draft)
SAM	In accordance with the IEEE 1528 standard
Material	Composite urethane which allows for the device to be viewed through the phantom, resistant to DGBE
Phantom Shell Shape Tolerance	Fully calibrated to be better than $\pm 0.2$ mm
Frame Material	Corian®
Tissue Simulation Volume	7 liter with $15.0 \pm 0.5$ cm tissue
Thickness	$2 \text{ mm} \pm 0.2 \text{ mm}$ $6 \text{ mm} \pm 0.2 \text{ mm}$ at NF/MB intersection
Loss Tangent	$<0.05$
Relative Permittivity	$<5$
Resistant to Solvents	Resistant to all solvents used for tissue manufacturing detailed in IEEE 1528
Load Deflection	$<1\text{mm}$ with sugar water compositions
Manufacturing Process	Injection Molded
Phantom Weight	Less than 10kg when filled with 15cm of simulation tissue

**Universal Phantom ALS-P-UP-1**

The Universal Phantom is used on the ALSAS-10U as a system validation phantom. The Universal Phantom has been fully validated both experimentally from 800MHz to 6GHz and numerically using XFDTD numerical software. The shell thickness is 2mm overall, with a 4mm spacer located at the NF/MB intersection providing an overall thickness of 6mm in line with the requirements of IEEE-1528.



The design allows for fast and accurate measurements, of handsets, by allowing the conservative SAR to be evaluated at on frequency for both left and right head experiments in one measurement.

Compliant Standards	IEEE-1528, IEC 62209 Part 1 & 2 (draft), CENELEC, and others
Manufacturing Process	Injection molded
Material	Vivac
Phantom Shell Shape Tolerance	Less than $\pm 0.2$ mm
Frame Material	Corian®
Tissue Simulation Volume	8 liter with $15.0 \pm 0.5$ cm tissue
Thickness	2mm $\pm 0.2$ mm 6mm at NF/MB intersection
Loss Tangent	<0.05
Relative Permittivity	<5
Resistant to Solvents	Resistant to all solvents detailed in IEEE 1528
Load Deflection	<1mm with heaviest tissue (sugar water compositions)
Dimensions	Length 220mm x breadth 170mm
Phantom Weight	Less than 10kg when filled with 15cm of simulation tissue



## 4.7 Universal Device Positioner

### ALS-H-E-SET-2

The universal device positioner allows complete freedom of movement of the EUT. Developed to hold a EUT in a free-space scenario any additional loading attributable to the material used in the construction of the positioner has been eliminated. Repeatability has been enhanced through the linear scales which form the design used to indicate positioning for any given test scenario in all major axes. A 15° tilt indicator is included for the of aid cheek to tilt movements for head SAR analysis. Overall uncertainty for measurements has been reduced due to the design of the Universal device positioner, which allows positioning of a device in as near to a free-space scenario as possible, and by providing the means for complete repeatability.

Compliant Standards	IEEE 1528, IEC 62209 Part 1 & 2 (draft)
Dielectric constant	Less than 5.0
Loss Tangent	Less than 0.05
Number of Axis	6 axis freedom of movement (8 when utilized with ALSAS-10U Workstation)
Translation Along MB Line	± 76.2 mm
Translation Along NF Line	± 38.1 mm
Translation Along Z Axis	± 25.4 mm (expandable up to 500 mm)
Rotation Around MB Line (yaw)	±10°
Rotation Around NF (pitch)	± 30°
Line Rotation (roll)	360° full circle
Maximum Grip Range	0 mm to 150 mm
Material	Resistant to DGBE and all other tissue stimulant materials as listed in IEEE 1528 Annex C.1.
Tilt Movement	Full movement with built-in 15° gauge

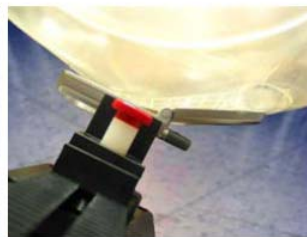
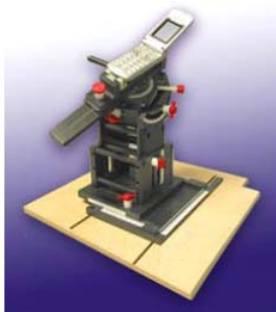

#### 4.8 Test Equipment List

Equipment Type	MFR	Model No.	Serial No.	Last Cal.	Cal. Due Date
Vector Network Analyzer	Agilent	E5071B	MY42402726	10/19/2012	10/18/2013
Dielectric Probe Kit	Aglient	85070E	MY44300124	N/A	N/A
Vector Signal Generator	R&S	SMU200A	102330	02/07/2012	02/06/2013
Power Meter	Anritsu	ML2495A	1116010	04/17/2012	04/16/2013
Power Sensor	Anritsu	MA2411B	34NKF50	04/16/2012	04/15/2013
Data Acquisition Package	Aprel	ALS-DAQ-PAQ-3	110-00220	NA	NA
Aprel Laboratories Probe	Aprel	ALS-E020	266	08/20/2012	08/19/2013
Aprel Reference Dipole 2450MHz	Aprel	LS-D-2450-S-2	2450-220-00753	01/25/2012	01/24/2015
Boundary Detection Sensor System	Aprel	ALS-PMDPS-3	120-00266	N/A	N/A
Universal Work Station	Aprel	ALS-UWS	100-00153	N/A	N/A
Device Holder 2.0	Aprel	ALS-H-E-SET-2	170-00503	N/A	N/A
Left Ear SAM Phantom	Aprel	ALS-P-SAM-L	130-00305	N/A	N/A
Right Ear SAM Phantom	Aprel	ALS-P-SAM-R	140-00359	N/A	N/A
Universal Phantom	Aprel	ALS-P-UP-1	150-00405	N/A	N/A
Aprel Dipole Spacer	Aprel	ALS-DS-U	250-00903	N/A	N/A
SAR Software	Aprel	ALSAS-10U Ver.2.2.0	B0D5F-112FE	N/A	N/A
CRS C500C Controller	Thermo	ALS-C500	RCF0440278	N/A	N/A
CRF F3 Robot	Thermo	ALS-F3	RAF0440252	N/A	N/A
Power Amplifier	Mini-Circuit	ZVE-8G	D030305	N/A	N/A

*Note: All equipment upon which need to be calibrated are with calibration period of 1 year.  
Other than Dipole antenna are calibration once 3 year*

## 5 Tissue Simulating Liquids

### *Tissue Dielectric Parameters for Head and Body Phantoms*

The head tissue dielectric parameters recommended by the IEEE SCC-34/SC-2 in P1528 have been incorporated in the following table. These head parameters are derived from planar layer models simulating the highest expected SAR for the dielectric properties and tissue thickness variations in a human head. Other head and body tissue parameters that have not been specified in P1528 are derived from the tissue dielectric parameters computed from the 4-Cole-Cole equations described in Reference [12] and extrapolated according to the head parameters specified in P1528.

Target Frequency (MHz)	Parameters(Body) IEEE1528 OTE 65		Parameters(Head) 62209-1/-2 IEEE1528 OET65	
	$\epsilon_r$	$\sigma$ (S/m)	$\epsilon_r$	$\sigma$ (S/m)
835	55.2	0.97	41.5	0.90
900	55.0	1.05	41.5	0.97
1800 – 2000	53.3	1.52	40.0	1.4
2450	52.7	1.95	39.2	1.8
5800	48.2	6.00	35.3	5.27

( $\epsilon_r$  = relative permittivity,  $\sigma$  = conductivity and  $\rho = 1000 \text{ kg/m}^3$ )

### *Tissue Calibration Result*

The dielectric parameters of the liquids were verified prior to the SAR evaluation using Agilent Dielectric Probe Kit 85070E and Agilent E5071B Vector Network Analyzer

Body Tissue Simulant Measurement				
Frequency [MHz]	Description	Dielectric Parameters		Tissue Temp. [°C]
		$\epsilon_r$	$\sigma$ [s/m]	
2450MHz	<b>Reference result ± 5% window</b>	<b>52.7 50.065 to 55.335</b>	<b>1.95 1.8525 to 2.0475</b>	N/A
	Oct 30, 2012	54.4112	1.882	22
2412MHz	Oct 30, 2012	54.2589	1.874	22
2437MHz	Oct 30, 2012	54.3315	1.878	22
2462MHz	Oct 30, 2012	54.4866	1.891	22

## 6 SAR Measurement Evaluation

Each system is equipped with one or more system validation kits. These units, together with the predefined measurement procedures within the APREL SAR software, enable the user to conduct the system performance check and system validation. System validation kit includes a dipole, tripod holder to fix it underneath the flat phantom and a corresponding distance holder.

### System Setup

In the simplified setup for system evaluation, the DUT is replaced by a calibrated dipole and the power source is replaced by a continuous wave that comes from a signal generator. The calibrated dipole must be placed beneath the flat phantom section of the SAM twin phantom with the correct distance holder. The distance holder should touch the phantom surface with a light pressure at the reference marking and be oriented parallel to the long side of the phantom. The equipment setup is shown below:

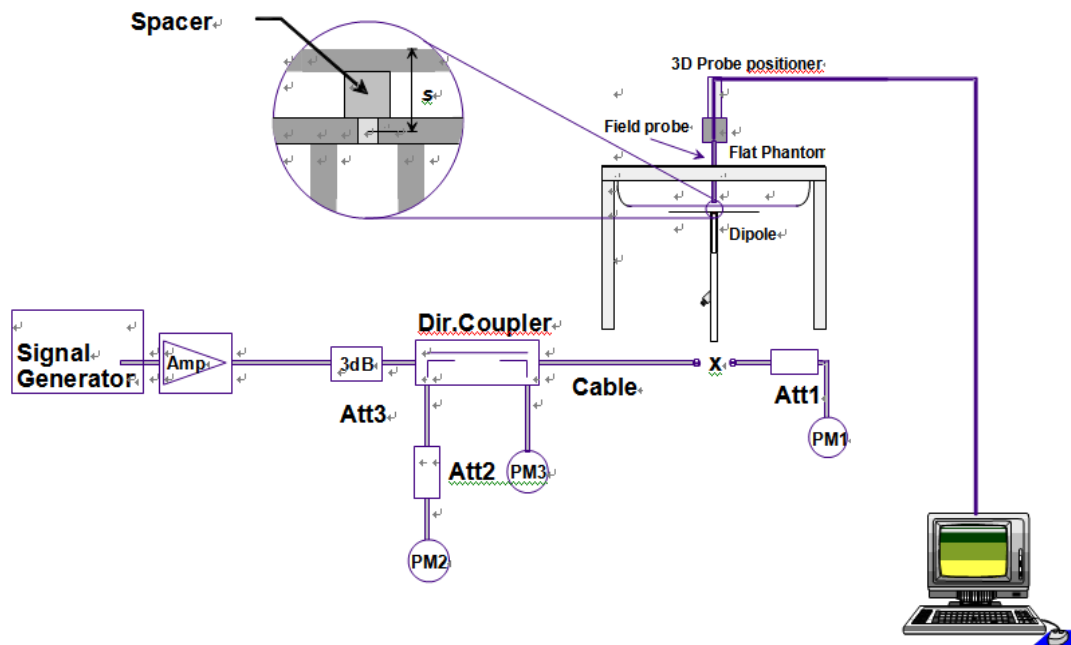

1. Signal Generator
2. Amplifier
3. Directional Coupler
4. Power Meter
5. Calibrated Dipole

### *Validation Dipoles*

The dipoles used is based on the IEEE-1528 standard, and is complied with mechanical and electrical specifications in line with the requirements of both IEEE and FCC Supplement C. the table below provides details for the mechanical and electrical specifications for the dipoles.

*	Frequency	L (mm)	h (mm)	d (mm)
	835MHz	161.0	89.8	3.6
	900MHz	149.0	83.3	3.6
	1800MHz	72.0	41.7	3.6
	1900MHz	68.0	39.5	3.6
v	2450MHz	51.5	30.4	3.6
	5200MHz	23.6	14.0	3.6
	5800MHz	21.6	12.6	3.6

\*Note: “V” indicates Frequency used of EUT

The output power on dipole port must be calibrated to 30 dBm (1W) before dipole is connected.

### Validation Result



Comparing to the Yearly Calibration SAR value provided by APREL, the validation data should be within its specification of 5 %. Table shows the target SAR and measured SAR after normalized to 1W input power. The table below indicates the system performance check can meet the variation criterion and the plots can be referred to Appendix E of this report.

Frequency [MHz]	Description	SAR [w/kg] 1g	SAR [w/kg] 10g	Tissue Temp. [°C]
2450 MHz	Reference result ± 5% window	55.57 52.79 to 58.38	25.80 24.51 to 27.09	N/A
	Oct 30,2012	53.457	25.618	21.7

Note: All SAR values are normalized 1W.

## 7 DUT Testing Position

### *Test Positions of Device Relative to Head*

This specifies exactly two test positions for the handset against the head phantom, the “cheek” position and the “tilted” position. The handset should be tested in both positions on the left and right sides of the SAM phantom. If the handset construction is such that it cannot be positioned using the handset positioning procedures described in 4.2.2.1 and 4.2.2.2 to represent normal use conditions (e.g., asymmetric handset), alternative alignment procedures should be considered with details provided in the test report.

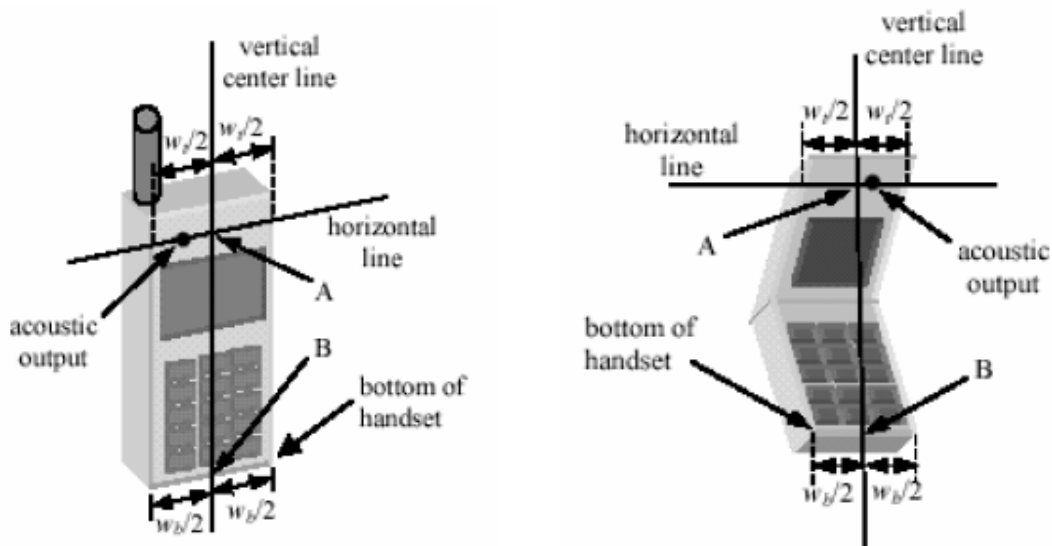

### *Definition of the “Cheek” Position*

The “cheek” position is defined as follows:

- Ready the handset for talk operation, if necessary. For example, for handsets with a cover piece, open the cover. (If the handset can also be used with the cover closed both configurations must be tested.)
- Define two imaginary lines on the handset: the vertical centerline and the horizontal line. The vertical centerline passes through two points on the front side of the handset: the midpoint of the width  $w_t$  of the handset at the level of the acoustic output (point A on Figures 4.1a and 4.1b), and the midpoint of the width  $w_b$  of the bottom of the handset (point B). The horizontal line is perpendicular to the vertical centerline and passes through the center of the acoustic output (see Figure 4.1a). The two lines intersect at point A. Note that for many handsets, point A coincides with the center of the acoustic output. However, the acoustic output may be located elsewhere on the horizontal line. Also note that the vertical centerline is not necessarily parallel to the front face of the handset (see Figure 4.1b), especially for clamshell handsets, handsets with flip pieces, and other irregularly-shaped handsets.
- Position the handset close to the surface of the phantom such that point A is on the (virtual) extension of the line passing through points RE and LE on the phantom (see Figure 4.2), such that the plane defined by the vertical center line and the horizontal line of the handset is approximately parallel to the sagittal plane of the phantom.

- d. Translate the handset towards the phantom along the line passing through RE and LE until the handset touches the pinna.
- e. While maintaining the handset in this plane, rotate it around the LE-RE line until the vertical centerline is in the plane normal to MB-NF including the line MB (called the reference plane).
- f. Rotate the handset around the vertical centerline until the handset (horizontal line) is symmetrical with respect to the line NF.
- g. While maintaining the vertical centerline in the reference plane, keeping point A on the line passing through RE and LE and maintaining the handset contact with the pinna, rotate the handset about the line NF until any point on the handset is in contact with a phantom point below the pinna (cheek). See Figure 4.2 the physical angles of rotation should be noted.

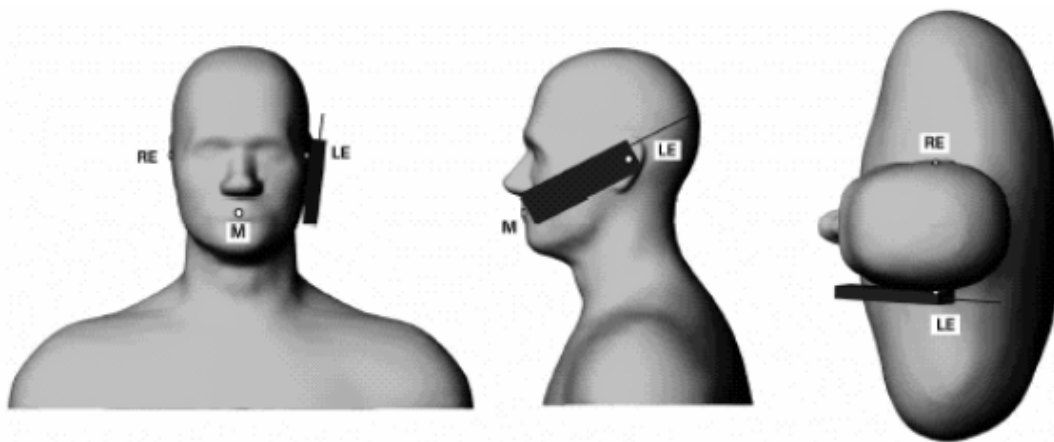

### ***Definition of the “Tilted” Position***

The “tilted” position is defined as follows:

- a. Repeat steps (a) – (g) of 4.2.1.1 to place the device in the “cheek position.”
- b. While maintaining the orientation of the handset move the handset away from the pinna along the line passing through RE and LE in order to enable a rotation of the handset by 15 degrees.
- c. Rotate the handset around the horizontal line by 15 degrees.
- d. While maintaining the orientation of the handset, move the handset towards the phantom on a line passing through RE and LE until any part of the handset touches the ear. The tilted position is obtained when the contact is on the pinna. If the contact is at any location other than the pinna (e.g., the antenna with the back of the phantom head), the angle of the handset should be reduced. In this case, the tilted position is obtained if any part of the handset is in contact with the pinna as well as a second part of the handset is contact with the phantom (e.g., the antenna with the back of the head).



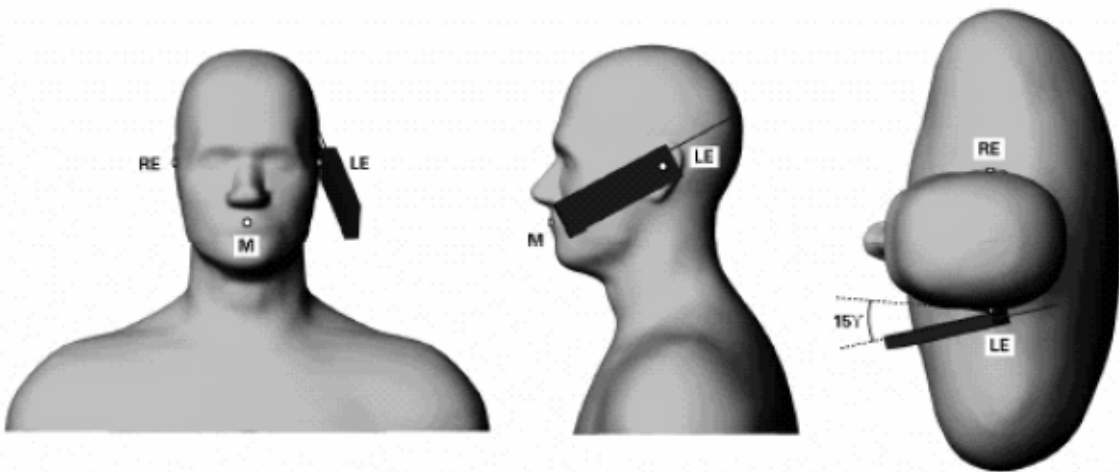

***Test Positions for body-worn***

Body-worn operating configurations should be tested without the belt-clips and holsters attached to the device and positioned against a flat phantom in normal use configurations. A separation distance of 0.5 cm between the device and a flat phantom is recommended for testing body-worn SAR compliance under such circumstances. Other separation distance may be used, but not exceed 1 cm.



## SAR Measurement Procedures

The measurement procedures are as follows:

- (a) through software control to continuous transmit
- (b) Set software to maximum output power and data rate
- (c) Measure output power through RF cable and power meter
- (d) Place the DUT in the positions described in the last section
- (e) Set scan area, grid size and other setting on the APREL software
- (f) Taking data for the maximum power on each testing position
- (g) Find out the largest SAR result on these testing positions of each band
- (h) Measure SAR results for the other channels in worst SAR testing position

According to the test standard, the recommended procedure for assessing the peak spatial-average SAR value consists of the following steps:

- (a) Power reference measurement
- (b) Area scan
- (c) Zoom scan
- (d) Power drift measurement

### Spatial Peak SAR Evaluation

The procedure for spatial peak SAR evaluation has been implemented according to the test standard. It can be conducted for 1g and 10g, as well as for user-specific masses. The APREL SAR software includes all numerical procedures necessary to evaluate the spatial peak SAR value.

The base for the evaluation is a "cube" measurement. The measured volume must include the 1g and 10g cubes with the highest averaged SAR values. For that purpose, the center of the measured volume is aligned to the interpolated peak SAR value of a previously performed area scan.

The entire evaluation of the spatial peak values is performed within the post-processing engine (SEMCAD). The system always gives the maximum values for the 1g and 10g cubes. The algorithm to find the cube with highest averaged SAR is divided into the following stages:

- (a) Extraction of the measured data (grid and values) from the Zoom Scan
- (b) Calculation of the SAR value at every measurement point based on all stored data (A/D values and measurement parameters)
- (c) Generation of a high-resolution mesh within the measured volume
- (d) Interpolation of all measured values from the measurement grid to the high-resolution grid
- (e) Extrapolation of the entire 3-D field distribution to the phantom surface over the distance from sensor to surface
- (f) Calculation of the averaged SAR within masses of 1g and 10g

### **Scan Procedures**

First Area Scan is used to locate the approximate location(s) of the local peak SAR value(s). The measurement grid within an Area Scan is defined by the grid extent, grid step size and grid offset. Next, in order to determine the EM field distribution in a three-dimensional spatial extension, Zoom Scan is required. The Zoom Scan measures 5x5x7 points with step size 8, 8 and 5 mm for 300 MHz to 3 GHz. The Zoom Scan is performed around the highest E-field value to determine the averaged SAR-distribution over 10 g.

### **SAR Averaged Methods**

In APREL, the interpolation and extrapolation are both based on the modified Quadratic Shepard's method. The interpolation scheme combines a least-square fitted function method and a weighted average method which are the two basic types of computational interpolation and approximation.

Extrapolation routines are used to obtain SAR values between the lowest measurement points and the inner phantom surface. The extrapolation distance is determined by the surface detection distance and the probe sensor offset. The uncertainty increases with the extrapolation distance. To keep the uncertainty within 1% for the 1 g and 10 g cubes, the extrapolation distance should not be larger than 5 mm.

## 8 SAR Test Results

### 8.1 Conducted power table:

802.11b

Cable loss = 0		Output Power	
CH	Frequency (MHz)	Detector	
		PK (dBm)	AV (dBm)
1	2412	20.56	16.33
6	2437	20.42	16.47
11	2462	19.84	16.17

802.11g

Cable loss = 0		Output Power	
CH	Frequency (MHz)	Detector	
		PK (dBm)	AV (dBm)
1	2412	21.62	13.06
6	2437	22.23	13.22
11	2462	21.99	12.84

802.11n 20

Cable loss = 0		Output Power	
CH	Frequency (MHz)	Detector	
		PK (dBm)	AV (dBm)
1	2412	20.31	13.24
6	2437	20.67	13.33
11	2462	20.42	13.09

802.11n 40

Cable loss = 0		Output Power	
CH	Frequency (MHz)	Detector	
		PK (dBm)	AV (dBm)
3	2422	20.08	13.19
6	2437	20.22	13.38
9	2452	20.31	13.04

## 8.2 Test Records for Body SAR Test

<i>Ambient Temperature (°C) : 21.7</i>	<i>Relative Humidity (%) : 60</i>
<i>Liquid Temperature (°C) : 22</i>	<i>Depth of Liquid (cm) : &gt;15</i>

<b>Data No.</b>	<b>Band</b>	<b>Mode</b>	<b>Test Position</b>	<b>Separation Distance (cm)</b>	<b>Channel</b>	<b>SAR 1g(W/kg)</b>
1	Wifi	802.11b	EUT of Top	0.5	6	0.200
2	Wifi	802.11b	EUT of Front	0.5	6	<b>1.363</b>
3	Wifi	802.11b	EUT of Left	0.5	6	0.800
4	Wifi	802.11b	EUT of Right	0.5	6	0.609
5	Wifi	802.11b	EUT of Back with Notebook	0.5	6	0.583
6	Wifi	802.11b	EUT of Front	0.5	1	1.228
7	Wifi	802.11b	EUT of Front	0.5	11	0.998
8	Wifi	802.11n 20	EUT of Front	0.5	6	0.397
9	Wifi	802.11n 40	EUT of Front	0.5	6	0.349

Note: According KDB248227 SAR is not required for 802.11g when maximum average power less than 1/4dB higher than that measured on the corresponding 802.11b

## 9 Exposure Assessment Measurement Uncertainty

Source of Uncertainty	Tolerance Value	Probability Distribution	Divisor	$c_i^1$ (1-g)	$c_i^1$ (10-g)	Standard Uncertainty (1-g) %	Standard Uncertainty (10-g) %
Measurement System							
Probe Calibration	3.5	normal	1	1	1	3.5	3.5
Axial Isotropy	3.7	rectangular	$\sqrt{3}$	$(1-cp)^{1/2}$	$(1-cp)^{1/2}$	1.5	1.5
Hemispherical Isotropy	10.9	rectangular	$\sqrt{3}$	$\sqrt{cp}$	$\sqrt{cp}$	4.4	4.4
Boundary Effect	1.0	rectangular	$\sqrt{3}$	1	1	0.6	0.6
Linearity	4.7	rectangular	$\sqrt{3}$	1	1	2.7	2.7
Detection Limit	1.0	rectangular	$\sqrt{3}$	1	1	0.6	0.6
Readout Electronics	1.0	normal	1	1	1	1.0	1.0
Response Time	0.8	rectangular	$\sqrt{3}$	1	1	0.5	0.5
Integration Time	1.7	rectangular	$\sqrt{3}$	1	1	1.0	1.0
RF Ambient Condition	3.0	rectangular	$\sqrt{3}$	1	1	1.7	1.7
Probe Positioner Mech.	0.4	rectangular	$\sqrt{3}$	1	1	0.2	0.2
Restriction							
Probe Positioning with respect to Phantom Shell	2.9	rectangular	$\sqrt{3}$	1	1	1.7	1.7
Extrapolation and Integration	3.7	rectangular	$\sqrt{3}$	1	1	2.1	2.1
Test Sample Positioning	4.0	normal	1	1	1	4.0	4.0
Device Holder Uncertainty	2.0	normal	1	1	1	2.0	2.0
Drift of Output Power	1.2	rectangular	$\sqrt{3}$	1	1	0.7	0.7
Phantom and Setup							
Phantom Uncertainty(shape & thickness tolerance)	3.4	rectangular	$\sqrt{3}$	1	1	2.0	2.0
Liquid Conductivity(target)	5.0	rectangular	$\sqrt{3}$	0.7	0.5	2.0	1.4
Liquid Conductivity(meas.)	2.9	normal	1	0.7	0.5	2.0	1.4
Liquid Permittivity(target)	5.0	rectangular	$\sqrt{3}$	0.6	0.5	1.7	1.4
Liquid Permittivity(meas.)	3.3	normal	1	0.6	0.5	2.0	1.6
Combined Uncertainty		RSS				9.7	9.3
Combined Uncertainty (coverage factor=2)		Normal(k=2)				19.4	18.7

## **Appendix A    Test Setup Photos**

EUT of Top

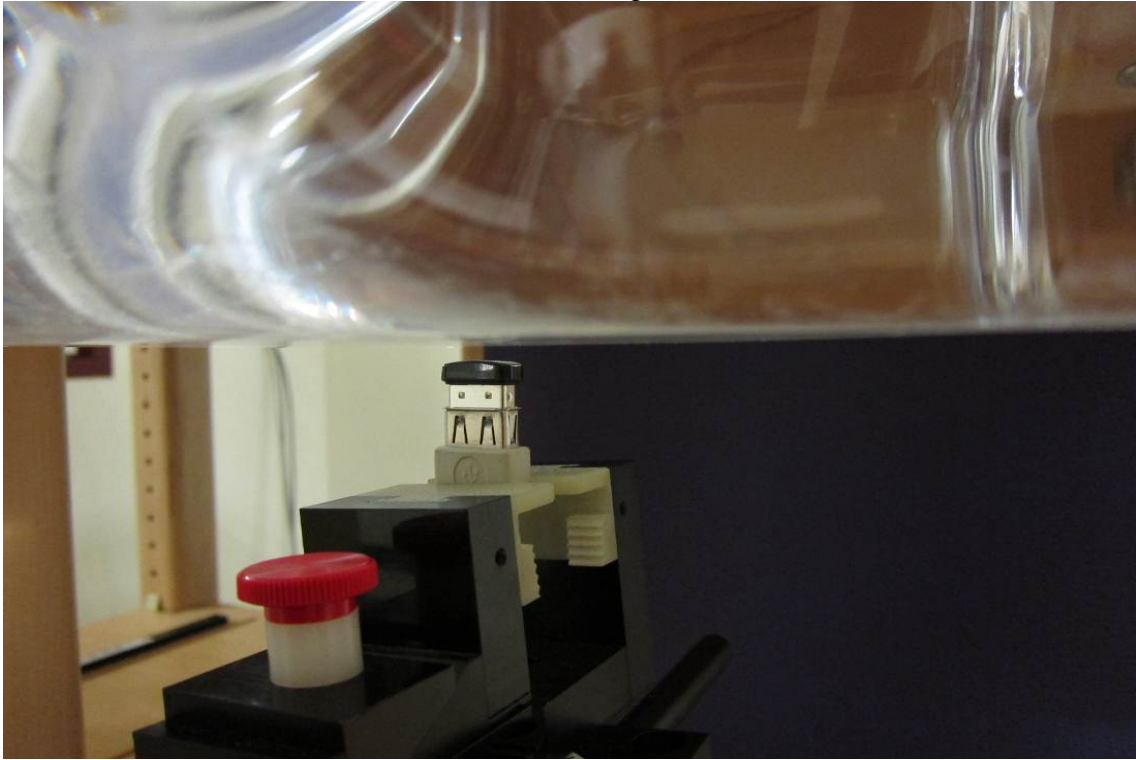

EUT of Back





EUT of front

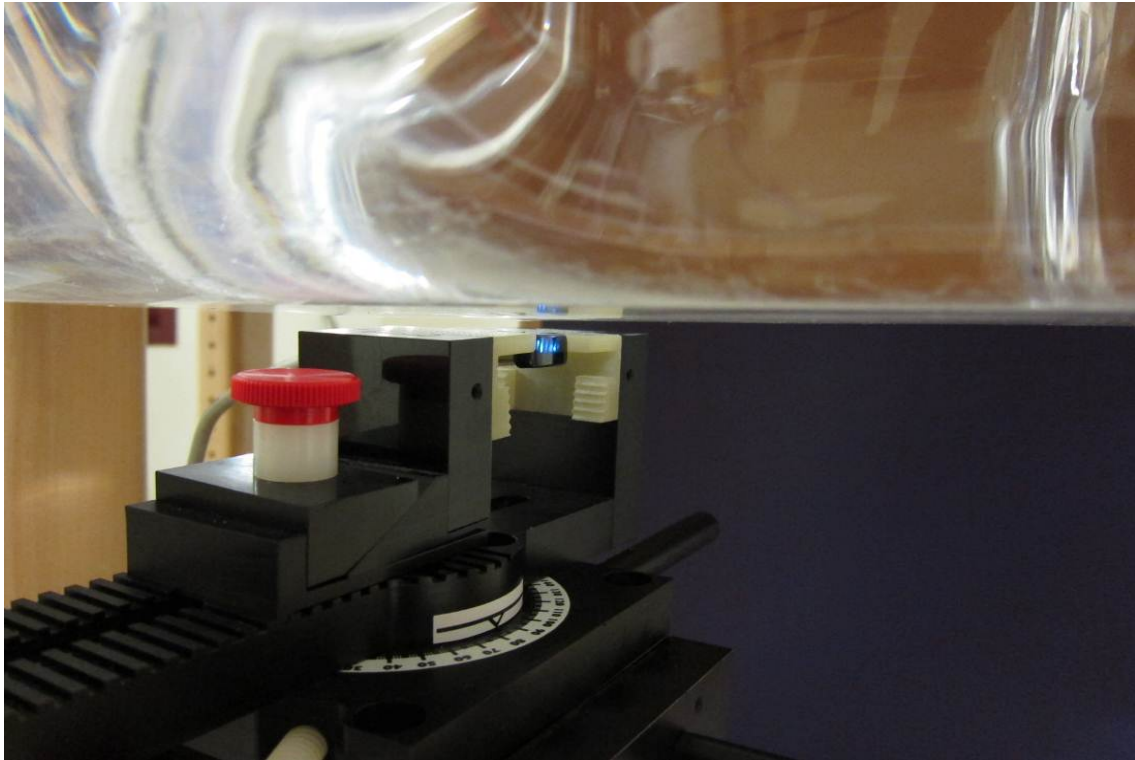

Edge of Left

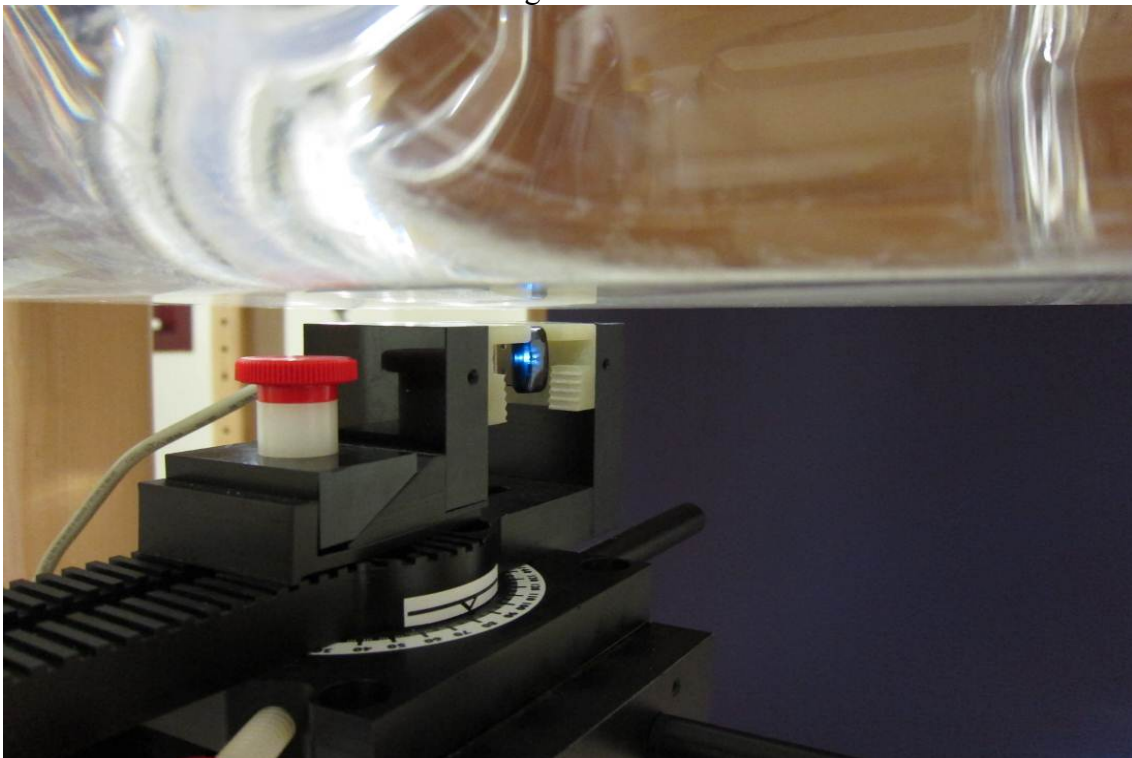



Edge of Right

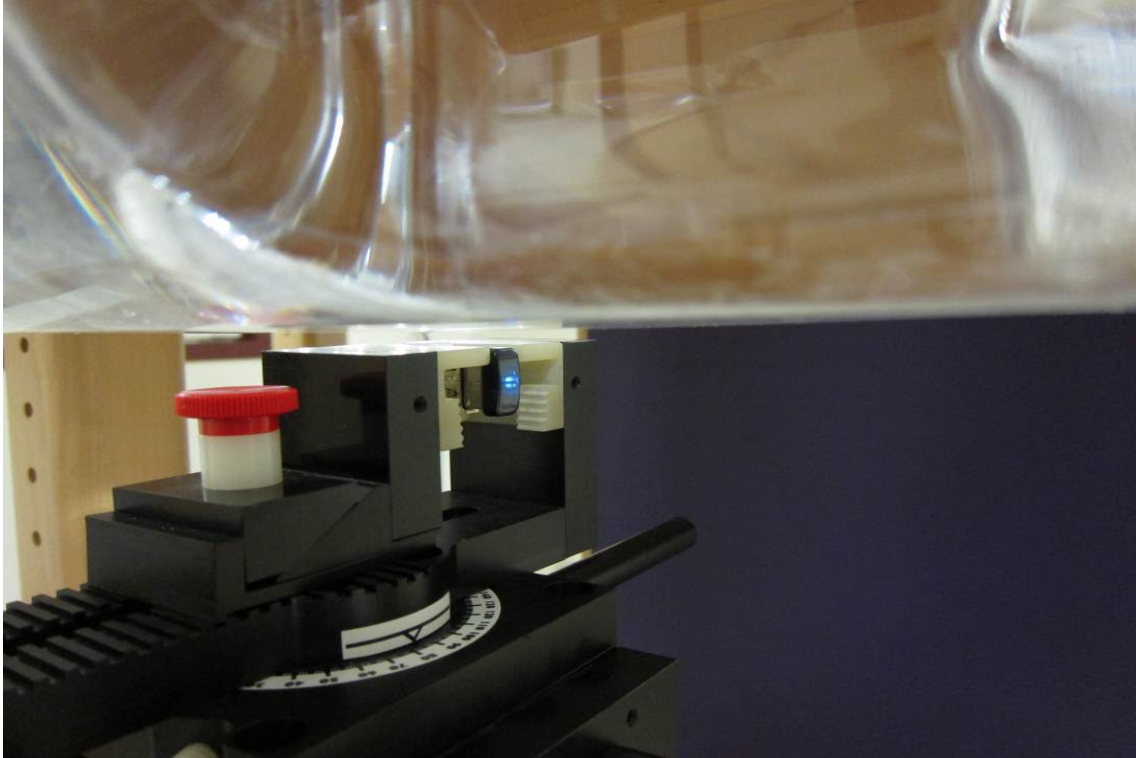

## **Appendix B    DUT Photos**

## *External of EUT – 1*



## *External of EUT – 2*



*External of EUT – 3*



*External of EUT – 4*



*External of EUT – 5*



*External of EUT – 6*



*External of EUT – 7*





*Internal of EUT - 1*

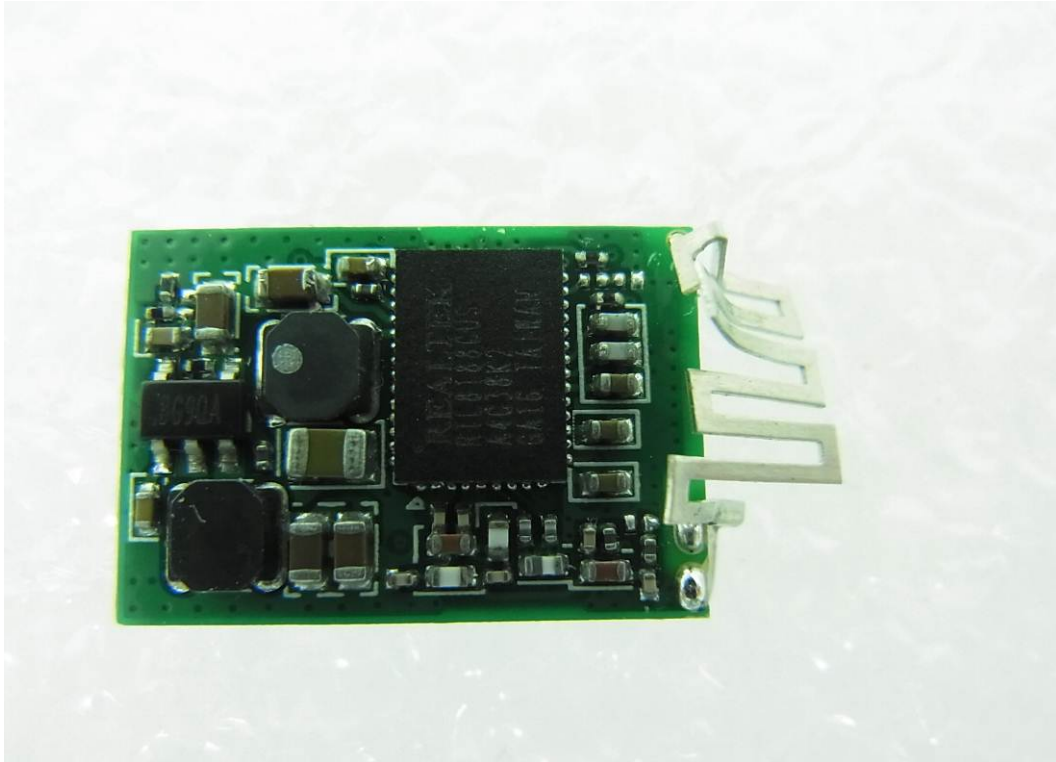

*Internal of EUT-2*



**Appendix C: System Performance Check**

Refer to Appendix C

**Appendix D: SAR Measurement Data**

Refer to Appendix D

**Appendix E: Probe Calibration Certificate**

Refer to Appendix E

**Appendix F: Dipole Calibration Certificate**

Refer to Appendix F

*~ end of Report ~*