

KENWOOD

MONITOR WITH DVD RECEIVER

DDX9906XR

DDX8906S

DDX8706S

DDX819WBTL

MONITOR WITH RECEIVER

DMX906S

DMX9706S

INSTRUCTION MANUAL

JVCKENWOOD Corporation

- Updated information (the latest Instruction Manual, system updates, new functions, etc.) is available from <http://www.kenwood.com/cs/ce/>.
- The Instruction manual is subject to change for modification of specifications and so forth. Be sure to download the latest edition of the Instruction manual for reference. <http://manual.kenwood.com/edition/im401/>

Take the time to read through this instruction manual.

Familiarity with installation and operation procedures will help you obtain the best performance from your new receiver.

For your records

Record the serial number, found on the back of the unit, in the spaces designated on the warranty card, and in the space provided below. Refer to the model and serial numbers whenever you call upon your KENWOOD dealer for information or service on the product.

Model DDX9906XR / DDX8906S / DDX8706S / DDX819WBTL / DMX906S / DMX9706S Serial number _____

US Residence Only

Register Online

Register your KENWOOD product at www.kenwood.com/usa/

Contents

Before Use	4	APPS	29
Precautions	4	Wireless Mirroring Operation.....	29
How to read this manual	5	Apple CarPlay Operation	29
		Android Auto™ Operation	32
		Spotify Operation.....	35
		Pandora® Operation	36
Basic Operations	6		
Functions of the Buttons on the Front Panel ...	6	USB	39
Turning on the Unit	8	Connecting a USB device	39
Initial Settings	9	USB Basic Operation.....	39
Adjusting the volume	10	Search Operation.....	41
Display Adjustment	11		
Viewing Angle	11	iPod/iPhone	42
Touch screen operations	12	Preparation	42
HOME screen descriptions.....	12	iPod/iPhone Basic Operation	42
Popup menu	13	Search Operation.....	43
Source selection screen description.....	13		
Source control screen descriptions	16	Radio	45
List screen	17	Radio Basic Operation	45
		Memory Operation	46
		Selecting Operation	47
		Traffic Information	47
Widget	18		
Widget.....	18	HD Radio™ Tuner	48
Multi Widget.....	18	HD Radio Tuner Basic Operation.....	48
Photo Frame Widget	20	Receive Mode	50
Widget Setup	20	Memory Operation.....	50
		Selecting Operation	50
		Bookmark.....	52
		Alert Message	53
Disc	22		
Playing a disc	22		
DVD/VCD Basic Operation	23		
Music CD/Disc media Basic Operation	24		
File search Operation	26		
DVD Disc Menu Operation.....	26		
DVD Setup.....	27		

SiriusXM® 54

SiriusXM® Basic Operation54
Storing Channels in Preset Memory56
Preset select56
Direct search56
Category/Channel search57
Replay57
TuneMix™58
SmartFavorites, TuneStart™58
TuneScan™58
Traffic & Weather Now™59
Content Alerts.....59
SportsFlash™60
SiriusXM Setup60

Bluetooth Control 66

Information for using Bluetooth® devices.....66
Register the Bluetooth device67
Bluetooth Setup.....68
Playing the Bluetooth Audio Device70
Using the Hands-Free Unit.....72
Hands-Free Setup.....77

Other External Components 78

View Camera78
Use Dashboard Camera.....81
External audio/video players (AV-IN).....81
TV tuner81
OEM Features Operation82

Setup 83

Monitor Screen Setup83
System Setup83
User Interface Setup.....84
Special Setup86
Display Setup86
AV Setup88

Controlling Audio 90

3-way speaker system setup90
Speaker / X'over setup91
Controlling General Audio93
Equalizer Control93
Volume Offset94
Zone Control95
Sound Effect96
Listening Position / DTA97
Audio Setup memory98

Remote control 99

Battery Installation.....99
Functions of the Remote control Buttons99

Connection/Installation 102

Before Installation 102
Installing the unit 104

Troubleshooting 114

Problems and Solutions 114
Error Messages 114

Appendix 117

Playable Media and Files..... 117
Region Codes in the World 119
DVD Language Codes..... 120
Specifications..... 121
About this Unit 124

Before Use

Before Use

Precautions

▲ WARNINGS

■ To prevent injury or fire, take the following precautions:

- To prevent a short circuit, never put or leave any metallic objects (such as coins or metallic tools) inside the unit.
- Do not watch or fix your eyes on the unit's display when you are driving for any extended period.
- If you experience problems during installation, consult your KENWOOD dealer.

■ Precautions on using this unit

- When you purchase optional accessories, check with your KENWOOD dealer to make sure that they work with your model and in your area.
- You can select a language to display menus, audio file tags, etc. See **User Interface Setup (P.84)**.
- The Radio Data System or Radio Broadcast Data System feature won't work in areas where the service is not supported by any broadcasting station.

■ Protecting the monitor

- To protect the monitor from damage, do not operate the monitor using a ball point pen or similar tool with a sharp tip.

■ Cleaning the unit

- If the faceplate of this unit is stained, wipe it with a dry soft cloth such as a silicon cloth. If the faceplate is stained badly, wipe it with a cloth moistened with neutral cleaner, then wipe it again with a clean soft dry cloth.

NOTE

- Applying spray cleaner directly to the unit may damage its mechanical parts. Wiping the faceplate with a hard cloth or using a volatile liquid such as thinner or alcohol may scratch the surface or erase the screened print.

■ Lens fogging

When you turn on the car heater in cold weather, dew may form on the lens in the disc player of the unit due to condensation. This condensation on the lens (also called lens fogging) may not allow discs to play. In such a situation, remove the disc and wait for the dew to evaporate. If the unit still does not operate normally after a while, consult your KENWOOD dealer.

■ Precautions on handling discs

- Do not touch the recording surface of the disc.
- Do not stick tape etc. on the disc, or use a disc with tape stuck on it.
- Do not use disc type accessories.
- Clean the disc from the center toward the outside rim.
- When removing a disc from this unit, pull it out horizontally.
- If the disc center hole or outside rim has burrs, use the disc only after removing the burrs with a ballpoint pen etc.
- Discs that are not round cannot be used.

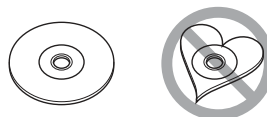

- 8-cm (3 inch) discs cannot be used.
- Discs with coloring on the recording surface or discs that are dirty cannot be used.
- This unit can only play the following types of CDs.



- This unit may not correctly play discs which do not have the mark.
- You cannot play a disc that has not been finalized. (For the finalization process, see your writing software and your recorder's instruction manual.)

Acquiring GPS signal

The first time you turn on this unit, you must wait while the system acquires satellite signals for the first time. This process could take up to several minutes. Make sure your vehicle is outdoors in an open area away from tall buildings and trees for fastest acquisition.

After the system acquires satellites for the first time, it will acquire satellites quickly each time thereafter.

About GLONASS

This unit uses Global Navigation Satellite System (GLONASS) in addition to GPS.

Combining GPS and GLONASS can refine positioning accuracy than using GPS only.

Caution for Smartphone Users

Simultaneously running multiple applications on your smartphone while screen sharing places heavy demand on the microprocessor of the phone, potentially affecting communication and performance.

For best results while pairing with your Kenwood receiver, please be sure to close any unused applications.

How to read this manual

- The screens and panels shown in this manual are examples used to provide a clear explanation of operations. For this reason, they may be different from the actual screens or panels, or some display patterns may be different from the actual ones.
- **Display language:** English is used for the purpose of explanation. You can select a display language from the **SETUP** menu. See **User Interface Setup (P.84)**.

Basic Operations

Functions of the Buttons on the Front Panel

DDX9906XR / DDX8906S / DDX8706S

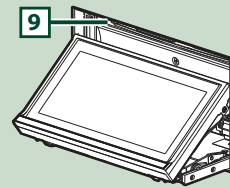
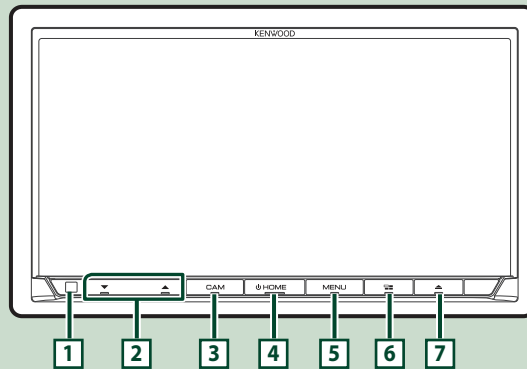

DMX906S / DMX9706S

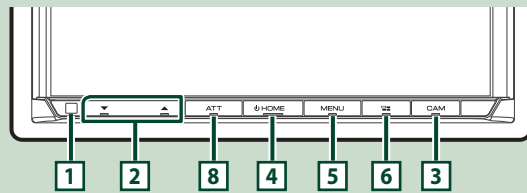

DDX819WBTL

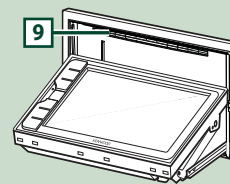
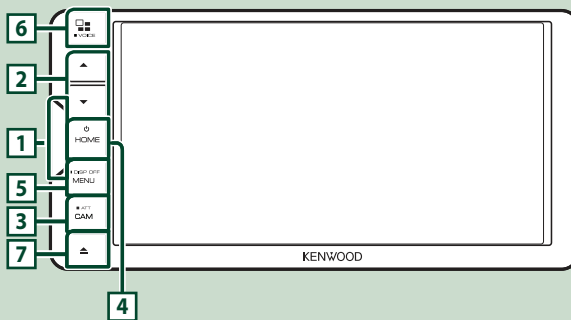

NOTE

• The panels shown in this manual are examples used to provide a clear explanation of operations. For this reason, they may be different from the actual panels.

Number	Name	Motion
1	Remote Sensor	• Receives the remote control signal.
2	▼, ▲ (Volume)	• Adjusts the volume. The volume will go up to 15 when you keep pressing ▲. (P.11)
3	CAM	• Switches view camera display on/off. The camera whose view is displayed first changes according to the "Camera Setup" setting and the shift lever position in the shift gate. • Pressing and holding turns the screen off. (DDX9906XR / DDX8906S / DDX8706S) • Pressing for 1 second switches attenuation of the volume on/off. (DDX819WBTL)
4	HOME	• Displays the HOME screen (P.13). • Pressing for 1 second turns the power off. • When the power is off, turns the power on.
5	MENU	• Displays the popup menu screen. • Pressing for 1 second switches attenuation of the volume on/off. (DDX9906XR / DDX8906S / DDX8706S) • Pressing for 1 second turns the screen off. (DDX819WBTL / DMX906S / DMX9706S)
6		• Displays the APP (Apple CarPlay/Android Auto/Wireless Mirroring) screen. • Pressing and holding displays the Voice Recognition screen (P.74). • When neither Apple CarPlay, Android Auto, nor a Bluetooth Hands-Free phone is connected, pressing and holding displays Bluetooth pairing waiting dialog. (P.67)
7	▲	• Displays the Angle Adjust screen. – DISC EJECT : Ejects the disc. • When the panel is opened, closes the panel. • To forcibly eject the disc, press it for 2 seconds and then touch DISC EJECT after the message is displayed.
8	ATT	• Switches attenuation of the volume on/off.
9	Disc insert slot	• A slot to insert a disc media. (DDX9906XR / DDX8906S / DDX8706S / DDX819WBTL only)

Basic Operations

Turning on the Unit

The method of turning on is different depending on the model.

- 1 Press the **HOME** button.

DDX9906XR / DDX8906S / DDX8706S



DMX906S / DMX9706S



DDX819WBTL

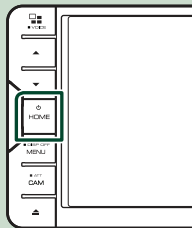

➤ The unit is turned on.

● To turn off the unit:

- 1 Press the **HOME** button for 1 second.

NOTE

- If it is your first time to turn the unit on after installation, it will be necessary to perform Initial setup (P.8).

Initial Settings

Initial setup

Perform this setup when you use this unit first time.

- 1 Set each item as follows.

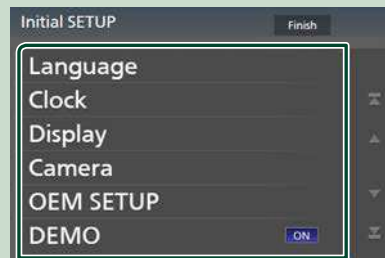

■ Language

Select the language used for the control screen and setting items. Default is "American English(en)".

- ① Touch **Language**.
- ② Touch **Language Select**.
- ③ Select the desired language.
- ④ Touch

For details, see **User Interface Setup (P.84)**.

■ Clock

Sets the synchronization of the clock and adjusts it.

For details, see **Calendar/clock settings (P.10)**.

■ Display

Set the key illumination color.

If it is hard to see the image on the screen even, adjust the viewing angle.

- ① Touch **Display**.
- ② Touch **Key Color**.
- ③ Select the desired color.
- ④ Touch

(DDX9906XR / DDX8906S / DDX8706S / DDX819WBTL only)

- ⑤ Touch **Display Adjustment**.
- ⑥ Adjust a viewing angle and a tilt position.
- ⑦ Touch .

For details, see **Display Adjustment (P.11)**.

(DMX906S / DMX9706S only)

- ⑤ Touch **Viewing Angle**.
- ⑥ Select a viewing angle.
- ⑦ Touch .

For details, see **Viewing Angle (P.12)**.

For details, see **Display Setup (P.86)**.

■ Camera

Set the parameters for the camera.

- ① Touch **Camera**.
- ② Set each item and touch .

For details, see **Camera Setup (P.78)**.

■ OEM SETUP (Except DDX819WBTL)

This function requires a commercial adaptor. Consult your KENWOOD dealer for details.

■ DEMO

Set the demonstration mode. Default is "ON".

2 Touch Finish.



NOTE

- These settings can be made from the SETUP menu. See **Setup (P.83)**.

Security Code Setup (DDX819WBTL)

You can set up a security code to protect your receiver system against theft.

When the Security Code function is activated, the code cannot be changed and the function cannot be deactivated. Note that the Security Code can be set with a 4 to 8 digit number of your choice.

1 Press the MENU button.

- Popup menu appears.

2 Touch SETUP.

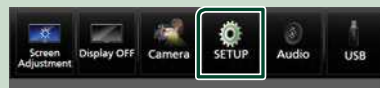

- SETUP Menu screen appears.

3 Touch Security.



- Security screen appears.

4 Touch Security Code Set on the Security screen.

- Security Code Set screen appears.

5 Enter a security code with 4 to 8 digits and touch Enter.



Basic Operations

- 6 Enter the same code again and touch **Enter**.

Now, your security code is registered.

NOTE

- This setting is available when demonstration mode is set to "OFF". (**P.86**)
- Touch **BS** to delete the last entry.
- If you enter a different security code, the procedure returns to step 5 (for first code entry).
- If you have disconnected the Receiver from the battery, enter the correct security code as that you have entered in step 5 and touch **Enter**. You can use your receiver.

To change the security code:

- 1 Touch **Security Code Change** on the Security screen.
 - Security Code Set screen appears.
- 2 Enter the current registered security code and touch **Enter**.
- 3 Enter a new security code with 4 to 8 digit number and touch **Enter**.
- 4 Enter the same code again and touch **Enter**.
 - The new security code is registered.

To clear the security code:

- 1 Touch **Security Code Cancellation** on the Security screen.
 - Security Code Set screen appears.
- 2 Enter the current registered security code and touch **Enter**.
 - The security code is cleared.

Calendar/clock settings

- 1 Press the **MENU** button.
 - Popup menu appears.

- 2 Touch **SETUP**.



- SETUP Menu screen appears.

- 3 Touch **User Interface**.



- User Interface screen appears.

- 4 Set each item as follows.

Scroll the page to show hidden items.

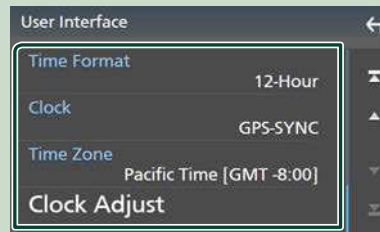

■ Time Format

Select the time display format.

12-Hour (Default)/**24-Hour**

■ Clock

GPS-SYNC (Default): Synchronizes the clock time with the GPS. (Except DDX819WBTL)

RDS-SYNC: Synchronizes the clock time with the RDS. (DDX819WBTL only)

Manual: Set the clock manually.

■ Time Zone

If you have selected **Manual** for Clock, select the time zone.

■ Clock Adjust

If you select **Manual** for Clock, adjust the date and time manually. (P.84)

NOTE

- Please set the date and time. If they are not set, some functions may not work.

Adjusting the volume

You can adjust the volume (0 to 40).
Press **▲** to increase, and press **▼** to decrease.
Holding **▲** increases the volume continuously to level 15.

DDX9906XR / DDX8906S / DDX8706S



DMX906S / DMX9706S



DDX819WBTL

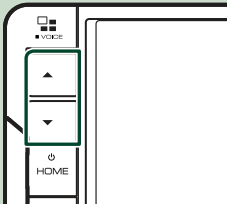

Display Adjustment (DDX9906XR / DDX8906S / DDX8706S / DDX819WBTL)

- 1 Press the **▲** button.
➤ Display Adjustment screen appears.
- 2 Select a tilt position you want to set up.
Default is "0".

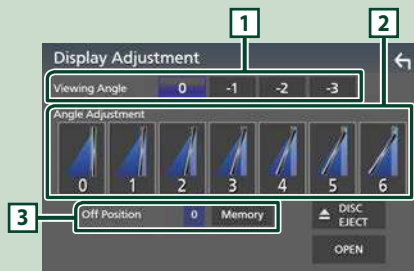

1 Viewing Angle

You can adjust the viewing angle when the image on the screen is difficult to see evenly. The smaller the (negative) value, the more whitish the image on the screen looks.
"0" (Default) / "-1" / "-2" / "-3"

2 Angle Adjustment

Select a tilt position you want to set up.
Default is "0".

3 Off Position

You can store the current monitor angle as the angle during power off. Touch **Memory** when the desired angle is selected.

Basic Operations

Viewing Angle (DMX906S / DMX9706S)

You can adjust the viewing angle when the image on the screen is difficult to see evenly. The smaller the (negative) value, the more whitish the image on the screen looks.

- 1 Press the **MENU** button.
➤ Popup menu appears.

- 2 Touch **SETUP**.

- 3 Touch **Display**.

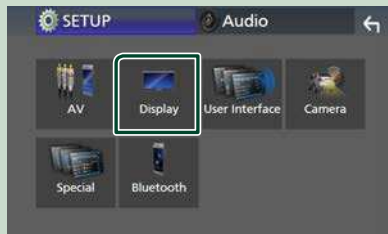

➤ Display screen appears.

- 4 Touch **Viewing Angle**.

- 5 Select an angle you want to set up.
Default is "0". (P.86)

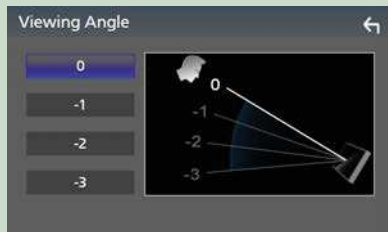

Touch screen operations

To perform operations on the screen, you need to touch, touch and hold, flick or swipe to select an item, display a setting menu screen or change pages.

● Touch

Touch the screen gently to select an item on the screen.

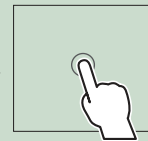

● Touch and hold

Touch the screen and keep your finger in place until the display changes or a message is displayed.

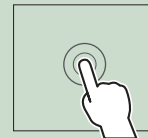

● Flick

Slide your finger quickly to the left or right on the screen to change the page. You can scroll a list screen by flicking up/down on the screen.



● Swipe

Slide your finger up or down on the screen to scroll the screen.

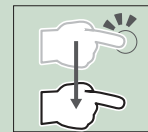

HOME screen descriptions

Most functions can be performed from the HOME screen.



- 1** • Widget (**P.18**)
 - You can change the widget by flicking left or right on the widget area.
 - Touch the widget to display the detailed screen.
- 2** • Displays the source selection screen. (**P.14**)
- 3** • Short-cut playback source icons (**P.15**)

Display the HOME screen

- 1** Press the **HOME** button.

DDX9906XR / DDX8906S / DDX8706S



DMX906S / DMX9706S



DDX819WBTL



➤ HOME screen appears.

Popup menu

- 1** Press the **MENU** button.
 - Popup menu appears.
- 2** Touch to display the popup menu.



The contents of the menu are as follows.

	• Displays the Screen Adjustment screen. (P.83)
	• Turns the display off. (P.14)
	• Displays the view camera screen. (P.78)
	• Displays the SETUP Menu screen. (P.83)
	• Displays the Audio screen. (P.90)
	• Displays the control screen of current source. Icon feature differs depending on the source. This icon is for USB source.
	• Close the popup menu.
1	• Short-cut source icons: The source changes to the one you have set with a short-cut. For the short-cut setting, refer to Customize Short-cut source icons on HOME screen (P.15) .

Basic Operations

Turn off the screen

- 1 Select **Display OFF** on the popup menu.



NOTE

- Touch the display to turn on the screen.
- To display the clock while the screen is off, it is necessary to set "OSD Clock" to "ON". (P.86)

Source selection screen description

You can display icons of all playback sources and options on the source selection screen.



















- | | |
|---|---|
| 1 | • Changes playback sources.
For playback sources, see P.14. |
| 2 | • Page indication |
| 3 | • Changes pages. (Touch ◀/▶.)
You can also change pages by flicking left or right on the screen. |
| 4 | • Returns to the previous screen. |
| 5 | • Displays the SETUP Menu screen. (P.83) |

Select the playback source

- 1 Press the **HOME** button.
➤ HOME screen appears.

- 2 Touch .

From the screen, you can select the following sources and functions.

	• Switches to the Apple CarPlay screen from the connected iPhone. (P.29)
	• Switches to the Android Auto screen from the connected Android device. (P.32)
	• Displays the Hands Free screen. (P.72) When neither Apple CarPlay, Android Auto, nor a Bluetooth Hands-Free phone is connected, displays Bluetooth pairing waiting dialog.*1 (P.67)
	• Switches to the Radio broadcast.*2 (P.45)
	• Switches to the HD Radio broadcast.*3 (P.48)
	• Switches to the SiriusXM® satellite radio broadcast.*4 (P.54)
	• Plays a Bluetooth audio player. (P.66)
	• Plays a disc.*5 (P.22)
	• Plays an iPod/iPhone. (P.42)
	• Plays files on a USB device. (P.39)
	• Switches to Pandora.*4 (P.36)
	• Switches to Spotify. (P.35)
	• Switches to an external component connected to the AV-IN input terminal.*6 (P.81)
	• Switches to the Wireless Mirroring screen from the connected iPhone/Android device.*4 (P.29)
	• Displays the Audio screen. (P.90)
	• Puts the unit in standby. (P.15)

- For sources and information displayed when an ADS adapter is connected, see **OEM Features Operation (P.82)**.

*1 When connecting as Apple CarPlay or Android Auto, it works as a phone provided in Apple CarPlay or Android Auto. If Apple CarPlay or Android Auto are connected during talking by the Bluetooth device or iDataLink phone, the current call will be continued.

*2 DDX8706S / DDX819WBTL / DMX9706S only

*3 DDX9906XR / DDX8906S / DMX906S only

*4 Except DDX819WBTL

*5 DDX9906XR / DDX8906S / DDX8706S / DDX819WBTL only

*6 CA-C3AV (optional accessory) is connected to the AV-IN input terminal for visual. (P.109)

To select the playback source on the HOME screen



The 4 items displayed on the source selection screen with large icons are shown on the HOME screen.

You can change the items displayed on this area by customizing the source selection screen. (P.15)

To select the playback source on the source control screen

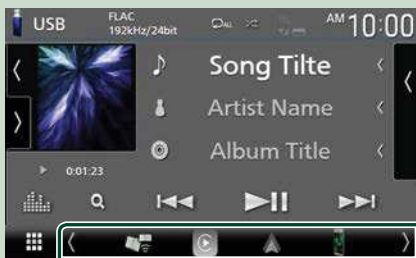

Display source selection icons by touching [Left Arrow] / [Right Arrow] or flicking left or right on the source control screen, then select a playback source.

Put the unit in standby

- 1 Press the **HOME** button.
➤ HOME screen appears.
- 2 Touch .
- 3 Touch **STANDBY**.

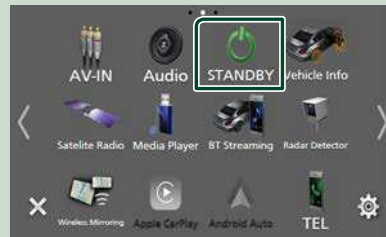

Customize Short-cut source icons on HOME screen

You can arrange the positions of the source icons as you like.

- 1 Press the **HOME** button.
➤ HOME screen appears.
- 2 Touch .
- 3 Touch and hold the icon which you want to move in the customizing mode.
- 4 Drag the icon to the desired position.



Changes the page



Basic Operations

Source control screen descriptions

There are some functions which can be performed from most screens.

Indicators

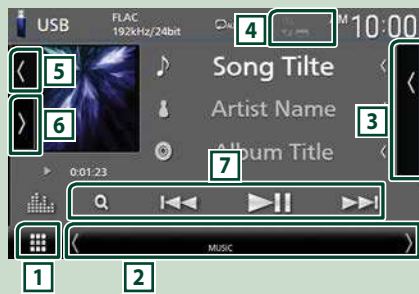

Short-cut source icons



1 All sources icon

Displays the source selection screen. (P.14)

2 Secondary screen

- **</>**: The Secondary screen changes to another one every time you touch it. You can also change the Secondary screen by flicking left or right on the screen.
- **Indicators**: Displays the current source condition and so on.
 - **ATT**: The attenuator is active.
 - **DUAL**: The dual zone function is active.
 - **MUTE**: The mute function is active.
 - **LOUD**: The loudness control function is active.
- **Short-cut source icons**: The source changes to the one you have set with a short-cut. For the short-cut setting, refer to **Customize Short-cut source icons on HOME screen (P.15)**.

3 Content list

Displays the track/file/station/channel list.



- Connected Bluetooth device information.

5 Artwork & information

You can select whether to display an artwork and song information or only song information in more detail.

Touching the artwork area switches to the VU meter. (The Disc, USB, iPod, Bluetooth audio sources only)

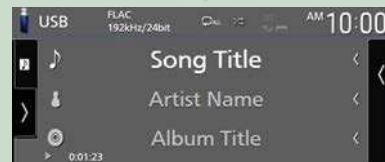
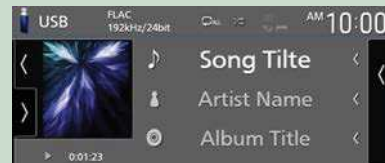

Change the text size of song information smaller when the "Small Audio Text" is set to "ON" in the User Interface screen (P.84).

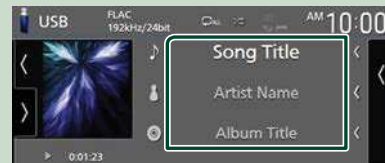

6 Function panel

Touch the left side of the screen to display the function panel. Touch again to close the panel.

7 Operation keys

You can operate the current source with these operation keys. The available functions are different depending on the source type.

List screen

There are some common function keys in the list screens of most sources.
See (P.26, 41, 43, 72).

Display the list screen

For Disc media/USB/iPod:

- 1 Touch **Q** or the item listed on the information area in the source control screen.
 > The list screen appears.

For Bluetooth audio:

- 1 Touch **Q**.
 > The list screen appears.

You can use following operation keys from this screen.

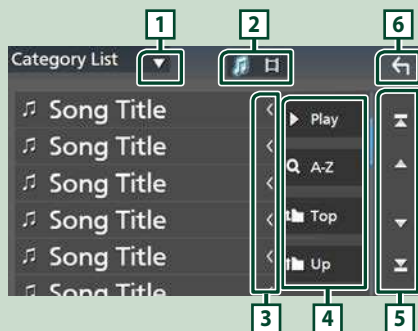

- 1 Displays the list type selection window.

- 2 Displays a music/movie file list.

- 3 **Text scroll**
Scrolls the displayed text.

- 4 **Play etc.**

Keys with various functions are displayed here.

- **Play**: Plays all tracks in the folder containing the current track.
- **Q A-Z**: Jumps to the letter you entered (alphabetical search).
- **Top Up**: Moves to the upper hierarchy level.

- 5 **Page scroll**

You can change pages to display more items by pressing .

- : Displays the top or bottom page.

- 6 **Return**

Returns to the previous screen.

NOTE

- Depending on the current source or mode, some function key may not appear.

Widget

Widget

Widget

- 1 Press the **HOME** button.
- 2 You can change the widget by flicking left or right on the widget area.



Widget list

- Multi Widget *1
- Clock Widget
- Tire Pressure Widget *2
- Rader Widget *2
- Climate Widget *2
- Photo Frame Widget

*1 Up to 3 pages can be set to the multi widget screen.
*2 This can be selected when a compatible ADS adapter is connected. (Except DDX819WBTL)

Multi Widget

You can place a widget on each of the following areas. Up to 4 widgets can be placed per a multi widget screen.

- 1 Press the **HOME** button.
- 2 Flick the widget area to the left/right to display the multi widget.



1 Widget (L)

2 Widget (M)

3 Widget (S1)

4 Widget (S2)

Replace the widget

● To move the widget

- 1 Touch and hold the widget.
➤ Widget customize mode is activated.
- 2 Drag the widget to the desired position.

● To delete the widget

- 1 Touch and hold the widget.
➤ Widget customize mode is activated.
- 2 Touch **×** on the right top corner of the widget.
➤ The selected widget is deleted.

● **To replace the widget**

1 Touch  on the multi widget screen.



➤ Widget list popup appears.

1 **Widget icon**

The widgets which can be placed to the multi widget screen are listed.

2 Flick the widget list popup to the left/right to select the widget to replace.

3 Touch and hold the new widget.

➤ Widget customize mode is activated.

4 Drag the widget from the widget list popup to the desired widget area.

You can set up following items.

- Clock Widget
- Compass Widget
- Current source information *1
- Visualizer Widget
- Mirroring Widget *2 *3
- Photo Frame Widget
- Climate Widget *4
- Radar Widget *4
- Tire Pressure Widget *4



*1 You cannot display the screen of Wireless Mirroring on this widget. To display the screen of the source, select the Mirroring Widget.

*2 This can be selected when using Wireless Mirroring.

*3 You cannot play the audio/video file on the USB/Disc media when using Wireless Mirroring.

*4 This can be selected when a compatible ADS adapter is connected. (Except DDX819WBTL)

NOTE

-  and the widget list popup disappear when no operation is done for 5 seconds.
- When the screen is switched from another widget to multi widget screen,  appears again.

 **Add a new multi widget**

You can add pages to the multi widget screen.

1 Touch  on the multi widget screen.

➤ Widget list popup appears.



Displays confirmation message to delete the current page from the multi widget screen. For details, see **To delete the multi widget (P.19)**.



Adds a page to the multi widget screen.

2 Touch  on the widget list popup.

➤ A new page is added.

NOTE

- You can add up to 2 pages to the multi widget screen. If you have already added 2 pages, you cannot select .
- The widget list popup is displayed on the new page until you place a widget to.

To delete the multi widget

1 Touch  on the widget list popup.

➤ Confirmation message appears.

2 Touch **YES**.

➤ Current page is deleted.

NOTE

- You cannot delete the first page of the multi widget screen.

Widget

Photo Frame Widget

You can display a slideshow of the image files stored in the USB memory on the Home screen.

Preparation

- Select "ON" for Photo Frame Widget. See **Widget Setup (P.20)**.

Acceptable Picture files

	Max. Picture size
JPEG (.jpg, .jpeg) *1	5,000 × 5,000
PNG (.png)	1,000 × 1,000
BMP (.bmp)	1,000 × 1,000

- This unit can only play back files which are less than 50 MB.
- The maximum number of files per device is 500.
- Picture files may not be played depending on their condition.

*1 A progressive format is not supported.

Photo Frame

- 1 Press the **HOME** button.
- 2 Flick the widget area to the left/right to display the photo frame widget.



- Scroll the screen to display the hidden part.

Widget Setup

Set up the widgets on the Home screen.

- 1 Press the **MENU** button.
 - Popup menu appears.
- 2 Touch **SETUP**.
 - SETUP screen appears.
- 3 Touch **User Interface**.



- User Interface screen appears.

- 4 Touch **Widget SETUP** in the User Interface screen.

- 5 Set each item as follows.

Photo Frame Widget

Determine whether to use the photo frame widget.

"ON" (Default)/"OFF"

Photo Frame SETUP

Make settings related to display of the photo frame widget.

- 6 Touch .

To Photo Frame Setup

Make settings related to display of the photo frame widget.

1 Touch **Photo Frame SETUP** on the Widget SETUP screen.

2 Set each item as follows.

■ **Sort Order**

Specify a file sorting criterion.

"By Name(Ascending)"/

"By Name(Descending)"/

"By Date(Newest First)"(Default)/

"By Date(Oldest First)"

■ **Slide Show Interval**

Specify the slideshow interval.

"5" to "30" seconds.

Default is "5" seconds.

■ **Photo Frame is**

Display help topics about the photo frame.

3 Touch  .

Disc (DDX9906XR / DDX8906S / DDX8706S / DDX819WBTL)

Playing a disc

Insert a disc

- 1 Press the **▲** button.

DDX9906XR / DDX8906S / DDX8706S

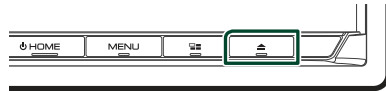

DDX819WBTL



- 2 Touch **DISC EJECT**.

➤ The panel opens.

- 3 Insert the disc into the slot.

DDX9906XR / DDX8906S / DDX8706S

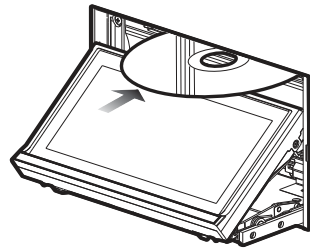

DDX819WBTL

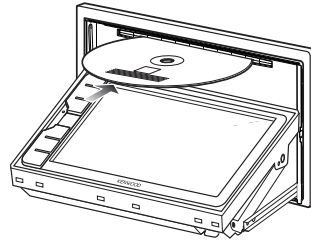

➤ The panel closes automatically.
The unit loads the disc and playback starts.

Eject a disc

- 1 Press the **▲** button.

- 2 Touch **DISC EJECT**.

When removing a disc, pull it horizontally.

- 3 Press the **▲** button.

➤ The panel closes.

NOTE

- To forcibly eject the disc, press and hold the **▲** button for 2 seconds and then touch **DISC EJECT** after the message is displayed.

DVD/VCD Basic Operation

Most functions can be controlled from the source control screen and playback screen.

NOTE

- Set the remote control mode switch to DVD mode before starting operation for DVD and VCD, see **Switch the operation mode (P.99)**.
- The screen shot below is for DVD. It may be different from the one for VCD.

- 1 When the operation buttons are not displayed on the screen, touch [7] area.

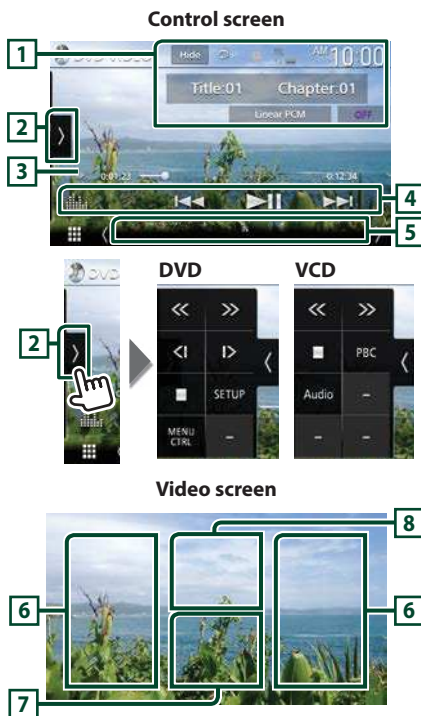

1 Information display area

Displays the following information.

- **Title #, Chapter #:** DVD title and chapter number
- **Track #/Scene #:** VCD track or scene number. Scene # is displayed only when Playback control (PBC) is on.

- **Linear PCM, etc.:** Audio format
- **OFF/Zoom2 – 4 (DVD)/Zoom2 (VCD):** Displays the zoom ratio. This function can be used from the remote control. **(P.99)**
- **Hide:** Hides the control screen.
- **[Repeat Icon]:** Repeats the current content. Each time you touch the key, repeat modes are switched in the following sequence;
 - DVD:** Title repeat ([Title Repeat Icon]), Chapter repeat ([Chapter Repeat Icon]), Repeat off ([Repeat Off Icon])
 - VCD (PBC On):** Does not repeat
 - VCD (PBC Off):** Track repeat ([Track Repeat Icon]), Repeat off ([Repeat Off Icon])

2 Function panel

Touch the left side of the screen to display the function panel. Touch again to close the panel.

- **[Stop Icon]:** Stops playback. Touching twice will play the disc from the beginning when you play it next time.
- **[Fast Forward/Backward Icons]:** Fast-forwards or fast-backward the disc. Each time you touch the key, the speed changes. 2 times, 10 times.
- **[Slow Forward/Backward Icons (DVD only):]** Plays in slow motion forward or backward.
- **SETUP (DVD only):** Touch to display the DVD SETUP screen. See **DVD Setup (P.27)**.
- **MENU CTRL (DVD only):** Touch to display the DVD-VIDEO disc menu control screen. See **DVD Disc Menu Operation (P.26)**.
- **PBC (VCD only):** Touch to turn Playback control (PBC) on or off.
- **Audio (VCD only):** Touch to change audio output channels.

3 Play mode indicator/Playing time

- **[Play Mode Icons]:** Current play mode indicator. Meanings of the icons are as follows:
 - ▶ (play), ▶▶ (fast forward), ◀◀ (fast backward), ■ (stop), R (resume stop), || (pause), |▶ (slow playback), ◀| (slow reverse playback).
- For confirmation of current playing position. You can drag the circle left or right to change the playing position.



Disc

4 Operation keys

- **◀◀ ▶▶** : Searches for the previous/next content.
Touch and hold to fast-forward or fast-backward the disc. (It will be cancelled automatically after about 50 seconds.)
- **▶||** : Plays or pauses.
- **📊** : Displays the Graphic Equalizer screen. **(P.93)**

5 Indicator Items

- **IN** : Disc insertion status.
White: A Disc is inside the unit.
Orange: Disc player failure.

VCD

- **1chLL/2chLL** : Identifies the left audio output of channel 1 or 2.
- **1chLR/2chLR** : Identifies the monaural audio output of channel 1 or 2.
- **1chRR/2chRR** : Identifies the right audio output of channel 1 or 2.
- **1chST/2chST** : Identifies the stereo audio output of channel 1 or 2.
- **LL** : Identifies the left audio output.
- **LR** : Identifies the monaural audio output.
- **RR** : Identifies the right audio output.
- **ST** : Identifies the stereo audio output.
- **PBC** : The PBC function is on.
- **VER1** : The VCD version is 1.
- **VER2** : The VCD version is 2.

6 Searching area

Touch to search for the next/previous content.

7 Key display area

Touch to display the control screen.

8 MENU CTRL (DVD only)

Touch to display the DVD-VIDEO disc menu control screen. See **DVD Disc Menu Operation (P.26)**.

NOTE

- The control screen disappears when no operation is done for 5 seconds.
- If you use a remote control, you can jump directly to the desired image by entering the chapter number, scene number, play time, etc. **(P.99)**.







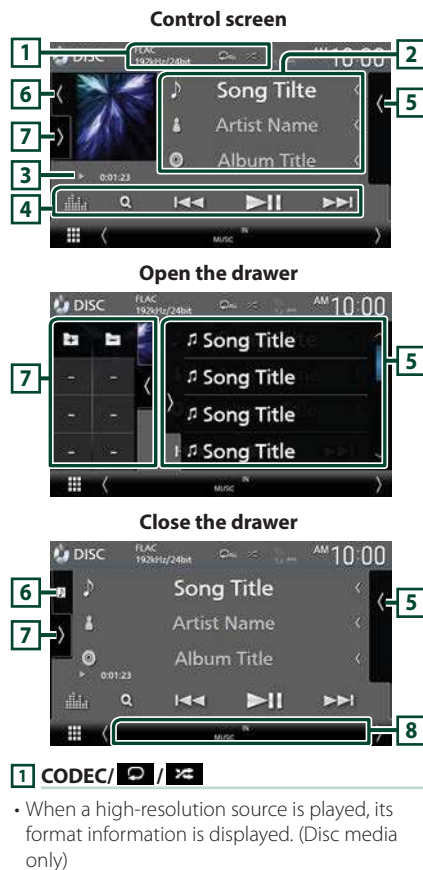

Music CD/Disc media Basic Operation

Most functions can be controlled from the source control screen and playback screen.

NOTE

- Set the remote controller mode switch to AUD mode before starting operation for Music CD and audio files, see **Switch the operation mode (P.99)**.
- In this manual, "Music CD" means a general CD which includes music tracks.
"Disc media" means a CD/DVD disc which includes audio or video files.
- The screen shot below is for disc media. It may be different from the one for CD.









-  : Repeats the current track/folder. Each time you touch the key, repeat mode switches in the following sequence; Track/File repeat (), Folder repeat () (Disc media only), Repeat all ()
-  : Randomly plays all tracks in current folder/disc. Each time you touch the key, random mode switches in the following sequence; Track random () (Music CD only), Folder random () (Disc media only), Random off ()

2 Track information





- Displays the information of the current track/file. Only a file name and a folder name are displayed if there is no tag information. (Disc media only)
- Change the text size of the information smaller when the "Small Audio Text" is set to "ON" in the User Interface screen (P.84).

3 Play mode indicator/Playing time

- , , etc.: Current play mode indicator. Meanings of the icons are as follows:  (play),  (fast forward),  (fast backward),  (pause).
- For confirmation of current playing position. You can drag the circle left or right to change the playing position. (Video file only)



4 Operation keys

-  (Disc media only) : Searches files. For details on search operation, see **File search Operation (P.26)**.
- ,  : Searches for the previous/next content. Touch and hold to fast-forward or fast-backward the disc. (It will be cancelled automatically after about 50 seconds.)
-  : Plays or pauses.
-  : Displays the Graphic Equalizer screen. (P.93)

5 Content list



- Touch the right side of the screen to display the Content list. Touch again to close the list.
- Displays the playing list. When you touch a track/file name on the list, playback will start.

6 Artwork/VU meter

- Displays/hides artwork area.
- The jacket of the currently playing file is displayed. (Disc media only)
- Touch to switch between the artwork and VU meter.

7 Function panel (Disc media only)

Touch the left side of the screen to display the function panel. Touch again to close the panel.

-   : Searches for the previous/next folder.

8 Indicator Items

- **IN** : Disc insertion status.
White: A Disc is inside the unit.
Orange: Disc player failure.
- **VIDEO** : Identifies the video file.
- **MUSIC** : Identifies the music file.

Video screen



9 File search area (Video file only)

Touch to search for the next/previous file.

10 Key display area (Video file only)

Touch to display the control screen.

Disc

File search Operation (Disc media only)

You can search for a file according to hierarchy.

NOTE

- For operations in the list screen, see **List screen (P.17)**.

- 1 Touch **Q**.
 - Folder List screen appears.
- 2 Touch the desired folder.

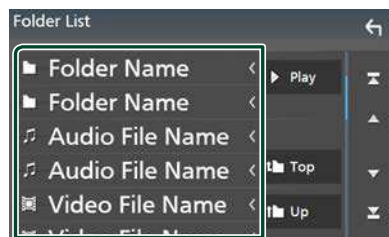

- When you touch a folder its contents are displayed.

- 3 Touch the desired item in the content list.
 - Playback starts.

DVD Disc Menu Operation

You can set up some functions using the DVD-VIDEO disc menu.

- 1 Touch the framed area during playback.



- Menu Control screen appears.

- 2 Perform your desired operation as follows.



■ To display the top menu

Touch **TOP**.

■ To display the menu

Touch **MENU**.

■ To display the previous menu

Touch **Return**.

■ To enter selected item

Touch **Enter**.

■ To enable direct operation

Touch **Highlight** to enter the highlight control mode (P.27).

■ To move the cursor

Touch **▲**, **▼**, **◀**, **▶**.

■ To switch among subtitle languages

Touch **Subtitle**. Each time you touch this key, subtitle languages are switched.

■ To switch among audio languages

Touch **Audio**. Each time you touch this key, audio languages are switched.

■ To switch among picture angles

Touch **Angle**. Each time you touch this key, picture angles are switched.

* These keys may not function depending on the disc.

■ Highlight control

Highlight control lets you control the DVD menu by touching the menu key directly on the screen.

1 Touch **Highlight** on the Menu Control screen.

2 Touch your desired item on the screen.



NOTE

- The highlight control function is cancelled automatically if you do not operate for a predetermined period of time.

DVD Setup

You can set up the DVD playback functions.

1 Touch the framed area during playback.



2 Touch **SETUP** on the left side of the screen. Touch **SETUP**.



► DVD SETUP screen appears.

3 Set each function as follows.



■ Menu Language/Subtitle Language/Audio Language

See **Language setup (P.28)**.

■ Dynamic Range Control

Sets the dynamic range.

Wide: The dynamic range is wide.

Normal: The dynamic range is normal.

Dialog (Default): Makes the total sound volume larger than the volumes in other modes. This is effective only when the Dolby Digital software is in use.

Disc

■ Screen Ratio

Sets the screen display mode.

16:9 (Default): Displays wide pictures.

4:3 LB: Displays wide pictures in the Letter Box format (having black stripes at the top and bottom of screen).

4:3 PS: Displays wide pictures in the Pan & Scan format (showing pictures cut at the right and left ends).

■ Language setup

This setting is for the languages used for the menu, subtitle, and voice.

- 1 Touch the desired item;
Menu Language, Subtitle Language, Audio Language.
➤ Language Set screen appears.
- 2 Select a language.

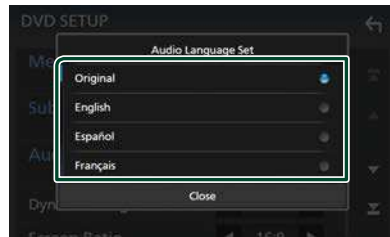

For language codes, refer to **DVD Language Codes (P.120)**.

Touch Close to set the entered language and return to the DVD SETUP screen.

NOTE

- To set the DVD's original language as the audio language, touch **Original**.

APPS

Wireless Mirroring Operation (Except DDX819WBTL)

You can display the same screen of the Android device on the monitor of the unit using the Wireless Mirroring function of the Android device.

Preparation

- You can use the Wireless Mirroring function with Android devices compatible with this function.
- This function may be called Wireless Display, Screen Mirroring, AllShare Cast, etc., depending on the manufacturer.
- The settings on the Android device differ depending on the device type. For details, refer to the instruction manual supplied with your Android device.
- If your Android device is locked, Mirroring screen may not appear.
- If the Android device is not ready for UIBC, you cannot perform touch operation.

- 1 Press the **HOME** button.
- 2 Touch .
- 3 Touch **Wireless Mirroring**. (P.14)
➤ The App screen is displayed.
- 4 Operate your Android device to activate the Wireless Mirroring function, then connect to this unit.
- 5 Select ("DDX****"/"DMX****") as the network to use.
➤ When the connection is established, then the same screen displayed on the Android device is displayed.

NOTE

- Apps is discontinued when the power is turned ON/OFF or you leave the vehicle. To restart Apps, operate the Android device.
- When the Apps source is displayed, you cannot register or reconnect a Bluetooth device. Switch the Apps source to another source, and then operate the Bluetooth device.
- When the device is connected as Wireless Mirroring device, the USB/Disc media sources are not available. To select the USB/Disc media sources as the playback source, disconnect the Wireless Mirroring connection.

Apple CarPlay Operation

Apple CarPlay is a smarter, safer way to use your iPhone in the car. Apple CarPlay takes the things you want to do with iPhone while driving and displays them on the screen of the product. You can get directions, make calls, send and receive messages, and listen to the music from iPhone while driving. You can also use Siri voice control to make it easier to operate iPhone.

For details about Apple CarPlay, visit <https://apple.com/ios/carplay/>.

Compatible iPhone devices

You can use Apple CarPlay with the following iPhone models.

- iPhone X
- iPhone 8 Plus
- iPhone 8
- iPhone 7 Plus
- iPhone 7
- iPhone SE
- iPhone 6s Plus
- iPhone 6s
- iPhone 6 Plus
- iPhone 6
- iPhone 5s
- iPhone 5c
- iPhone 5

Connecting an iPhone

Wired connection

- 1 Connect your iPhone using KCA-iP103 via the USB (Black) terminal. (P.111)

When an iPhone compatible with Apple CarPlay is connected to the USB (Black) terminal, the Bluetooth Hands-Free phone currently connected is disconnected. If the Bluetooth Hands-Free phone is being used, disconnection will occur after ending the call.

- 2 Unlock your iPhone.

APPS

Wireless connection (Except DDX819WBTL)

You can select the iPhone registered as the Bluetooth device from **Apple CarPlay Device List** and use it as the Apple CarPlay device.

Preparation

- To register an iPhone by the connection via the USB (Black) terminal
 - Connect an iPhone via the USB (Black) terminal and operate the iPhone according to the confirmation messages displayed on the iPhone. The iPhone is registered in **Apple CarPlay Device List**. Removing the iPhone from the USB (Black) terminal and selecting the registered iPhone from **Apple CarPlay Device List**, the iPhone will be connected wirelessly.
- To register an iPhone by the connection via Bluetooth
 - Touching  on the **Apple CarPlay Device List** screen (P.30), displays Bluetooth pairing waiting dialog. Referring to **Register the Bluetooth device (P.67)** and registering the iPhone, the iPhone will be connected wirelessly.

- 1 Press the **HOME** button.
- 2 Touch .
- 3 Touch **Apple CarPlay**. (P.14)

NOTE

- Turn on the Bluetooth function and Wi-Fi function of an iPhone.
- If two or more iPhones have been registered, select the iPhone to be used as the **Apple CarPlay** source. (P.30)
- You can also select the iPhone registered in **Apple CarPlay Device List (P.30)** even when the **Apple CarPlay** icon is not activated on the source selection screen.
- It is necessary to connect the GPS antenna and the speed pulse input in order to use a wireless Apple CarPlay.

To switch the Current Screen to the Apple CarPlay Screen When Connecting Your iPhone

- Touch **Apple CarPlay** icon on the source selection screen. (P.14)
- Touch the following connection message if the message appears.



NOTE

- The connection message appears when;
 - The iPhone you used previously is connected again.
 - The screen other than HOME and the source selection screen is displayed.
- The connection message is displayed for about 5 seconds.

Select an Apple CarPlay device

If two or more iPhones compatible with Apple CarPlay have been registered, select the iPhone to be used as the Apple CarPlay source.



- 1 Press the **MENU** button.
 - Pop up menu appears.
- 2 Touch **SETUP**.
 - SETUP screen appears.
- 3 Touch **AV**.

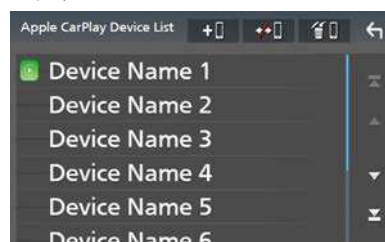

- 4 Touch **Apple CarPlay Device List**.
- 5 Select a device.

The Apple CarPlay device connected via the USB and the registered Apple CarPlay devices ready for wireless connection are displayed.



-  : Displays a Bluetooth pairing waiting dialog. For details, see **Register the Bluetooth device (P.67)**.
-  : Displays confirmation message to disconnect the device.
-  : Displays Device Remove screen. (P.31)

To delete the registered Apple CarPlay device

- 1 Touch .
- 2 Touch the device name to check.

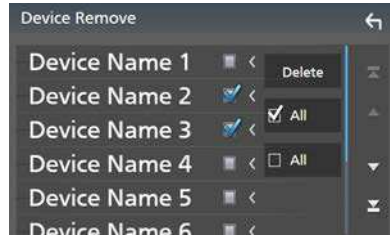

- ALL**
Selects all Apple CarPlay devices.
- ALL**
Clears all check marks.

- 3 Touch **Delete**.
➤ Confirmation message appears.
- 4 Touch **Yes**.
➤ All the selected device(s) is deleted.

NOTE

- This operation also deletes the same device(s) from the Bluetooth device list screen. **(P.69)**

Operation buttons and available Apps on the home screen of Apple CarPlay

You can use the Apps of the connected iPhone. The items displayed and the language used on the screen differ among the connected devices.

To enter the Apple CarPlay mode, touch **Apple CarPlay** icon on the source selection screen. **(P.14)**



- 1 
 - Displays the home screen of Apple CarPlay.
 - Touch and hold to activate Siri.
- 2 **Application buttons**
Starts the application.
- 3 **HOME**
Exits the Apple CarPlay screen and displays the Home screen.

To exit the Apple CarPlay screen

- 1 Press the **HOME** button.

Use Siri

You can activate Siri.

- 1 Press the  button for 1 second.

DDX9906XR / DDX8906S / DDX8706S

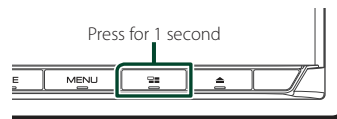

DMX906S / DMX9706S

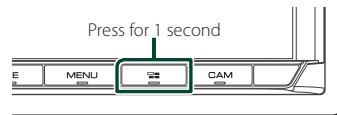

APPS

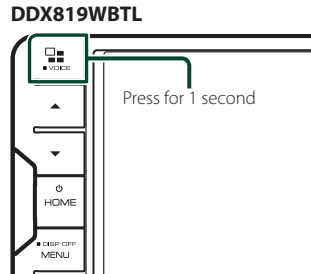

2 Talk to Siri.

To deactivate

1 Press the  button.

 **Switch to the Apple CarPlay screen while listening to another source**

1 Press the  button.

DDX9906XR / DDX8906S / DDX8706S



DMX906S / DMX9706S



DDX819WBTL

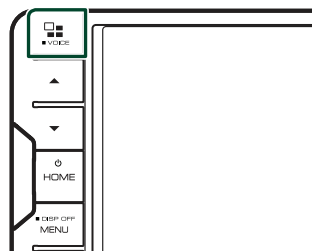

NOTE

- When listening to another source with the Apple CarPlay screen displayed, playing music in the Apple CarPlay mode will switch the current source to the Apple CarPlay source.

Android Auto™ Operation

Android Auto enables you to use the functions of your Android device convenient for driving. You can easily access route guidance, make calls, listen to music, and access convenient functions on the Android device while driving. For details about Android Auto, visit <https://www.android.com/auto/> and <https://support.google.com/androidauto>.

Compatible Android devices

You can use Android Auto with Android devices of Android version 5.0 (Lollipop) or later.

For Wi-Fi connection, Android 8.0 (Oreo) or later.

NOTE

- Android Auto may not be available on all devices and may not be available in all countries or regions.

● About the placement of smartphone

Install the smartphone connected as Android Auto device in the place where it can receive the GPS signals.

When using Google Assistant, install the smartphone in the place where the smartphone easily catch a voice by the microphone.

NOTE

- Do not put the smartphone in a spot exposed to direct sunlight or near an air blowing out port of an air conditioner. The placement of the smartphone in such places can lead to malfunction or damage of your smartphone.
- Do not leave the smartphone in the vehicle.

■ Connect Android device

Wired connection

- 1 **Connect an Android device via the USB terminal. (P.112)**
To use the hands-free function, connect the Android device via Bluetooth.
When an Android device compatible with Android Auto is connected to the USB terminal, the device is connected via Bluetooth automatically, and the Bluetooth Hands-Free phone currently connected is disconnected.
- 2 **Unlock your Android device.**
- 3 **Press the HOME button.**
- 4 **Touch .**
- 5 **Touch Android Auto . (P.14)**

Wireless connection (Except DDX819WBTL)

When the Android device is ready for wireless connection, connecting it via the USB registers Bluetooth and Wi-Fi automatically. Thus, the registered Android device will be able to be connected wirelessly to be used as an Android Auto source.

- 1 **Press the HOME button.**
- 2 **Touch .**
- 3 **Touch Android Auto . (P.14)**

NOTE

- Turn on the Bluetooth function and Wi-Fi function of Android device.
- If two or more Android devices have been registered, select the Android device to be used as the Android Auto source. (P.33)

■ Select an Android device (Except DDX819WBTL)

If two or more Android devices have been registered, select the Android device to be used as the Android Auto source.

- 1 **Press the HOME button.**
- 2 **Touch .**
- 3 **Touch Android Auto . (P.14)**
- 4 **Select an Android device.**
The registered Android devices ready for wireless connection and the Android device connected via the USB are displayed.

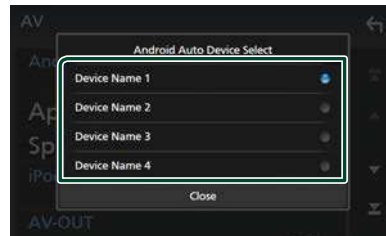

■ Operation buttons and available Apps on the Android Auto screen

You can perform the operations of the Apps of the connected Android device.

The items displayed on the screen differ among the connected Android devices.

To enter the Android Auto mode, touch the **Android Auto** icon on the source selection screen. (P.14)

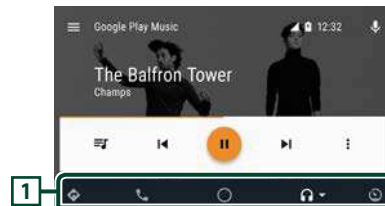

1 Application/information buttons

Starts the application or displays information.

APPS

To exit the Android Auto screen

- 1 Press the **HOME** button.

Using voice control

- 1 Press the  button for 1 second.

DDX9906XR / DDX8906S / DDX8706S

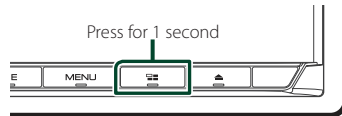

DMX906S / DMX9706S

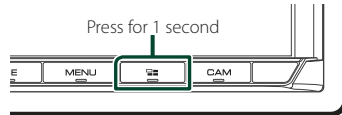

DDX819WBTL

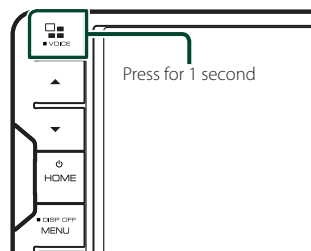

To cancel

- 1 Press the  button.

Switch to the Android Auto screen while listening to another source

- 1 Press the  button.

DDX9906XR / DDX8906S / DDX8706S



DMX906S / DMX9706S



DDX819WBTL

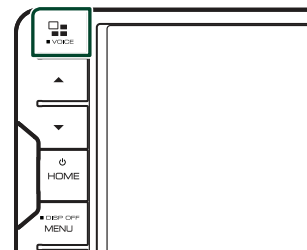

NOTE

- When listening to another source with the Android Auto screen displayed, playing music in the Android Auto mode will switch the current source to the Android Auto source.

Spotify Operation

You can listen to Spotify on this unit by controlling the application installed in the iPhone or Android.

To select the Spotify source, touch **Spotify** icon on the source selection screen. (P.14)

Preparation

- Install the latest version of the Spotify application "Spotify" on your iPhone or Android.
- **iPhone:** Search for "Spotify" in the Apple App Store to find and install the most current version.
- **Android:** Search for "Spotify" in Google play to find and install the most current version.
- iPhones are connected via either USB or Bluetooth.
- Android devices are connected via Bluetooth.
- To connect a smartphone via Bluetooth, register it as the Bluetooth device and do the App (SPP) profile setting for the connection beforehand. See **Register the Bluetooth device (P.67)** and **Connect the Bluetooth device (P.68)**.
- When an Apple CarPlay is connected, you can use Spotify.

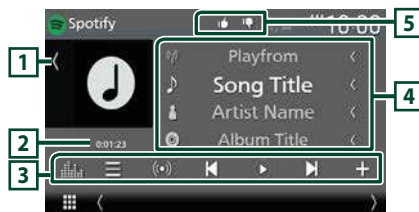

Close the drawer

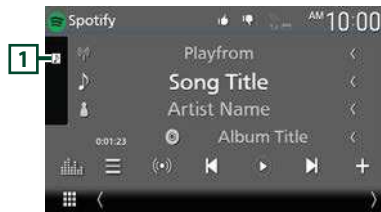

1 Artwork

- Displays/hides artwork area.
- Picture data is displayed if available from the current content.

2 Playing time

- For confirmation of play time.

3 Operation keys

- : Displays the Station list screen.
- : New radio station that relates to the artist of the currently being played song is selected and playback starts.
- , : Skips the current song. (Note that this function is disabled when the Spotify skip limitation is exceeded.)
- : Plays or pauses the content of the current station.
- : Saves the currently being played song to My Music.
- : Displays the Graphic Equalizer screen. (P.93)

4 Content information

- Displays the information on the current content being played.
- Change the text size of the information smaller when the "Small Audio Text" is set to "ON" in the User Interface screen (P.84).

5 / / /

- : Thumbs down to the current contents and skips to the next content.
- : Registers the current content as a favorite content.
- : Repeats the current song.
- : Randomly plays all songs in the current playlist.

Selecting a track

- 1 Touch .
➤ Station list screen appears.
- 2 Select the list type, then select a desired item.

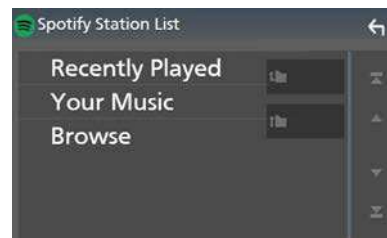

To select the category and station

Touch the category and station name in the list.

APPS

■  **Top**
Returns to the top of the list.

■  **Up**
Returns to the previous list.

About Spotify®

Note

- Ensure you are logged in to your smartphone application. If you do not have an Spotify account, you can create one for free from your smartphone or at www.spotify.com.
- Because Spotify is a third-party service, the specifications are subject to change without prior notice. Accordingly, compatibility may be impaired or some or all of the services may become unavailable.
- Some functions of Spotify cannot be operated from this unit.
- For issues on using the application, contact Spotify at www.spotify.com.
- Establish an Internet connection.

Pandora® Operation (Except DDX819WBTL)

You can listen to Pandora® on this unit by controlling the application installed in the iPhone or Bluetooth device.

To select the Pandora source, touch the **Pandora** icon on the source selection screen. **(P.14)**

Preparation

- Install the latest version of the Pandora® application on your iPhone, Android or BlackBerry.
iPhone: Search for "Pandora" in the Apple App Store to find and install the most current version.
Android: Visit the Google play and search for Pandora to install.
BlackBerry: Visit www.pandora.com from the built in browser to download the Pandora application.
- iPhones are connected via either USB or Bluetooth.
- Android or BlackBerry devices are connected via Bluetooth.
- To connect a smartphone via Bluetooth, register it as the Bluetooth device and do the App (SPP) profile setting for the connection beforehand. See **Register the Bluetooth device (P.67)** and **Connect the Bluetooth device (P.68)**.
- When an Apple CarPlay is connected, you can use Pandora.

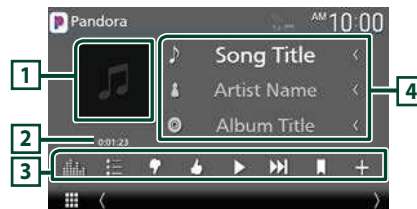



1 Artwork

Picture data is displayed if available from the current content.

2 Playing time

For confirmation of play time.

3 Operation keys

-  : Searches for a station. For details on searching, see **Station list screen (P.37)**.
-  (Thumbs down) : Thumbs down to the current contents and skips to the next contents.

- (Thumbs up) : Registers the current content as a favorite content.
- : Plays or pauses the content of the current station.
- : Skips the current song.
(Note that this function is disabled when the Pandora skip limitation is exceeded.)
- (Bookmark Song) : Bookmarks a song in the current contents.
- : Creates a new station. See **Creates a new station (P.37)**.
- : Displays the Graphic Equalizer screen. **(P.93)**

4 Content information

- Displays the information on the current content being played.
- Change the text size of the information smaller when the "Small Audio Text" is set to "ON" in the User Interface screen **(P.84)**.

Station list screen

You can perform the following functions from this screen.

1 Touch .

➤ Station List screen appears.

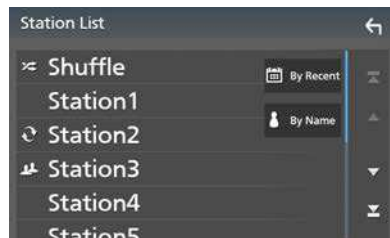

■ **To select the station**

Touch the station name in the list.

■ **To sort the list by played date**

Touch **By Recent**. The list is sorted to begin with the last played station.

■ **To sort the list in alphabetical order**

Touch **By Name**. You can select the desired letter from the list which corresponds to the station name to help narrow the search range.

NOTE

- You can operate Pandora by using the remote control function. However, you can perform only play, pause, and skip operations.

Creates a new station

1 Touch .

2 Touch your desired item.

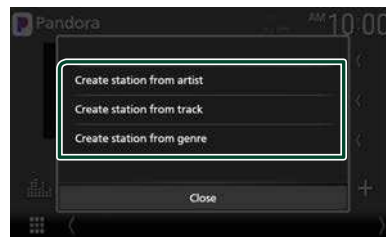

■ **Create station from artist**

Creates a new station based on the artist who is playing now.

■ **Create station from track**

Creates a new station based on the song being played.

■ **Create station from genre**

Displays the genre list screen.

Genre list screen

1 Touch **Create station from genre.**

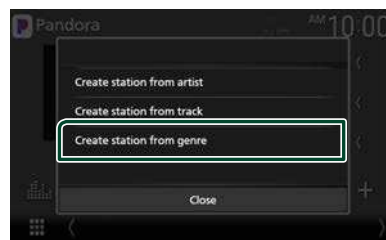

APPS

2 The selected genre is created as a new station.

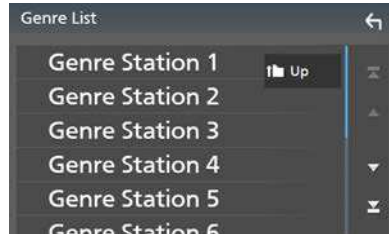

About Pandora®

NOTE

- In the application on your device, log in and create an account with Pandora.
(If you are not already a registered user, an account can also be created at www.pandora.com.)
- Establish an Internet connection.
- Pandora is only available in certain countries. Please visit <http://www.pandora.com/legal> for more information.
- Because Pandora® is a third-party service, the specifications are subject to change without prior notice. Accordingly, compatibility may be impaired or some or all of the services may become unavailable.
- Some functions of Pandora® cannot be operated from this unit.
- For issues on using the application, please contact Pandora® at pandora-support@pandora.com.

USB

Connecting a USB device

- 1 Connect the USB device with the USB cable. (P.111)

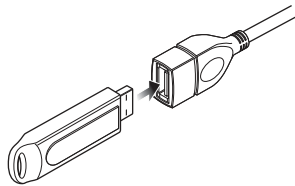

- 2 Press the **HOME** button.
- 3 Touch .
- 4 Touch **USB**. (P.14)

Disconnect the USB device

- 1 Press the **HOME** button.
- 2 Touch a source other than **USB**.
- 3 Detach the USB device.

Usable USB device

You can use a mass-storage-class USB device with this unit.
The word "USB device" appearing in this manual indicates a flash memory device.

● About the file system

The file system should be the one of the following.

- FAT16 • FAT32 • exFAT • NTFS

NOTE

- Install the USB device in the place where it will not affect safe driving.
- You cannot connect a USB device via a USB hub and Multi Card Reader.
- Take backups of the audio files used with this unit. The files can be erased depending on the operating conditions of the USB device. We shall have no compensation for any damage arising from any erased data.

USB Basic Operation



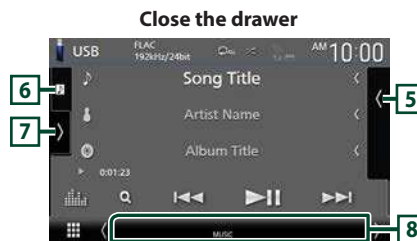

Most functions can be controlled from the source control screen and playback screen.

NOTE



- Set the remote controller mode switch to AUD mode before starting operation, see **Switch the operation mode (P.99)**.



1 CODEC/ /

- When a high-resolution source is played, its format information is displayed.
-  : Repeats the current track/folder. Each time you touch the key, repeat modes are switched in the following sequence: File repeat (), Folder repeat (), Repeat all ()





USB

-  : Randomly plays all tracks in the current folder. Each time you touch the key, random modes are switched in the following sequence: File random (), Random off ()

2 Track information





- Displays the information on the current file. Only a file name and a folder name are displayed if there is no tag information.
- Change the text size of the information smaller when the "Small Audio Text" is set to "ON" in the User Interface screen (P.84).

3 Play mode indicator/Playing time

- , etc.: Current play mode indicator
Meanings of individual icons are as follows:
 (play),  (fast forward),  (fast backward),  (pause).
- For confirmation of current playing position. You can drag the circle left or right to change the playing position. (Video file only)



4 Operation keys

-  : Searches track/file. For details on search operation, see **Search Operation (P.41)**.
-  : Searches the previous/next track/file.
Touch and hold to fast forward or fast backward. (It will be cancelled automatically after about 50 seconds.)
-  : Plays or pauses.
-  : Displays the Graphic Equalizer screen. (P.93)

5 Content list



- Touch the right side of the screen to display the Content list. Touch again to close the list.
- Displays the playing list. When you touch a track/file name on the list, playback will start.

6 Artwork/VU meter

- Displays/hides artwork area.
- The jacket of the currently playing file is displayed.
- Touch to switch between the artwork and VU meter.

7 Function panel

Touch the left side of the screen to display the function panel. Touch again to close the panel.

-   : Searches for the previous/next folder.

• USB DEVICE CHANGE :

Switches to another USB device when two USB devices are connected.
(Except DDX819WBTL)

8 Indicator Items

- **VIDEO** : Identifies the video file.
- **MUSIC** : Identifies the music file.

Video screen



9 File search area (Video file only)

Touch to search for the next/previous file.

10 Key display area (Video file only)

Touch to display the control screen.

Search Operation

You can search music or video files by the following operations.

- 1 Touch **Q**.
- 2 Touch **▼**.



- 3 Select a list type.



NOTE

- For operations on the list screen, see *List screen (P.17)*.

Category search

You can search for a file by selecting a category.

- 1 Touch **Category List**.
- 2 Select whether you search audio files or video files .
- 3 Touch the desired category.

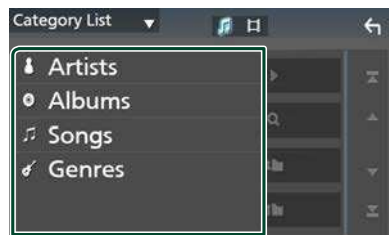

- The list corresponding to your selection appears.

- 4 Touch to select the desired item in the list. Repeat this step until you find the desired file.

Link search

You can search for a file of the same artist/album/genre as that in the current track.

- 1 Touch **Link Search**.
- 2 Touch the desired tag type. You can select from artists, albums and genres.

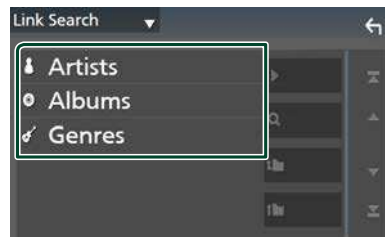

- The list corresponding to your selection appears.

- 3 Touch the desired item in the content list.

Folder search

You can search for a file according to hierarchy.

- 1 Touch **Folder List**.
- 2 Touch the desired folder.

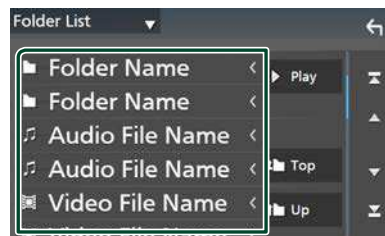

When you touch a folder its contents are displayed.

- 3 Touch to select your desired item in the list. Repeat this step until you find the desired file.

iPod/iPhone

Preparation

Connectable iPod/iPhone

The following models can be connected to this unit.

Made for

- iPhone X
- iPhone 8 Plus
- iPhone 8
- iPhone 7 Plus
- iPhone 7
- iPhone SE
- iPhone 6s Plus
- iPhone 6s
- iPhone 6 Plus
- iPhone 6
- iPhone 5s
- iPhone 5c
- iPhone 5
- iPod touch (6th generation)

NOTE

- Latest compatible list of iPod/iPhone. For details, see www.kenwood.com/cs/ce/ipod/.
- By connecting your iPod/iPhone to this unit with the iPod connection cable KCA-iP103 (optional accessory), you can supply power to your iPod/iPhone as well as charge it while playing music. Note that the power of this unit must be held on.
- If you restart playback after connecting the iPod, the music that has been played by the iPod is played first.

Connect iPod/iPhone

Wired connection

Preparation

- Connect an iPod/iPhone with the KCA-iP103 (optional accessory) while Apple CarPlay is not connected.
- With an Apple CarPlay-capable iPhone, turn off Apple CarPlay by operating the iPhone at functional setup before connecting iPhone. For details of the setup method, contact the manufacturer of the terminal.
- Plug the iPod/iPhone into the gray USB terminal with the KCA-iP103 (optional accessory). (Except DDX819WBTL)
- Plug the iPod/iPhone into the USB terminal with the KCA-iP103 (optional accessory). (DDX819WBTL)
- Only one iPod/iPhone can be connected.

1 Connect the iPod/iPhone using the KCA-iP103. (P.111)

2 Press the **HOME** button.

3 Touch .

4 Touch **iPod**. (P.14)

● **To disconnect the iPod/iPhone connected with the cable:**

1 Detach the iPod/iPhone.

Bluetooth connection

Pair the iPhone through Bluetooth.

Preparation

- To connect an iPhone via Bluetooth, register it as a Bluetooth device and do the profile setting for the connection beforehand. See **Register the Bluetooth device (P.67)** and **Connect the Bluetooth device (P.68)**.
- Connect an iPhone via Bluetooth while Apple CarPlay and an iPod/iPhone are not connected via USB.
- With an Apple CarPlay-capable iPhone, turn off Apple CarPlay by operating the iPhone at functional setup before connecting iPhone. For details of the setup method, contact the manufacturer of the terminal.

iPod/iPhone Basic Operation

NOTE

- Set the remote controller mode switch to AUD mode before starting operation, see **Switch the operation mode (P.99)**.

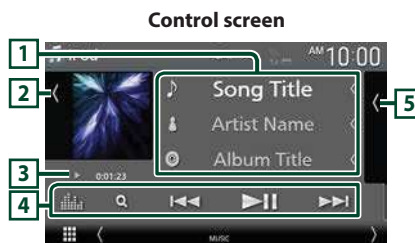

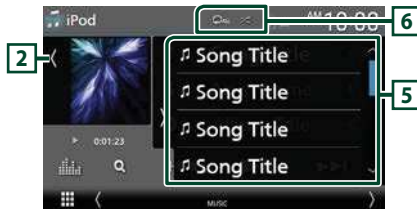
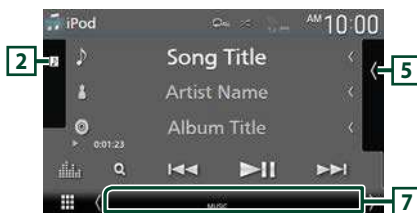
Open the drawer**Close the drawer****1 Track information**

- Displays the information on the current file.
- Touch to display the category list screen. See **Category search (P.44)**.
- Change the text size of the information smaller when the "Small Audio Text" is set to "ON" in the User Interface screen (**P.84**).

2 Artwork/VU meter

- Displays/hides artwork area.
- The jacket of the currently being played file is displayed.
- Touch to switch between the artwork and VU meter.

3 Play mode indicator/Playing time

- ▶, ▶▶, etc.: Current play mode indicator
Meanings of individual icons are as follows:
▶ (play), ▶▶ (fast forward), ◀◀ (fast backward), || (pause).

4 Operation keys

- 🔍 : Searches for a track/file. For details on search operation, see **Search Operation (P.43)**.
- ◀◀ ▶▶ : Searches for the previous/next track/file.
Touch and hold to fast forward or fast backward. (It will be cancelled automatically after about 50 seconds.)
- ▶|| : Plays or pauses.
- 📊 : Displays the Graphic Equalizer screen. (**P.93**)

5 Content list

- Touch the right side of the screen to display the Content list. Touch again to close the list.
- Displays the playing list. When you touch a track/file name on the list, playback will start.

6 Repeat/Random

- 🔄 : Repeats the current track/album. Each time you touch the key, repeat modes are switched in the following sequence:
Song repeat (🔄), All songs repeat (🔄), Repeat off (🔄)
- 🎲 : Randomly plays all tracks in the current album. Each time you touch the key, random modes are switched in the following sequence:
Song random (🎲), Random off (🎲)

7 Indicator Items

- MUSIC: Identifies the music file.

Search Operation

You can search music files by the following operations.

1 Touch 🔍.**2 Touch ▼.****3 Select a list type.****NOTE**

- For operations on the list screen, see **List screen (P.17)**.

iPod/iPhone

Category search

You can search for a file by selecting a category.

- 1 Touch **Category List**.
- 2 Touch the desired category.

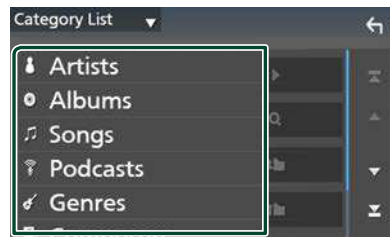

➤ The list corresponding to your selection appears.

- 3 Touch to select the desired item in the list. Repeat this step until you find the desired file.

Link search

You can search for a file of the same artist/album/genre/composer as that in the current track.

- 1 Touch **Link Search**.
- 2 Touch the desired tag type. You can select from artists, albums, genres and composers.

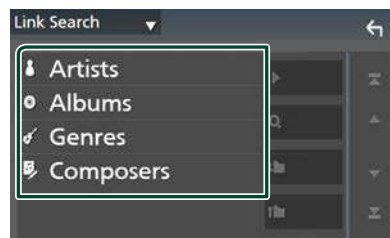

➤ The list corresponding to your selection appears.

- 3 Touch the desired item in the content list.

Radio (DDX8706S / DDX819WBTL / DMX9706S)

Radio Basic Operation

Most functions can be controlled from the source control screen.

To listen to the Radio source, touch **Radio** icon on the source selection screen. (P.14)

NOTE

- Set the remote control mode switch to AUD mode before starting operation, see **Switch the operation mode (P.99)**.

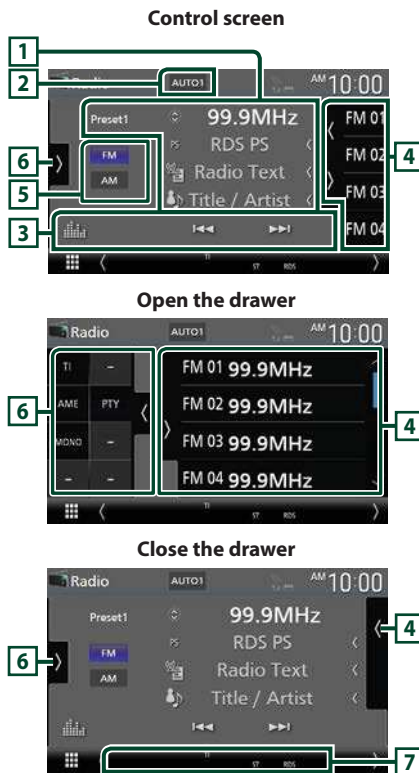

1 Information display

- Displays the information on the current station: Frequency
Touching allows you to switch between Content A and Content B.
Content A: PS name, Radio Text, Title & Artist
Content B: PTY Genre, Radio Text plus
Preset#: Preset number
- Change the text size of the information smaller when the "Small Audio Text" is set to "ON" in the User Interface screen (P.84).

2 Seek mode

Touch to switch seek mode in the following sequence: **AUTO1**, **AUTO2**, **MANUAL**.

- AUTO1**: Tunes in a station with good reception automatically.
- AUTO2**: Tunes in the memorized stations one after another.
- MANUAL**: Switches to the next frequency manually.

3 Operation keys

- : Tunes in a station. The method of switching frequencies can be changed (see 2 Seek mode).
- : Displays the Graphic Equalizer screen. (P.93)

4 Preset list

- Touching allows you to change the display size.
- Recalls the memorized station.
- When touched for 2 seconds, stores the currently being received station in the memory.

5 Band buttons

Switches bands (between FM and AM).

6 Function panel

Touch the left side of the screen to display the function panel. Touch again to close the panel.

- TI** (FM only): Selects the traffic information mode. For details, see **Traffic Information (P.47)**.
- AME**: Presets stations automatically. For details, see **Auto memory (P.46)**.

Radio

- **PTY** (FM only) : Searches for a program by program type. For details, see **Search by program type (P.47)**.
- **MONO** (FM only) : Selects the Monaural reception mode.

7 Indicator Items

- **ST** : A stereo broadcast is being received.
- **MONO** : The forced monaural function is active.
- **TI** : Indicates the reception state of traffic information.
 - White: TP is being received.
 - Orange: TP is not being received.

Memory Operation

Auto memory

You can store stations with good reception in the memory automatically.

1 Touch desired band key.



2 Touch **▶** on the left side of the screen. Touch **AME**.

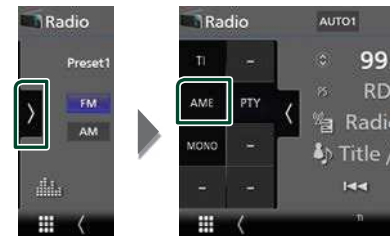

3 Touch **Yes**.

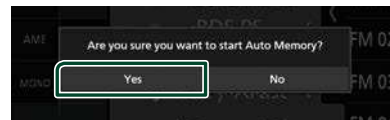

➤ Auto memory starts.

Manual memory

You can store the currently being received station in the memory.

1 Select the station you wish to store in the memory.

2 Touch **FM#** (#:1-15) or **AM#** (#:1-5) in which you want to store the station for 2 seconds until a beep sounds.

Selecting Operation

Preset select

You can list and select memorized stations.

- 1 Touch **[>]** on the right side of the screen. Select a station from the list.

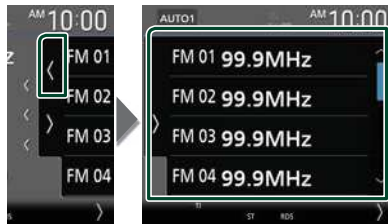

Search by program type (FM only)

You can tune in the station broadcasting the specified type of program when listening to FM.

- 1 Touch **[>]** on the left side of the screen. Touch **PTY**.



➤ TUNER PTY Mode screen appears.

- 2 Select a program type from the list.
- 3 Touch **Search**.

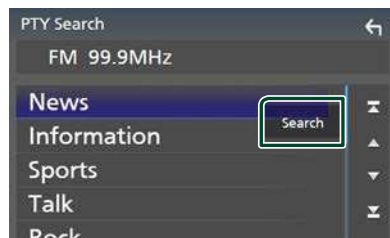

You can search for the station broadcasting the selected type of program.

Traffic Information (FM only)

You can listen to and watch traffic information automatically when a traffic bulletin starts. However, this feature requires a Radio Broadcast Data System that includes TI information.

- 1 Touch **[>]** on the left side of the screen. Touch **TI**.

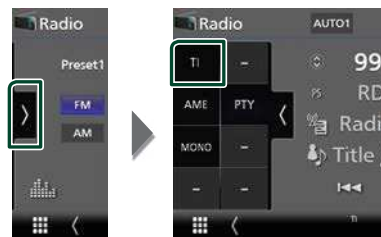

➤ Traffic information mode is set.

When the traffic bulletin starts

The Traffic Information screen appears automatically.

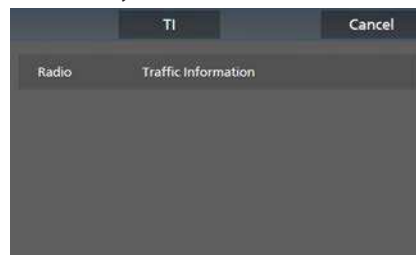

NOTE

- It is necessary to turn on the Traffic Information function in order to allow the Traffic Information screen to appear automatically.
- The volume setting made during reception of traffic information is automatically memorized. When the traffic information is received next time, this unit recalls the volume setting automatically.
- To cancel Traffic Information: Touch **Cancel**.

HD Radio™ Tuner (DDX9906XR / DDX8906S / DMX906S)

HD Radio Tuner Basic Operation

Most functions can be controlled from the source control screen.

To listen to the HD Radio source, touch **HD Radio** icon on the source selection screen. (P.14)

NOTE

- Set the remote control mode switch to AUD mode before starting operation, see **Switch the operation mode (P.99)**.
- HD Radio broadcasting is for North American sales area only.
- The screen shot below is for tuner. It may be different from the one for HD Radio broadcasting.

Control screen



Open the drawer



Close the drawer

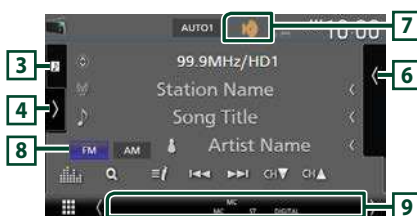

1 Information display

- Displays the information on the current station: Frequency and Channel
- Touching  allows you to switch between Content A, Content B and Content C.
- Content A: Station name, Song Title, Artist Name
- Content B: Station Message, Radio Text
- Content C: PTY Genre, Album Name
- Change the text size of the information smaller when the "Small Audio Text" is set to "ON" in the User Interface screen (P.84).

2 Seek mode

Touch to switch seek mode in the following sequence: **AUTO1**, **AUTO2**, **MANUAL**.

- **AUTO1**: Tunes in a station with good reception automatically.
- **AUTO2**: Tunes in the memorized stations one after another.
- **MANUAL**: Switches to the next frequency manually.

3 Picture

- Displays/hides picture area.
- The picture data or station Logo data is displayed if available from current content.

4 Function panel

Touch the left side of the screen to display the function panel. Touch again to close the panel.

- **10key Direct**: Display the direct station/channel search screen. For details, see **Direct search (P.51)**.
- **AME**: Presets stations automatically. For details, see **Auto memory (P.50)**.
- **RCV**: Change the HD Radio reception mode. For details, see **Receive Mode (P.50)**.
- **PTY** (FM only): Searches for a program by program type. For details, see **Search by program type (P.51)**.
- : Stores the information about the song being received. See **Bookmark (P.52)**.
- **Emergency Alerts**: Turn on or off the alert message. See **Alert Message (P.53)**.
- **Alert Message Log**: Displays the alert message received. See **Alert Message (P.53)**.

5 Operation keys

- **◀▶** : Tunes in a station. The method of switching frequencies can be changed (see **2** Seek mode).
- **CH▼ CH▲** : Selects a channel.
- **Q** : Display the Channel List screen. See **Channel search (P.51)**.
- **☰** : Display a list of registered bookmarks. See **Bookmark list (P.52)**.
- **📊** : Displays the Graphic Equalizer screen. **(P.93)**

6 Preset list

- Touching **📏** allows you to change the display size.
- Recalls the memorized station or channel.
- When touched for 2 seconds, stores the currently being received station or channel in the memory.

7 Indicator display

While receiving an HD Radio station, it lights with orange when the audio is digital and lights with gray when it is analog. While receiving an analog station, it is off.

8 Band buttons

Switches bands (between FM and AM).

9 Indicator Items

- **MC**: A multicast digital broadcast is being received.
- **ANALOG**: An analog broadcast is being received.
- **DIGITAL**: A digital broadcast is being received.
- **ST**: A stereo broadcast is being received.
- **EA**:
 - White: Emergency Alert is on.
 - No light: Emergency Alert is off.
 - Orange: Interrupting or in snooze/ignore state.

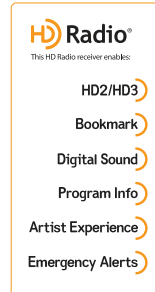

HD2/HD3

- Adjacent to traditional main stations are HD2/HD3 Channels, providing new original programming on the FM dial

Bookmark

- A music & product discovery feature that enables users to store information about content on the radio, and can deliver interactive information via QR codes

Digital Sound

- Crystal clear, CD-like digital audio quality to consumers; eliminates background noise

Program Info

- Provides song name, artist, station ID, and other relevant data to enrich the listening experience

Artist Experience

- Visual images, such as album art of over-the-air broadcasts from HD Radio stations

Emergency Alerts

- Delivers critical and life-saving messages to the public during emergency situations

HD Radio™ Tuner

Receive Mode

You can set the radio broadcasts receive mode.

- 1 Touch  on the left side of the screen. Touch **RCV**.

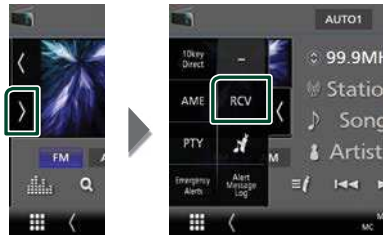

- 2 Select a receive mode.



- **Auto**
Switch between digital and analog audio automatically.
- **Digital**
Select this to tune to digital audio only.
- **Analog**
Select this to tune to analog audio only.

Memory Operation

Auto memory

You can store stations with good reception in the memory automatically.

- 1 Touch desired band key.

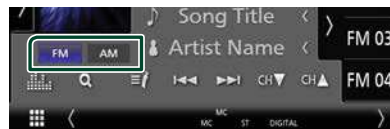

- 2 Touch  on the left side of the screen. Touch **AME**.

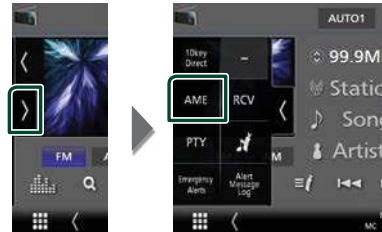

- 3 Touch **Yes**.

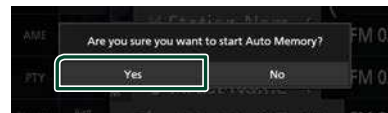

➤ Auto memory starts.

Manual memory

You can store the currently being received station or channel in the memory.

- 1 Select the station or channel you wish to store in the memory.
- 2 Touch **FM#** (#:1-15) or **AM#** (#:1-5) in which you want to store the station or channel for 2 seconds until a beep sounds.

Selecting Operation

Preset select

You can list and select memorized stations or channels.

- 1 Touch  on the right side of the screen. Select a station or channel from the list.

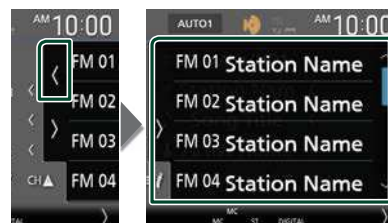

Direct search

You can tune in by entering the desired frequency or channel number.

- 1 Touch **10key Direct** on the left side of the screen. Touch **10key Direct**.



- 2 Select the search method.



- 3 Enter the frequency or channel number.
- 4 Touch **Enter**.

NOTE

• To clear the number you entered, touch **BS**.

Channel search

You can specify the desired channel.

- 1 Touch **Q**.

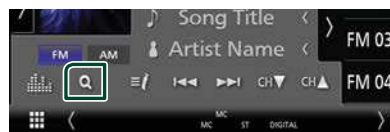

- 2 Select the desired content from the list.

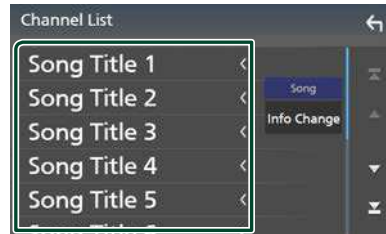

NOTE

• Touch **Info Change** in the channel list. Select the sequence of the list (Song title, artist name, album name).

Search by program type (FM only)

You can tune in the station broadcasting the specified type of program when listening to FM.

- 1 Touch **PTY** on the left side of the screen. Touch **PTY**.

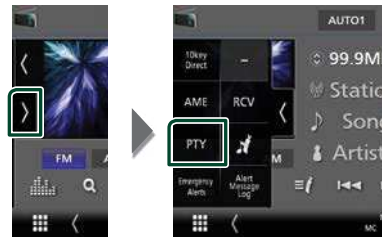

➤ TUNER PTY Mode screen appears.

- 2 Select a program type from the list.
- 3 Touch **Search**.

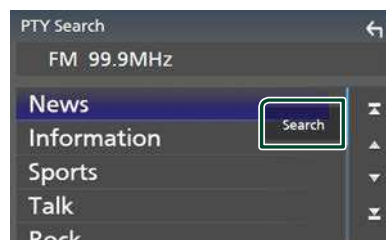



You can search for the station broadcasting the selected type of program.

Bookmark

Stores tag information (title, artist, album, URL, and description) about the song you are listening to now.

Detailed information and QR codes can be displayed according to the stored tag information.

Bookmark registration

- 1 Touch  on the left side of the screen. Touch .

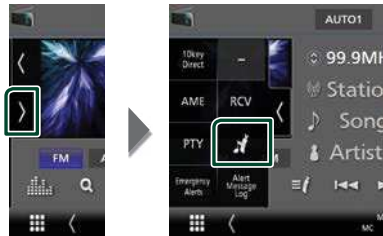

➤ Registers a bookmark.

NOTE

- Up to 100 bookmarks can be registered to this unit.

Bookmark list

Displaying a list of registered bookmarks and detailed information and QR code of the song.

- 1 Touch .

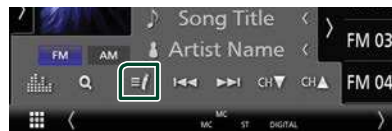

- 2 Select the desired bookmark from the list.

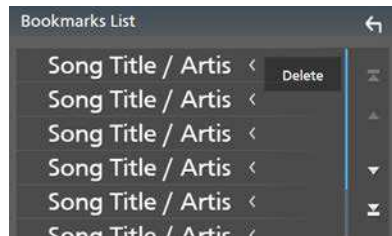

➤ The bookmark information appears.

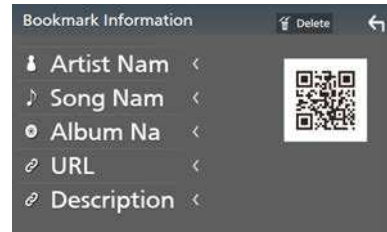

- 1 Touch  **Delete**.

Deletes the bookmarks being displayed.

Bookmark delete

Deleting a bookmark.

- 1 Touch **Delete**.

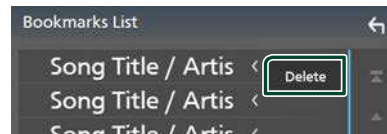

- 2 Select the bookmark to delete from the list.

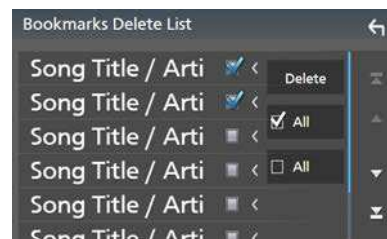

- 1 **All**

Select all bookmarks.

- 1 **All**

Erases all check marks.

- 3 Touch **Delete**.

➤ Confirmation message appears.

- 4 Touch **Yes**.

➤ All the selected bookmark(s) is deleted.

Alert Message

This function is to receive alert messages. First, you need to turn on the “Emergency Alerts”. (P.48)

When an Alert Message comes



Snooze

The alert message is erased. Same alert message cannot be displayed for next 10 minutes.

Ignore

The alert message is erased. Same alert message cannot be displayed for next 12 hours.

Allow Alert

Touch to tune to that channel of HD Radio source.

Display of the received Alert Message

You can read the received alert message afterward.

- 1 Touch  on the left side of the screen. Touch **Alert Message Log**.

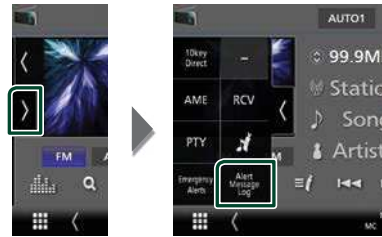

- 2 Select the desired Alert Message from the list.

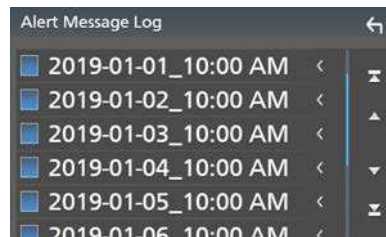

► The Alert Message appears.

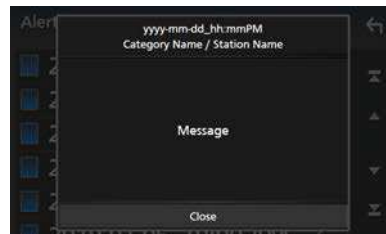

- 3 Touch **Close**.

SiriusXM® (Except DDX819WBTL)

SiriusXM® Basic Operation

Only SiriusXM® brings you more of what you love to listen to, all in one place. Get over 140 channels, including commercial-free music plus the best sports, news, talk, comedy and entertainment. Welcome to the world of satellite radio. A SiriusXM Vehicle Tuner and Subscription are required. For more information, visit www.siriusxm.com.

To listen to the SiriusXM source, touch the **SiriusXM** icon on the source selection screen. (P.14)

Activating subscription

- Check your Radio ID.
The SiriusXM Satellite Radio ID is required for activation and can be found by tuning in Channel 0 as well as on the label found on the SiriusXM Connect tuner and its package.
The Radio ID does not include the letters I, O, S or F.
- Activate the SiriusXM Connect Vehicle Tuner using either one of the two methods below:
 - For users in U.S.A.
Online: Visit www.siriusxm.com/activatenow
Phone: Call SiriusXM Listener Care at 1-866-635-2349
 - For users in Canada:
Online: Visit <http://www.siriusxm.ca/help/activation-help/>
Phone: Call XM customer Care at 1-877-438-9677

NOTE

- Set the remote control mode switch to AUD mode before starting operation, see **Switch the operation mode (P.99)**.
- To use SiriusXM® Satellite Radio, the optional accessory is necessary.

Control screen



Open the drawer



Close the drawer

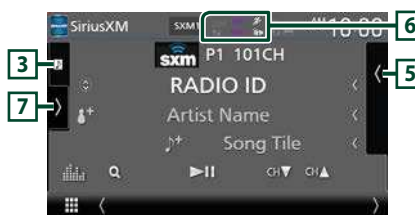

1 Information display

- Displays the information on the current channel: Channel Name
P#: Preset number
#CH: Channel number
Logo: Channel logo
Touching allows you to switch between Content A, Content B and Content C.
Content A: Artist Name, Song Title
Content B: Content Info, Category Name
Content C: Channel Description, Similar Channels
 : Touch for 2 seconds to register the artist of the current song as a Content Alert.
 : Touch for 2 seconds to register the current song as a Content Alert.
For details, see **Content Alerts (P.59)**.

- Change the text size of the information smaller when the "Small Audio Text" is set to "ON" in the User Interface screen (P.84).

NOTE

- While getting contents, "Waiting" is showing on the display.

2 Band button

Switches among bands. (SXM1/SXM2/SXM3/SXM4)

3 Artwork

- Displays/hides artwork area.
- Displays the album artwork for most SiriusXM music channels



4 Operation keys

- **Q** : Display the Category search screen. For details on search operation, see **Category/Channel search (P.57)**.
- **▶||** : Plays or pauses. See **Replay (P.57)**.
- **CH▼ CH▲** : Selects a channel.
- **EQ** : Displays the Graphic Equalizer screen. (P.93)

5 Preset list

- Touching **Q**/**X** allows you to change the display size.
- Recalls the memorized channel.
- When touched for 2 seconds, stores the currently being received channel in the memory.

6 Indicator display

Displays the "Mix" (TuneMix™), "Scan" (TuneScan™),  (Traffic&Weather), or  (SportsFlash™) indicator and the received signal strength of the SiriusXM tuner.

7 Function panel

Touch the left side of the screen to display the function panel. Touch again to close the panel.

- **Direct Channel**: Touch and enter the desired number. For details, see **Direct search (P.56)**.
- **SETUP**: Touch to display the SiriusXM SETUP screen. For details, see **SiriusXM Setup (P.60)**.
- **Replay/Live**: Touch to turn on or off the replay mode. See **Replay (P.57)**.





• Traffic & Weather

For SXV300 *1

Traffic & Weather Now™ allows you to access the latest report whenever you want to hear it. Select your city from the set up menu



Select a City for Traffic & Weather (P.65)

and press the **Traffic & Weather** button to check the latest report. It will start from the beginning.

-  (White) : Played already.
-  (Green) : New information arrived.
-  (Purple) : Playing.
-  (Gray) : No information.

For SXV200 or SXV100 *2

Turns the Traffic & Weather Jump function on or off.

-  (White) : Function on.
-  (Purple) : Playing.
-  (Gray) : Function off.

- **TuneScan** *3 : Allows you to hear a few seconds of songs from each of the SmartFavorite music channels on the current preset band. See **TuneScan™ (P.58)**.
- **TuneMix** *4 : When turned ON, shuffles the preset channels on P1-P6 to play a blend of songs from your favorite channels. See **TuneMix™ (P.58)**.
- **SportsFlash** *4 : Displays during SportsFlash™. Touch to cancel the SportsFlash™ function and return to the previous channel. See **SportsFlash™ (P.60)** and **SportsFlash™ setup (P.64)**.

*1 Compatible with SXV300 or later tuner models. It may take a few minutes after power on to get the first full report on your city. Traffic channels are not available in Canada.

*2 When SXV200 or SXV100 is connected with this unit.

*3 Compatible with SXV200 or later tuner models.

*4 Compatible with SXV300 or later tuner models.

Storing Channels in Preset Memory

You can store the current channel in memory.

- 1 Tune in the channel you wish to store in the memory.
- 2 Touch **CH** on the right side of the screen.



- 3 Touch **SXM(1-4) P(1-6)** in which you want to store the channel for 2 seconds until a beep sounds.

Preset select

You can list and select memorized channels.

To select from the preset list

- 1 Touch **CH** on the right side of the screen. Select a channel from the list.



Direct search

You can tune in a channel directly.

- 1 Touch **Direct Channel** on the left side of the screen. Touch **Direct Channel**.



- 2 Enter the channel number and touch **Enter**.



NOTE

- To clear the number you entered, touch **BS**.

Category/Channel search

You can specify the desired category and select a channel.

1 Touch **Q**.



2 Select a category.

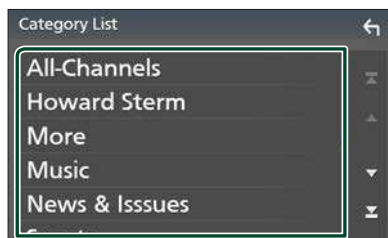

➤ Channel list appears.

3 Select the desired content from the list.

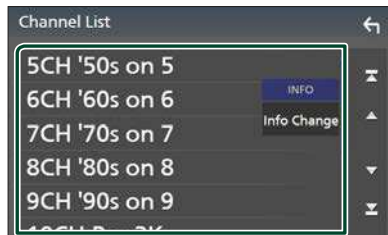

NOTE

- All channels in the selected category appear.
- Touching **All-Channels** displays all channels.
- Touch **Info Change** in the channel list. Select a desired item: content info, channel name, artist name, song title, category name.
- Categories which have the prefix "Featured - " are Featured Favorites.
- Featured Favorites are groups of channels that are created by the SiriusXM Programming department allowing you to discover new channels. Featured Favorite channels are dynamic and can change often, allowing you to discover new channels.
 - You can set whether to be notified when the featured seasonal theme is updated. **(P.65)**

Replay

You can replay the last 60 minutes of the program from the current channel.

1 Touch **▶||** or **Replay** on the function panel.



Press to skip to the previous/next track.

Press and hold to rewind or fast forward. (It will be cancelled automatically after about 50 seconds.)



Plays or pauses.

■ **Replay time bar/Play mode indicator**

Displays the recorded data capacity and playback position.

▶, ▶▶, etc.: Current play mode indicator



Displays a list of recorded data on a program basis.

2 Touch **Q** to display an Instant Replay List screen.

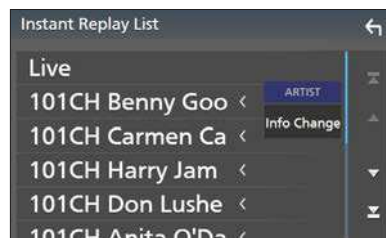

■ **Instant Replay List**

Touching this plays back the displayed program.

LIVE: Touch to return to the live music/content.

■ **Info Change**

Touch **Info Change**. Select a desired item: content info, channel name, artist name, song title, category name.

SiriusXM®

To return to live music/content

- 1 Touch the left side of the screen.
- 2 Touch **Live**.

TuneMix™

TuneMix™ plays a unique blend of songs from your Preset music channels of the current SiriusXM Preset Band, allowing you to build a custom channel from as few as two to as many as 6 music channels. You can even skip songs you don't want to hear.

- 1 Touch  on the left side of the screen. Touch **TuneMix** to set ON or OFF.



NOTE

- Compatible with SXV300 or later tuner models.

SmartFavorites, TuneStart™

Preset channels 1 through 6 of the current band are SmartFavorites channels. The SiriusXM Vehicle Tuner automatically buffers the broadcast audio content of the SmartFavorites channels in the background.

You can rewind and replay up to 30 minutes of any of the missed news, talk, sports or music content on SmartFavorites channels. (see **Replay (P.57)**)

When tuning in a SmartFavorites channel, songs will be played from the beginning of each track (TuneStart™). You can enable/disable TuneStart. (see **TuneStart™ (P.65)**)

NOTE

- Compatible with SXV200 or later tuner models.

TuneScan™

TuneScan™ is a feature that plays samples from the starts of multiple buffered songs from each of the SmartFavorites channels that predominantly play music selections.

You have easy access to a large sampling of music content and can enjoy hearing a full song by stopping the scan on a song of interest.

- 1 Touch  on the left side of the screen.



- 2 Touch **TuneScan** to begin scanning your SmartFavorites channels.

You will hear a few seconds of the songs from each of the SmartFavorite channels.

- 3 While your favorite song is being played, touch **TuneScan** again to start listening to that song.



- Scan finishes and the song is played continuously.

NOTE

- To cancel TuneScan™, touch the left side of the screen. Touch **TuneScan**.
- Touch and hold **TuneScan** to cancel TuneScan, and the music/content which was present on the channel before starting TuneScan will be played.
- Compatible with SXV200 or later tuner models.

Traffic & Weather Now™

Traffic & Weather Now™ allows you to access the latest report whenever you want to hear it. Select your city in the set up menu **Select a City for Traffic & Weather (P.65)**.





- 1 Touch **>** on the left side of the screen.



- 2 Touch **Traffic & Weather**.

The report starts from the beginning. To stop and return to the previous channel, touch it again.

Indicator display

-  (White) : Played already.
-  (Green) : New information arrived.
-  (Purple) : Playing.
-  (Gray) : No information.

NOTE

- Compatible with SXV300 or later tuner models.

Content Alerts

When a broadcast program related to the registered artist, song or team starts, an Alert Content List screen appears to allow you to switch the current channel to the relevant channel.

- 1 When the broadcast of the registered content starts, an Alert Content List screen appears.

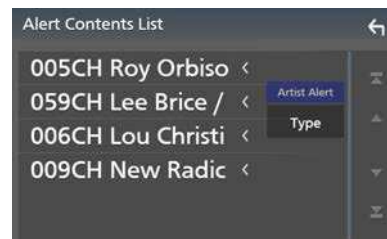

- 2 Select a content from the list.

NOTE

- Touch **Type**. Select a desired item. Artist Alert, Song Alert, GameAlert™
- To learn how to register artists and songs for the Content Alert function, see **Information display in SiriusXM® Basic Operation (P.54)**.
- To learn how to set up the Content Alerts function and select Teams for alerts, see **Content Alerts setup (P.62)**.

SportsFlash™

SportsFlash™ will notify you when a big play happens during a game with one of your favorite sports teams. Choose to tune in and hear the play unfold like it was live. Continue listening to the game or return to your previous channel.

- 1 When a big play happens during one of the games, an Alert screen appears.

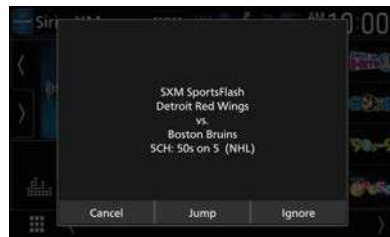

Jump

Touch to tune in that channel and play back the big play.

Ignore

Touch to cancel this specific SportsFlash alert. Touching **Ignore** will ignore this specific alert but will allow future alerts for this game.

Cancel

Touch to cancel SportsFlash alert. No alerts for this game will be displayed afterward.

NOTE

- Compatible with SXV300 or later tuner models.
- To learn how to set up the SportsFlash alert function, see **SportsFlash™ setup (P.64)**.

SiriusXM Setup

- 1 Touch  on the left side of the screen. Touch **SETUP**.



- SiriusXM SETUP screen appears.

See the following sections for each setting.

- Set up the parental code **(P.61)**
- Set up the Parental Control **(P.61)**
- Set up the skip channel select **(P.62)**
- Set up the Content Alerts **(P.62)**
- Set up the teams for SportsFlash™ **(P.64)**
- Select the city for Traffic & Weather Jump or Traffic & Weather Now™ **(P.65)**
- Select the Featured Bands Update Messages **(P.65)**
- Set up the TuneStart™ **(P.65)**
- Reset to the default settings **(P.65)**

Parental code

You can set a SiriusXM parental code for Parental Control.

1 Touch **Parental Code** on the SiriusXM SETUP screen.

➤ Parental Pass Check screen appears.

NOTE

- The code number is set to "0000" as default.

2 Enter the current code number and touch **Enter**.



➤ Parental Pass 1st screen appears.

3 Enter the new code number and touch **Enter**.



➤ Parental Pass 2nd screen appears.

4 Enter the same code number as that you entered in step 3 and touch **Enter**.

➤ The code number is confirmed and the SiriusXM parental code is now set.

Parental Control

Parental Control is a feature that provides the user with the ability to prevent unauthorized access to mature content and user selected channels.

1 Touch **Parental Control** on the SiriusXM SETUP screen.

2 Touch **User, Mature** or **OFF**.

■ **User**

Locks only the selected channels.

■ **Mature**

Locks channels classified as "mature" only.

■ **OFF**

Deactivates the parental mature and user locks.

3 Enter the parental code you originally input in as stated in **Parental code (P.61)** and touch **Enter**.

When selecting User

This allows you to limit access to any SiriusXM channel (Parental Lock Channel).

1 Touch **Parental Lock Channel Selection** on the SiriusXM SETUP screen.

➤ Parental Pass Check screen appears.

NOTE

- You need to set up a parental code beforehand as stated in **Parental code (P.61)**.

2 Enter the parental code you originally input as stated in **Parental code (P.61)** and touch **Enter**.

➤ Parental Lock Category Select screen appears.

3 Touch the desired category in the list.

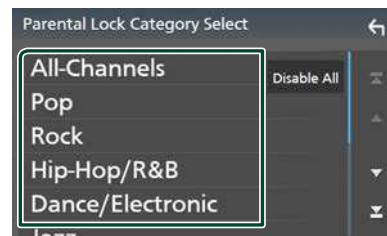

➤ Displays all channels in the selected category.

SiriusXM®

NOTE

- Touch **All-Channels** to display all channels.
- To delete the parental lock channel setting, touch **Disable All** and then touch **YES** on the confirmation screen.

4 Touch each channel on the list and set to ON or OFF.

ON: Locks the channel.

OFF: Unlocks the channel.

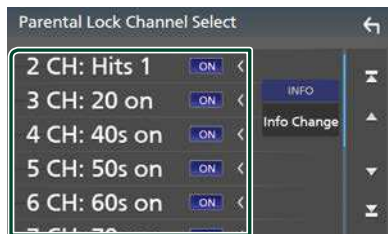

NOTE

- Touch **Info Change**. Select a desired item: content info, channel name, artist name, song title, category name.

☑ Skip channel select

You can set the undesired channels to skip.

1 Touch **Skip Channel Select**.

- Skip Category Select screen appears.

2 Touch the desired category from the list.

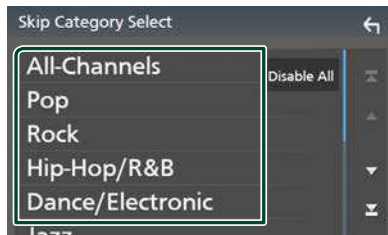

- Displays all channels in the selected category.

3 Touch each channel in the list and set to ON or OFF.



NOTE

- To delete the skip channel setting, touch **Disable All** and then touch **YES** on the confirmation screen.
- Touch **Info Change**. Select a desired item: content info, channel name, artist name, song title, category name.
- Direct Channel and Preset Memory functions allow you to select channels.

☑ Content Alerts setup

Activating content alert

1 Touch **Content Alerts** on the SiriusXM SETUP screen.

- Content Alerts is turned on or off. Default is "ON".

Selecting the content for Content Alerts

1 Touch **Content Alerts Contents Set** on the SiriusXM SETUP screen.

2 Select the content you want to set up.

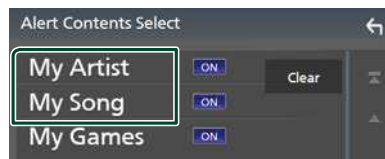

NOTE

- To cancel all alert contents, touch **Clear** and then touch **YES** on the confirmation screen.
- Select **OFF** for the content you want to deactivate the content alert for.

- 3** Touch each content list item you want to select ON or OFF.

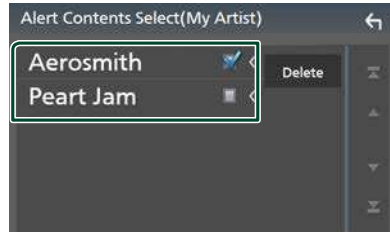

NOTE

• You can select up to 60 artists or songs.

● **To delete the Artist and Song**

- 1** Touch **Delete**.

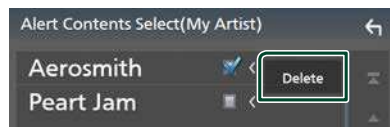

- 2** Touch the content(s) in the list you want to select.

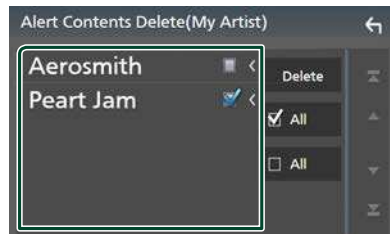

All
Selects all contents.

All
Clears all check marks.

- 3** Touch **Delete** and then touch **YES** on the confirmation screen.

To select a Team

Get alerted when your favorite sports team is playing on another SiriusXM channel with GameAlert™

- 1** Touch **My Games**.

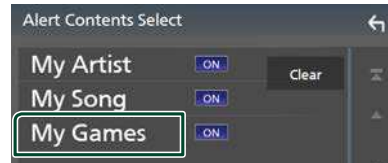

- 2** Touch the desired league in the list.



- 3** Touch the team(s) in the list you want to select.

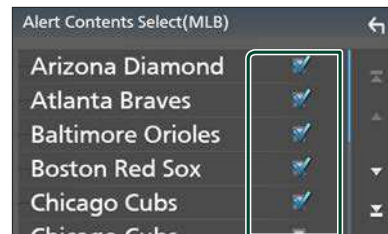

NOTE

• You can select up to 30 teams.

SiriusXM®

SportsFlash™ setup

Activating SportsFlash

- 1 Touch **SportsFlash** on the SiriusXM SETUP screen.
 - SportsFlash is turned on or off. Default is "ON".

Selecting SportsFlash Beep

- 1 Touch **SportsFlash Beep** on the SiriusXM SETUP screen.
 - SportsFlash Beep is turned on or off. Default is "ON".

Selecting the teams for SportsFlash

- 1 Touch **SportsFlash Team Set** on the SiriusXM SETUP screen.
 - Team Set screen appears.
- 2 Touch **Edit**.

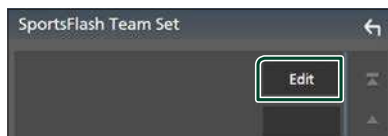

- 3 Touch the desired league in the list.

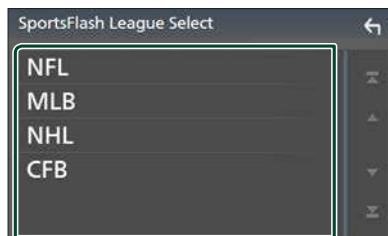

- 4 Touch each team(s) in the list you want to select.

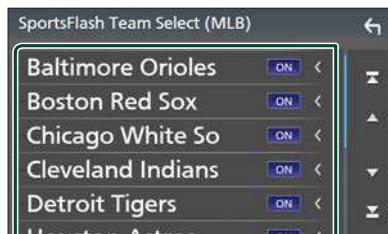

- 5 Touch  twice.

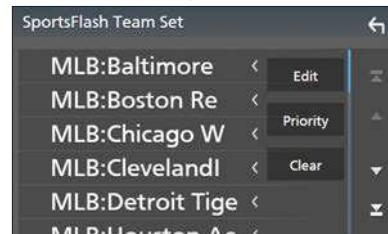

- **Edit**
Sets and removes teams.
- **Priority**
Sets the priority of a team.
- **Clear**
Removes all teams that have been set. Touch **Clear**. When the confirmation screen appears, touch **YES**.

NOTE

- SportsFlash™ is available on SXV300 or later tuner models.
- Up to 50 teams can be added.

Set the SportsFlash™ Team Priority

- 1 Touch **Priority**.

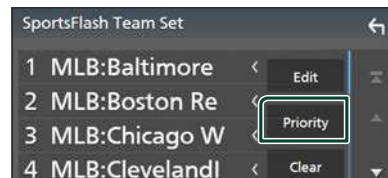

- 2 Set the priority of a team.
Each time you touch a Team, the priority is set of reset.

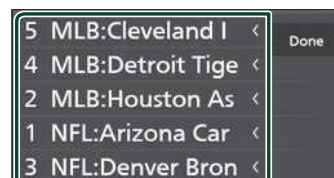

3 Touch Done.



NOTE

- Priority can be set on up to 5 teams.
- When priority has already been set for 5 teams, it cannot be set for any other team. Delete an unnecessary team.

Select a City for Traffic & Weather

You can select a city for which you wish to receive SiriusXM Traffic & Weather broadcasts and hear them from the beginning.

- 1 Touch Traffic & Weather City Select on the SiriusXM SETUP screen.**
- 2 Touch ◀ and ▶ to select a city.**

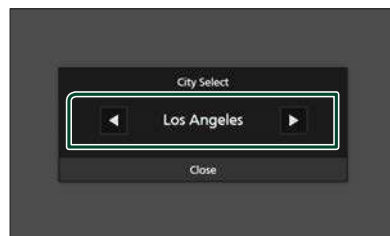

Selecting Featured Bands Update Messages

You can set whether to be notified when the featured seasonal theme is updated.

- 1 Touch Featured Bands Update Messages on the SiriusXM SETUP screen.** Featured Bands Update Messages is turned on or off.

TuneStart™

- 1 Touch Tune Start on the SiriusXM SETUP screen.** The TuneStart is turned on or off. Default is "ON".

Reset

- 1 Touch SiriusXM Reset on the SiriusXM SETUP screen.** Confirmation screen appears.
- 2 Touch YES.** All SiriusXM settings are reset to defaults.

Bluetooth Control

Using the Bluetooth function allows you to use various functions such as listening to the audio file and making/receiving a call.

Information for using Bluetooth® devices



Bluetooth is a short-range wireless radio communication technology for mobile devices such as cell-phones, portable PCs, and other devices.

Bluetooth devices can be connected without cables and communication with each other.

NOTE

- While driving, do not perform complicated operations such as dialing numbers, using the phone book, etc. When you perform these operations, stop your car in a safe place.
- Some Bluetooth devices may not be connected to this unit depending on the Bluetooth version of the device.
- This unit may not work for some Bluetooth devices.
- Connecting conditions may vary depending on your environment.
- Some Bluetooth devices are disconnected when this unit is turned off.
- The Bluetooth devices cannot be used while using Apple CarPlay.
- The Bluetooth currently connected with other device is disconnected when an iPhone compatible with Apple CarPlay is connected.

About the cell-phone and Bluetooth audio player

This unit conforms to the following Bluetooth specifications:

Version

Bluetooth Ver. 5.0

Profiles

Cell-phone:

- HFP (V1.7) (Hands Free Profile)
- SPP (Serial Port Profile)
- PBAP (Phonebook Access Profile)

Audio player:

- A2DP (Advanced Audio Distribution Profile)
- AVRCP (V1.6) (Audio/Video Remote Control Profile)

Sound codec

SBC, AAC

NOTE

- The units supporting the Bluetooth function have been certified for conformity with the Bluetooth Standard according to the procedure prescribed by Bluetooth SIG.
- However, it may be impossible for such units to communicate with your cell-phone depending on its type.

Register the Bluetooth device

It is necessary to register the Bluetooth audio player or cell-phone in this unit before using the Bluetooth function.

You can register up to 10 Bluetooth devices.

NOTE

- Up to 10 Bluetooth devices can be registered. If an attempt is made to register the 11th Bluetooth device, the Bluetooth device connected on the earliest date will be deleted to register the 11th one.
- This unit is compatible with the Apple Easy Pairing function. When an iPod touch or iPhone connected via USB terminal previously is connected again, an authentication dialog appears. Performing operation for authentication on this unit or iOS smartphone registers the smartphone as a Bluetooth device.

1 Press the MENU button.

➤ Popup menu appears.

2 Touch SETUP.



➤ SETUP Menu screen appears.

3 Touch Bluetooth.



➤ Bluetooth SETUP screen appears.

4 Touch Select Device on the Bluetooth Setup screen.



5 Touch + on the Select Device screen.

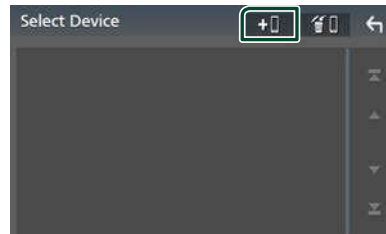

➤ Bluetooth pairing waiting dialog appears.

NOTE

- You can also register an iPhone on the Apple CarPlay Device List screen. **(P.30)**
- When neither Apple CarPlay, Android Auto, nor a Bluetooth Hands-Free phone is connected, pressing and holding the  button displays Bluetooth pairing waiting dialog.

6 Search for the unit ("DDX****"/"DMX****") from your smartphone/cell-phone.

Complete steps 6 to 9 within 30 seconds.

7 Operate your smartphone/cell-phone according to the displayed messages.

- Confirm the request both on the smartphone/cell-phone.

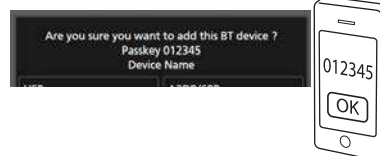

Bluetooth Control

- **Input the PIN Code in your smartphone/cell-phone.**

PIN Code is set to "0000" as the default.



- 8 Select the function you want to use.



- **HFP Hands Free1/Hands Free2/No Connection.**

Select the hands-free number to connect.

- **A2DP/SPP Audio/App**

Select if you want to use the audio player app in your smartphone over A2DP, and the other apps in your smartphone over SPP.

- **PBAP Phonebook DL**

Select if you want to transfer your phonebook data.

- 9 Touch **Yes**.

When data transmission and connection have completed, the Bluetooth connection icon appears on the screen.

Bluetooth Setup

NOTE

- The Bluetooth Setup is disabled while using Apple CarPlay.

- 1 Press the **MENU** button.

➤ Popup menu appears.

- 2 Touch **SETUP**.

➤ SETUP Menu screen appears.

- 3 Touch **Bluetooth**.



➤ Bluetooth SETUP screen appears.
See the following section for each setting.

- Connect the Bluetooth device (**P.68**)
- Change the PIN Code (**P.70**)
- Change the device name (**P.69**)

- 1 **Connect the Bluetooth device**

- 1 Touch **Select Device** on the Bluetooth Setup screen.

- 2 Touch the name of the device you want to connect.

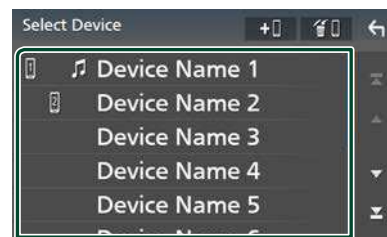

➤ Profile select screen appears.

NOTE

- If the icon is lighted, it means that the unit will use that device.
- You cannot select an Android device connected as an Android Auto device.

3 Set each profile as follows.

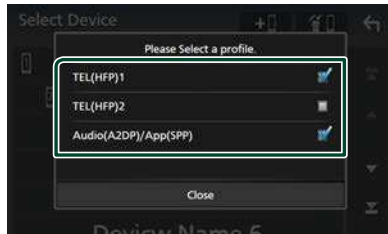

■ **TEL (HFP) 1 , TEL (HFP) 2**

Select when the device is connected with the unit as hands-free phone 1 or 2.

■ **Audio (A2DP)/App (SPP)**

Select to interwork with an application installed in a smartphone or to use as an audio player.

4 Touch **Close**.

To delete the registered Bluetooth device

1 Touch on the Select Device screen.

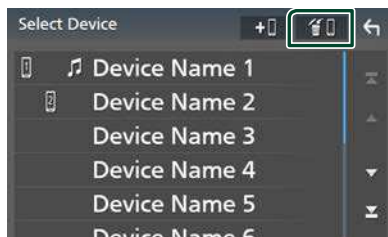

2 Touch the device name to check.

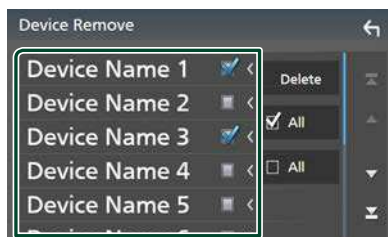

■ **All**

Selects all Bluetooth devices.

■ **All**

Clears all check marks.

NOTE

• You cannot select an Android device connected as an Android Auto device.

3 Touch **Delete**.

➤ Confirmation message appears.

4 Touch **Yes**.

➤ All the selected device(s) is deleted.

NOTE

• If the device compatible with wireless Apple CarPlay is deleted, the same device is deleted from the Apple CarPlay device list screen.

Change the device name

1 Touch **Device Name** on the Bluetooth SETUP screen.

➤ Change Device Name screen appears.

2 Touch and hold .

3 Input the device name.



4 Touch **Enter**.

Bluetooth Control

Change the PIN Code

- 1 Touch **PIN Code** on the Bluetooth SETUP screen.
➤ Change PIN Code screen appears.
- 2 Touch and hold **BS**.
- 3 Input the PIN Code.

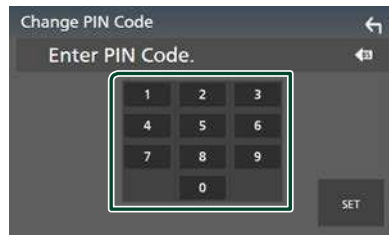

- 4 Touch **SET**.

Playing the Bluetooth Audio Device

Most function can be controlled from the source control screen.

To select Bluetooth source, touch **Bluetooth** icon on the source selection screen. (P.14)

NOTE

- The Bluetooth audio source is disabled while using Apple CarPlay.
- The Bluetooth audio source is disabled when the device set as Audio(A2DP)/App(SPP) is using Android Auto.

Bluetooth basic operation



1 Artwork/VU meter

- Displays/hides artwork area.
- Touch to switch between the artwork and VU meter.

2 Play mode indicator/Playing time

▶, II: Current play mode indicator

Meanings of individual icons are as follows:

- ▶ (play), ▶▶ (fast forward), ◀◀ (fast backward), II (pause), ■ (stop).

3 Operation keys *









- 🔍 : Searches for a file. See **File search** (P.72).
- ◀◀ ▶▶: Searches for the previous/next content.
Touch and hold to fast forward or fast backward. (It will be cancelled automatically after about 50 seconds.)
- ▶ : Plays.
- II : Pauses.
- 📄 : Displays the Bluetooth SETUP screen. (P.68)

-  : Displays the Graphic Equalizer screen. (P.93)

4 KENWOOD Music Mix

Bluetooth audio devices can be switched easily to play music. See **KENWOOD Music Mix** (P.71).

5  /  *

-  : Repeats the current track/folder. Each time you touch the key, repeat modes are switched in the following sequence: File repeat (), Folder repeat (), All songs repeat (), Repeat off ()
-  : Randomly plays all tracks in the current folder. Each time you touch the key, random modes are switched in the following sequence: Folder random (), All random (), Random off ()

6 Information display *

- Displays the name of track information.
- Connected device name.
- Change the text size of the information smaller when the "Small Audio Text" is set to "ON" in the User Interface screen (P.84).





* These items appear only when the audio player which supports AVRCP profile is connected.

NOTE



- The operation buttons, indications and information displayed on the screen differ depending on the connected device.
- If the operation keys do not appear, operate from the player.
- Depending on your cell-phone or audio player, sound may be heard and controlled but text information may not appear.
- If the volume is too low, raise it on your cell-phone or audio player.



KENWOOD Music Mix

Up to 5 Bluetooth audio device can be connected and switched easily to play music.



- 1 Touch  .
 > A list of registered devices is displayed.
- 2 Touch  of device name you want to connect.
 - Touching  displays the Bluetooth device connection setup screen. (P.68)
 - Touching  on the left of the connected device () disconnects this device.



-  : Device used normally.
-  : Device used for KENWOOD MusicMix

- 3 Touch  (white) on the left of the name of the device to be played.
 (white) changes to  (purple) and starts playback.



-  (Gray) : Not connected.
-  (White) : Connected.
-  (Purple) : During playback.

- 4 Touch  .

Bluetooth Control

NOTE

- If a connected Bluetooth audio device is operated to play music, connections are switched.
- When a Bluetooth source is switched to another one, its settings are deleted and the connection is restored to the connection before source switching.
- You cannot select an Android device connected as an Android Auto device.

File search

- 1 Touch **Q**.
- 2 Touch the desired file or folder.

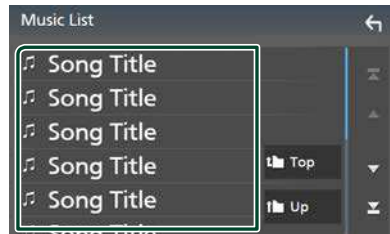

When you touch a folder its contents are displayed.

- 3 Touch the desired item in the content list.
➤ Playback starts.

NOTE

- For operations in the list screen, see **List screen (P.17)**.

Using the Hands-Free Unit

You can use the telephone function by connecting the Bluetooth telephone to this unit.

NOTE

- If you use the hands-free function frequently, move the TEL short-cut button (icon) to the Home screen. **(P.15)**
- While Apple CarPlay or Android Auto is connected, the Bluetooth Hands-Free function and two Bluetooth devices connections cannot be used. Only the Apple CarPlay or Android Auto Hands-Free function can be used.

Make a call

- 1 Press the **HOME** button.
- 2 Touch .
- 3 Touch **TEL**.



➤ Hands Free screen appears.

NOTE

- If your cell-phone supports PBAP, you can display the phone book and call lists onto the touch panel screen when the cell-phone is connected.
 - Phone book: up to 1000 entries
 - Up to 50 entries including dialed calls, received calls, and missed calls

4 Select a dialing method.



- : Call using call records
- : Call using the phonebook
- : Call using the preset number
- : Call by entering a phone number

● **Select the cell-phone to use**

When you connect two cell-phones

- 1) Touch to select the phone you want to use.

● **Bluetooth SETUP**

- 1) Touch .
Bluetooth SETUP screen appears.

● **Voice Recognition**

- 1) Touch . (P.74)

NOTE

- Status icons such as battery and antenna icons may differ from those displayed on the cell-phone.
- Setting the cell-phone in the private mode can disable the hands-free function.

Call using call records

- 1 Touch .
- 2 Select the phone number from the list.

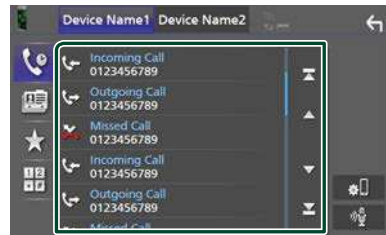

Call using the phonebook

- 1 Touch .
- 2 Touch .
- 3 Select the initial.



- Characters with no corresponding name will not appear.
- A first character with an accent character such as "ü" can be searched for with a non-accent character "u". A character with an accent character in a sentence cannot be searched for.

- 4 Select the person you want to call from the list.

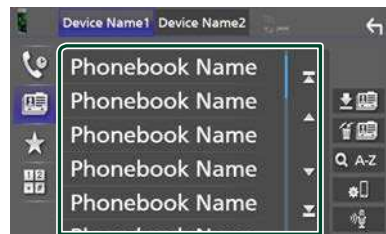

Bluetooth Control

- 5 Select the phone number from the list.



NOTE

• You can sort the phone numbers in the list by last name or first name. For details, see **Hands-Free Setup (P.77)**.

Call using the preset number

- 1 Touch .
- 2 Touch the name or phone number.



Call by entering a phone number

- 1 Touch .
- 2 Enter a phone number with number keys.



- 3 Touch .

Voice Recognition

You can access the voice recognition function of the cell-phone connected to this unit. You can search the cell-phone phonebook by voice. (The functionality depends on the cell-phone.)

- 1 Press the  button for 1 second.

DDX9906XR / DDX8906S / DDX8706S

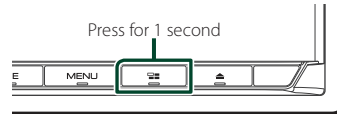

DMX906S / DMX9706S



DDX819WBTL

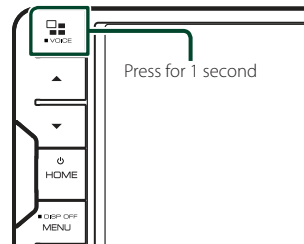

➤ Voice Recognition screen appears.

- 2 Start speaking.

NOTE

• You can use the voice recognition function by touching  on the Hands Free screen.

Bluetooth Control

Receive a call

- 1 Touch to answer a phone call or to reject an incoming call.

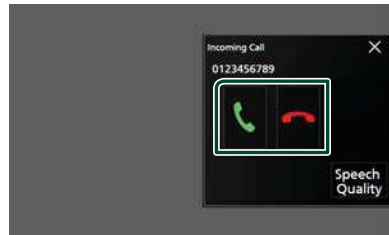

NOTE

- While monitoring the picture from the view camera, this screen does not appear even if a call comes in.

To end call

- 1 While talking, touch .

Operations during a call



● Adjust the volume of your voice

- 1) Touch **Speech Quality**.
- 2) Touch ◀ or ▶ for **Microphone Level**.

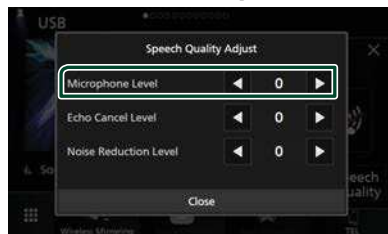

● Adjust the receiver volume

Press the ▼ or ▲ button.

DDX9906XR / DDX8906S / DDX8706S

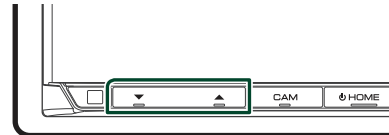

DMX906S / DMX9706S

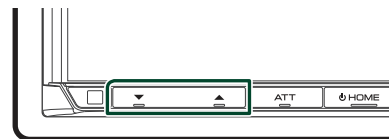

DDX819WBTL

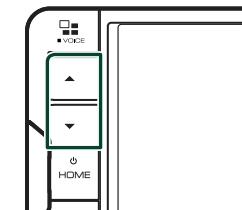

● Mute your voice

Touch to mute or not to mute your voice.

● Output the dial tone

Touch **DTMF** to display the tone input screen. You can send tones by touching desired keys on the screen.

● Switching between speaking voice output destinations

Touching / each time switches speaking voice output destinations between the cell-phone and the speaker.

● Call-waiting

When you receive a new call while talking on the phone, you can answer the newly received call by touching . The current call is put on hold.

Each time you touch , the caller will change to the other one.

When you touch , the current call will end to be switched to the call waiting on hold.

● To close the Hands-Free popup screen

Touching × to close the Hands-Free popup screen.

Bluetooth Control

To display it again

- ① Press the **HOME** button.
- ② Touch .
- ③ Touch **TEL**.

Phone number preset

You can register frequently used phone numbers in this unit.

- 1 Touch .
- 2 Touch **Edit**.



- 3 Select where to preset.

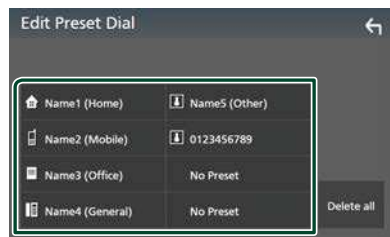

■ Delete all

To delete all preset numbers, touch **Delete all** and then touch **Yes** on the confirmation screen.

- 4 Select how to preset.

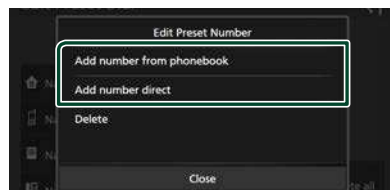

■ Add number from phonebook

Select the number to preset from the phonebook. See **Call using the phonebook (P.73)**.

■ Add number direct

Enter the telephone number directly and touch **SET**. See **Call by entering a phone number (P.74)**.

■ Delete

To delete a preset number, touch **Delete** and then touch **OK** on the confirmation screen.

Phonebook transfer

You can transfer phonebook data from your Bluetooth smartphone using PBAP.

- 1 Touch .
- 2 Touch .



> Phonebook data transfer starts.

NOTE

- If the Phonebook contains more than 1000 entries, Phonebook data cannot be transferred.
- If no Phonebook has been downloaded, touching **Download Phonebook Now** will start downloading the Phonebook.

Phonebook deletion

- 1 Touch .
- 2 Touch the name to check.

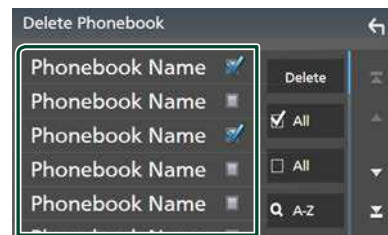

■ All

Checks all boxes.

■ All

Clears all check marks.

Bluetooth Control

- 3 Touch **Delete**.
 - Confirmation message appears.
- 4 Touch **Yes**.

Hands-Free Setup

You can make various settings for the Hands-Free function.

- 1 Press the **MENU** button.
 - Popup menu appears.

- 2 Touch **SETUP**.



➤ SETUP Menu screen appears.

- 3 Touch **Bluetooth**.

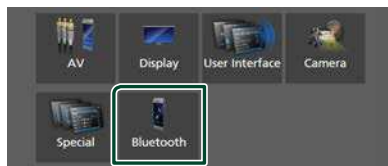

➤ Bluetooth SETUP screen appears.

- 4 Touch **TEL SETUP**.
 - TEL SETUP screen appears.

- 5 Set each function as follows.



Bluetooth HF/Audio

Select the speakers to output the sound from the cell-phone (such as phone call voice and ringing tone) and Bluetooth audio player.

Front: Outputs sound from the front speakers.

All (Default): Outputs sound from all speakers.

Auto Response*

Set the automatic response time to pick-up an incoming call.

OFF (Default): Turns off the Automatic response function.

1/5/10/15/20/25/30: Sets the ringing time (second).

Auto Pairing

When set to "ON", the Apple Auto Pairing function is turned on to automatically register the iPod touch or iPhone connected to this unit.

ON (Default): Turns on the Apple Auto Pairing function.

OFF: Turns off the Apple Auto Pairing function.

Sort Order

Set how to sort the data in the cell-phone phonebook.

First: Sorts data by the first name.

Last (Default): Sorts data by the last name.

* Either the auto response time set on this unit or the time set on the cell-phone, whichever is shorter takes effect.

- 6 Touch **OK**.



Other External Components

View Camera

NOTE

- To connect a camera, see **P.113**.
- To use a rear view camera, a REVERSE lead connection is required. **(P.107)**
- If **Rear Camera Interruption** is active the camera screen is displayed when you shift the gear to the reverse (R) position.

Display the camera screen

- 1 Press the **MENU** button.
 - Popup menu appears.

- 2 Touch **Camera**.

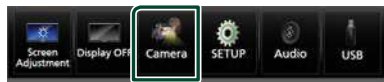

➤ View camera screen appears.

- 3 Adjust each item as follows.

To erase the caution message, touch the screen.

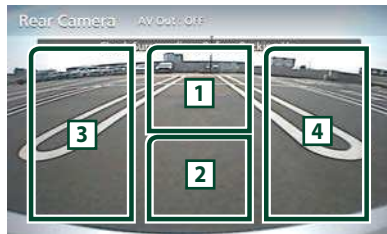

- 1 **Switching the View Camera** *1

Touch to display the camera switching keys. It is necessary to set "Camera Assignment Settings" beforehand. See **To switch the view camera (P.78)**.

- 2 **Camera off**

Touch to exit the camera screen.

- 3 **Switching the Guideline** *2

Touching each time turns on or off the guideline.

- 4 **Switching the Angle** *2

Touching each time changes camera angles.

*1 When two or more cameras of rear, front, left, and right are connected with this unit.

*2 When CMOS-3xx series is connected with this unit.

To switch the view camera

- 1 Touch **1**.

➤ Camera switching keys appear left/right side.

- 2 Select a view camera you want to switch.

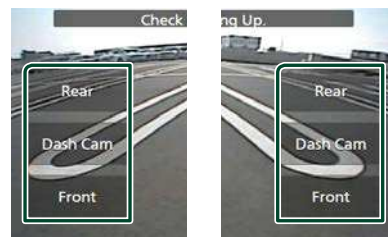

NOTE

- The position to display the camera switching keys is opposite to the setting of **Parking Assist Position (P.84)**
- To switch to the picture other than selectable view camera from the camera switching keys, change the key function of except "Rear" in **Camera Assignment Settings (P.79)**

Camera Setup

- 1 Press the **MENU** button.

➤ Popup menu appears.

- 2 Touch **SETUP**.

➤ SETUP Menu screen appears.

- 3 Touch **Camera**.



➤ Camera screen appears.

4 Set each item as follows.

■ **Camera Assignment Settings**

Set up the camera assignment. See **To set up the camera assignment settings (P.79)**.

■ **Rear Camera Interruption**

ON: Displays the picture from the rear view camera when you shift the gear to the reverse (R) position.

OFF (Default): Select this when no camera is connected.

■ **Rear Camera Settings *1**

Adjusts the CMOS-3xx series with ID 1 ("Rear Camera") set. For details, see the instruction manual of your camera.

■ **Parking Guidelines**

You can display parking guidelines to enable easier parking when you shift the gear to the reverse (R) position.

Default is "ON".

■ **Guidelines SETUP**

If you select **ON** for **Parking Guidelines**, you can adjust the parking guidelines. See **To adjust the parking guidelines (P.80)**.

■ **Front Camera Settings *2**

Adjusts the CMOS-3xx series with ID 2 ("Front Camera") set. For details, see the instruction manual of your camera.

■ **Front Camera Interruption *3**

10 sec / 15 sec (Default) / **20 sec**: The front camera screen is displayed when return the gear from the reverse (R) position.

OFF: Cancel.

*1 When CMOS-3xx series is connected with this unit.

*2 To use the function, it is necessary to connect CMOS-3xx series and to set **Camera Assignment Settings** to **Front**. (P.79)

*3 To use the function, it is necessary to set **Rear Camera Interruption** to **ON** and to set **Camera Assignment Settings** to **Front**. (P.79)

■ **To set up the camera assignment settings**

1 Touch **Camera Assignment Settings** on the Camera screen. (P.78)

2 Set each item as follows.

Except DDX819WBTL

■ **FRONT VIEW CAMERA / DASH CAM**

DDX819WBTL

■ **FRONT VIEW CAMERA**

Set the camera assignment from view camera connected to Front view camera/ Dashboard camera input terminal.

■ **AV-IN**

Set the camera assignment from view camera connected to AV-IN input terminal.

For Front view camera/Dashboard camera input terminal:

1 Touch **FRONT VIEW CAMERA / DASH CAM**. (Except DDX819WBTL)

Touch **FRONT VIEW CAMERA**. (DDX819WBTL)

➤ Displays the picture from view camera connected to Front view camera/ Dashboard camera input terminal.

2 Select the view camera to set up.

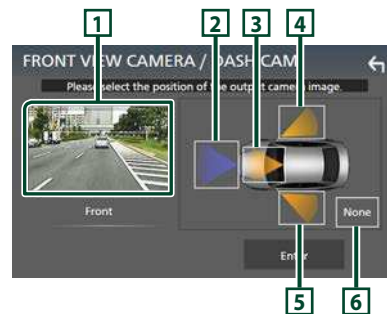

1 **Picture from view camera**

Displays the picture from view camera connected to Front view camera/ Dashboard camera input terminal. (P.113)

2 **Front**

3 **Dashboard Camera**
(Except DDX819WBTL)

Other External Components

- 4 Right
- 5 Left
- 6 None

3 Touch **Enter**.

For AV-IN input terminal:

- 1 Touch **AV-IN**.
 - Displays the picture from view camera connected to AV-IN input terminal.
- 2 Select the view camera to set up.

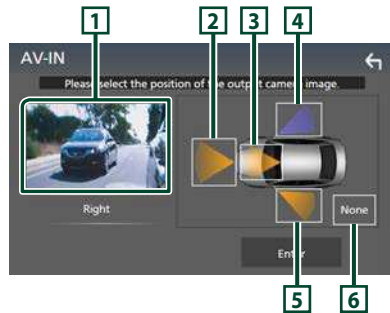

- 1 **Picture from view camera**
Displays the picture from view camera connected to AV-IN input terminal. (P.113)
- 2 **Front**
- 3 **Dashboard Camera**
(Except DDX819WBTL)
- 4 **Right**
- 5 **Left**
- 6 **None**

3 Touch **Enter**.

NOTE

- The Dashboard Camera can be selected when it is connected. (P.113)

To adjust the parking guidelines

NOTE

- Install the rear view camera in the appropriate position according to the instruction manual supplied with the rear view camera.
- When adjusting the parking guidelines, make sure to apply the parking brake to prevent the car from moving.

- 1 Touch **Parking Guidelines** in the Camera screen and set to **ON**. (P.78)
- 2 Touch **Guidelines SETUP** on the Camera screen.
- 3 Adjust the parking guidelines by selecting the mark.



4 Adjusting the position of the selected mark.

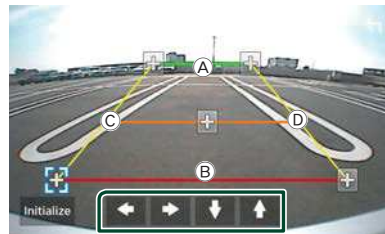

Make sure that lines (A) and (B) are horizontally parallel, and that lines (C) and (D) are of the same length.

NOTE

- Touch **Initialize** and then touch **Yes** to set all the marks to their initial default position.

Use Dashboard Camera (Except DDX819WBTL)

A Dashboard Camera, DRV-N520 (optional accessory), connected to this unit lets you play video-recorded data and so on.

For details, see the instruction manual of the Dashboard Camera DRV-N520 (optional accessory).

NOTE

- To connect a dashboard camera, see **P.113**.
- To use the dashboard camera function, it is necessary to set "Camera Assignment Settings" to "Dashboard Camera". (**P.79**)

Display the dashboard camera screen

- 1 Press the **MENU** button.
➤ Popup menu appears.
- 2 Touch **Camera**.

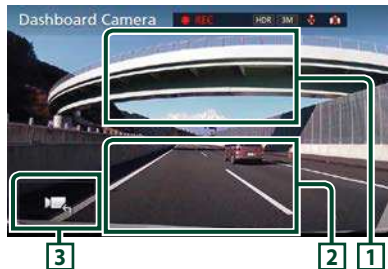

- 1 **Switching the View Camera**
Touch to display the camera switching keys. It is necessary to set "Camera Assignment Settings" beforehand. See **To switch the view camera (P.78)**.
- 2 **Camera off**
Touch to exit the camera screen.
- 3 **Key display**
Touch to display the dashboard camera control keys.

External audio/video players (AV-IN)

- 1 Connect an external component to the **AV-IN** input terminal. (**P.109**)
- 2 Select **AV-IN** as the source. (**P.14**)
- 3 Turn on the connected component and start playing the source.

NOTE

- To select the AV-IN source, it is necessary to set "AV-IN" to "None" in **Camera Assignment Settings**. (**P.79**)

TV tuner (DDX819WBTL)

You can connect the TV tuner (commercially available) with this unit and watch TV.

Preparation

- When you use TV control function, connect the TV tuner (commercially available) and set 3rd Party TV Tuner Control in **AV Setup (P.88)** to ON.
- The TV tuner can be controlled with its supplied remote control through the remote sensor on the front panel of this unit.

- 1 Select **TV** as the source. (**P.14**)
- 2 Touch **Key display area**.

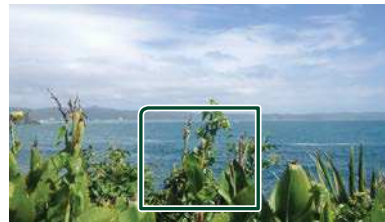

Other External Components







- **Hides the indicators and buttons.**
Touch **Hide**.
- **Change the channel.**
Touch **CH▲**, **CH▼**.

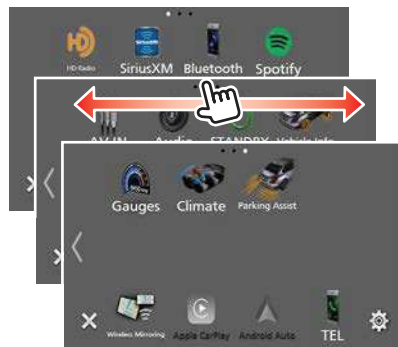

OEM Features Operation (Except DDX819WBTL)

By connecting this unit to the bus system of the vehicle using an iDataLink (commercially available), this unit can access the satellite radio source provided for the vehicle and can display vehicle information on this unit.

- 1 Press the **HOME** button.
➤ HOME screen appears.
- 2 Touch  on the HOME screen.
- 3 Touch icon.



	• Displays the control screen of the Bluetooth Hands Free function provided for the vehicle.
	• Displays information about the tire pressures of the vehicle. *
	• Displays the control screen of the satellite radio source provided for the vehicle.
	• Displays the control screen of the media player source provided for the vehicle.
	• Displays the control screen of the Bluetooth streaming source provided for the vehicle.
	• Displays information about the Radar Detector. *
	• Displays information about the instruments such as a speedometer.

	• Displays information about the air conditioner of the vehicle. *
	• Displays information about the Parking Distance Sensor of the vehicle.

* These ADS adapter features are displayed as the widget on the Home screen. **(P.13)** You can display the relevant screens by touching the widget.

NOTE

- Displayable screens, button names, and screen names vary depending on the type of the connected iDataLink and the model of the vehicle. For more details, access the following URL:
www.idatalink.com/

Setup

Monitor Screen Setup

You can adjust the image quality of video, menu screen, etc.

- 1 Press the **MENU** button.
➤ Popup menu appears.
- 2 Touch **Screen Adjustment**.



➤ Screen Adjustment screen appears.

- 3 Adjust each setting as follows.

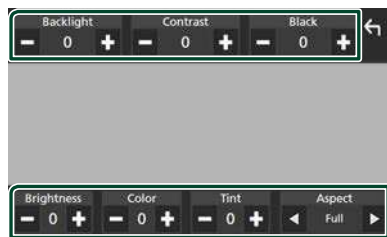

■ Backlight/Contrast/Black/ Brightness/Color/Tint

Adjust each setting.

■ Aspect

Select a screen mode.

Full: Changes the aspect ratio of video and displays video fully on the screen.

Normal: Displays video at the ratio of 4:3.

Auto:

DVD, VCD and disc media: 16:9 video is displayed in the Full mode and 4:3 video is displayed in the Regular mode.

USB device: Displays video fully (vertically or horizontally) with no ratio change.

NOTE

- Settings to adjust vary depending on the current source.

System Setup

- 1 Press the **MENU** button.
➤ Popup menu appears.
- 2 Touch **SETUP**.



See the following section for each setting.

- Set up AV (**P.88**)
- Set up display (**P.86**)
- Set up the user interface (**P.84**)
- Set up camera (**P.78**)
- Set up special (**P.86**)
- Set up Bluetooth (**P.68**)
- Set up security (**P.9**) (DDX819WBTL only)

Setup

User Interface Setup

You can setup user interface parameters.

- 1 Press the **MENU** button.
➤ Popup menu appears.

- 2 Touch **SETUP**.
➤ SETUP screen appears.

- 3 Touch **User Interface**.

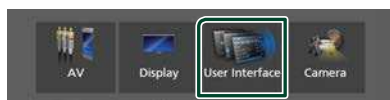

➤ User Interface screen appears.

- 4 Set each parameter as follows.

■ Small Audio Text

Change the text size for the source control screen.

ON : Change the text size smaller.

OFF (Default): Cancel.

■ Steering Remote Controller (DDX819WBTL)

Sets the desired function in the steering remote controller.

See **Learning function of steering remote.** (P.85)

■ Beep (Except DDX9906XR)

Turn the key touch tone on or off.

Default is "ON".

■ Beep Volume (DDX9906XR)

Set the sound volume of the key touch tone.

"0" (Off) – "3" (Default) – "5"

■ Widget SETUP

Set up the widget displayed on the Home screen. (P.20)

■ Parking Assist Display (Except DDX819WBTL)

When an ADS adapter is connected, you can display information about obstacles around the car.

ON: Always displays information.

Dyn. (Default): Displays information when the sensor detects obstacles.

OFF: Cancels this function.

This can be set when the iDataLink (commercially available) is connected.

■ Parking Assist Position (Except DDX819WBTL)

Select where to display information about obstacles on the screen (left or right).

"Left"/"Right" (Default)

This can be set when the iDataLink (commercially available) is connected.

■ Language Select

Select a language.

■ Touch Panel Adjust (DDX8706S / DDX819WBTL / DMX9706S)

Adjust the sensing position of the touch panel. (P.85)

■ Time Format

Select the time display format.

"12-Hour" (Default)/"24-Hour"

■ Clock

GPS-SYNC (Default): Synchronizes the clock time with the GPS. (Except DDX819WBTL)

RDS-SYNC: Synchronizes the clock time with the RDS. (DDX819WBTL only)

Manual: Set the clock manually.

■ Time Zone

If you have selected **Manual** for Clock, select the time zone.

■ Clock Adjust

If you select **Manual** for Clock, adjust the date and time manually. (P.84)

Adjust the date and time manually

- 1 Touch **Clock** on the User Interface screen.

- 2 Select **Manual**.

- 3 Touch **Time Zone** on the User Interface screen.

- 4 Select the time zone.

- 5 Touch **Clock Adjust** on the User Interface screen.

6 Adjust the date, then adjust the time.

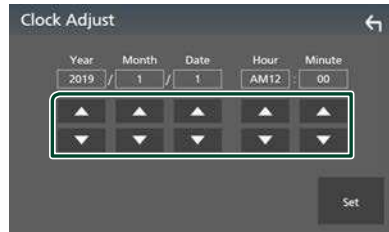

7 Touch **Set**.

Touch panel adjustment

1 Touch **Touch Panel Adjust** on the User Interface screen.

➤ Touch Panel Adjust screen appears.

2 Follow the instruction on the screen and long touch the center of each .



NOTE

- To cancel the touch panel adjustment, touch **Cancel**.
- To reset it to the default, touch **Reset**.

Learning function of steering remote (DDX819WBTL)

This function is available only when your vehicle is equipped with the electrical steering remote controller.

If your steering remote controller is not compliant, learning may not be completed and error message may appear.

1 Touch **Steering Remote Controller** in the User Interface screen.

➤ Steering Remote Controller Setting screen appears.

2 Press and hold the steering remote controller button.

NOTE

- You can have the unit learned all buttons at a time. In that case, press the all buttons one at a time and after pressing all of them, touch **Learning completed** in Steering Remote Controller Setting screen. However, new functions cannot be learned after this operation.

3 Touch the function you want to set.

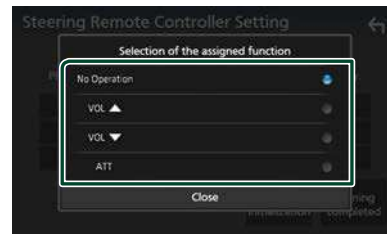

4 Repeat steps 2 and 3 as necessary.

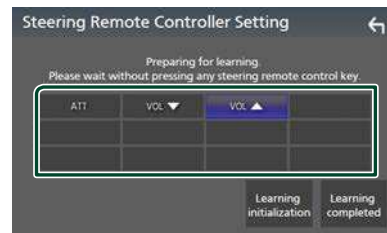

5 Touch **Learning completed**.

NOTE

- When changing the function already learned, press and hold the button you want to change in step 2 and then touch to select the changed function from the function list.
- Confirm the contents of the settable function on the function list. You cannot edit the function list.
- To initialize the contents, touch **Learning initialisation of Steering Remote Controller** in User Interface screen. After you touch **Initialise**, a confirmation message appears. Follow the message and complete the operation.

Setup

Special Setup

You can setup special parameters.

- 1 Press the **MENU** button.
➤ Popup menu appears.

- 2 Touch **SETUP**.
➤ SETUP screen appears.

- 3 Touch **Special**.



➤ Special screen appears.

- 4 Set each parameter as follows.

■ DEMO

Select the demonstration mode. Default is "ON".

■ Software Information

Confirm the software version of this unit. (P.86)

■ Open Source Licenses

Display the open source licenses.

■ Initialize

Touch **Initialize** and then touch **Yes** to set all the settings to the initial default settings.

- Audio SETUP Memory is not initialized.

■ Software Information

You can confirm the software version of this unit.

- 1 Touch **Software Information** in the Special screen.

- 2 Confirm the software version.

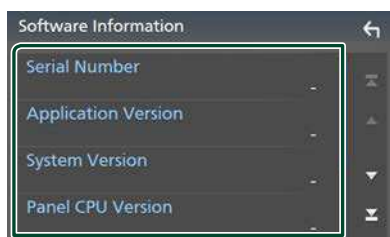

NOTE

- For how to update the software, see the relevant update procedure manual which comes with the software.

Display Setup

- 1 Press the **MENU** button.
➤ Popup menu appears.

- 2 Touch **SETUP**.
➤ SETUP screen appears.

- 3 Touch **Display**.



➤ Display screen appears.

- 4 Set each parameter as follows.

■ Dimmer

Select the dimmer mode.

OFF: Does not dim the display and keys.

ON: Dims the display and keys.

SYNC (Default): Turns the dimmer function on or off when the vehicle light control switch is turned on or off.

■ OSD Clock

Select if you want to display the clock while the screen is off, or while watching DVD video and video files (USB, Disc media), etc.

■ Key Color

You can set the key illumination color.

(P.87)

■ Wallpaper Customize

You can change the wallpaper image or color. (P.87)

■ Viewing Angle (DMX906S / DMX9706S)

If it is hard to see the image on the screen evenly, adjust the viewing angle. The smaller the (negative) value, the more whitish the image on the screen looks.

"0" (Default) / "-1" / "-2" / "-3"

■ Screen transition effect

Select whether to use the screen transition effect when the source control screen is switched to the Home screen.
"ON" (Default)/"OFF"

■ Customizing the key color

You can set the key illumination color.

- 1 Touch **Key Color** on the Display screen.
- 2 Touch the desired color.



■ User

The color you have set in the process of **Adjust** is registered.

■ Scan

You can set the key color to continuously scan through the color spectrum.

■ Car Color (Except DDX819WBL)

This can be selected when a compatible ADS adapter is connected.

- 3 Touch .

To register an original color

You can register your original color.

- 1 Touch **User** on the Key Color screen.
- 2 Touch **Adjust**.
- 3 Use **-** and **+** to adjust each color value.

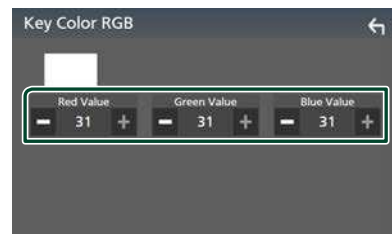

- 4 Touch .

■ Change the wallpaper image or color

- 1 Touch **Wallpaper Customize** on the Display screen.
- 2 Select an image.



*1 The album art currently being displayed is used as a wallpaper.

*2 Select a wallpaper color in advance.

*3 Select an original image in advance.

To select wallpaper color

- 1 Touch **Wallpaper Color** on the Background screen.
- 2 Select a wallpaper color.

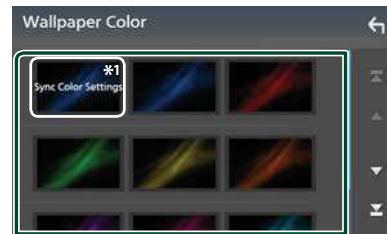

*1 The color you have selected at **Key Color** is added on the image. If you select "Scan" at **Key Color**, you cannot select this image.

- 3 Touch .

Setup

To register an original image

You can load an image from the connected USB device and set it as the wallpaper image. Before starting this procedure, it is necessary to connect the device which has the image to load.

- 1 Touch **User1 Select** or **User2 Select** on the Wallpaper Customize screen.
- 2 Select the image to load.

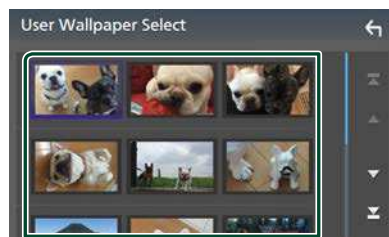

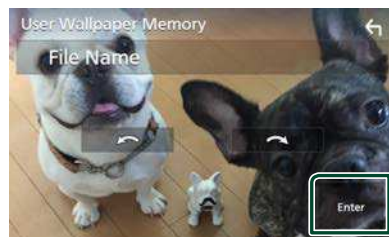

- 3 Touch **Enter**.



- The selected image is loaded and the display returns to the Wallpaper Customize screen.

NOTE

- Touching  rotates the image counter-clockwise.
- Touching  rotates the image clockwise.
- Picture files: JPEG (.jpg, .jpeg), PNG (.png), BMP (.bmp)

AV Setup

You can set AV parameters.

- 1 Press the **MENU** button.
 - Popup menu appears.
- 2 Touch **SETUP**.
 - SETUP screen appears.
- 3 Touch **AV**.



- AV screen appears.

- 4 Set each parameter as follows.

■ Android Auto Device Select (Except DDX819WBTL)

Select the device to be used in the Android Auto mode. (P.33)

■ Apple CarPlay Device List

Select the device to be used in the Apple CarPlay mode. (P.30)

■ Speech Quality Adjust

Adjust the speech quality.

Microphone Level : Adjust the level of microphone gain. Default is "0".

Echo Cancel Level : Adjust the level of echo cancellation. Default is "0".

Noise Reduction Level : Reduce the noise generated in the surrounding environment without changing the microphone volume. Use this function when the voice of caller is not clear. Default is "0".

■ TV Tuner Control (DDX819WBTL)

Sets when connecting the TV tuner to AV-IN input terminal. (P.109)

To use this function, it is necessary to set "AV-IN" to "None" in **Camera Assignment Settings**. (P.79)

ON : Set to ON when connecting the 3rd party TV tuner. AV-IN Name is set to TV. If you connect the TV tuner made by DOS and watch TV, you can perform some simple operations by touching the screen of this unit.

OFF (Default): Set to OFF when not connecting the 3rd party TV tuner.

■ AV-OUT

You can select an AV source to be output from the AV OUTPUT port.

OFF, AV-IN, DISC (DDX9906XR / DDX8906S / DDX8706S / DDX819WBTL only), USB or iPod

- You cannot select AV-IN if the AV-IN input terminal is used for camera.
- You cannot select iPod if it is connected via Bluetooth.
- If you select USB, iPod, DISC (Music CD/Disc media), Spotify, Pandora or Bluetooth audio as the main source, you cannot select USB or iPod as the AV output source.
- If you select Wireless Mirroring, Apple CarPlay or Android Auto as the main source, you cannot select DISC (Music CD/Disc media), USB or iPod as the AV output source.

■ Driving Position

Select the driving position (left or right).

“Left” (Default)/“Right”

■ Wi-Fi SETUP (Except DDX819WBTL)

You can change the device name and display the device address, password. See **Change the device name (P.89)**.

■ OEM SETUP (Except DDX819WBTL)

Confirm the information about or change the settings for using the ADS adapter.

📄 Change the device name

- 1 Touch **Wi-Fi SETUP** on the AV screen.
- 2 Touch **Device Name**.
➤ Change Device Name screen appears.
- 3 Touch and hold **BS**.
- 4 Input the device name.



- 5 Touch **Enter**.

Controlling Audio

You can adjust various settings such as audio balance or subwoofer level.

- 1 Press the **MENU** button.
➤ Pop up menu appears.

- 2 Touch **Audio**.



See the following section for each setting.

- Set up speaker / X'over (P.91)
- Controlling equalizer (P.93)
- Set listening position / DTA (P.97)
- Controlling general audio (Fader / Balance) (P.93)
- Set volume offset (P.94)
- Performing zone control (P.95)
- Set sound effect (P.96)
- Memory/recall the audio settings (P.98)

3-way speaker system setup (DDX9906XR / DDX8906S / DDX819WBTL / DMX906S)

Select the appropriate crossover network mode for the speaker system used (2-way or 3-way speaker system).

- 1 Press the **HOME** button.
➤ HOME screen appears.
- 2 Touch .
➤ Source selection screen appears.

- 3 Touch **STANDBY**.

- 4 Press the button ① followed by the button ② for 1 second at the same time.

DDX9906XR / DDX8906S



DMX906S



DDX819WBTL

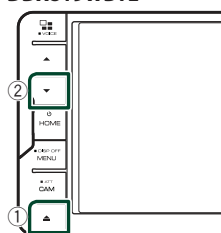

- Speaker system select screen appears.

- 5 Select the crossover network mode.

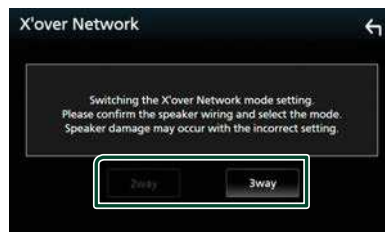

- A confirmation screen appears.

- 6 Touch **Yes**.

NOTE

- When the 3-way speaker system is selected, the following functions are disabled.
 - Front focus of Listening Position / DTA
 - Fader for Controlling General Audio
 - Zone Control
 - Selection of the speakers to output sound from the cell-phone of Bluetooth HF/Audio
 - Beep for User Interface Setup
- Connecting 3-way speakers with the 2-way mode selected can break the speakers.

Speaker / X'over setup

- 1 Press the **MENU** button.
 > Popup menu appears.
- 2 Touch **Audio**.
 > Audio screen appears.
- 3 Touch **Speaker / X'over**.



- 4 Select a car type.
 You can select the car type and speaker network, etc.
 When you select your car type, the Delay Time Alignment is activated automatically (for timing adjustment of sound output for each channel) to have the highest surround effects.



- 5 Touch the speaker (1) you wish to adjust and set each parameter (2) as follows.

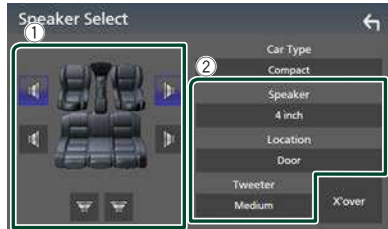

- **Speaker**
 You can select a speaker type and its size to get the best sound effects.
 When the speaker type and size are selected, the speaker crossover network is set automatically.
- **Location (Only for Front, Rear)**
 Select the speaker position you have installed.

- **Tweeter (Only for Front)**
 You can set up the tweeter when you are selecting front speakers.
 None, Small, Medium, Large

- **X'over**
 Display the speaker crossover setup screen.
 You can adjust the crossover frequency that was set automatically when you selected the speaker type.
 For details, see **Crossover network setup (P.91)**

When Speaker network is set to 3-way:

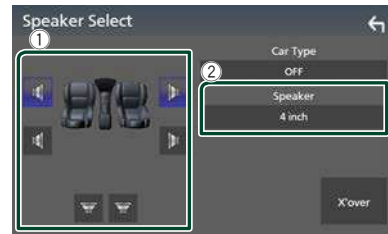

NOTE

- For how to switch to the 3-way speaker system, see **3-way speaker system setup (P.90)**.
 Connecting 3-way speakers with the 2-way mode selected can break the speakers.
- Select "None" if you have no speakers.

Crossover network setup

You can set the crossover frequency of speakers.

- 1 Touch **X'over**.



- 2 Touch the speaker to set up.



Controlling Audio

3 Set each parameter as follows.

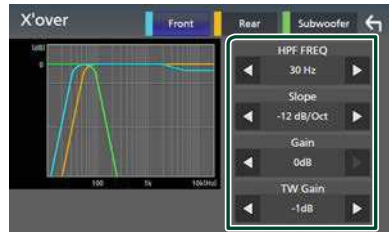

■ HPF FREQ

High Pass Filter adjustment. (When Front or Rear is selected on the Speaker Select screen)

■ LPF FREQ

Low Pass Filter adjustment. (When Subwoofer is selected on the Speaker Select screen)

■ Slope *1

Set a crossover slope.

■ Gain

Adjust the gain of the front speaker, rear speaker, or subwoofer.

■ TW Gain *2

Adjust the tweeter level. (When Front is selected on the Speaker Select screen)

■ Phase Inversion *3

Set the phase of subwoofer output.
Check **Phase Inversion** to shift the phase 180 degrees. (When Subwoofer is selected on the Speaker Select screen)

*1 Only when "LPF FREQ"/"HPF FREQ" is set to a mode other than "Through" in **X'over**.

*2 Only when "Tweeter" is set to "Small", "Medium", "Large" in **Speaker Setup**.

*3 Only when "Subwoofer" is set to a mode other than "None" in **Speaker Setup**.

When Speaker network is set to 3-way:

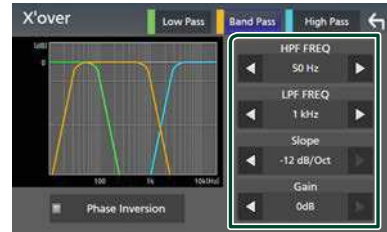

■ FREQ (High Pass)

High Pass Filter adjustment.

■ HPF FREQ, LPF FREQ (Band Pass)

Band Pass Filter adjustment. (When Mid Range Speaker is selected on the Speaker Select screen)

■ FREQ (Low Pass)

Low Pass Filter adjustment. (When Woofer is selected on the Speaker Select screen)

■ Slope *1 *2

Set a crossover slope.

■ Gain

Set the gain of each speaker.

■ Phase Inversion

Set the phase of tweeter, mid range, and woofer output.

Check **Phase Inversion** to shift the phase 180 degrees.

*1 Only when "LPF FREQ"/"HPF FREQ" (Band Pass) is set to a mode other than "Through" in **X'over**.

*2 Only when "FREQ" (Low Pass) is set to a mode other than "Through" in **X'over**.

NOTE

- For how to switch to the 3-way speaker system, see **3-way speaker system setup (P.90)**. Connecting 3-way speakers with the 2-way mode selected can break the speakers.

Controlling General Audio

- 1 Press the **MENU** button.
 > Popup menu appears.
- 2 Touch **Audio**.
 > Audio screen appears.
- 3 Touch **Fader / Balance**.



- 4 Set each parameter as follows.

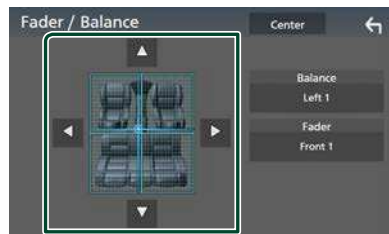

■ Fader / Balance

Adjust the volume balance around the touched area.

◀ and ▶ adjust the right and left volume balance.

▲ and ▼ adjust the front and rear volume balance.

■ Center

Clear the adjustment.

Equalizer Control

You can adjust equalizer by selecting the optimized setting for each category.

- 1 Press the **MENU** button.
 > Popup menu appears.
- 2 Touch **Audio**.
 > Audio screen appears.
- 3 Touch **Equalizer**.



- 4 Touch the screen and set the Graphic Equalizer as desired.

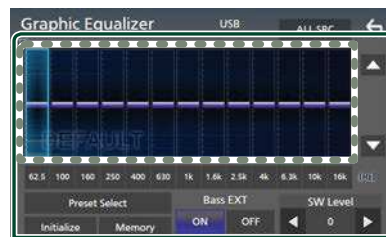

■ Gain level (area in dotted frame)

Adjust the gain level by touching each frequency bar.

You can select a frequency bar and adjust its level by ▲, ▼.

■ Preset Select

Display the screen for selecting the preset equalizer curve. (P.94)

■ Memory

Saves the adjusted equalizer curve as "User1" to "User4". (P.94)

■ Initialize

Initialize (flatten) the current EQ curve.

■ ALL SRC

Apply the adjusted equalizer curve to all sources. Touch **ALL SRC** and then touch **OK** on the confirmation screen.

■ Bass EXT (Bass Extend Settings)

When turned on, the frequencies lower than 62.5 Hz is set to the same gain level (62.5 Hz).

Controlling Audio

■ SW Level

Adjust the subwoofer volume. This setting is not available when Subwoofer is set to "None". See **Speaker / X'over setup (P.91)**.

■ Recall the EQ curve

- 1 Touch **Preset Select**.
- 2 Select an EQ curve.



NOTE

- **iPod** is available for the iPod, Apple CarPlay, Spotify, and Pandora sources and it is connected via USB.

■ Save the EQ curve

- 1 Adjust the EQ curve.
- 2 Touch **Memory**.
- 3 Select where to save.

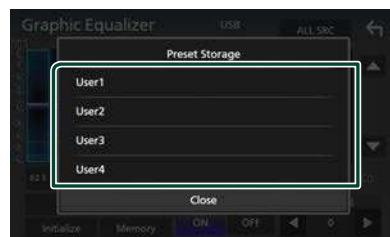

Volume Offset

Finely adjust the volume of the current source to minimize the difference in volume between different sources.

- 1 Press the **MENU** button.
 - Popup menu appears.
- 2 Touch **Audio**.
 - Audio screen appears.
- 3 Touch **Volume Offset**.

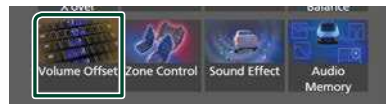

- 4 Touch **+ or -** to adjust the level.



■ Initialize

Returns to the initial settings.

NOTE

- If you have increased the volume first, then reduce the volume using "Volume Offset". Switching the current source to another source suddenly may output extremely loud sound.

Zone Control

You can select different sources for front and rear positions in the vehicle.

1 Press the MENU button.

➤ Popup menu appears.

2 Touch Audio .

➤ Audio screen appears.

3 Touch Zone Control .



➤ Zone Control screen appears.

4 Touch Zone Select .



5 Touch Dual Zone .



6 Set each source as follows.

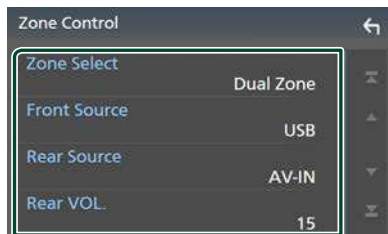

■ Zone Select

Touch **Single Zone** to turn off the dual zone function.

■ Front Source, Rear Source

Select an audio source for each.
Rear Source;
"AV-IN"/"DISC"/"iPod"/"USB"/"OFF"

■ Rear VOL.

Adjust the rear source volume.

NOTE

- When the rear speaker sound is switched, the audio source that is output at the AV OUTPUT terminal is also switched to the same source.
- When the dual zone function is set to on, the following functions are not available.
 - Output from the subwoofer
 - Subwoofer Level/Bass Boost (P.96)
 - Equalizer Control/Sound Effect/Listening Position (P.93, 96, 97)
 - Speaker Setup (P.91)
 - High-resolution Sound Source File Playback
- You cannot select AV-IN if the AV-IN input terminal is used for camera.
- You cannot select iPod if it is connected via Bluetooth.
- If you select Radio, HD Radio, USB, iPod, Disc (Music CD/Disc media), Spotify, Pandora or Bluetooth audio as the Front Source, you cannot select USB, iPod, DISC (Music CD/Disc media) as the Rear Source.
- If you select Wireless Mirroring, Apple CarPlay or Android Auto as the Front Source, you cannot select DISC (Music CD/Disc media), USB or iPod as the Rear Source.

Controlling Audio

Sound Effect

You can set sound effects.

- 1 Press the **MENU** button.
➤ Popup menu appears.
- 2 Touch **Audio**.
➤ Audio screen appears.
- 3 Touch **Sound Effect**.

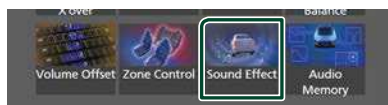

- 4 Set each parameter as follows.



■ Bass Boost

Set the amount of bass boost "OFF"/"1"/"2"/"3".

■ Loudness

Set the amount of boost of low and high tones.

"OFF", "Low", "High"

■ Drive Equalizer

Reduces the driving noise by raising the bandwidth.

"OFF", "ON"

■ Space Enhancer

Select the feeling of sound space enhancement.

"OFF"/"Small"/"Medium"/"Large".

This setting is not available for the HD Radio tuner source.

■ Supreme

Turn ON/OFF the Supreme function.

Technology to extrapolate and supplement with proprietary algorithm, the high-frequency range that is cut off when encoding.

■ Realizer

Virtually make the sound more realistic using the Digital Signal Processor (DSP) system.

Select the level from "OFF"/"1"/"2"/"3".

■ Stage EQ

You can adjust the height of speakers virtually to suit your listening position.

"OFF"/"Low"/"Middle"/"High".

Listening Position / DTA

Listening Position / DTA allows you to improve the sound field depending on the position of the seat you sit.

Listening Position / DTA allows you to set "Listening Position" and "Front Focus". You cannot set both at the same time.

- 1 Press the **MENU** button.
 - Pop-up menu appears.
- 2 Touch **Audio**.
 - Audio screen appears.
- 3 Touch **Position / DTA**.



- Set up Listening Position (P.97)
- Set up Front Focus (P.97)

Listening Position

Adjust the sound delay time so that the sounds from different speakers arrive at the listener sitting on the selected seat at the same time.

- 1 Touch **Listening Position** on the Position / DTA screen.
- 2 Select a listening position from **Front R** (Right front), **Front L** (Left front), **Front All** (All front), and **All**.

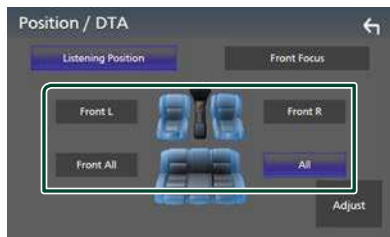

Position DTA control

You can fine-adjust your listening position.

- 1 Touch **Adjust**.
- 2 Touch **Delay**.

- 3 Touch ◀ or ▶ to adjust the delay time of the selected speaker.



- 4 Touch **Level**.
- 5 Touch ◀ or ▶ to adjust the sound level of the selected speaker.



NOTE

- To initialize the Delay and Level settings, touch **Initialize** and **YES** on the confirmation screen.

Front Focus

You can focus the imaginary sound image on the front of the selected seat.

- 1 Touch **Front Focus** in the Position / DTA screen.
- 2 Select a front focus position. For **Front All** and **All**, select Priority L or R depending on which side you want to put the imaginary sound image.

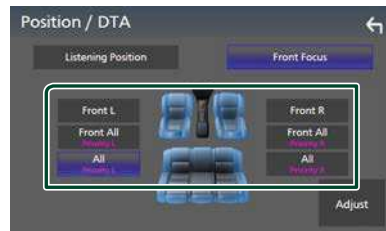

Controlling Audio

Front Focus fine adjustment

- 1 Touch **Adjust**.
- 2 Touch **Delay**.
- 3 Set each parameter as follows.

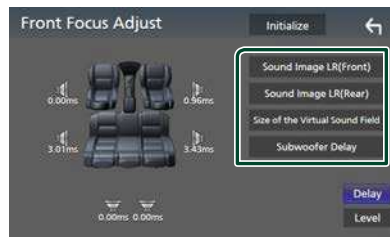

- **Sound Image LR (Front)**
Focus the sound image on the front of front seats.
- **Sound Image LR (Rear)**
Focus the sound image on the front of rear seats.
- **Size of the Virtual Sound Field**
Adjust the size of sound image to meet your taste. If the sound image is shifted from the front, move it back by **Sound Image LR (Front)** or **Sound Image LR (Rear)**.
- **Subwoofer Delay**
Adjust the delay time of subwoofer sound.

- 4 Touch **Level**.
- 5 Touch ◀ or ▶ to adjust the sound level of the selected speaker.



NOTE

- To initialize the Delay and Level settings, touch **Initialize** and **YES** on the confirmation screen.

Audio Setup memory

Audio Control settings can be memorized. The memorized settings can be recalled at any time.

- 1 Press the **MENU** button.
▶ Popup menu appears.
- 2 Touch **Audio**.
▶ Audio screen appears.
- 3 Touch **Audio Memory**.

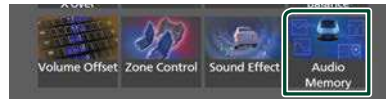

- **SETUP Memory**
Lock or unlock the Audio SETUP Memory/Recall/Clear.
- **Audio SETUP Memory**
Memorize the current audio settings.
 - Fader / Balance, Speaker / X'over, Equalizer (User Preset, SW Level), Position / DTA, Sound Effect (**P.90**)
- **Audio SETUP Recall**
Recall the memorized audio setting.
- **Audio SETUP Clear**
Clear the Audio SETUP Memory and the currently memorized audio settings.

Remote control

This unit can be operated using the remote control.

For DDX819WBTL, the remote control is supplied with the unit.

For DDX9906XR, DDX8906S, DDX8706S, DMX906S and DMX9706S, the remote control is the optional accessory (KNA-RCDV331).

⚠ CAUTION

- Put the remote control in a place where it will not move during braking or other operations. A dangerous situation could result, if the remote control falls down and gets wedged under the pedals while driving.
- Do not leave the battery near fire or under direct sunlight. A fire, explosion or excessive heat generation may result.
- Do not recharge, short, break up or heat the battery or place it in an open fire. Such actions may cause the battery to leak fluid. If spilled fluid comes in contact with your eyes or on clothing, immediately rinse with water and consult a physician.
- Place the battery out of reach of children. In the unlikely event that a child swallows the battery, immediately consult a physician.

Battery Installation

If the remote control operates only over shorter distances or does not operate at all, it is possible that the batteries are depleted. In such instances, replace the both batteries with new ones.

- 1 Insert two "AAA"/"R03"-size batteries with the ⊕ and ⊖ poles aligned properly, following the illustration inside the case.

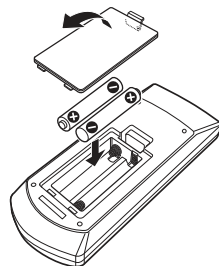

Functions of the Remote control Buttons

Switch the operation mode

The functions operated from the remote control differ depending on the position of the mode switch.

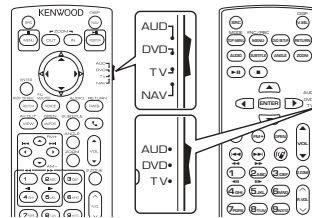

■ AUD mode

Switch to this mode when controlling a selected source or tuner source, etc.

■ DVD mode

Switch to this mode when playing a disc media including DVD, VCD, and CD.

■ NAV mode/TV mode

Not used.

NOTE

- When controlling a player that is not integrated in the unit, select "AUD" mode.

Direct search mode

Using the remote control, you can jump directly to the desired file, track chapter, etc. by entering the number corresponding to the content.

NOTE

- This operation cannot be performed for the USB device and iPod.

- 1 Press the **#BS/DIRECT** button several times until the desired content appears.

The available contents are different depending on the source type.

Remote control

- **DVD**
Title number/Chapter number
- **VCD 1.X and 2.X (PBC OFF)**
Track number
- **VCD 2.X (PBC ON)**
Scene number/Track number
- **Music CD**
Track number
- **Radio**
(DDX8706S / DDX819WBTL /
DMX9706S)
Frequency value

- **HD Radio tuner**
(DDX9906XR / DDX8906S / DMX906S)
Frequency value/Channel number
- **SiriusXM (Except DDX819WBTL)**
Channel number

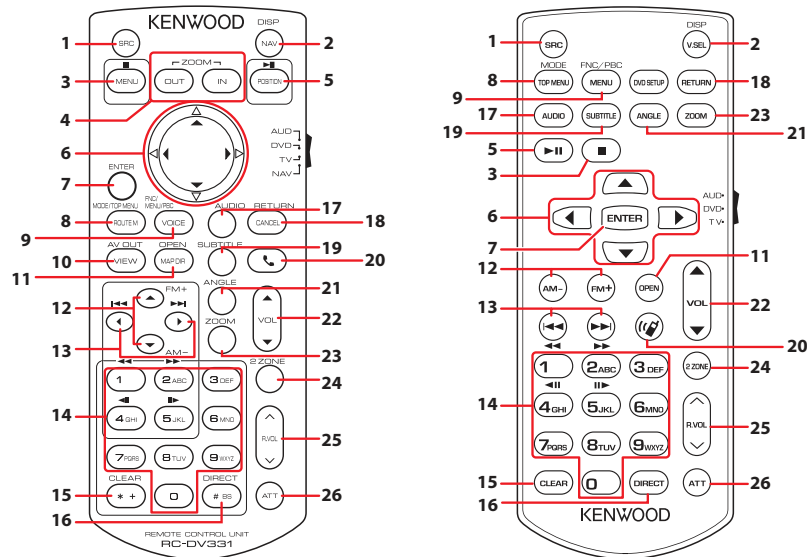

- 2** Enter the number of the content you want to play using the numeric keypad.
 - 3** For DVD or VCD, music CD, press the **ENTER** button.
For radio, press the ◀ or ▶/◀◀ or ▶▶ button.
- The content corresponding to the number you entered is played.

Basic Operation



	Key Name		Mode switch	Function
1	SRC	SRC	AUD, DVD	Switches to the source to be played. In hands-free mode, hangs up the phone.
2	NAV	V.SEL	—	Displays the APP (Apple CarPlay/Android Auto/Wireless Mirroring) screen.
3	MENU	■	DVD	Stops playing and memorizes the last point where the disc stopped. The last point is deleted by pressing twice.
4	OUT, IN	—	—	Not used.
5	POSITION	▶	AUD, DVD	Pauses the track or file, and resumes playing by pressing twice. For the radio and HD Radio (DDX9906XR / DDX8906S / DMX906S only) sources in AUD mode, switches the seek mode.
6	Cursor Key		DVD	Moves the cursor in the DVD menu.

Remote control

	Key Name		Mode switch	Function
7	ENTER	ENTER	–	Performs the selected function.
8	ROUTE M	TOP MENU	AUD	Screen mode changes each time you press this key during video playback.
			DVD	Returns to the DVD top menu.
9	VOICE	MENU	AUD	Displays the control screen of current source. (USB, iPod, DISC)
			DVD	Displays the DVD menu. Turns the playback control on or off while playing VCD.
10	VIEW	–	AUD, DVD	Switches the AV source to be output.
11	MAP DIR	OPEN	AUD, DVD	Switches the display angle each time it is pressed. (DDX9906XR / DDX8906S / DDX8706S / DDX819WBTL only)
12	▲/▼	FM+/AM-	AUD, DVD	Selects the folder to be played. For the radio and HD Radio (DDX9906XR / DDX8906S / DMX906S only) sources in AUD mode, selects FM/AM band to be received. For the SiriusXM source in AUD mode, selects the band to be received. For the DVD/VCD source in DVD mode, selects the title to be played.
13	◀▶	◀◀▶▶	AUD, DVD	Selects the track or file to be played. For the radio, HD Radio (DDX9906XR / DDX8906S / DMX906S only), and SiriusXM sources in AUD mode, switches to broadcast stations received by the unit. For the DVD/VCD source in DVD mode, selects the chapter/scene/track to be played.
14	Numeric Keypad		AUD	For the Radio, HD Radio, and SiriusXM sources, allows you to enter the preset number. • If the preset number is one digit, press the number. • If the preset number is two digits, press continuously the numbers within 3 seconds. • Pressing ◀▶ within 3 seconds allows you to determine the preset number of one digit. Allows you to enter the number to search in the direct search mode. For details on the direct search mode, see Direct search mode (P.99) .
			DVD	• Press 1 2 to fast forward/backward. • Press 4 5 to slow forward/backward. Switches the slow playback speed each time you press this key.* *DVD only
15	* +	CLEAR	DVD	For the DVD/VCD source, deletes a character while in direct search mode.
16	# BS	DIRECT	AUD, DVD	Switches to the direct search mode. For details on the direct search mode, see Direct search mode (P.99) .
17	AUDIO	AUDIO	DVD	Switches the voice language each time you press this key.
18	CANCEL	RETURN	DVD	Displays previous screen.
19	SUBTITLE	SUBTITLE	DVD	Switches the subtitle language.
20			–	When a call comes in, answers the call.
21	ANGLE	ANGLE	DVD	Switches the picture angle each time you press this key.
22	VOL ▲▼	VOL ▲▼	–	Adjusts the volume.
23	ZOOM	ZOOM	DVD	Switches the zoom ratio (2, 3, 4, Off) each time you press this key.
24	2 ZONE	2 ZONE	AUD, DVD	Switches the Dual Zone function on and off.
25	R.VOL ^▼	R.VOL ^▼	–	Adjusts volume at rear when the Dual Zone function is on.
26	ATT	ATT	–	Lowers the volume when pressed once.
			–	Restores the previous volume when pressed twice.

Connection/Installation

Before Installation

Before installation of this unit, please note the following precautions.

⚠ WARNINGS

- If you connect the ignition wire (red) and the battery wire (yellow) to the car chassis (ground), you may cause a short circuit, that in turn may start a fire. Always connect those wires to the power source running through the fuse box.
- Do not cut out the fuse from the ignition wire (red) and the battery wire (yellow). The power supply must be connected to the wires via the fuse.

⚠ CAUTION

- Install this unit in the console of your vehicle. Do not touch the metal part of this unit during and shortly after the use of the unit. Metal part such as the heat sink and enclosure become hot.

NOTE

- Mounting and wiring this product requires skills and experience. For best safety, leave the mounting and wiring work to professionals.
- Make sure to ground the unit to a negative 12V DC power supply.
- Do not install the unit in a spot exposed to direct sunlight or excessive heat or humidity. Also avoid places with too much dust or the possibility of water splashing.
- Do not use your own screws. Use only the screws provided. If you use the wrong screws, you could damage the unit.
- If the power is not turned ON ("There is an error in the speaker wiring. Please check the connections." is displayed), the speaker wire may have a short-circuit or touched the chassis of the vehicle and the protection function may have been activated. Therefore, the speaker wire should be checked.
- If your car's ignition does not have an ACC position, connect the ignition wires to a power source that can be turned on and off with the

ignition key. If you connect the ignition wire to a power source with a constant voltage supply, such as with battery wires, the battery may be drained.

- If the console has a lid, make sure to install the unit so that the front panel will not hit the lid when closing and opening.
- If the fuse blows, first make sure the wires aren't touching to cause a short circuit, then replace the old fuse with one with the same rating.
- Insulate unconnected wires with vinyl tape or other similar material. To prevent a short circuit, do not remove the caps on the ends of the unconnected wires or the terminals.
- Connect the speaker wires correctly to the terminals to which they correspond. The unit may be damaged or fail to work if you share the ⊖ wires or ground them to any metal part in the car.
- When only two speakers are being connected to the system, connect the connectors either to both the front output terminals or to both the rear output terminals (do not mix front and rear). For example, if you connect the ⊕ connector of the left speaker to a front output terminal, do not connect the ⊖ connector to a rear output terminal.
- After the unit is installed, check whether the brake lamps, blinkers, wipers, etc. on the car are working properly.
- Mount the unit so that the mounting angle is 30° or less.
- This unit has the cooling fan to decrease the internal temperature. Do not mount the unit in a place where the cooling fan of the unit is blocked. Blocking these openings will inhibit the cooling of the internal temperature and result in malfunction.

Connection/Installation

In case of DDX9906XR

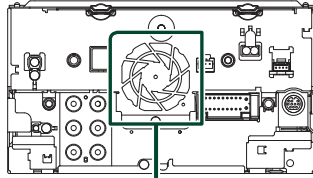



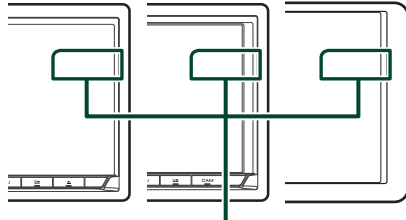

Cooling fan





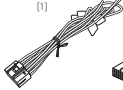
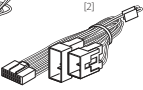

- Do not press hard on the panel surface when installing the unit to the vehicle. Otherwise scars, damage, or failure may result.
- Reception may drop if there are metal objects near the Bluetooth antenna.

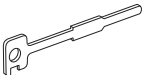

Bluetooth antenna unit

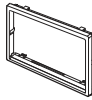
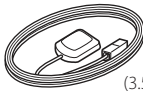
Supplied accessories for installation

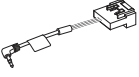
①	 ⁽¹⁾  ⁽²⁾	x1
② ⁽¹⁾	 (Black 1 m)	x1
③ ⁽¹⁾	 (Gray 1 m)	x1
④	 (3 m)	x1
⑤ ⁽¹⁾		x2

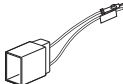
⑥	 (M5 x 8 mm)	x6
⑦	 (M5 x 8 mm)	x6
⑧ ⁽¹⁾		x1
⑨ ⁽¹⁾	 (3.5 m)	x1
⑩ ⁽¹⁾		x1
⑪ ⁽²⁾		x1
⑫ ⁽²⁾		x1
⑬ ⁽³⁾		x1
⑭ ⁽²⁾		x1

⁽¹⁾ Except DDX819WBTL

⁽²⁾ DDX819WBTL only

⁽³⁾ DDX9906XR / DDX8906S / DMX906S only

Installation procedure

- 1) To prevent a short circuit, remove the key from the ignition and disconnect the ⊖ terminal of the battery.
- 2) Make the proper input and output wire connections for each unit.

Connection/Installation

- 3) Connect the speaker wires of the wiring harness.
- 4) Connect the wiring harness wires in the following order; ground, battery, ignition.
- 5) Connect the wiring harness connector to the unit.
- 6) Install the unit in your car.
- 7) Reconnect the \ominus terminal of the battery.
- 8) Perform the Initial Setup.
See **Initial setup (P.8)**.

Installing the unit

Non-Japanese cars (Except DDX819WBTL)

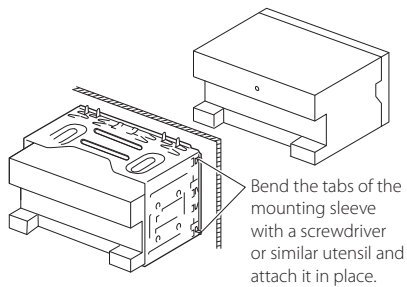

Japanese cars

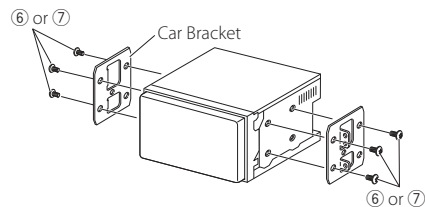

NOTE

- Make sure that the unit is installed securely in place. If the unit is unstable, it may malfunction (eg, the sound may skip).

Trim plate (Except DDX819WBTL)

- 1) Attach accessory ⑧ to the unit.

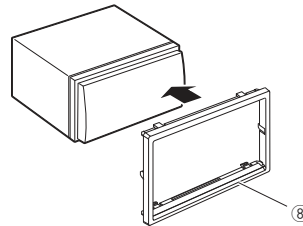

■ GPS antenna (Except DDX819WBTL)

GPS antenna is installed inside of the car. It should be installed as horizontally as possible to allow easy reception of the GPS satellite signals.

To mount the GPS antenna inside your vehicle:

- 1) Clean your dashboard or other surface.
- 2) Remove the separator of the metal plate (accessory ⑩).
- 3) Press the metal plate (accessory ⑩) down firmly on your dashboard or other mounting surface. You can bend the metal plate (accessory ⑩) to conform to a curved surface, if necessary.
- 4) Remove the separator of the GPS antenna (accessory ⑨), and stick the antenna to the metal plate (accessory ⑩).

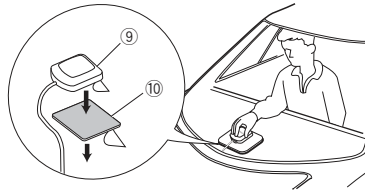

NOTE

- Depending on the type of car, reception of the GPS satellite signals might not be possible with an inside installation.
- Please install this GPS antenna in an area away from any antennas that are used with CB radios or satellite televisions.
- The GPS antenna should be installed at a position that is spaced at least 12 inch (30 cm) from cellular phone or other transmitting antennas. Signals from the GPS satellite may be interfered with by these types of communication.
- Painting the GPS antenna with (metallic) paint may cause a drop in performance.

■ Microphone unit

- 1) Check the installation position of the microphone (accessory ④).
- 2) Clean the installation surface.
- 3) Remove the separator of the microphone (accessory ④), and stick the microphone to the place shown below.
- 4) Wire the microphone cable up to the unit with it secured at several positions using tape or other desired method.
- 5) Adjust the direction of the microphone (accessory ④) to the driver.

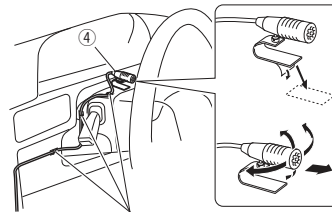

Fix a cable with a commercial item of tape.

Connection/Installation

■ Removing the trim plate (Except DDX819WBTL)

- 1) Engage the catch pins on the extraction key (accessory ⑤) and remove the two locks on the lower level.
Lower the trim plate (accessory ⑧) and pull it forward as shown in the figure.

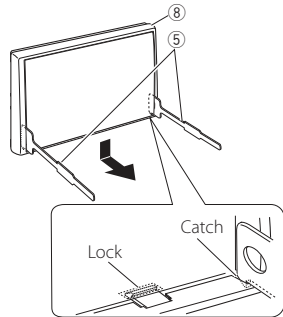

NOTE

- The trim plate can be removed from the top side in the same manner.

- 2) When the lower level is removed, remove the upper two locations.

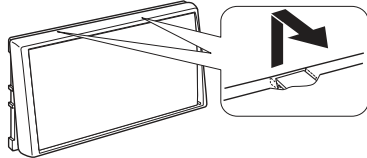

■ Removing the unit (Except DDX819WBTL)

- 1) Remove the trim plate by referring to step 1 in "Removing the trim plate".
- 2) Insert the two extraction key (accessory ⑤) deeply into the slots on each side, as shown.

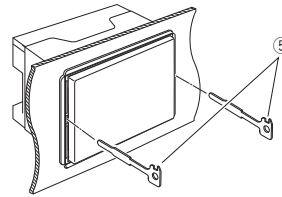

- 3) Lower the extraction key toward the bottom, and pull out the unit halfway while pressing towards the inside.

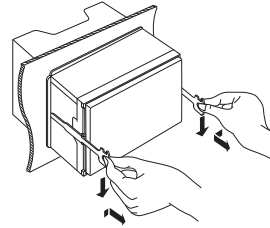

NOTE

- Be careful to avoid injury from the catch pins on the extraction key.

- 4) Pull the unit all the way out with your hands, being careful not to drop it.

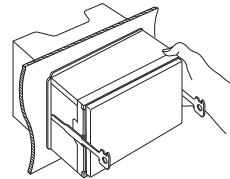

Connecting wires to terminals

● Except DDX819WBTL

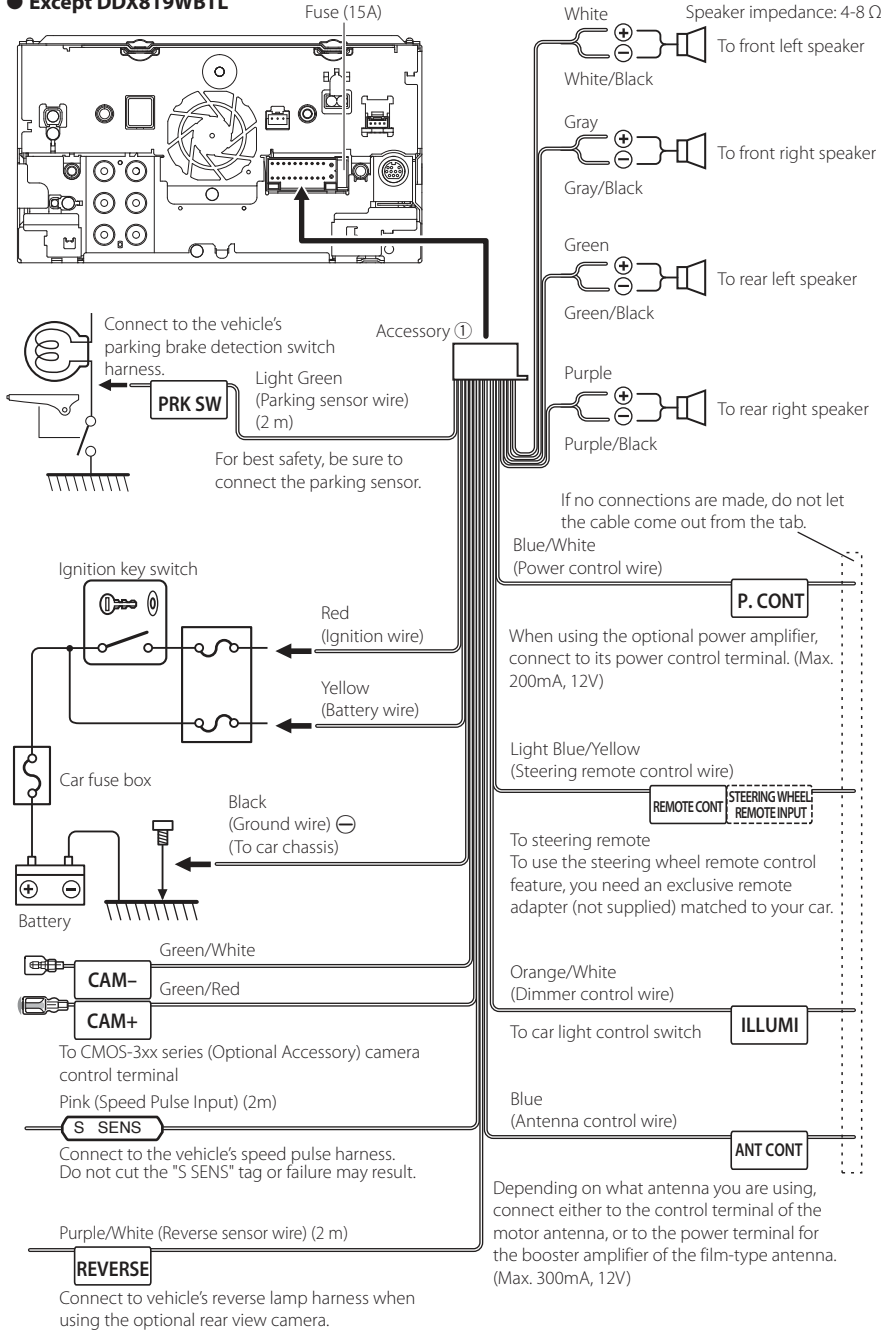

Connection/Installation

● DDX819WBTL

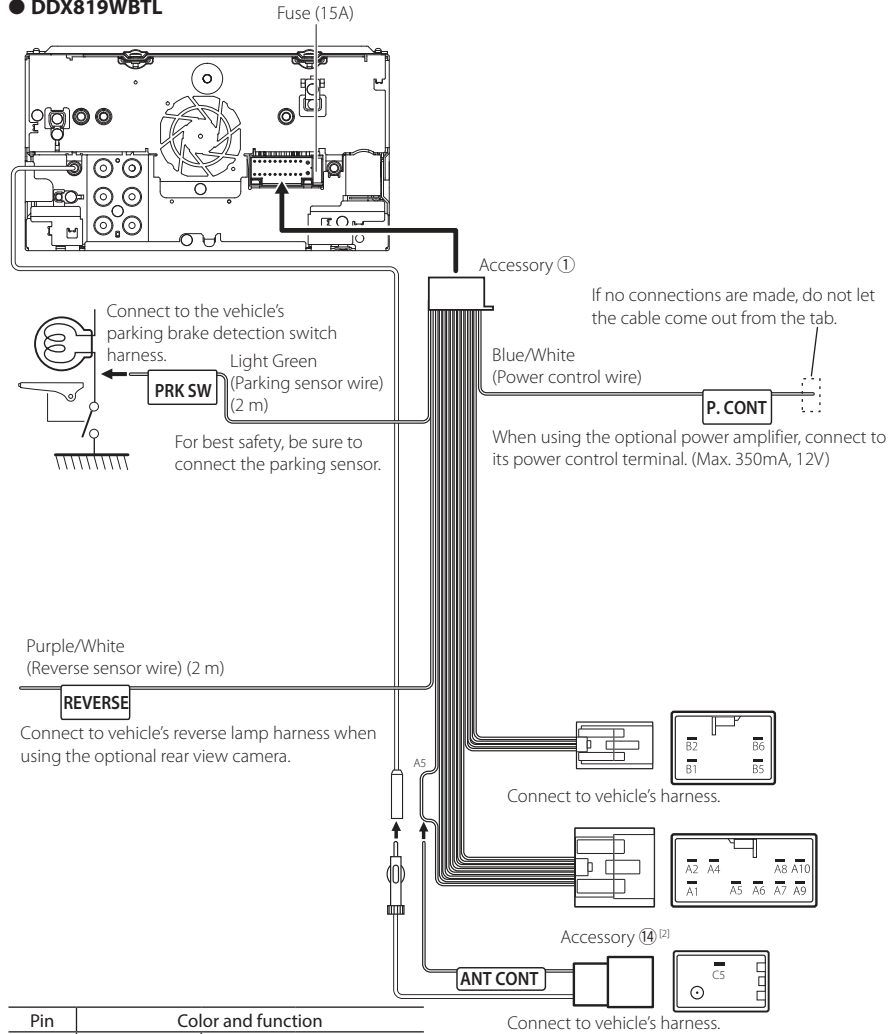

Pin	Color and function
A1	Orange/White Dimmer
A2	Yellow Battery
A4	Red Ignition (ACC)
A5	Blue ^[1] Antenna control
A6	Black Earth (Ground) Connection
A8/A7	White (+) / White/Black (-) Front Left
A10/A9	Gray (+) / Gray/Black (-) Front Right
B2/B1	Green (+) / Green/Black (-) Rear Left
B6/B5	Purple (+) / Purple/Black (-) Rear Right
C5	Blue Antenna control

*Speaker Impedance: 4-8 Ω

^[1] Max. 300mA, 12V

^[2] When using Antenna Control, connect the ANT CONT lead (blue) to A5 (blue) on the wiring harness.

3-way speaker system setup

- DDX9906XR / DDX8906S / DDX819WBTL / DMX906S

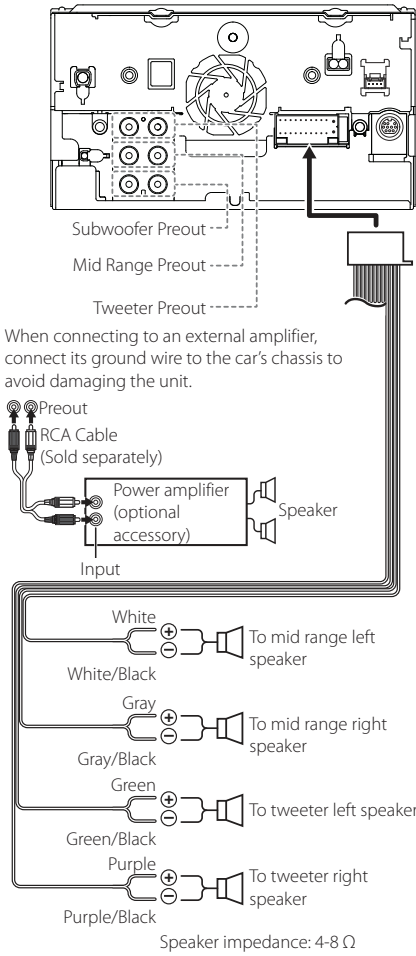

NOTE

- For speaker system setup, see **3-way speaker system setup (P.90)**.
- For speaker setup and crossover setup, see **Speaker / X'over setup (P.91)**.
- For how to connect speaker wires to terminals other than speaker terminals and Preout terminals, see **Connecting the system and external components (P.109)** and **Connecting wires to terminals (P.107)**.

Connecting the system and external components

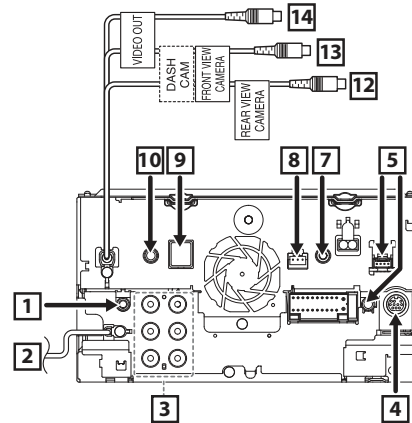

- Except DDX819WBTL

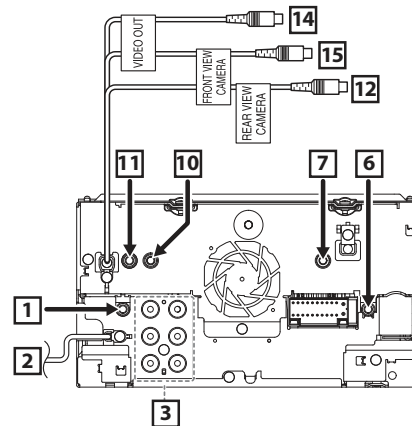

- DDX819WBTL

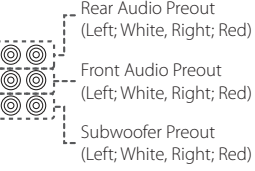
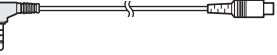

Connection/Installation

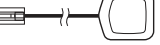
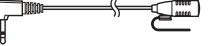
1	AV Audio output (ø3.5 mini jack)
2	FM/AM antenna input 
3	When connecting to an external amplifier, connect its ground wire to the car's chassis to avoid damaging the unit. 
4	SiriusXM Connect Vehicle Tuner connector (Except DDX819WBTL) For more information on how to install the SiriusXM Connect Vehicle tuner, consult the installation guide included with the tuner.
5	iDataLink connector (Except DDX819WBTL)
6	TV tuner remote output (DDX819WBTL only)
7	This jack accepts either AV-IN or Side (Left or Right) View Camera Input. For more information, see To set up the camera assignment settings (P.79) . DDX9906XR / DDX8906S / DMX906S : Accessory 13 : Mini plug to RCA cable*1  or CA-C3AV (Optional Accessory) DDX8706S / DMX9706S : CA-C3AV (Optional Accessory) DDX819WBTL: AV-IN (Accessory 12) input  Accessory 12 : Visual; Yellow, Left audio; White, Right audio; Red
8	Dashboard camera interface (Except DDX819WBTL) Connect a Dashboard Camera DRV-N520 (optional accessory). (P.113)
9	Accessory 9 : GPS Antenna (Except DDX819WBTL) 
10	Accessory 4 : Bluetooth Microphone 

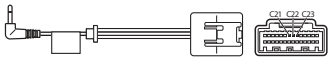
11	Accessory 11 : Steering remote harness (DDX819WBTL only) Connect to vehicle's steering remote harness. Contact your KENWOOD dealer for details. 												
	<table border="1"> <thead> <tr> <th>Pin</th> <th colspan="2">Color and function</th> </tr> </thead> <tbody> <tr> <td>C21</td> <td>Light green/Red</td> <td>Input 1</td> </tr> <tr> <td>C22</td> <td>Purple/Red</td> <td>Input 2</td> </tr> <tr> <td>C23</td> <td>Gray/Red</td> <td>Ground</td> </tr> </tbody> </table>	Pin	Color and function		C21	Light green/Red	Input 1	C22	Purple/Red	Input 2	C23	Gray/Red	Ground
Pin	Color and function												
C21	Light green/Red	Input 1											
C22	Purple/Red	Input 2											
C23	Gray/Red	Ground											
12	Rear view camera input (Yellow)												
13	Front view camera/Dashboard camera input (Yellow). (Except DDX819WBTL) See To set up the camera assignment settings (P.79) .												
14	VIDEO Output (Yellow)												
15	Front view camera input (Yellow). (DDX819WBTL only) See To set up the camera assignment settings (P.79) .												

*1 Connecting Mini plug to RCA cable to AV-IN terminal enables you to use the Side (Left or Right) View Camera only. If you connect CA-C3AV (Optional Accessory), AV-IN (for visual) or the Side (Left or Right) View Camera is available.

Connecting a USB device

● Except DDX819WBTL

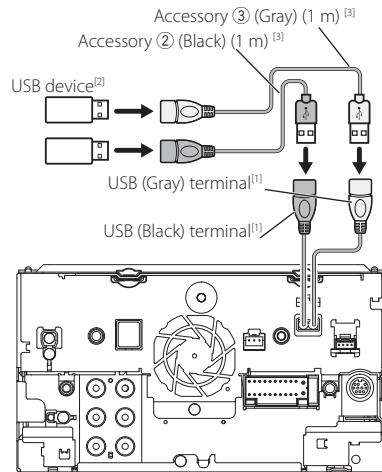

● DDX819WBTL

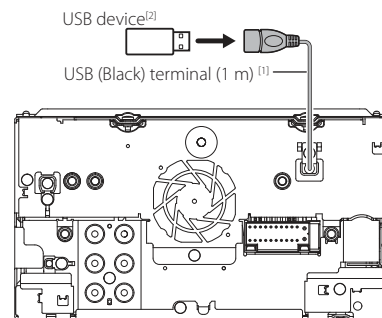

^[1] USB maximum power supply current :
DC 5 V \pm 1.5 A

^[2] Sold separately/Use CA-U1EX to extend the cable if necessary. (Max 500 mA, 5V)

^[3] See **Securing the USB extension cable (P.111)**.

Securing the USB extension cable

Secure the USB extension cable with insulating tape or the like so that its connectors are not disconnected.

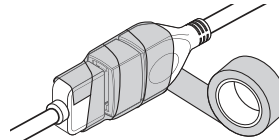

Connecting an iPod/iPhone

● Except DDX819WBTL

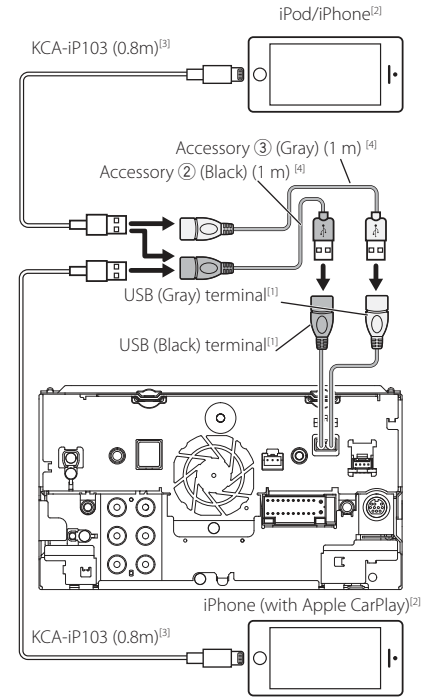

Connection/Installation

● **DDX819WBTL**

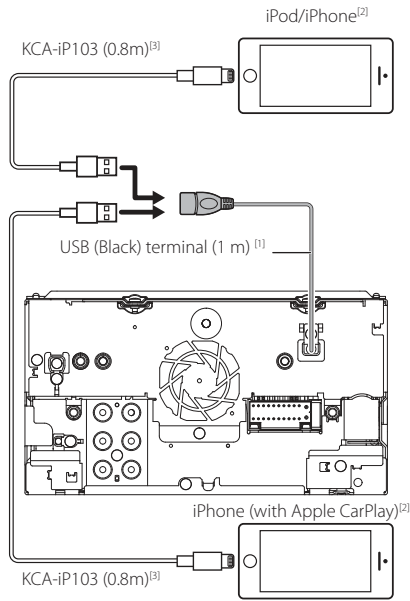

^[1] USB maximum power supply current :
DC 5 V \pm 1.5 A

^[2] Sold separately

^[3] Optional accessory

^[4] See **Securing the USB extension cable (P.111)**.

Connecting an Android smartphone

● **Except DDX819WBTL**

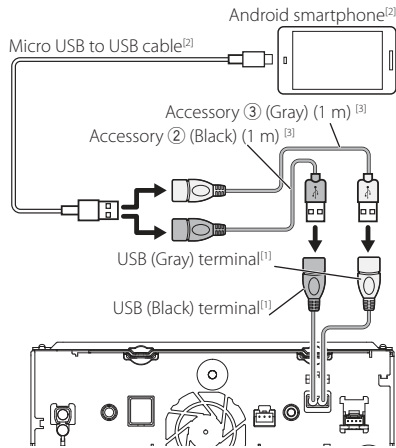

● **DDX819WBTL**

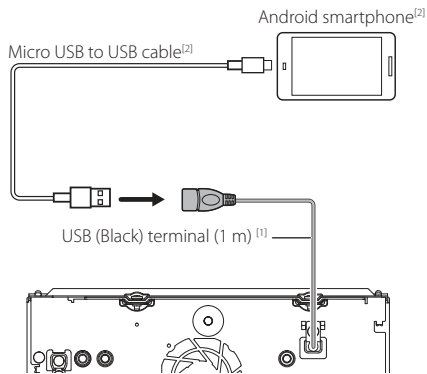

^[1] USB maximum power supply current :
DC 5 V \pm 1.5 A

^[2] Sold separately

^[3] See **Securing the USB extension cable (P.111)**.

Connecting the camera

● **Except DDX819WBTL**

Left Side View Camera and Right Side View Camera ^[2]

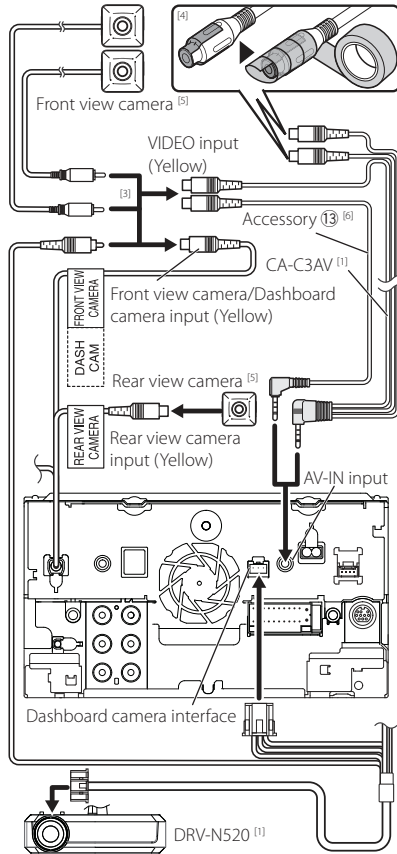

● **DDX819WBTL**

Left Side View Camera and Right Side View Camera ^[2]

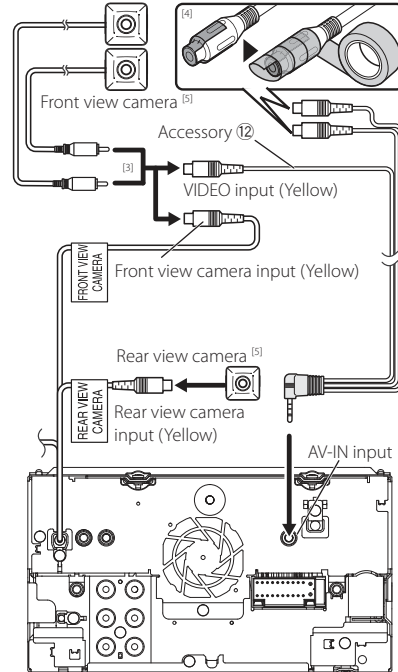

^[1] Optional accessory

^[2] Sold separately

^[3] Up to 2 cameras of Dashboard camera, Front view camera, Left Side View Camera and Right Side View Camera can be connected. For more information, see **Camera Assignment Settings (P.79)**.

^[4] Insulate audio input terminals of a CA-C3AV (Optional Accessory) or accessory ^[12] (DDX819WBTL only) when connecting to the Camera.

^[5] CMOS-3xx series (Optional Accessory) or commercially available camera.

^[6] DDX9906XR / DDX8906S / DMX906S only

Troubleshooting

Problems and Solutions

If any trouble occurs, first check the following table for possible problems.

NOTE

- Some functions of this unit may be disabled by some settings made on this unit.
- What might seem to be a malfunction in your unit may just be the result of slight misoperation or miswiring.

About settings

- **Cannot set up the subwoofer.**
- **Cannot set up subwoofer phase.**
- **No output from the subwoofer.**
- **Cannot set up the low pass filter.**
- **Cannot set up the high pass filter.**

Subwoofer is not set to on.

- Set the subwoofer to on. See **Speaker / X'over setup (P.91)**.

The dual zone function is enabled.

- Set the dual zone function to off. See **Zone Control (P.95)**.

- **Cannot select the output destination of the subsource in the dual zone.**
- **Cannot adjust the volume of the rear speakers.**

The dual zone function is disabled.

- Set the dual zone function to on. See **Zone Control (P.95)**.

- **Cannot set up the equalizer.**
- **Cannot set up the crossover network.**

The dual zone function is enabled.

- Set the dual zone function to off. See **Zone Control (P.95)**.

About audio operations

Radio reception is poor.

The car antenna is not extended.

- Pull out the antenna all the way.

The antenna control wire is not connected.

- Connect the wire correctly. See **Connecting the system and external components (P.109)**.

Cannot select a folder.

The random play function is enabled.

- Turn off the random function.

Cannot perform repeat play during VCD playback.

The PBC function is enabled.

- Turn off the PBC function.

The specified disc does not play, but another one plays instead.

The disc is quite dirty.

- Clean the disc. See **Precautions on handling discs (P.4)**.

The disc is severely scratched.

- Try another disc instead.

The sound skips when an audio file is being played.

The disc is scratched or dirty.

- Clean the disc. See **Precautions on handling discs (P.4)**.

The recording condition is bad.

- Record the file again or use another disc.

Others

The Touch Sensor Tone doesn't sound.

The preout jack is being used.

- The Touch Sensor Tone cannot be output from the preout jack.

Error Messages

When you fail to operate the unit correctly, the cause of the failure appears as the message on the screen.

There is an error in the speaker wiring. Please check the connections.

Protective circuit has been activated because a speaker cord has shorted or it has come in contact with the car chassis.

- Wire or insulate the speaker cord as appropriate and turn the power off and on again.

Hot Error

When the internal temperature of this unit rises to 60°C or more, the protection circuit is activated and you may not be able to operate the unit.

- Use the unit again after reducing the temperature of the unit.

Mecha Error

The disc player is malfunctioning.

- Eject the disc and try inserting it again. Contact the KENWOOD dealer if this indicator continues blinking or the disc cannot be ejected.

Disc Error

An unplayable disc is inserted.

- Change the disc. See **Playable Media and Files (P.117)**.

Read Error

The disc is quite dirty.

- Clean the disc. See **Precautions on handling discs (P.4)**.

Disc is upside down.

- Load the disc with the labeled side up.

Region Code Error

The disc you wanted to play has a region code that cannot be played with this unit.

- See **Region Codes in the World (P.119)** or try another disc.

Error 07-67

The unit is not operating correctly due to some reason or other.

- Turn the power off and on again. If the "Error 07-67" message does not disappear, contact your nearest KENWOOD dealer.

No Device (USB device)

The USB device is selected as a source although no USB device is connected.

- Change the source to any source other than USB/iPod. Connect a USB device, and change the source to USB again.

Disconnected (iPod, Bluetooth audio player)

The iPod/Bluetooth audio player is selected as a source although no iPod/Bluetooth audio player is connected.

- Change the source to any source other than iPod/Bluetooth. Connect an iPod/Bluetooth audio player, and change the source to iPod/Bluetooth again.

No Media file

The connected USB device contains no playable audio file. Media was played that doesn't have data recorded that the unit can play.

- See **Playable Media and Files (P.117)** and try another USB device.

USB device over current status detected.

The connected USB device is rated a current capacity higher than the allowable limit.

- Check the USB device. Some trouble may have occurred to the connected USB device.
- Change the source to any source other than USB. Remove the USB device.

 **SiriusXM**

Check Tuner

A SiriusXM tuner is not connected to this unit.

- Verify that the SiriusXM Connect Vehicle Tuner cable is securely connected to the radio.

Subscription Updated - Press Return To Continue

The SiriusXM subscription has been renewed.

- Touching **Return** on the popup screen will clear the message.

SXM Chan Unavailable

The currently selected channel is unavailable.

- Visit www.siriusxm.com for more information about the SiriusXM channel lineup.

SXM Ch Unsubscribed

The currently selected channel is not subscribed to.

- In the U.S.A., visit www.siriusxm.com or call 1-866-635-2349 if you have questions about your subscription package or would like to subscribe to this channel.
- In Canada, visit www.siriusxm.ca or call 1-877-438-9677.

SXM Check Antenna

No antenna is connected to the SiriusXM tuner.

- Check that an antenna is connected to the SiriusXM tuner. Check antenna for damages.

SXM No Signal

No SiriusXM radio signal is received.

- Verify that your vehicle is outdoors with a clear view of the sky.

Channel Locked

The selected channel has been locked by the parental controls.

- Enter the unlock code when you are asked. See **Parental Control (P.61)**.

Incorrect Pass Code entered

The selected channel is a mature or parental lock channel, and locked by the parental lock or user lock code.

- Enter the correct lock code.

Troubleshooting

Apple CarPlay

The speed sensor must be connected to use Apple CarPlay wirelessly. Please verify the proper connections or plug in by USB to use Apple CarPlay.

The speed pulse is not detected when the Apple CarPlay is started by connecting wirelessly or when the iPhone compatible with wireless Apple CarPlay is registered in **Apple CarPlay Device List**.

- Check the connection of the speed pulse or plug in over USB to use Apple CarPlay.

The GPS antenna must be connected to use Apple CarPlay wirelessly. Please verify the proper connections or plug in by USB to use Apple CarPlay.

The GPS antenna is not connected when the Apple CarPlay is started by connecting wirelessly or when the iPhone compatible with wireless Apple CarPlay is registered in **Apple CarPlay Device List**.

- Check the connection of the GPS antenna or plug in over USB to use Apple CarPlay.

The speed sensor and the GPS antenna must be connected to use Apple CarPlay wirelessly. Please verify the proper connections or plug in by USB to use Apple CarPlay.

The speed pulse is not detected and the GPS antenna is not connected when the Apple CarPlay is started by connecting wirelessly or when the iPhone compatible with wireless Apple CarPlay is registered in **Apple CarPlay Device List**.

- Check the connection of the speed pulse and the GPS antenna or plug in over USB to use Apple CarPlay.

Appendix

Playable Media and Files

You can play various kinds of media and files on this unit.

■ List of playable discs (DDX9906XR / DDX8906S / DDX8706S / DDX819WBTL)

	Disc types / Standard	Support	Remark
DVD	DVD Video	○	
	DVD Audio	×	
	DVD-VR	×	
	DVD-R*1	○	<ul style="list-style-type: none"> • MP3 / WMA / AAC / WAV / FLAC / Vorbis / MPEG1 / MPEG2 / MPEG4 / H.264 / WMV / MKV playback • Multi-border/Multisession playback (Playback depends on authoring conditions)
	DVD-RW	○	
	DVD+R	○	
	DVD+RW	○	
	DVD-R DL (Dual layer)	○	Only video format
	DVD+R DL (Double layer)	○	
	DVD-RAM	×	
CD	Music CD*1	○	
	CD-ROM	○	<ul style="list-style-type: none"> • MP3 / WMA / AAC / WAV / FLAC / Vorbis playback • Multisession is supported. • Packet write is not supported.
	CD-R	○	
	CD-RW	○	
	DTS-CD	×	
	Video CD (VCD)	○	
	Super video CD	×	
	Photo CD	×	
	CD-EXTRA	△	Only music CD session can be played.
	HDCD	△	Normal music CD sound quality
	CCCD	×	
	Others	Dualdisc	×
Super audio CD		△	Only CD layer can be played.

○ : Playback is possible.

△ : Playback is partly possible.

×

*1 Incompatible with 8 cm (3 inch) discs.

■ Use of DualDisc

When playing a "DualDisc" on this unit, the surface of the disc that is not played may be scratched while the disc is inserted or ejected. Since the music CD surface does not conform to the CD standard, playback may be impossible.

(A "DualDisc" is a disc with one surface containing DVD standard signals and the other surface containing music CD signals.)

■ About disc format

The disc format should be the one of the following.

- ISO 9660 Level 1, 2
- Joliet
- Romeo
- Long file name

Appendix

About files

The following audio and video files are supported.

Playable Audio files

	Format	Bit rate	Sampling frequency	Bit count
AAC-LC (.m4a)	MPEG-2/MPEG-4 AAC LC HE-AAC(V1,V2)	8 – 320kbps, VBR	16 – 48 kHz	16 bit
MP3 (.mp3)	MPEG-1/MPEG-2 Audio Layer 3	8 – 320kbps, VBR	16 – 48 kHz	16 bit
WMA (.wma)	Windows Media Audio Standard L3 profile (Version 7,8,9)	8 – 320kbps	16 – 48 kHz	16 bit
Linear PCM (WAVE) (.wav)	RIFF waveform Audio Format	–	16 – 48 kHz (Disc), 16 – 192 kHz (USB)	16 bit/24 bit
FLAC (.flac)	flac	–	16 – 48 kHz (Disc), 16 – 192 kHz (USB)	16 bit/24 bit
Vorbis (.ogg)	vorbis	–	16 – 48 kHz	16 bit

- If music of normal CD and other playback systems are recorded in the same disc, only the playback system recorded at the first setout is played.
- WMA and AAC files with DRM cannot be played.
- Although the audio files complies with the standards listed above, they may not be played depending on the types or conditions of media or device.
- This unit supports playback of High-Resolution Audio files.
It is recommended that a car audio system should be configured with all High-Resolution Audio compatible products from player to speaker to enjoy its high quality sound.

Acceptable Video files

	Profile	Max. Picture size	Max. bit rate	Audio format
MPEG-1 (.mpg, .mpeg)	–	352 × 240, 352 × 288	1.5 Mbps	MPEG Audio Layer 2
MPEG-2 (.mpg, .mpeg)	MP@ML	720 × 480, 720 × 576	8 Mbps	MPEG Audio Layer 2
H.264/MPEG-4 AVC (.mp4, .m4v, .avi, .flv, .f4v)	Baseline Profile, Main Profile	1920 × 1080 (30 fps)	8 Mbps	MP3, AAC
MPEG-4 (.mp4, .avi)	Advanced Simple Profile	1920 × 1080 (30 fps)	8 Mbps	MP3, AAC
WMV (.wmv)	Main Profile	1920 × 1080 (30 fps)	8 Mbps	WMA
MKV (.mkv)	Video format follows H.264/MPEG-4 AVC, MPEG-4, WMV			MP3, AAC, WMA, Vorbis, FLAC

- This unit can only play back files which are smaller than 4 GB.

Limitation on structure of file and folder

	Disc media	USB device
Maximum number of folder layers	8	8
Maximum number of files (per folder)	999	999
Maximum number of folders (per folder)	5000	9999
Maximum number of folders (per device)	5000	Unlimited

- You can enter a folder name and file name with 254 (for Disc)/255 (for USB) or fewer single-byte characters.
- Files in the folder whose folder name begins with a dot (.) cannot be played.

Region Codes in the World

The DVD players are given a region code according to the country or area it is marketed, as shown in the following map.

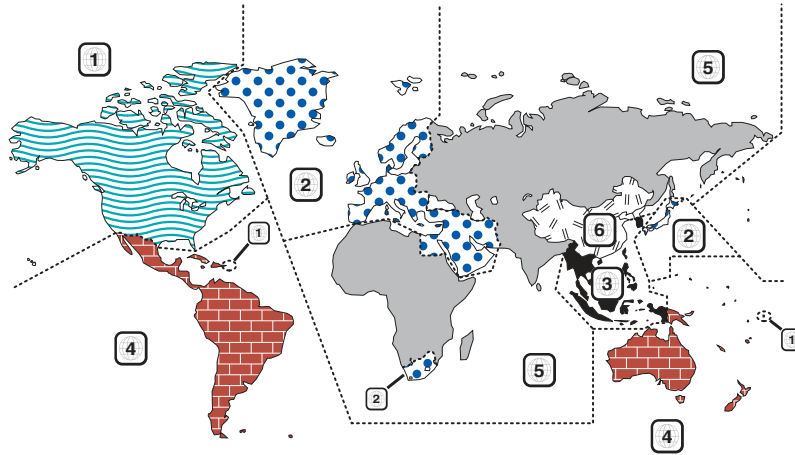

■ DVD disc marks



Indicates a region number. The discs with this mark can be played with any DVD player.



Indicates the number of audio languages recorded. Up to 8 languages can be recorded in a movie. You can select a favorite language.



Indicates the number of subtitled languages recorded. Up to 32 languages can be recorded.



If a DVD disc has scenes shot from multiple angles, you can select a favorite angle.

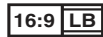

Indicates the type of screen for the image. The left mark indicates that a wide image picture (16:9) is displayed on a standard TV set screen (4:3) with a black band at both the top and bottom of the screen (letter box).

■ Operation regulatory marks

With this DVD, some functions of this unit such as the play function may be restricted depending on the location where the DVD is playing. In this case, the following marks will appear on the screen. For more information, refer to the disc manual.



■ Discs with limited period of use

Do not leave discs with a limited period of use in this unit. If you load an already expired disc, you may not be able to remove it from this unit.

Appendix

DVD Language Codes

Code	Language	Code	Language	Code	Language
aa	Afar	ia	Interlingua	rn	Kirundi
ab	Abkhazian	ie	Interlingue	ro	Romanian
af	Afrikaans	ik	Inupiak	ru	Russian
am	Amharic	id	Indonesian	rw	Kinyarwanda
ar	Arabic	is	Icelandic	sa	Sanskrit
as	Assamese	it	Italian	sd	Sindhi
ay	Aymara	ja	Japanese	sg	Sangho
az	Azerbaijani	jv	Javanese	sh	Serbo-Croatian
ba	Bashkir	ka	Georgian	si	Singhalese
be	Byelorussian	kk	Kazakh	sk	Slovak
bg	Bulgarian	kl	Greenlandic	sl	Slovenian
bh	Bihari	km	Cambodian	sm	Samoan
bi	Bislama	kn	Kannada	sn	Shona
bn	Bengali, Bangla	ko	Korean	so	Somali
bo	Tibetan	ks	Kashmiri	sq	Albanian
br	Breton	ku	Kurdish	sr	Serbian
ca	Catalan	ky	Kirghiz	ss	Siswati
co	Corsican	la	Latin	st	Sesotho
cs	Czech	lb	Luxembourgish	su	Sundanese
cy	Welsh	ln	Lingala	sv	Swedish
da	Danish	lo	Laotian	sw	Swahili
de	German	lt	Lithuanian	ta	Tamil
dz	Bhutani	lv	Latvian, Lettish	te	Telugu
el	Greek	mg	Malagasy	tg	Tajik
en	English	mi	Maori	th	Thai
eo	Esperanto	mk	Macedonian	ti	Tigrinya
es	Spanish	ml	Malayalam	tk	Turkmen
et	Estonian	mn	Mongolian	tl	Tagalog
eu	Basque	mo	Moldavian	tn	Setswana
fa	Persian	mr	Marathi	to	Tongan
fi	Finnish	ms	Malay	tr	Turkish
fj	Fiji	mt	Maltese	ts	Tsonga
fo	Faroese	my	Burmese	tt	Tatar
fr	French	na	Nauru	tw	Twi
fy	Frisian	ne	Nepali	uk	Ukrainian
ga	Irish	nl	Dutch	ur	Urdu
gd	Scots Gaelic	no	Norwegian	uz	Uzbek
gl	Galician	oc	Occitan	vi	Vietnamese
gn	Guarani	om	(Afan) Oromo	vo	Volapuk
gu	Gujarati	or	Oriya	wo	Wolof
ha	Hausa	pa	Punjabi	xh	Xhosa
he	Hebrew	pl	Polish	yo	Yoruba
hi	Hindi	ps	Pashto, Pushto	zh	Chinese
hr	Croatian	pt	Portuguese	zu	Zulu
hu	Hungarian	qu	Quechua		
hy	Armenian	rm	Rhaeto-Romance		

Specifications

■ Monitor section

Picture Size

DDX9906XR
: 6.75 inches (diagonal) wide
: 152.1 mm (W) × 79.5 mm (H)
5-63/64 × 3-1/8 inch
Except DDX9906XR
: 6.95 inches (diagonal) wide
: 156.6 mm (W) × 81.6 mm (H)
6-3/16 × 3-3/16 inch

Display System

DDX9906XR: AAS LCD panel
Except DDX9906XR: TN LCD panel

Drive System

: TFT active matrix system

Number of Pixels

DDX9906XR
: 2,764,800 (1280H x 720V x RGB)
Except DDX9906XR
: 1,152,000 (800H x 480V x RGB)

Effective Pixels

: 99.99 %

Pixel Arrangement

: RGB striped arrangement

Back Lighting

: LED

■ DVD player section

(DDX9906XR / DDX8906S / DDX8706S /
DDX819WBTL)

D/A Converter

: 24 bit/32 bit

Audio Decoder

: Linear PCM / Dolby Audio / MP3 / WMA / AAC /
WAV / FLAC / Vorbis

Video Decoder

: MPEG-1 / MPEG-2 / MPEG-4 / WMV / H.264 / MKV

Wow & Flutter

: Below Measurable Limit

Frequency Response

- 96 kHz : 20 – 44,000 Hz
- 48 kHz : 20 – 22,000 Hz
- 44.1 kHz : 20 – 20,000 Hz

Total Harmonic Distortion

: 0.010 % (1 kHz)

S/N Ratio (dB)

: 90.5 dB (DVD-Video 96 kHz)

Dynamic Range

: 89 dB (DVD-Video 96 kHz)

Disc Format

: DVD-Video / VIDEO-CD / CD-DA

Quantifying Bit Number

: 16 bit/20 bit/24 bit

■ USB interface section

USB Standard

: USB 2.0 High Speed

File System

: FAT16, FAT32, exFAT, NTFS

Maximum Power Supply Current

Except DDX819WBTL
: DC 5 V $\overline{\text{DC}}$ 1.5 A × 2
DDX819WBTL
: DC 5 V $\overline{\text{DC}}$ 1.5 A × 1

D/A Converter

: 24 bit/32 bit

Audio Decoder

: MP3 / WMA / AAC / WAV / FLAC / Vorbis

Video Decoder

: MPEG-1 / MPEG-2 / MPEG-4 / WMV / H.264 / MKV

Frequency Response (DMX906S / DMX9706S)

- 192 kHz : 20 – 88,000 Hz
- 96 kHz : 20 – 44,000 Hz
- 48 kHz : 20 – 22,000 Hz
- 44.1 kHz : 20 – 20,000 Hz

Total Harmonic Distortion (DMX906S / DMX9706S)

: 0.0001 % (1 kHz)

S/N Ratio (dB) (DMX906S / DMX9706S)

: 98.5 dB

Dynamic Range (DMX906S / DMX9706S)

: 89 dB

■ Wireless Mirroring Section (Except DDX819WBTL)

Mode

: Sink

Copyright protection

: HDCP2.2

Touch Control

: UIBC

■ Wi-Fi section (Except DDX819WBTL)

IEEE Standard

: 802.11 a/b/g/n/ac

Frequency Range

: Dual Band (2.4GHz/5GHz)

Channels

: Auto(1-11ch)/Auto(149,153,157,161ch)

Transfer rates (MAX)

: 11a: 54 Mbps / 11b: 11 Mbps / 11g: 54 Mbps /
11n: 300 Mbps / 11ac: 867 Mbps

Appendix

Output Power

2.4 GHz/SISO

: 11b: 14 dBm \pm 2 dB / 11g: 13 dBm \pm 2 dB /
: 11n(20MHz):12 dBm \pm 2 dB

5 GHz/SISO

: 11a: 9 dBm \pm 2 dB /
: 11n (20 MHz): 9 dBm \pm 2 dB /
: 11n (40 MHz): 8 dBm \pm 2 dB /
: 11ac (40 MHz): 8 dBm \pm 2 dB /
: 11ac (80 MHz): 8 dBm \pm 2 dB

5 GHz/MIMO

: 11n (20 MHz): 12 dBm \pm 2 dB /
: 11n (40 MHz): 11 dBm \pm 2 dB /
: 11ac (40 MHz): 11 dBm \pm 2 dB /
: 11ac (80 MHz): 11 dBm \pm 2 dB

Bluetooth section

Technology

: Bluetooth Ver.5.0

Frequency

: 2.402 – 2.480 GHz

Output Power

: Power Class2

Maximum Communication range

: Line of sight approx. 10m (32.8 ft)

Audio Codec

: SBC/AAC

Profile (Multi Profile support)

- HFP (V1.7) (Hands Free Profile)
- SPP (Serial Port Profile)
- A2DP (Advanced Audio Distribution Profile)
- AVRCP (V1.6) (Audio/Video Remote Control Profile)
- PBAP (Phonebook Access Profile)

DSP section

Graphics equalizer

Band: 13 Band
Frequency (BAND1 – 13)
: 62.5/100/160/250/400/630/1k/1.6k/2.5k/4k/6.3k/
10k/16k Hz

Gain

: -9/-8/-7/-6/-5/-4/-3/-2/-1/0/1/2/3/4/5/6/7/8/9 dB

2-way X'Over

High pass filter

Frequency: Through, 30/40/50/60/70/80/90/100/
120/150/180/220/250 Hz
Slope: -6/-12/-18/-24 dB/Oct.

Low pass filter

Frequency: 30/40/50/60/70/80/90/100/120/150/
180/220/250 Hz, Through
Slope: -6/-12/-18/-24 dB/Oct.

3-way X'Over (Except DDX8706S / DMX9706S)

High pass filter

Frequency: 250/300/1k/1.6k/2.5k/4k/5k/6.3k/8k/
10k/12.5k Hz
Slope: -12/-18/-24 dB/Oct.

Band pass filter

Frequency: Through, 50/60/70/80/90/100/120/150/
180/220/250/300 Hz
250/300/1k/1.6k/2.5k/4k/5k/6.3k/8k Hz,
Through
Slope: -12/-18/-24 dB/Oct.

Low pass filter

Frequency: 30/40/50/60/70/80/90/100/120/150 Hz,
Through
Slope: -12/-18/-24 dB/Oct.

Position

Front/Rear/Subwoofer Delay

: 0 – 20.01 ft (0.03 or 0.04 ft Step)

Gain

: -8 – 0 dB

Subwoofer level

: -50 – +10 dB

Digital FM tuner section

(DDX9906XR / DDX8906S / DMX906S)

Frequency Range (step)

: 87.9 MHz – 107.9 MHz (200 kHz)

Frequency Response (\pm 3.0 dB)

: 20 Hz – 20 kHz

S/N Ratio

: 80 dB (STEREO)

Digital AM tuner section

(DDX9906XR / DDX8906S / DMX906S)

Frequency Range (step)

: 530 kHz – 1700 kHz (10 kHz)

Frequency Response (\pm 3.0 dB)

: 40 Hz – 15 kHz

S/N Ratio (dB)

: 80 dB (STEREO)

FM tuner section

Frequency Range (step)

: 87.9 MHz – 107.9 MHz (200 kHz)

Usable Sensitivity (S/N : 30 dB)

: 9.3 dBf (0.8 μ V/ 75 Ω)

Quieting Sensitivity (S/N : 46 dB)

: 10.2 dBf (1.13 μ V/ 75 Ω)

Frequency Response

: 30 Hz – 15 kHz

S/N Ratio (dB)

: 65 dB (MONO)

Selectivity (\pm 400 kHz)

: Over 80 dB

Stereo Separation

: 45 dB (1 kHz)

■ AM tuner section

Frequency Range (step)
: 530 kHz – 1700 kHz (10 kHz)

Usable Sensitivity
: 28 dBμ

■ Video section

Color System of External Video Input
: NTSC

External Video Input Level (mini jack)
: 1 Vp-p/75 Ω

External Audio Max Input Level (mini jack)
: 2 V/25 kΩ

Video Input Level (RCA jacks)
: 1 Vp-p/75 Ω

Video Output Level (RCA jacks)
: 1 Vp-p/75 Ω

Audio Output Level (mini jack)
: 0.9 V/10 kΩ

■ Audio section

Maximum Power (Front & Rear)
: 50 W × 4

Typical Power Output (Front & Rear)
Full Bandwidth Power (at less than 1% THD)
: 22 W × 4

Output frequency band
: 20 – 88,000 Hz

Preout Level (V)
DDX9906XR / DDX8906S / DMX906S
: 5 V/10 kΩ
DDX8706S / DDX819WBTL / DMX9706S
: 4 V/10 kΩ

Preout Impedance
: ≤ 300 Ω

Speaker Impedance
: 4 – 8 Ω

■ General

Operating Voltage
: 12V DC car battery

Installation Dimensions (W × H × D)
DDX9906XR / DDX8906S / DDX8706S /
DDX819WBTL
: 178 × 100 × 160 mm
7 × 3-15/16 × 6-5/16 inch
DMX906S / DMX9706S
: 178 × 100 × 155 mm
7 × 3-15/16 × 6-1/8 inch
With Sleeve
DDX9906XR / DDX8906S / DDX8706S
: 182 × 112 × 163 mm
7-3/16 × 4-7/16 × 6-7/16 inch
DMX906S / DMX9706S
: 182 × 112 × 153 mm
7-3/16 × 4-7/16 × 6 inch

Weight
DDX9906XR / DDX8906S / DDX8706S /
DDX819WBTL
: 2.4 kg (5.3 lbs)
DMX906S / DMX9706S
: 1.7 kg (3.8 lbs)

NOTE

• Although the effective pixels for the liquid crystal panel is given as 99.99% or more, 0.01% of pixels may not light or may light incorrectly.

Specifications are subject to change without prior notice.

About this Unit

■ Copyrights

- The Bluetooth® word mark and logos are registered trademarks owned by the Bluetooth SIG, Inc. and any use of such marks by JVC KENWOOD Corporation is under license. Other trademarks and trade names are those of their respective owners.
- Manufactured under license from Dolby Laboratories. Dolby, Dolby Audio and the double-D symbol are trademarks of Dolby Laboratories.
-  is a trademark of DVD Format/Logo Licensing Corporation registered in the U.S., Japan and other countries.
- This item incorporates copy protection technology that is protected by U.S. patents and other intellectual property rights of Rovi Corporation. Reverse engineering and disassembly are prohibited.
- Microsoft and Windows Media are either registered trademarks or trademarks of Microsoft Corporation in the United States and/or other countries.
- This software is based in part on the work of the independent JPEG Group.
- The "AAC" logo is a trademark of Dolby Laboratories.
- Use of the Made for Apple badge means that an accessory has been designed to connect specifically to the Apple product(s) identified in the badge, and has been certified by the developer to meet Apple performance standards. Apple is not responsible for the operation of this device or its compliance with safety and regulatory standards. Please note that the use of this accessory with an Apple product may affect wireless performance.
- Apple, iPhone, iPod, iPod touch, and Lightning are trademarks of Apple Inc., registered in the U.S. and other countries.
- Apple, Siri, Apple CarPlay and Apple CarPlay logo are trademarks of Apple Inc., registered in the U.S. and other countries.
- Sirius, XM and all related marks and logos are trademarks of Sirius XM Radio Inc. All rights reserved.
- HD Radio Technology manufactured under license from iBiquity Digital Corporation. U.S. and Foreign Patents. For patents see <http://dts.com/patents>. HD Radio and the HD, HD Radio, and "ARC" logos are registered trademarks or trademarks of iBiquity Digital Corporation in the United States and/or other countries.
- Pandora, the Pandora logo, and the Pandora trade dress are trademarks or registered trademarks of Pandora Media, Inc., used with permission.
- SPOTIFY and the Spotify logo are among the registered trademarks of Spotify AB.
- Android, Android Auto, Google Play and other marks are trademarks of Google LLC.
- BlackBerry®, RIM®, Research In Motion® and related

trademarks, names and logos are the property of Research In Motion Limited and are registered and/or used in the U.S. and countries around the world. Used under license from Research In Motion Limited.

- Wi-Fi® is a registered trademark of Wi-Fi Alliance®.
- The Wi-Fi CERTIFIED™ Logo is a certification mark of Wi-Fi Alliance®.
- This product includes FontAvenue® fonts licensed by NEC Corporation. FontAvenue is a registered trademark of NEC Corporation.



- This product includes "Ubiquitous QuickBoot™" technology developed by Ubiquitous Corp. Ubiquitous QuickBoot™ is a trademark of Ubiquitous Corp. Copyright© 2017 Ubiquitous Corp. All rights reserved.



- THIS PRODUCT IS LICENSED UNDER THE AVC PATENT PORTFOLIO LICENSE FOR THE PERSONAL USE OF A CONSUMER OR OTHER USES IN WHICH IT DOES NOT RECEIVE REMUNERATION TO (i) ENCODE VIDEO IN COMPLIANCE WITH THE AVC STANDARD ("AVC VIDEO") AND/OR (ii) DECODE AVC VIDEO THAT WAS ENCODED BY A CONSUMER ENGAGED IN A PERSONAL ACTIVITY AND/OR WAS OBTAINED FROM A VIDEO PROVIDER LICENSED TO PROVIDE AVC VIDEO. NO LICENSE IS GRANTED OR SHALL BE IMPLIED FOR ANY OTHER USE. ADDITIONAL INFORMATION MAY BE OBTAINED FROM MPEG LA, L.L.C. SEE [HTTP://WWW.MPEGLA.COM](http://www.mpegla.com)
- THIS PRODUCT IS LICENSED UNDER THE MPEG-4 VISUAL PATENT PORTFOLIO LICENSE FOR THE PERSONAL AND NON-COMMERCIAL USE OF A CONSUMER FOR (i) ENCODING VIDEO IN COMPLIANCE WITH THE MPEG-4 VISUAL STANDARD ("MPEG-4 VIDEO") AND/OR (ii) DECODING MPEG-4 VIDEO THAT WAS ENCODED BY A CONSUMER ENGAGED IN A PERSONAL AND NON-COMMERCIAL ACTIVITY AND/OR WAS OBTAINED FROM A VIDEO PROVIDER LICENSED BY MPEG LA TO PROVIDE MPEG-4 VIDEO. NO LICENSE IS GRANTED OR SHALL BE IMPLIED FOR ANY OTHER USE. ADDITIONAL INFORMATION INCLUDING THAT RELATING TO PROMOTIONAL, INTERNAL AND COMMERCIAL USES AND LICENSING MAY BE OBTAINED FROM MPEG LA, L.L.C. SEE [HTTP://WWW.MPEGLA.COM](http://www.mpegla.com).
- THIS PRODUCT IS LICENSED UNDER THE VC-1 PATENT PORTFOLIO LICENSE FOR THE PERSONAL AND NON-COMMERCIAL USE OF A CONSUMER TO (i) ENCODE VIDEO IN COMPLIANCE WITH THE VC-1 STANDARD ("VC-1 VIDEO") AND/OR (ii) DECODE VC-1 VIDEO THAT WAS ENCODED BY A CONSUMER ENGAGED IN A PERSONAL AND NON-COMMERCIAL ACTIVITY AND/OR WAS OBTAINED FROM A VIDEO PROVIDER LICENSED TO PROVIDE VC-1 VIDEO. NO LICENSE IS GRANTED OR SHALL BE IMPLIED FOR ANY OTHER USE. ADDITIONAL INFORMATION MAY BE OBTAINED

Appendix

FROM MPEG LA, L.L.C. SEE [HTTP://WWW.MPEGLA.COM](http://www.mpegla.com)

- libFLAC
Copyright (C) 2000-2009 Josh Coalson
Copyright (C) 2011-2013 Xiph.Org Foundation
Redistribution and use in source and binary forms, with or without modification, are permitted provided that the following conditions are met:
 - Redistributions of source code must retain the above copyright notice, this list of conditions and the following disclaimer.
 - Redistributions in binary form must reproduce the above copyright notice, this list of conditions and the following disclaimer in the documentation and/or other materials provided with the distribution.
 - Neither the name of the Xiph.org Foundation nor the names of its contributors may be used to endorse or promote products derived from this software without specific prior written permission.THIS SOFTWARE IS PROVIDED BY THE COPYRIGHT HOLDERS AND CONTRIBUTORS "AS IS" AND ANY EXPRESS OR IMPLIED WARRANTIES, INCLUDING, BUT NOT LIMITED TO, THE IMPLIED WARRANTIES OF MERCHANTABILITY AND FITNESS FOR A PARTICULAR PURPOSE ARE DISCLAIMED. IN NO EVENT SHALL THE FOUNDATION OR CONTRIBUTORS BE LIABLE FOR ANY DIRECT, INDIRECT, INCIDENTAL, SPECIAL, EXEMPLARY, OR CONSEQUENTIAL DAMAGES (INCLUDING, BUT NOT LIMITED TO, PROCUREMENT OF SUBSTITUTE GOODS OR SERVICES; LOSS OF USE, DATA, OR PROFITS; OR BUSINESS INTERRUPTION) HOWEVER CAUSED AND ON ANY THEORY OF LIABILITY, WHETHER IN CONTRACT, STRICT LIABILITY, OR TORT (INCLUDING NEGLIGENCE OR OTHERWISE) ARISING IN ANY WAY OUT OF THE USE OF THIS SOFTWARE, EVEN IF ADVISED OF THE POSSIBILITY OF SUCH DAMAGE.
- libvorbis
Copyright (c) 2002-2008 Xiph.org Foundation
Redistribution and use in source and binary forms, with or without modification, are permitted provided that the following conditions are met:
 - Redistributions of source code must retain the above copyright notice, this list of conditions and the following disclaimer.
 - Redistributions in binary form must reproduce the above copyright notice, this list of conditions and the following disclaimer in the documentation and/or other materials provided with the distribution.
 - Neither the name of the Xiph.org Foundation nor the names of its contributors may be used to endorse or promote products derived from this software without specific prior written permission.THIS SOFTWARE IS PROVIDED BY THE COPYRIGHT HOLDERS AND CONTRIBUTORS "AS IS" AND ANY EXPRESS OR IMPLIED WARRANTIES, INCLUDING, BUT NOT LIMITED TO, THE IMPLIED WARRANTIES OF MERCHANTABILITY AND FITNESS FOR A PARTICULAR

PURPOSE ARE DISCLAIMED. IN NO EVENT SHALL THE FOUNDATION OR CONTRIBUTORS BE LIABLE FOR ANY DIRECT, INDIRECT, INCIDENTAL, SPECIAL, EXEMPLARY, OR CONSEQUENTIAL DAMAGES (INCLUDING, BUT NOT LIMITED TO, PROCUREMENT OF SUBSTITUTE GOODS OR SERVICES; LOSS OF USE, DATA, OR PROFITS; OR BUSINESS INTERRUPTION) HOWEVER CAUSED AND ON ANY THEORY OF LIABILITY, WHETHER IN CONTRACT, STRICT LIABILITY, OR TORT (INCLUDING NEGLIGENCE OR OTHERWISE) ARISING IN ANY WAY OUT OF THE USE OF THIS SOFTWARE, EVEN IF ADVISED OF THE POSSIBILITY OF SUCH DAMAGE.

- libogg
Copyright (c) 2002, Xiph.org Foundation
Redistribution and use in source and binary forms, with or without modification, are permitted provided that the following conditions are met:
 - Redistributions of source code must retain the above copyright notice, this list of conditions and the following disclaimer.
 - Redistributions in binary form must reproduce the above copyright notice, this list of conditions and the following disclaimer in the documentation and/or other materials provided with the distribution.
 - Neither the name of the Xiph.org Foundation nor the names of its contributors may be used to endorse or promote products derived from this software without specific prior written permission.THIS SOFTWARE IS PROVIDED BY THE COPYRIGHT HOLDERS AND CONTRIBUTORS "AS IS" AND ANY EXPRESS OR IMPLIED WARRANTIES, INCLUDING, BUT NOT LIMITED TO, THE IMPLIED WARRANTIES OF MERCHANTABILITY AND FITNESS FOR A PARTICULAR PURPOSE ARE DISCLAIMED. IN NO EVENT SHALL THE FOUNDATION OR CONTRIBUTORS BE LIABLE FOR ANY DIRECT, INDIRECT, INCIDENTAL, SPECIAL, EXEMPLARY, OR CONSEQUENTIAL DAMAGES (INCLUDING, BUT NOT LIMITED TO, PROCUREMENT OF SUBSTITUTE GOODS OR SERVICES; LOSS OF USE, DATA, OR PROFITS; OR BUSINESS INTERRUPTION) HOWEVER CAUSED AND ON ANY THEORY OF LIABILITY, WHETHER IN CONTRACT, STRICT LIABILITY, OR TORT (INCLUDING NEGLIGENCE OR OTHERWISE) ARISING IN ANY WAY OUT OF THE USE OF THIS SOFTWARE, EVEN IF ADVISED OF THE POSSIBILITY OF SUCH DAMAGE.

Appendix

■ FCC WARNING

This equipment may generate or use radio frequency energy. Changes or modifications to this equipment may cause harmful interference unless the modifications are expressly approved in the instruction manual. The user could lose the authority to operate this equipment if an unauthorized change or modification is made.

NOTE

- This equipment has been tested and found to comply with the limits for a Class B digital device, pursuant to Part 15 of the FCC Rules. These limits are designed to provide reasonable protection against harmful interference in a residential installation.
- This equipment generates, uses and can radiate radio frequency energy and, if not installed and used in accordance with the instructions may cause harmful interference to radio communications. However, there is no guarantee that interference will not occur in a particular installation. If this equipment does cause harmful interference to radio or television reception, which can be determined by turning the equipment off and on, the user is encouraged to try to correct the interference by one or more of the following measures:
 - Reorient or relocate the receiving antenna.
 - Increase the separation between the equipment and receiver.
 - Connect the equipment into an outlet on a circuit different from that to which the receiver is connected.
 - Consult the dealer or an experienced radio/TV technician for help.

▲ CAUTION

Use of controls or adjustments or performance of procedures other than those specified herein may result in hazardous radiation exposure.

In compliance with Federal Regulations, following are reproductions of labels on, or inside the product relating to laser product safety.

JVC KENWOOD Corporation
2967-3, ISHIKAWA-MACHI,
HACHIOJI-SHI, TOKYO, JAPAN

THIS PRODUCT COMPLIES WITH DHHS RULES
21 CFR SUBCHAPTER J IN EFFECT AT DATE OF
MANUFACTURE.

Location: Bottom plate (DDX9906XR)
Top plate (DDX8906S / DDX8706S /
DDX819WBTL)

This transmitter must not be co-located or operated in conjunction with any other antenna or transmitter.

■ IC (Industry Canada) Notice

This device complies with Industry Canada's applicable licence-exempt RSSs.

Operation is subject to the following two conditions:

- (1) This device may not cause interference, and
- (2) this device must accept any interference, including interference that may cause undesired operation of the device.

▲ CAUTION

This equipment complies with FCC/IC radiation exposure limits set forth for an uncontrolled environment and meets the FCC radio frequency (RF) Exposure Guidelines and RSS-102 of the IC radio frequency (RF) Exposure rules. This equipment should be installed and operated keeping the radiator at least 20cm or more away from person's body.

Supplier's Declaration of Conformity

Trade Name: KENWOOD
Products: MONITOR WITH DVD RECEIVER
Model Name: DDX9906XR / DDX8906S /
DDX8706S / DDX819WBTL
Products: MONITOR WITH RECEIVER
Model Name: DMX906S / DMX9706S
Responsible Party: JVC KENWOOD USA
CORPORATION
2201 East Dominguez Street,
Long Beach, CA 90810, U.S.A.
PHONE: 310 639-9000

THIS DEVICE COMPLIES WITH PART 15 OF THE FCC
RULES. OPERATION IS SUBJECT TO THE FOLLOWING
TWO CONDITIONS:

- (1) THIS DEVICE MAY NOT CAUSE HARMFUL
INTERFERENCE, AND
- (2) THIS DEVICE MUST ACCEPT ANY INTERFERENCE
RECEIVED, INCLUDING INTERFERENCE THAT MAY
CAUSE UNDESIRE OPERATION.

■ CALIFORNIA, USA

This product contains a CR Coin Cell Lithium Battery which contains Perchlorate Material – special handling may apply.

See www.dtsc.ca.gov/hazardouswaste/perchlorate.

■ Información acerca de la eliminación de equipos eléctricos y electrónicos al final de la vida útil (aplicable a los países que hayan adoptado sistemas independientes de recogida de residuos)



Los productos con el símbolo de un contenedor con ruedas tachado no podrán ser desechados como residuos domésticos.

Los equipos eléctricos y electrónicos al final de la vida útil, deberán ser reciclados en instalaciones que puedan dar el tratamiento adecuado a estos productos y a sus subproductos residuales correspondientes. Póngase en contacto con su administración local para obtener información sobre el punto de recogida más cercano. Un tratamiento correcto del reciclaje y la eliminación de residuos ayuda a conservar los recursos y evita al mismo tiempo efectos perjudiciales en la salud y el medio ambiente.

■ Informação sobre a eliminação de pilhas

Este produto não deve ser eliminado como lixo doméstico geral. Devolva a pilha usada ao revendedor ou entidade autorizada para que a mesma seja devolvida ao fabricante ou importador.

A reciclagem e a eliminação de lixo de maneira apropriada ajudarão a conservar os recursos naturais ao mesmo tempo que prevenirão os efeitos prejudiciais à nossa saúde e ao meio ambiente.

■ Para cumplimiento de la IFT:

“La operación de este equipo esta sujeta a las siguientes dos condiciones:

- (1) es posible que este equipo o dispositivo no cause interferencia perjudicial y
- (2) este equipo o dispositivo debe aceptar cualquier interferencia, incluyendo la que pueda causar su operación no deseada.”

For DDX819WBTL

■ The marking of products using lasers



The label is attached to the chassis/case and says that the component uses laser beams that have been classified as Class 1. It means that the unit is utilizing laser beams that are of a weaker class. There is no danger of hazardous radiation outside the unit.



**android
auto**

pandora[®]



(SiriusXM)
READY

DOLBY AUDIO[™]



HD Radio[®]

This HD Radio receiver enables:

HD2/HD3

Bookmark

Digital Sound

Program Info

Artist Experience

Emergency Alerts

KENWOOD