

Audio Control

Audio Control Menu

Displays the Audio Control menu to set the sound effect function of this unit.

1 Display the Source Select Screen

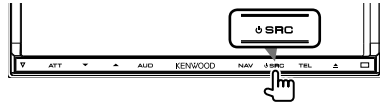

When a video screen is displayed, press the [SRC] button.

2 Display the Audio Control menu

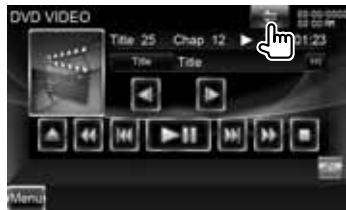

In this manual, the above selection is indicated as:
Touch [] > [].

3 Select the Audio Control item



Item	Page
[Audio Control]	72
[Equalizer]	73
[EQ]	73
[Zone Control]	74
[SRS WOW]	76
[Space Enhancer]	75

Item	Page
[Position]	75
[Surround Control]	77

Audio Control

You can adjust the front/rear and right/left audio balance.

1 Display the Audio Control screen

Touch [] > [] > [Audio Control]. (page 72)

2 Set each item

DNX9/ DDX8 series



DNX7 series



1 Adjusts the front/back and left/right volume around the touched area.

[◀], [▶] Adjusts the right and left volume balance.

[▲], [▼] Adjusts the front and rear volume balance.

[Volume Offset] Finely adjust the volume of the current source to minimize the difference in volume between different sources.



• If you have increased the volume first, then

reduced the volume using the "Volume Offset", the sound generated if you suddenly switch to another source may be extremely loud.

[Subwoofer Level] Adjusts the subwoofer volume.
The setting is available when subwoofer is set to any item other than "None". See <Speaker Setup> (page 94).

[Bass Boost] Sets the amount of bass boost. (DNX7 series only)
"OFF"/ "Step1"/ "Step2"

[Supreme] Turns ON/OFF the Supreme function. (DNX9/ DDX8 series only)
Technology to extrapolate and supplement with proprietary algorithm, the high-frequency range that is cut off when encoding.
This function works on DVD, USB, SD and iPod sources.

Equalizer Control

You can set up the equalizer.

1 Display the Equalizer screen

Touch [] > [] > [Equalizer]. (page 72)

2 Select EQ curves



[Natural], [Rock], [Pops], [Easy], [Top40], [Jazz], [Game], [iPod], [User]
Selects an equalizer curve type.
You can select any of the following equalizer curves.



• [iPod]
During iPod source only.

[EQ] Displays the Graphic Equalizer setup screen. (page 73)

Graphic Equalizer Setup

You can Manually set the equalizer curve.

1 Display the Equalizer screen

Touch [] > [] > [Equalizer]. (page 72)

2 Display the Graphic Equalizer screen



• When "iPod" is selected in <Equalizer Control>, the [EQ] button is deactivated.
"iPod" uses its equalizer function.

3 Select the channel to be adjusted (DNX9/ DDX8 series only)



[F] Front speaker
[R] Rear speaker
[C] Center speaker

4 Set the Graphic Equalizer

DNX9/ DDX8 series



DNX7 series



- Gain level can be adjusted by touching the each frequency bar.
[◀], [▶] Sets a frequency.
[▲], [▼] Sets a gain level.

[EQ Init] Returns to the previous level which the gain level is adjusted.

[Flat] Tone curve becomes flat.

[Bass EXT] Bass Extend settings.
When turned on, the frequency lower than 62.5 Hz is set to the same gain level as 62.5Hz.

[SW Level] Adjusts the subwoofer volume.
The setting is available when subwoofer is set to any item other than "None". See <Speaker Setup> (page 94).

Zone Control

You can set the front and rear audio source.

1 Display the Zone Control screen

Touch [◀] > [🔊] > [Zone Control]. (page 72)

2 Set the Zone Control



- [Single Zone]** Sets the unit to single zone.
- [Dual Zone]** Sets the unit to dual zone.
- [Front Source]** Sets the front audio source.
- [Rear Source]** Sets the rear audio source.
- [Rear VOL.]** Adjusts the volume of the rear channel.



- When the rear speaker sound is switched, the audio source that is output at the AV OUTPUT terminal is also switched to the same source.



- There are following limitations when zone function is set to "ON".
- There is no output from the subwoofer or center speaker.
- "Bass Boost" of <Audio Control> (page 72) is not available.
- <EqualizerControl> (page 73), <Space Enhancer> (page 75), <Listening Position> (page 75), <SRS WOW Control> (page 76), and <Surround Control> (page 77) are not available.
- <DSP Bypass Control> (page 93), <Speaker Setup> (page 94), <Car Type (DTA) Setup> (page 95), and <Channel Level> (page 97) are not available.

Space Enhancer (DNX7 series)

You can enhance the soundscape.

1 Display the Space Enhancer screen

Touch [◀] > [🔊] > [Space Enhancer]. (page 72)

2 Set the Space Enhancer



- Sets the soundscape level.



- You cannot set Space Enhancer in tuner source.

Listening Position

You can adjust the sound effects according to your listening position.

1 Display the Position screen

Touch [◀] > [🔊] > [Position]. (page 72)

2 Set the Position Control



- [P1] - [P3]** Stores the present adjustment setup in memory, or recalls it from memory.
To store your adjustment in memory:
Continue to touch [P1] to [P3] more than 2 seconds.
To call your adjustment from memory:
Touch [P1] to [P3] of your adjustment you wish to recall from memory.
- [◀], [▶]** Sets a listening position.
You can select any of "Front R" (Right front), "Front L" (Left front), "Front All" (All front), "All" (All), and "User" (User) positions.
- [DTA]** Displays the Position DTA (Digital Time Alignment) screen.

3 Exit Position Control



- The final distance is adjusted to the total of Car Type Set Up value (page 95) and Position Setup (both Position and Position DTA) value.
- If you change the Car Type Set Up value (page 95), the position is set to "All".

Next page ►

Audio Control

- Only the adjusted distance of position setup (Position and Position DTA values) is stored in memory. Therefore, the final adjustment distance changes if you change the Car Type Set Up value (page 95).

Position DTA Control

You can fine-adjust your listening position.

1 Display the Position DTA screen



2 Select a speaker you wish to adjust

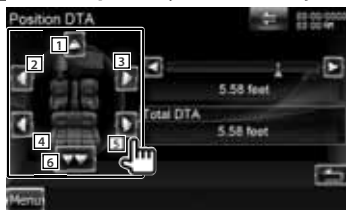

- 1 Center speaker (DNX9/ DDX8 series)
- 2 Left front speaker
- 3 Right front speaker
- 4 Left rear speaker
- 5 Right rear speaker
- 6 Subwoofer

[◀], [▶] Finely adjusts the value set with the Position function.

[Total DTA] Indicates setup position distance. The adjusted distance (Position and Position DTA values), and the total of the distance adjusted by Car Type Set Up (page 95) and the adjustment distance for position setup are indicated.

3 Finely adjust the distance



Finely adjust the value set with the Position function.

SRS WOW Control (DNX9/ DDX8 series)

You can set up the SRS WOW effect.

1 Display the SRS WOW Control screen

Touch [◀] > [🔊] > [SRS WOW]. (page 72)

2 Set the SRS WOW Control



- 1 Selects SRS WOW setting.

SRS WOW User Setup

1 Display the SRS WOW Adjust screen



2 Adjust the SRS settings



- 1 Selects a speaker to be set (Front, Rear or Center speaker).

[TruBass] Sets the TruBass effect level.

[FOCUS] Sets the FOCUS effect level.

[SRS 3D] Sets the SRS 3D effect level.



- **FOCUS:** Adjusts the vertical position of the speaker and sound image by virtual adjustment.
- **TruBass:** Assists the playback for the super bass sound.
- **SRS 3D:** Makes a natural 3D sound field.
- Some items cannot be adjusted depending on the selected speaker.
- **SRS WOW control** is not available in tuner source, TV source and HD Radio source.
- When Surround Control is Dolby Pro Logic II, SRS WOW control is not available.

Surround Control (DNX9/ DDX8 series)

You can set up the sound field.

1 Display the Surround Control screen

Touch [◀] > [🔊] > [Surround Control]. (page 72)

2 Set the Surround Control



- 1 Sets a sound field. You can select any of the following sound fields. "Bypass"/ "Bypass+Center"/ "Dolby Pro Logic II Movie"/ "Dolby Pro Logic II Music"/ "Dolby Pro Logic II Matrix"

[Stream Information] Displays the present source information. The stream (Dolby Digital, dts, Linear PCM, MPEG, SDDS, AAC or MP3/WMA), input channels (front or rear channels), and sampling frequency are displayed.



- When you have selected the TV or TUNER source and when you set the Dolby PL, we recommend you to select the "Dolby PLII Matrix" mode. If you select another Dolby PLII mode, the sound is NOT output from rear speakers when you receive monaural broadcasting sounds.
- Surround control can be set for each source.

Dolby Pro Logic II Music Adjustment

1 Display the Dolby Pro Logic II Music Adjust screen



2 Adjust the sound field



[Dimension Control] Sets the surround position by adjusting the front and rear volume balance.

[Center Width Control] Sets the vocal image position by adjusting the right and left vocal volume level.

[Panorama Mode] Turns the Panorama mode On or Off.



- You cannot use the <Surround Control Adjustment> during playback of a Multi-channel source.

Setup Menu

You can set up various receiver parameters.

How to Display SETUP Menu Screen

Displays the Setup menu to set various functions.

1 Display the Source Select Screen

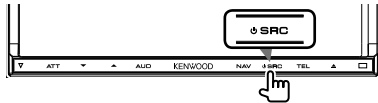

When a video screen is displayed, press the [SRC] button.

2 Display the Setup Menu Screen

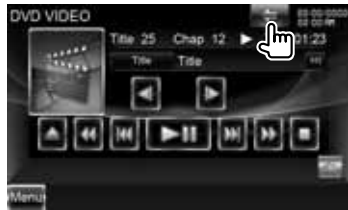

In this manual, the above selection is indicated as:
Touch [Left Arrow] > [Right Arrow].

3 Select the setup item



- [AV-IN SETUP], [Navigation] and [Audio SETUP] options can be locked. The key mark (🔒) is displayed in reverse video for the locked option.

See <Setup Memory> (page 84).

Item	Page
[DivX(R) SETUP]	79
[System]	
[User Interface]	80
[Touch]	81
[Clock]	82
[Security]	82
[Angle]	82
[EXT SW]	83
[SETUP Memory]	84
[Display]	
[Screen Control]	87
[Color]	86
[Background]	85
[Bluetooth SETUP]	88
[SIRIUS SETUP]	102
[DVD SETUP]	98
[iPod SETUP]	101
[USB SETUP]	101
[SD SETUP]	101
[TV SETUP]	101
[AV-IN SETUP]	91
[Navigation]	93
[Software]	79
[Audio SETUP]	93
[Speaker Select]	94
[Car Type]	95
[Channel Level]	97
[AV-OUT Interface]	91
[Camera SETUP]	92

DivX Setup (DNX9/ DDX8 series)

Checks the registration code. This code is needed when making a disc which has DRM (Digital Rights Management).

1 Display the DivX Setup screen

Touch [Left Arrow] > [Right Arrow] > [DivX(R) SETUP]. (page 78)



Displays the registration code.



- Disabled when a DVD is being played.
- When downloading a DivX VOD file controlled by DRM, register the code appeared on the screen such as the one above. Otherwise the file may not be able to play with this unit. Remaining number of viewing is displayed when playing a DivX VOD file with the viewing restriction. When the remaining number of viewing reached 0, a warning message appears and the file cannot be played.

Deactivating DivX Code

1 Display the DivX Deactivation Confirm screen



2 Cancel the registration



Touching the screen displays a confirmation message. Touch [OK]. To cancel clearing, touch [Cancel].

Software Information

Checks the software version of this unit.

1 Display the Software Information screen

Touch [Left Arrow] > [Right Arrow] > [Software]. (page 78)



Displays the software version.



- For how to update the software, refer to the relevant update procedure manual which comes with the software.

User Interface

You can setup user interface parameters.

1 Display the User Interface screen

Touch [Left Arrow] > [Right Arrow] > [System] > [User Interface]. (page 78)

2 Set each item



[Beep] Turns the key touch tone On or Off. (☑ "ON")

[Remote Sensor] Selects a remote control signal. (☑ "ON")
When turned "OFF", the remote control of TV reception is rejected.

[Language] Select the language used for the control screen and setting items. See <Language Setting> (page 80).

[Scroll] Allows scrolling of text display on the Source Control screen. (☑ "Manual")
"Auto": Scrolls the screen automatically.
"Manual": Allows you to scroll the screen manually.

[Drawer Close] Sets whether to close the function bar automatically. (☑ "Auto")

[AUD Key Longer than 1 Second] Sets the function of the [AUD] button. (page 12)

"V.OFF": Press the [AUD] button for longer than 1 second to turn the

display off.

"CAM": Press the [AUD] button for longer than 1 second to switch to camera view.

[Animation] Sets whether to display animation. (☑ "ON")

Language Setting

You can select the display language for the control screen and audio file tags.

1 Display the User Interface screen

Touch [Left Arrow] > [Right Arrow] > [System] > [User Interface]. (page 78)

2 Display the Language Setting screen



3 Select a language



[ASR] Selects whether to use the voice control function. (page 56) (☑ "Enabled") (DNX9960 only)

"Enabled": Voice control is activated.

"Disabled": Voice control is deactivated.

[Select Mode] Selects the mode to select a language. (☑ "Easy")
Touching [Advanced] allows you to select languages for respective items.

[Language Select] Selects a language. (☑ "American English (en)")

[Enter] Determines the selected language.

[Cancel] Cancels the selected language.

When [ASR] is set to "Disabled" (DNX9 only)

When [Select Mode] is set to "Advanced"



[GUI Language Select] Selects the display language used for the control screen and so forth. (☑ "American English (en)")

[Navigation Language Select] Selects the language used for navigation. (☑ "American English (en)") (DNX7 series only)

[User Text Language Select] Selects the language used for tag text (song information). (☑ "American English (en)")

Touch Panel Adjustment

You can adjust the touch panel operations.

1 Display the Touch panel Adjustment screen

Touch [Left Arrow] > [Right Arrow] > [System] > [Touch]. (page 78)

2 Adjust the Touch panel



Follow the instruction on the screen and touch the center of ⊕.

[Cancel] Cancels the Touch Panel Adjust.

[Reset] Resets to the initial status.

Clock and Date Setup

You can adjust the clock time.

1 Display the Clock Setup screen

Touch [Left Arrow] > [Right Arrow] > [System] > [Clock]. (page 78)

2 Setup the Clock



1 Adjusts month, day, year, hours, and minute.

[Reset] Sets "00" minute.

Setup examples: 3:00 – 3:29 → 3:00
3:30 – 3:59 → 4:00

[Synchronize] Sets the clock time in synchronization with the time data sent from the navigation system or the RDS station. (☑ DNX series: "Navigation", DDX series: "RDS")
"OFF" / "RDS"*1 / "Navigation"

When the synchronized mode is set, the clock cannot be adjusted manually. (*1 North American sales area only)

3 Adjust the date or clock time



Security Setup

A red indicator will blink on the unit after the ACC is set to OFF, warning potential thieves.

1 Display the Security screen

Touch [Left Arrow] > [Right Arrow] > [System] > [Security]. (page 78)

2 Setup the SI (Security Indicator)



[SI] Turns the SI function on or off.

If turned "ON", the security indicator on the front panel flashes when the vehicle ignition is off. (☑ "ON")

Monitor Angle Control

You can adjust the position of the monitor.

1 Display the Angle Setup screen

Touch [Left Arrow] > [Right Arrow] > [System] > [Angle]. (page 78)

2 Set the Monitor Angle

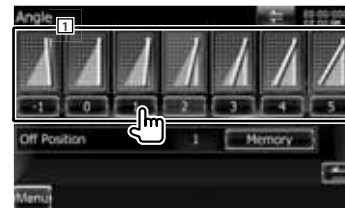

1 Sets the Monitor angle.

[Off Position] Stores the current monitor angle as the angle during power off.

EXT SW Setup

Sets up the external switch power mode.

1 Display the EXT SW screen

Touch [Left Arrow] > [Right Arrow] > [System] > [EXT SW]. (page 78)

2 Perform EXT SW Setup



[SW1 Name]/ [SW2 Name] Sets the name of the external device. See <How To Use the Character Entry Screen> (page 83) for information on how to enter a name.

[Output Pattern] Sets the power signal output mode.

(☑ EXT SW1: Pulse, EXT SW2: Level)

"Pulse": Generates a single power signal pulse.

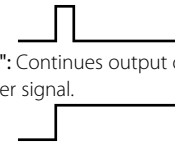

"Level": Continues output of high power signal.

Sets to turn output on/off each time the button on the EXT SW Control screen is touched. See <External Device Power Supply Control> (page 55).

[Pulse Set] Sets the Pulse signal output time.

Outputs 500ms when "1" is set. Increases by 200ms with each step. Up to 100 steps can be set.

How To Use the Character Entry Screen



1 Enters characters.

[Left Arrow], [Right Arrow] Shifts the cursor.

[Up Arrow], [Down Arrow] Scrolls up or down the character button display.

[Shift] Toggles between uppercase and lowercase.

[qwe]/ [abc] Sets the key layout of the character buttons.
abc : Alphabetical key layout.
qwe : Qwerty key layout.

[Clear] Clears the character.

[Space] Enters a space.
If you erase a character, locate the cursor on it and touch this button.



• You can enter characters only after you have applied the parking brake.

Setup Memory

Audio Control, AV-IN SETUP, AV Interface, Navigation, and Audio SETUP settings can be memorized. The memorized settings can be recalled at any time. For example, even when the settings are cleared due to replacement of the battery, the settings can be restored.

1 Display the SETUP Memory screen

Touch [Left Arrow] > [Right Arrow] > [System] > [SETUP Memory]. (page 78)

2 Start Setup Memory

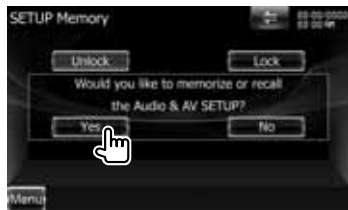

[Lock] Locks the AV-IN SETUP, Navigation, and Audio SETUP settings. When [Lock] is selected, you cannot change the AV-IN SETUP, Navigation, and Audio SETUP settings.

[Yes] Memorizes or recalls the settings.
[No] To cancel the function, touch [No]. To cancel memorization, touch [No]. The SETUP Menu screen appears again.

3 Select a desired function



[Recall] Recalls the memorized settings.
[Memory] Memorizes the current settings.

[Clear] Clears the currently memorized settings.

4 Memorize or recall the settings

When memorizing the Audio Setup and AV Interface settings:



If settings have already been memorized, a confirmation message appears. Touch [Yes]. To cancel memorization, touch [No].

When recalling the memorized settings:



Touching the screen displays a confirmation message. Touch [Yes]. To cancel recalling, touch [No].

When clearing the currently memorized settings:



Touching the screen displays a confirmation message. Touch [Yes]. To cancel clearing, touch [No].

5 Quit memorization/recalling of settings



Changing Background image

Loads an image from the connected USB device and sets it for the background image.

1 Connect the device which has the image to load

2 Display the Background screen

Touch [Left Arrow] > [Right Arrow] > [Display] > [Background]. (page 78)

3 Change Standby



4 Display the Background Memory screen



[Change] Selects an image for background.

[Delete] Deletes the background image. Touching the screen displays a confirmation message. Touch [Yes]. To cancel clearing, touch [No].

5 Select the image to load



6 Load the image



[Left Arrow] Rotates counter clockwise.

[Right Arrow] Rotates clockwise.

7 Select Background Change screen



8 Select an image for background



1 Returns to the initial background.

9 Set the image as the background





- See <About Picture files> (page 6) for readable image specifications.
- The [Memory] button on the "Background" screen becomes active only in STANDBY source mode.
- Pressing the [Memory] button on the "Background" screen switches the AV OUT source to OFF. For resetting the AV OUT source, refer to <AV Output Interface Setup> (page 91).

Panel Color Coordinate

DNX9/ DDX8 series : Sets the button illumination color.

DNX7 series : Sets the screen and button illumination color.

1 Display the Color screen

Touch [Left Arrow] > [Right Arrow] > [Display] > [Color]. (page 78)

2 Display the Panel Color Coordinate screen

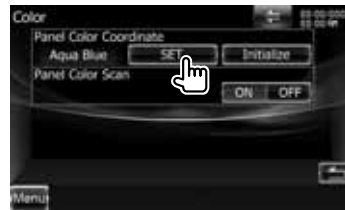

[Initialize] Initialization resets the settings made using the Panel Color to the default settings made at the factory.

[Panel Color Scan] When set to "ON", the illumination color of the screen and buttons changes one after another. (DNX9/ DDX8 series only)



- When touching [SET] or [Initialize], make sure [Panel Color Scan] is set to "OFF".

3 Select a color



1 Sets to the touched color.

[Adjust] Sets and registers favorite color to the preset buttons ([P1] – [P3]).

To register your original color

1 Start the RGB coordinate



2 Adjust each color value



1 Selects a preset number to register.

[Red Value] Adjusts the Red value.

[Green Value] Adjusts the Green value.

[Blue Value] Adjusts the Blue value.

3 Select a Preset number to register



Adjusted color is registered to the selected Preset button.

4 Complete the color coordination



Screen Control

You can adjust the screen mode of the monitor.

1 Display the Screen Control screen

Touch [Left Arrow] > [Right Arrow] > [Display] > [Screen Control]. (page 78)

2 Set each item



[Bright] Brightness Control

[Contrast] Contrast Control

[Black] Black Level Adjustment

[Dimmer] Dimmer Mode Setup (☑ "ON")

"ON": The display dims.

"OFF": The display doesn't dim.

"SYNC": Turning the Dimmer function On or Off when the vehicle light control switch is turned On or Off.

"NAV-SYNC": Turning the Dimmer function On or Off according to the Navigation Day/Night display setting. (DNX series and DDX series with navigation unit only)



- In this Screen Control screen, you can perform setups for the menu screen. Setups for videos such as DVD can be performed on the <Screen Control> (page 58).

Registering Bluetooth Unit

Registers the Bluetooth unit to be connected.

1 Display the Bluetooth Setup screen

Touch [Left Arrow] > [Right Arrow] > [Bluetooth SETUP]. (page 78)

2 Display the Connect Device List screen



3 Search for a Bluetooth unit



1 Displays the registered Bluetooth units.

[Left Arrow] When [Left Arrow] appears, the text display is scrolled by touching it.

[Search] Searches for a Bluetooth unit.

[SP DEV] Registers a Bluetooth unit that cannot be registered by normal register (pairing) operation.



- A new device cannot be registered if there are 5 registered Bluetooth units. Delete unnecessary registration. See <Bluetooth Unit Connection> (page 90).

4 Display the PIN Code Set screen



1 Display the PIN Code.

[Search] Searches for a Bluetooth unit.

[Cancel] Cancels searching of Bluetooth unit.

[PIN Code Set] Display the PIN Code Set screen.

5 Enter PIN code

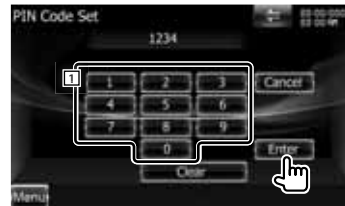

1 Enters a code number.

[Enter] Enter the PIN code specified for the Bluetooth unit to register.

This button will not be active until at least four PIN code digits have been entered.

[Cancel] Cancels registration of PIN code.

[Clear] Clears the code number.

6 Select the Bluetooth unit to register



1 Displays the searched Bluetooth unit. Returns to the Connect Device List

screen.



- You can also register from the Bluetooth unit side. For the PIN code necessary for registration, see <Registering Bluetooth Unit PIN Code> (page 89).
- If pairing cannot be done even when the PIN code is correct, try <Registering Special Bluetooth Unit>.

Registering Special Bluetooth Unit

Registers Special Bluetooth unit that results in error by normal operation by selecting from model name.

1 Display the Special Device List screen

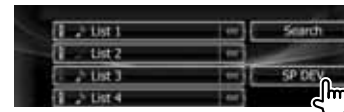

2 Select a model name



Displays the Bluetooth unit name that can be registered.

3 Confirm whether to register



- Only models in Bluetooth unit name list can be registered.

4 Go through the procedure of <Registering Bluetooth Unit> and complete the registration (pairing).

Registering Bluetooth Unit PIN Code

Sets the PIN code of the Bluetooth unit to enter when registering (pairing) from the cell-phone or audio player side.

1 Display the Bluetooth Setup screen

Touch [Left Arrow] > [Right Arrow] > [Bluetooth SETUP]. (page 78)

2 Display the Receiver PIN Code screen



3 Enter PIN code

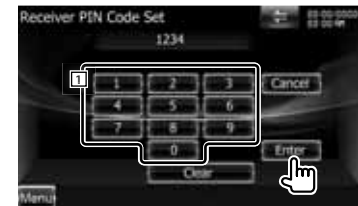

1 Enters a code number.

[Cancel] Cancels registration of PIN code.

[Enter] Enters PIN code.

[Clear] Clears the code number.

Bluetooth Unit Connection

Selects the Bluetooth unit to connect.

1 Display the Bluetooth Setup screen

Touch [Left] > [Right] > [Bluetooth SETUP]. (page 78)

2 Display the Connect Device List screen



3 Select a registered Bluetooth unit



4 Select the service to use



[TEL (HFP)] Connects/disconnects cell-phone to use for Hands Free.

[Audio (A2DP)] Connects/disconnects Audio player to use for Bluetooth Audio.

[Remove] Deletes registration (pairing). Touching the screen displays a confirmation message. Touch [Yes]. To cancel clearing, touch [No].

Bluetooth Hands-Free/Audio Output Setup

Selects speakers to output the sound of hands-free phoning (such as phone call voice and ringing tone) and Bluetooth audio.

1 Display the Bluetooth Setup screen

Touch [Left] > [Right] > [Bluetooth SETUP]. (page 78)



[Bluetooth HF/Audio] Sets the output speakers. (☑ "Front Only")

"Front Only": Outputs from the front speakers.

"All": Outputs from all the speakers.

AV Input Setup

You can set AV input parameters.

1 Display the AV-IN Setup screen

Touch [Left] > [Right] > [AV-IN SETUP]. (page 78)

2 Set each item



[AV-IN Interruption] Sets an image display of the system that is connected via the AV INPUT port. (☑ "OFF")
"OFF": When the image source is switched, an image entered via the AV INPUT port is displayed.

"ON": When an image signal is entered via the AV INPUT port, this image is displayed.

[iPod AV Interface Use] Sets the terminal which iPod is connected. (☑ "iPod")

[AV-IN1 Name], [AV-IN2 Name], [AV-IN3 Name] Sets a name to be displayed when you select a system that is connected via the AV INPUT port. (☑ "VIDEO")



- [iPod AV Interface Use]
This item can be set when in STANDBY source and also the iPod is disconnected.
- [AV-IN Name]
Two AV-IN names are displayed when "iPod" is selected in [iPod AV Interface Use] and three are displayed when not selected.
- [AV-IN3 Name]
DNX9/ DDX8 series only

AV Output Interface Setup

You can set AV output parameters.

1 Display the AV-OUT Interface screen

Touch [Left] > [Right] > [AV-OUT Interface]. (page 78)

2 Set each item



[AV-OUT] Selects an AV source to be output at the AV OUTPUT port. (☑ "OFF")

Camera Setup

You can set Camera parameters.

1 Display the AV Interface screen

Touch [Left Arrow] > [Right Arrow] > [Camera SETUP]. (page 78)

2 Set each item



[Rear Camera] Selects the type of rear camera to use. (☑ "Other")
 "CMOS-300": When the CMOS-300 with ID 1 set is connected.
 "Other": When the other camera is connected.

[R-CAM Interruption] Sets a method to switch to the rear view camera video display. (☑ "OFF")
 "ON": Switches to the rear view camera video display when engaging the shift knob of car to "Reverse".
 "OFF": Switches to the rear view camera video display when engaging the shift knob of car to "Reverse" and then pressing the [AUD] button for longer than 1 second.

The function of the [AUD] button needs to be set to "CAM" in [AUD Key Longer than 1 Second] beforehand.

[R-CAM Settings] Adjusts the CMOS-300 with ID 1 set. For details, see the option manual.

[F-CAM on AV-IN1] Turn this setting on when the CMOS-300 with ID2 set is connected. (☑ "OFF")

[F-CAM Settings] Adjusts the CMOS-300 with ID 2 set. For details, see the option manual.

Navigation Setup

You can set Navigation parameters.

1 Display the Navigation Setup screen

Touch [Left Arrow] > [Right Arrow] > [Navigation]. (page 78)

2 Set each item



[NAV Interrupt Speaker] Selects speakers used for voice guidance of the navigation system. (☑ "Front All")
 "Front L": Uses the front left side speaker for voice guidance.
 "Front R": Uses the front right side speaker for voice guidance.
 "Front All": Uses both front speakers for voice guidance.

[NAV Voice Volume] Adjusts the volume for voice guidance of the navigation system. (☑ DNX series: "25", DDX series: "21")

[NAV Mute] Mutes the volume of rear speakers during voice guidance of the navigation system. (☑ "ON")
 When turned "ON", the volume level drops for voice guidance.

[Navigation Input] Selects a navigation system connection. (☑ "RGB") (DDX series only)
 "RGB": Allows the Kenwood's Navigation System to connect via its interface cable.
 "AV-IN": Allows a third-party navigation system to connect via the AV INPUT1

port.
 "OFF": Must be used if no navigation system is connected. (The navigation display is cancelled when the AV source is switched.)

[On Screen Navigation] Sets an on-screen display of the navigation screen. (☑ "OFF") (DDX series only)
 "Auto": Information is displayed for 5 seconds when updated. (Example : when the track/file/song has changed to the next one.)
 "OFF": Information is not displayed.



- [On Screen Navigation]
 It can be set only when [Navigation Input] is set to "AVIN".

DSP Bypass Control (DNX7 series)

Temporarily bypassing DSP (Digital Signal Processor) System.

1 Display the Audio SETUP screen

Touch [Left Arrow] > [Right Arrow] > [Audio SETUP]. (page 78)

2 Set the DSP Select



[Bypass] There is no effect by DSP.
[Through] There is an effect by DSP.



- When the mode is set to [Bypass], DSP System cannot be adjusted.

Speaker Setup

You can select a speaker type and its size to get the best sound effects.

1 Display the Speaker Select screen

Touch [Left Arrow] > [Right Arrow] > [Audio SETUP] > [Speaker Select]. (page 78)

2 Select a speaker you wish to adjust

When the speaker type and size are set, the speaker crossover network and equalizer curve are set automatically.

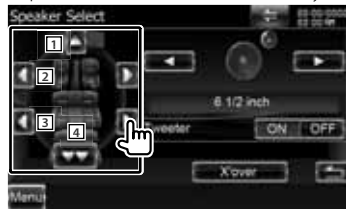

- 1 Center speaker (DNX9/ DDX8 series)
- 2 Front speaker
- 3 Rear speaker
- 4 Subwoofer

[Tweeter] You can set the tweeter when you are selecting front speakers. If you are using a tweeter together with the front speakers, set the tweeter to "ON". In the "ON" position, the Equalizer is adjusted to its best position.

[X'over] Displays the Speaker Crossover Setup screen.

You can adjust the crossover setup that was set automatically when you selected the speaker type.

3 Select a speaker type



You can select any of the following speaker types.

"Center" None, 2-3/4x1-9/16 inch, 2 inch, 4 inch, 5 inch, 6-1/2 inch over

"Front" OEM, 4 inch, 5 inch, 6-1/2 inch, 6-3/4 inch, 7 inch, 4x6, 5x7, 6x8, 6x9, 7x10

"Rear" None, OEM, 4 inch, 5 inch, 6-1/2 inch, 6-3/4 inch, 7 inch, 4x6, 5x7, 6x8, 6x9, 7x10

"Subwoofer" None, 6 1/2 inch, 8 inch, 10 inch, 12 inch, 15 inch over



- Select "None" if you have no speakers.
- If you set the center speaker to "None" even in a short time when you are setting the Surround Control to "Bypass+Center", the Surround Control is set to "Bypass" automatically. See <Surround Control> (page 77).
- If you set the center and rear speakers to "None" when you are setting the Surround Control to "Dolby PL II", the Surround Control is set to "Bypass" automatically. See <Surround Control> (page 77).

Crossover Network Setup

You can set a crossover frequency of speakers.

1 Select the speaker to set the crossover



- 1 Sets the High Pass Filter of the center speaker. (DNX9/ DDX8 series)
- 2 Sets the High Pass Filter of the front speaker.
- 3 Sets the High Pass Filter of the rear speaker.
- 4 Sets the Low Pass Filter of the subwoofer.

2 Display the Crossover setup screen



3 Set the crossover



[Phase] Sets the phase of subwoofer output.

The phase is reversed 180 degrees when set to "Reverse". (Only when "Subwoofer" is set to any item other than "None" in Speaker Setup)

[HPF FREQ] High Pass Filter adjustment. (When front, center or rear speaker is selected on Speaker Select screen)

[LPF FREQ] Low Pass Filter adjustment. (When Subwoofer is selected on Speaker Select screen)

[Slope] Sets a crossover slope.

Car Type (DTA) Setup

You can setup the car type and speaker network, etc.

1 Display the Car Type Setup screen

Touch [Left Arrow] > [Right Arrow] > [Audio SETUP] > [Car Type]. (page 78)

2 Setup the Car Type

If your car type is selected, the Digital Time Alignment and Equalizer is set automatically (for timing adjustment of sound output for each channel) to have the highest surround effects.



1 Sets up the car type you use together with this unit.

You can choose according to type of your car. "OFF", "Compact", "Full Size Car", "Wagon", "Minivan", "SUV", "Minivan (Long)"

[Location] Sets the locations of the speakers.

[Adjust] Displays the Car Type Adjust screen.

You can adjust the digital time alignment that was set automatically when you selected the car type.

Speaker Location setup

1 Display the Speaker Location Setup screen



2 Set the speaker locations



[Front Speaker] Sets the location of the front speaker.

"Door", "On Dash", "Under Dash"

[Rear Speaker] Sets the location of the rear speaker.

"Door", "Rear Deck"

"2nd Row", "3rd Row" (Minivan, Minivan (Long))

Car Type Adjust

You can manually set the sound output timing of each channel.

1 Display the Car Type Adjust screen



2 Select a speaker you wish to adjust



- 1 Center speaker (DNX9/ DDX8 series)
- 2 Front speaker
- 3 Rear speaker
- 4 Subwoofer

3 Set a delay time

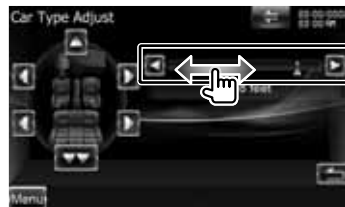

Make fine adjustment of the delay time of the speaker output specified at <Setup the Car Type> to have a more suitable environment for your vehicle. The settings of the delay time are automatically identified and compensated by specifying the distances of each speaker from the center of the vehicle interior.

1 Set the front and rear positions and the height of the reference point to the position of the ears of the person

sitting in the front seat, and set the right and left positions to the center of the vehicle interior.

- 2 Measure the distances from the reference point to the speakers.
- 3 Calculate the distance difference in accordance with the farthest speaker.

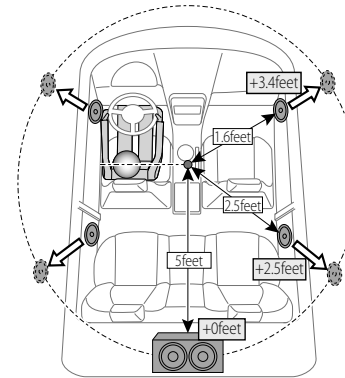

Channel Level (DNX9/ DDX8 series)

You can set the volume at each setup position.

1 Display the Car Type Setup screen

Touch [Left Arrow] > [Right Arrow] > [Audio SETUP] > [Channel Level]. (page 78)

2 Select a speaker you wish to adjust

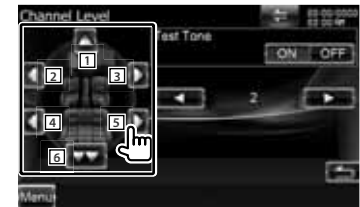

- 1 Center speaker
- 2 Left front speaker
- 3 Right front speaker
- 4 Left rear speaker
- 5 Right rear speaker
- 6 Subwoofer

[Test Tone] Starts or stops test signal tone output for setup check.

3 Adjust the volume



DVD Setup

You can set up the DVD play.

1 Display the DVD Setup screen

Touch [Left] > [Right] > [DVD SETUP].
(page 78)

2 Set each item



[Menu Language]*1 Selects a disc menu language. See <DVD Language Setup> (page 99).

[Subtitle Language]*1 Selects a subtitle language. See <DVD Language Setup> (page 99).

[Audio Language]*1 Selects an audio language. See <DVD Language Setup> (page 99).

[Dynamic Range Control]*1 Sets the dynamic range. (☑ "Dialog")
The dynamic range is reduced by changing from "Wide" to "Normal" and from "Normal" to "Dialog". "Dialog" makes the total sound volume becomes larger as compared with "Wide" and "Normal", allowing you to listen to the movie's dialog more clearly.
This is effective only when you are using a Dolby Digital software.

The operation is available during the play stop mode.

[Angle Mark] Sets an angle mark display. (☑ "ON")

[Screen Ratio]*1 Selects the screen display mode. (☑ "16:9")

"16:9": Displays wide pictures.

"4:3 LB": Displays wide pictures in the Letter Box format (having black stripes at the top and bottom of screen).

"4:3 PS": Displays wide pictures in the Pan & Scan format (showing pictures cut at the right and left ends).

[Parental Level]*1 Displays the Parental Lock screen. (☑ "OFF")
See <DVD Parental Level Setup> (page 99).

[Disc SETUP] Makes the settings related to the disc media. See <Disc Setup> (page 100).

[Stream Information] Displays the present source information.
The stream (Dolby Digital, dts, Linear PCM, MPEG, MP3, WMA or AAC) is displayed. (DNX7 series only)



*1 Disabled when a DVD is being played.

DVD Language Setup

Selects a language you use for the speech and menus.

1 Display the DVD Setup screen

Touch [Left] > [Right] > [DVD SETUP].
(page 78)

2 Select the language item to set



3 Enter a language code

See <DVD Language Codes> (page 115) and select the desired language.

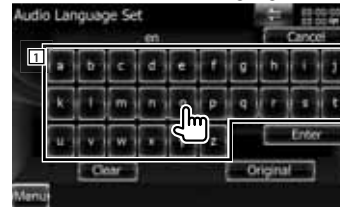

1 Enters a language code.

[Cancel] Cancels the language setup and returns to the "DVD SETUP" screen.

[Enter] Sets the language and returns to the "DVD SETUP" screen. (It appears after you have entered a language code.)

[Original] Sets the DVD's original language (only when setting an audio language).

[Clear] Clears the language code.

4 Set the language you use



DVD Parental Level Setup

Sets a parental level.

1 Display the DVD Setup screen

Touch [Left] > [Right] > [DVD SETUP].
(page 78)

2 Display the Parental Level code number screen



3 Enter the code number



1 Enters a code number.

[Cancel] Cancels the current setup and returns to the "DVD SETUP" screen.

[Level] Indicates the present parental lock level.

[Enter] Determines the code number and displays the Parental Level setup screen.

Setup Menu

[Clear] Clears the code number.



- The number you enter first is set as your code number.

4 Display the Parental Level SETUP screen



5 Select a parental level and complete the setup



Selects a parental level.



- If a disc has higher parental lock level, you need to enter the code number.
- The parental lock level varies depending on a loaded disc.
- If a disc has no parental lock, anybody can play it back even when you have set the parental lock.

Disc Setup

Performs setup when using disc media.

1 Display the DVD Setup screen

Touch [Left] > [Right] > [DVD SETUP].
(page 78)

2 Display the Disc Setup screen



3 Set each item



[CD Read] Sets a music CD playback.

(☑ "1")

"1": Automatically recognizes and plays back an Audio file disc, a DVD or a music CD.

"2": Forcibly plays back a disc as a music CD. Select "2" if you wish to play a music CD having a special format or if you cannot play a disc in the "1" position.

[On Screen DVD] Sets an on-screen display of the DVD Playback screen.

(☑ "OFF")

"Auto": Information is displayed for 5 seconds when updated.

"OFF": Information is not displayed.



- [CD Read]

Disabled when a disc is in the unit.

You cannot play an Audio file/VCD disc in the "2" position. Also, you may not play some music CDs in the "2" position.

USB Setup

Performs setup when using USB.

1 Display the USB Setup screen

Touch [Left] > [Right] > [USB SETUP].
(page 78)

2 Set each item

Example : USB Setup screen



[Picture Display Time] Selects a picture display time. (☑ "Long")

The Display of a JPEG picture is changed. ("Short", "Middle", "Long")

[On Screen USB] Sets an on-screen display of the USB Playback screen.

(☑ "Auto")

"Auto": Information is displayed for 5 seconds when updated.

"OFF": Information is displayed when you touch on the screen.

iPod Setup

Performs setup when using iPod.

1 Display the iPod Setup screen

Touch [Left] > [Right] > [iPod SETUP].
(page 78)

2 Set each item



[AudioBook Speed] Sets the Audio book playback speed. (☑ "Normal")

[Wide Screen] Sets Wide Screen on or off. (☑ "OFF")

[On Screen iPod] Sets an on-screen display of the iPod Playback screen. (☑ "Auto")

"Auto": Information is displayed for 5 seconds when updated.

"OFF": Information is displayed when you touch on the screen.



- "Wide Screen" cannot be set while the iPod is connected.

SIRIUS Parental Code Setup

Sets a SIRIUS Parental code. (with the optional accessory SIRIUS Tuner connected only)

1 Display the SIRIUS Setup screen

Touch [Left Arrow] > [Right Arrow] > [SIRIUS SETUP]. (page 78)

2 Display the Parental Code screen



- If you have already completed the code registration, [Change] is displayed.

3 Enter the Parental Code number



1 Enters a code number.

[Cancel] Cancels the current setup and returns to the SIRIUS Setup screen.

[Enter] Determines the code number.

[Clear] Clears the code number.

4 Confirm the code number

Enter the same code number as you input in step 3.



SIRIUS Parental code is now set, and the display returns to SIRIUS Setup screen.

Change the Parental Code

1 Display the Parental Code screen



[Clear] Clears the Parental Code.



- Pressing [Clear] for 5 seconds or longer deletes the code.

2 Enter the current code number



3 Enter the new code number



4 Confirm the code number

Enter the same code number as you input in step 3.
SIRIUS Parental code is now set, and the display returns to SIRIUS Setup screen.

Parental Lock Setup

Selects the channel to enable SIRIUS Parental lock function.

1 Display the SIRIUS Setup screen

Touch [Left Arrow] > [Right Arrow] > [SIRIUS SETUP]. (page 78)

2 Display the Parental Code screen



- You need to complete <SIRIUS Parental Code Setup> beforehand.

3 Enter the code number

Enter the same code number as you originally input <SIRIUS Parental Code Setup> (page 102).



4 Display the Parental Code screen



5 Enter the code number



6 Select a category

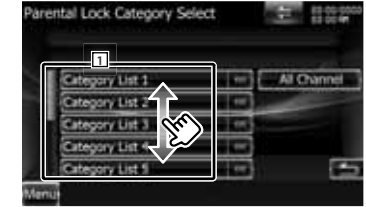

1 Category list

Displays all the channels in the selected category.

[All Channel] Displays all the channels.

7 Set the parental lock for each channel



1 Channel list

2 Sets the Parental lock function on or off for each channel.

3 Selects a channel

[Info Change] Switch the sequence of the channel list. (Channel name, Song title, Artist name, Composer name, and Category name)

[UP] Moves to SIRIUS Category Select screen.

Setup Menu

SIRIUS Skip Channel Select

Sets the undesired channels unselected.

1 Display the SIRIUS Setup screen

Touch [←] > [SIRIUS SETUP]. (page 78)

2 Display the Skip Category Select screen



3 Select a category



1 Category list

Displays all the channels in the selected category.

[All Channel] Displays all the channels.

4 Set the skip for each channel

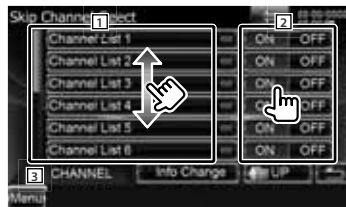

1 Channel list

2 Sets the skip function on or off for each channel.

3 Selects a channel

[Info Change] Switch the sequence of the channel list. (Channel name, Song title, Artist name, Composer name, and Category name)

[UP] Moves to SIRIUS Category Select screen.

TV Setup

The TV signal receiving areas can be set. (with the optional accessory TV Tuner connected only)

1 Display the TV SETUP screen

Touch [←] > [TV SETUP]. (page 78)

2 Set each item



[On Screen TV] Sets an on-screen display of the TV screen.

[Auto] (with the optional accessory TV tuner connected only)

"Auto": Information is displayed for 5 seconds when updated.

"OFF": Information is displayed when you touch on the screen.

Remote Controller

This unit can be operated using the Remote Controller supplied with this unit.

CAUTION

- Put the Remote Controller in a place where it will not move during braking or other operations. A dangerous situation could result, if the Remote Controller falls down and gets wedged under the pedals while driving.
- Do not leave the battery near fire or under direct sunlight. A fire, explosion or excessive heat generation may result.
- Do not recharge, short, break up or heat the battery or place it in an open fire. Such actions may cause the battery to leak fluid. If spilled fluid comes in contact with your eyes or on clothing, immediately rinse with water and consult a physician.
- Place the battery out of reach of children. In the unlikely event that a child swallows the battery, immediately consult a physician.

Battery installation

Use two "AAA"/"R03"-size batteries. Insert the batteries with the + and - poles aligned properly, following the illustration inside the case.

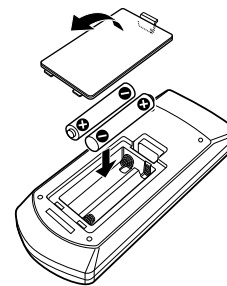

- The Remote Controller operates only over shorter distances or does not operate at all, it is possible that the batteries are depleted. In such instances, replace the both batteries with new ones.

Remote Controller mode switch

The functions operated from the remote controller differ depending on the position of the mode switch.

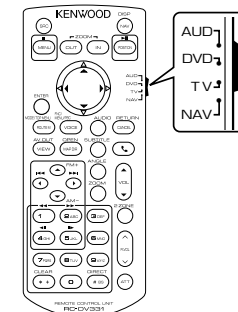

AUD mode

Switch to this mode when controlling a selected source or tuner source, etc.

DVD mode

Switch to this mode when playing DVDs or CDs etc. with the player integrated in this unit.

Remote Controller

TV mode

This is switched when controlling TV.

NAVI mode

This is switched when controlling Navigation unit.



- The position of the remote control mode switch is indicated in the title of each mode, e.g., "(AUD mode)".
- When controlling a player that is not integrated in the unit, select "AUD" mode.

Common operations (AUD mode)

Source switching

Switches to the source to be played.

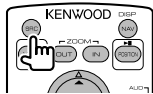

Volume control

Adjusts the volume.

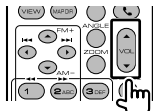

Volume attenuator

Press the key once to lower the volume.

Press again to restore the previous volume.



Dual Zone

Switches the Dual Zone function ON and OFF.

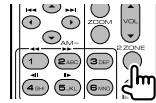

Rear volume control

Adjusts volume at rear when the Dual Zone function is ON.

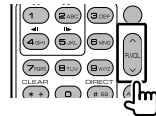

V.SEL

Switches to the navigation screen.

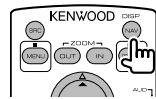

Display angle

Switches the display angle each time it is pressed.

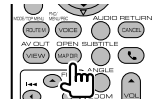

Cursor key

Moves the cursor when displaying menu.

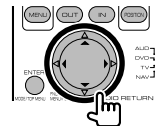

ENTER

Enters options.

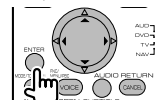

Hands-free communication

When a call comes in, it answers the call.

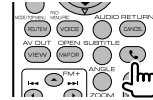

Function

Switches the function screen

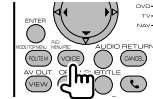

MODE

Switches the screen mode.

Screen mode changes each time you press this key.

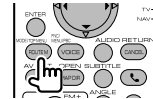

DVD/VCD (DVD mode)

Track search and file search

Selects the track or file to be played.

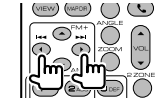

Play/Pause

Pauses the track.

Press again to resume playing.

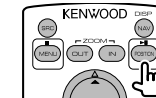

Stop

Memorizes the last point where the disc stopped. When pressed again, the last point is deleted.

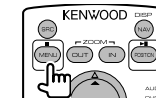

Direct search



Pressing this key switches the features that can be searched directly.

DVD-VIDEO

Title number

Chapter number

Play time

Item number*

Cancel

* You may not be able to use this function with some discs or scenes.

Remote Controller

VCD 1.X, VCD 2.X (PBC OFF)

Track number

Cancel

VCD 2.X (PBC ON)

Scene number

Number

Cancel

Once you have switched to the direct search feature, specify the search number from the numeric keypad, and then press [ENTER] key.

Numeric keypad

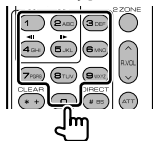

- Specify the number to search in direct search.
- Press **1** **2** to fast forward/backward. Switches the fast forward/backward speed each time you press this key.
- Press **4** **5** to slow forward/backward. Switches the slow playback speed each time you press this key.

DVD Top Menu

Returns to the DVD top menu.

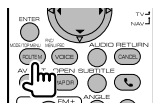

DVD Menu

Displays the DVD menu.

Turns the playback control on or off while playing VCD.

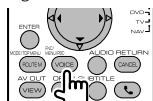

SUBTITLE

Switches the subtitle language.

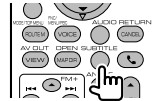

ZOOM

Switches the zoom ratio each time you press this key.

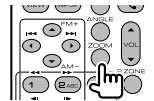

Picture Angle

Switches the picture angle each time you press this key.

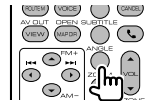

AUDIO

Switches the voice language each time you press this key.

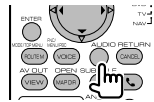

Music CD/Audio file/Video file/ Picture file (AUD mode)

Folder search

Selects the folder to be played.

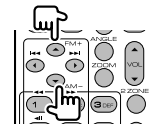

Track search and file search

Selects the track or file to be played.

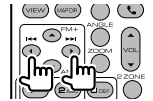

Play/Pause

Pauses the track or file.

Press again to resume playing.

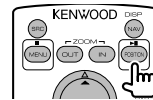

Direct search

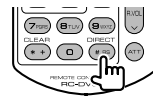

Pressing this key switches the features that can be searched directly.

Music CD

Track number

Play time

Cancel

Audio files in DVD/CD disc

Folder number

File number

Cancel

Once you have switched to the direct

search feature, specify the search number from the numeric keypad, and then press [▶||] key.

Numeric keypad

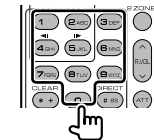

- Specify the number to search in direct search.

iPod (AUD mode)

Music/Video search

Selects the music/video to be played.

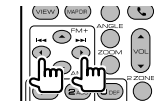

Play/Pause

Pauses the music/video.

Press again to resume playing.

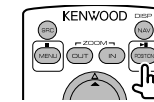

Radio (AUD mode)

FM band switching

Switches to bands received by the unit.

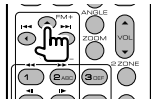

AM band

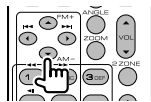

Station selection

Switches to broadcast stations received by the unit.

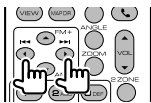

Seek mode switching

Switches the Seek mode (AUTO1, AUTO2, MANU).

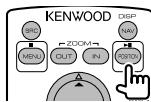

Direct tuning

After pressing this key, use the keypad to specify the broadcast station you wish to receive.

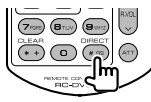

Example: 92.1MHz (FM)

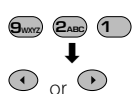

Example: 810kHz (AM)

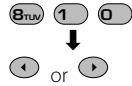

Numeric keypad

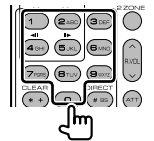

- To use preset tuning, press the number of a programmed broadcast station.
- Press the direct tuning key first, then specify the frequency of the station to receive.

NAVI (NAVI mode)

Cursor key

Scrolls the map, or moves the cursor.

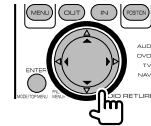

ENTER

Performs the selected function.

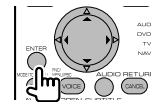

ZOOM

Zooms in or out the navigation map.

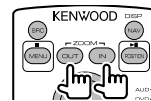

MENU

Displays Main menu.

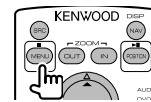

CANCEL

Displays previous screen.

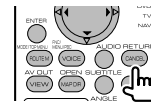

POSITION

Displays the current position.

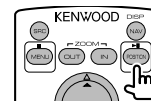

ROUTE M

Displays Route Option menu.

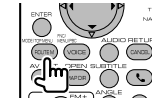

VIEW

Switches between 2D and 3D map displays.



VOICE

Plays Voice guidance.

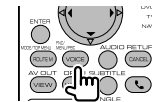

MAP DIR

Switches between the heading up navigation and north up navigation map displays.



TV (TV mode)

Switching Band/Video

It switches between the station of the TV band to receive and video input.

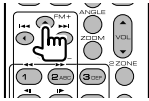

Channel Selection

The TV channel to receive is selected.

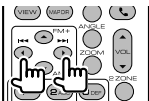

Direct tuning (NTSC TV type only)

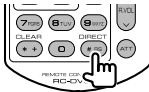

Press this key first, and then specify the station to receive with the numeric keypad.
Example: In case of Channel 6 (2-digit)

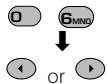

Numeric keypad

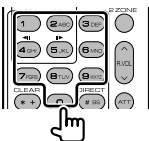

- The number of the memorized station is selected. (1 - 6)
- Press the direct tuning key first, then specify the channel of the station to receive.

Initial Setup

When pressing the Reset button or turning on the unit for the first time, the Initial SETUP screen is displayed.

Initial Setup

- 1 Turns the power On**
- 2 Set each item**

- 3 End initial setup**

• The settings above can be changed in <Setup Menu> (page 78).

[Language] Select the language used for the control screen and setting items. (page 80)

[Angle] You can adjust the position of the monitor. (page 82)

[iPod AV Interface Use] Sets the terminal which the iPod is connected to. (iPod)

[Color] Sets the screen and button illumination color. (page 86)

[EXT SW] Setting up external switch power mode. (page 83)

[Camera] You can set Camera parameters. See <Camera Setup> (page 92).

Status bar Indicator items

Shown below is a list of indicators displayed on the Status bar.



Source	Display	Overview	
General	"ATT"	Indicates that the attenuator is active.	
	"DUAL"	Turns on the Dual zone function.	
	"LOUD"	Indicates that the Loudness control function is ON.	
Bluetooth	"TEL"	Indicates the connection state of the Bluetooth hands-free unit. (White: Connected. Orange: Not connected.)	
	"FO-REP"	Indicates that the Folder repeat function is ON.	
	"IN"	Indicates that a disc is inserted. (White: A Disc is inside the unit. Orange: Error at the disc player.)	
DVD/CD	"MOVIE"	Identifies the video file.	
	"MUSIC"	Identifies the music file.	
	"RDM"	Indicates that the Random function is ON.	
	"REP"	Indicates that the Repeat function is ON.	
	"C-REP"	Indicates that the Chapter repeat function is ON.	
	"T-REP"	Indicates that the Title repeat function is ON.	
	"1chLL"	Identifies the left audio output of channel 1.	
	"1chLR"	Identifies the monaural audio output of channel 1.	
	"1chRR"	Identifies the right audio output of channel 1.	
	"1chST"	Identifies the stereo audio output of channel 1.	
Video	"LL"	Identifies the left audio output.	
	"LR"	Identifies the monaural audio output.	
	"RR"	Identifies the right audio output.	
	"ST"	Identifies the stereo audio output.	
	"PBC"	Indicates that the PBC function is ON.	
	"SVCD"	Identifies the Super Video CD.	
	"VER1"	Indicates that the Video CD version is 1.	
	"VER2"	Indicates that the Video CD version is 2.	
	"REP"	Indicates that the Repeat function is ON.	
	USB	"FO-REP"	Indicates that the Folder repeat function is ON.
		"MOVIE"	Identifies the video file.
		"MUSIC"	Identifies the music file.
		"PICTURE"	Identifies the image file.
		"RDM"	Indicates that the Random function is ON.
"REP"		Indicates that the Repeat function is ON.	
"PLST"		Indicates that the Play list mode is selected now.	

Source	Display	Overview	
iPod	"MUSIC"	Identifies the music file.	
	"VIDEO"	Identifies the video file.	
	"RDM"	Indicates that the Random function is ON.	
	"A-RDM"	Indicates that the Album random function is ON.	
	"REP"	Indicates that the Repeat function is ON.	
Tuner	"AF"	Indicates that the AF search function is ON.	
	"AUTO1"	Indicates that Seek mode is set to Auto1.	
	"AUTO2"	Indicates that Seek mode is set to Auto2.	
	"CRSC"	Indicates that the CRSC function is OFF.	
	"MANU"	Indicates that Seek mode is set to Manual.	
	"RDS"	Indicates the state of the RDS station when the AF function is ON. (White: RDS is being received. Orange: RDS is not being received.)	
	"ST"	Indicates that stereo broadcast is being received.	
	"TI"	Indicates the reception state of traffic information. (Orange: TP is being received. White: TP is not being received.)	
	HD Radio	"AUTO1"	Indicates that Seek mode is set to Auto1.
		"AUTO2"	Indicates that Seek mode is set to Auto2.
"MANU"		Indicates that Seek mode is set to Manual.	
"HD"		Indicates that HD Radio station is being received.	
"M/S"		Indicates whether the reception channel is main or sub. (Orange: Sub channel White: Main channel)	
SIRIUS XM	"ANALOG"	Indicates that analog broadcast is being received.	
	"DIGITAL"	Indicates that digital broadcast is being received.	
	"ST"	Indicates that stereo broadcast is being received.	
	"TAG"	Indicates that Tagging is enabled.	
	"SCN"	Indicates that the channel scan function is ON.	
	"SEEK1"	Indicates that Seek mode is set to 1.	
	"SEEK2"	Indicates that Seek mode is set to 2.	
	TV	"AUTO1"	Indicates that Seek mode is set to Auto1.
		"AUTO2"	Indicates that Seek mode is set to Auto2.
		"MANU"	Indicates that Seek mode is set to Manual.

DVD Language Codes

Code	Language	Code	Language	Code	Language
aa	Afar	ie	Interlingue	ru	Russian
ab	Abkhazian	ik	Inupiak	rw	Kinyarwanda
af	Afrikaans	id	Indonesian	sa	Sanskrit
am	Amharic	is	Icelandic	sd	Sindhi
ar	Arabic	it	Italian	sg	Sangho
as	Assamese	ja	Japanese	sh	Serbo-Croatian
ay	Aymara	ju	Javanese	si	Singhalese
az	Azerbaijani	ka	Georgian	sk	Slovak
ba	Bashkir	kk	Kazakh	sl	Slovenian
be	Byelorussian	kl	Greenlandic	sm	Samoan
bg	Bulgarian	km	Cambodian	sn	Shona
bh	Bihari	kn	Kannada	so	Somali
bi	Bislama	ko	Korean	sq	Albanian
bn	Bengali, Bangla	ks	Kashmiri	sr	Serbian
bo	Tibetan	ku	Kurdish	ss	Siswati
br	Breton	ky	Kirghiz	st	Sesotho
ca	Catalan	la	Latin	su	Sundanese
co	Corsican	lb	Luxembourgish	sv	Swedish
cs	Czech	ln	Lingala	sw	Swahili
cy	Welsh	lo	Laotian	ta	Tamil
da	Danish	lt	Lithuanian	te	Telugu
de	German	lv	Latvian, Lettish	tg	Tajik
dz	Bhutani	mg	Malagasy	th	Thai
el	Greek	mi	Maori	ti	Tigrinya
en	English	mk	Macedonian	tk	Turkmen
eo	Esperanto	ml	Malayalam	tl	Tagalog
es	Spanish	mn	Mongolian	tn	Setswana
et	Estonian	mo	Moldavian	to	Tongan
eu	Basque	mr	Marathi	tr	Turkish
fa	Persian	ms	Malay	ts	Tsonga
fi	Finnish	mt	Maltese	tt	Tatar
fj	Fiji	my	Burmese	tw	Twi
fo	Faroese	na	Nauru	uk	Ukrainian
fr	French	ne	Nepali	ur	Urdu
fy	Frisian	nl	Dutch	uz	Uzbek
ga	Irish	no	Norwegian	vi	Vietnamese
gd	Scots Gaelic	oc	Occitan	vo	Volapuk
gli	Galician	om	(Afan) Oromo	wo	Wolof
gn	Guarani	or	Oriya	xh	Xhosa
gu	Gujarati	pa	Punjabi	yo	Yoruba
ha	Hausa	pl	Polish	zh	Chinese
he	Hebrew	ps	Pashto, Pushto	zu	Zulu
hi	Hindi	pt	Portuguese		
hr	Croatian	qu	Quechua		
hu	Hungarian	rm	Rhaeto-Romance		
hy	Armenian	rn	Kirundi		
ia	Interlingua	ro	Romanian		

Help? Troubleshooting

Some functions of this unit may be disabled by some settings made on this unit.

- ❗ **Cannot set up the subwoofer.**
 - **Cannot set up subwoofer phase.**
 - **No output from the subwoofer.**
 - **Cannot set up the low pass filter.**
 - **Cannot set up the high pass filter.**
- ▶ Subwoofer is not set to On.
☞ <Speaker Setup> (page 94)
- ▶ The Dual zone function is enabled.
☞ <Zone Control> (page 74)

- ❗ **Cannot select the output destination of the subsource in the Dual zone.**
 - **Cannot adjust the volume of the rear speakers.**
- ▶ The Dual zone function is disabled.
☞ <Zone Control> (page 74)

- ❗ **Cannot play audio files.**
 - ▶ "CD Read" of <Disc Setup> (page 100) is set to "2".

- ❗ **Cannot Folder select.**
 - ▶ The Random play function is enabled.

- ❗ **Cannot perform Repeat play.**
 - ▶ The PBC function of the Video CD is enabled.

- ❗ **Cannot set up the equalizer.**
 - **Cannot set up the crossover network.**
- ▶ The Dual zone function is enabled.
☞ <Zone Control> (page 74)
- ▶ The DSP Select is Bypass.
☞ <DSP Bypass Control> (page 93)

What might seem to be a malfunction in your unit may just be the result of slight misoperation or miswiring. Before calling service, first check the following table for possible problems.

General

- ❓ **The Touch Sensor Tone doesn't sound.**
 - ✓ The preout jack is being used.
 - ☞ The Touch Sensor Tone can't be output from the preout jack.

Tuner source

- ❓ **Radio reception is poor.**
 - ✓ The car antenna is not extended.
☞ Pull the antenna out all the way.
 - ✓ The antenna control wire is not connected.
☞ Connect the wire correctly, referring to the section on <INSTALLATION MANUAL>.

Disc source

- ❓ **The specified disc does not play, but another one plays instead.**
 - ✓ The specified CD is quite dirty.
☞ Clean the CD.
 - ✓ The disc is severely scratched.
☞ Try another disc instead.

Audio file source

- ❓ **The sound skips when an Audio file is being played.**
 - ✓ The media is scratched or dirty.
☞ Clean the media, referring to the CD cleaning of the section on <Handling discs> (page 4).
 - ✓ The recording condition is bad.
☞ Record the media again or use another media.

Help? Error

When the unit fails to operate correctly, the cause of the failure appears on the display.

"Protect" :

Protective circuit has been activated because a speaker cord has shorted or it has come in contact with the car chassis.

- ☞ Wire or insulate the speaker cord as appropriate and then push the Reset button.

"Hot Error" :

When the internal temperature of this unit rises to 60°C or more, the protection circuit is activated and you may not be able to operate the unit. At such times this message will appear.

- ☞ Use the unit again after reducing the temperature inside the vehicle.

"Hold Error" :

Activation of the protective circuit when the temperature inside the disc changer is higher than 60 degrees Celsius stops the disc changer from operating. At such times this message will appear.

- ☞ Use when the temperature at the site where the disc changer has been fitted has dropped.

"Mecha Error" :

The disc player is malfunctioning.

- ☞ Eject the disc and try inserting it again. Contact the Kenwood dealer if this indicator continues blinking or the disc cannot be ejected.

"Disc Error" :

An unplayable disc is inserted.

"Read Error" :

Disc is quite dirty.

- ☞ Clean the disc, referring to the section on <Handling discs> (page 4).

Disc is upside down.

- ☞ Load the disc with the labeled side up.

"Region code Error" :

The disc you wanted to play has a region code that cannot be played with this unit.

"Parental level Error" :

The disc you wanted to play has a higher level than the parental level you set.

"Error 07-67" :

The unit is not operating correctly due to some reason or other.

- ☞ Push the unit's Reset button. If the "Error 07-67" message does not disappear, see your nearest Kenwood dealer.

"No Device" (USB device):

The USB device is selected as a source although no USB device is connected.

- ☞ Change the source to any source other than USB/iPod. Connect an USB device, and change the source to USB again.

"Disconnected" (iPod, Bluetooth audio player):

The iPod/Bluetooth audio player is selected as a source although no iPod/Bluetooth audio player is connected.

- ☞ Change the source to any source other than iPod/Bluetooth. Connect an iPod/Bluetooth audio player, and change the source to iPod/Bluetooth again.

"No Music" :

The connected USB device contains no playable audio file.

Media was played that doesn't have data recorded that the unit can play.

"USB Device Error!!" :

The connected USB device is rated a current capacity higher than the allowable limit.

- ☞ Check the USB device.

Some trouble may have occurred to the connected USB device.

- ☞ Change the source to any source other than USB. Remove the USB device.

Help? Error

"Authorization Error" :

- Connection to the iPod has failed.
- ➔ Remove the iPod and then reconnect it. The unit does not support the iPod.
 - ➔ Refer to <iPod/iPhone that can be connected to this unit> (page 7).

"Update your iPod" :

- The iPod's software is an older version which the unit can not support.
- ➔ Confirm that the software for the iPod is the latest version. Refer to <iPod/iPhone that can be connected to this unit> (page 7).

"You only can connect one iPod." :

- More than one iPod are connected to this unit.
- ➔ Connect only one iPod to the USB terminal with iPod tag.

"Update your USB database" :

- The USB device is different from the previous one or the contained audio files are replaced.
- ➔ Update your database. Refer to <Source Control Screen> (page 26) of USB Device Control.

"Navigation Error. Please turn on power again later." (DNX series only) :

- The communication error has occurred due to severely cold temperature.
- ➔ Turn on power again after warming your car interior.

"No Navigation" (DDX series only):

- This unit does not support the connected navigation unit.
- ➔ The latest information on the connectable navigation unit can be obtained from <http://www.kenwood.com/cs/ce>.

No navigation unit is connected.

 - ➔ Connect a supported navigation unit.

"CHECK SIRIUS" :

- The unit cannot recognize the connected SIRIUS Tuner Box.
- ➔ Check the connection of the SIRIUS Tuner Box.

"ANTENNA ERROR" :

- Something is wrong with the antenna.
- ➔ Check the connection of the antenna.

"ACQUIRING SIGNAL" :

- The unit cannot receive any signal.
- ➔ Move the vehicle to the area where the unit can receive signal.

"FIRMWARE UPDATING" :

- Updating the firmware of SIRIUS tuner.
- ➔ Operation is invalid until the update is completed.

"CHANNELS UPDATING **% COMPLETE" :

- Updating the SIRIUS Channel Map.
- ➔ Operation is invalid until the update is completed.

"SUBSCRIPTION UPDATED" :

- Updating the subscription information.
- ➔ Operation is invalid until the update is completed.

"INVALID CHANNEL" :

- The selected channel is invalid.
- ➔ Select a different channel.

"CALL 888-539-SIRIUS TO SUBSCRIBE" :

- The selected channel is not subscribed.
- ➔ Call the displayed number for subscription.

"Check XM Tuner" :

- The unit cannot recognize the connected XM Tuner.
- ➔ Check the connection of the XM Tuner.

"No Signal" :

- The unit cannot receive any signal.
- ➔ Check the connection of the antenna.

"Check Antenna" :

- Something is wrong with the antenna.
- ➔ Check the connection of the antenna.

"Ch Unavailable" :

- The selected channel is invalid.
- ➔ Select a different channel.

"Ch Unauthorized" :

- The selected channel is not subscribed.

"Channel Off Air" :

- The broadcast of the selected channel has finished.

Specifications

Monitor section

- Picture Size**
: 6.95 inches (diagonal) wide
: 156.6 mm (W) x 81.6 mm (H)
- Display System**
: Transparent TN LCD panel
- Drive System**
: TFT active matrix system
- Number of Pixels**
: 1,152,000 (800H x 480V x RGB)
- Effective Pixels**
: 99.99 %
- Pixel Arrangement**
: RGB striped arrangement
- Back Lighting**
: LED

DVD player section

- D/A Converter**
: 24 bit
- Audio Decoder**
: Linear PCM/ Dolby Digital/ dts/ MP3/ WMA/ AAC
- Video Decoder**
: MPEG1/ MPEG2
: DivX (DNX9/ DDX8 series)
- Wow & Flutter**
: Below Measurable Limit
- Frequency Response**
DNX9/ DDX8 series
Sampling frequency;
96 kHz : 20 – 22,000 Hz
48 kHz : 20 – 22,000 Hz
44.1 kHz : 20 – 20,000 Hz
DNX7 series
Sampling frequency;
96 kHz : 20 – 20,000 Hz
48 kHz : 20 – 20,000 Hz
44.1 kHz : 20 – 20,000 Hz
- Total Harmonic Distortion**
: 0.008 % (1 kHz)
- S/N Ratio (dB)**
: 98 dB (DVD-Video 96 kHz)
- Dynamic Range**
: 98 dB (DVD-Video 96 kHz)

- Disc Format**
: DVD-Video/ VIDEO-CD/ CD-DA
- Sampling Frequency**
: 44.1/ 48/ 96 kHz
- Quantifying Bit Number**
: 16/ 20/ 24 bit

USB interface section

- USB Standard**
: USB 2.0 High speed
iPod: USB 1.1 Full speed (DNX9/ DDX8 series only)
- File System**
: FAT 16/ 32
- Maximum Power Supply Current**
: 500 mA
- D/A Converter**
: 24 Bit
- Video Decoder**
: MPEG1/ MPEG2/ MPEG4/ H.264/ WMV
- Audio Decoder**
: MP3/ WMA/ AAC/ WAV (Linear PCM)

Bluetooth section

- Technology**
: Bluetooth Ver.2.1 + EDR Certified
- Frequency**
: 2.402 – 2.480 GHz
- Output Power**
: +4dBm (MAX), 0dBm (AVE), Power Class2
- Maximum Communication range**
: Line of sight approx. 10m (32.8 ft)
- Profile**
HFP (Hands Free Profile),
SPP (Serial Port Profile),
HSP (Headset Profile),
OPP (Object Push Profile),
PBAP (Phonebook Access Profile),
SYNC (Synchronization Profile),
A2DP (Advanced Audio Distribution Profile),
AVRCP (Audio/Video Remote Control Profile)

Specifications

FM tuner section

Frequency Range

200 kHz : 87.9 MHz – 107.9 MHz (DNX9960/
DNX7160/ DNX7020EX/ DDX896)
50 kHz : 87.5 MHz – 108.0 MHz (DDX8046BT)

Usable Sensitivity (S/N : 30 dB)

: 9.3 dBf (0.8 μ V/ 75 Ω)

Quieting Sensitivity (S/N : 50 dB)

: 15.2 dBf (1.6 μ V/ 75 Ω)

Frequency Response (\pm 3.0 dB)

: 30 Hz – 15 kHz

S/N Ratio (dB)

: 70 dB (MONO)

Selectivity (\pm 400 kHz)

: \geq 80 dB

Stereo Separation

: 35 dB (1 kHz)

AM tuner section

Frequency Range (10 kHz)

: 530 kHz – 1700 kHz

Usable Sensitivity

: 28 dB μ

Video section

Color System of External Video Input

: NTSC

External Video Input Level (mini jack)

: 1 Vp-p/ 75 Ω

External Audio Max Input Level (mini jack)

: 2 V/ 25 k Ω

Video Output Level (RCA jacks)

: 1 Vp-p/ 75 Ω

Audio Output Level (RCA jacks)

: 1.2 V/ 10 k Ω

Analog RGB input (DDX series only)

: 0.7 Vp-p/ 75 Ω

Audio section

Maximum Power (Front & Rear)

: 50 W x 4

Full Bandwidth Power (Front & Rear)

(4 Ω , 14.4 V, 1 % THD)

: 22 W x 4

Preout Level (V)

: 5 V/ 10 k Ω (DNX9/ DDX8 series)

: 2 V/ 10 k Ω (DNX7 series)

Preout Impedance

: 80 Ω (DNX9/ DDX8 series)

: \leq 600 Ω (DNX7 series)

Speaker Impedance

: 4 – 8 Ω

DSP Section

Graphics equalizer

DNX9/ DDX8 series

Band: 13 Band

Frequency (BAND1 – 13)

: 62.5/ 100/ 160/ 250/ 400/ 630/ 1k/ 1.6k/

2.5k/ 4k/ 6.3k/ 10k/ 16k Hz

Channel: Front/ Rear/ Center

DNX7/ DDX7 series

Band: 5 Band

Frequency (BAND1 – 5)

: 62.5/ 250/ 1k/ 4k/ 16k Hz

Gain

: -9/ -8/ -7/ -6/ -5/ -4/ -3/ -2/ -1/ 0/ 1/ 2/ 3/ 4/

5/ 6/ 7/ 8/ 9 dB

X'over

High pass filter

Frequency: Through, 30/ 40/ 50/ 60/ 70/ 80/

90/ 100/ 120/ 150/ 180/ 220/

250 Hz

Slope: -6/ -12/ -18/ -24 dB

Low pass filter

Frequency: 30/ 40/ 50/ 60/ 70/ 80/ 90/ 100/

120/ 150/ 180/ 220/ 250 Hz,

Through

Slope: -6/ -12/ -18/ -24 dB

Time alignment

Front/ Rear/ Subwoofer

: 0 – 20.01 ft (0.07 ft Step)

Center: 0 – 11.15 ft (0.07 ft Step) (DNX9/

DDX8 series)

Position

: 0 – 5.68 ft (0.07 ft Step)

Channel Level (DNX9/ DDX8 series)

: \pm 10 dB

Navigation section (DNX series only)

Receiver

: High-sensitivity GPS receiver

Reception Frequency

: 1575.42 MHz (C/A code)

Acquisition Times

Cold : < 38 seconds

Factory Reset : < 45 seconds

(On average for a stationary receiver with a clear view of the sky)

Accuracy

Position : < 10 meters typical

Velocity : 0.05 m/sec. RMS

Position Method

: GPS

Antenna

: External GPS antenna

External SW

Maximum Power Supply Current

: 500 mA

General

Operating voltage

: 14.4 V (10.5 – 16 V allowable)

Maximum Current Consumption

: 15 A

Dimensions (W x H x D)

: 181.7 x 100.0 x 180 mm

7-3/16 x 3-15/16 x 7-1/8 inch

Operational Temperature Range

: -10 $^{\circ}$ C – +60 $^{\circ}$ C

Storage Temperature Range

: -20 $^{\circ}$ C – +85 $^{\circ}$ C

Weight

DNX9 series : 2.54 kg (5.6 lbs)

DNX7 series : 2.50 kg (5.5 lbs)

DDX series : 2.48 kg (5.5 lbs)

Although the effective pixels for the liquid crystal panel is given as 99.99% or more, 0.01% of pixels may not light or may light incorrectly.

Specifications subject to change without notice.

The Bluetooth word mark and logos are owned by the Bluetooth SIG, Inc. and any use of such marks by Kenwood Corporation is under license. Other trademarks and trade names are those of their respective owners.

The "AAC" logo is a trademark of Dolby Laboratories.

iPod is a trademark of Apple Inc., registered in the U.S. and other countries.

iPhone is a trademark of Apple Inc.

iTunes is a trademark of Apple Inc.

"Made for iPod" means that an electronic accessory has been designed to connect specifically to iPod and has been certified by the developer to meet Apple performance standards.

"Works with iPhone" means that an electronic accessory has been designed to connect specifically to iPhone and has been certified by the developer to meet Apple performance standards.

Apple is not responsible for the operation of this device or its compliance with safety and regulatory standards.

DVD is a trademark of DVD Format/Logo Licensing Corporation registered in the U.S., Japan and other countries.

This product incorporates copyright protection technology that is protected by U.S. patents and other intellectual property rights. Use of this copyright protection technology must be authorized by Macrovision, and is intended for home and other limited viewing uses only unless otherwise authorized by Macrovision. Reverse engineering or disassembly is prohibited.

HD Radio™ and the HD Radio Ready logo are proprietary trademarks of iBiquity Digital Corporation.

DNX9960/ DDX896/ DDX8046BT:

ABOUT DIVX VIDEO:

DivX® is a digital video format created by DivX, Inc. This is an official DivX Certified device that plays DivX video. Visit www.divx.com for more information and software tools to convert your files into DivX video.

ABOUT DIVX VIDEO-ON-DEMAND:

This DivX Certified® device must be registered in order to play DivX Video-on-Demand (VOD) content. To generate the registration code, locate the DivX VOD section in the device setup menu. Go to vod.divx.com with this code to complete the registration process and learn more about DivX VOD.

DivX®, DivX Certified® and associated logos are registered trademarks of DivX, Inc. and are used under license.

SFS is a trademark of SRS Labs, Inc. WOW technology is incorporated under license from SRS Labs, Inc.

Manufactured under license from Dolby Laboratories. Dolby, Pro Logic and the double-D symbol are trademarks of Dolby Laboratories.

Manufactured under license under U.S. Patent #'s: 5,451,942; 5,956,674; 5,974,380; 5,978,762; 6,487,535 & other U.S. and worldwide patents issued & pending. DTS and the Symbol are registered trademarks & DTS Digital Surround and the DTS logos are trademarks of DTS, Inc. Product includes software. © DTS, Inc. All Rights Reserved.

DNX7160/ DNX7020EX:

Manufactured under license from Dolby Laboratories. Dolby and the double-D symbol are trademarks of Dolby Laboratories.

Manufactured under license under U.S. Patent #'s: 5,451,942; 5,956,674; 5,974,380; 5,978,762; 6,487,535 & other U.S. and worldwide patents issued & pending. DTS and the Symbol are registered trademarks & DTS 2.0 Channel and the DTS logos are trademarks of DTS, Inc. Product includes software. © DTS, Inc. All Rights Reserved.

FCC WARNING

This equipment may generate or use radio frequency energy. Changes or modifications to this equipment may cause harmful interference unless the modifications are expressly approved in the instruction manual. The user could lose the authority to operate this equipment if an unauthorized change or modification is made.

NOTE

This equipment has been tested and found to comply with the limits for a Class B digital device, pursuant to Part 15 of the FCC Rules. These limits are designed to provide reasonable protection against harmful interference in a residential installation. This equipment may cause harmful interference to radio communications, if it is not installed and used in accordance with the instructions. However, there is no guarantee that interference will not occur in a particular installation. If this equipment does cause harmful interference to radio or television reception, which can be determined by turning the equipment off and on, the user is encouraged to try to correct the interference by one or more of the following measures:

- Reorient or relocate the receiving antenna.
- Increase the separation between the equipment and receiver.
- Connect the equipment into an outlet on a circuit different from that to which the receiver is connected.
- Consult the dealer or an experienced radio/TV technician for help.

DNX9960/ DNX7160/ DNX7020EX/ DDX896:

IC (Industry Canada) Notice

Operation is subject to the following two conditions:

- (1) This device may not cause interference, and
- (2) this device must accept any interference, including interference that may cause undesired operation of the device.

The term "IC: " before the certification/ registration number only signifies that the Industry Canada technical specification were met.

This product contains a CR Coin Cell Lithium Battery which contains Perchlorate Material – special handling may apply. See www.dtsc.ca.gov/hazardouswaste/perchlorate

DNX9960/ DNX7160/ DNX7020EX/ DDX896:

CAUTION

Use of controls or adjustments or performance of procedures other than those specified herein may result in hazardous radiation exposure. In compliance with Federal Regulations, following are reproductions of labels on, or inside the product relating to laser product safety.

Kenwood Corporation
2967-3, ISHIKAWA-MACHI,
HACHIOJI-SHI
TOKYO, JAPAN

KENWOOD CORP. CERTIFIES THIS EQUIPMENT
CONFORMS TO DHHS REGULATIONS NO.21 CFR
1040.10, CHAPTER 1, SUBCHAPTER J.

Location : Bottom Panel

DDX8046BT:

The marking of products using lasers

**CLASS 1
LASER PRODUCT**

The label is attached to the chassis/case and says that the component uses laser beams that have been classified as Class 1. It means that the unit is utilizing laser beams that are of a weaker class. There is no danger of hazardous radiation outside the unit.

The term "IC: " before the certification/ registration number only signifies that the Industry Canada technical specification were met.

This product contains a CR Coin Cell Lithium Battery which contains Perchlorate Material – special handling may apply. See www.dtsc.ca.gov/hazardouswaste/perchlorate



This symbol mark indicates that Kenwood manufactured this product so as to decrease harmful influence on the environment.

KENWOOD