

TEST REPORT

APPLICANT : Kenwood Corporation

ADDRESS : 2967-3 Ishikawa-machi, Hachioji-shi, Tokyo, 192-8525, Japan

PRODUCTS : GPS NAVIGATION SYSTEM

MODEL No. : DNX7160

SERIAL No. : --

FCC ID : IOM39622B
IC : 282C-39622B

TEST STANDARD : CFR 47 FCC Rules and Regulations Part 15 Subpart A, B and C
: Industry Canada RSS-210(Issue 7) and RSS-Gen(Issue 2)

TESTING LOCATION : Japan Quality Assurance Organization
SAFETY & EMC CENTER
EMC Engineering Department Testing Division
1-21-25, Kinuta, Setagaya-ku, Tokyo 157-8573, Japan

TEST RESULTS : Passed

DATE OF TEST : December 26, 2009 - January 18, 2010

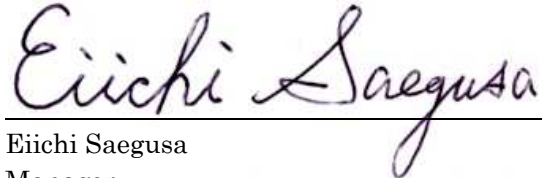

Eiichi Saegusa

Manager

Japan Quality Assurance Organization

SAFETY & EMC CENTER

EMC Engineering Dept. Testing Division

1-21-25, Kinuta, Setagaya-ku, Tokyo 157-8573, Japan

-
- The measurement values stated in Test Report was made with traceable to National Institute of Advanced Industrial Science and Technology (AIST) of Japan and National Institute of Information and Communications Technology (NICT) of Japan.
 - The applicable standard, testing condition and testing method which were used for the tests are based on the request of the applicant.
 - The test results presented in this report relate only to the offered test sample.
 - The contents of this test report cannot be used for the purposes, such as advertisement for consumers.
 - This test report shall not be reproduced except in full without the written approval of JQA.

Table of Contents

Documentation	Page
1 Test Regulation	3
2 Test Location	3
3 Recognition of Test Laboratory	3
4 Description of the Equipment Under Test	4
5 Test Condition	5-12
6 Preliminary Test and Test Setup	13-21
7 Equipment Under Test Modification	22
8 Responsible Party	22
9 Deviation from Standard	22
10 Test Results	23-29
11 Summary	30
12 Operating Condition	31
13 Test Configuration	32
14 Equipment Under Test Arrangement (Drawings)	33
Appendix A : Test Data	34-71
A.1 Channel Separation	
A.2 Minimum Hopping Channel	
A.3 Occupied Bandwidth	
A.4 Dwell Time	
A.5 Peak Output Power (Conduction)	
A.6 Peak Output Power (Radiation)	
A.7 Peak Power Density (Conduction)	
A.8 Peak Power Density (Radiation)	
A.9 Spurious Emissions (Conduction)	
A.10 Spurious Emissions for Transmitter (Radiation)	
A.11 AC Power Line Conducted Emissions for Transmitter	
A.12 RF Exposure Compliance	
A.13 Spurious Emissions for Receiver (Radiation)	
A.14 AC Power Line Conducted Emissions for Receiver	

Appendix B : Test Arrangement (Photographs)	72-74
--	--------------

Appendix C : Test Instruments	75-77
--------------------------------------	--------------

Definitions for Abbreviation and Symbols Used In This Test Report

- “EUT” means Equipment Under the Test.
- “AE” means Associated Equipment.
- “N/A” means that Not Applicable.
- “N/T” means that Not Tested.

- indicates that the listed condition, standard or equipment is applicable for this report.
- indicates that the listed condition, standard or equipment is not applicable for this report.

Documentation**1 Test Regulation**

Applied Standard : CFR 47 FCC Rules and Regulations Part 15 Subpart A, B and C
Industry Canada RSS-210(Issue 7) and RSS-Gen(Issue 2)

Test Procedure : The tests were performed with reference to the FCC Public Notice DA 00-705, released March 30, 2000. The test set-up was made in accordance to the general provisions of ANSI C63.4-2003.

2 Test Location

Japan Quality Assurance Organization
SAFETY & EMC CENTER
EMC Engineering Department Testing Division
1-21-25, Kinuta, Setagaya-ku, Tokyo 157-8573, Japan

3 Recognition of Test Laboratory

Japan Quality Assurance Organization
SAFETY & EMC CENTER
EMC Engineering Department Testing Division

is accredited under ISO/IEC 17025 by following accreditation bodies and the test facility of Testing Division is registered by the following bodies .

VLAC Code : VLAC-001-1 (Effective through : April 3, 2010)

NVLAP Lab Code : 200189-0 (Effective through : June 30, 2010)

VCCI Registration Number : R-002, R-003, C-002, C-966 (Effective through : April 3, 2010)

FCC Registration Number : 349652 (Date of Listing : April 1, 2010)

IC Registration Number : 2079-7, 2079-8 (Effective through : August 29, 2011)

Accredited as conformity assessment body for Japan electrical appliances and material law by METI. (Effective through : February 22, 2010)

4 Description of the Equipment Under Test

1	Manufacturer	: Kenwood Corporation 2967-3 Ishikawa-machi, Hachioji-shi, Tokyo, 192-8525, Japan
2	Products	: GPS NAVIGATION SYSTEM
3	Trade Name	: KENWOOD
4	Model No.	: DNX7160
5	Serial No.	: --
6	FCC ID	: IOM39622B
7	IC	: 282C-39622B
8	Product Type	: Pre-Production
9	Date of Manufacture	: December 2009
10	Power Rating	: 12.0VDC
11	EUT Grounding	: None
12	Category	: Transceiver(Spread Spectrum Transmitter(FHSS))
13	Modulation Type	: Bluetooth 2.0 + EDR (GFSK, $\pi/4$ DQPSK, 8DPSK)
14	Received Date of EUT	: December 18, 2009
15	EUT Authorization	: Certification
16	Fundamental Frequency Generated/used in the EUT	: 32.768 kHz, 4.3320 MHz, 10.250 MHz, 11.0592 MHz, 11.2896 MHz, 12.00 MHz, 14.31818 MHz, 15.6672 MHz, 16.368 MHz, 26.0 MHz and 27.0000 MHz
17	Operating Frequency Range	: 2402 MHz - 2480 MHz
18	EUT Highest Frequency Used/Generated	: 2480 MHz
19	RF Output Power	: 0.81 dBm(measured value)
20	Antenna Type	: Film Antenna (Integral Internal antenna : not accessible to the user)
21	Antenna Gain	: -1.9 dBi
22	Similar Model	: DNX7020EX(*1)

Note : The difference point between the EUT(Model No.: DNX7160) and the similar model(Model No.: DNX7020) is only the difference in the color of the panel of the enclosure.

5 Test Condition**5.1 Channel Separation**

The requirements are -Applicable -Tested -Not tested by applicant request.]
-Not Applicable

Test site & instruments :

Type	Number of test site & instruments (Refer to Appendix C)
Test Site	3
Test Receiver	13
Spectrum Analyzer	--
Antenna	--
Cable	48
Attenuator	80
Thermo-Hygrometer	202

5.2 Minimum Hopping Channel

The requirements are -Applicable -Tested -Not tested by applicant request.]
-Not Applicable

Test site & instruments :

Type	Number of test site & instruments (Refer to Appendix C)
Test Site	3
Test Receiver	13
Spectrum Analyzer	--
Antenna	--
Cable	48
Attenuator	80
Thermo-Hygrometer	202

5.3 Occupied Bandwidth

The requirements are -Applicable -Tested -Not tested by applicant request.]
-Not Applicable

Test site & instruments :

Type	Number of test site & instruments (Refer to Appendix C)
Test Site	3
Test Receiver	13
Spectrum Analyzer	--
Antenna	--
Cable	48
Attenuator	80
Thermo-Hygrometer	202

5.4 Dwell Time

The requirements are -Applicable -Tested -Not tested by applicant request.]
-Not Applicable

Test site & instruments :

Type	Number of test site & instruments (Refer to Appendix C)
Test Site	3
Test Receiver	13
Spectrum Analyzer	--
Antenna	--
Cable	48
Attenuator	80
Thermo-Hygrometer	202

5.5 Peak Output Power (Conduction)

The requirements are -Applicable -Tested -Not tested by applicant request.]
-Not Applicable

Test site & instruments :

Type	Number of test site & instruments (Refer to Appendix C)
Test Site	3
Test Receiver	13
Spectrum Analyzer	--
Cable	48
Attenuator	--
Power Meter	210
Power Sensor	212
Signal Generator	--
Thermo-Hygrometer	202

5.6 Peak Output Power (Radiation)

The requirements are -Applicable -Tested -Not tested by applicant request.]
-Not Applicable

Test site & instruments :

Type	Number of test site & instruments (Refer to Appendix C)
Test Site	--
Test Receiver	--
Spectrum Analyzer	--
Antenna	--
Cable	--
Attenuator	--
Power Meter	--
Power Sensor	--
Signal Generator	--
Thermo-Hygrometer	--

5.7 Peak Power Density (Conduction)

The requirements are -Applicable -Tested -Not tested by applicant request.]
-Not Applicable

Test site & instruments :

Type	Number of test site & instruments (Refer to Appendix C)
Test Site	3
Test Receiver	13
Spectrum Analyzer	--
Cable	48
Attenuator	80
Thermo-Hygrometer	202

5.8 Peak Power Density (Radiation)

The requirements are -Applicable -Tested -Not tested by applicant request.]
-Not Applicable

Test site & instruments :

Type	Number of test site & instruments (Refer to Appendix C)
Test Site	--
Test Receiver	--
Spectrum Analyzer	--
Antenna	--
Cable	--
Attenuator	--
Digitizing Oscilloscope	--
RF Detector	--
Signal Generator	--
Thermo-Hygrometer	--

5.9 Spurious Emission (Conduction)

The requirements are -Applicable -Tested -Not tested by applicant request.]
-Not Applicable

Test site & instruments :

Type	Number of test site & instruments (Refer to Appendix C)
Test Site	3
Test Receiver	13
Spectrum Analyzer	--
Cable	48
Attenuator	80
Thermo-Hygrometer	202

5.10 Spurious Emissions for Transmitter (Radiation)

The requirements are -Applicable -Tested -Not tested by applicant request.]
-Not Applicable

Test site & instruments : (for 9 kHz – 30 MHz)

Type	Number of test site & instruments (Refer to Appendix C)
Test Site	1
Test Receiver	13
Spectrum Analyzer	--
Antenna	21
Cable	43
Thermo-Hygrometer	204

Test site & instruments : (for 30 MHz – 1000 MHz)

Type	Number of test site & instruments (Refer to Appendix C)
Test Site	1
Test Receiver	13
Spectrum Analyzer	--
Antenna	167 168
Cable	38
Thermo-Hygrometer	204

Test site & instruments : (for above 1 GHz)

Type	Number of test site & instruments (Refer to Appendix C)
Test Site	1
Test Receiver	13
Spectrum Analyzer	--
Antenna	31 32
Cable	48 49 195
RF Amplifier	57
Band Reject Filter	78
High Pass Filter	79
Thermo-Hygrometer	204

5.11 AC Power Line Conducted Emissions for Transmitter

The requirements are -Applicable -Tested -Not tested by applicant request.]
-Not Applicable

Test site & instruments :

Type	Number of test site & instruments (Refer to Appendix C)
Test Site	--
Test Receiver	--
Spectrum Analyzer	--
Cable	--
AMN(for EUT)	--
AMN(for Peripheral)	--
Termination	--
Thermo-Hygrometer	--

5.12 RF Exposure Compliance

The requirements are -Applicable -Tested -Not tested by applicant request.]
-Not Applicable

Test site & instruments :

Type	Number of test site & instruments (Refer to Appendix C)
--	--

5.13 Spurious Emissions for Receiver (Radiation)

The requirements are -Applicable -Tested -Not tested by applicant request.]
-Not Applicable

Test site & instruments : (for 9 kHz – 30 MHz)

Type	Number of test site & instruments (Refer to Appendix C)		
Test Site	1		
Test Receiver	13		
Spectrum Analyzer	--		
Antenna	21		
Cable	43		
Thermo-Hygrometer	204		

Test site & instruments : (for 30 MHz – 1000 MHz)

Type	Number of test site & instruments (Refer to Appendix C)		
Test Site	1		
Test Receiver	13		
Spectrum Analyzer	--		
Antenna	167	168	
Cable	38		
Thermo-Hygrometer	204		

Test site & instruments : (for above 1 GHz)

Type	Number of test site & instruments (Refer to Appendix C)		
Test Site	1		
Test Receiver	13		
Spectrum Analyzer	--		
Antenna	31	32	
Cable	48	49	195
RF Amplifier	57		
Band Reject Filter	--		
High Pass Filter	--		
Thermo-Hygrometer	204		

5.14 AC Power Line Conducted Emissions for Receiver

The requirements are -Applicable [-Tested -Not tested by applicant request.]
-Not Applicable

Test site & instruments :

Type	Number of test site & instruments (Refer to Appendix C)
Test Site	--
Test Receiver	--
Spectrum Analyzer	--
Cable	--
AMN(for EUT)	--
AMN(for Peripheral)	--
Termination	--
Thermo-Hygrometer	--

COPY

6 Preliminary Test and Test Setup

6.1 Channel Separation

The EUT have its hopping function enabled.

Use the following spectrum analyzer settings:

Span = wide enough to capture the peaks of two adjacent channels

Resolution (or IF) Bandwidth (RBW) \geq 1% of the span

Video (or Average) Bandwidth (VBW) \geq RBW

Sweep = auto

Detector function = peak

Trace = max hold

Allow the trace to stabilize. Use the marker-delta function to determine the separation between the peaks of the adjacent channels.

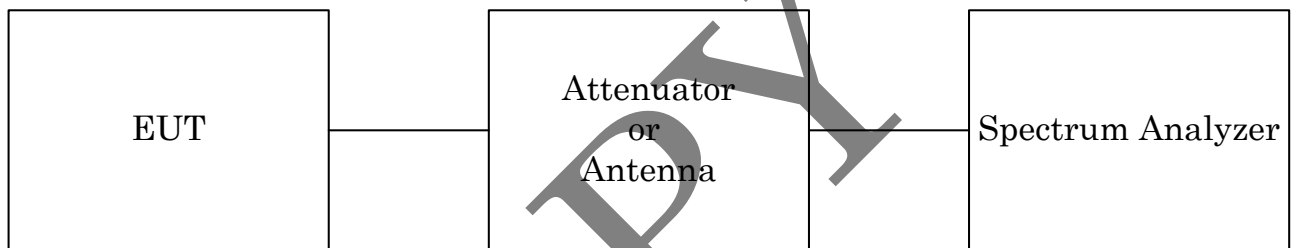

6.2 Minimum Hopping Channel

The EUT have its hopping function enabled.

Use the following spectrum analyzer settings:

Span = the frequency band of operation

RBW \geq 1% of the span

VBW \geq RBW

Sweep = auto

Detector function = peak

Trace = max hold

Allow the trace to stabilize. It may prove necessary to break the span up to sections, in order to clearly show all of the hopping frequencies.

Measurement setup is same as sub-clause 6.1.

6.3 Occupied Bandwidth

Use the following spectrum analyzer settings:

Span = approximately 2 to 3 times the 6 dB or 20 dB bandwidth, centered on a channel

RBW \geq 1% of the 6 dB or 20 dB bandwidth

VBW \geq RBW

Sweep = auto

Detector function = peak

Trace = max hold

The EUT should be transmitting at its maximum data rate. Allow the trace to stabilize. Use the marker-to-peak function to set the marker to the peak of the emission. Use the marker-delta function to measure 6 dB or 20 dB down one side of the emission. Reset the marker-delta function, and move the marker to the other side of the emission, until it is (as close as possible to) even with the reference marker level. The marker-delta reading at this point is the 6 dB or 20 dB bandwidth of the emission. If this value varies with different modes of operation (e.g., data rate, modulation format, etc.), repeat this test for each variation.

Measurement setup is same as sub-clause 6.1.

6.4 Dwell Time

The EUT must have its hopping function enabled.

Use the following spectrum analyzer settings:

Span = zero span, centered on a hopping channel

RBW \leq Channel Separation

VBW \geq RBW

Sweep = as necessary to capture the entire dwell time per hopping channel

Detector function = peak

Trace = max hold

If possible, use the marker-delta function to determine the dwell time. If this value varies with different modes of operation (e.g., data rate, modulation format, etc.), repeat this test for each variation.

Measurement setup is same as sub-clause 6.1.

6.5 Peak Output Power (Conduction)

In case of conducted measurements, the transmitter shall be connected to the measuring equipment via a suitable attenuator.

The measurement shall be performed using normal operation of the equipment with the test modulation applied.

It is measured the Peak Power Analyzer, that have had the RBW greater than 6 dB bandwidth of the emission.

The test procedure shall be as follows;

- using a suitable means, the output of the transmitter shall be connected to the peak power analyzer;
- the peak power analyzer is made into a suitable condition for the measurement;
- The observed value shall be recorded;

The measurement shall be repeated at the lowest, the middle, and the highest frequency of the stated frequency range.



6.6 Peak Power Density (Conduction)

Use the following spectrum analyzer settings:

Span = approximately 5 times the 20 dB bandwidth, centered on a channel

RBW = Specified Value

VBW \geq RBW

Sweep = auto

Detector function = peak

Trace = max hold

Allow the trace to stabilize. Use the marker-to-peak function to set the marker to the peak of the emission.

Measurement setup is same as sub-clause 6.1.

6.7 Peak Output Power and Peak Power Density (Radiation)

The radiated power output and the field strength of the transmitter radiation were measured at the distance at 3 meters away from the transmitter under test which was placed on a turntable 0.8 meter in height. The receiving antenna was oriented for vertical polarization and raised or lowered through 1 to 4 meters until the maximum signal level was detected on the measuring instrument. The transmitter under test was rotated through 360° until the maximum signal was received. The measurement was repeated with the receiving antenna in the horizontal polarization.

The transmitter was removed and replaced with the antenna. The center of the antenna was placed approximately at the same location as the center of the transmitter. The antenna was fed with a signal generator, and the output level of the signal generator was adjusted to obtain the previously recorded maximum reading at the particular frequency and recorded. This procedure was repeated with the receiving antenna and the antenna in the orthogonal polarization.

The input power into the antenna was measured using the power meter. The level of the emissions in dBm(EIRP) were calculated from the following formula:

$$\text{Transmitter Power[dBm]}(\text{EIRP}) = (\text{Meter Reading of Power Meter}) + (\text{Antenna Gain[dBi]})$$

Use the following spectrum analyzer settings:

Span = approximately 5 times the 20 dB bandwidth, centered on a channel

RBW : Greater than the 20 dB bandwidth of the emission being measured or Specified Value

VBW ≥ RBW

Sweep = auto

Detector function = peak

Trace = max hold

Allow the trace to stabilize. Use the marker-to-peak function to set the marker to the peak of the emission.

6.8 Spurious Emission (Conduction)

Band-edge Compliance of RF Conducted Emissions

Use the following spectrum analyzer settings:

Span = wide enough to capture the peak level of the emission operating on the channel closest to the band edge, as well as any modulation products which fall outside of the authorized band of operation

RBW \geq 1% of the span

VBW \geq RBW

Sweep = auto

Detector function = peak

Trace = max hold

Allow the trace to stabilize. Set the marker on the emission at the band edge, or on the highest modulation product outside of the band, if this level is greater than that at the band edge. Enable the marker-delta function, then use the marker-to-peak function to move the marker to the peak of the in-band emission.

Now, using the same instrument settings, enable the hopping function of the EUT. Allow the trace to stabilize. Follow the same procedure listed above to determine if any spurious emissions caused by the hopping function also comply with the specified limit.

Spurious RF Conducted Emissions

Use the following spectrum analyzer settings:

Span = wide enough to capture the peak level of the in-band emission and all spurious emissions (e.g., harmonics) from the lowest frequency generated in the EUT up through the 10th harmonic. Typically, several plots are required to cover this entire span.

RBW = 100 kHz

VBW \geq RBW

Sweep = auto

Detector function = peak

Trace = max hold

Allow the trace to stabilize. Set the marker on the peak of any spurious emission recorded. The level displayed must comply with the limit specified in this Section.

Measurement setup is same as sub-clause 6.1.

6.9 Spurious Emissions (Radiation)

6.9.1 Radiated Emission (9 kHz – 30 MHz)

According to description of ANSI C63.4-2003 sec.13.1.4, the preliminary radiated emissions measurement were carried out. The preliminary radiated measurements were performed at the measurement distance that specified for compliance to determine the emission characteristics of the EUT.

The EUT configuration, cable configuration and mode of operation were determined for producing the maximum level of emissions. These configurations were used for the final radiated emissions measurements.

- Side View -

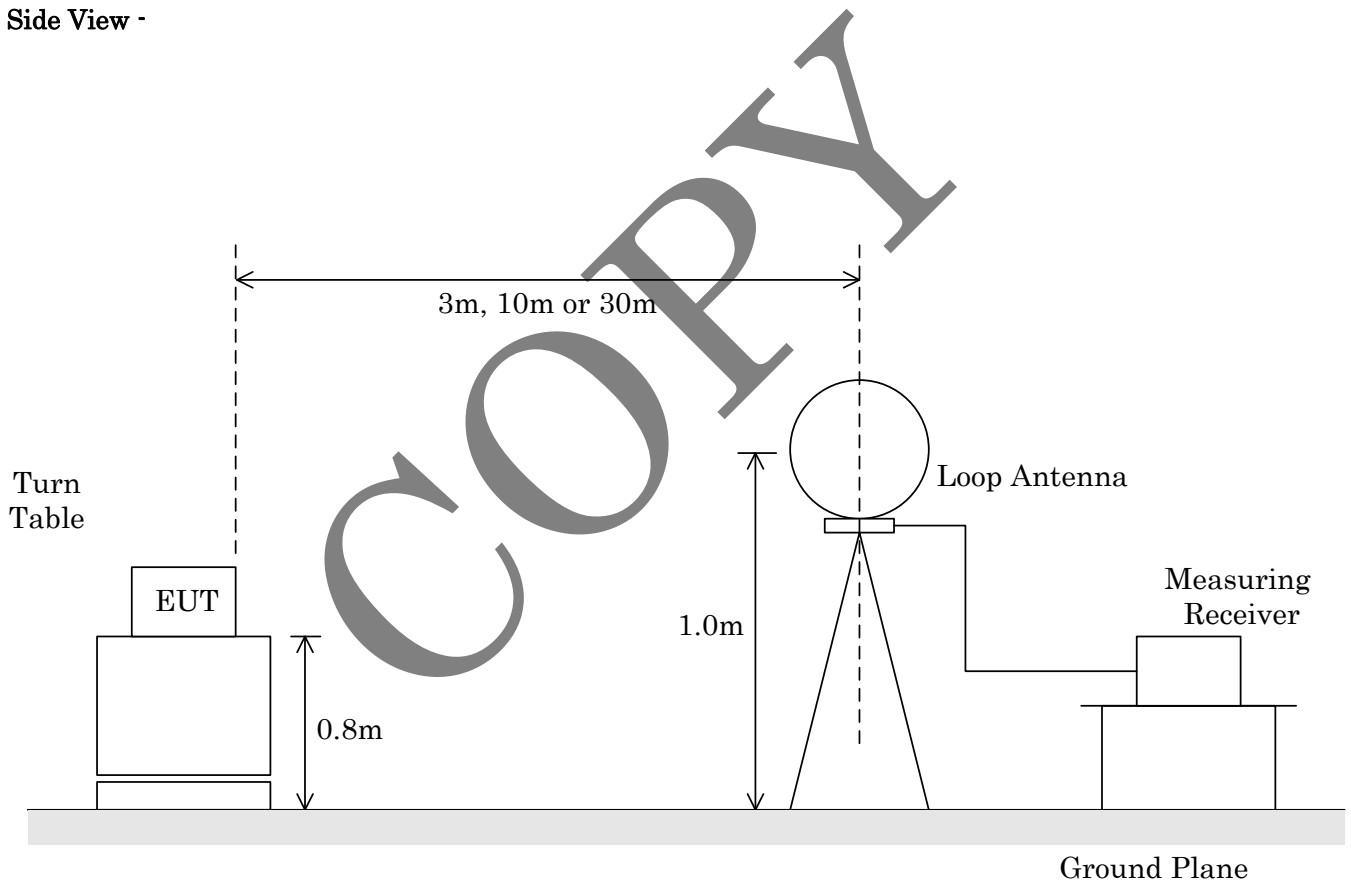

6.9.2 Radiated Emission (30 MHz – 1000 MHz)

According to description of ANSI C63.4-2003 sec.13.1.4, the preliminary radiated emissions measurement were carried out. The preliminary radiated measurements were performed at the measurement distance that specified for compliance to determine the emission characteristics of the EUT.

The EUT configuration (in X, Y and Z axis), cable configuration and mode of operation were determined for producing the maximum level of emissions. These configurations were used for the final radiated emissions measurements.

- Side View -

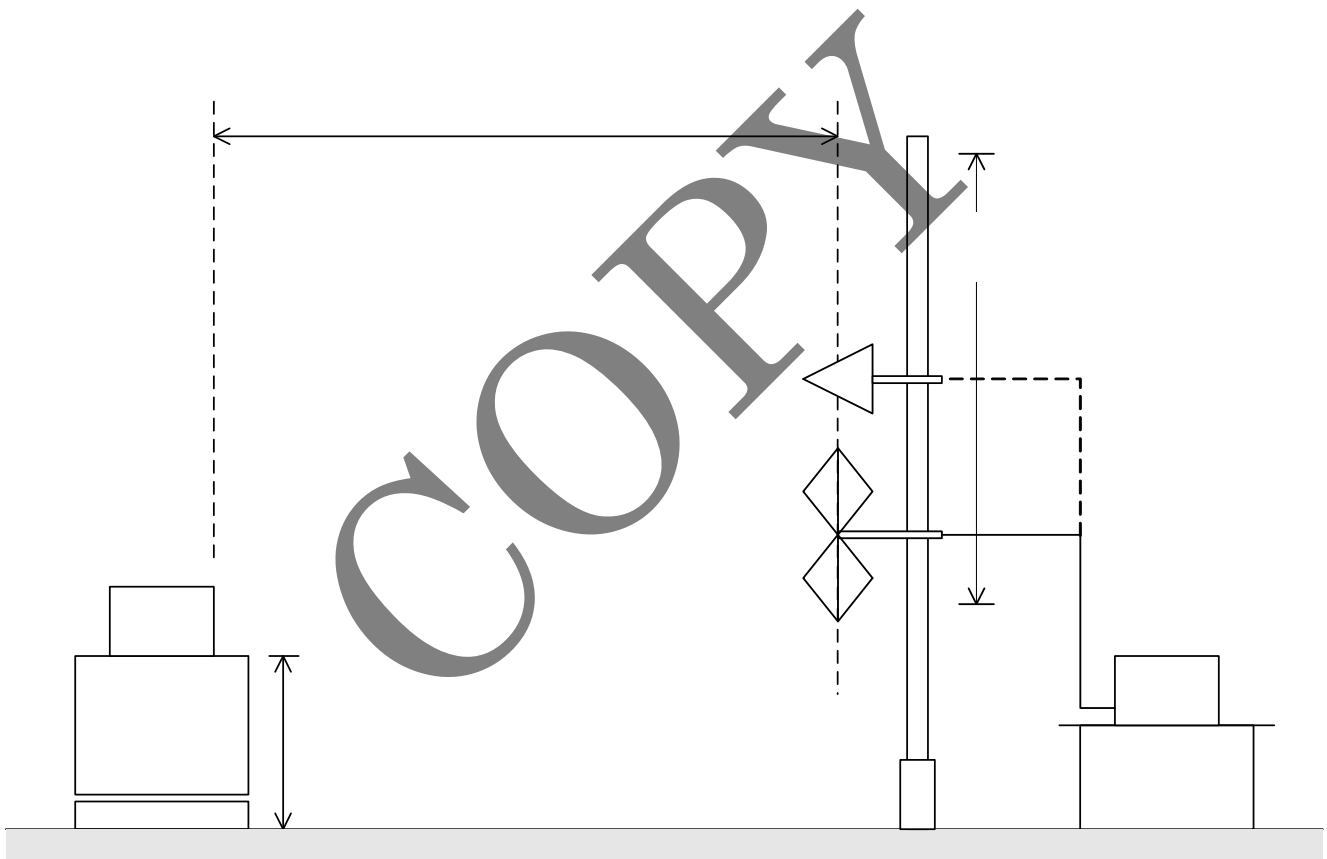

6.9.3 Radiated Emission (above 1 GHz)

According to description of ANSI C63.4-2003 sec.13.1.4, the preliminary radiated emissions measurement were carried out. The preliminary radiated measurements were performed at the measurement distance that specified for compliance to determine the emission characteristics of the EUT.

The EUT configuration (in X, Y and Z axis), cable configuration and mode of operation were determined for producing the maximum level of emissions. These configurations were used for the final radiated emissions measurements.

- Side View -

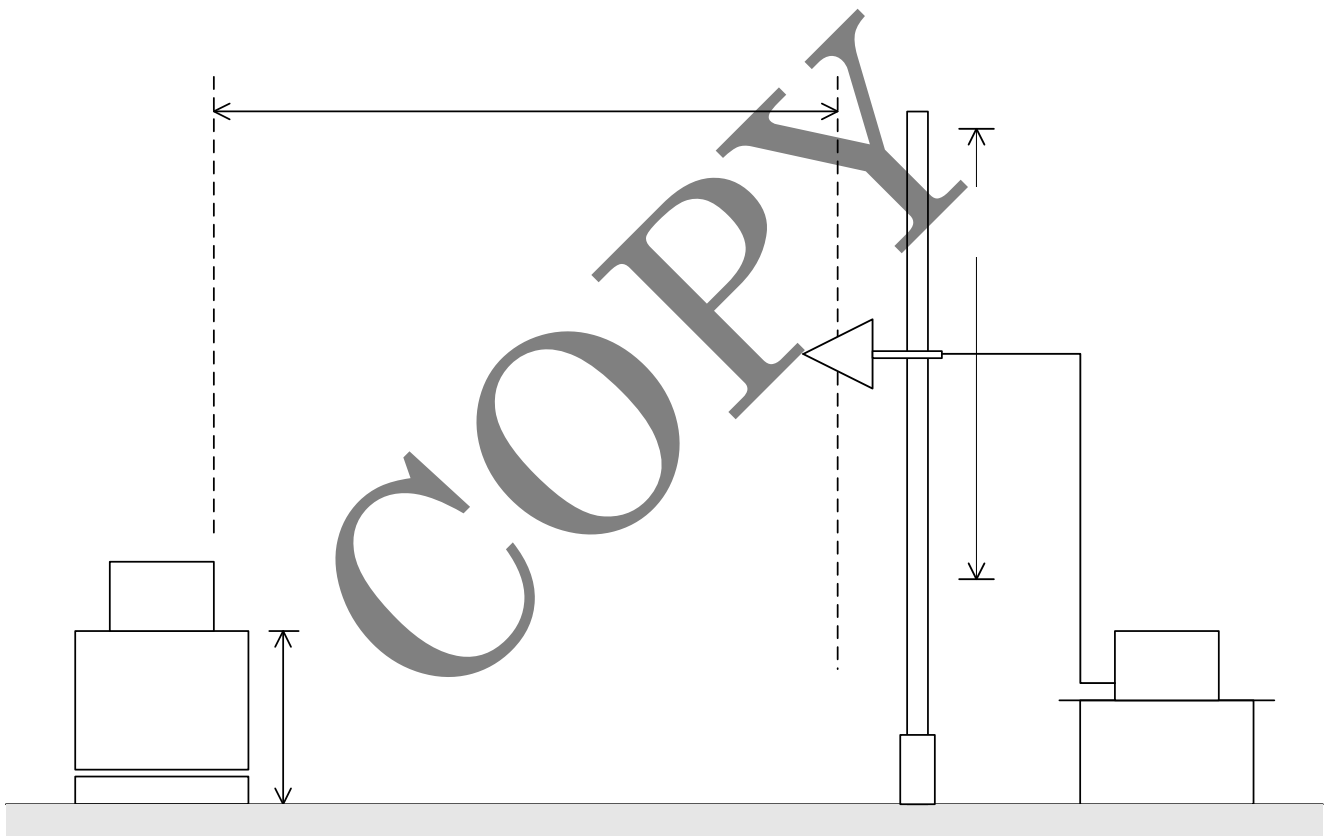

6.10 AC Power Line Conducted Emissions (150 kHz – 30 MHz)

According to description of ANSI C63.4-2003 sec.13.1.3, the AC power line preliminary conducted emissions measurements were carried out.

The preliminary conducted measurements were performed using the spectrum analyzer to observe the emission characteristics of the EUT.

The EUT configuration, cable configuration and mode of operation were determined for producing the maximum level of emissions. These configurations were used for final AC power line conducted emissions measurements.

- Side View -

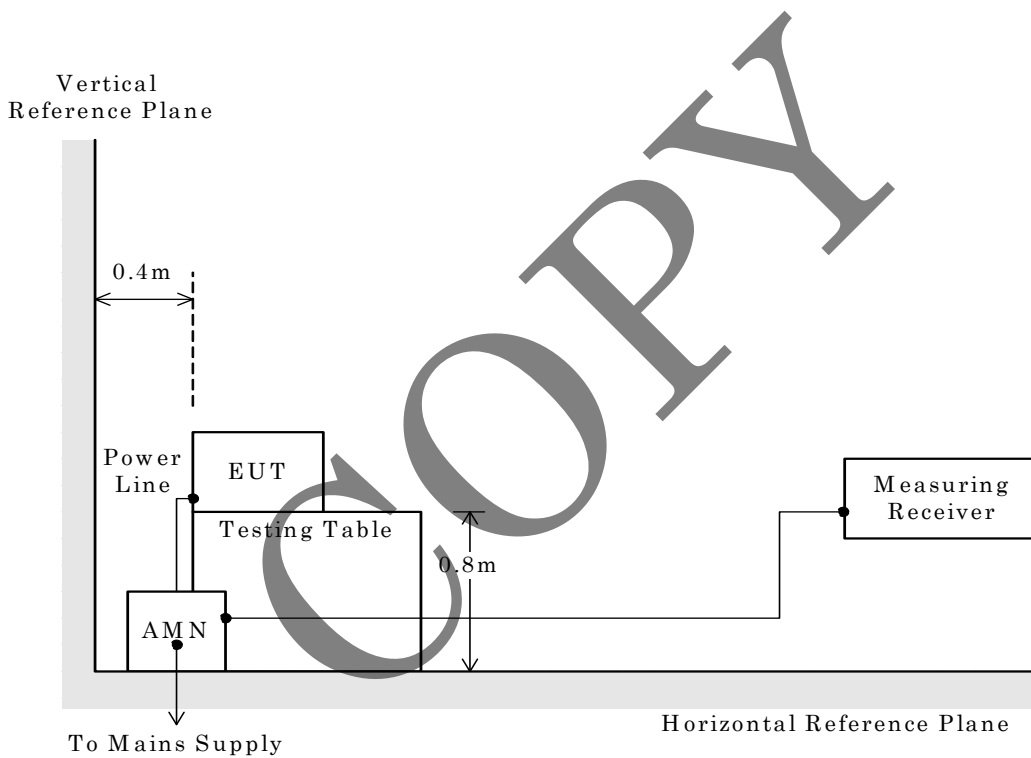

* AMN : Artificial Mains Network

5.11 RF Exposure Compliance

According to description of FCC/OET Bulletin 65 Supplement C (2001), the measurement of SAR were carried out.

7 Equipment Under Test Modification

- No modifications were conducted by JQA to achieve compliance to the limitations.
 To achieve compliance to the limitations, the following changes were made by JQA during the compliance test.

The modifications will be implemented in all production models of this equipment.

Applicant : Not Applicable

Date : Not Applicable

Typed Name : Not Applicable

Position : Not Applicable

Signatory : Not Applicable

8 Responsible PartyResponsible Party of Test Item (Product)

Responsible Party :	
Contact Person :	_____
	Signatory

9 Deviation from Standard

- No deviations from the standard described in clause 1.
 The following deviations were employed from the standard described in clause 1.

10 Test Results**10.1 Channel Separation [§15.247(a)(1), RSS-210 A8.1(b)]**

The requirements are -Applicable -Tested -Not tested by applicant request.]
-Not Applicable

-Passed -Failed -Not judged

Uncertainty of measurement results

± 0.9 %(2σ)

Remarks : _____

10.2 Minimum Hopping Channel [§15.247(a)(1)(iii), RSS-210 A8.1(d)]

The requirements are -Applicable -Tested -Not tested by applicant request.]
-Not Applicable

-Passed -Failed -Not judged

Remarks : _____

10.3 Occupied Bandwidth [§15.247(a)(2), RSS-210 A8.2(a)]

The requirements are -Applicable -Tested -Not tested by applicant request.]
-Not Applicable

-Passed -Failed -Not judged

Uncertainty of measurement results

± 0.9 %(2σ)

Remarks : _____

10.4 Dwell Time [§15.247(a)(1)(iii) / (g), RSS-210 A8.1(d)]

The requirements are -Applicable -Tested -Not tested by applicant request.]
-Not Applicable

-Passed -Failed -Not judged

Uncertainty of measurement results

± 0.9 %(2σ)Remarks : _____
_____**10.5 Peak Output Power (Conduction) [§15.247(b)(3), RSS-210 A8.4(4)]**

The requirements are -Applicable -Tested -Not tested by applicant request.]
-Not Applicable

-Passed -Failed -Not judged

Uncertainty of measurement results

0.1-1000	MHz	<u>± 0.6</u>	dB(2σ)
1-18	GHz	<u>± 0.7</u>	dB(2σ)
18-40	GHz	<u>± 1.3</u>	dB(2σ)

Remarks : _____
_____**10.6 Peak Output Power (Radiation) [§15.247(b)(1), RSS-210 A8.4.(2)]**

The requirements are -Applicable -Tested -Not tested by applicant request.]
-Not Applicable

-Passed -Failed -Not judged

Uncertainty of measurement results

30-1000	MHz	<u>± 1.2</u>	dB(2σ)
1-18	GHz	<u>± 2.0</u>	dB(2σ)

Remarks : _____

10.7 Peak Power Density (Conduction) [§15.247(d), RSS-210 A8.2(b)]

The requirements are -Applicable -Tested -Not tested by applicant request.]
-Not Applicable

-Passed -Failed -Not judged

Uncertainty of measurement results

0.1-1000	MHz	<u>± 1.7</u>	dB(2σ)
1-18	GHz	<u>± 1.7</u>	dB(2σ)
18-40	GHz	<u>± 2.1</u>	dB(2σ)

Remarks : _____

10.8 Peak Power Density (Radiation) [§15.247(d), RSS-210 A8.2(b)]

The requirements are -Applicable -Tested -Not tested by applicant request.]
-Not Applicable

-Passed -Failed -Not judged

Uncertainty of measurement results

30-1000	MHz	<u>± 1.2</u>	dB(2σ)
1-18	GHz	<u>± 2.0</u>	dB(2σ)

Remarks : _____

10.9 Spurious Emissions (Conduction) [§15.247(c), RSS-210 A8.5]

The requirements are -Applicable -Tested -Not tested by applicant request.]
-Not Applicable

-Passed -Failed -Not judged

Uncertainty of measurement results

0.1-1000	MHz	<u>± 1.7</u>	dB(2σ)
1-18	GHz	<u>± 1.7</u>	dB(2σ)
18-40	GHz	<u>± 2.1</u>	dB(2σ)

Remarks : _____

10.10 Spurious Emissions for Transmitter (Radiation) [§15.247(c) / §15.35(b) / §15.209(a), RSS-210 A8.5]

The requirements are -Applicable [-Tested -Not tested by applicant request.]
-Not Applicable
-Passed -Failed - Not judged

For the Frequency Range below 1000 MHz

Min. Limit Margin 7.0 dB at 540.00 MHz

Max. Limit Excess -- dB at -- MHz

For the Frequency Range above 1000 MHz

Min. Limit Margin(Average) > 13.7 dB at 7440.00 MHz

Min. Limit Margin(Peak) > 20.7 dB at 7440.00 MHz

Max. Limit Excess -- dB at -- MHz

Uncertainty of measurement results

30-300	MHz	<u>± 4.6</u>	dB(2σ)
300-1000	MHz	<u>± 4.5</u>	dB(2σ)
1-18	GHz	<u>± 5.0</u>	dB(2σ)
18-40	GHz	<u>± 5.3</u>	dB(2σ)

Remarks : _____

10.11 AC Power Line Conducted Emissions for Transmitter [§15.207(a), RSS-Gen 7.2.2]

The requirements are -Applicable -Tested -Not tested by applicant request.]
-Not Applicable

-Passed -Failed - Not judged

Min. Limit Margin (QP) -- dB at -- MHz

Min. Limit Margin (AVE) -- dB at -- MHz

Max. Limit Exceeding (QP) -- dB at -- MHz

Max. Limit Exceeding (AVE) -- dB at -- MHz

Uncertainty of measurement results

 ± 2.9 dB(2σ)

Remarks : The EUT does not have AC power port.

10.12 RF Exposure Compliance [§15.247(b)(5), RSS-Gen 5.5]

The requirements are -Applicable -Tested -Not tested by applicant request.]
-Not Applicable

-Passed -Failed -Not judged

Remarks : _____

10.13 Spurious Emissions for Receiver (Radiation) [§15.109(a), RSS-Gen 6(a)]

The requirements are -Applicable [-Tested -Not tested by applicant request.]
-Not Applicable
-Passed -Failed - Not judged

For the Frequency Range below 1000 MHz

Min. Limit Margin 6.5 dB at 828.00 MHz

Max. Limit Excess -- dB at -- MHz

For the Frequency Range above 1000 MHz

Min. Limit Margin(Average) > 23.7 dB at 2481.50 MHz

Min. Limit Margin(Peak) > 30.7 dB at 2481.50 MHz

Max. Limit Excess -- dB at -- MHz

Uncertainty of measurement results

30-300	MHz	<u>± 4.6</u>	dB(2σ)
300-1000	MHz	<u>± 4.5</u>	dB(2σ)
1-18	GHz	<u>± 5.0</u>	dB(2σ)
18-40	GHz	<u>± 5.3</u>	dB(2σ)

Remarks : _____

10.14 AC Power Line Conducted Emissions for Receiver [15.107(a), RSS-Gen 7.2.2]

The requirements are -Applicable [-Tested -Not tested by applicant request.]
-Not Applicable

-Passed -Failed - Not judged

Min. Limit Margin (QP) -- dB at -- MHz

Min. Limit Margin (AVE) -- dB at -- MHz

Max. Limit Exceeding (QP) -- dB at -- MHz

Max. Limit Exceeding (AVE) -- dB at -- MHz

Uncertainty of measurement results

 ± 2.9 dB(2σ)

Remarks : The EUT does not have AC power port.

11 Summary**General Remarks**

The EUT was tested according to the requirements of CFR 47 FCC Rules and Regulations Part 15 and RSS-210 under the test configuration, as shown in clause 12 to 14.

The conclusion for the test items of which are required by the applied regulation is indicated under the test result.

Test Result :

The "as received" sample;

- fulfill the test requirements of the regulation mentioned on clause 1.
-doesn't fulfill the test requirements of the regulation mentioned on clause 1.

Reviewed by:

Tested by:



Shigeru Osawa
Deputy Manager
SAFETY & EMC CENTER
EMC Engineering Dept. Testing Division

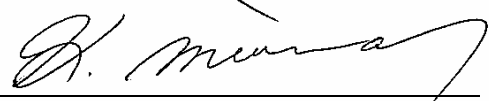

Katsunori Miura
Assistant Manager
SAFETY & EMC CENTER
EMC Engineering Dept. Testing Division

12 Operating Condition

Power Supply Voltage : 12.0 VDC operate with Car Battery
This operational condition is mentioned by applicant.

Operation Mode

The EUT is set with the test mode, the specification of the test mode is as following.

- (1) TX Mode (0ch : 2402MHz)
- (2) TX Mode (39ch : 2441MHz)
- (3) TX Mode (78ch : 2480MHz)
- (4) TX Mode (Hopping)
- (5) RX Mode

Used application to controlled and support equipment :

The operation of the EUT is carried out by directions of a client.

The detail is as following.

Frequency : 2402 MHz, 2441 MHz, 2480 MHz and Hopping

Packet Condition : DH1, DH3, DH5, 2-DH5 and 3-DH5

DH1, DH3, and DH5 : GFSK

2-DH5 : $\pi/4$ DQPSK

3-DH5 : 8DPSK

13 Test Configuration

The equipment under test consists of :

Sign	Item	Manufacturer	Model No.	Serial No.	FCC ID / IC
A	GPS NAVIGATION SYSTEM	Kenwood Corporation	DNX7160	None	IOM39622B / 282C-39622B

The auxiliary equipment used for testing :

Sign	Item	Manufacturer	Model No.	Serial No.	FCC ID / IC
B	GPS Antenna	Kenwood Corporation	--	--	None
C	XM Satellite Radio Interface BOX	Kenwood Corporation	KCA-XM100V	80400099	None
D	Microphone	Kenwood Corporation	--	--	None
E	Remote Controller	Kenwood Corporation	RC-DV340	--	None

Type of Cable:

No.	Description	Identification (Manu. Etc.)	Connector Shielded	Cable Shielded	Ferrite Core	Length (m)
1	GPS Antenna cable	--	No	No	No	1.50
2	XM Satellite Radio Antenna cable	--	Yes	Yes	No	1.50
3	Microphone cable	--	No	No	No	3.00
4	ACC+BATT+Ground cable	--	No	No	No	0.20(*1)
5	PPK cable	--	No	No	No	1.90
6	Reverse cable	--	No	No	No	10.00
7	FM/AM Antenna cable	--	No	No	No	0.20
8	BUS Control cable	--	No	No	No	0.20(*2)
9	AUDIO cable	--	No	No	No	0.20(*3)
10	AV cable	--	No	No	No	0.20(*3)
11	USB cable	--	Yes	Yes	No	1.20
12	Connection cable	--	Yes	Yes	No	3.00

Note : (*1) These cables were connected to the extension cables.

(*2) The cables consist of several cables.

(*3) The cables consist of several cables. And, these cables were connected to the extension cables.

14 Equipment Under Test Arrangement (Drawings)

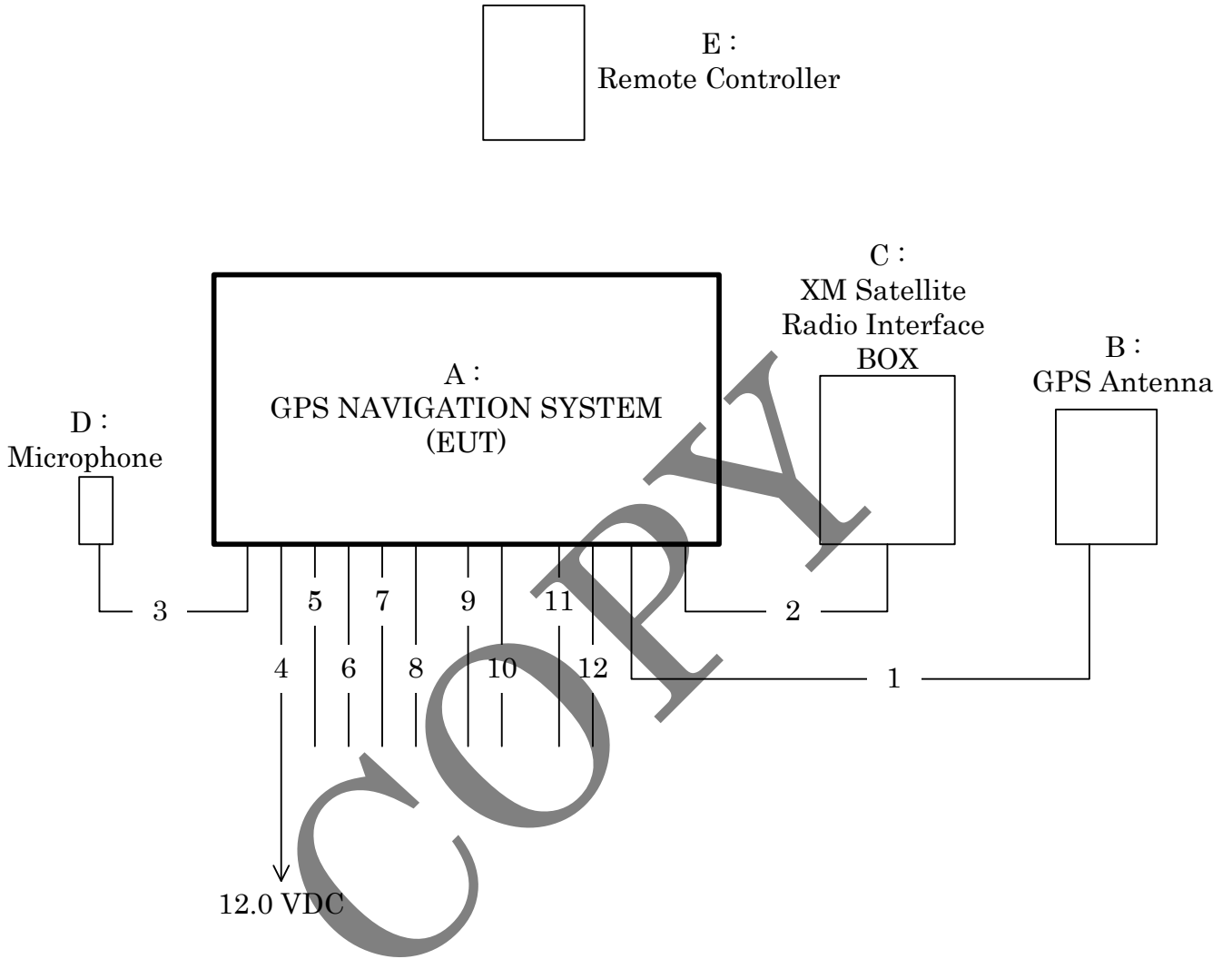

Appendix A : Test Data

A.1 Channel Separation

Date : January 4, 2010
 Temp. : 18 °C Humi. : 45 %

Mode of EUT : TX Mode (Hopping)
 Test Port : Temporary antenna connector

Channel Separation (kHz)	Limit
1004.008	25 kHz or two-thirds of 20 dB bandwidth of hopping channel(*)

Note : (*) It means that there is an alternative limit, in the case of frequency hopping systems operating in the 2400 - 2483.5 MHz band with an output power no greater than 125mW.

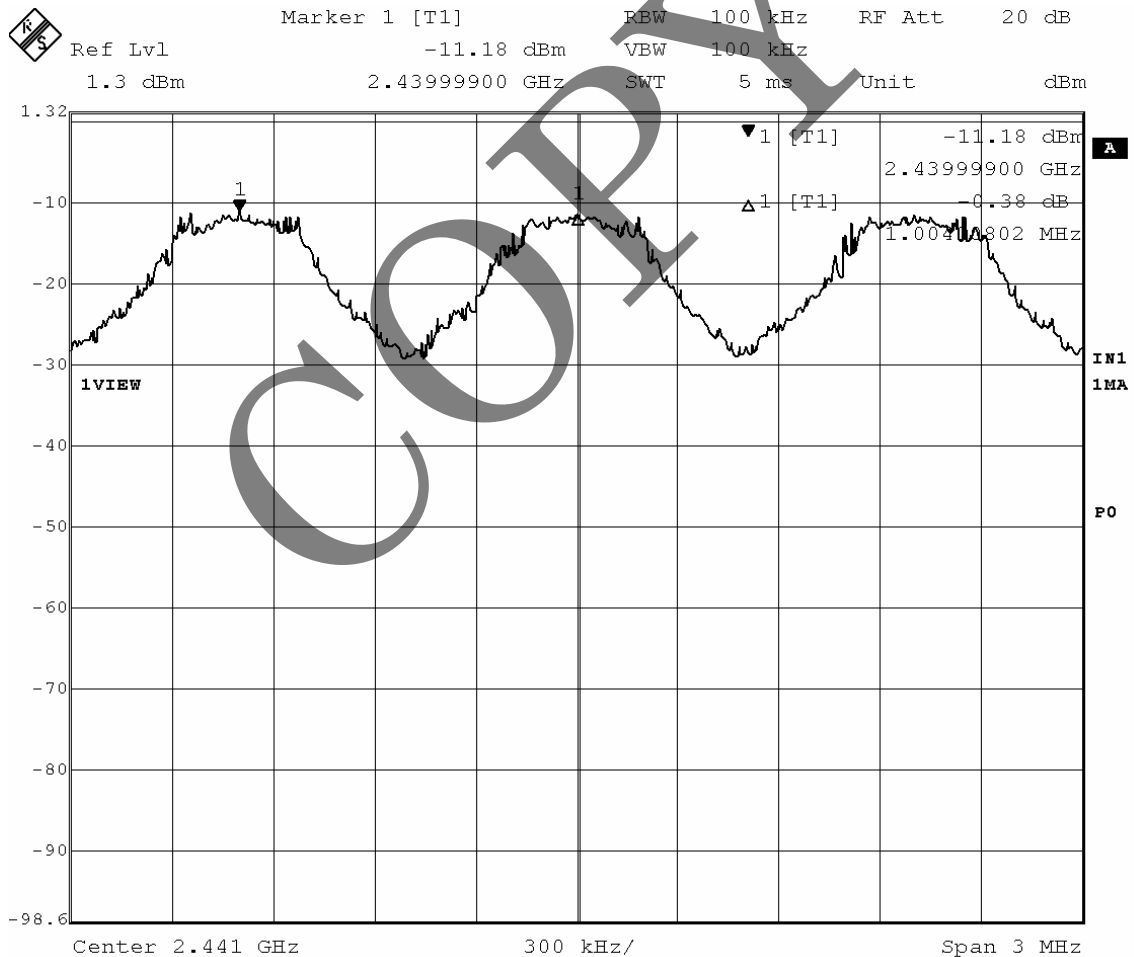

A.2 Minimum Hopping Channel

Date : January 4, 2010
 Temp. : 18 °C Humi. : 45 %

Mode of EUT : TX Mode (Hopping)
 Test Port : Temporary antenna connector

Hopping Channel	Limit
79	15

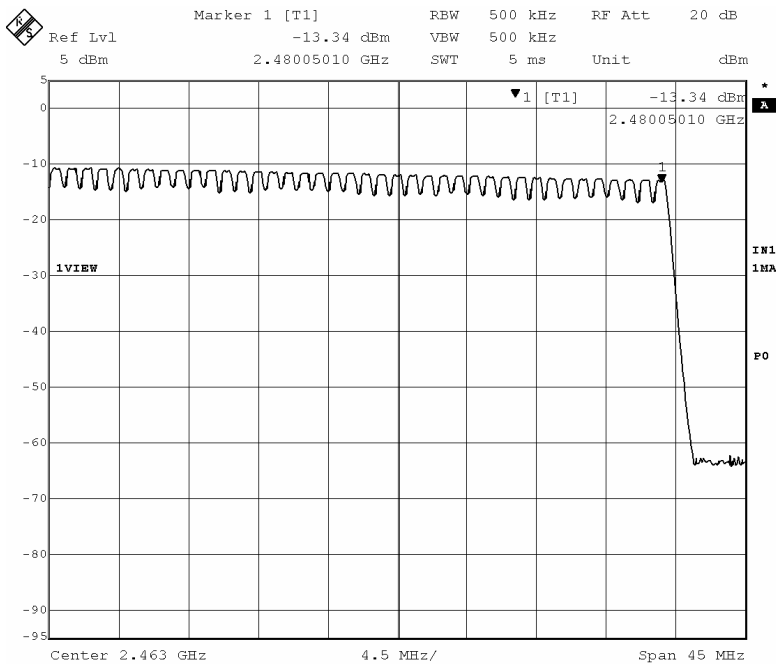
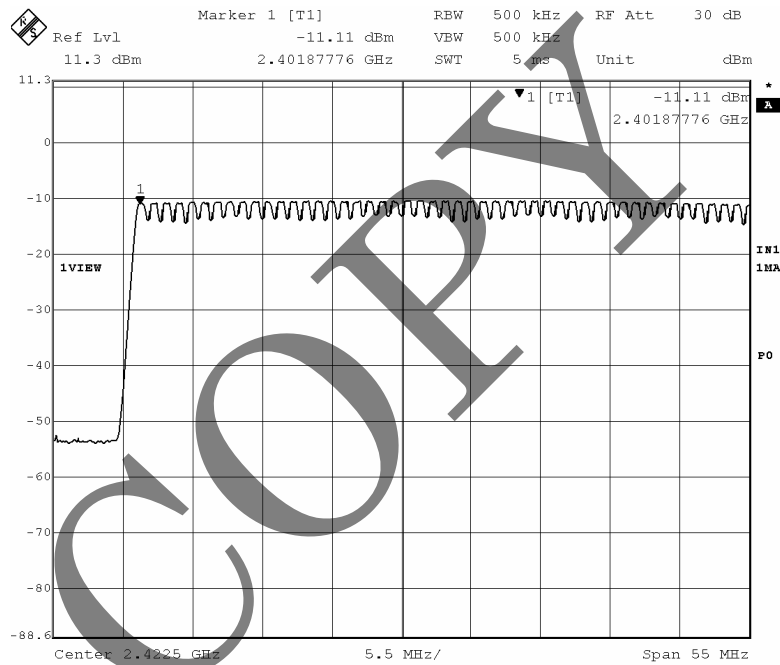

A.3 Occupied Bandwidth

Date : January 4, 2010
 Temp. : 18 °C Humi. : 45 %

A.3.1 Packet Setting : DH5(GFSK)

(1) 20dB Bandwidth

Mode of EUT : TX Mode

Test Port : Temporary antenna connector

Frequency (MHz)	Bandwidth(kHz)	Limit(kHz)
2402	749.49	N/A
2441	749.49	N/A
2480	749.49	N/A

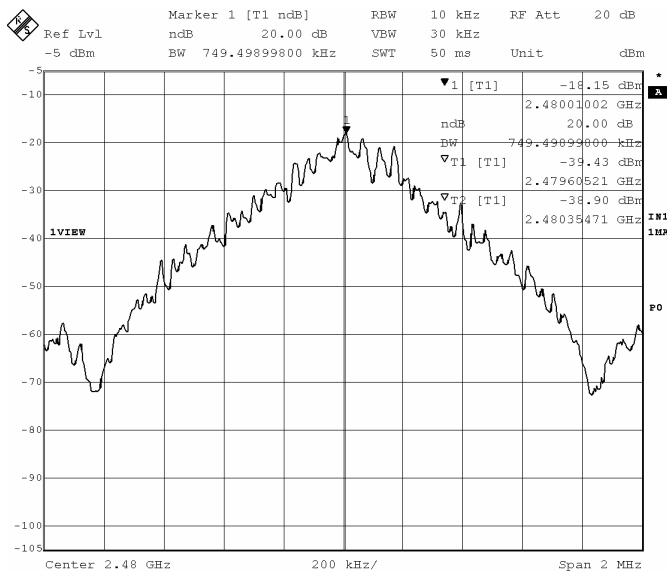
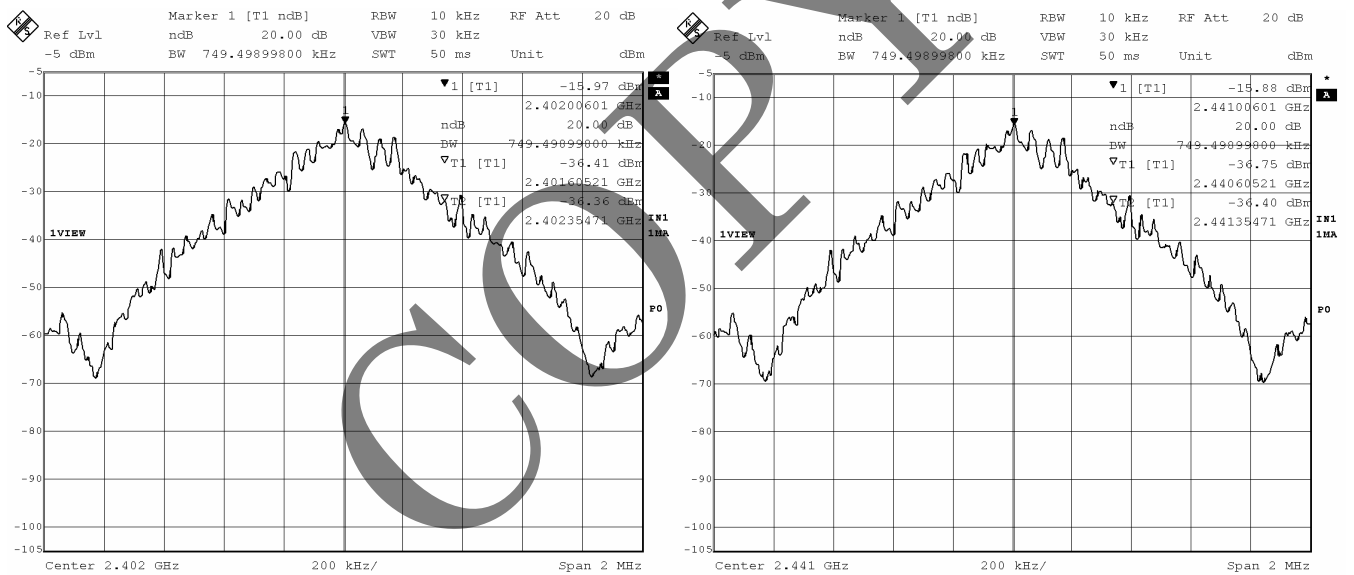

(2) 99% Bandwidth

Mode of EUT : TX Mode

Test Port : Temporary antenna connector

Frequency (MHz)	Bandwidth(kHz)	Limit(kHz)
2402	895.79	N/A
2441	895.79	N/A
2480	889.78	N/A

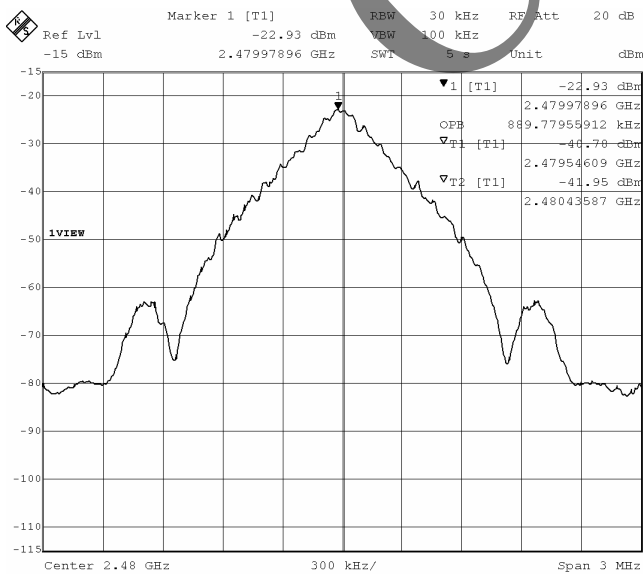
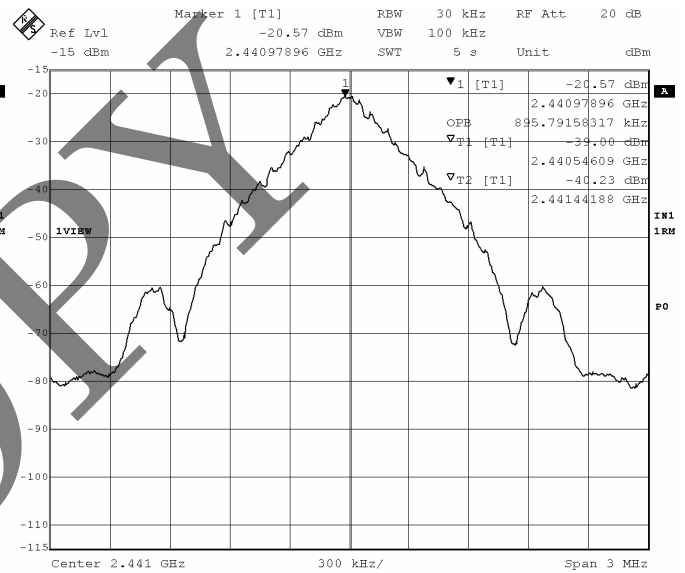
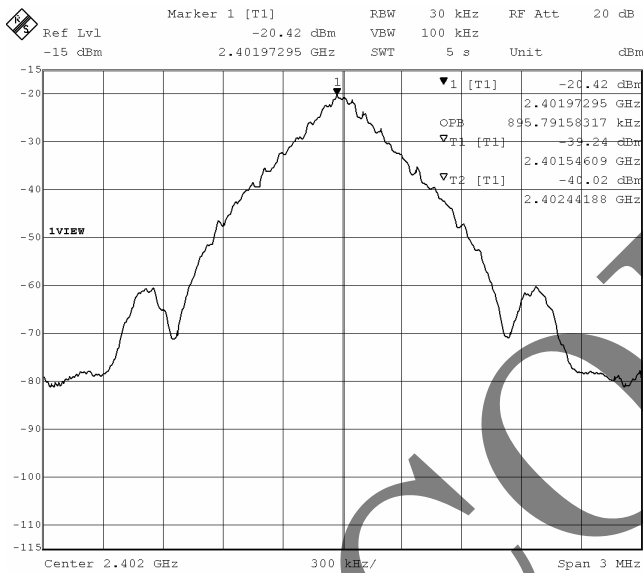

A.3.2 Packet Setting : 2-DH5(π /4DQPSK)

(1) 20dB Bandwidth

Mode of EUT : TX Mode

Test Port : Temporary antenna connector

Frequency (MHz)	Bandwidth(kHz)	Limit(kHz)
2402	1232.46	N/A
2441	1232.46	N/A
2480	1232.46	N/A

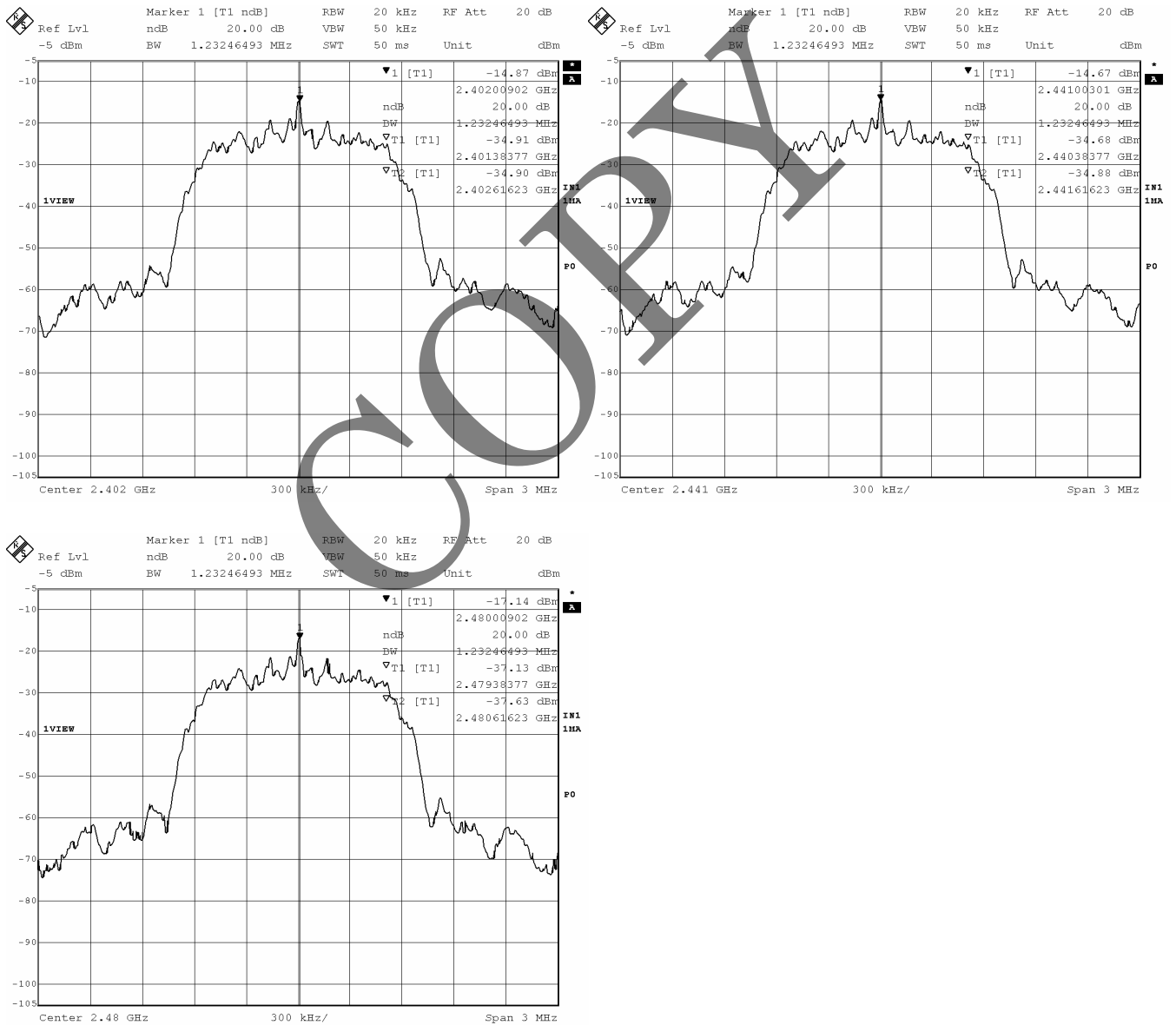

(2) 99% Bandwidth

Mode of EUT : TX Mode

Test Port : Temporary antenna connector

Frequency (MHz)	Bandwidth(kHz)	Limit(kHz)
2402	1208.42	N/A
2441	1202.40	N/A
2480	1196.39	N/A

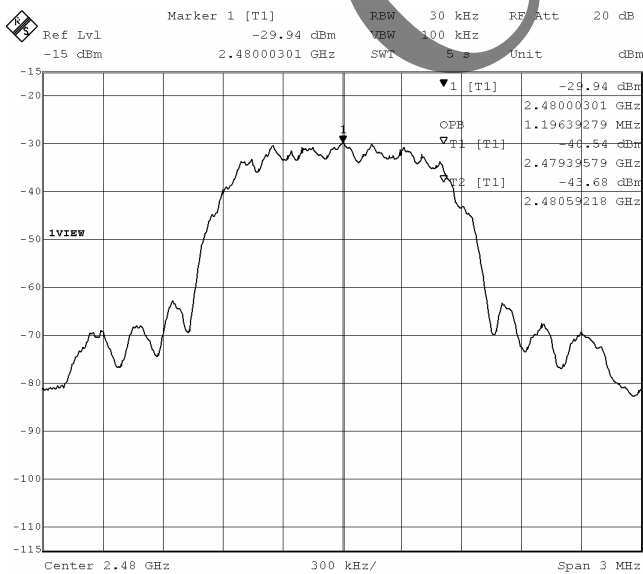
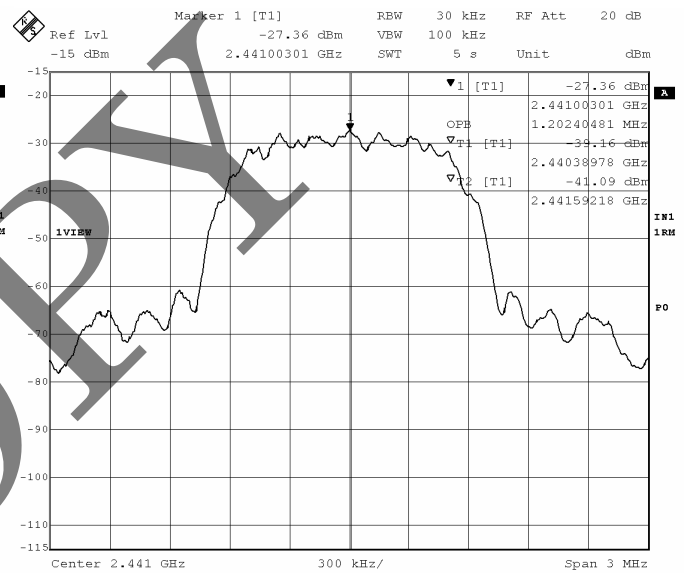
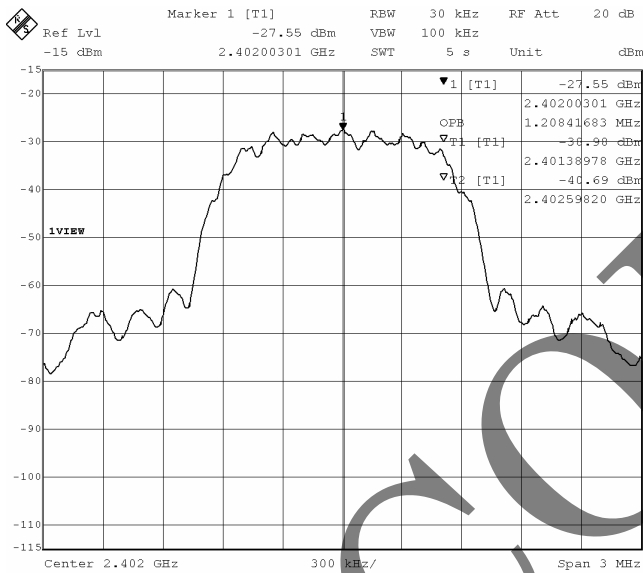

A.3.3 Packet Setting : 3-DH5(8DPSK)

(1) 20dB Bandwidth

Mode of EUT : TX Mode

Test Port : Temporary antenna connector

Frequency (MHz)	Bandwidth(kHz)	Limit(kHz)
2402	1214.43	N/A
2441	1214.43	N/A
2480	1214.43	N/A

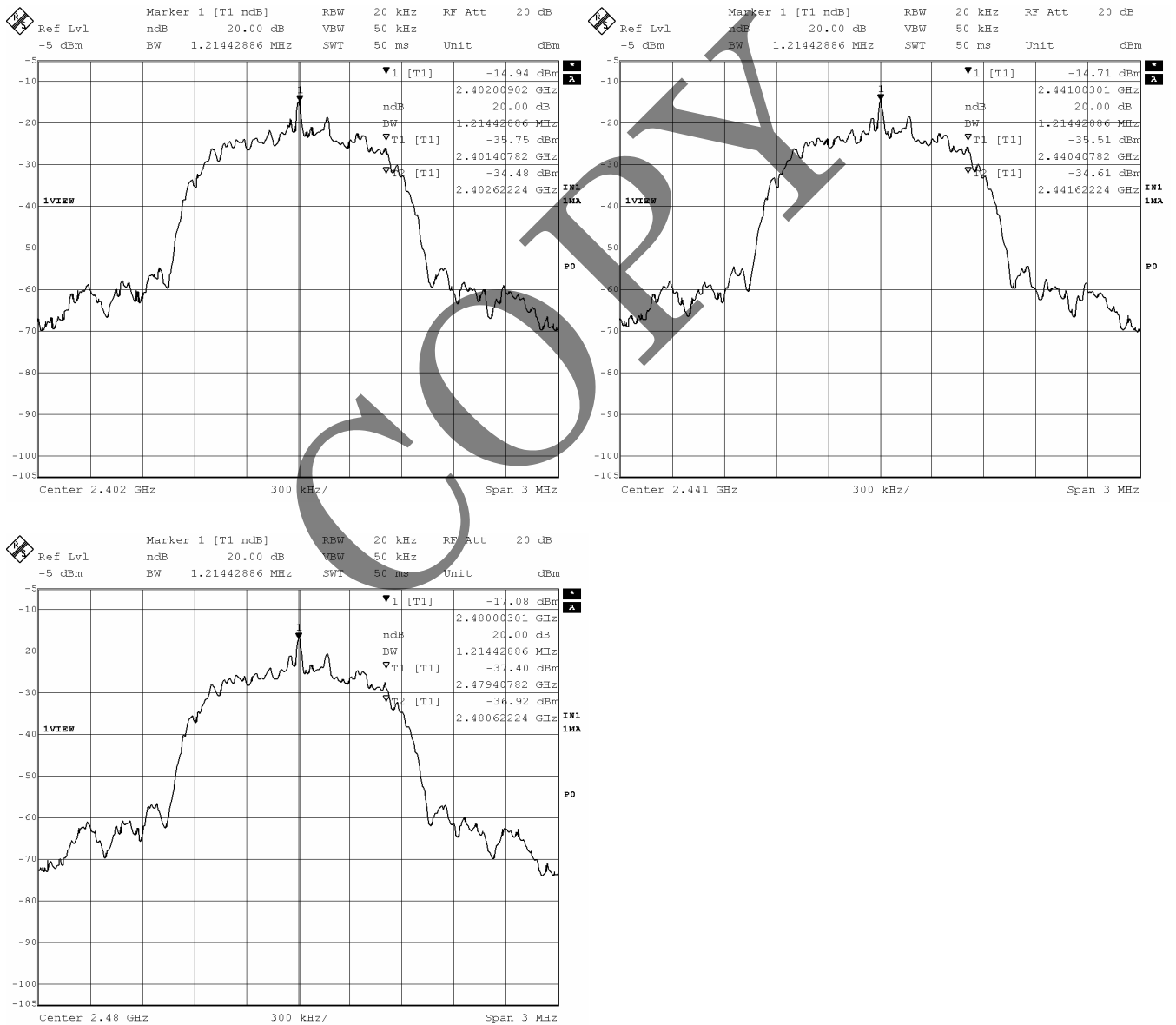

(2) 99% Bandwidth

Mode of EUT : TX Mode

Test Port : Temporary antenna connector

Frequency (MHz)	Bandwidth(kHz)	Limit(kHz)
2402	1214.43	N/A
2441	1208.42	N/A
2480	1208.42	N/A

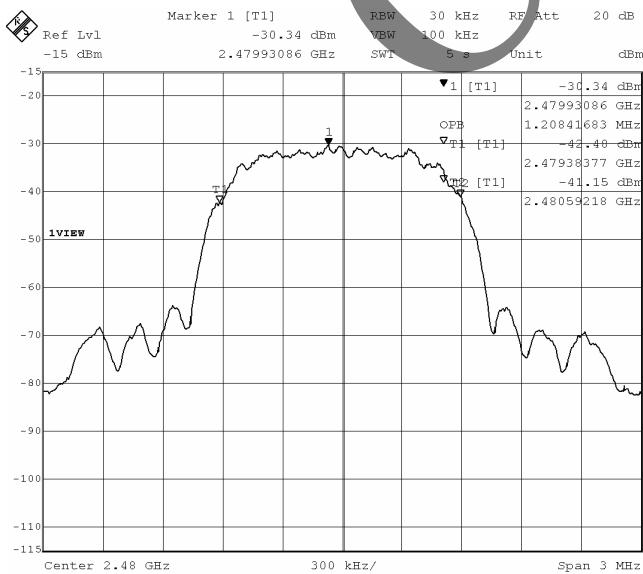
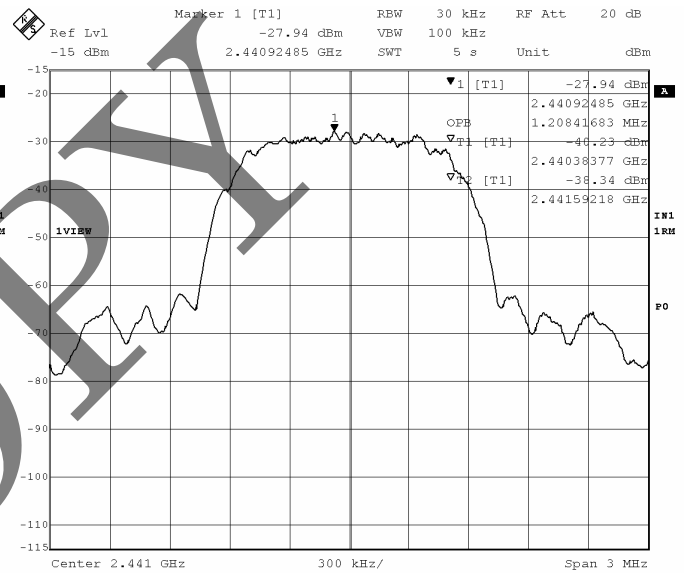
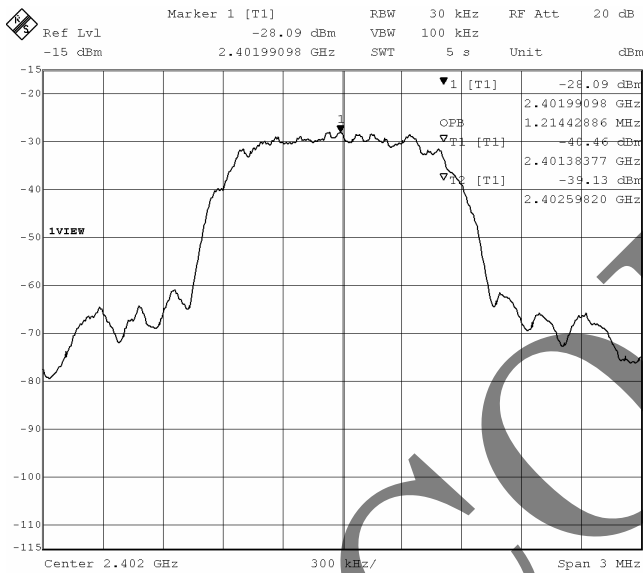

A.4 Dwell Time

Date : January 4, 2010
 Temp. : 18 °C Humi. : 45 %

Mode of EUT : TX Mode (Hopping)
 Packet Setting : DH1
 Test Port : Temporary antenna connector

Dwell Time (ms)	Limit
127.3	400 ms per 31.6 seconds

Note : The system makes worst case 1600 hops per second or 1 time slot has a length of 625 μs with 79 channels. A DH1 Packet need 1 time slot for transmitting and 1 time slot for receiving. Then the system makes worst case 800 hops per second with 79 channels. So the system has each channel 10.1266 times per second and so for 31.6 seconds the system have 320.0 times of appearance.

Each tx-time per appearance is 0.3978 ms.
 Dwell time = 320.0 * 0.3978 = 127.3 ms

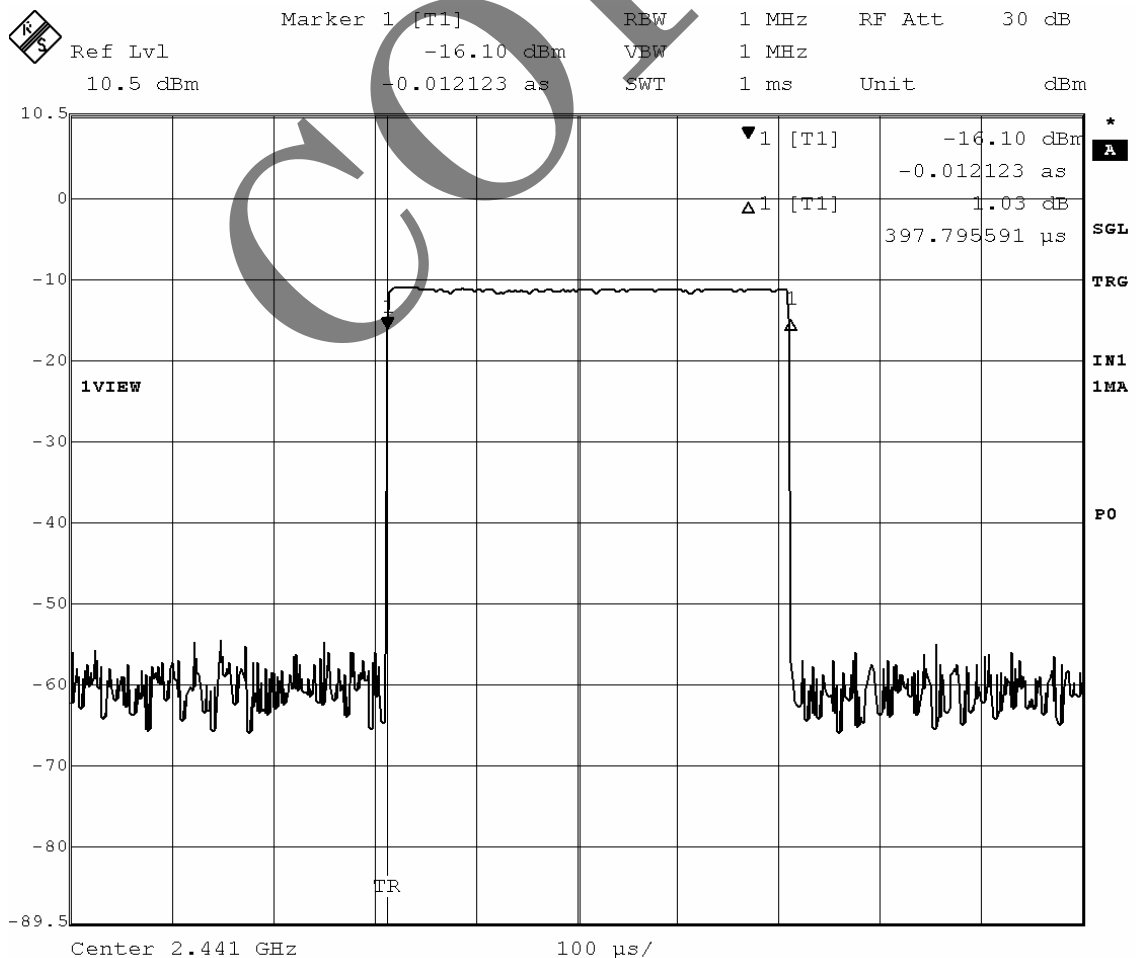

Mode of EUT : TX Mode (Hopping)
 Packet Setting : DH3
 Test Port : Temporary antenna connector

Dwell Time (ms)	Limit
264.6	400 ms per 31.6 seconds

Note : A DH3 Packet need 3 time slot for transmitting and 1 time slot for receiving. Then the system makes worst case 400 hops per second with 79 channels. So the system have each channel 5.063 times per second and so for 31.6 seconds the system have 160.0 times of appearance.

Each tx-time per appearance is 1.654 ms.
 Dwell time = 160.0 * 1.654 = 264.6 ms

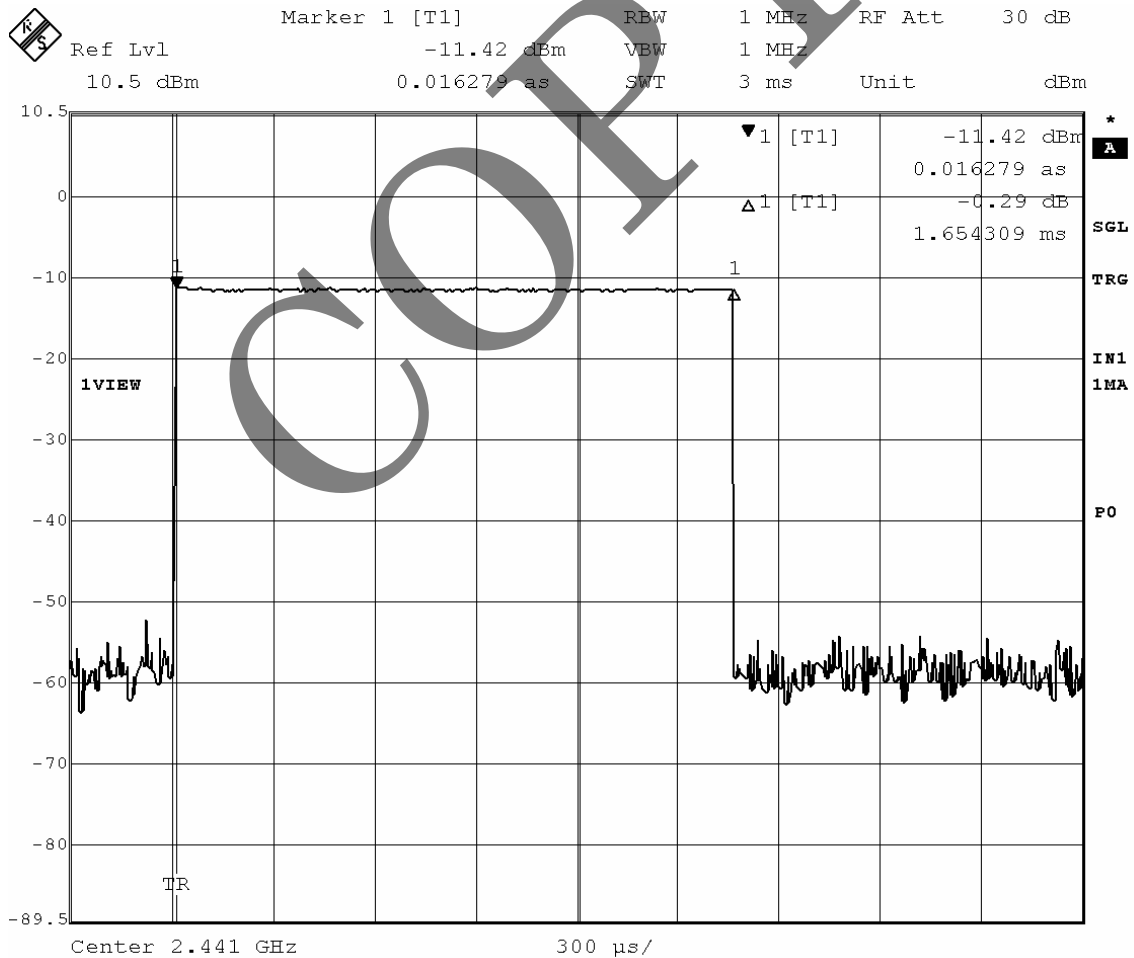

Mode of EUT : TX Mode (Hopping)
 Packet Setting : DH5
 Test Port : Temporary antenna connector

Dwell Time (ms)	Limit
308.0	400 ms per 31.6 seconds

Note : A DH5 Packet need 5 time slot for transmitting and 1 time slot for receiving. Then the system makes worst case 266.667 hops per second with 79 channels. So the system have each channel 3.3755 times per second and so for 31.6 seconds the system have 106.7 times of appearance.

Each tx-time per appearance is 2.887 ms.
 Dwell time = 106.7 * 2.887 = 308.0 ms

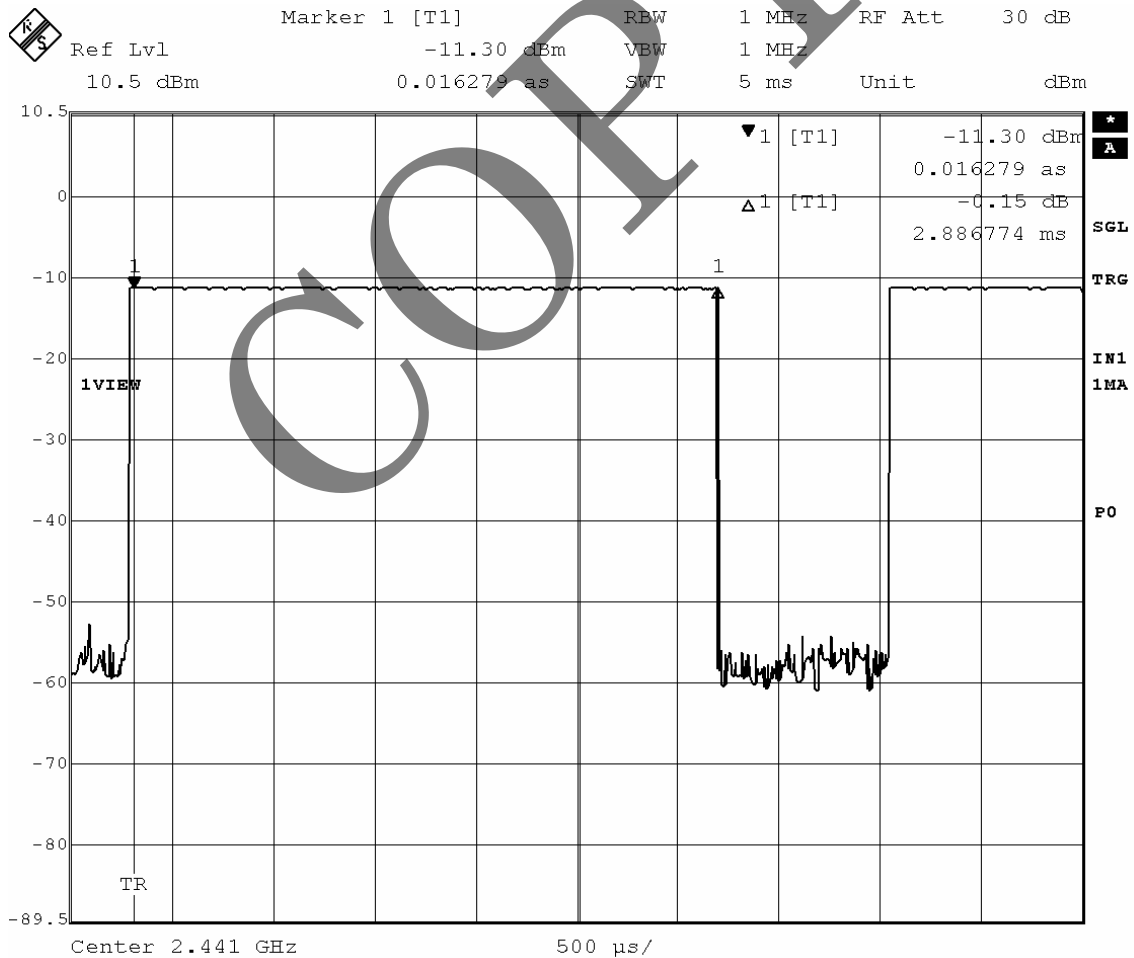

A.5 Peak Output Power (Conduction)

Date : January 4, 2010
 Temp. : 18 °C Humi. : 45 %

A.5.1 Packet Setting : DH5(GFSK)

Mode of EUT : TX Mode

Test Port : Temporary antenna connector

Frequency (MHz)	Cable Loss (dB)	Attenuator Loss (dB)	Meter Reading (dBm)	Peak Power (dBm)	Limit (dBm)
2402	1.40	10.06	-10.80	0.66	21
2441	1.40	10.06	-10.71	0.75	21
2480	1.40	10.06	-12.76	-1.30	21

A.5.2 Packet Setting : 2-DH5(π/4DQPSK)

Frequency (MHz)	Cable Loss (dB)	Attenuator Loss (dB)	Meter Reading (dBm)	Peak Power (dBm)	Limit (dBm)
2402	1.40	10.06	-10.80	0.66	21
2441	1.40	10.06	-11.21	0.25	21
2480	1.40	10.06	-13.34	-1.88	21

A.5.3 Packet Setting : 3-DH5(8DPSK)

Frequency (MHz)	Cable Loss (dB)	Attenuator Loss (dB)	Meter Reading (dBm)	Peak Power (dBm)	Limit (dBm)
2402	1.40	10.06	-10.82	0.64	21
2441	1.40	10.06	-10.65	0.81	21
2480	1.40	10.06	-12.90	-1.44	21

Note : 1) Rated Supply Voltage : 12.0 VDC

2) A sample calculation was made at 2402 MHz(Packet Setting : DH5(GFSK)).

$$CL + AL + MR = 1.40 + 10.06 + (-10.80) = 0.66 \text{ (dBm)}$$

CL : Cable Loss AL : Attenuator Loss MR : Meter Reading

A.6 Peak Output Power (Radiation)

Not Applicable

A.7 Peak Power Density (Conduction)

Date : January 4, 2010
 Temp. : 18 °C Humi. : 45 %

A.7.1 Packet Setting : DH5(GFSK)

Mode of EUT : TX Mode

Test Port : Temporary antenna connector

Frequency (MHz)	Cable Loss (dB)	Attenuator Loss (dB)	Meter Reading (dBm)	Peak Power (dBm)	Limit (dBm)
2402	1.40	10.06	-23.68	-12.22	8
2441	1.40	10.06	-23.45	-11.99	8
2480	1.40	10.06	-26.12	-14.66	8

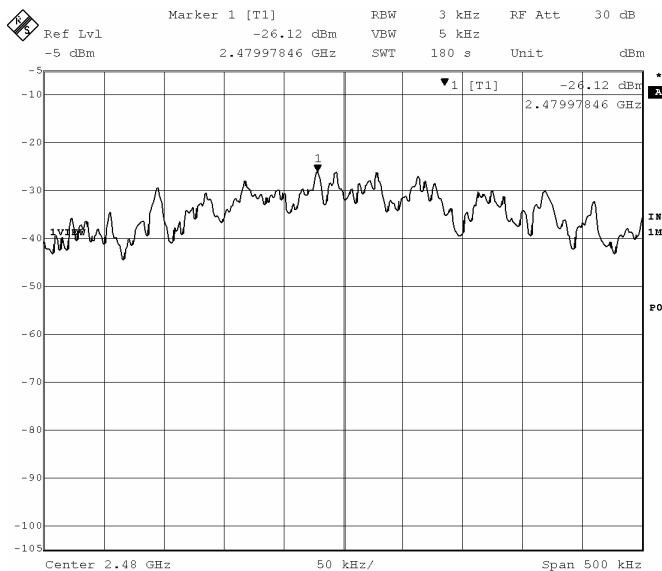
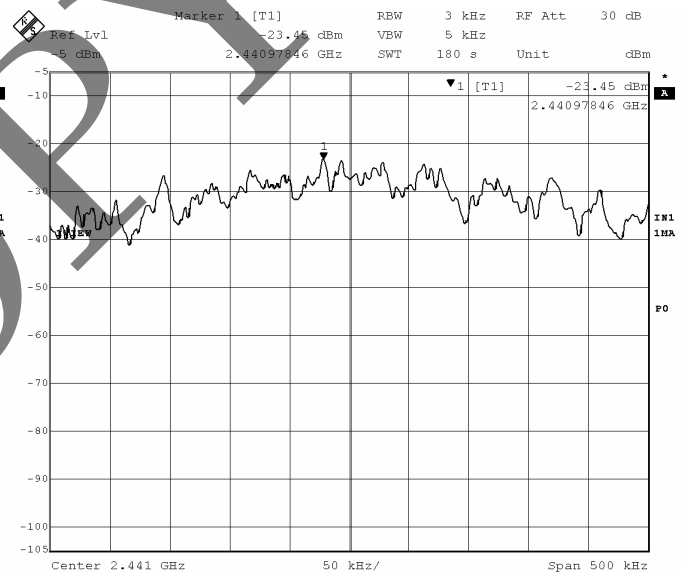
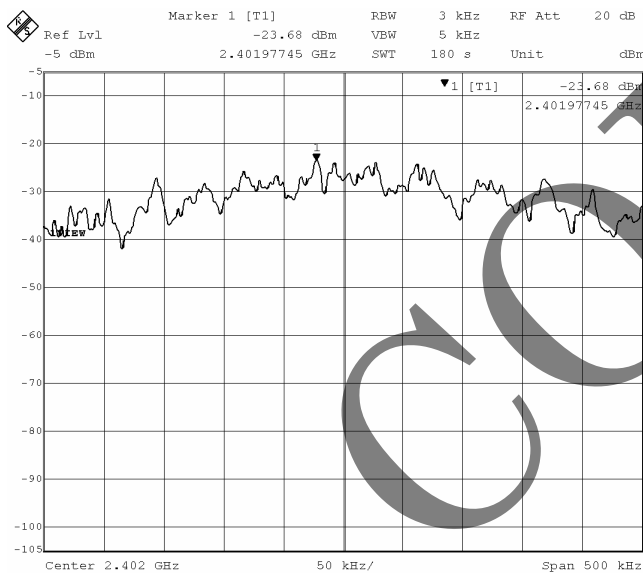

A.7.2 Packet Setting : 2-DH5(π /4DQPSK)

Mode of EUT : TX Mode

Test Port : Temporary antenna connector

Frequency (MHz)	Cable Loss (dB)	Attenuator Loss (dB)	Meter Reading (dBm)	Peak Power (dBm)	Limit (dBm)
2402	1.40	10.06	-28.92	-17.46	8
2441	1.40	10.06	-28.28	-16.82	8
2480	1.40	10.06	-30.18	-18.72	8

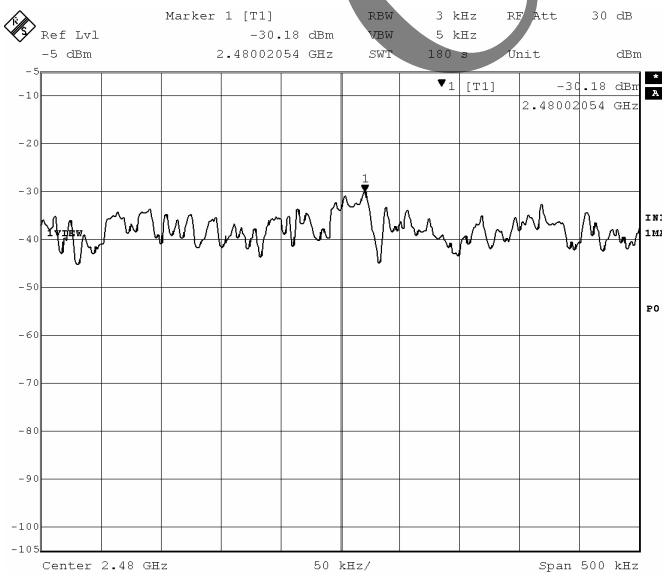
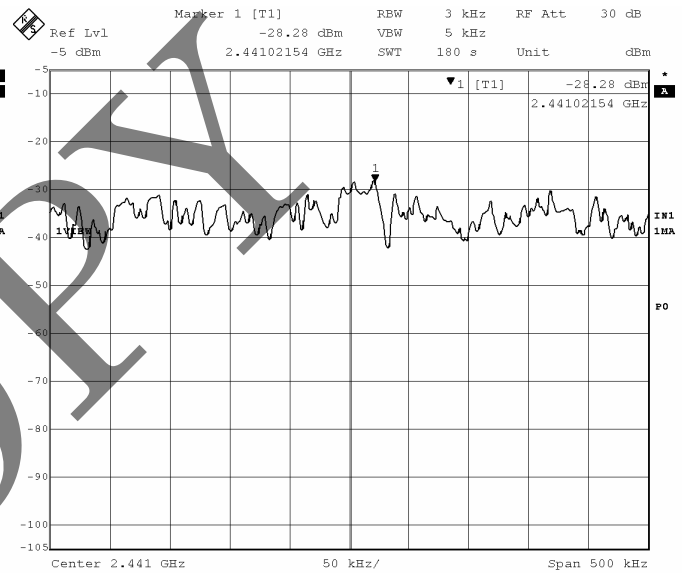
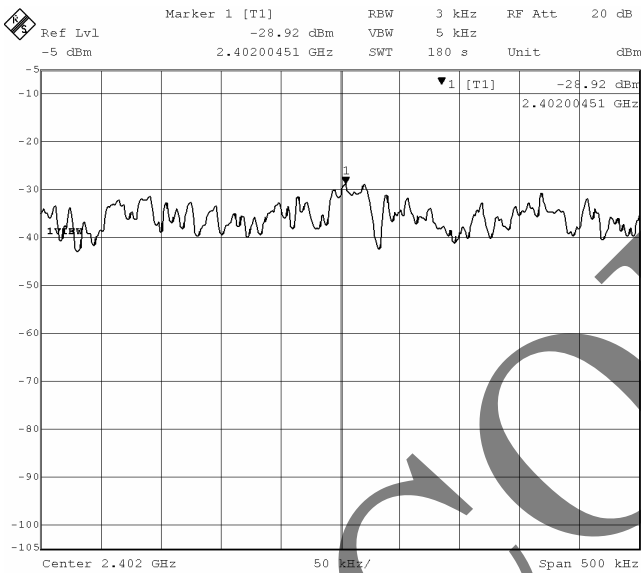

A.7.3 Packet Setting : 3-DH5(8DPSK)

Mode of EUT : TX Mode

Test Port : Temporary antenna connector

Frequency (MHz)	Cable Loss (dB)	Attenuator Loss (dB)	Meter Reading (dBm)	Peak Power (dBm)	Limit (dBm)
2402	1.40	10.06	-29.28	-17.82	8
2441	1.40	10.06	-28.13	-16.67	8
2480	1.40	10.06	-30.47	-19.01	8

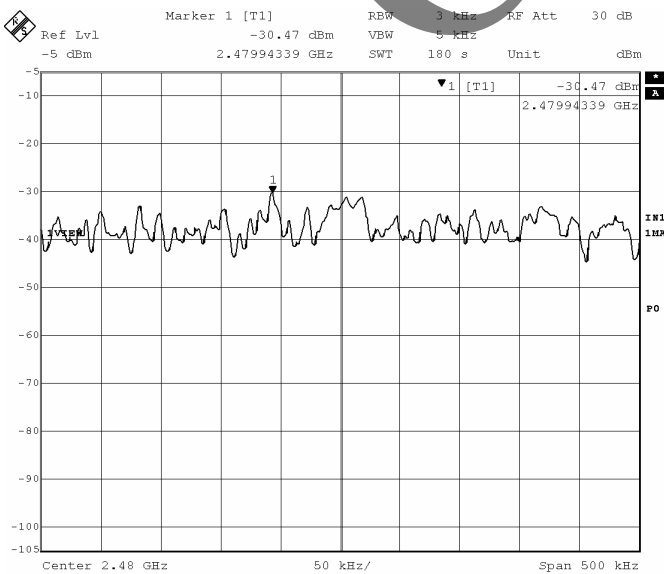
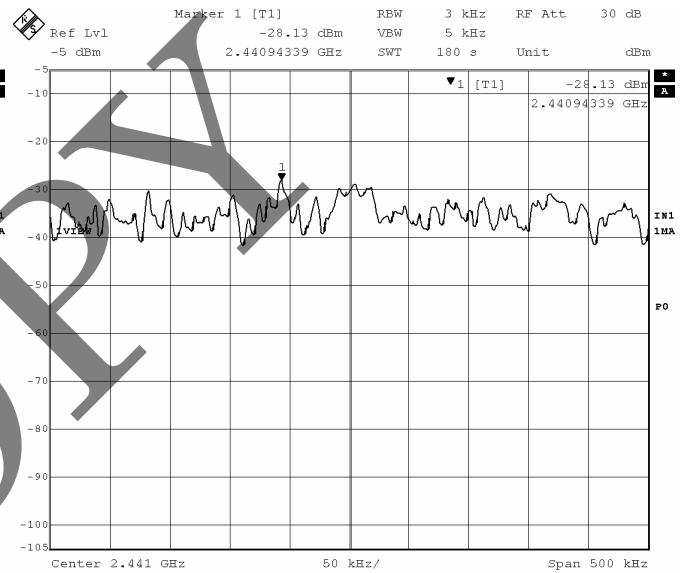
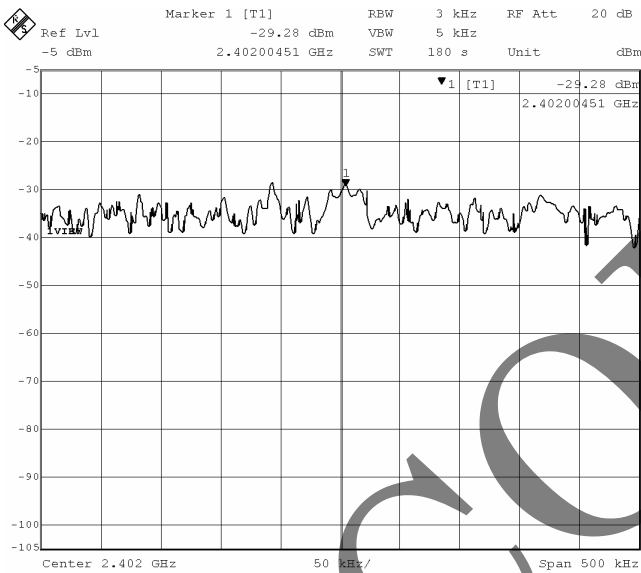

Note : 1) A sample calculation was made at 2402 MHz(Packet Setting : DH5(GFSK)).

$$CL + AL + MR = 1.40 + 10.06 + (-23.68) = -12.22 \text{ (dBm)}$$

CL : Cable Loss AL : Attenuator Loss MR : Meter Reading

2) Measuring Instruments Setting :

Detector Function

Resolution Bandwidth

Peak

3 kHz

A.8 Peak Power Density (Radiation)

Not Applicable

COPY

A.9 Spurious Emissions (Conduction)

A.9.1 Band Edge Compliance

Date : January 4, 2010
 Temp. : 18 °C Humi. : 45 %

A.9.1.1 Packet Setting : DH5(GFSK)

Mode of EUT : TX Mode (Hopping)

Test Port : Temporary antenna connector

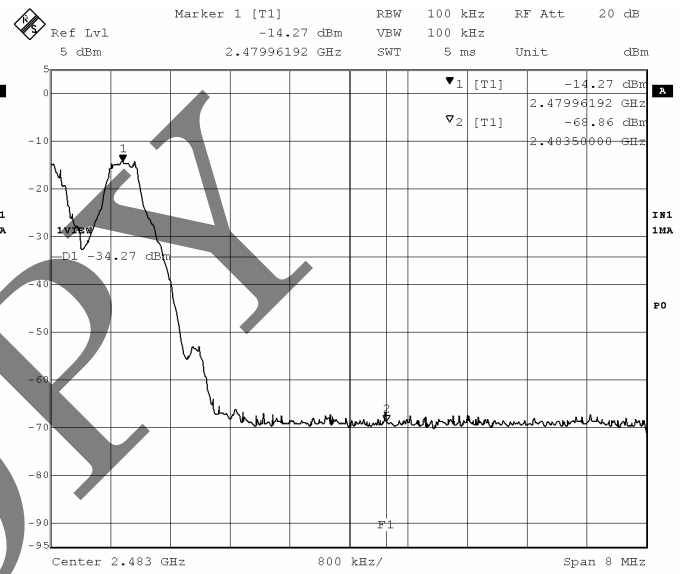
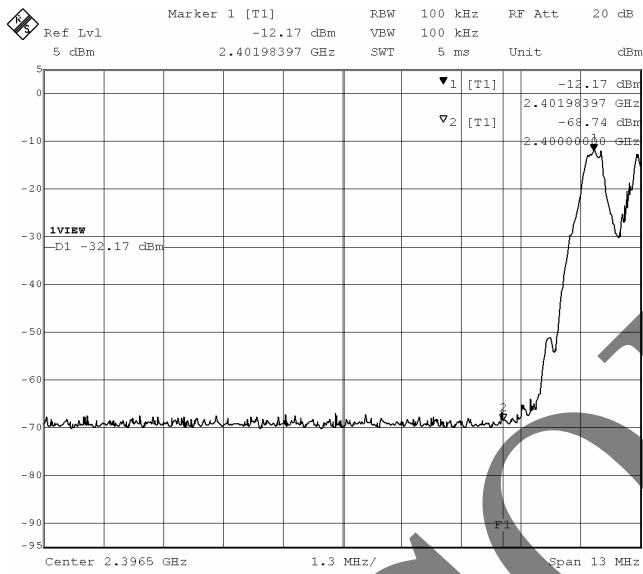

A.9.1.2 Packet Setting : 2-DH5($\pi/4$ DQPSK)

Mode of EUT : TX Mode (Hopping)

Test Port : Temporary antenna connector

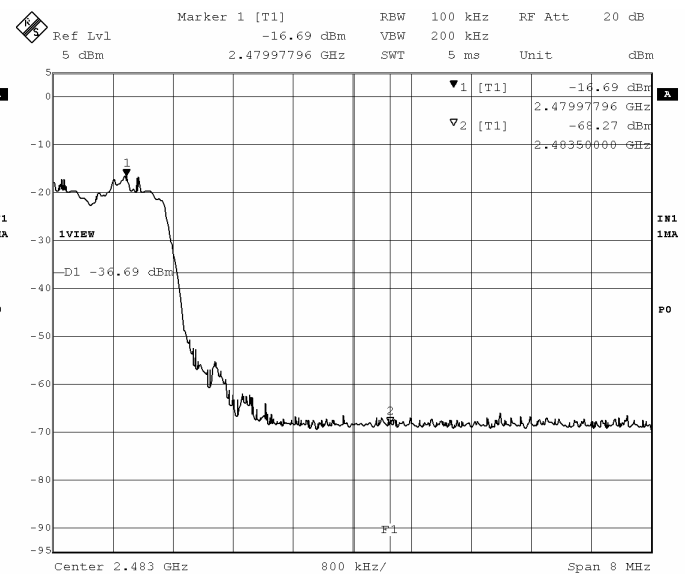
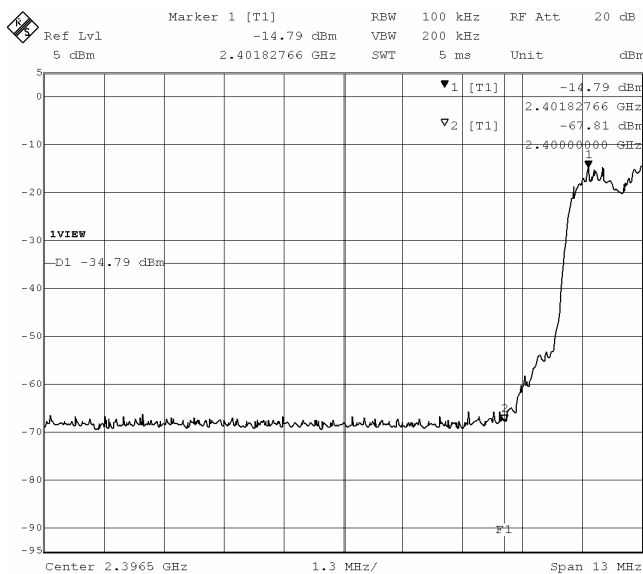

A.9.1.3 Packet Setting : 3-DH5(8DPSK)

Mode of EUT : TX Mode (Hopping)

Test Port : Temporary antenna connector

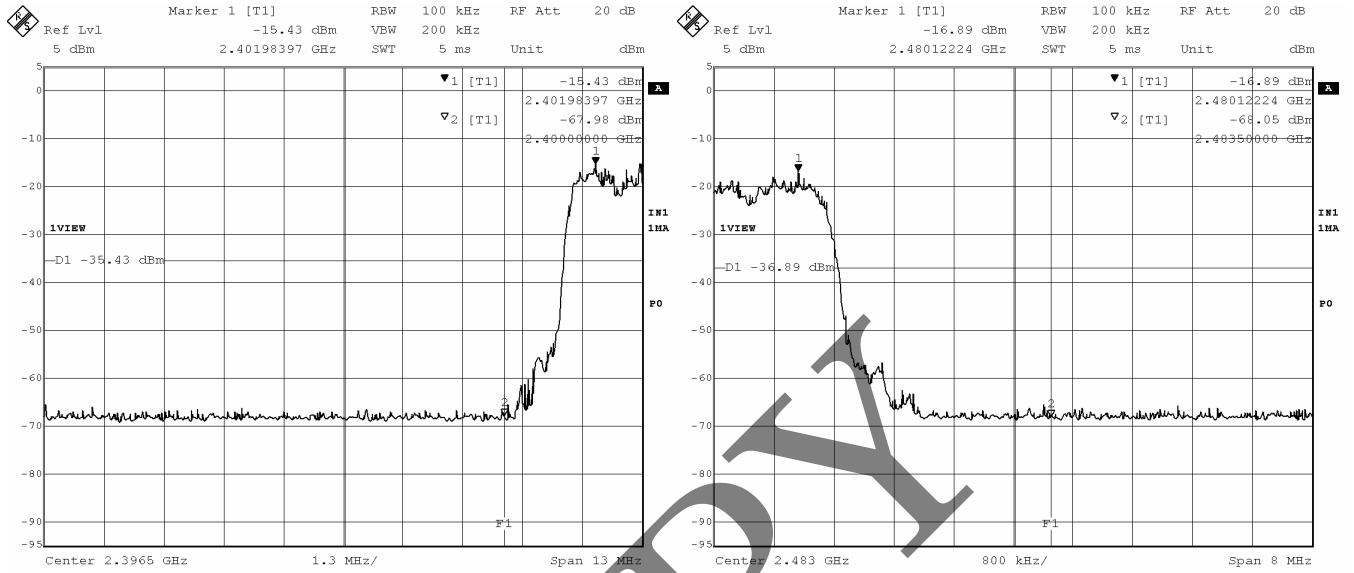

COPY

A.9.2 Other Spurious Emissions

Date : January 4, 2010
 Temp. : 18 °C Humi. : 45 %

A.9.2.1 Packet Setting : DH5(GFSK)

Mode of EUT : TX Mode (Och : 2402MHz)
 Test Port : Temporary antenna connector

Frequency (MHz)	Cable Loss (dB)	Attenuator Loss (dB)	Meter Reading (dBm)	Peak Power (dBm)	Limit (dBm)
2402	1.40	10.06	-11.11	0.35	--
5551	1.40	10.06	-58.29	-48.69	-19.65
6975	1.40	10.06	-52.99	-47.25	-19.65

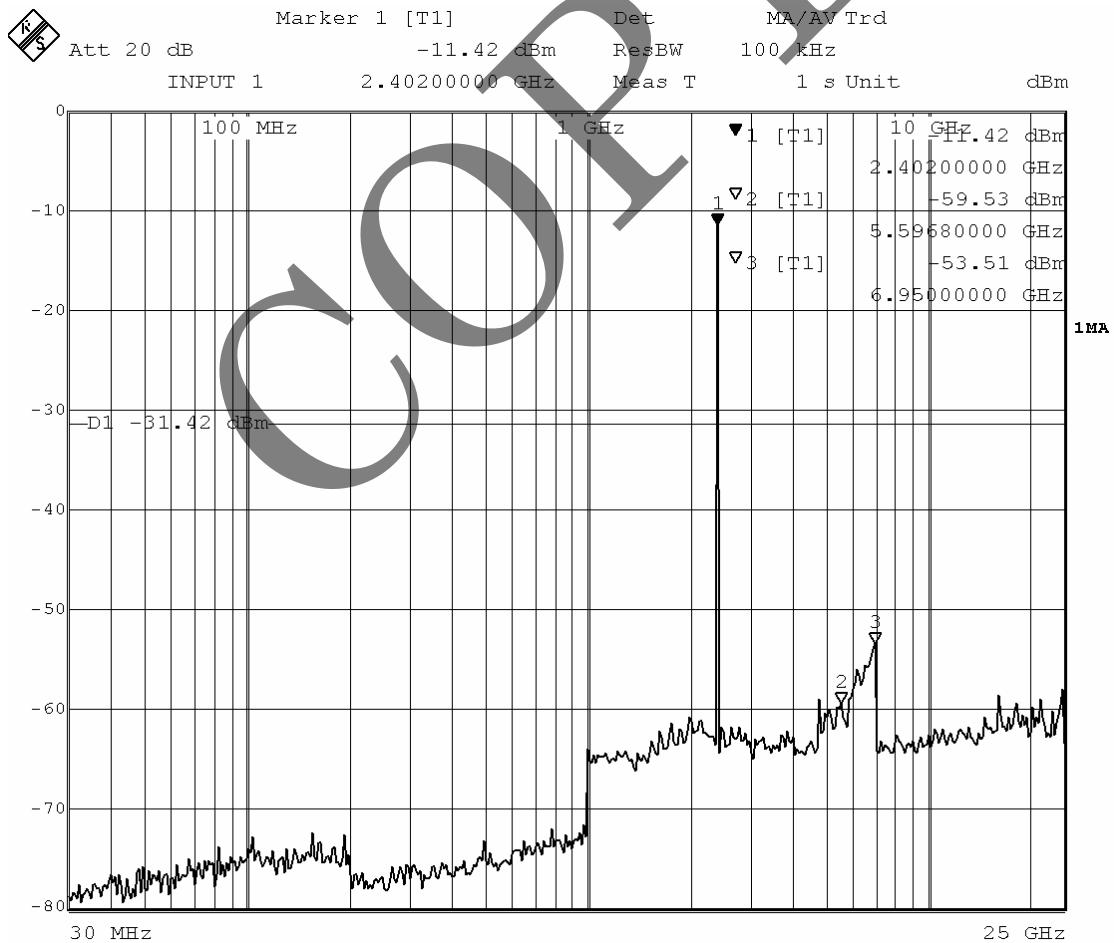

Mode of EUT : TX Mode (39ch : 2441MHz)

Test Port : Temporary antenna connector

Frequency (MHz)	Cable Loss (dB)	Attenuator Loss (dB)	Meter Reading (dBm)	Peak Power (dBm)	Limit (dBm)
2441	1.40	10.06	-11.07	0.39	--
5548	1.40	10.06	-57.99	-46.53	-19.61
6951	1.40	10.06	-53.68	-42.22	-19.61

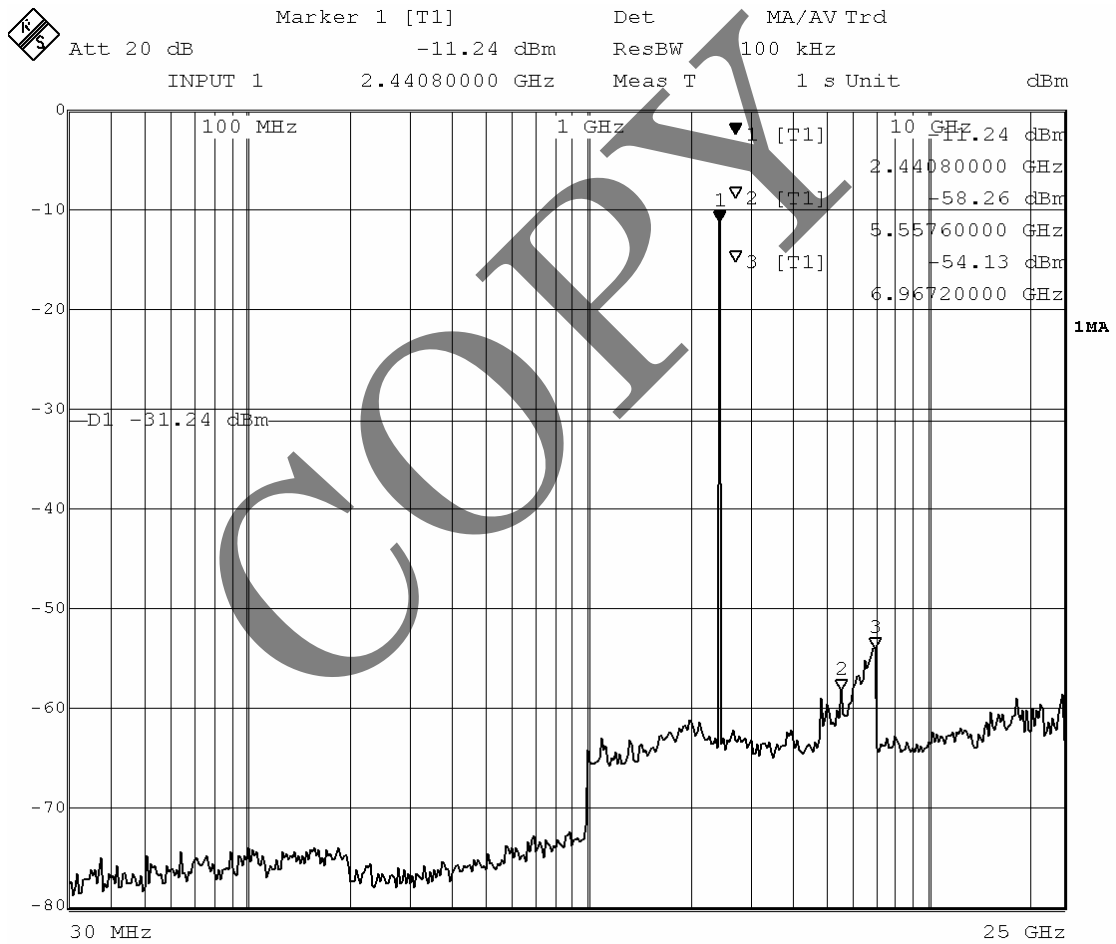

Mode of EUT : TX Mode (78ch : 2480MHz)

Test Port : Temporary antenna connector

Frequency (MHz)	Cable Loss (dB)	Attenuator Loss (dB)	Meter Reading (dBm)	Peak Power (dBm)	Limit (dBm)
2480	1.40	10.06	-12.87	-1.41	--
5570	1.40	10.06	-57.71	-46.25	-21.41
6965	1.40	10.06	-53.48	-42.02	-21.41

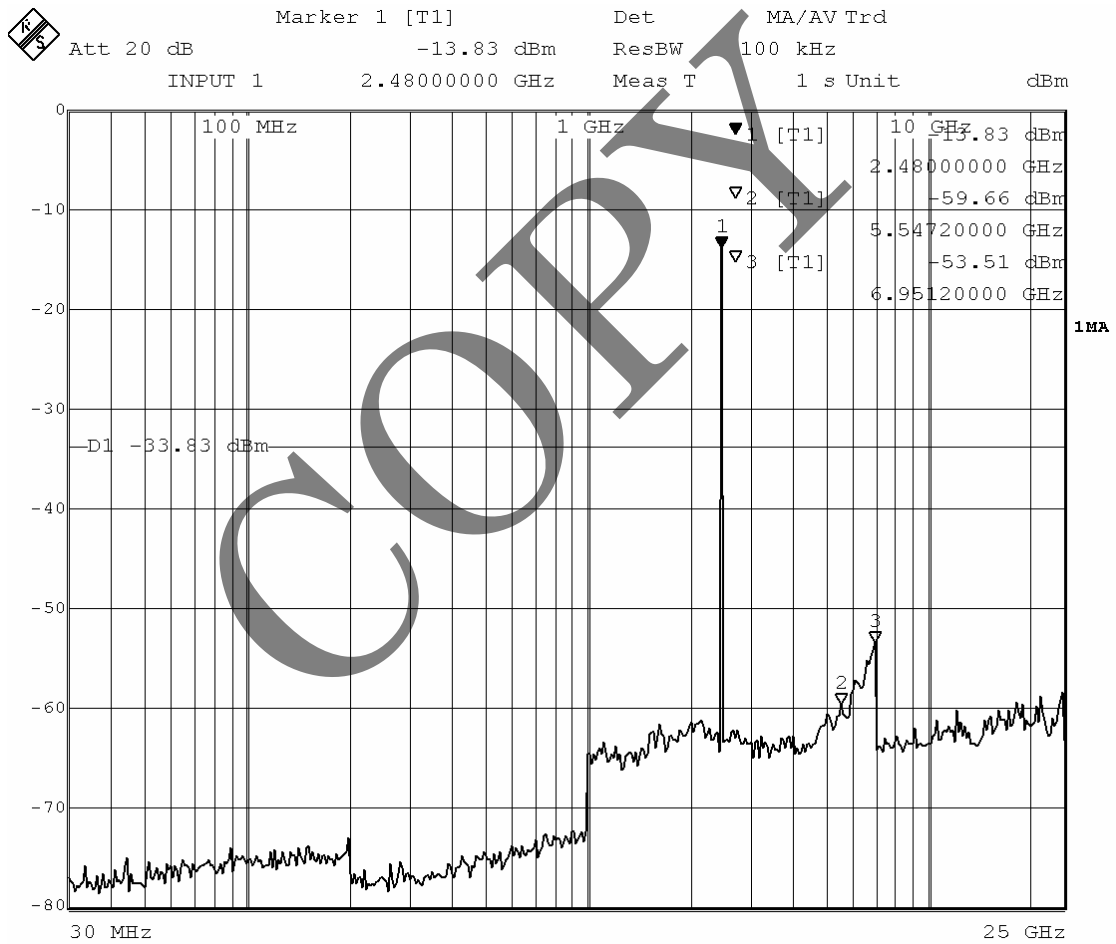

A.9.2.2 Packet Setting : 2-DH5($\pi/4$ DQPSK)

Mode of EUT : TX Mode (Och : 2402MHz)

Test Port : Temporary antenna connector

Frequency (MHz)	Cable Loss (dB)	Attenuator Loss (dB)	Meter Reading (dBm)	Peak Power (dBm)	Limit (dBm)
2402	1.40	10.06	-13.55	-2.09	--
6189	1.40	10.06	-56.14	-44.68	-22.09
6972	1.40	10.06	-53.35	-41.89	-22.09

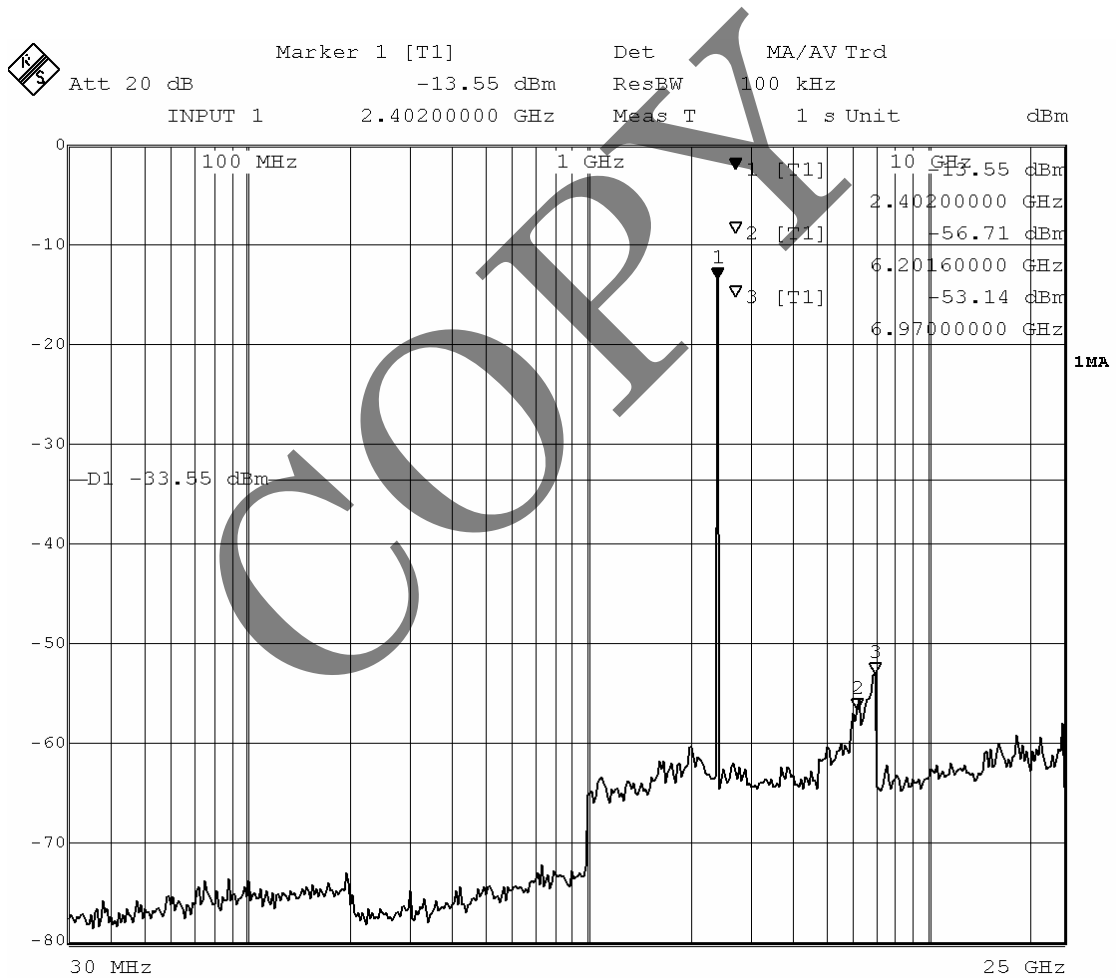

Mode of EUT : TX Mode (39ch : 2441MHz)

Test Port : Temporary antenna connector

Frequency (MHz)	Cable Loss (dB)	Attenuator Loss (dB)	Meter Reading (dBm)	Peak Power (dBm)	Limit (dBm)
2441	1.40	10.06	-13.29	-1.83	--
6164	1.40	10.06	-56.53	-45.03	-21.83
6955	1.40	10.06	-53.23	-41.77	-21.83

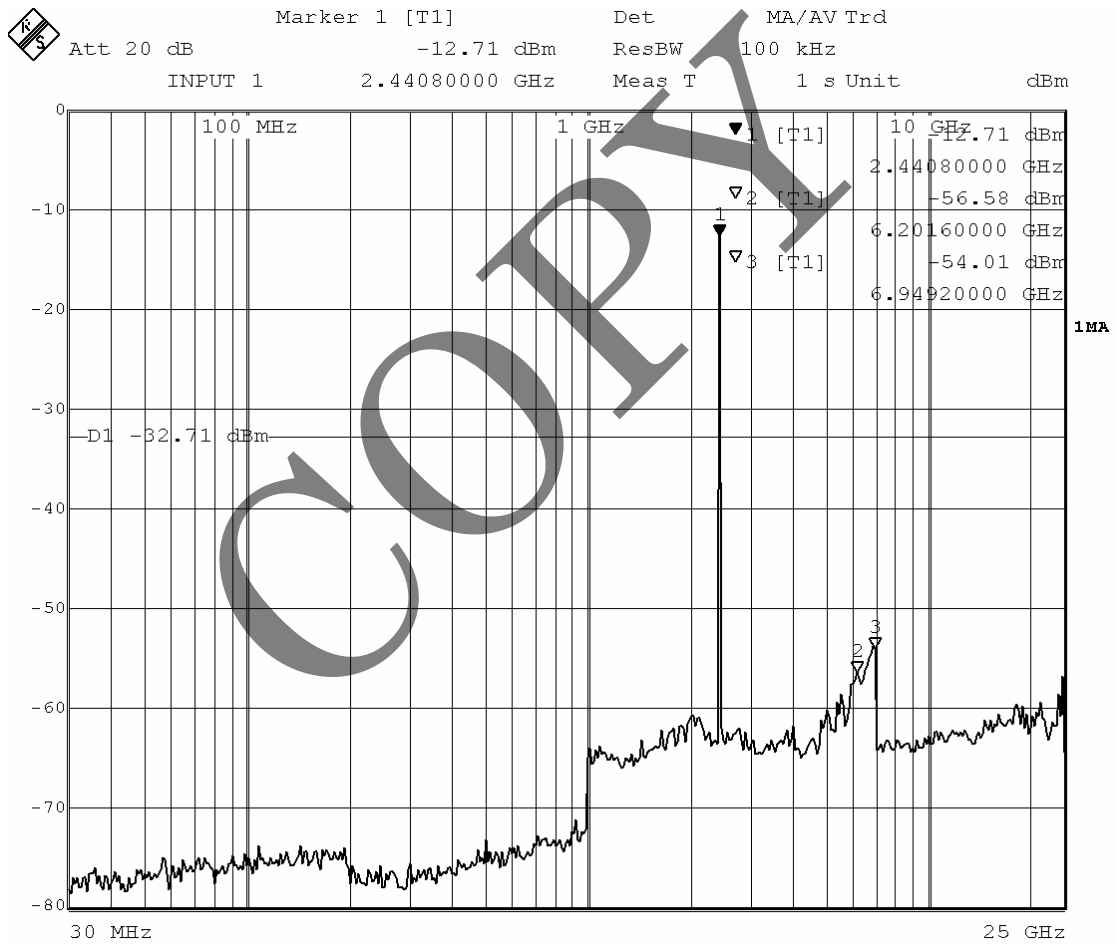

Mode of EUT : TX Mode (78ch : 2480MHz)

Test Port : Temporary antenna connector

Frequency (MHz)	Cable Loss (dB)	Attenuator Loss (dB)	Meter Reading (dBm)	Peak Power (dBm)	Limit (dBm)
2480	1.40	10.06	-15.50	-4.04	--
6191	1.40	10.06	-56.23	-44.77	-24.04
6953	1.40	10.06	-53.58	-42.12	-24.04

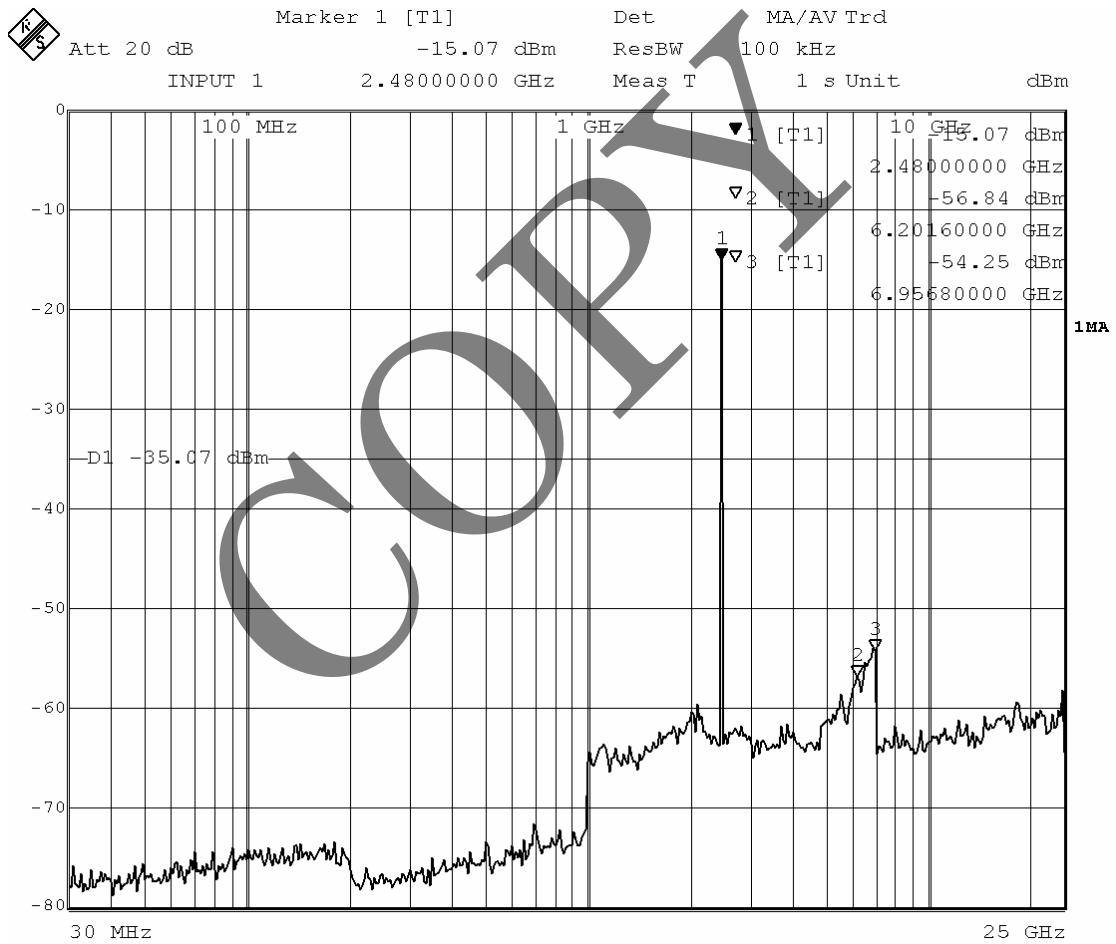

A.9.2.3 Packet Setting : 3-DH5(8DPSK)

Mode of EUT : TX Mode (Och : 2402MHz)

Test Port : Temporary antenna connector

Frequency (MHz)	Cable Loss (dB)	Attenuator Loss (dB)	Meter Reading (dBm)	Peak Power (dBm)	Limit (dBm)
2402	1.40	10.06	-13.56	-2.10	--
6192	1.40	10.06	-56.14	-44.68	-22.10
6969	1.40	10.06	-53.31	-41.85	-22.10

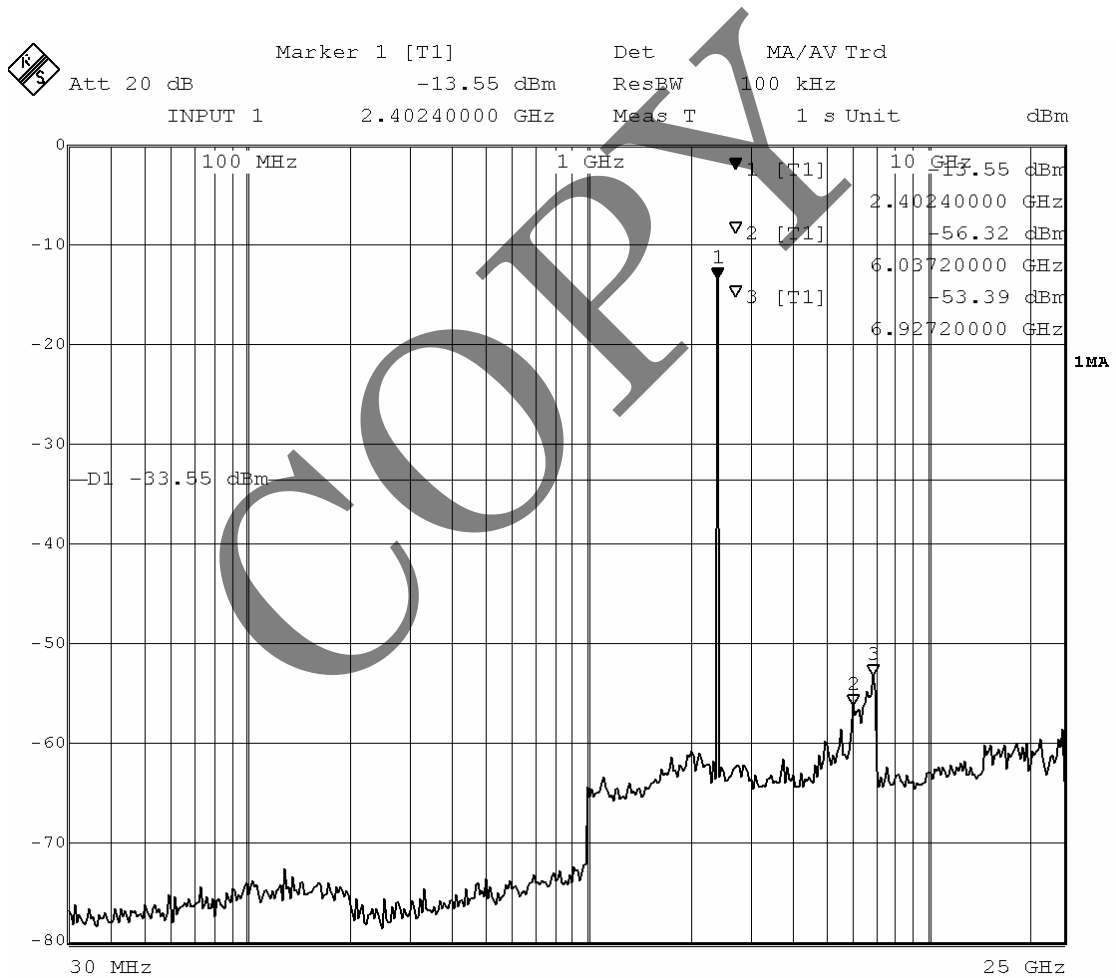

Mode of EUT : TX Mode (39ch : 2441MHz)

Test Port : Temporary antenna connector

Frequency (MHz)	Cable Loss (dB)	Attenuator Loss (dB)	Meter Reading (dBm)	Peak Power (dBm)	Limit (dBm)
2441	1.40	10.06	-13.32	-1.85	--
6180	1.40	10.06	-56.47	-45.01	-21.85
6952	1.40	10.06	-52.99	-41.53	-21.85

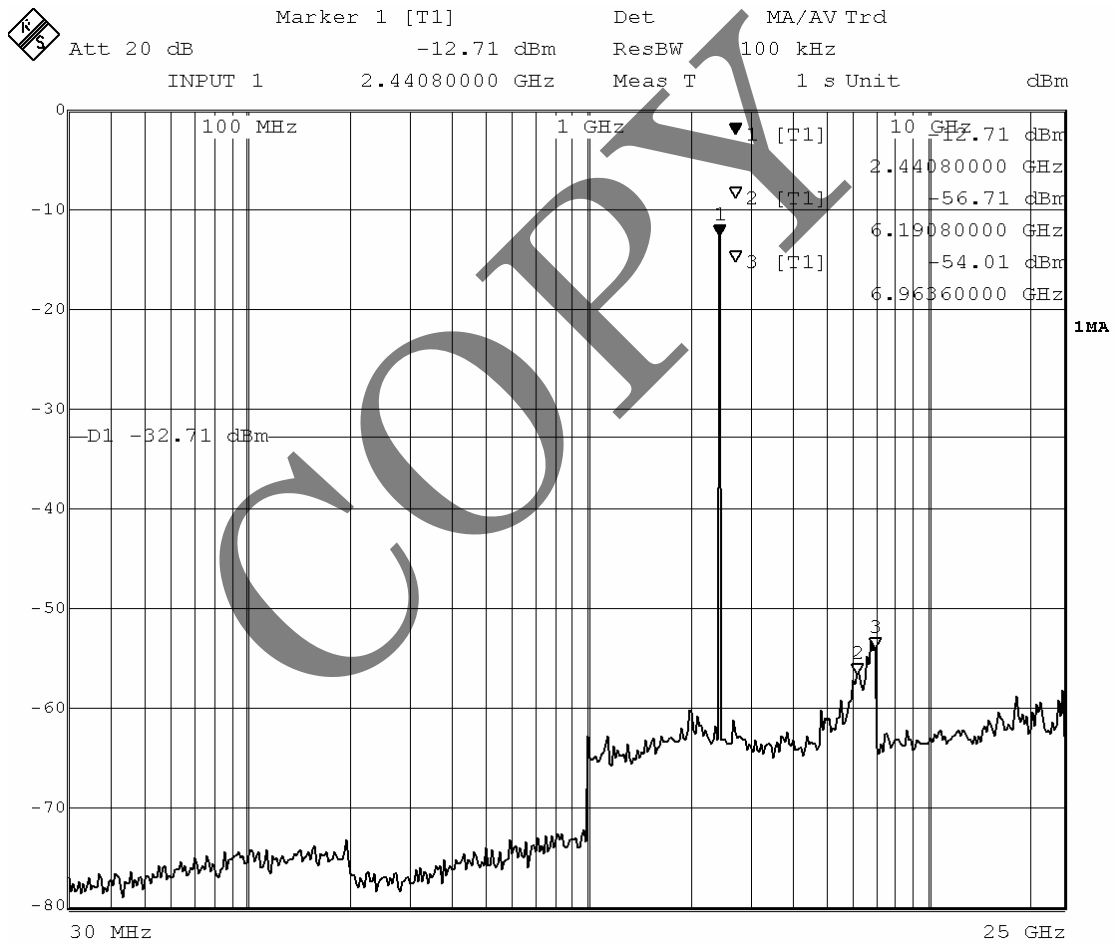

Mode of EUT : TX Mode (78ch : 2480MHz)

Test Port : Temporary antenna connector

Frequency (MHz)	Cable Loss (dB)	Attenuator Loss (dB)	Meter Reading (dBm)	Peak Power (dBm)	Limit (dBm)
2480	1.40	10.06	-15.57	-4.11	--
6175	1.40	10.06	-56.29	-44.83	-24.11
6981	1.40	10.06	-54.46	-43.00	-24.11

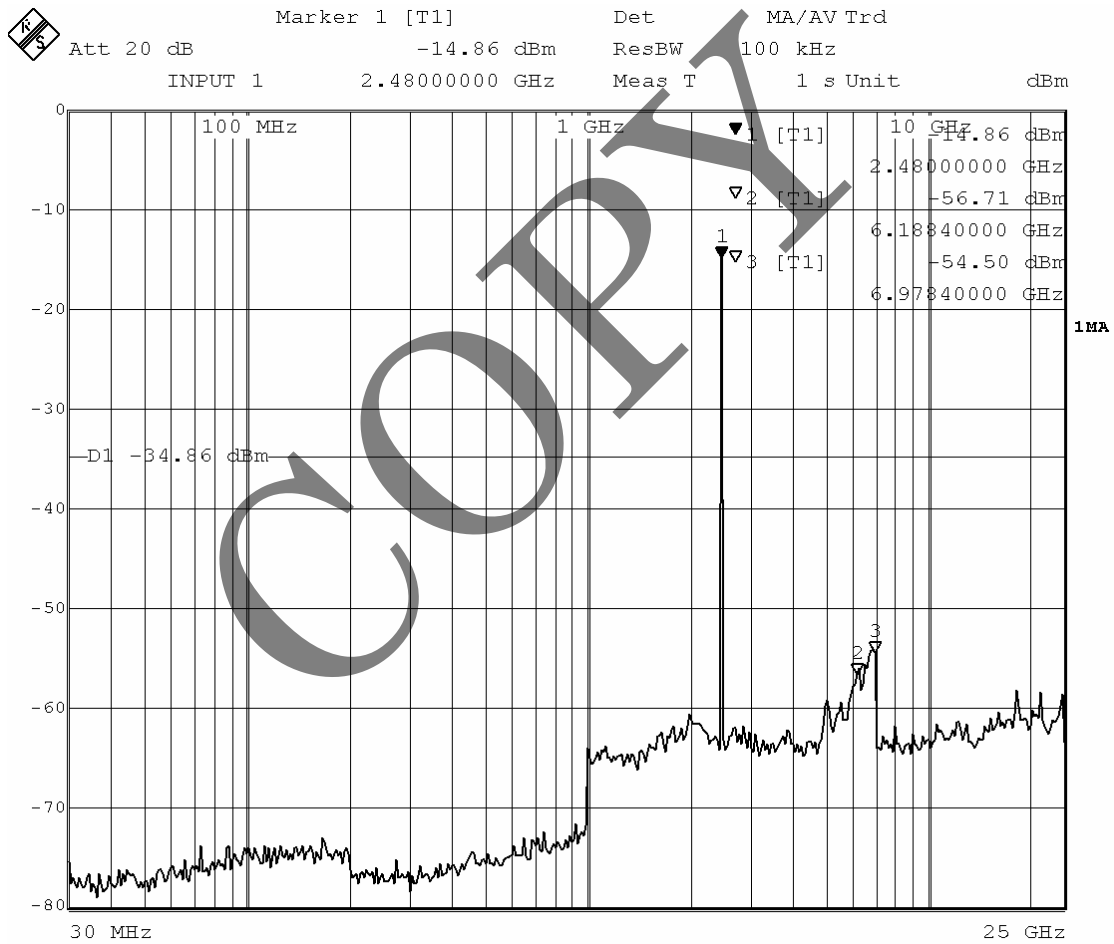

Note : 1) A sample calculation was made at 2402 MHz(Packet Setting : DH5(GFSK)).

$$CL + AL + MR = 1.40 + 10.06 + (-11.11) = 0.35 \text{ (dBm)}$$

CL : Cable Loss AL : Attenuator Loss MR : Meter Reading

2) Measuring Instruments Setting :

Detector Function	Resolution Bandwidth
Peak	100 kHz

A.10 Spurious Emissions for Transmitter (Radiation)

A.10.1 Band Edge Compliance

Date : January 19, 2010
 Temp. : 20 °C Humi. : 35 %

A.10.1.1 Packet Setting : DH5(GFSK)

Mode of EUT : TX Mode (Hopping)

Test Port : Enclosure

Antenna Polarization : Horizontal

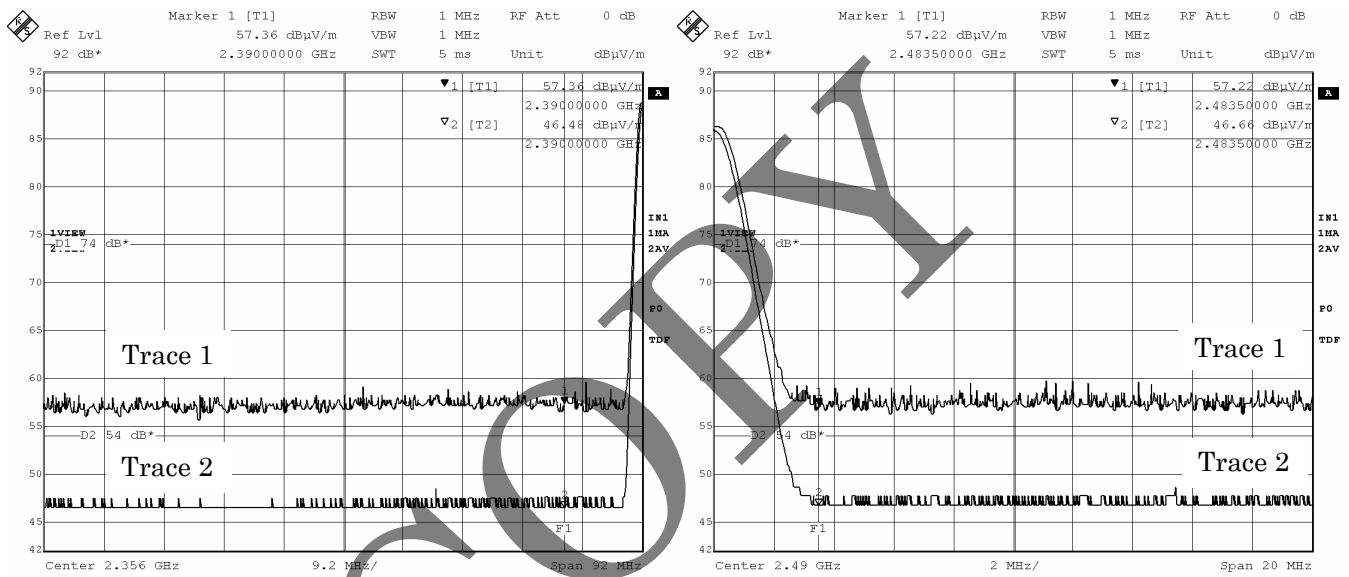

Note : The trace 1 is Peak detection. The Trace 2 is Average detection.

Antenna Polarization : Vertical

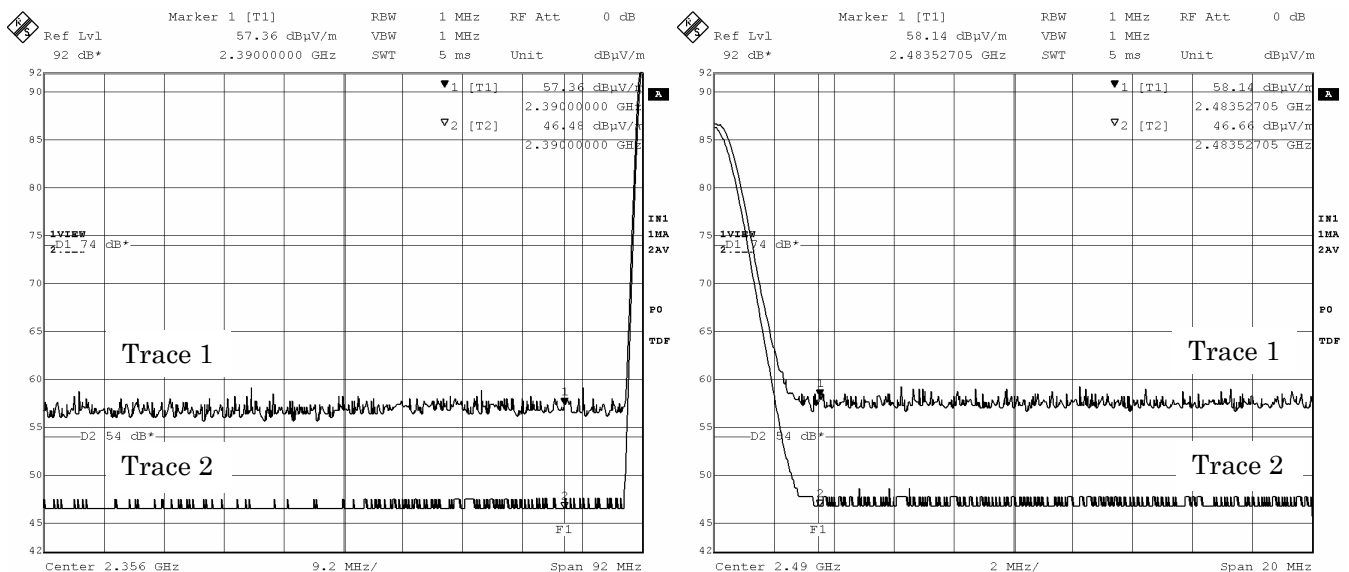

Note : The trace 1 is Peak detection. The Trace 2 is Average detection.

A.10.1.2 Packet Setting : 2-DH5($\pi/4$ DQPSK)

Mode of EUT : TX Mode (Hopping)

Test Port : Enclosure

Antenna Polarization : Horizontal

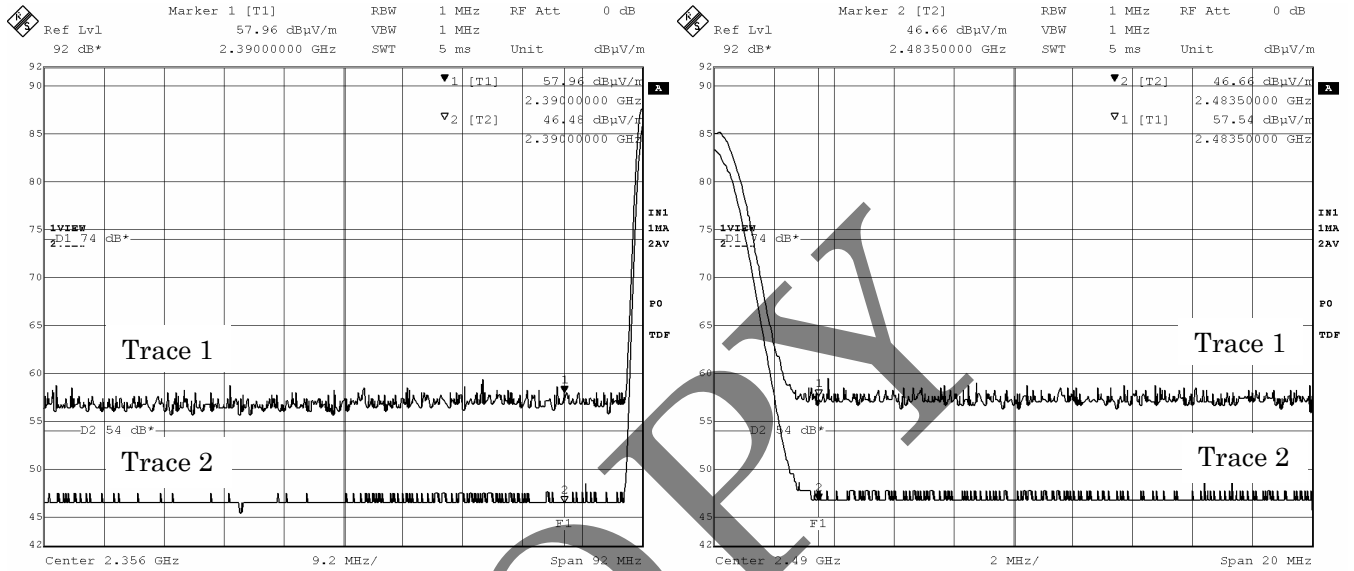

Note : The trace 1 is Peak detection. The Trace 2 is Average detection.

Antenna Polarization : Vertical

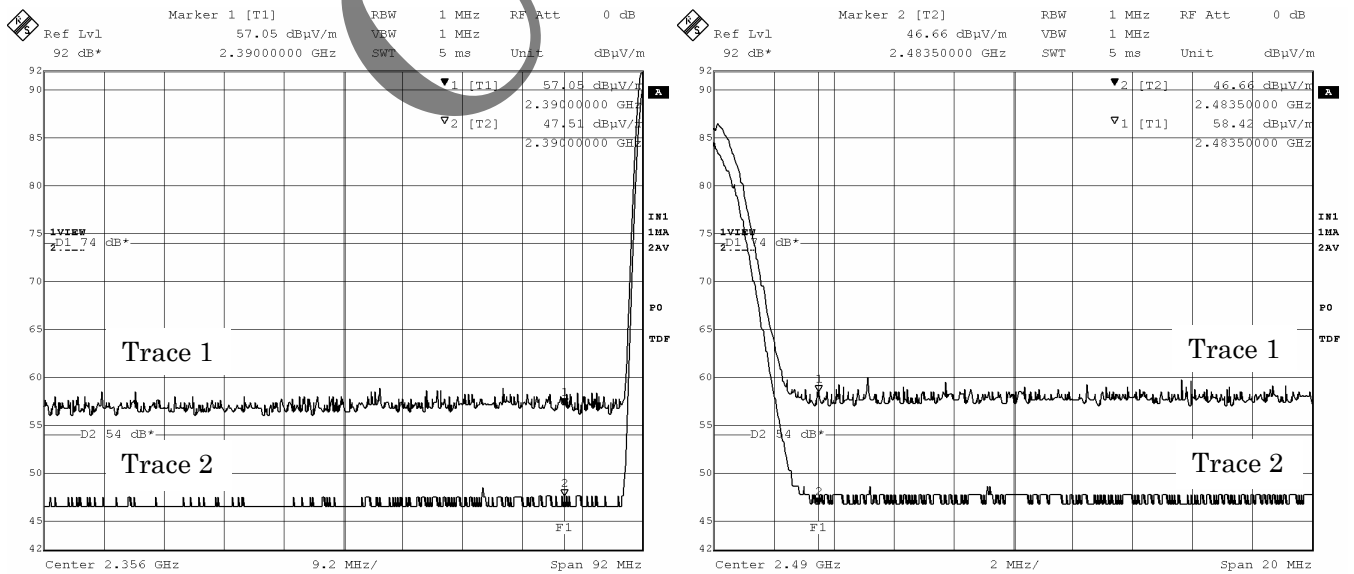

Note : The trace 1 is Peak detection. The Trace 2 is Average detection.

A.10.1.3 Packet Setting : 3-DH5(8DPSK)

Mode of EUT : TX Mode (Hopping)

Test Port : Enclosure

Antenna Polarization : Horizontal

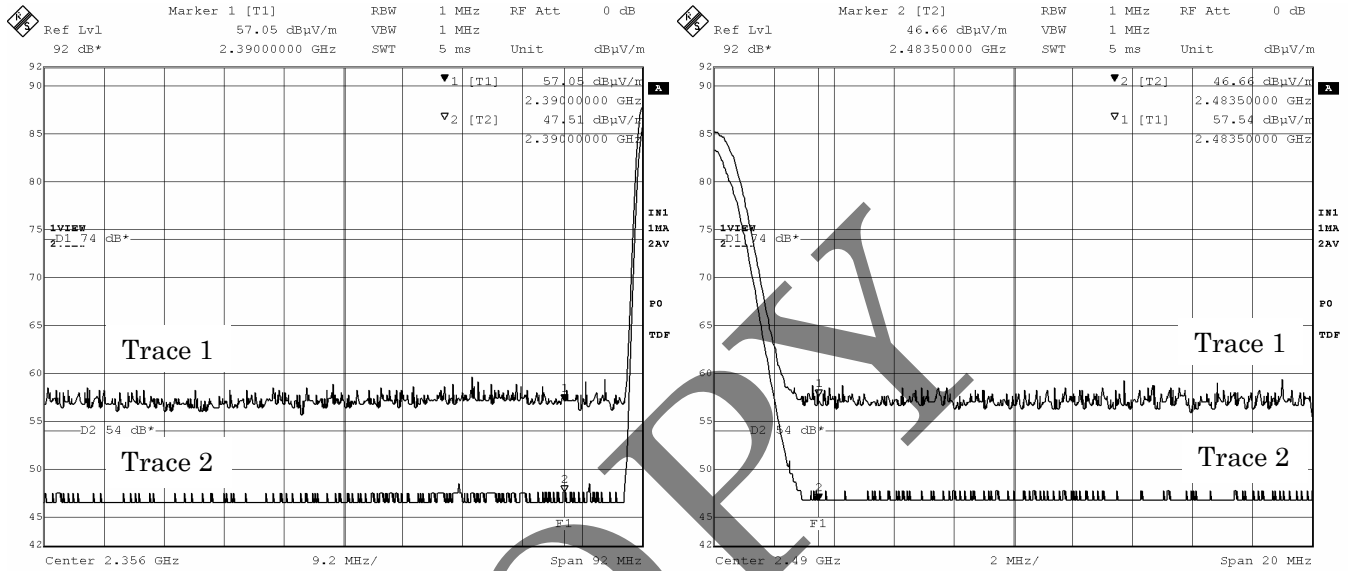

Note : The trace 1 is Peak detection. The Trace 2 is Average detection.

Antenna Polarization : Vertical

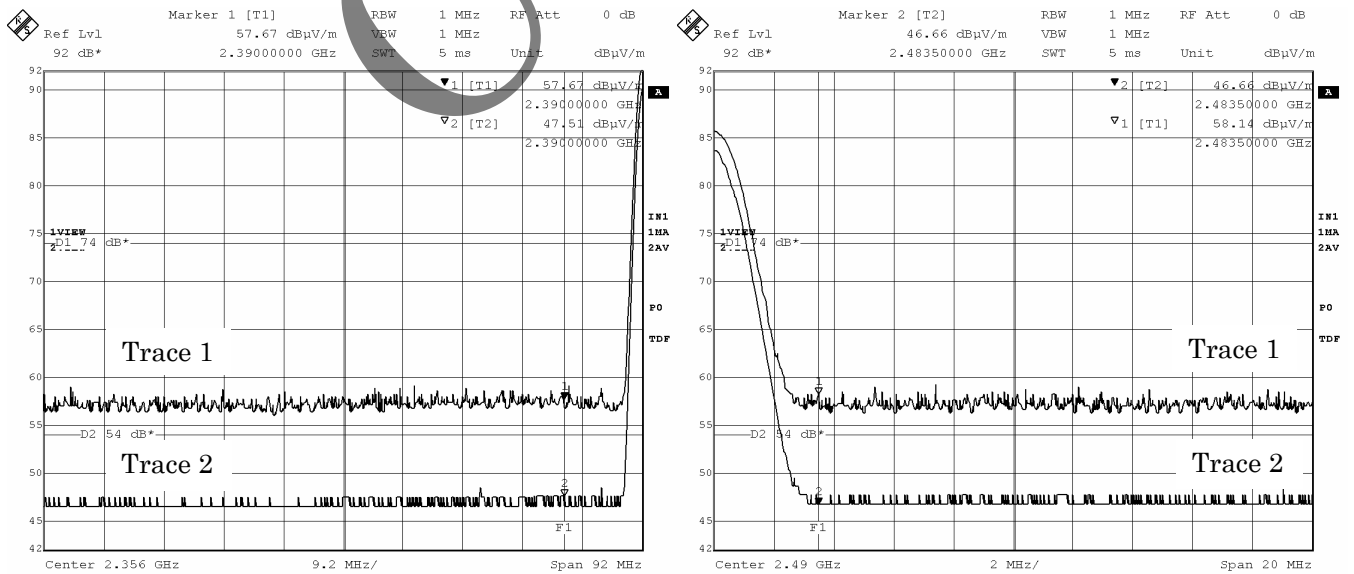

Note : The trace 1 is Peak detection. The Trace 2 is Average detection.

A.10.2 Other Spurious Emissions**A.10.2.1 Spurious Emissions in the frequency range from 9 kHz to 30 MHz**Date : January 19, 2010Temp. : 20 °C Humi. : 35 %

Mode of EUT : All modes have been investigated and worst case mode for Channel (0ch : 2402 MHz,
Packet Setting : DH5(GFSK)) has been listed.

Test Port : Enclosure

The spurious emissions of the EUT were less than 20dB from the limit.

COPY

A.10.2.2 Spurious Emissions in the frequency range from 30 MHz to 1000 MHz

Date : January 19, 2010
 Temp. : 20 °C Humi. : 35 %

Mode of EUT : All modes have been investigated and worst case mode for Channel (0ch : 2402 MHz, Packet Setting : DH5(GFSK)) has been listed.

Test Port : Enclosure

Frequency (MHz)	P-A Factor (dB)	Correction Factor (dB)	Polarization	Meter Reading (dBuV)			Limits (dBuV/m)		Emission Levels (dBuV/m)		Margins (dB)	
				QP	AV	Peak	QP/AV	Peak	QP/AV	Peak	QP/AV	Peak
67.15	0.0	10.7	V	14.8	-	-	40.0	-	25.5	-	14.5	-
83.17	0.0	10.8	V	16.6	-	-	40.0	-	27.4	-	12.6	-
90.77	0.0	12.2	H	10.3	-	-	43.5	-	22.5	-	21.0	-
108.00	0.0	15.6	V	11.3	-	-	43.5	-	26.9	-	16.6	-
129.60	0.0	18.1	V	9.2	-	-	43.5	-	27.3	-	16.2	-
144.00	0.0	18.9	V	5.3	-	-	43.5	-	24.2	-	19.3	-
252.01	0.0	22.1	H	11.8	-	-	46.0	-	33.9	-	12.1	-
288.00	0.0	23.9	H	11.3	-	-	46.0	-	35.2	-	10.8	-
324.01	0.0	19.0	H	14.6	-	-	46.0	-	33.6	-	12.4	-
360.01	0.0	20.0	H	12.3	-	-	46.0	-	32.3	-	13.7	-
396.00	0.0	21.2	H	15.0	-	-	46.0	-	36.2	-	9.8	-
400.00	0.0	21.4	H	11.6	-	-	46.0	-	33.0	-	13.0	-
467.99	0.0	22.7	H	10.9	-	-	46.0	-	33.6	-	12.4	-
504.00	0.0	23.3	V	10.6	-	-	46.0	-	33.9	-	12.1	-
540.00	0.0	24.0	V	15.0	-	-	46.0	-	39.0	-	7.0	-
576.01	0.0	24.7	V	10.3	-	-	46.0	-	35.0	-	11.0	-
684.00	0.0	26.4	H	10.9	-	-	46.0	-	37.3	-	8.7	-
756.01	0.0	26.9	H	10.2	-	-	46.0	-	37.1	-	8.9	-
800.00	0.0	27.5	H	7.3	-	-	46.0	-	34.8	-	11.2	-
828.00	0.0	28.1	H	10.8	-	-	46.0	-	38.9	-	7.1	-

- Note : 1) The spectrum was checked from 30 MHz to 1000 MHz.
 2) The cable loss, amp. gain and antenna factor are included in the correction factor.
 3) The symbol of "<" means "or less".
 4) The symbol of ">" means "or greater".
 5) A sample calculation(QP/AV) was made at 67.15 MHz.
 $PA + CF + MR = 0.0 + 10.7 + 14.8 = 25.5$ (dBuV/m)
 PA : Peak to Average Factor (P-A Factor)
 CF : Correction Factor
 MR : Meter Reading

6) Measuring Instruments Setting :

Detector Function	Resolution Bandwidth	Video Bandwidth
Quasi-peak (QP)	120 kHz	--

A.10.2.3 Spurious Emissions in the frequency range above 1 GHz

Date : January 19, 2009
 Temp. : 20 °C Humi. : 35 %

Mode of EUT : All modulation modes of the same carrier frequency have been investigated and worst modulation mode for Channel(0ch : 2402 MHz, Packet Setting : DH5(GFSK)) has been listed.

Test Port : Enclosure

Frequency (GHz)	P-A Factor (dB)	Correction Factor (dB)	Polarization	Meter Reading (dBuV)		Limits (dBuV/m)		Emission Levels (dBuV/m)		Margins (dB)	
				AV	Peak	AV	Peak	AV	Peak	AV	Peak
1.2000	0.0	-2.1	H	35.5	53.0	54.0	74.0	33.4	50.9	20.6	23.1
1.6020	0.0	-0.3	H <	28.0 <	41.0	54.0	74.0 <	27.7 <	40.7 >	26.3 >	33.3
1.9330	0.0	1.4	V	32.7 <	41.0	54.0	74.0	34.1 <	42.4	19.9 >	31.6
4.8040	0.0	8.4	V <	28.0 <	41.0	54.0	74.0 <	36.4 <	49.4 >	17.6 >	24.6
7.2060	0.0	12.0	V <	28.0 <	41.0	54.0	74.0 <	40.0 <	53.0 >	14.0 >	21.0

Mode of EUT : All modulation modes of the same carrier frequency have been investigated and worst modulation mode for Channel(39ch : 2441 MHz, Packet Setting : DH5(GFSK)) has been listed.

Test Port : Enclosure

Frequency (GHz)	P-A Factor (dB)	Correction Factor (dB)	Polarization	Meter Reading (dBuV)		Limits (dBuV/m)		Emission Levels (dBuV/m)		Margins (dB)	
				AV	Peak	AV	Peak	AV	Peak	AV	Peak
1.2000	0.0	-2.1	H	35.5	53.0	54.0	74.0	33.4	50.9	20.6	23.1
1.6267	0.0	-0.2	H <	28.0 <	41.0	54.0	74.0 <	27.8 <	40.8 >	26.2 >	33.2
1.9330	0.0	1.4	V	32.7 <	41.0	54.0	74.0	34.1 <	42.4	19.9 >	31.6
4.8820	0.0	8.5	V <	28.0 <	41.0	54.0	74.0 <	36.5 <	49.5 >	17.5 >	24.5
7.3230	0.0	12.1	V <	28.0 <	41.0	54.0	74.0 <	40.1 <	53.1 >	13.9 >	20.9

Mode of EUT : All modulation modes of the same carrier frequency have been investigated and worst modulation mode for Channel(78ch : 2480 MHz, Packet Setting : DH5(GFSK)) has been listed.

Test Port : Enclosure

Frequency (GHz)	P-A Factor (dB)	Correction Factor (dB)	Polarization	Meter Reading (dBuV)		Limits (dBuV/m)		Emission Levels (dBuV/m)		Margins (dB)	
				AV	Peak	AV	Peak	AV	Peak	AV	Peak
1.2000	0.0	-2.1	H	35.5	53.0	54.0	74.0	33.4	50.9	20.6	23.1
1.6527	0.0	-0.1	H <	28.0 <	41.0	54.0	74.0 <	27.9 <	40.9 >	26.1 >	33.1
1.9330	0.0	1.4	V	32.7 <	41.0	54.0	74.0	34.1 <	42.4	19.9 >	31.6
4.9600	0.0	8.6	V <	28.0 <	41.0	54.0	74.0 <	36.6 <	49.6 >	17.4 >	24.4
7.4400	0.0	12.3	V <	28.0 <	41.0	54.0	74.0 <	40.3 <	53.3 >	13.7 >	20.7

- Note : 1) The spectrum was checked from 1.0 GHz to 26.5 GHz.
2) The cable loss, amp. gain and antenna factor are included in the correction factor.
3) The symbol of "<" means "or less".
4) The symbol of ">" means "or greater".
5) A sample calculation(Peak) was made at 1.200 GHz of the carrier frequency : 2402 MHz.
PA + CF + MR = 0.0 + (-2.1) + 53.0 = 50.9 (dBuV/m)
PA : Peak to Average Factor (P-A Factor)
CF : Correction Factor
MR : Meter Reading
6) Measuring Instruments Setting :

Detector Function	Resolution Bandwidth	Video Bandwidth
Average (AV)	1 MHz	10 Hz
Peak	1 MHz	1 MHz

A.11 AC Power Line Conducted Emissions for Transmitter

Not Applicable

A.12 RF Exposure Compliance

Not Applicable

COPY

A.13 Spurious Emissions for Receiver (Radiation)

A.13.1 Spurious Emissions in the frequency range from 30 MHz to 1000 MHz

Date : January 19, 2010
 Temp. : 20 °C Humi. : 35 %

Mode of EUT : All modes have been investigated and worst case mode for Channel (0ch : 2402 MHz) has been listed.

Test Port : Enclosure

Frequency (MHz)	P-A Factor (dB)	Correction Factor (dB)	Polarization	Meter Reading (dBuV)			Limits (dBuV/m)		Emission Levels (dBuV/m)		Margins (dB)	
				QP	AV	Peak	QP/AV	Peak	QP/AV	Peak	QP/AV	Peak
67.15	0.0	10.7	V	14.7	-	-	40.0	-	25.4	-	14.6	-
83.17	0.0	10.8	V	16.4	-	-	40.0	-	27.2	-	12.8	-
90.77	0.0	12.2	H	10.8	-	-	43.5	-	23.0	-	20.5	-
108.00	0.0	15.6	V	13.2	-	-	43.5	-	28.8	-	14.7	-
129.60	0.0	18.1	V	7.2	-	-	43.5	-	25.3	-	18.2	-
144.00	0.0	18.9	H	9.1	-	-	43.5	-	28.0	-	15.5	-
252.01	0.0	22.1	H	12.0	-	-	46.0	-	34.1	-	11.9	-
288.00	0.0	23.9	H	11.6	-	-	46.0	-	35.5	-	10.5	-
324.01	0.0	19.0	H	12.8	-	-	46.0	-	31.8	-	14.2	-
360.01	0.0	20.0	H	12.8	-	-	46.0	-	32.8	-	13.2	-
396.00	0.0	21.2	H	13.9	-	-	46.0	-	35.1	-	10.9	-
400.00	0.0	21.4	H	13.0	-	-	46.0	-	34.4	-	11.6	-
467.99	0.0	22.7	H	9.5	-	-	46.0	-	32.2	-	13.8	-
504.00	0.0	23.3	V	10.5	-	-	46.0	-	33.8	-	12.2	-
540.00	0.0	24.0	V	15.2	-	-	46.0	-	39.2	-	6.8	-
576.01	0.0	24.7	V	10.2	-	-	46.0	-	34.9	-	11.1	-
684.00	0.0	26.4	H	7.6	-	-	46.0	-	34.0	-	12.0	-
756.01	0.0	26.9	H	10.1	-	-	46.0	-	37.0	-	9.0	-
800.00	0.0	27.5	H	8.4	-	-	46.0	-	35.9	-	10.1	-
828.00	0.0	28.1	H	11.4	-	-	46.0	-	39.5	-	6.5	-

- Note : 1) The spectrum was checked from 30 MHz to 1000 MHz.
 2) The cable loss, amp. gain and antenna factor are included in the correction factor.
 3) The symbol of "<" means "or less".
 4) The symbol of ">" means "or greater".
 5) A sample calculation(QP/AV) was made at 67.15 MHz.
 $PA + CF + MR = 0.0 + 10.7 + 14.7 = 25.4$ (dBuV/m)
 PA : Peak to Average Factor (P-A Factor)
 CF : Correction Factor
 MR : Meter Reading

6) Measuring Instruments Setting :

Detector Function	Resolution Bandwidth	Video Bandwidth
Quasi-peak (QP)	120 kHz	--

A.13.2 Spurious Emissions in the frequency range above 1 GHz

Date : January 19, 2010
 Temp. : 19 °C Humi. : 43 %

Mode of EUT : RX Mode (0ch : 2402MHz)
 Test Port : Enclosure

Frequency (GHz)	P-A Factor (dB)	Correction Factor (dB)	Polarization	Meter Reading (dBuV)		Limits (dBuV/m)		Emission Levels (dBuV/m)		Margins (dB)	
				AV	Peak	AV	Peak	AV	Peak	AV	Peak
1.2000	0.0	-2.1	H	35.7	52.8	54.0	74.0	33.6	50.7	20.4	23.3
1.6023	0.0	-0.3	H <	28.0 <	41.0	54.0	74.0 <	27.7 <	40.7 >	26.3 >	33.3
1.9330	0.0	1.4	H	32.7 <	41.0	54.0	74.0	34.1 <	42.4	19.9 >	31.6
2.4035	0.0	2.0	H <	28.0 <	41.0	54.0	74.0 <	30.0 <	43.0 >	24.0 >	31.0

Mode of EUT : RX Mode (39ch : 2441MHz)
 Test Port : Enclosure

Frequency (GHz)	P-A Factor (dB)	Correction Factor (dB)	Polarization	Meter Reading (dBuV)		Limits (dBuV/m)		Emission Levels (dBuV/m)		Margins (dB)	
				AV	Peak	AV	Peak	AV	Peak	AV	Peak
1.2000	0.0	-2.1	H	35.7	52.8	54.0	74.0	33.6	50.7	20.4	23.3
1.6283	0.0	-0.3	H <	28.0 <	41.0	54.0	74.0 <	27.7 <	40.7 >	26.3 >	33.3
1.9330	0.0	1.4	H	32.7 <	41.0	54.0	74.0	34.1 <	42.4	19.9 >	31.6
2.4425	0.0	2.2	H <	28.0 <	41.0	54.0	74.0 <	30.2 <	43.2 >	23.8 >	30.8

Mode of EUT : RX Mode (78ch : 2480MHz)
 Test Port : Enclosure

Frequency (GHz)	P-A Factor (dB)	Correction Factor (dB)	Polarization	Meter Reading (dBuV)		Limits (dBuV/m)		Emission Levels (dBuV/m)		Margins (dB)	
				AV	Peak	AV	Peak	AV	Peak	AV	Peak
1.2000	0.0	-2.1	H	35.7	52.8	54.0	74.0	33.6	50.7	20.4	23.3
1.6543	0.0	-0.3	H <	28.0 <	41.0	54.0	74.0 <	27.7 <	40.7 >	26.3 >	33.3
1.9330	0.0	1.4	H	32.7 <	41.0	54.0	74.0	34.1 <	42.4	19.9 >	31.6
2.4815	0.0	2.3	H <	28.0 <	41.0	54.0	74.0 <	30.3 <	43.3 >	23.7 >	30.7

- Note : 1) The spectrum was checked from 1.0 GHz to 26.5 GHz.
2) The cable loss, amp. gain and antenna factor are included in the correction factor.
3) The symbol of "<" means "or less".
4) The symbol of ">" means "or greater".
5) A sample calculation(Peak) was made at 1.200 GHz of the carrier frequency : 2402 MHz.
PA + CF + MR = 0.0 + (-2.1) + 53.0 = 50.9 (dBuV/m)
PA : Peak to Average Factor (P-A Factor)
CF : Correction Factor
MR : Meter Reading
6) Measuring Instruments Setting :

Detector Function	Resolution Bandwidth	Video Bandwidth
Average (AV)	1 MHz	10 Hz
Peak	1 MHz	1 MHz

A.14 AC Power Line Conducted Emissions for Receiver

Not Applicable

Appendix B : Test Arrangement (Photographs)**B.1 Radiated Emissions**

- Front View -

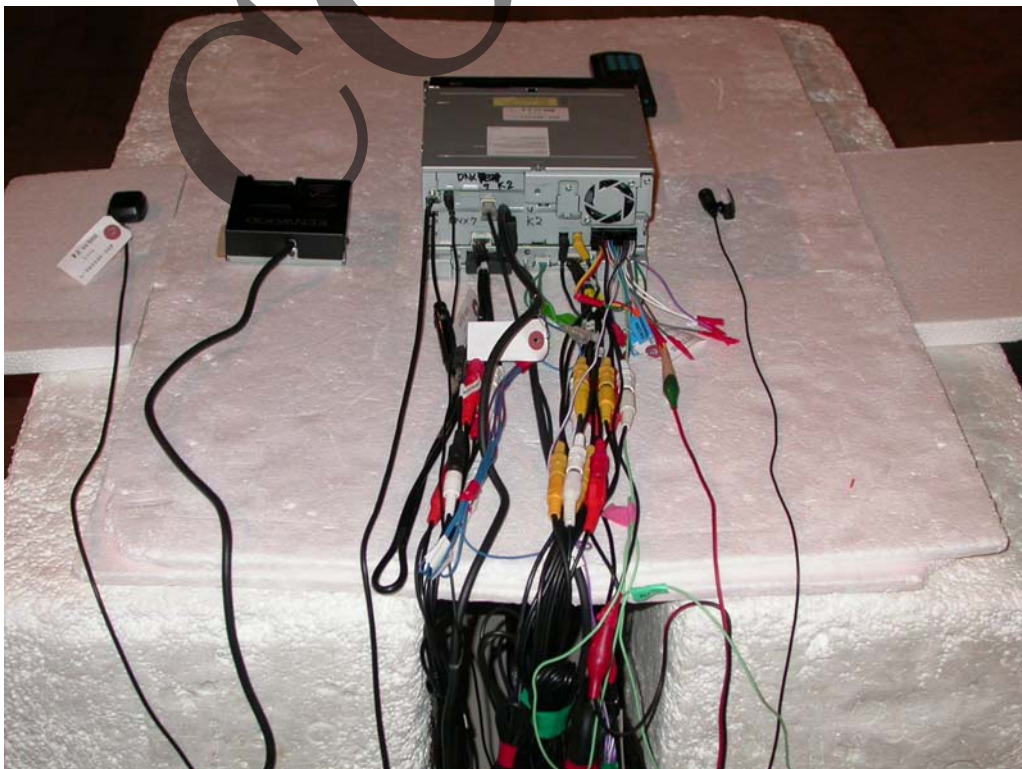

- Rear View -

Photograph present configuration with maximum emission



- Right Side View -

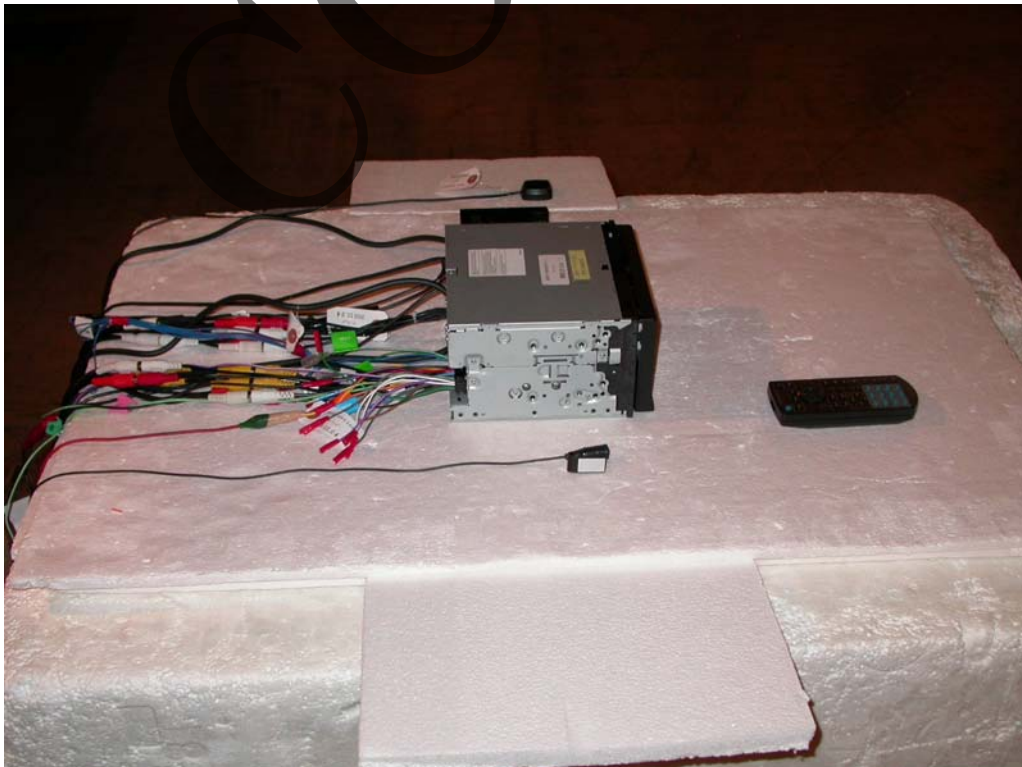

- Left Side View -

Photograph present configuration with maximum emission

B.2 AC Power Line Conducted Emissions

Not Applicable

COPY

Appendix C : Test Instruments

02-Feb-2010

No	Type	Model	Manufacturer	Serial	ID	Last Cal.	Interval
Test Facilities:							
1	Anechoic Chamber A	-	TDK	-	800-01-502E0	Apr 2009	1 Year
2	Anechoic Chamber B	-	TDK	-	800-01-503E0	Apr 2009	1 Year
3	Shield Room A	-	TDK	-	800-01-501E0	-	-
4	Shield Room B	-	Ray Proof	-	800-01-010E0	-	-
5	Shield Room C	-	TDK	-	800-01-504E0	-	-
6	Shield Room D	-	Emerson	-	800-01-022E0	-	-
7	Shield Room E	-	TDK	-	800-01-505E0	-	-

Measuring Instruments:

10	Test Receiver	ESHS10	Rohde & Schwarz	835871/004	119-01-505E0	May 2009	1 Year
11	Test Receiver	ESVS10	Rohde & Schwarz	826148/002	119-03-504E0	Jun 2009	1 Year
12	Test Receiver	ESVS10	Rohde & Schwarz	832699/001	119-03-506E0	Sep 2009	1 Year
13	Test Receiver	ESI26	Rohde & Schwarz	100043	119-04-511E0	Oct 2009	1 Year
14	Spectrum Analyzer	R3182	Advantest	120600581	122-02-521E0	Mar 2009	1 Year
19	Spectrum Analyzer	R3132	Advantest	120500072	122-02-520E0	May 2009	1 Year
20	Spectrum Analyzer	R3132	Advantest	150400998	122-02-523E0	Jul 2009	1 Year
65	Power Meter	436A	Hewlett Packard	1725A01930	100-02-501E0	Apr 2009	1 Year
66	Power Sensor	8482A	Hewlett Packard	1551A01013	100-02-501E0	Apr 2009	1 Year
68	FM Linear Detector	MS61A	Anritsu	M77486	123-02-008E0	Oct 2009	1 Year
69	Level Meter	ML422C	Anritsu	M87571	114-02-501E0	Jun 2009	1 Year
70	Measuring Amplifier	2636	B & K	1614851	082-01-502E0	May 2009	1 Year
75	Frequency Counter	53131A	Hewlett Packard	3546A11807	102-02-075E0	May 2009	1 Year
83	FFT Analyzer	R9211C	Advantest	02020253	122-02-506E0	Jun 2009	1 Year
84	Noise Meter	MN-446	Meguro	53030478	082-01-144E0	Apr 2009	1 Year
163	Digital Oscilloscope	54502A	Hewlett Packard	2934A05573	121-02-502E0	May 2009	1 Year
165	Multimeter	VOAC7413	Iwatsu Electric	0267973	114-02-502E0	Apr 2009	1 Year
172	Test Receiver	ESCI	Rohde & Schwarz	100408	119-04-512E0	Oct 2009	1 Year
210	Peak Power Meter	ML2495A	Anritsu	0836023	100-02-507E0	Nov 2009	1 Year
211	Power Sensor	MA2491A	Anritsu	0811206	100-02-507E0	Nov 2009	1 Year
212	Power Sensor	MA2411B	Anritsu	0738312	100-02-507E0	Nov 2009	1 Year
230	Spectrum Analyzer	U3751	Advantest	150800116	122-02-003T	Feb 2009	1 Year
232	Digital Oscilloscope	TDS3052C	Tektronix, Inc.	C010708	121-02-504E0	Jun 2009	1 Year

Antennas:

21	Loop Antenna	HFH2-Z2	Rohde & Schwarz	881058/62	119-05-033E0	Jul 2009	1 Year
234	Dipole Antenna	KBA-511A	Kyoritsu	0-316-5	119-05-123E0	Nov 2009	2 Year
235	Dipole Antenna	KBA-611	Kyoritsu	0-317-3	119-05-124E0	Nov 2009	2 Year
27	Biconical Antenna	BBA9106	Schwarzbeck	-	119-05-078E0	Nov 2008	1 Year
28	Log-periodic Antenna	UHALP9107	Schwarzbeck	-	119-05-079E0	Nov 2008	1 Year
31	Horn Antenna	3115	EMC Test Systems	6442	119-05-514E0	Jan 2010	2 Year
32	Horn Antenna	3116	EMC Test Systems	2547	119-05-515E0	Jun 2009	2 Year
167	Biconical Antenna	BBA9106	Schwarzbeck	VHA91032325	119-05-520E0	Jun 2009	1 Year
168	Log-periodic Antenna	UHALP9108A	Schwarzbeck	0666	119-05-521E0	Jun 2009	1 Year
169	Biconical Antenna	BBA9106	Schwarzbeck	VHA91032399	119-05-522E0	Jun 2009	1 Year
170	Log-periodic Antenna	UHALP9108A	Schwarzbeck	0724	119-05-523E0	Jun 2009	1 Year
198	Log-periodic Antenna	HL050	Rohde & Schwarz	100251	119-05-524E0	Sep 2009	1 Year
225	Loop Sensor/Radiating Loop	F55103-2-0.13M	FCC	03018	119-05-516E0	-	-
236	Horn Antenna	3160-03	EMC Test Systems	00078687	119-05-525E0	Oct 2008	2 Year
237	Horn Antenna	3160-08	EMC Test Systems	00026081	119-05-517E0	Jan 2008	2 Year
238	Horn Antenna	3160-09	EMC Test Systems	00023883	119-05-518E0	May 2009	2 Year
239	Horn Antenna	3160-10	EMC Test Systems	00026026	119-05-519E0	Jul 2009	2 Year

02-Feb-2010

No	Type	Model	Manufacturer	Serial	ID	Last Cal.	Interval
<u>Cables:</u>							
38	RF Cable	5D-2W	Fujikura	-	155-21-001E0	Feb 2009	1 Year
39	RF Cable	5D-2W	Fujikura	-	155-21-002E0	Feb 2009	1 Year
40	RF Cable	3D-2W	Fujikura	-	155-21-005E0	Apr 2009	1 Year
41	RF Cable	3D-2W	Fujikura	-	155-21-006E0	Apr 2009	1 Year
42	RF Cable	3D-2W	Fujikura	-	155-21-007E0	Apr 2009	1 Year
43	RF Cable	RG213/U	Rohde & Schwarz	-	155-21-010E0	Apr 2009	1 Year
44	RF Cable(10m)	S 04272B	Suhner	-	155-21-011E0	May 2009	1 Year
45	RF Cable(1.5m 18GHz)	S 04272B	Suhner	-	155-21-012E0	May 2009	1 Year
46	RF Cable(1m 18GHz)	SUCOFLEX10	Suhner	-	155-21-013E0	May 2009	1 Year
47	RF Cable(1m N)	S 04272B	Suhner	-	155-21-015E0	Jun 2009	1 Year
48	RF Cable(1m 26GHz)	SUCOFLEX 104E	Suhner	14543/4E	155-21-016E0	Dec 2009	1 Year
49	RF Cable(4m 26GHz)	SUCOFLEX10	Suhner	190630	155-21-017E0	Dec 2009	1 Year
50	RF Cable(10m)	F130-S1S1-394	MEGA PHASE	10510	155-21-018E0	Dec 2009	1 Year
51	RF Cable(5m)	3D-2W	Fujikura	-	155-21-009E0	Apr 2009	1 Year
52	RF Cable(7m)	RG223/U	Suhner	-	155-21-021E0	May 2009	1 Year
195	RF Cable(10m)	F130-S1S1-394	MEGA PHASE	20051	155-21-020E0	Apr 2009	1 Year
240	RF Cable(3m 40GHz)	KPS-1501- 1181-KPS	Insulated Wire Inc.	11292001	155-21-019E0	Jan 2010	1 Year
241	RF Cable(6m 40GHz)	SUCOFLEX 102E	Suhner	6257/2E	155-21-024E0	Oct 2009	1 Year
<u>Networks:</u>							
33	LISN	KNW-407	Kyoritsu	8-833-6	149-04-052E0	Nov 2009	1 Year
34	LISN	KNW-407	Kyoritsu	8-855-2	149-04-055E0	May 2009	1 Year
35	LISN	KNW-407	Kyoritsu	8-1130-6	149-04-062E0	May 2009	1 Year
36	LISN	KNW-242C	Kyoritsu	8-837-13	149-04-054E0	Apr 2009	1 Year
37	Absorbing Clamp	MDS21	Luthi	03293	119-06-506E0	Aug 2009	1 Year
164	LISN	KNW-403D	Kyoritsu	8-1474-3	149-04-059E0	Apr 2009	1 Year
173	Pulse Limiter	ESH3-Z2	Rohde & Schwarz	-	156-01-501E0	Apr 2009	1 Year
174	Pulse Limiter	ESH3-Z2	Rohde & Schwarz	-	156-01-502E0	Apr 2009	1 Year
175	Pulse Limiter	ESH3-Z2	Rohde & Schwarz	-	156-01-503E0	Apr 2009	1 Year
194	High Impedance Probe	HP-2	JQA	001	149-06-503E0	Oct 2009	1 Year
248	High Impedance Probe	KNW-411	Kyoritsu	8-2071-2	149-06-504E0	Feb 2010	1 Year
<u>Amplifiers:</u>							
53	AF Amplifier	P-500L	Accuphase	BOY806	127-01-501E0	Feb 2009	1 Year
54	RF Amplifier	WJ-6882-814	Watkins-Johnson	0414	127-04-017E0	Jun 2009	1 Year
55	RF Amplifier	WJ-5315-556	Watkins-Johnson	106	127-04-006E0	Jun 2009	1 Year
56	RF Amplifier	WJ-5320-307	Watkins-Johnson	645	127-04-005E0	Jun 2009	1 Year
57	RF Amplifier	JS4-00102600- 28-5A	MITEQ	669167	127-04-502E0	Apr 2009	1 Year
226	Differential Amplifier	5303	NF	155726- 5305046	127-01-502E0	Apr 2009	1 Year

02-Feb-2010

No	Type	Model	Manufacturer	Serial	ID	Last Cal.	Interval
Generators:							
58	Function Generator	3325B	Hewlett Packard	2847A03284	118-08-124E0	Jul 2009	1 Year
59	Function Generator	VP-7422A	Matsushita Communication	050351E122	118-08-503E0	Jul 2009	1 Year
60	Signal Generator	8664A	Hewlett Packard	3035A00140	118-03-014E0	May 2009	1 Year
61	Signal Generator	8664A	Hewlett Packard	3438A00756	118-04-502E0	May 2009	1 Year
62	Signal Generator	6061A	Gigatronics	5130593	118-04-024E0	Mar 2009	1 Year
171	Signal Generator	SML03	Rohde & Schwarz	102651	118-04-509E0	Feb 2009	1 Year
222	Signal Generator	8673D	Hewlett Packard	2938A00988	118-04-015E0	Jul 2009	2 Year
Others:							
63	Termination(50)	-	Suhner	-	154-06-501E0	Jan 2010	1 Year
64	Termination(50)	-	Suhner	-	154-06-502E0	Jan 2010	1 Year
71	Microphone	4134	B & K	1253497	147-01-502E0	May 2009	1 Year
72	Preamplifier	2639	B & K	1268763	127-01-504E0	-	-
73	Pistonphone	4220	B & K	1165008	147-02-501E0	Mar 2009	1 Year
74	Artificial Mouth	4227	B & K	1274869	-	-	-
76	Oven	-	Ohnishi	-	023-02-018E0	-	-
77	DC Power Supply	6628A	Hewlett Packard	3224A00284	072-05-503E0	Jun 2009	1 Year
78	Band RejectFilter	BRM12294	Micro-tronics	003	149-01-501E0	Jan 2010	1 Year
79	High Pass Filter	F-100-4000-5-R	RLC Electronics	0149	149-01-502E0	Feb 2009	1 Year
80	Attenuator	43KC-10	Anritsu	-	148-03-506E0	Feb 2009	1 Year
81	Attenuator	43KC-20	Anritsu	-	148-03-507E0	Feb 2009	1 Year
82	Attenuator	355D	Hewlett Packard	219-10782	148-03-065E0	Apr 2009	1 Year
85	RF Detector	75KC-50	Anritsu	305002	100-02-506E0	Jul 2009	1 Year
200	Artificial Hand	AH-1	ES Factory	001	155-07-561E0	Jul 2009	1 Year
201	Barometer	TYPE6	Yanagi	16076	209-02-014E0	Feb 2008	2 Year
202	Thermo-Hygrometer	-	Empex	-	141-01-504E0	Mar 2008	2 Year
203	Thermo-Hygrometer	EX-2727	Empex	-	141-01-505E0	Mar 2008	2 Year
204	Thermo-Hygrometer	EX-2727	Empex	-	141-01-506E0	Mar 2008	2 Year
205	Thermo-Hygrometer	EX-2727	Empex	-	141-01-507E0	Mar 2008	2 Year
206	Low Pass Filter	LPM13323	Micro-tronics	001	149-01-505E0	Jul 2009	1 Year
207	High Pass Filter	HPM13321	Micro-tronics	001	149-01-506E0	Jul 2009	1 Year
208	High Pass Filter	HPM13322	Micro-tronics	001	149-01-507E0	Jul 2009	1 Year
242	Power Divider	1575	Aeroflex Weischel	1153	086-02-501E0	Oct 2009	1 Year
243	Power Divider	1575	Aeroflex Weischel	1157	086-02-502E0	Oct 2009	1 Year
244	Power Divider	1575	Aeroflex Weischel	1161	086-02-503E0	Oct 2009	1 Year