

JTS[®]

UF-10R / UF-10TH / UF-10TB
Professional Wideband (60~75MHz)
True Diversity System

JTS[®] PROFESSIONAL CO., LTD
No.148, Gongye 9th Rd., Dali Dist., Taichung
City 41280, Taiwan (R.O.C.)
Tel: 886-4-24938803 Fax: 886-4-24914890
Email: jts@jts.com.tw
www.jts.com.tw

FC CE 1856     **RoHS**
conform

59508-040-01

UF-10R **UF-10TB**
UHF PLL **UF-10TH**

Product manual

One year product warranty

Product Model		Equipment serial number	
Customer name		Contact number	
Address			
Purchase date			
Selling store stamp	Be sure to put store stamp and fill in purchase date for the warranty to be effective!		

Warranty description

1. Be sure to put the warranty label indicating purchase date on the bottom of equipment to ensure your interest in maintenance and service.
2. Product warranty, starting on the purchase date indicated on “warranty label”, will last for one year; if the equipment does not have “warranty label”, the warranty period is 15 months from the manufacturing date. If a microphone is broken but not sent back with the equipment, the warranty period is 15 months from the manufacturing date of the microphone.
3. Within the warranty period, if the equipment is broken under normal use as instructed in manual, please contact the original selling store for repair.
4. When the product is returned for repair, to facilitate proper determination of cause of malfunction and of whether repair fee is needed, please ship back the equipment and microphone together.
5. Within the warranty period, our company provides repair service at no cost except for the following conditions that parts and repair may be charged:
 - a. Damages due to natural disaster or irresistible outside forces.
 - b. Damages due to drop, water, moisture, corrosion, foreign objects, missing components.
 - c. The warranty does not cover consumable parts. (such as microphone capsule, ball grille etc.)
 - d. Those without “warranty label” on equipment or with “warranty label” being damaged and failing to identify warranty period.
6. Please keep the warranty properly. No replacement will be made if the warranty is missing.

INDEX

1. System operation instructions	1
2. Features	1
2-1 Receiver// UF-10R	1
2-2 Handheld Transmitter // UF-10TH	2
2-3 Body-Pack Transmitter // UF-10TB	2
3. Specification	3
3-1 Receiver// UF-10R	3
3-2 Handheld Transmitter // UF-10TH	4
3-3 Body-Pack Transmitter // UF-10TB	4
3-4 Optional Condenser Microphone	5
4. Parts Identification & Accessories	8
4-1 Receiver // UF-10R	8
4-2 Handheld Transmitter // UF-10TH	11
4-3 Body-Pack Transmitter // UF-10TB	12
4-4 Optional Condenser Microphone	13
4-5 Accessories	17
5. Connection method	18
6. Operation	21
6-1 Receiver// UF-10R	21
6-2 Handheld Transmitter // UF-10TH	30
6-3 Body-Pack Transmitter // UF-10TB	35
6-4 Installation of Condenser Microphones	40
7. Product notes	42
8. Important Notice	43

1. System operation instructions

- Before connecting to power, make sure the voltage marked on equipment is the same as that on the power socket.
- Do not place the equipment in damp and hot environment.
- Prior to operation, please dry your hands.
- Keep the equipment away from fire and heat source.
- Transmitter and receiver need to be adjusted to the same “default channel” or “frequency”.

2. Features

2-1 UHF PLL Broadband true diversity receiver // UF-10R

The UF-10 Wide Band Wireless Microphone System uses the latest wireless technology can be found. Up to 75 MHz bandwidth benefits multi system application. JTS patented REMOSET provides great convenience to project set up. Various advanced features assure a successful performance.

- UHF PLL True Diversity System renders 200 to 480 meters of operation distance.
- Maximum 2400 to 3000 selectable frequencies across 60~75 MHz.
- Maximum 12 groups, each provides maximum 60 channels. (figures vary according to frequency band)
- Provide 6 user-built groups, maximum 64 channels for each group.
- Automatic search function for available frequency.
- JTS patented **REMOSET**® function, one press key allows instant synchronous setup for transmitter.
- Adjustable squelch level.
- JTS LCX circuit design technology effectively reduces noise interference
- Come with antenna booster power, compatible with various external antennas.

2-2 UHF PLL Handheld transmitter // UF-10TH

- Maximum 2400 to 3000 selectable frequencies across 60~75 MHz.
- Phase-locked loop circuit design.
- Extended dynamic range and smooth frequency response.
- Tone key squelch.
- Replaceable condenser or dynamic capsule module.
- Hidden antenna design.
- Lock-On function prevents signal interruption due to accidental change.
- Adjustable transmission power between 10mW and 50 mW.

2-3 UHF PLL Body-Pack Transmitter // UF-10TB

- Maximum 2400 to 3000 selectable frequencies across 60~75 MHz.
- Phase-Locked Loop (PLL) synthesized tuner.
- Extended dynamic range and smooth frequency response.
- Adjustable transmission power
- Tone-key squelch
- The “lock-on” function mode prevents tampering and RF interruption.
- 4 pin mini XLR connector compatible with guitar cable and various vocal and instrument mics.
- Adjustable transmission power between 10 mW and 50 mW

3. Specification

3-1 UHF PLL Broadband true diversity receiver // UF-10R

Frequency oscillation mode	PLL Synthesized Control
REMASET.....	Radio Frequency
Carrier frequency range.....	502~960 MHz
Signal to noise ratio.....	> 105dB
Total distortion rate.....	<0.6%@1KHz
Function display method.....	LCD and LED
Function display content.....	Channel , Group , Antenna A/B , Mute , AF/RF , Low battery , Device ID
Control method.....	ON/OFF , Frequency (up/down) , Available frequency scan , Volume , Jog dial , ID pairing , REMASET , Squelch level
Audio output level.....	-12dB
Audio output impedance.....	600Ω
Mute method.....	Pilot tone and noise mute
Power supply.....	+15 VDC , 1000 mA
Output type.....	1 balanced XLR connector 1 balanced Ø6.3mm connector
Size(m/m).....	212mm (Width) * 44mm (Height) * 213.9mm (Length)

3-2 UHF PLL Handheld transmitter // UF-10TH

Frequency oscillation mode	PLL Synthesized Control
Carrier frequency range.....	502~960MHz
RF output.....	10mW/50mW (Depend on Local Regulation)
Stability.....	< ±10KHz
Frequency drift.....	±48KHz
LCD.....	Frequency (up/down), Power indicator, Device ID
Control method.....	Power switch, AF, Frequency (up/down), Lock-On, ID pairing
Spurious Emissions.....	< -50dBC
Frequency response.....	50~16,500Hz
Battery type.....	UM3, AA 1.5V*2

3-3 UHF PLL Body-Pack Transmitter // UF-10TB

Frequency Preparation.....	PLL Synthesized Control
Carrier Frequency Range.....	502~960 MHz
RF Outputs.....	10mW / 50mW (Depend on Local Regulation)
Stability.....	< ±10KHz
Frequency Deviation.....	±48KHz
LCD Display.....	User name, Group, Channel, Frequency, Battery Fuel Gauge, Sensitivity
Controls.....	Power On/Off, AF Level, Frequency Up/Down, Lock-on Mode, ID Pairing
Spurious Emissions.....	<- 50 dBC
Audio Frequency Response....	50~16,500 Hz
Battery.....	UM3, AA 1.5V*2

3-4 Optional Condenser Microphone

Lavaliere Microphone

Model No.....	CM-501	CM-201	CM-125
Connector.....	4P Mini XLR	4P Mini XLR	4P Mini XLR
Frequency Response.....	100~15,000 Hz	60~15,000 Hz	50~18,000 Hz
Polar Pattern.....	Cardioid	Omni-directional	Omni-directional
Sensitivity (at 1000Hz)	-60±3 dB	-60±3 dB	-53±3 dB
Impedance.....	2.2kΩ	2.2kΩ	4.4kΩ
Max. SPL for 1% THD	130dB	130dB	130dB
Dimension(mm).....	Ø10.1mm(W) * 26.4mm(H)	Ø5mm(W) * 9mm(H)	Ø4mm(W) * 11mm(H)
Net Weight.....	21.5g	20.7g	7g (cable excluded)

Headset Microphone

Model No.....	CM-214	CM-214U	CM-214UL
Connector.....	4P Mini XLR	4P Mini XLR	801C3 (3 pin mini XLR) 801C4 (4 pin mini XLR) 801CS (3.5 stereo plug)
Frequency Response.....	60~15,000 Hz	30~18,000 Hz	100 ~ 18,000Hz
Polar Pattern.....	Omni-directional	Cardioid	Cardioid
Sensitivity (at 1000Hz)	-60±3 dB	-68±3 dB	-75±3 dB
Impedance.....	2.2kΩ	680Ω	1.5kΩ
Max. SPL for 1% THD	130dB	130dB	120dB
Dimension(mm).....	125mm(W) * 134mm(H) * 157mm(D)	205mm(W) * 134mm(H) * 157mm(D)	125mm(W) * 134mm(H) * 157mm(D)
Net Weight.....	32.9g	38.4g	18g (cable excluded)

Model No.....	CM-235	CX-504
Connector.....	4P Mini XLR	4P Mini XLR
Frequency Response.....	50~18,000 Hz	30~18,000 Hz
Polar Pattern.....	Omni-directional	Cardioid
Sensitivity (at 1000Hz)	-53±3 dB	-68±3 dB
Impedance.....	4.4kΩ	680Ω
Max. SPL for 1% THD	130dB	130dB
Dimension(mm).....	155mm(W) * 134mm(H) * 157mm(D)	285mm(W) * 55mm(H) * 111.3mm(D)
Net Weight.....	17g (cable excluded)	56.3g

Ear-hook Microphone

Model No.....	CM-801/CM-804i	CM-8015/CM-825i
Connector.....	801C4 (4 pin mini XLR)	801C4 (4 pin mini XLR)
Option Connector.....	801C3 (3 pin mini XLR)	801C3 (3 pin mini XLR)
	801CS (3.5 stereo plug)	801CS (3.5 stereo plug)
Frequency Response.....	60~15,000 Hz	50~18,000 Hz
Polar Pattern.....	Omni-directional	Omni-directional
Sensitivity (at 1000Hz)	-64±3 dB	-53±3 dB
Impedance.....	1.8kΩ	1.2kΩ
Max. SPL for 1% THD	130dB	130dB

Compatible Instrument Microphone

Model No.....	CX-500	CX-500F	CX-520
Connector.....	4P Mini XLR	4P Mini XLR	4P Mini XLR
Frequency Response.....	20~20,000 Hz	50~18,000 Hz	50~18,000 Hz
Polar Pattern.....	Omni-directional	Omni-directional	Supercardioid
Sensitivity (at 1000Hz)	-58±3dB	-58±3dB	-78±3dB
Impedance.....	1.5kΩ	1.5kΩ	600Ω
Max. SPL for 1% THD	130 dB	130 dB	148 dB
Good For.....	Violin	Flutes	Harmonica

Model No.....	CX-508W	CX-516W
Connector.....	4P Mini XLR	4P Mini XLR
Frequency Response.....	50~18,000 Hz	30~18,000 Hz
Polar Pattern.....	Cardioid	Cardioid
Sensitivity (at 1000Hz)	-67±3 dB	-67±3 dB
Impedance.....	220Ω	220Ω
Max. SPL for 1% THD	130 dB	130 dB
Good For.....	Winds	Accordion

4. Parts Identification & Accessories



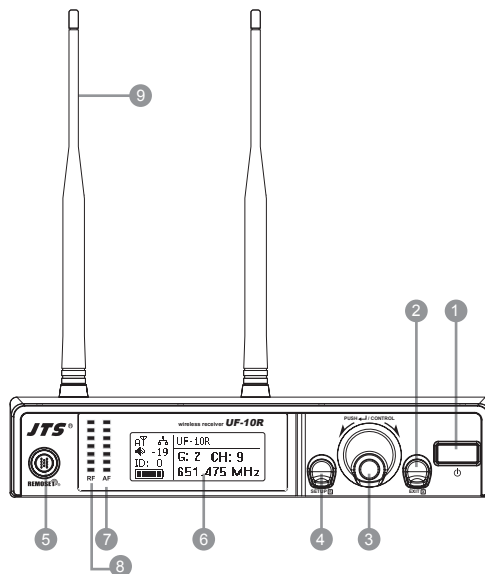

4-1 Broadband true diversity receiver key function and LCD description//UF-10R

(1) Front panel

- 1 Power switch: press switch once to turn power on; press and hold for 2 seconds to shut down.
- 2 EXIT key: when UF-10R is under “setup menu”, press EXIT to cancel selection or leave menu.
- 3 Jog dial: when main menu is on screen, turn jog dial to adjust volume (MUTE, -31~0dB); on “setup menu” screen, turn jog dial to select setup item, after entering into the selected item turn jog dial to adjust the value.
- 4 SETUP key: press and hold for 2 seconds to enter “setup menu”; press SETUP key to enter into setup mode for jog dial; after adjustment of value, press SETUP key to save the setting.
- 5 REMOSET: Press REMOSET once to send frequency data to a microphone.
- 6 LCD: refer to “(2) Receiver LCD instruction”.
- 7 AF: indicate current audio signal strength.
- 8 RF: indicate current radio frequency signal strength.
- 9 Antenna: 1/2 wave length antenna.



(2) Receiver LCD instruction

- ⑩  : indicate key lock is set (Key lock on).
- ⑪  : show antenna A or B is receiving signal; signal is not received .
- ⑫  - 19 : indicate current receiver volume.
- ⑬ ID: 0 : indicate device ID setting; ID number 0~255.
- ⑭  : indicate transmitter battery level; if no RF signal is received **MUTE** will show up.
- ⑮ G: indicate current Group, 1~13
CH: indicate current Channel, CH1~63
Frequency indication: current operation frequency

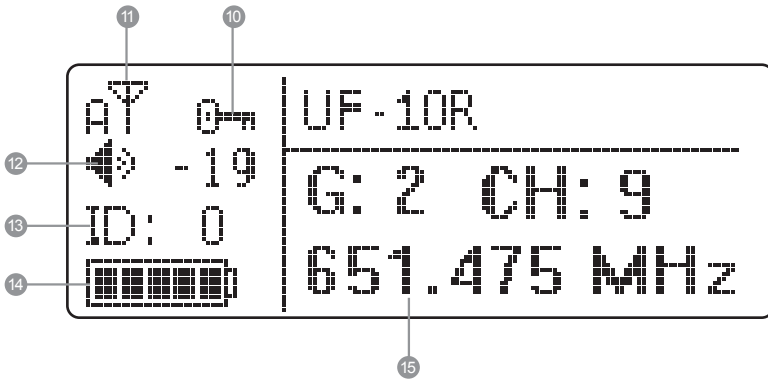

(3) Rear panel

- 16 Power receptacle: connect to power supply (DC15V/1000mA)
- 17 Balanced XLR MIC output
- 18 ϕ 6.3mm balanced output
- 19 BNC antenna socket: ANT 1 and ANT 2, set antennas vertical or sloping for better reception.

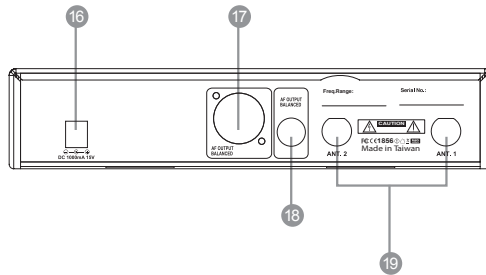

Note: select MIC or LINE audio output difference:

From setup menu, set "7. OUTPUT LEVEL":

Set Line: Output level of XLR MIC output and ϕ 6.3mm are identical

Set Mic: XLR MIC output level is lower than ϕ 6.3mm output by "-20dB"

4-2 UHF PLL handheld transmitter key function and LCD description // UF-10TH

- ⑳ LCD
- ㉑ Power key:
 - Turn on power: press power key once
 - Shut down power: press and hold power key for 2 seconds
 - Mute mode: during use, press power key once to mute the microphone, press it again to release
- ㉒ ▲ , ▼ : up and down keys, select setup item
- ㉓ SET: set up and save data
- ㉔ Mute/REMOSET indicator lamp:
 - Mute mode: red light flashes
 - REMOSET successful: blue light on for 5 seconds
- ㉕ Battery compartment

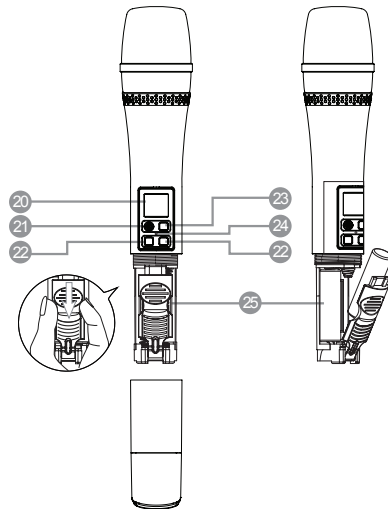

For screen display and operation please refer to “6-2. System operation setup for handheld transmitter”.

4-3 UHF PLL Body-Pack Transmitter // UF-10TB

- 26 LCD
- 27 Battery
 - Low Battery Indicator: when battery lever is low this red LED will light on constantly.
 - Note: when switch on the unit the red LED will light on for 1 second and turn off.
- 28 AF Peak and Mute Indicator
 - AF PEAK: Orange
 - Mute mode: Red light flashes
- 29 Power Key
 - (1) Turn on power: press power key once
 - (2) Shut down power: press and hold Power Key for 2 seconds
 - (3) Mute mode: during use, press Power Key once to mute the microphone, press it again to release.
 - (4) Leave the setting window: press the power key once the LCD display will return to the main window.
- 30 ▲ , ▼ : up and down keys, select setup item
- 31 SET : set up and save data
- 32 User Name
- 33 Indicate current Group and current Channel
- 34 Current operation frequency
- 35 Battery status: display battery status
- 36 Microphone sensitivity

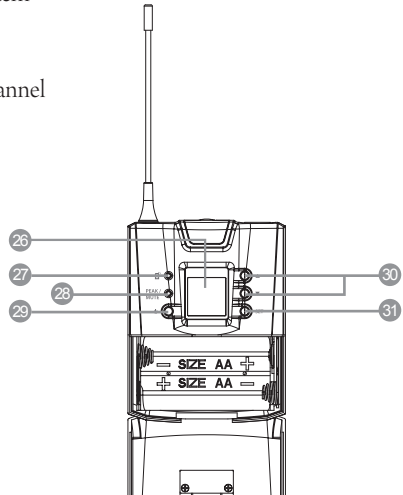
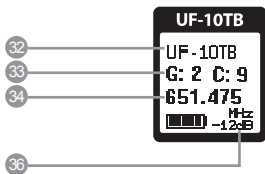

For screen display and operation please refer to “6-3. System operation setup for Body-Pack transmitter”.

4-4 Optional Condenser Microphone

Lavaliere Microphone // CM-501 / CM-201 / CM-125

- 37 Clip
- 38 4 Pin Mini XLR
- 39 Windscreen

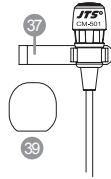
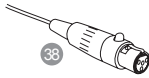

CM-501

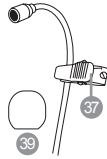

CM-201

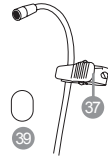

CM-125

Headset Microphone // CM-214 / CM-214U / CM-214UL / CM-235 / CX-504

- 40 Gooseneck
- 41 Adjustable headband
- 42 Headband
- 43 4 Pin Mini XLR
- 44 Windscreen

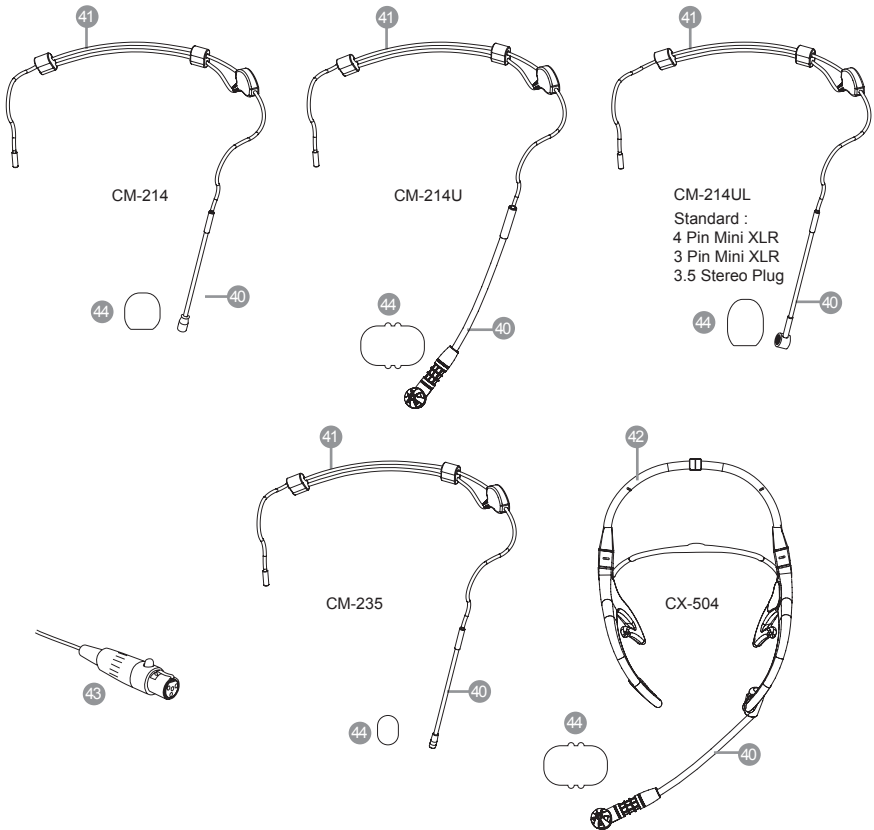

Ear-hook Microphone // CM-801 / CM-804i / CM-8015 / CM-825i

- 45 Boom
- 46 Adjustable Headband
- 47 Adjustable ear hook
- 48 Detchable Cable
- 49 Cable Clip
- 50 Windscreen
- 51 4 Pin Mini XLR
- 52 3 Pin Mini XLR **Option**
- 53 3.5 Stereo Plug **Option**

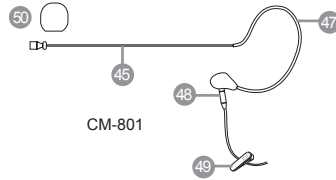
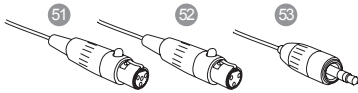

CM-801

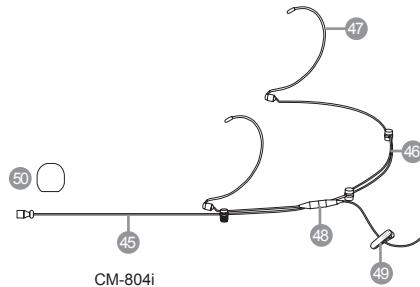

CM-804i

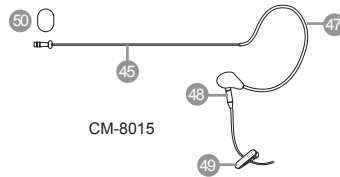

CM-8015

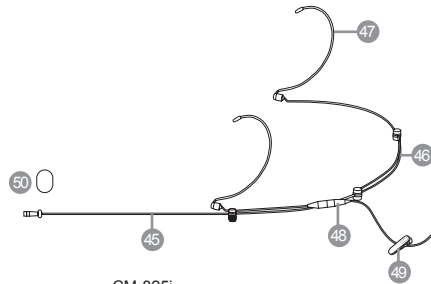

CM-825i

Compatible Instrument Microphone // CX-500 / CX-500F / CX-520 /
CX-508W / CX-516W

- 54 Gooseneck
- 55 Clip
- 56 Bracket
- 57 Volume Control
- 58 Windscreen
- 59 4 Pin Mini XLR

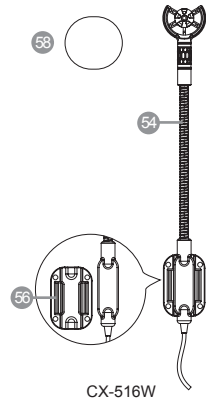
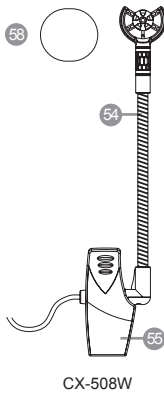
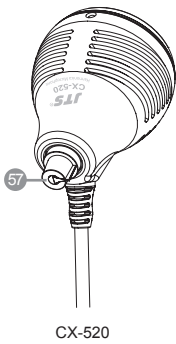
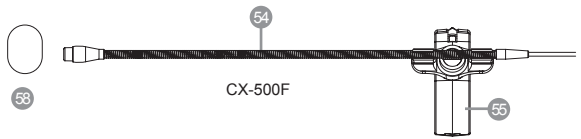
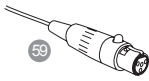
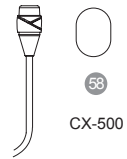

4-5 Accessories

- 60 AC/DC power adapter:
Switching power adapter
AC IN: AC100~240V/50~60Hz
DC OUT: DC15V/1000 mA
- 61 Audio cable
- 62 Rack mount kit//RM-10 (optional)
 - A RM-10E
 - B RM-10M
- 63 Rack mount kit//RM-901 (optional)

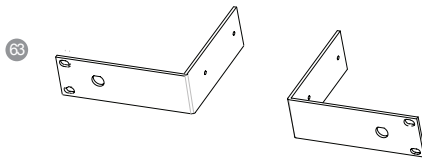
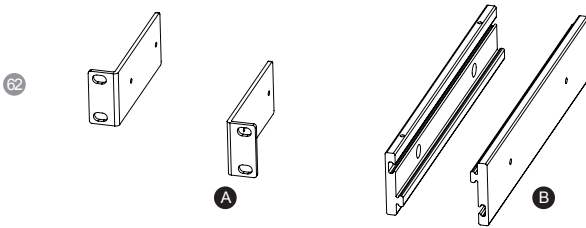
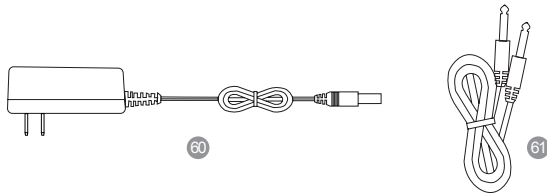

5. Connection method

Receiver connection method

1. UF-10R output to a mixer or an amplifier:

Audio cable: XLR or ϕ 6.3mm audio cable, one end connects to audio output of UF-10R “AF OUTPUT BALANCED”, while the other end connects to audio input of a mixer or an amplifier.

2. Connect to power

Connect to AC/DC adapter: one end connects to receiver “DCV INPUT”, while the other end connects to AC power receptacle.

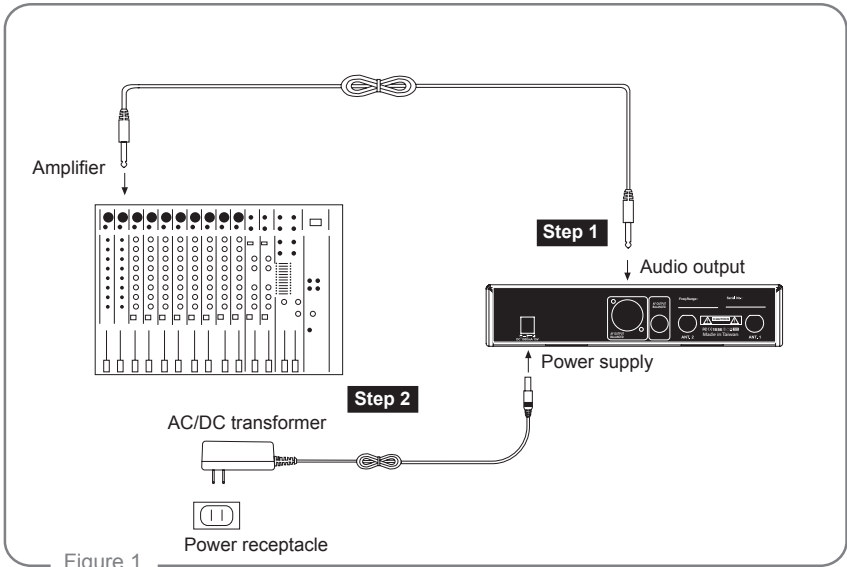
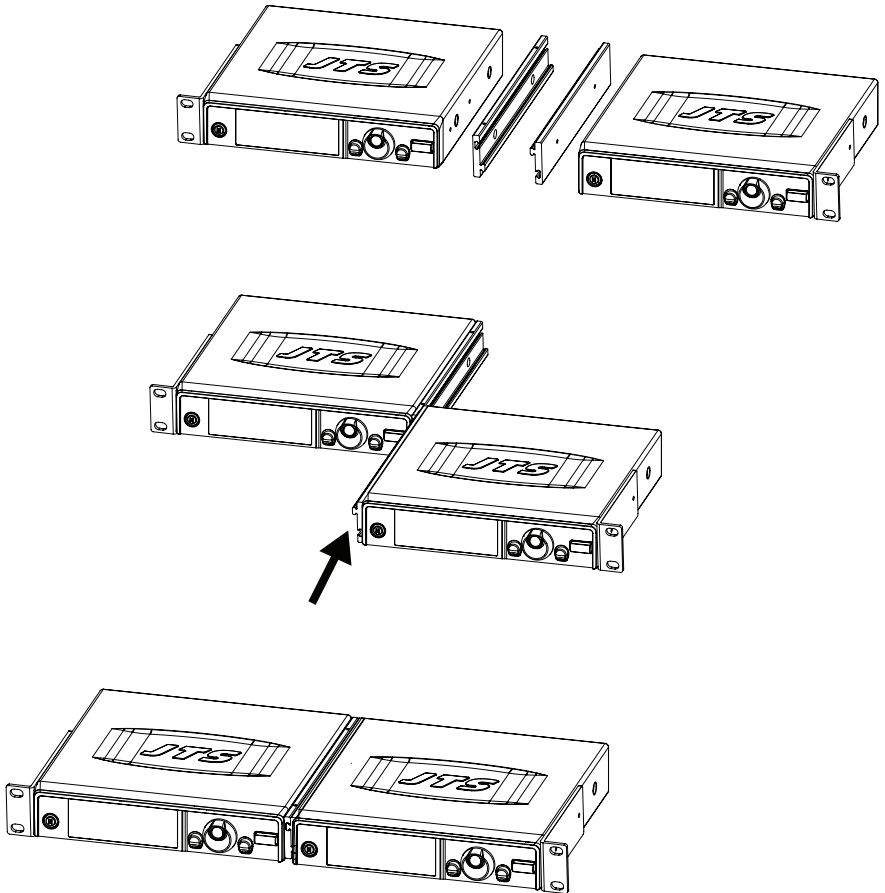

Figure 1

3. Receiver rack mount kit assembly//RM-10 (optional)

- (1) Assembly the rack mount kit as the following illustration to mount two UF-10R into one U rack.
- (2) Lock equipment onto a rack



4. Rack Mount Kit RM-901 (optional)

- Mount one UF-10R into one U rack.
- (1) Screw the rack mount kit on the receiver.
 - (2) screw the whole set onto a rack.

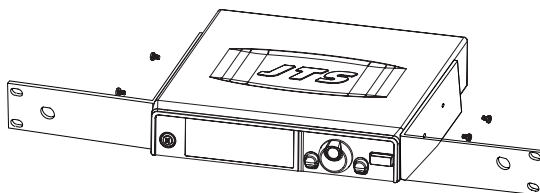
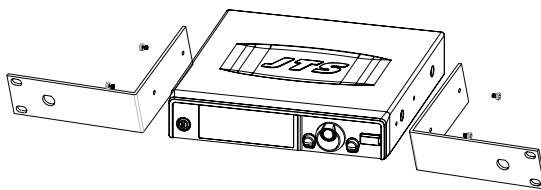

6. Operation

6-1 Operation setup for broadband true diversity receiver system // UF-10R

1. Turn receiver power on

- (1) Connect antennas onto the receiver
- (2) Press power key ① once to turn power on
- (3) Shut down: press and hold power key for 2 seconds.

2. Adjust volume

On main menu, turn jog dial to adjust volume, ranging from MUTE, -31 ~ 0 dB.

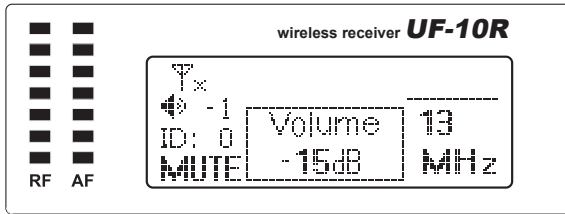

3. REMOSET function:

- (1) Pressing REMOSET key, blue light starts to flash, indicating transmitting frequency data. (Fig. 1)

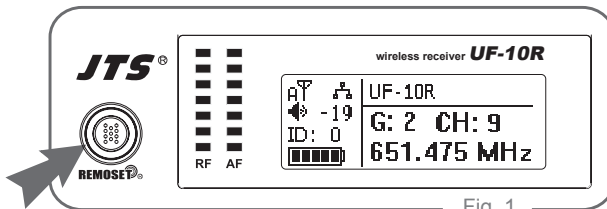

Fig. 1

- (2) When microphone receives data, microphone indicator lamp ②4 shows blue light for 5 seconds, while receiver blue light stops flashing, indicating the REMOSET has been done successfully. (Fig. 2)

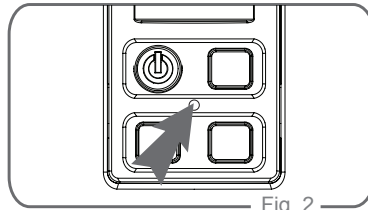

Fig. 2

- (3) Receiver blue light flashes slowly, indicating REMOSET failure, please check it:
- 1) Whether “frequency range labels” attached on receiver and microphone are the same.
 - 2) “REMOSET” selection in microphone function menu needs to be set “ON”.
 - 3) Device ID for receiver and microphone should be paired.

Refer to receiver setup method:

4. Menu function setup “6. Device ID: set device ID”

Refer to handheld transmitter setup method:

6. Menu function setup “4. Device ID: set device ID”

4. Menu function setup:

Press Setup key for 2 seconds to enter menu screen

- (1) Turn jog dial to make desired selection; press Setup key or press jog dial to enter setup screen; press Exit key to leave menu.
- (2) After entering into menu screen, turn jog dial to select default item; press Setup key or press jog dial to enter into menu screen.
- (3) After selecting the desired item, turn jog dial to obtain desired value; press Setup key to save the setting.

1. Frequency: set frequency

- (1) Turn jog dial to “1. Frequency”, press Setup (or press jog dial) to enter into frequency adjustment screen.

M	1. Frequency
E	2.Group/Channel
N	3.User Group
U	4. Scan

- (2) After entering into frequency adjustment screen, first adjust left 3 digit frequency; turn jog dial with “+/-” 1 MHz as unit change; press jog dial to adjust right 3 digit frequency; press jog dial to switch frequency between left and right.

Setup Frequency	
638	.000 MHz
G: --	CH: --

- (3) Adjust right 3 digit frequency; turn jog dial with “+/-” 0.025MHz as unit change; press Setup key to save setting.

Setup Frequency	
638	.000 MHz
G: --	CH: --

2. Group/Channel: set group and channel

- (1) Turn jog dial to “2. Group/Channel”, press Setup (or press jog dial) to enter into setup screen.

M	1. Frequency
E	2.Group/Channel
N	3.User Group
U	4. Scan

- (2) Turn jog dial to select group “G:”; group U1~U6 are user self-defined group/channel, which needs to be preset in “3. User Group” before use (please refer to “3. User Group” instructions for setup); press jog dial to set channel.

Setup Group/Channel	
G: 1	CH: 1
638.100MHz	

- (3) Turn jog dial to adjust channel “CH:”; after adjustment, press Setup key to save setting.

Setup Group/Channel	
G: 1	CH: 1
638.100MHz	

- (4) If not to save setting, press Exit key twice to leave.

3. User Group: user self-defined group and channel

Turn jog dial to “3. User Group”, press Setup (or press jog dial) to enter into User Group setup screen.

M	1. Frequency
E	2.Group/Channel
N	3.User Group
U	4. Scan

#1. Custom Group: self-defined group

(1) Turn jog dial to “1. Custom Group”; press jog dial to enter into Custom Group screen.

	1. Custom Group
	2. Clear Group
	3. Return

(2) Enter into Custom Group screen; press jog dial to switch setting from group (G), channel (CH), frequency in sequence; as frequency area shows “- - - - MHz”, it indicates the channel (G/CH) is not in use; turn jog dial to adjust frequency.

Setup Group/Channel	
G: U1	CH: 1
- - - - MHz	

#2. Clear Group: clear user self-defined groups

(1) Turn jog dial to “2. Clear Group”; press jog dial to enter into Custom Group screen.

	1. Custom Group
	2. Clear Group
	3. Return

(2) Turn jog dial to select the group to clear; then press jog dial to clear the setting for the group; the frequency for all channels in the group will become “- - - - MHz”.

Group:	U1
Rotary to select	
Push “Entry” to clear	
Push “Exit” to return	

#3. Return: return to main menu

Turn jog dial to “3. Return”; press jog dial to return to main menu.

	1. Custom Group
	2. Clear Group
	3. Return

4. Scan: scan channel

(1) Turn jog dial to “4. Scan”, press Setup (or press jog dial) to enter into scan channel screen.

M	1. Frequency
E	2.Group/Channel
N	3.User Group
U	4. Scan

#1. All Groups: scan all groups

(1) Turn jog dial to “1. All Group”, press Setup (or press jog dial) to enter into menu screen.

	1. All Groups
	2. Result List
	3. Current Group
	4. Return

(2) After entering into the screen (press Exit to return to upper menu); in “Scan All Group” press jog dial to start scanning.

	Scan All Group
	Press Setup or Enter to Start Scan.
	Press Exit to quit.

(3) Scan screen indicates current percentage of completion; to stop scan, press Exit key.

	Scan All Group
	Scanning... 10%

(4) After scan, automatically enter into “2. Result List” screen; user can enter directly by selecting it on menu.

Scan result can be seen on screen; select available channel; press Setup key to save setting; press Exit to cancel setting

	Scan Result List
G:	1 CH: 1
	Open Channel : 40

#2. Result List: see scan list

Turn jog dial to 2. Result List; press Setup (or press jog dial) to enter into menu screen to see scan result; select available channel; press Setup key to save setting; press Exit to cancel setting.

	Scan Result List
G:	1 CH: 1
	Open Channel : 40

#3. Current Group: scan single channel

(1) Turn jog dial to “3. Current Group”; press jog dial to enter into menu screen.

1. All Groups
2. Result List
3. Current Group
4. Return

(2) Turn jog dial to select Group first; press Setup key (or press jog dial) to start scan.

Scan Current Group
G: 1 CH:1

(3) After scan, screen shows OK; press jog dial once to scan the next channel; press Exit to return to upper menu.

Scan Current Group
G: U1 CH: 6 OK
Press "Setup" to Save.

#4. Return: return to main menu

Turn jog dial to “4. Return”; press jog dial to return to menu screen

1. All Groups
2. Result List
3. Current Group
4. Return

5. Squelch: Adjust receiving sensitivity

(1) Turn jog dial to “5. Squelch”, press Setup (or press jog dial) to enter into adjustment screen.

M	5. Squelch
E	6. Device ID
N	7. Output Level
U	8. Antenna Power

(2) Turn jog dial to adjust squelch, ranging from 10 ~ -5; 0 is standard, press Setup key to save setting; higher number represents lower sensitivity; lower number represents higher sensitivity.

Setup Squelch
0

6. Device ID: set device ID

(1) Turn jog dial to “6. Device ID”, press Setup (or press jog dial) to enter into ID adjustment screen.

M	5. Squelch
E	6. Device ID
N	7. Output Level
U	8. Antenna Power

(2) Turn jog dial to adjust ID, ranging 0~255; press Setup key to save setting.

The setting will affect the use of REMOSET.

Setup Device ID	
	6 (0~255)

7. Output Level: set audio output level

(1) Turn jog dial to “7. Output Level”, press Setup (or press jog dial) to enter into setup screen.

M	5. Squelch
E	6. Device ID
N	7. Output Level
U	8. Antenna Power

(2) Turn jog dial to select Line or Mic:

- Set Line: XLR MIC Output and Ø6.3mm output volume level is same.

- Set Mic: XLR MIC Output volume is lower than Ø6.3 mm output by -20dB.

(3) Press Setup key to save setting

Output Level	
<input type="radio"/>	Line
<input checked="" type="radio"/>	Mic.

8. Antenna Power: Set power on/off provided at BNC connectors

(1) Turn jog dial to “8. Antenna Power”, press Setup (or press jog dial) to enter into adjustment screen.

M	5. Squelch
E	6. Device ID
N	7. Output Level
U	8. Antenna Power

(2) Turn jog dial to select ON or OFF to turn on or shut down antenna booster power; press Setup key to save setting.

Antenna Power	
<input type="radio"/>	ON
<input checked="" type="radio"/>	OFF

9. User Name: set user name

(1) Turn jog dial to “9. User Name”, press Setup (or press jog dial) to enter into User Name setup screen.

M	9. User Name
E	a. Contrast
N	b. Key Lock
U	c. Exit

(2) Turn jog dial to select desired character; after confirmation press jog dial to go to next character setup; after setup press Setup key to save setting.

A user name consists of 10 characters at maximum.

User Name	
JTS UF-10R	
Char:	1/10

Indicate which character currently is set

10 characters available

a. Contrast: adjust screen contrast

(1) Turn jog dial to “a. Contrast”, press Setup (or press jog dial) to enter into setup screen.

M	9. User Name
E	a. Contrast
N	b. Key Lock
U	c. Exit

(2) Turn jog dial to adjust screen contrast; after confirmation press Setup key to save setting; higher number represents darker color; 7 adjustable levels.

Setup Contrast	
■■■■■■□□ 4/7	

b. Key Lock: set key lock

(1) Turn jog dial to “b. Key Lock”, press Setup (or press jog dial) to enter into setup screen.

M	9. User Name
E	a. Contrast
N	b. Key Lock
U	c. Exit

(2) Turn jog dial to select “Lock On”; after confirmation press Setup key to save setting; “Lock On” can lock all panel keys to prevent accidental touch except “Setup” key.

Setup Key Lock	
<input checked="" type="radio"/>	Lock On
<input type="radio"/>	Lock Off

(3) At Lock On statue pressing of any key will prompt texts as shown in the figure.

Press Setup for 2 Sec.
to unlock keyPad

(4) Cancel Lock On: press SETUP key for 2 seconds to go directly to “Key Lock” setup screen.
Turn jog dial to select Lock Off; after confirmation press Setup key to save setting.

Setup Key Lock	
<input type="radio"/>	Lock On
<input checked="" type="radio"/>	Lock Off

c. Exit: leave menu

Turn jog dial to “c. Exit”; press Setup key (or press jog dial) to return to main menu; or press “exit” to return to main menu.

M	9. User Name
E	a. Contrast
N	b. Key Lock
U	c. Exit

6-2 System operation setup for handheld transmitter // UF-10TH

1. Turn power on for UF-10TH handheld transmitter
 - (1) Turn on power: press power key once (Fig. 3).

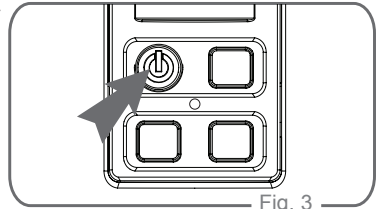

Fig. 3

- (2) Shut down power: press and hold power key for 2 seconds.

- (3) Mute setup:

When microphone is in use and mute setup is needed:

Set mute: short press power key once; indicator lamp flashes in red.

Cancel mute: short press power key again to cancel mute.

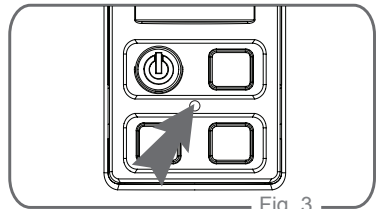

Fig. 3

2. Menu function setup:

Press and hold SET key for 2 seconds; enter into function setup menu;

- (1) Press ▲, ▼ keys to select desired item; press SET key to enter into menu.
- (2) After entering into menu, press ▲, ▼ keys to adjust to desired value; press SET key to save setting.

1. Freq.: set frequency

- (1) Press ▲, ▼ keys to Freq.; press SET key to enter into frequency adjustment screen.
- (2) After going to frequency adjustment screen, first adjust left 3 digit frequency; press ▲, ▼ keys with "+/-" 1 MHz as unit change; after adjustment press SET key to adjust right 3 digit frequency

Freq.
Group
Sensit.
Device ID

Frequency
G:- - C:- -
638.100

- (3) Adjust right 3 digit frequency: press ▲, ▼ keys with “+/-” 0.025 MHz as unit change; after adjustment press SET key to save setting.

Frequency
G:- C:-
638.100

2. Group: set group and channel

- (1) Press ▲, ▼ keys to Group; press SET key to enter into “Group” setup screen.

Freq.
Group
Sensit.
Device ID

- (2) After entering into the screen, press ▲, ▼ keys to select the desired group; press SET key to switch to Channel setup.

Group/Channel
G: 1
C: 1
638.100

- (3) Press ▲, ▼ keys to select the desired channel; press SET key to save setting.

Group/Channel
G: 1
C: 1
638.100

3. Sensit: microphone sensitivity setup

- (1) Press ▲, ▼ keys to Sensit; press SET to enter into “Sensit” sensitivity setup screen.

Freq.
Group
Sensit.
Device ID

- (2) Press ▲, ▼ keys to adjust sensitivity with 3dB as unit change; adjustment range from -18dB to +12dB.

Sensitivity
3db

4. Device ID: set device ID

- (1) Press ▲, ▼ keys to Device ID; press SET key to enter into “Device ID” setup screen.

Freq.
Group
Sensit.
Device ID

(2) Press ▲, ▼ keys to adjust default ID between 0 and 255; press SET key to switch to set ID: ON/OFF.

Device ID
0
ID: OFF

ID: ON → only if microphone ID and receiver ID are the same, REMOSET function can work.

ID: OFF → regardless of ID, the transmitter will accept REMOSET data from all receivers of the same band and with ID Off.

The setting will affect the use of REMOSET.

Device ID
0
ID: ON

5. REMOSET: set REMOSET function on/off

(1) Press ▲, ▼ keys to REMOSET; press SET to enter into “REMOSET” setup screen.

REMOSET
RF Power
Contrast
Light T.

(2) Press ▲, ▼ keys to select ON or OFF; press SET key to save setting.
Setting ON: REMOSET function available.

Setting OFF: disable REMOSET function; and saves microphone power.

Remote Set
<input type="radio"/> ON
<input checked="" type="radio"/> OFF

6. RF Power: set transmission power

(1) Press ▲, ▼ keys to RF Power; press SET to enter into “RF Power” screen; set transmission power.

REMOSET
RF Power
Contrast
Light T.

(2) Press ▲, ▼ keys to select transmission power as Hi or Low; press SET key to save setting.

Attention: if setting is Hi, microphone consumes more power.

RF Power
<input type="radio"/> Hi
<input checked="" type="radio"/> Low

Note: Hi represents 50 mW and Low 10 mW.

7. Contrast: adjust screen contrast

(1) Press ▲, ▼ keys to Contrast; press SET to enter into “Contrast” screen; adjust screen contrast.

	REMOSET
	RF Power
	Contrast
	Light T.

(2) Press ▲, ▼ keys to adjust contrast; higher number represents higher contrast; otherwise, lower contrast; -3 ~ 0 ~ +3 total seven adjustable levels.

	Contrast
	0

8. Light T.: set screen backlight time

(1) Press ▲, ▼ keys to Light T.; press SET to enter into “Light T.” screen; set screen backlight time.

	REMOSET
	RF Power
	Contrast
	Light T.

(2) Press ▲, ▼ keys to select backlight time;

3 options available; Always OFF (shut off), 5-30Sec (5 Sec as unit change), Always ON (always on).

The longer screen backlight time, the shorter battery life.

	Light Time
	5 Sec.

9. Name: set user name

(1) Press ▲, ▼ keys to Name; press SET to enter into “Name” screen; set user name.

	Name
	Key Lock
	Exit

(2) Press ▲, ▼ keys to select texts; after confirmation press SET key to set the next character; if no characters is needed, select “blank” character; after confirmation press SET key to save setting; Name consists of 10 characters at maximum.

	Name
	UF-10T
	Char1 / 10

Indicate which character currently is set

10 characters available

10. Key Lock: set key lock

(1) Press ▲, ▼ keys to Key Lock; press SET to enter into “Key Lock” screen; set key lock

	Name
	Key Lock
	Exit

(2) Select “Lock On” to lock all keys to prevent accidental touch; if setting is Lock On, mute function is not affected.

	Key Lock
	<input checked="" type="radio"/> Lock On
	<input type="radio"/> Lock Off

(3) If setting is “Lock On”, except mute, pressing any other keys will prompt the following screen.

	Press Set
	For 2 Sec.
	to unlock
	Keypad.

(4) Cancel Lock On: press SETUP key for 2 seconds to go directly to “Key Lock” setup screen, select “Lock Off”.

	Key Lock
	<input type="radio"/> Lock On
	<input checked="" type="radio"/> Lock Off

11. Exit: leave function setup menu

Press ▲, ▼ keys to Exit; press SET key to leave menu.

	Light T.
	Name
	Key Lock
	Exit

6-3 System operation setup for Body-Pack transmitter // UF-10TB

6-3-1 Turn power on for UF-10TB Body-Pack transmitter (Fig. 5)

- (1) Turn on power: press power key once
- (2) Shut down power: press and hold power key for 2 seconds.
- (3) Mute setup : When microphone is in use and mute setup is needed:
Set mute: short press power key once; indicator lamp flashes in red.
Cancel mute: short press power key again to cancel mute.
- (4) Leave the setting window: press the power key once the LCD display will return to the main window.

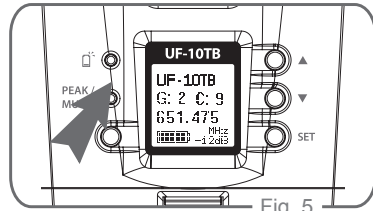

Fig. 5

6-3-2 Menu function setup :

Press and hold SET key for 2 seconds; enter into function setup menu;

- (1) Press ▲ , ▼ keys to select desired item; press SET key to enter into menu.
- (2) After entering into menu, press ▲ , ▼ keys to select desired value : press SET key to save setting.

1. Freq.: set frequency

- (1) Press ▲ , ▼ keys to Freq.; press SET key to enter into frequency adjustment screen.

Freq.
Group
Sensit.
Attenuate

- (2) After going to frequency adjustment screen, first adjust left 3 digits ;
Press ▲ , ▼ keys with “+/-” 1 MHz as unit change; after adjustment press SET key to adjust right 3 digits

Frequency
G: 1 C:1
625 500

- (3) Adjust right 3 digits : press ▲ , ▼ keys with “+/-” 0.025 MHz as unit change; after adjustment press SET key to save setting.

Frequency
G: 1 C:1
625 . 500

2. Group: set group and channel

(1) Press ▲, ▼ keys to Group; press SET key to enter into “Group” setup screen.

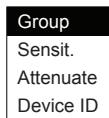

(2) After entering into the screen, press ▲, ▼ keys to select the desired group ; press SET key to switch to Channel setup.

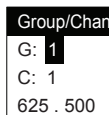

(3) Press ▲, ▼ keys to select the desired channel; press SET key to save setting.

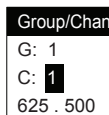

3. Sensit: microphone sensitivity setup

(1) Press ▲, ▼ keys to Sensit; press SET to enter into “Sensit” sensitivity setup screen.

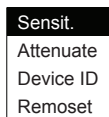

(2) Press ▲, ▼ keys to adjust sensitivity with 3dB as unit change ; press SET key to save setting ; adjustable range from -18dB to +12dB.

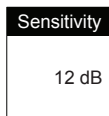

4. Attenuate : Microphone Attenuate

(1) Press ▲, ▼ key to Attenuate. Press SET to enter “Attenuate” setup screen.

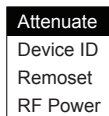

(2) Press ▲, ▼ key to select ON or OFF

ON: -20dB attenuation

OFF: No attenuation

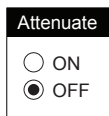

5. Device ID: set device ID

(1) Press ▲, ▼ keys to Device ID; press SET key to enter into “Device ID” setup screen.

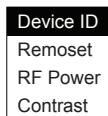

(2) Press ▲, ▼ keys to adjust default ID between 0 and 255; press SET key to switch to set ID: ON/OFF.

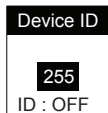

ID: ON → only if microphone ID and receiver ID are the same, REMOSET function will work.

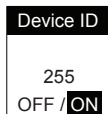

ID: OFF → regardless of ID, the transmitter will accept REMOSET data from all receivers of the same band and with ID Off.

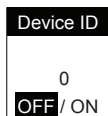

Press SET key to save setting.

The setting will affect the use of REMOSET.

6. REMOSET: set REMOSET function on/off

(1) Press ▲, ▼ keys to REMOSET; press SET to enter into “REMOSET” setup screen.

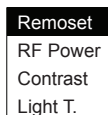

(2) Press ▲, ▼ keys to select ON or OFF; press SET key to save setting.

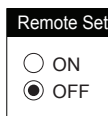

Setting ON: REMOSET function available.

Setting OFF: disable REMOSET function; and saves microphone power.

7.RF Power: set transmission power

(1) Press ▲, ▼ keys to RF Power; press SET to enter into “RF Power” screen;set transmission power.

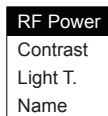

(2) Press ▲, ▼ keys to select transmission power as Hi or Low; press SET key to save setting.

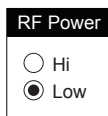

Attention: if setting is Hi, the RF signal is stronger while microphone consumes more power.

Note: Hi represents 50 mW and Low 10 mW.

8. Contrast: adjust screen contrast

(1) Press ▲, ▼ keys to Contrast; press SET to enter into “Contrast” screen ; adjust screen contrast.

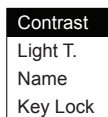

(2) Press ▲, ▼ keys to adjust contrast; higher number represents higher contrast ; otherwise, lower contrast; -3 ~ 0 ~ +3 total seven adjustable levels.

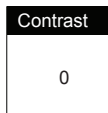

9.Light T.: set screen backlighting time

(1) Press ▲, ▼ keys to Light T.; press SET to enter into “Light T.” screen; set screen backlight time.

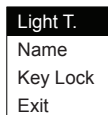

(2) Press ▲, ▼ keys to select backlight time 3 options available; Always OFF (shut off), 5~30Sec (5 Sec as unit change), Always ON (always on).



The longer screen backlight time, the shorter battery life.

10.Name: set user name

(1) Press ▲ , ▼ keys to Name; press SET to enter into “Name” screen; set user name.

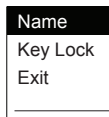

(2) Press keys to select texts; after confirmation press SET key to set the next character; if no characters is needed, select “blank” character; after confirmation press SET key to save setting; Name consists of 10 characters at maximum.

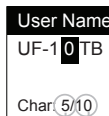

Indicate which character currently is set

10 characters available

11.Key Lock :

(1) Press ▲ , ▼ keys to Key Lock; press SET to enter into “Key Lock” screen; set Key Lock

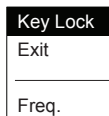

(2) Select “Lock On” to lock all keys to prevent accidental touch; if setting is Lock On, mute function is not affected.

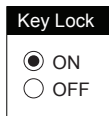

(3) If setting is “Lock On”, except mute, pressing any other keys will prompt the following screen.

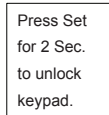

(4) Cancel Lock On: press SETUP key for 2 seconds to go directly to “Key Lock” setup screen, select “Lock Off”. Press SET key to save setting.

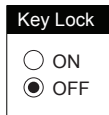

12.Exit: leave function setup menu

Press ▲ , ▼ keys to Exit; press SET key to leave menu.

Note: Pressing the power key will make the LCD back to main window.



6-4 Installation of Condenser Microphones

(1) Lavalier microphone

Attach lavalier microphone to a tie, lapel, where is suitable for sound pick-up. Plug the connector into input socket on the body-pack transmitter.

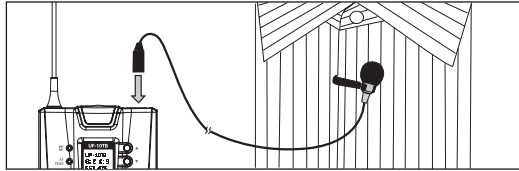

(2) Headset microphone

Put the headband behind your head, and fix the temples on your ears as shows, then adjust the gooseneck to have best miking. Plug the connector into input socket on the body-pack transmitter.

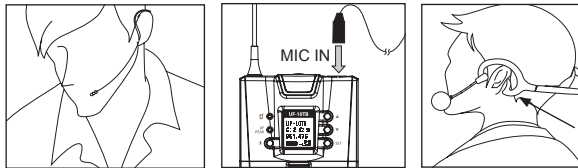

(3) Instrument Microphones

The system is compatible with JTS various instrument microphones.
For detail please refer to user's manuals of these microphones.

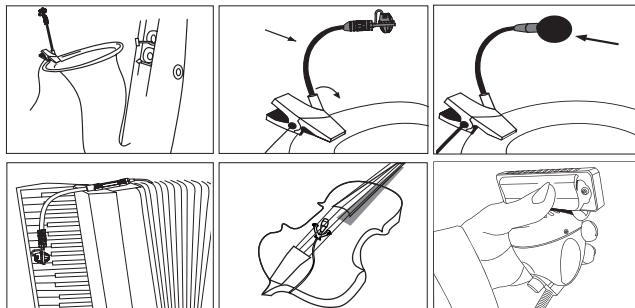

(4) Ear-hook Microphone

1. Lightweight Dual Ear Hook Microphone

Try on whether the headset is fit.

Adjust the headband to a suitable width.

Tighten or loosen the curve of the ear-hook by twisting the loop or expanding it.

Curve and bend the boom to fit your face.

Attach the detachable cable to a suitable place by a cable clip.

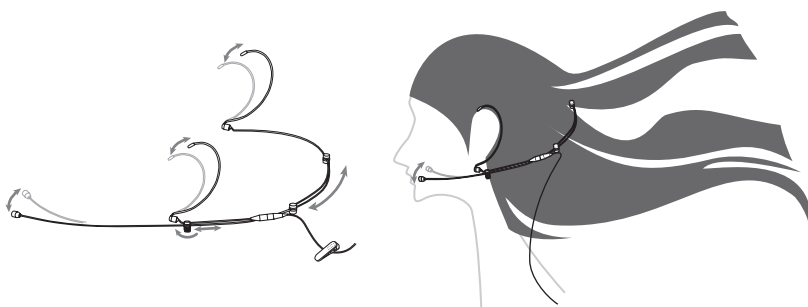

2. Lightweight Single Ear Hook Microphone

Try on whether the original curve is tight or loose.

Re-try and push the fixed curve against your earlobe.

Curve and Bend the boom to fit your face.

Attach the detachable cable to a suitable place by a cable clip.

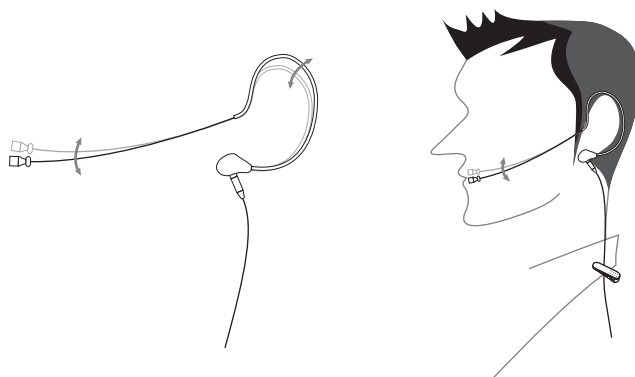

7. Product notes

- (1) To get the best signal performance, please keep at least 3 meters between a receiver and a transmitter.
- (2) Keep a receiver and transmitter from other metal object for at least 50cm.
- (3) To prevent feedback and whistle, please do not aim transmitter to speaker.
- (4) It is suggested to hold the middle section of transmitter (microphone) body to achieve the best pickup effect.
- (5) When multiple units are in use, it is suggested to use JTS UA-900 antenna distributor to prevent interference.
- (6) When transmitter is not used for a long time, please remove batteries from battery compartment to avoid leakage of electrolyte solution to damage transmitter.
- (7) When replacing batteries, please replace two batteries at the same time and use the same brand of battery, to assure the best power performance.

8. Important Notice

- (1) JTS offers wireless systems in a selection of bands that conform to the different government regulations of specific nations or geographic regions. These regulations help limit radio frequency (RF) interference among different wireless devices and prevent interference with local public communications channels, such as television and emergency broadcasts.
- (2) For information on bands available in your area, consult your local dealer or phone JTS. More information is also available at JTS's website (www.jts.com.tw).
- (3) This Radio apparatus may be capable of operating on some frequencies not authorized in your region. Please contact your national authority to obtain information on authorized frequencies and RF power levels for wireless microphone products.
- (4) The changes or modifications not expressly approved by the party responsible for compliance could void the user's authority to operate the equipment.
- (5) To comply with the FCC RF exposure compliance requirements, no change to the antenna or the device is permitted. Any change to the antenna or the device could result in the device exceeding the RF exposure requirements and void user's authority to operate the device.

