

Report No.	T6474774
Specifications	FCC Part 74 – Certification
Test Method	ANSI C63.4 1992
Applicant	JTS PROFESSIONAL CO., LTD.
Applicant address	No. 148, 9 th Industry Road, Ta-Li Industrial Park, Ta-Li City, Taiwan, R.O.C.
Items tested	Wireless Microphone
Model No.	PT-850B (Sample # T64774)
Results	Compliance (As detailed within this report)
Date	06/12/2002 (month / day / year) (Sample received) 07/02/2003 (month / day / year) (Test)
Prepared by	 Project Engineer
Authorized by	 General Manager (Frank Tsai)
Issue date	July 11, 2003 (month / day / year)
Modifications	None
Tested by	Training Research Co., Ltd.
Office at	No. 255, Nanyang Street, Hsichih, Taipei Hsien 221, Taiwan
Anechoic Chamber at	No. 255, Nanyang Street, Hsichih, Taipei Hsien 221, Taiwan

Conditions of issue:

- (1) This test report shall not be reproduced except in full, without written approval of TRC. And the test result contained within this report only relate to the sample submitted for testing.**
- (2) This report must not be used by the client to claim product endorsement by NVLAP or nay agency of U.S. Government.**

FCC ID : INGPT-850B

Contents

CHAPTER 0 APPLICATION FOR CERTIFICATION	4
CHAPTER 1 GENERAL	5
1.1 INTRODUCTION	5
1.2 DESCRIPTION OF SUPPORT EQUIPMENT	5
1.3 CONFIGURATION OF TEST SETUP	6
1.4 LOCATION OF THE MEASUREMENT SITE.....	6
1.5 GENERAL TEST CONDITION.....	6
CHAPTER 2 CONDUCTED EMISSION TEST	7
2.1 TEST CONDITION AND SETUP	7
2.2 LIST OF TEST INSTRUMENT.....	7
2.3 CONDUCTED EMISSION TEST RESULT	7
CHAPTER 3 POWER OUTPUT MEASUREMENT	8
3.1 RULES AND SPECIFICATION LIMITS	8
3.2 TEST CONDITION AND SETUP	8
3.3 TEST CONDITION AND SETUP	10
3.4 MEASUREMENT RESULT.....	11
CHAPTER 4 MODULATION CHARACTERISTICS MEASUREMENT	14
4.1 RULES AND SPECIFICATION LIMITS	14
4.2 TEST CONFIGURATION & LIST OF TEST INSTRUMENTS.....	14
4.3 LIST OF TEST INSTRUMENT	15
4.4 FREQUENCY RESPONSE OF AUDIO MODULATION CIRCUIT AND LOW PASS FILTER MEASUREMENT CONDITION & SETUP	15
4.5 MODULATION LIMITING MEASUREMENT CONDITION & SETUP.....	18

CHAPTER 5 OCCUPIED BANDWIDTH MEASUREMENT21

- 5.1 RULES AND SPECIFICATION LIMITS 21
- 5.2 TEST CONFIGURATION & LIST OF TEST INSTRUMENTS..... 21
- 5.3 LIST OF TEST INSTRUMENT..... 21
- 5.4 MEASUREMENT PROCEDURE..... 22
- 5.5 MEASUREMENT RESULT..... 22

CHAPTER 6 FIELD STRENGTH OF SPURIOUS RADIATION MEASUREMENT29

- 6.1 RULES AND SPECIFICATION LIMITS 29
- 6.2 MEASUREMENT CONDITION & SETUP..... 29
- 6.3 LIST OF MEASUREMENT INSTRUMENTS 32
- 6.4 MEASUREMENT RESULT:..... 33

CHAPTER 7 FREQUENCY STABILITY TOLERANCE MEASUREMENT36

- 7.1 RULES AND SPECIFICATION LIMITS 36
- 7.2 MEASUREMENT CONDITION & SETUP WITH TEMPERATURE VARIATION 36
- 7.3 LIST OF MEASUREMENT INSTRUMENTS WITH TEMPERATURE VARIATION LIST OF TEST INSTRUMENT..... 36
- 7.4 MEASUREMENT CONFIGURATION OF TEMPERATURE VARIATION TEST:..... 37
- 7.5 MEASUREMENT RESULT WITH TEMPERATURE VARIATION..... 38
- 7.6 MEASUREMENT CONDITION & SETUP WITH VOLTAGE VARIATION..... 40
- 7.7 CONFIGURATION OF VOLTAGE VARIATION TEST..... 40
- 7.8 MEASUREMENT RESULT WITH VOLTAGE VARIATION..... 41

Chapter 0 Application for Certification

- 74.861(e)(2)** : Transmitters may be either crystal controlled or frequency synthesized.
 crystal controlled frequency synthesized
- 2.1033(c)(1)** : **JTS PROFESSIONAL CO., LTD.** – applicant and manufacturer
- 2.1033(c)(2)** : The equipment is a transmitter, wireless microphone
Model No.: PT-850B
- 2.1033(c)(3)** : Quantity production is planned. See users manual
- 2.1033(c)(4)** : Type of emission – F3E- FM Modulation
- 2.1033(c)(5)** : 614 ~ 806MHz
- 2.1033(c)(6)** : 29.0 mW
- 2.1033(c)(7)** : Specification of 250 mW is met by the equipment in the applicable
Part 74.861 (e)(1)(ii)
- 2.1033(c)(8)** : Final RF amplifier stage current : 100mA
- 2.1033(c)(9)** : Description follows
- 2.1033(c)(10)** : Complete circuit diagrams are included. No modification was made
- 2.1033(c)(11)** : See label, Instruction sheet to user included
- 2.1033(c)(12)** : See photos.
- 2.1033(c)(13)** : N/A
- 2.1033(c)(14)** : Description follows.
- 2.1033(c)(15)** : N/A
- 2.1033(c)(16)** : N/A
- 2.1033(c)(17)** : N/A

Chapter 1 GENERAL

1.1 Introduction

The following measurement report is submitted on behalf of JTS PROFESSIONAL CO., LTD. In support of the wireless microphone certification in accordance with FCC Rules 2.1031, 2.1046, 2.1047, 2.1049, 2.1053, 2.1055, 74.801, and 74.861.

Description of EUT:

EUT	:	WIRELESS MICROPHONE
Model No.	:	PT-850B
Carrier Frequency Range	:	692MHz ~ 806MHz
RF Power Output	:	29.0 mW
Supply Voltage	:	DC 3V
Supply Current	:	100mA
Frequency Response	:	300Hz ~ 15kHz
Frequency Stability	:	0.005%
Operating Temperature	:	- 30 to + 50 degree centigrade

Wireless microphone is a transmitter, which operates in the frequency range of 692MHz ~ 806MHz (lowest: 692.000MHz, middle: 749.000MHz, and highest: 806.000MHz tested) This microphone is worn by a performer and other participants in a program, filming, reporting .etc.

1.2 Description of Support Equipment

No support equipment

The EUT does not be connected with any product. No support equipment is required for its normal operation.

1.3 Configuration of Test Setup

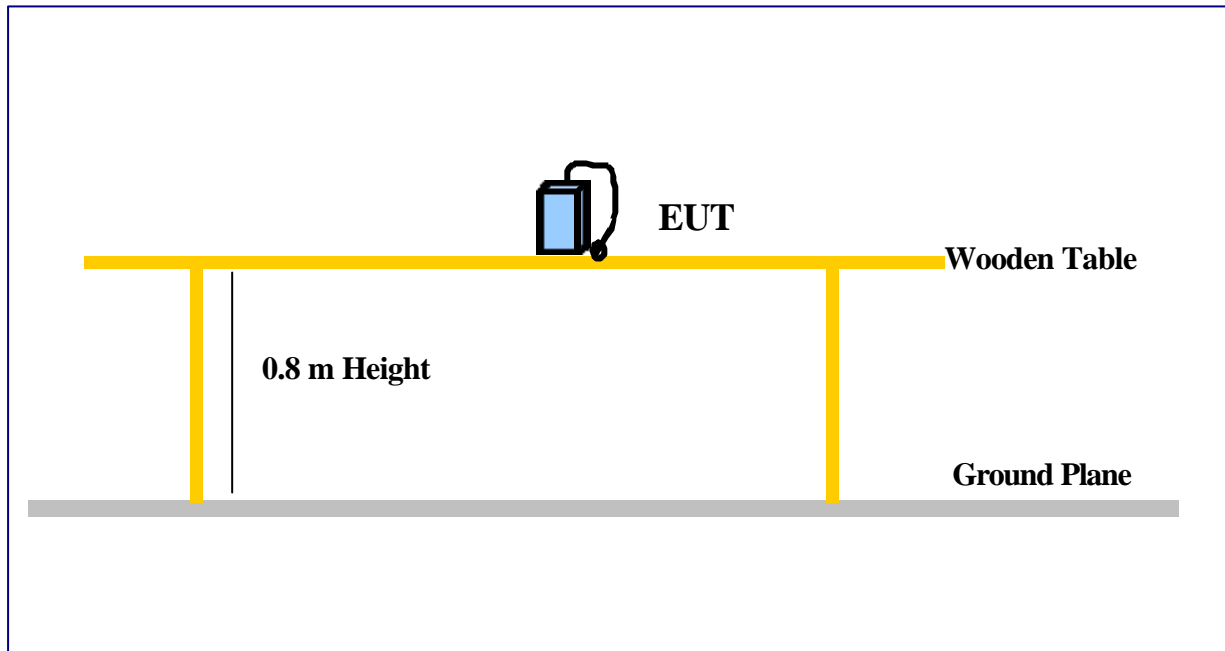

1.4 Location of the Measurement Site

The radiated emissions measurements required by the Rules were performed on the Three-meter, anechoic chamber at test site maintained by *Training Research Co., Ltd.*, No. 255, Nanyang Street, Shijr, Taipei Hsien 221, Taiwan. Complete description and measurement data have been placed on file with the Commission. The conducted power line Emissions tests were performed in a shielded enclosure also located at the above facility.

Training Research Co., Ltd. is listed by the FCC (Registration Number: 93906) as a facility available to do measurement work for others on a contract basis.

1.5 General Test Condition

The conditions under which the EUT operates were varied to determine their effect on the equipment's emission characteristics. The final configuration of the test system and the mode of operation used during these tests were chosen as that which produced the highest emission levels. However, only those conditions, which the EUT was considered likely to encounter in normal use were investigated.

Chapter 2 Conducted Emission Test

2.1 Test condition and setup

All the equipment is placed and setup according to the ANSI C63.4 - 1992.

The EUT is assembled on a wooden table, which is 80 cm high, is placed 40 cm from the back-wall, which is a vertical conducting plane. One LISN is for EUT, the other LISN is for support equipment. They are all placed on the conductive ground. The EUT's LISN connect a line switch box for selecting L1 or L2, then connect to a preamplifier and spectrum.

The spectrum scans from 150KHz to 30MHz. Conducted emission levels are detected at maximum peak mode. But if the maximum peak mode failed or over average limit, It will be measured by average detection mode.

While testing, there is the worst-emission plot printed at peak detection mode, and there are more than 6 highest emissions relative to limit recorded. The plot is kept as the original data, not included in test report.

2.2 List of test Instrument

<u>Instrument Name</u>	<u>Model No.</u>	<u>Brand</u>	<u>Serial No.</u>	<u>Calibration Date</u>	
				<u>Last time</u>	<u>Next time</u>
Spectrum analyzer	8594EM	H P	3710A00279	12/26/02	12/26/03
Pre-selector (>30MHz)	AMP-01	TRC	REP-001	10/20/02	10/20/03
LISN (EUT)	TRCLISN-01	TRC	LISN-01	09/03/02	09/03/03
LISN (Support E.)	LISN-01	TRC	9912-05	07/15/02	07/15/03
Auto Switch Box (< 30MHz)	ASB-01	TRC	9904-01	11/20/02	11/20/03

The level of confidence of 95%, the uncertainty of measurement of conducted emission is $\pm 2.02\text{dB}$.

2.3 Conducted Emission Test Result

Test Result: N/A (Not Applicable)

Chapter 3 Power Output Measurement

3.1 Rules and Specification Limits

2.1046(a), ANSI/ TIA/ EIA-603-1992, Paragraph 2.2.1.

74.861 (e) (1) : The power of the measured unmodulated carrier power at output of the transmitter power amplifier (antenna input power) may not exceed the following:

1. 54 – 72, 76 – 88 and 174 – 216 MHz band 50 mW.
2. 470 – 608 and 614 – 806 MHz band 250 mW.

3.2 Test condition and setup

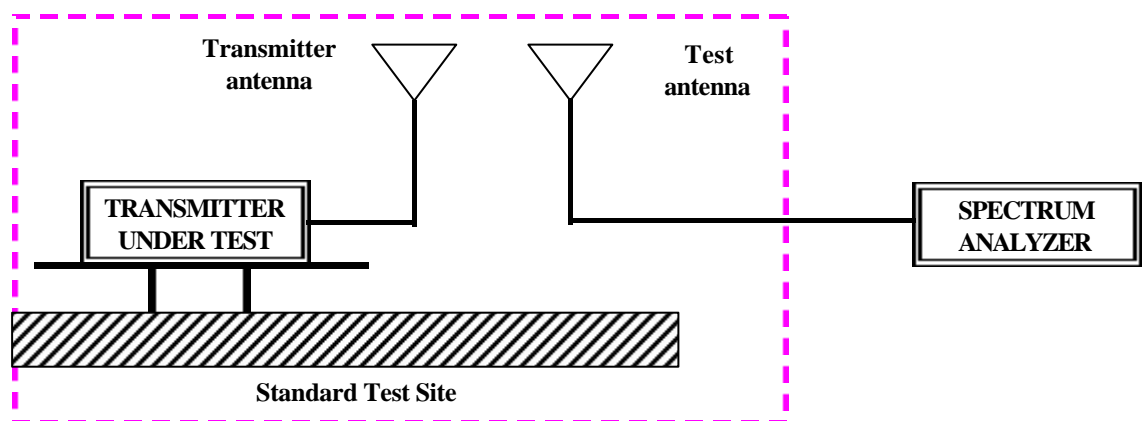

1. Measurement was made on anechoic chamber. The EUT system was placed on non-conductive turntable which is 0.8 meters height, top surface 1.0 X 1.5 meter. The EUT was placed in three direction of the space in order to obtain maximum emission.
2. Connect the equipment as illustrated. Place the transmitter to be tested on the turntable in the standard test site.
3. Raise and lower the test antenna from 1m to 4m with the transmitter facing the antenna and record the highest received signal.
4. Repeat step (3) for seven additional readings at 45 interval positions of the turn-table.

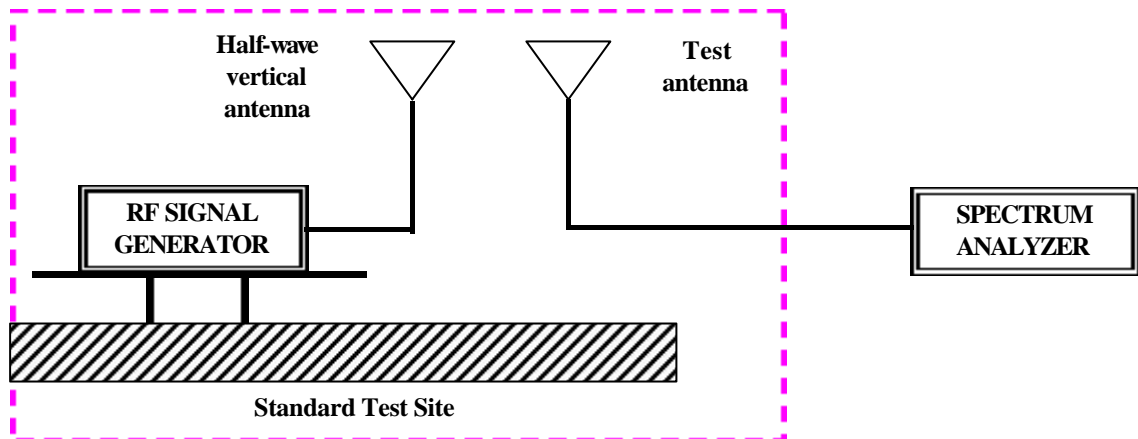

5. Replace the transmitter under test with a half-wave vertically polarized antenna. The center of the antenna should be at the same location as the transmitter under test. Connect the antenna to a signal generator with a known output and record value.

6. $FI_a(\text{dBm}) = FI_r(\text{dBm}) - \text{Corrected (dB)}$
 $\text{Corrected (dB)} = AF(\text{dB}) + [CL(\text{dB}) - \text{Amplitude Gain}]$
 FI_a : Actual Field Intensity
 FI_r : Reading of the Field Intensity
 AF : Antenna Factor
 CL : Cable Loss

7. The field intensity in Watt can then be determined by the following equation:
 $P(\text{watt}) = FI^2(\text{ Volt}) \times d^2(\text{meter}) / 49.2$
 P : Power in Watt
 D : Measurement Distance (3 m)

3.3 Test condition and setup

<u>Instrument Name</u>	<u>Model No.</u>	<u>Brand</u>	<u>Serial No.</u>	<u>Calibration Date</u>	
				<u>Last time</u>	<u>Next time</u>
Spectrum analyzer	8594EM	H P	3710A00279	12/26/02	12/26/03
Pre-selector (>30MHz)	AMP-01	TRC	REP-001	10/20/02	10/20/03
Bi-log Antenna	CBL 6141A	Chase	4206	05/27/03	05/27/04
Switch/Control Unit (> 30MHz)	3488A	HP	N/A	11/20/02	11/20/03
Auto Switch Box (> 30MHz)	ASB-01	TRC	9904-01	11/20/02	11/20/03
Spectrum Analyzer	8564E	HP	US36433002	08/01/02	08/01/03
Microwave Preamplifier	83051A	HP	3232A00347	08/01/02	08/01/03
Horn Antenna	3115	EMCO	9704 – 5178	08/01/02	08/01/03
Horn Antenna	RA42-K-F-4B-C	CMT	961505-003	02/01/03	02/01/04
Anechoic Chamber (cable calibrated together)				05/20/03	05/20/04

The level of confidence of 95% , the uncertainty of measurement of radiated emission is ± 3.44 dB .

3.4 Measurement Result

(1) Frequency: 692.000 MHz

The maximum field measured is 14.62 dBm

$$FI (Volt) = 10^{112.00/20} \times 10^{-6} = 0.39811 \text{ V}$$

$$FI (W) = (0.39811 \times 3)^2 / 49.2 = 29.0 \text{ mW}$$

Angle of Turn Table (°)	Spectrum Reading (dBm)	Corrected (dB)	Actually Value (dBm)	E. R. P. (mW)	Average (W)
0°	0.93	11.53	12.46	17.63194	1.349 x 10 ⁻²
45°	0.77	11.53	12.30	16.99417	
90°	2.05	11.53	13.58	22.81918	
135°	1.84	11.53	13.37	21.74203	
180°	-0.27	11.53	11.26	13.37519	
225°	-5.48	11.53	6.05	4.02995	
270°	-3.95	11.53	7.58	5.73192	
315°	-4.07	11.53	7.46	5.57571	

(2) Frequency: 749.000 MHz

The maximum field measured is 13.12 dBm

$$FI \text{ (Volt)} = 10^{110.50/20} \times 10^{-6} = 0.33497 \text{ V}$$

$$FI \text{ (W)} = (0.33497 \times 3)^2 / 49.2 = 20.53 \text{ mW}$$

Angle of Turn Table (°)	Spectrum Reading (dBm)	Corrected (dB)	Actually Value (dBm)	E. R. P. (mW)	Average (W)
0°	-0.40	12.72	12.32	17.07261	1.223 x 10 ⁻²
45°	-1.47	12.72	11.25	13.34443	
90°	-1.49	12.72	11.23	13.28312	
135°	-1.28	12.72	11.44	13.94119	
180°	-1.12	12.72	11.60	14.46439	
225°	-3.75	12.72	8.97	7.89405	
270°	-3.82	12.72	8.90	7.76784	
315°	-2.68	12.72	10.04	10.09950	

(3) Frequency: 806.000 MHz

The maximum field measured is 11.22 dBm

$$FI \text{ (Volt)} = 10^{108.60/20} \times 10^{-6} = 0.26915 \text{ V}$$

$$FI \text{ (W)} = (0.26915 \times 3)^2 / 49.2 = 13.25 \text{ mW}$$

Angle of Turn Table (°)	Spectrum Reading (dBm)	Corrected (dB)	Actually Value (dBm)	E. R. P. (mW)	Average (W)
0°	-4.65	13.95	9.30	8.51726	7.925 x 10 ⁻²
45°	-4.04	13.95	9.91	9.80167	
90°	-5.55	13.95	8.40	6.92309	
135°	-14.67	13.95	-0.72	0.84781	
180°	-4.16	13.95	9.79	9.53455	
225°	-4.56	13.95	9.39	8.69561	
270°	-4.51	13.95	9.44	8.79630	
315°	-3.83	13.95	10.12	10.28727	

Chapter 4 Modulation Characteristics Measurement

4.1 Rules and Specification Limits

2.1047 (a), ANSI/ TIA/ EIA-603-1992, Paragraph 2.2.6.

Voice modulated communication equipment

2.1047 (b), ANSI/ TIA/ EIA-603-1992, Paragraph 2.2.3.

Equipment which employs modulation limiting

4.2 Test Configuration & List of Test Instruments

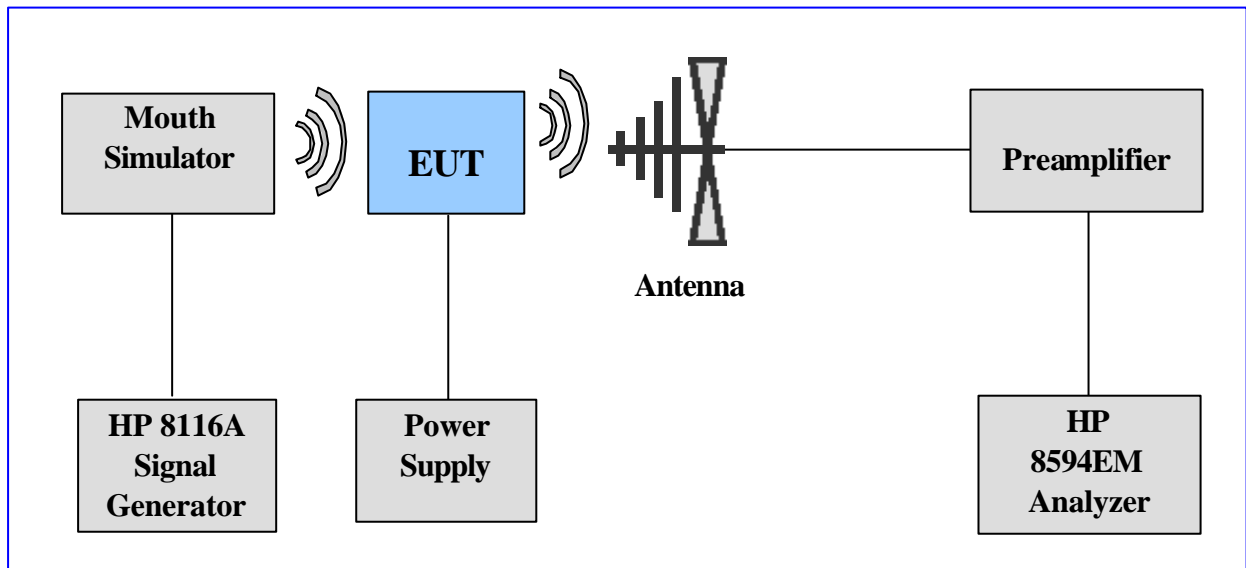

4.3 List of test instrument

<u>Manufacturer</u>	<u>Device</u>	<u>Model No.</u>	<u>Input Impedance</u>
HP	Dynamic Signal Analyzer	HP35660A	50
HP	Signal Generator 50 MHz	HP8116A	50
SCHAFFNER	Bi-log Antenna	CBL6141A	50
Farnell	Modulation Meter	AMM2000	50
TRC	Preamplifier	TRC001	50
ANRITSU	Spectrum Analyzer	MS2665C	50

4.4 Frequency Response of Audio Modulation Circuit and Low Pass Filter Measurement Condition & Setup

2.1047 (a)

1. The EUT and test equipment were set up as shown on the Section 4.2.
2. The Plus/Function generator was connected to the microphone of EUT, via an artificial mouth simulator.
3. The audio signal input was adjusted to obtain 50% modulation at 1 kHz.
4. With input levels held constant and below limiting at all frequencies, the generator was varied from 100Hz to 51.3kHz, 1kHz to 103.4kHz
5. The response in dBm relative to 1kHz was then measured, using the HP 35660A Dynamic Signal Analyzer as follow page.

100Hz to 51.3kHz

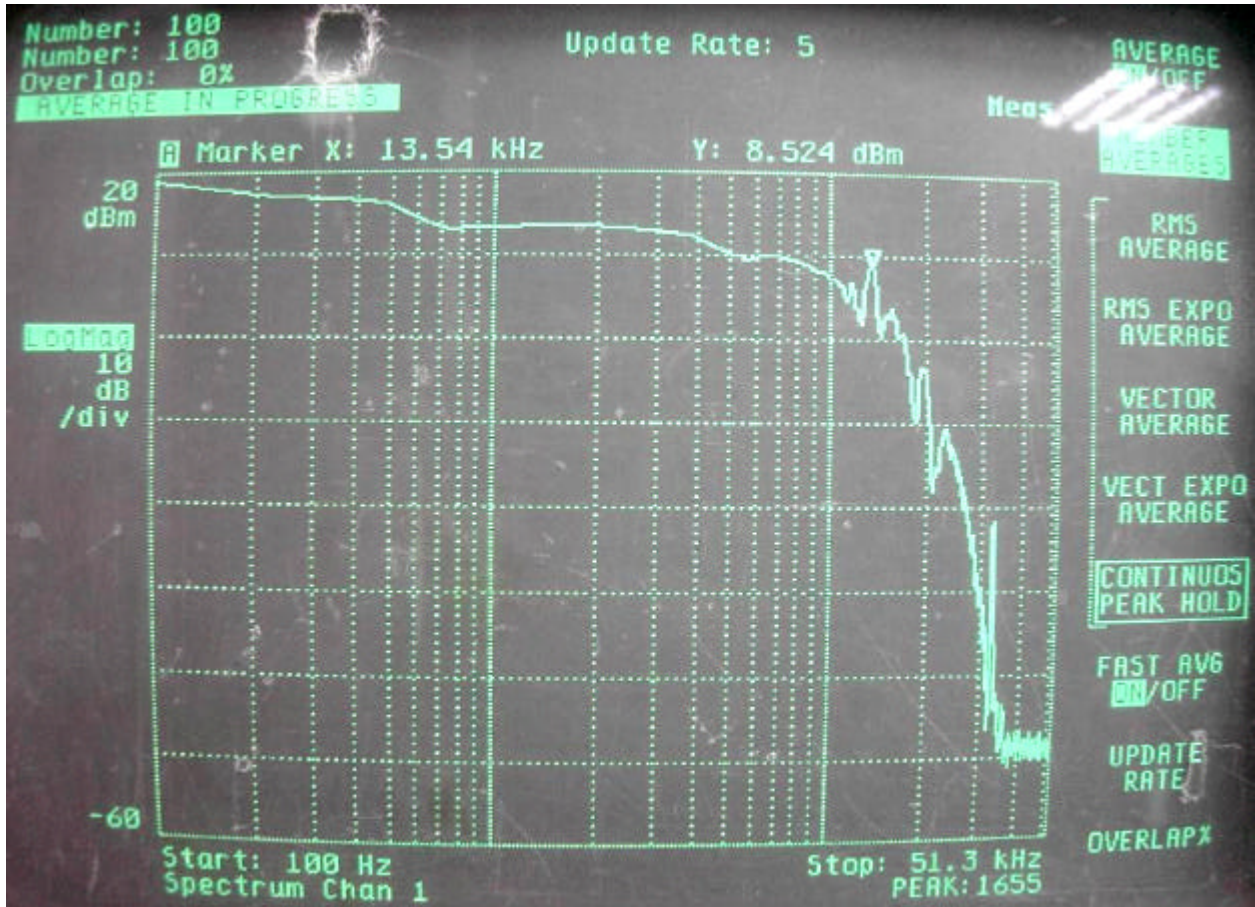

1kHz to 103.4kHz

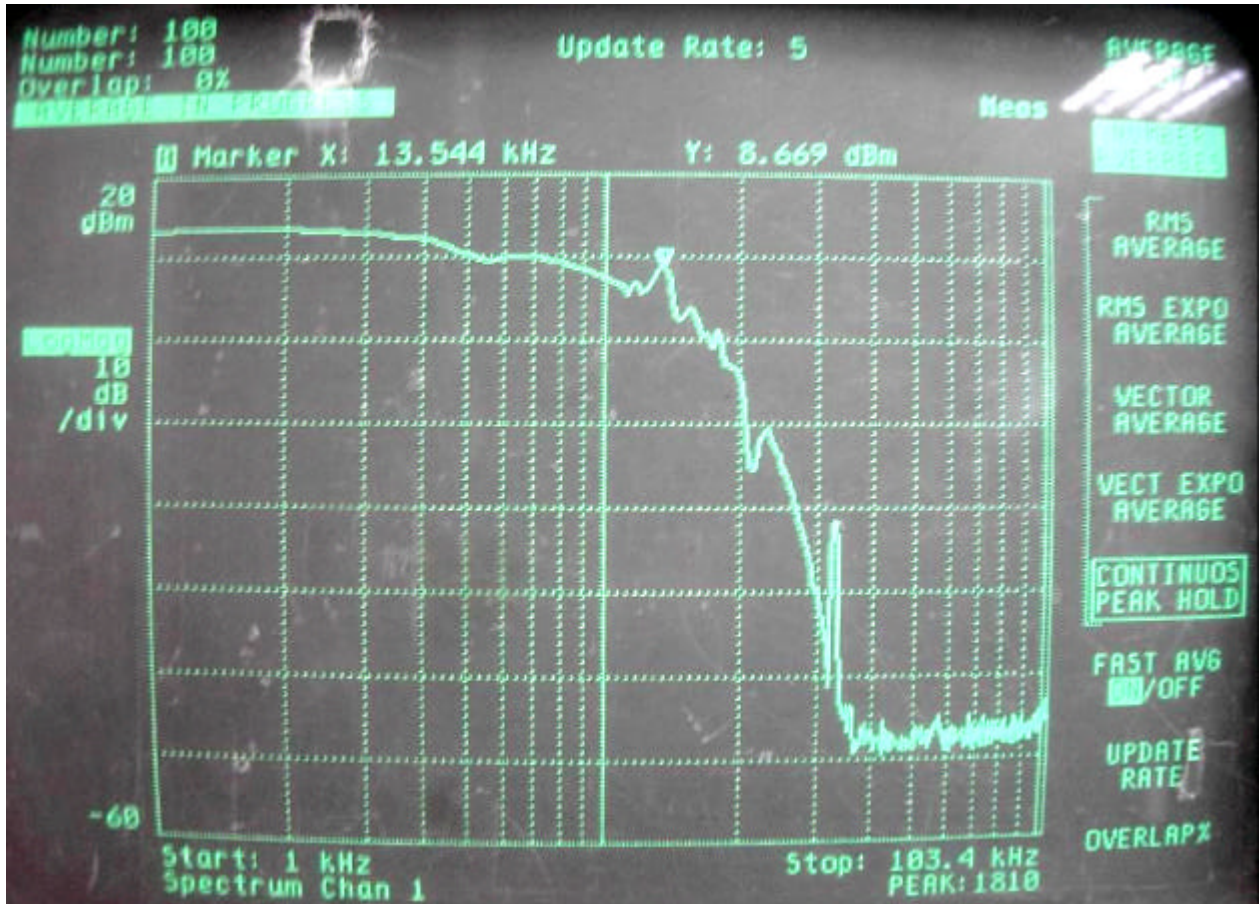

4.5 Modulation Limiting Measurement Condition & Setup

2.1047 (b)

1. The Plus/Function generator was connected to the microphone of EUT, via an artificial mouth simulator.
2. The modulation response was measured for each of following frequencies: 300Hz, 1.0kHz, 2.5kHz, 13.5kHz and 15kHz.
3. The input level was varied from 30% modulation to at least 20dB higher than the saturation point.
4. Measurements were performed for both negative and positive modulation and the respective results were recorded.
5. Measurement results as Chart 4.1 and Chart 4.2

Chart 4.1 Modulation Limiting Measurement Negative

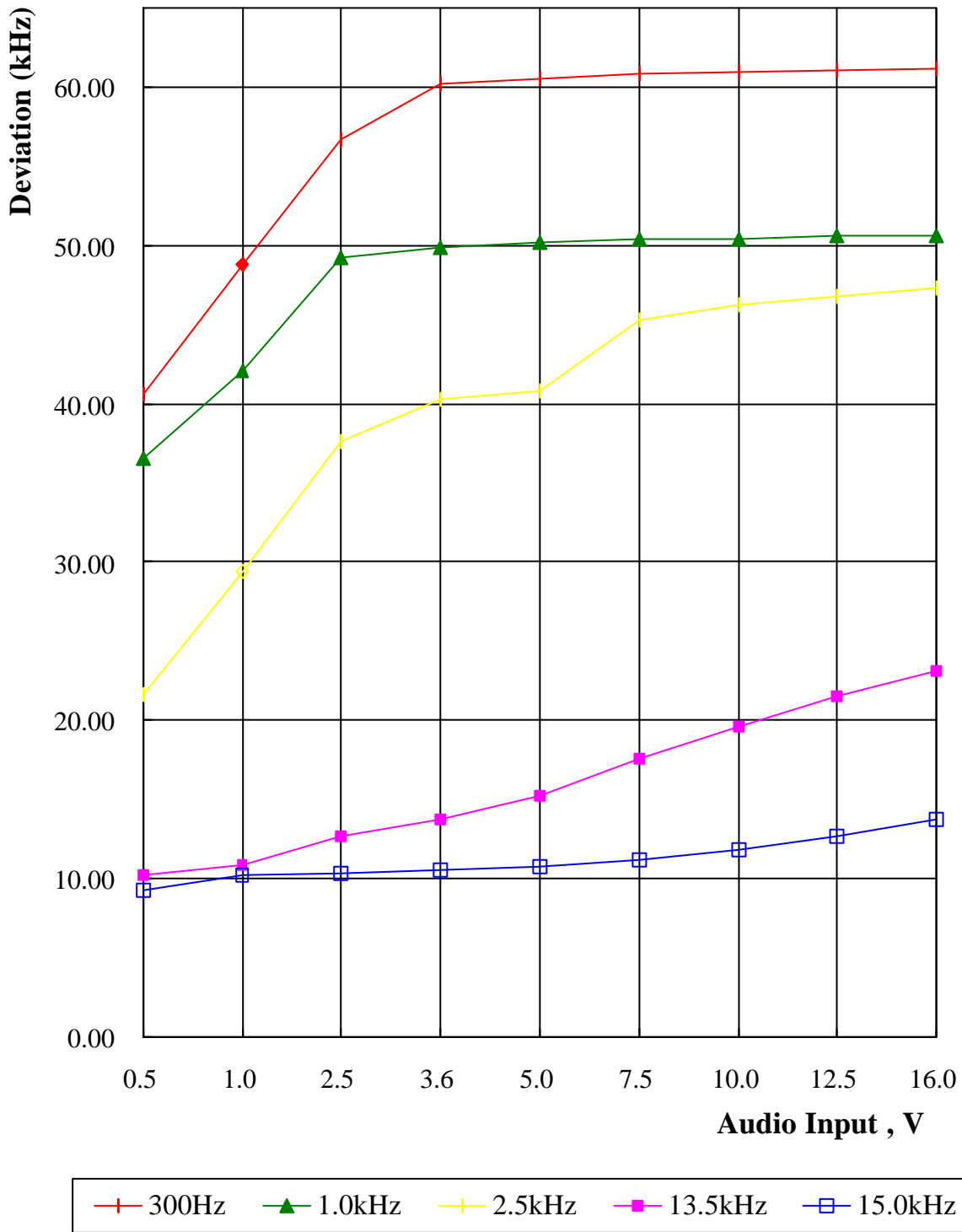
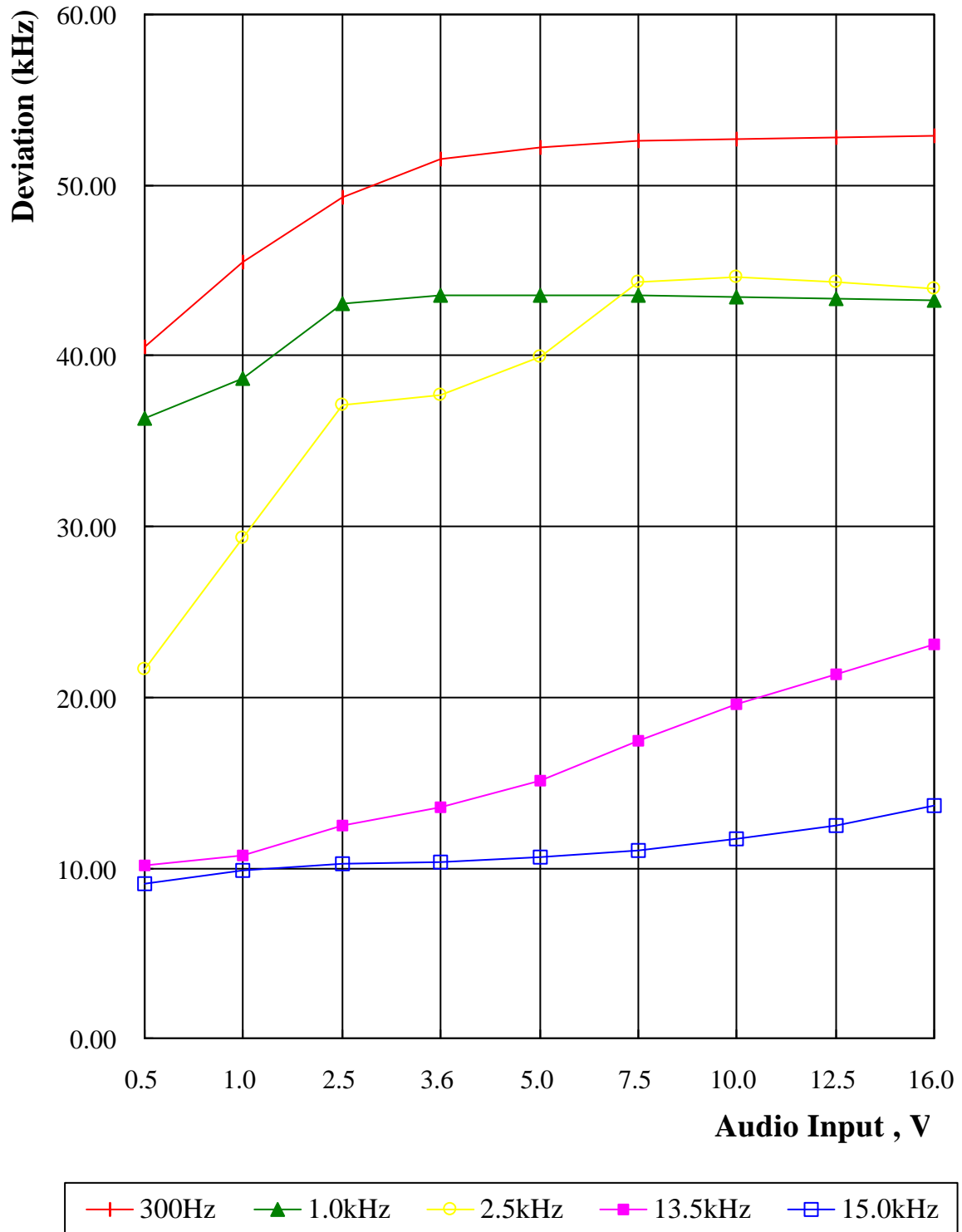

Chart 4.2 Modulation Limiting Measurement Positive



Chapter 5 Occupied Bandwidth Measurement

5.1 Rules and Specification Limits

2.1049(c)(1): ANSI/ TIA / EIA-603-1992, Paragraph 2.2.11.

74.861(e)(3): Any form of modulation may be used. A maximum deviation of $\pm 75\text{kHz}$ is permitted when frequency modulation is employed.

74.861(e)(5): The operation bandwidth shall not exceed 200kHz.

5.2 Test Configuration & List of Test Instruments

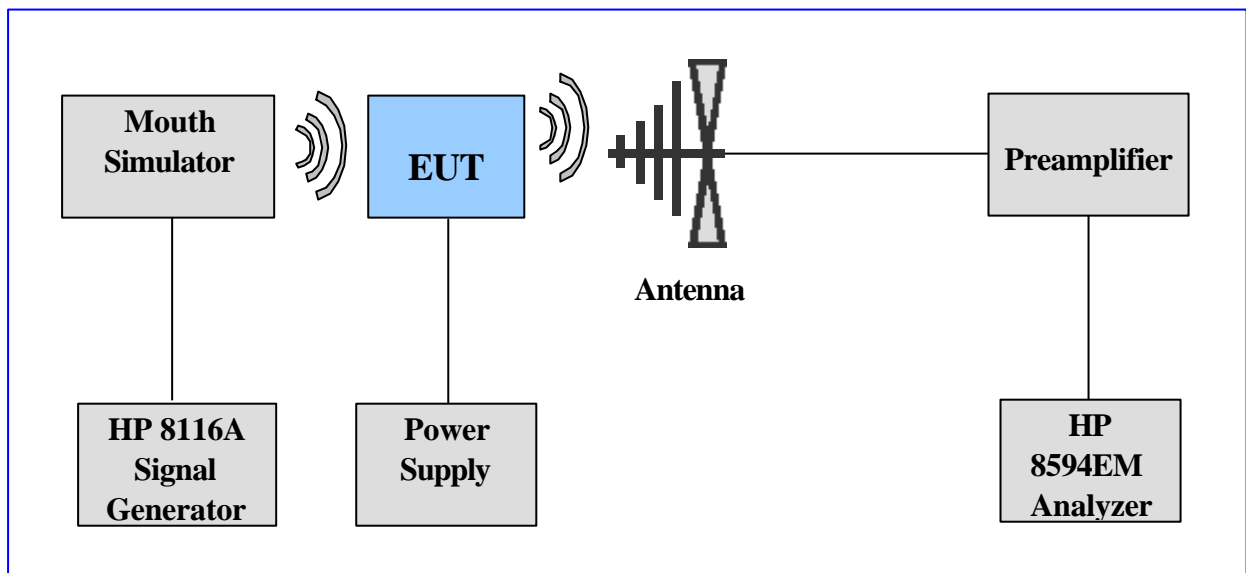

5.3 List of test Instrument

Instrument Name	Model No.	Brand	Input Impedance
Spectrum analyzer (9K~1.8GHz)	8594EM	HP	50
Spectrum analyzer (9K~1.8GHz)	8564E	HP	50
Preamplifier (30MHz~1GHz)	TRC001	TRC	50
Signal Generator 50 MHz	HP8116A	HP	50
Bi-log Antenna	CBL6141A	SCHAFFNER	50
Spectrum Analyzer	MS2665C	ANRITSU	50

5.4 Measurement Procedure

1. Connect the EUT as Section 4.2 .
2. Plot the unmodulated chart shows on spectrum.
3. Set the output of the signal generator to 300Hz, 1.0kHz, 2.5kHz, 13.5kHz and 15kHz.
Increase the amplitude of the signal, while monitoring the modulation meter. Until modulation is maximum measure the bandwidth under 26dB compared to the unmodulated fundamental carrier peak level of the modulated signal displayed on the spectrum analyzer.
4. The occupied Bandwidth was measured as follow pages.

5.5 Measurement Result

The occupied bandwidth' s plot is presented on following pager, which illustrates compliance with the rules.

Calculation of Necessary Bandwidth (Bn)

$$B_n = 2M + 2D$$

$$M = \text{Max. Modulation Frequency} = 15.00 \text{ kHz}$$

$$D = \text{Peak Frequency Deviation} = 61.18 \text{ kHz} \quad (\text{Chart 4-1, Page20})$$

$$K = 1$$

$$B_n = 152.36 \text{ kHz}$$

Unmodulation

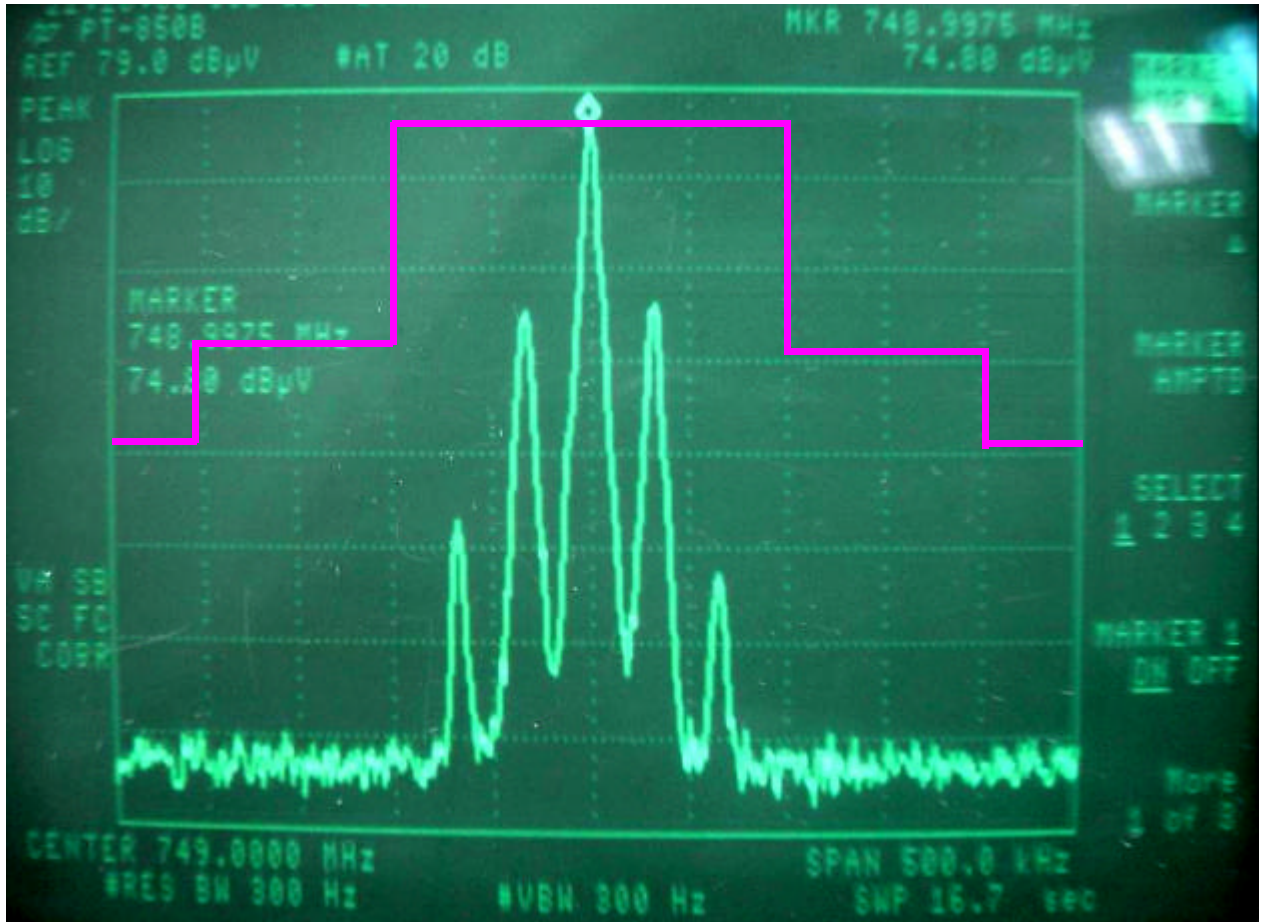

300Hz modulation

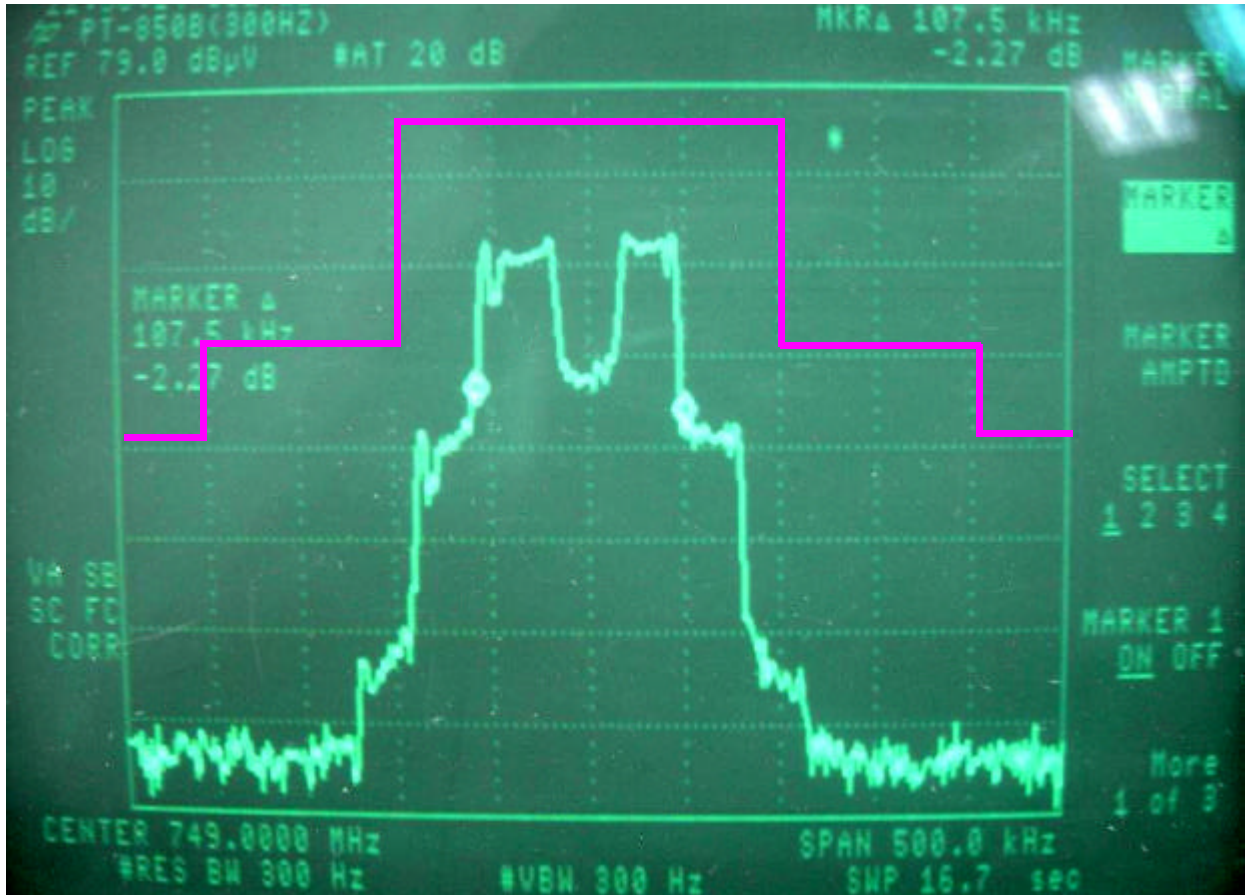

1.0kHz modulation

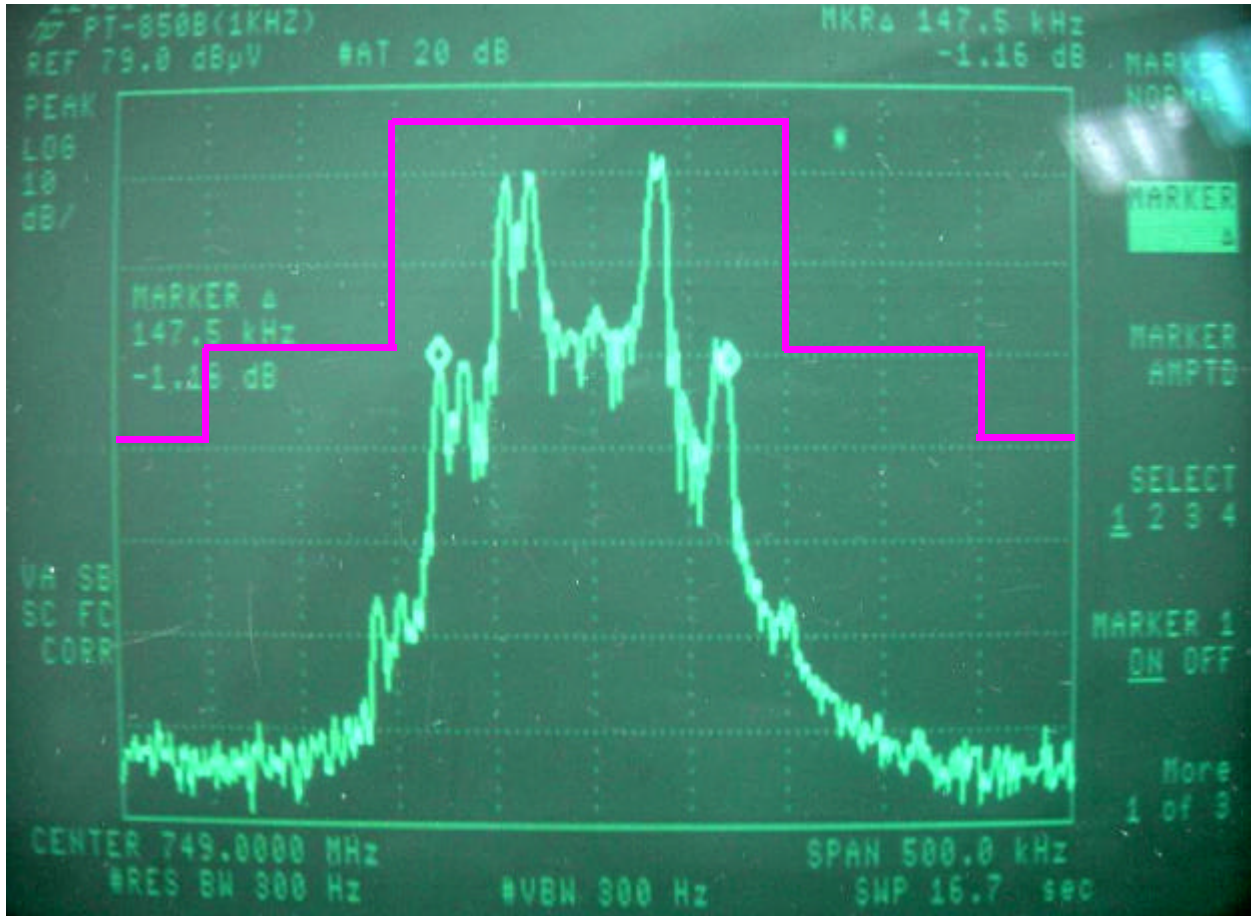

2.5kHz modulation

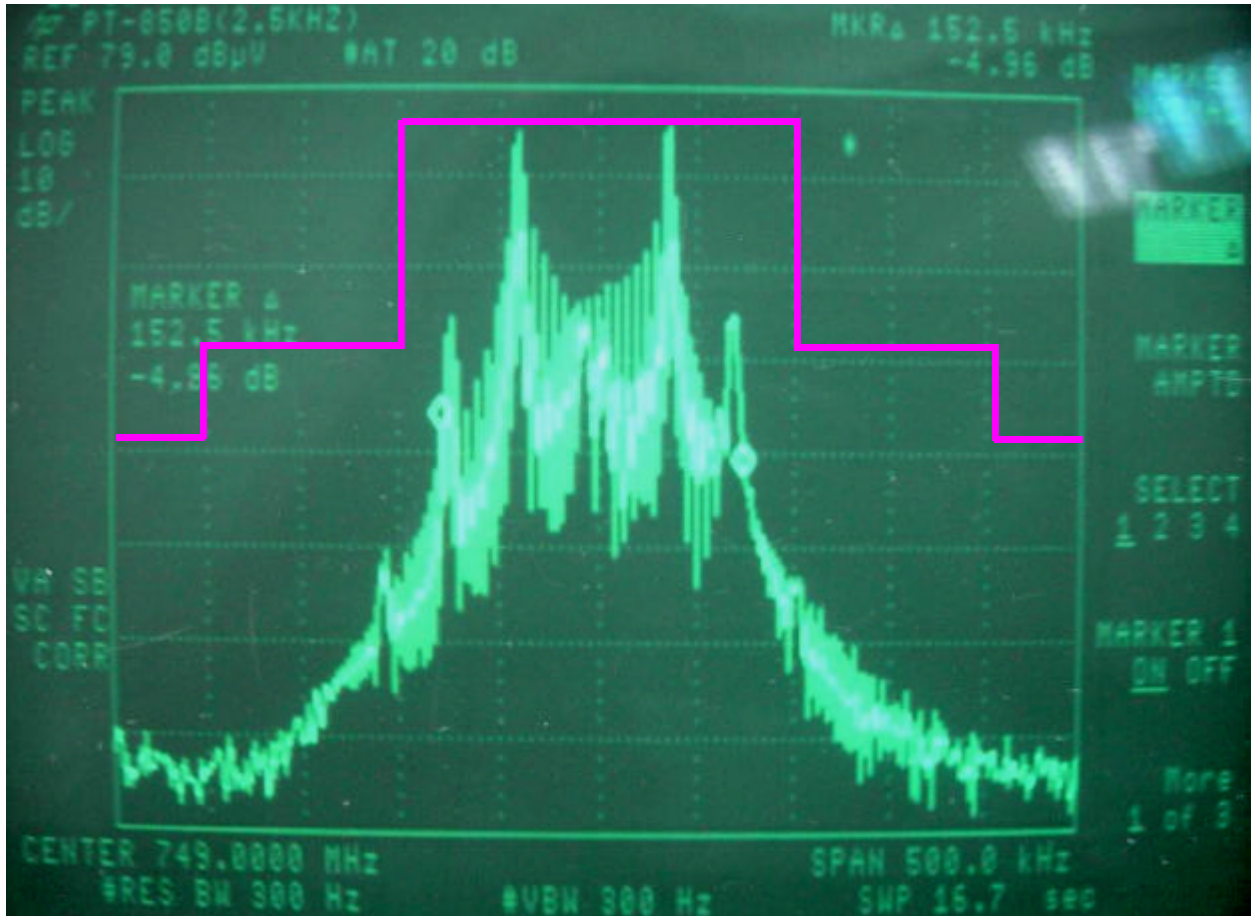

13.5kHz modulation

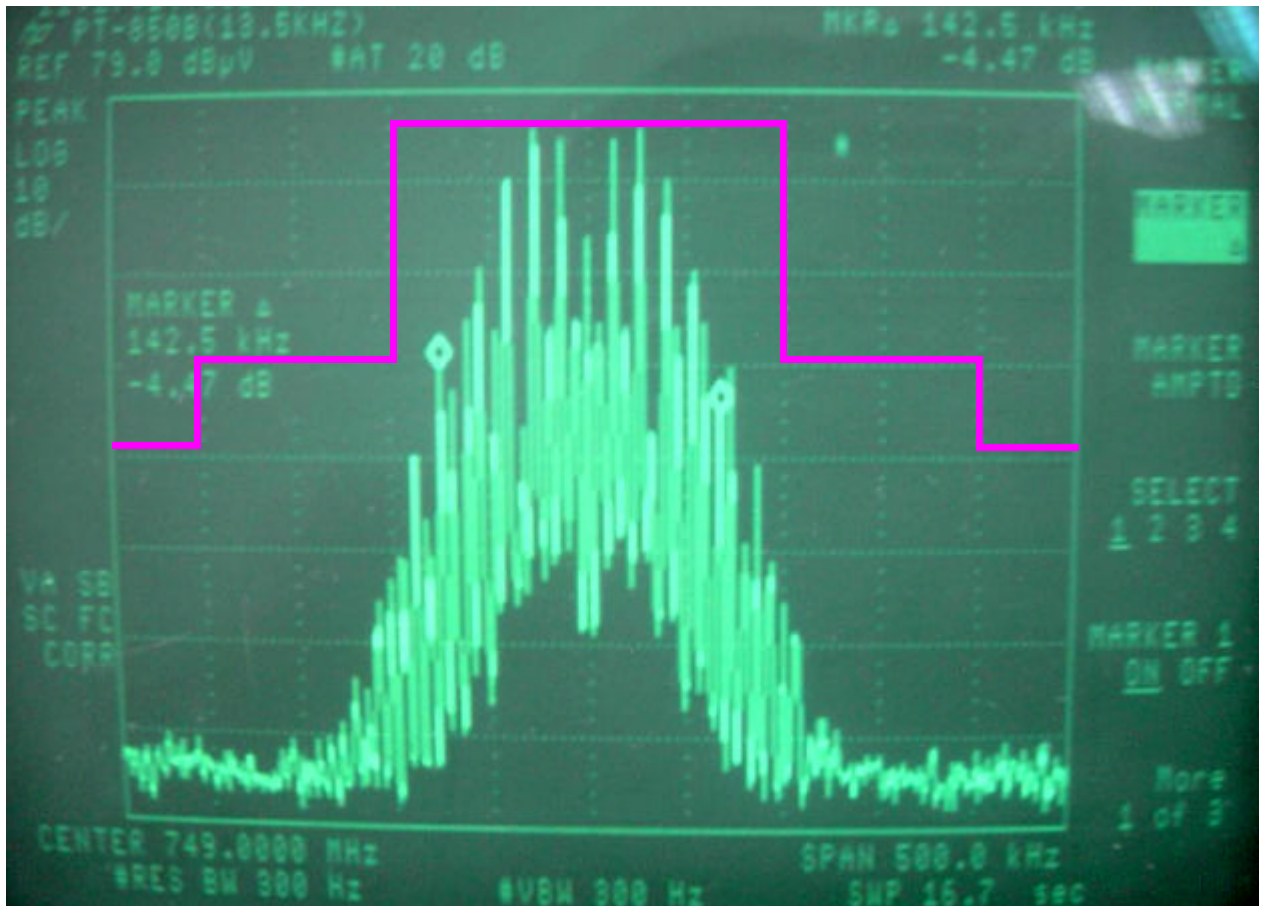

15kHz modulation

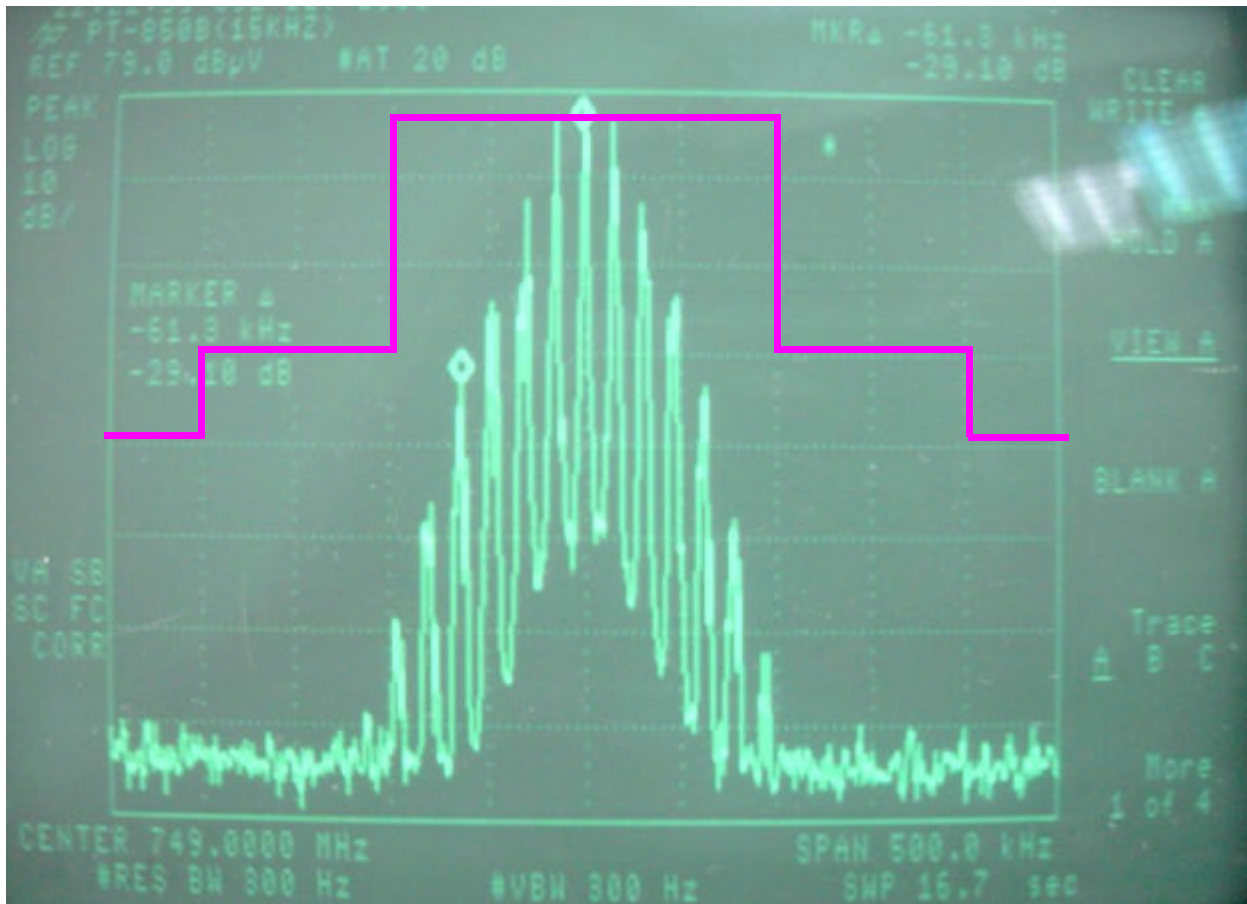

Chapter 6 Field Strength of Spurious Radiation Measurement

6.1 Rules and Specification Limits

2.1053(a): ANSI/ TIA/ EIA-603-1992, Paragraph 2.2.12

Measurements shall be made to detect spurious emissions that may be radiated directly from the cabinet, control circuits, Power leads, or intermediate circuit elements under normal conditions of installation and operation.

74.861(e)(6)(iii):

Spurious and harmonics must be at least $43 + 10 \log (\text{Output Power})$ below the Carrier peak

2.1057:

In all measurements set forth, the spectrum should be investigated from the lowest radio frequency generated in the equipment up to at least the 10th harmonic of the carrier frequency.

6.2 Measurement Condition & Setup

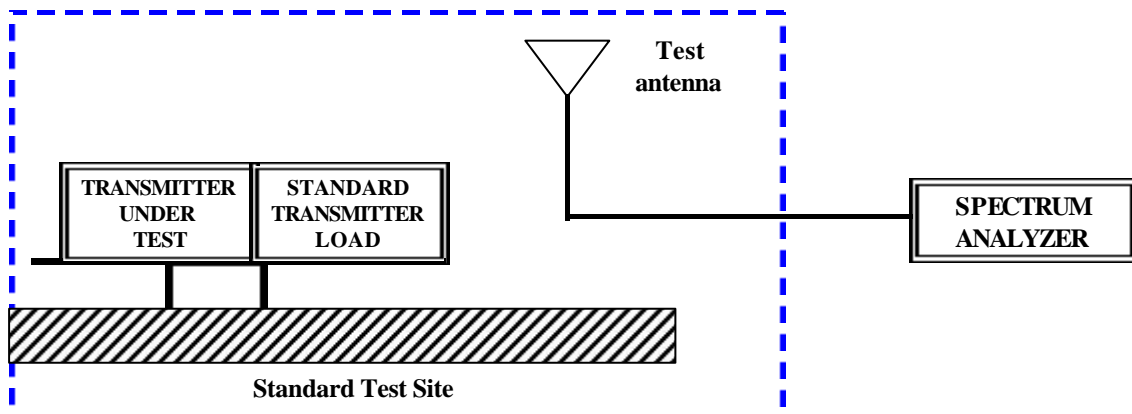

1. Connect the equipment as illustrated.

2. Adjust the spectrum analyzer for the following setting:
 - a) Resolution Bandwidth 3kHz
 - b) Video Bandwidth 10kHz
 - c) Sweep Speed 2000Hz /second
 - d) Detector mode = Positive Peak
3. Place the transmitter to be tested on the turntable in the standard test site. The transmitter is transmitting into a non-radiating load, which is placed on the turntable. The RF cable to this load should be of minimum length.
4. For each spurious measurement the test antenna should be adjusted to the correct length for the frequency involved. The length may be determined from a calibration ruler supplied with the equipment. Measurements shall be made from the lowest radio frequency generated in the equipment to the tenth harmonic of the carrier, except for the region close to the carrier equal to \pm the test bandwidth (see section 1.3.4.4)
5. For each spurious frequency, raise and lower the test antenna from 1m to 4m to obtain a maximum reading on the spectrum analyzer with the test antenna at horizontal polarity. Then the turntable should be rotated 360° to determine the maximum reading. Repeat this procedure to obtain the highest possible reading. Record this maximum reading.
6. Repeat step (5) for each spurious frequency with the test antenna polarized vertically.

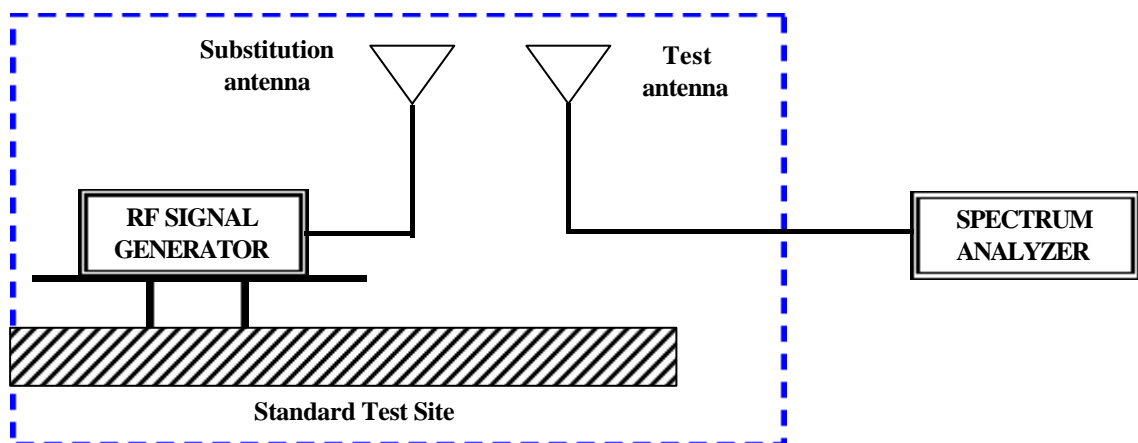

7. Reconnect the equipment as illustrated.
8. Keep the spectrum analyzer adjusted as in step (2)

9. Remove the transmitter and replace it with a substitution antenna (the antenna should be half-wavelength for each frequency involved). The center of the substitution antenna should be approximately at the same location as the center of the transmitter. At the lower frequencies, where the substitution antenna is very long, this will be impossible to achieve when the antenna is polarized vertically. In such case the lower end of the antenna should be 0.3m above the ground.
10. Feed the substitution antenna at the transmitter end with a signal generator connected to the antenna by means of a non-radiating cable. With the antennas at both ends horizontally polarized and with the signal generator tuned to a particular spurious frequency, raise and lower the test antenna to obtain a maximum reading at the spectrum analyzer. Adjust the level of the signal generator output until the previously recorded maximum reading for this set of conditions is obtained. This should be done carefully repeating the adjustment of the test antenna and generator output.
11. Repeat step (10) with both antennas vertically polarized for each spurious frequency.
12. Calculate power in dBm into a reference ideal half-wave dipole antenna by reducing the readings obtained in steps (10) and (11) by the power loss in the cable between the generator and the antenna and further corrected for the gain of the substitution antenna used relative to an ideal half-wave dipole antenna.
13. The levels record in step (12) are the absolute levels of radiated spurious emissions in dBm. The radiated spurious emissions in dB can be calculated by the following:

Radiated spurious emissions (dB) =

$$10 \log_{10} \left[\frac{\text{TX power in watts}}{0.001} \right] - \text{the levels in step (12)}$$

6.3 List of Measurement Instruments

<u>Instrument Name</u>	<u>Model No.</u>	<u>Brand</u>	<u>Serial No.</u>	<u>Calibration Date</u>	
				<u>Last time</u>	<u>Next time</u>
Spectrum analyzer	8594EM	H P	3710A00279	12/26/02	12/26/03
Pre-selector (>30MHz)	AMP-01	TRC	REP-001	10/20/02	10/20/03
Bi-log Antenna	CBL 6141A	Chase	4206	05/27/03	05/27/04
Switch/Control Unit (> 30MHz)	3488A	HP	N/A	11/20/02	11/20/03
Auto Switch Box (> 30MHz)	ASB-01	TRC	9904-01	11/20/02	11/20/03
Spectrum Analyzer	8564E	HP	US36433002	08/01/02	08/01/03
Microwave Preamplifier	83051A	HP	3232A00347	08/01/02	08/01/03
Horn Antenna	3115	EMCO	9704 – 5178	08/01/02	08/01/03
Horn Antenna	RA42-K-F-4B-C		CMT	961505-003	
	02/01/03	02/01/04			
Anechoic Chamber (cable calibrated together)			05/20/03	05/20/04	

The level of confidence of 95% , the uncertainty of measurement of radiated emission is ± 3.44 dB .

6.4 Measurement Result:

Test Conditions:

Testing room : Temperature : 22 °C Humidity : 58 % RH

Test mode: Lowest band --- 692.000MHz, Ant. polarity -- Horizontal

<i>Frequency</i>	<i>Reading Amplitude</i>	<i>Ant. Height</i>	<i>Table</i>	<i>Correction Factors</i>	<i>Corrected Power</i>	<i>Attenuated below the mean power</i>	<i>Minimum Attenuation limit</i>
MHz	dBm	m	degree	dB	dBm	dBc	dBc
2082.00	-50.94	1.00	31	2.11	-53.05	67.67	27.62
4850.00	-73.64	1.00	9	-24.07	-49.57	64.19	
5545.00	-62.63	1.00	175	-21.91	-40.72	55.34	
6915.00	-64.78	1.00	137	-17.81	-46.97	61.59	
7600.00	-60.36	1.00	289	-17.59	-42.77	57.39	
8305.00	-56.97	1.00	120	-14.62	-42.35	56.97	

Test mode: Lowest band – 692.000MHz, Ant. polarity -- Vertical

<i>Frequency</i>	<i>Reading Amplitude</i>	<i>Ant. Height</i>	<i>Table</i>	<i>Correction Factors</i>	<i>Corrected Power</i>	<i>Attenuated below the mean power</i>	<i>Minimum Attenuation limit</i>
MHz	dBm	m	degree	dB	dBm	dBc	dBc
2082.50	-47.65	1.00	76	2.11	-49.76	64.38	27.62
5545.00	-62.81	1.00	246	-21.91	-40.90	55.52	
6230.00	-70.47	1.00	221	-19.98	-50.49	65.11	
6920.00	-62.48	1.00	30	-17.74	-44.74	59.36	
7600.00	-56.05	1.00	176	-17.59	-38.46	53.08	
8305.00	-55.02	1.00	20	-14.62	-40.40	55.02	

Note:

- 1. Corrected Amplitude = Reading Amplitude – Correction Factors**
- 2. The maximum field measured is 14.62 dBm**
 Attenuated below the mean power = Power – Corrected Power
 { For example: 14.62 – (-53.05) = 67.67 dBc }
- 3. Attenuation required = 43 + 10 log (29.0 mW) = 27.62**

Test Conditions:

Testing room : Temperature : 22 °C Humidity : 58 % RH

Test mode: Middle band --- 749.000MHz, Ant. polarity -- Horizontal

<i>Frequency</i>	<i>Reading Amplitude</i>	<i>Ant. Height</i>	<i>Table</i>	<i>Correction Factors</i>	<i>Corrected Power</i>	<i>Attenuated below the mean power</i>	<i>Minimum Attenuation limit</i>
MHz	dBm	m	degree	dB	dBm	dBc	dBc
2250.00	-43.01	1.00	109	2.67	-45.68	58.80	26.12
2997.50	-40.53	1.00	256	4.16	-44.69	57.81	
3755.00	-70.08	1.00	189	-25.63	-44.45	57.57	
6000.00	-66.60	1.00	10	-21.60	-45.00	58.12	
6740.00	-51.96	1.00	337	-18.54	-33.42	46.54	
7485.00	-60.60	1.00	28	-17.10	-43.50	56.62	

Test mode: Middle band --- 749.000MHz, Ant. polarity -- Vertical

<i>Frequency</i>	<i>Reading Amplitude</i>	<i>Ant. Height</i>	<i>Table</i>	<i>Correction Factors</i>	<i>Corrected Power</i>	<i>Attenuated below the mean power</i>	<i>Minimum Attenuation limit</i>
MHz	dBm	m	degree	dB	dBm	dBc	dBc
2250.00	-37.56	1.00	22	2.67	-40.23	53.35	26.12
2997.50	-28.66	1.00	189	4.16	-32.82	45.94	
3750.00	-68.07	1.00	350	-25.56	-42.51	55.63	
6740.00	-53.07	1.00	28	-18.54	-34.53	47.65	
7480.00	-55.98	1.00	109	-17.09	-38.89	52.01	
8240.00	-60.02	1.00	246	-14.52	-45.50	58.62	

Note:

- 1. Corrected Amplitude = Reading Amplitude – Correction Factors**
- 2. The maximum field measured is 13.12dBm**
 Attenuated below the mean power = Power – Corrected Power
- 3. Attenuation required = 43 + 10 log (20.52mW) = 26.12**

Test Conditions:

Testing room : Temperature : 22 °C Humidity : 58 % RH

Test mode: Highest band --- 806.000MHz, Ant. polarity -- Horizontal

<i>Frequency</i>	<i>Reading Amplitude</i>	<i>Ant. Height</i>	<i>Table</i>	<i>Correction Factors</i>	<i>Corrected Power</i>	<i>Attenuated below the mean power</i>	<i>Minimum Attenuation limit</i>
MHz	dBm	m	degree	dB	dBm	dBc	dBc
1615.00	-53.22	1.00	55	3.23	-55.87	67.09	24.22
5650.00	-72.12	1.00	279	-21.65	-49.66	60.88	
7245.00	-71.16	1.00	17	-17.92	-50.21	61.43	

Test mode: Highest band --- 806.000MHz, Ant. polarity -- Vertical

<i>Frequency</i>	<i>Reading Amplitude</i>	<i>Ant. Height</i>	<i>Table</i>	<i>Correction Factors</i>	<i>Corrected Power</i>	<i>Attenuated below the mean power</i>	<i>Minimum Attenuation limit</i>
MHz	dBm	m	degree	dB	dBm	dBc	dBc
4045.00	-77.97	1.00	149	-25.71	-52.26	63.48	24.22
5650.00	-67.45	1.00	247	-21.65	-45.80	57.02	
6450.00	-71.17	1.00	158	-19.70	-51.47	62.69	
7245.00	-68.65	1.00	224	-17.92	-50.73	61.95	
8050.00	-61.30	1.00	37	-15.69	-45.61	56.83	
8395.00	-62.85	1.00	347	-14.56	-48.29	59.51	

Note:

- 1. Corrected Amplitude = Reading Amplitude – Correction Factors**
- 2. The maximum field measured is 11.22dBm**
Attenuated below the mean power = Power – Corrected Power
- 3. Attenuation required = 43 + 10 log (13.25mW) = 24.22**

Chapter 7 Frequency Stability Tolerance Measurement

7.1 Rules and Specification Limits

2.1055, ANSI/ TIA/ EIA-603-1992, Paragraph 2.2.2 .

74.861(e) (4): The frequency tolerance of the transmitter shall be 0.005 percent.

7.2 Measurement Condition & Setup with Temperature Variation

1. Place the EUT in the chamber, powered in its normal operation.
2. Set the temperature of the chamber -30 degree Centigrade. Allow the equipment to stabilize at that temperature.
3. Measured the carrier frequency using preamplifier and frequency counter.
4. Repeated procedures 1 to 3 from -20 to 50 degree Centigrade at intervals of 10 degree.

7.3 List of Measurement Instruments with Temperature Variation List of test Instrument

<u>Instrument Name</u>	<u>Model No.</u>	<u>Brand</u>	<u>Remark</u>
Spectrum Analyzer	8591A	H P	1.8GHz
Temperature Chamber	THS-MV2	King Son	
Near field Probe	7405-901	EMCO	
Power Supply	GPR-6030	Good Will	
Auto Transformer	Powerstat	Supprior Elec. Co.	

7.4 Measurement Configuration of Temperature Variation Test:

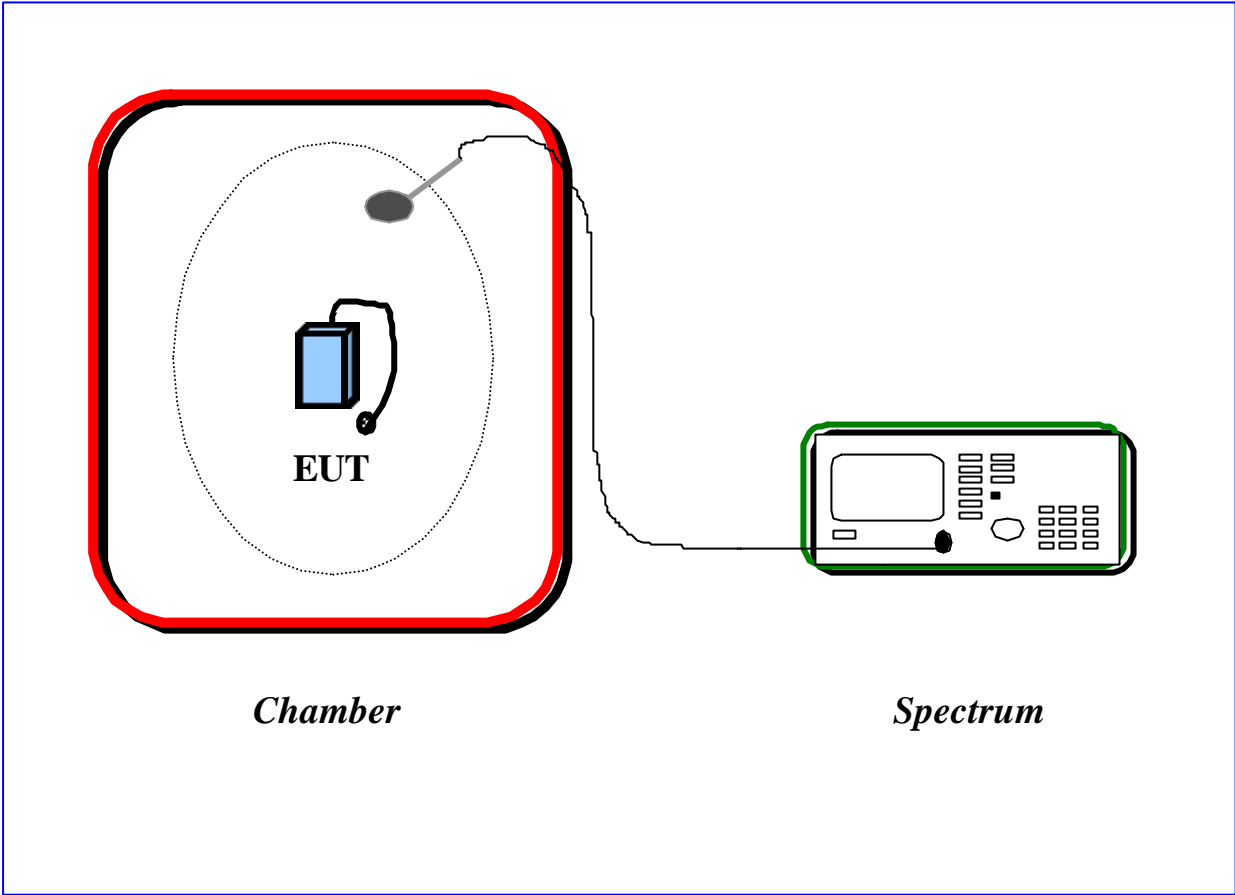

7.5 Measurement Result with Temperature Variation

A plot and table is presented which illustrates compliance with the rule where the center frequency is 749.000MHz.

Temperature Variation Table

<i>Temperature (Centigrade)</i>	<i>Frequency (MHz)</i>	<i>Tolerance (MHz)</i>
-30	748.99051	748.96255 To 749.03745
-25	748.99043	
-20	748.99048	
-15	748.99062	
-10	748.99090	
-5	748.99137	
0	748.99259	
5	748.99436	
10	748.99717	
15	748.99778	
20	748.99875	
25	748.99949	
30	748.99928	
35	748.99937	
40	748.99956	
45	748.99966	
50	748.99982	

Chart 7.1 Temperatuer Variation Vs. Frequency

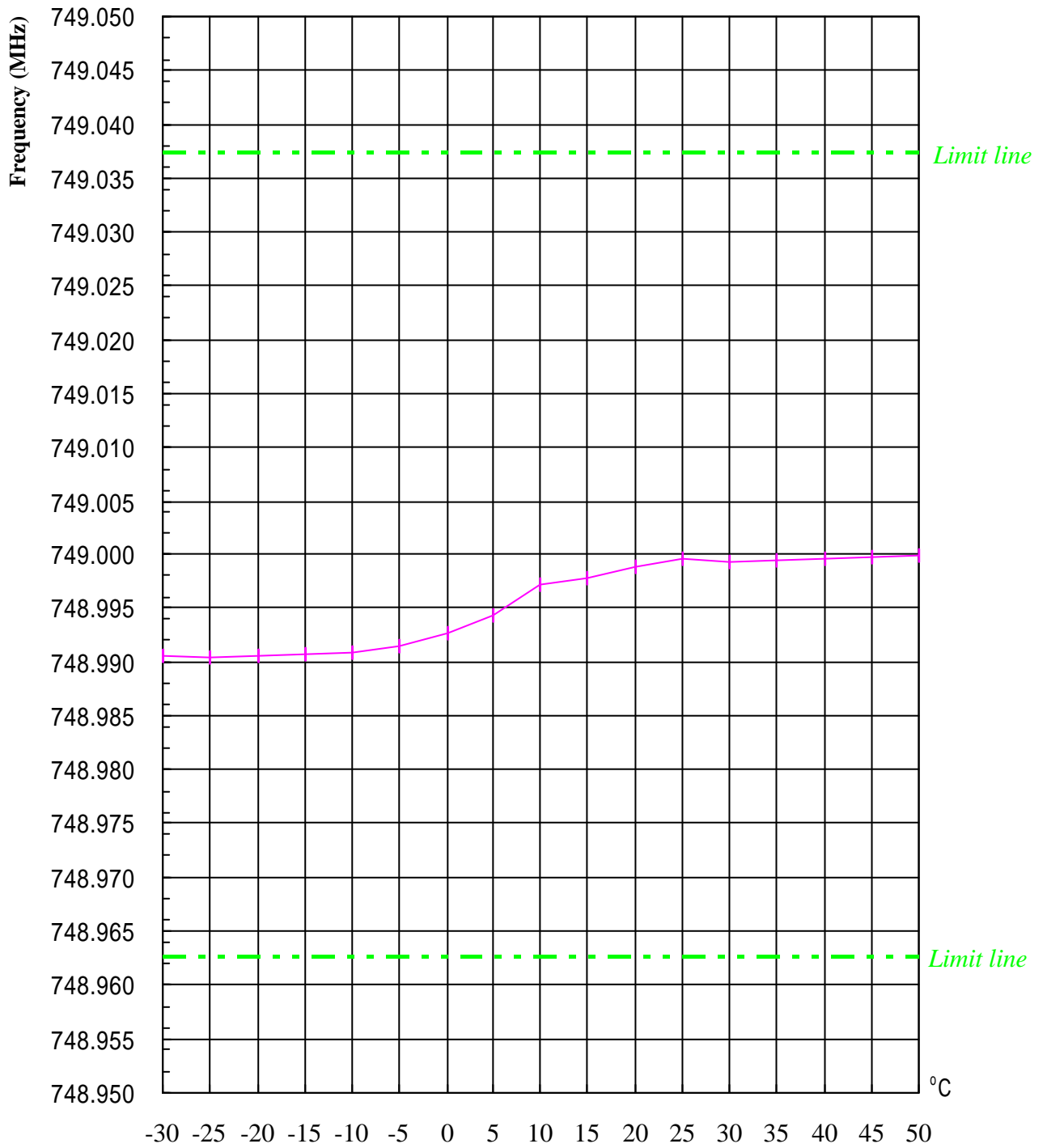

7.6 Measurement Condition & Setup with Voltage Variation

1. Attached the power line of the power supply to the battery position of the EUT.
2. Tuned the output power level to battery end point, 85 %, 100%, 115% of the normal operation power of EUT.
3. Recorded the frequency with a frequency counter.

7.7 Configuration of Voltage Variation Test

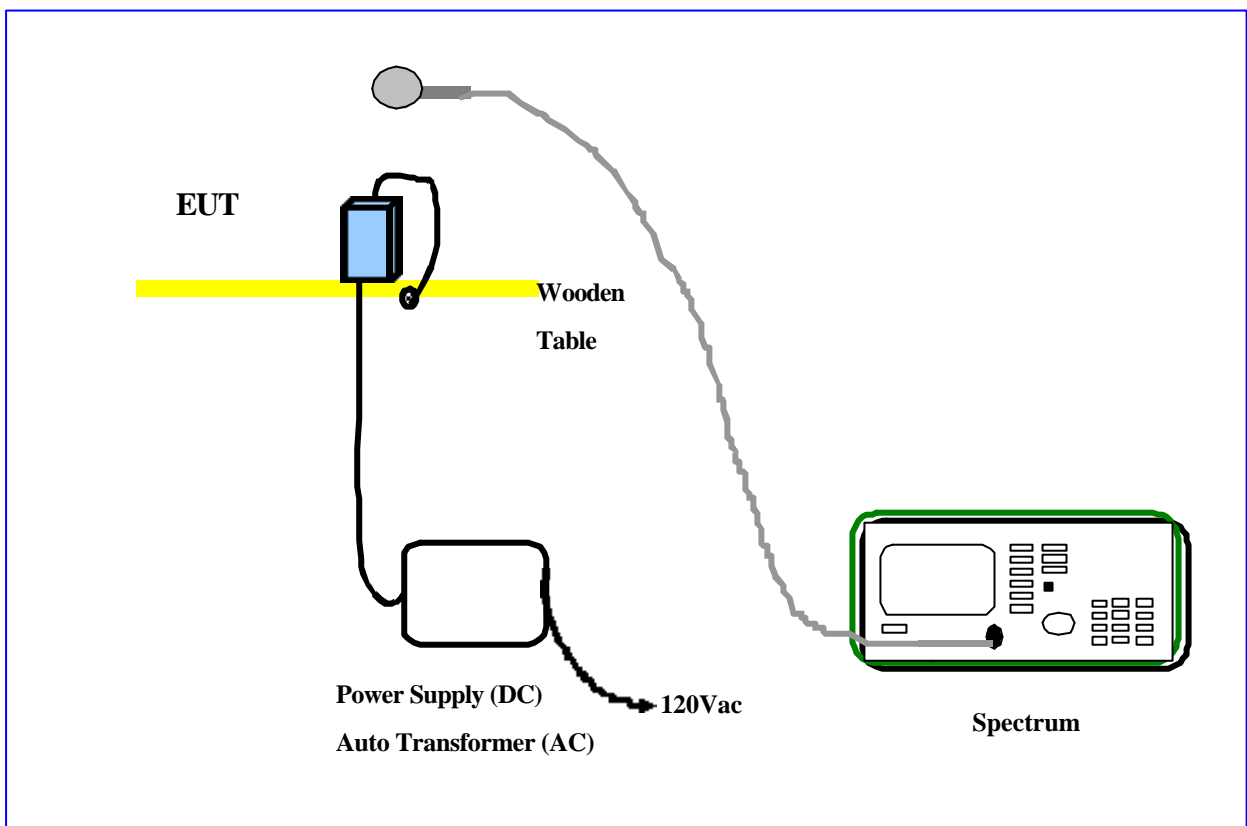

7.8 Measurement Result with Voltage Variation

Frequency Stability of Voltage Variation Measurement Table

Supply Voltage (Volt)	Frequency (MHz)	Tolerance (MHz)
2.55 (85%)	748.99948	748.96255 To 749.03745
3.00 (100%)	748.99949	
3.45 (115%)	748.99948	
Endpoint Voltage (Volt)	Frequency (MHz)	Tolerance (MHz)
1.595	748.99931	748.96255 ~ 749.03745

Chart 7.2 Voltage Variation Vs. Frequency

