



Shenzhen Certification Technology Service Co., Ltd
2F, Building B, East Area of Nanchang Second Industrial
Zone, Gushu 2nd Road, Bao'an District, Shenzhen
518126, P.R. China.

TEST REPORT

FCC ID: INC-66121

Applicant : Zhejiang Focus-On Import and Export Co., Ltd
Address : 11F, Binhai Building, 480 Jiangnan Dadao, Binjiang District,
Hangzhou, China

Equipment under Test (EUT):

Name : RF wireless headphone
Model : 66121

Standards : FCC Part15.239

Report No. : STE120516574

Date of Test : May 18-20, 2012

Date of Issue : May 21, 2012

Test Result :	PASS *
----------------------	---------------

* In the configuration tested, the EUT complied with the standards specified above

Authorized Signature

(Mark Zhu)
General Manager

The manufacture should ensure that all the products in series production are in conformity with the product sample detailed in this report.

If the product in this report is used in any configuration other than that detailed in the report, the manufacturer must ensure the new system complies with all relevant standards. Any mention of Shenzhen Certification Technology Service Co., Ltd. Or test done by Shenzhen Certification Technology Service Co., Ltd. Approvals in connection with, distribution or use of the product described in this report must be approved by Shenzhen Certification Technology Service Co., Ltd. Approvals in writing.

TABLE OF CONTENT

Description	Page
1 General Information -----	3
1.1 Description of Device (EUT)-----	3
1.2 Description of Test Facility-----	4
2 Test Equipment List -----	4
3 Test Procedure -----	5
4 Summary of Measurement -----	6
5 POWER LINE CONDUCTED EMISSION -----	7
5.1 Conducted Emission Limits(15.209)-----	7
5.3 Test Setup-----	7
5.3 Test Procedure-----	8
5.4 Test Resluts-----	8
6 Radiated Emission Test -----	9
6.1 Radiated Emission Limits(15.209&239)-----	9
6.2 Test Setup for Emission measurement-----	10
6.3 Test Procedure -----	11
6.4 Test Condition -----	12
7 Bandwidth Test -----	17
7.1 Limit for Bandwidth -----	17
7.2 Method of measurement -----	17
7.3 Test Setup-----	17
7.4 Test Results-----	17
8 Band Edge Test -----	18
8.1 Test Limit-----	18
8.2 Test Procedure -----	18
8.3 Test Results -----	18
9 Antenna Requirement -----	19
9.1 Standard requirement -----	19
9.2 Result -----	19
10 Photographs of Test Setup -----	20
11 Photographs of EUT -----	21

1 General Information

1.1 Description of Device (EUT)

Trade Name : N/A

EUT : RF wireless headphone

Model No. : 66121
:

Type of Antenna : Integral Antenna, Max Gain 0dBi.

Operation Frequency : 88.1

Modulation type FM

Power Supply : DC 3V Supply by Battery

Applicant : Zhejiang Focus-On Import and Export Co., Ltd
Address : 11F, Binhai Building, 480 Jiangnan Dadao,
Binjiang District, Hangzhou, China

Manufacturer : Zhejiang Focus-On Import and Export Co., Ltd
Address : 11F, Binhai Building, 480 Jiangnan Dadao,
Binjiang District, Hangzhou, China

1.2 Description of Test Facility

Shenzhen Certification Technology Service Co., Ltd.
2F, Building B, East Area of Nanchang Second Industrial Zone,
Gushu 2nd Road, Bao'an District, Shenzhen 518126, P.R. China
FCC Registered No.:197647

1.3 Test Equipment List

Equipment	Manufacture	Model No.	Serial No.	Last cal.	Cal Interval
3m Semi-Anechoic	ETS-LINDGREN	N/A	SEL0017	06/06/2011	1Year
Spectrum analyzer	Agilent	E4443A	MY46185649	06/06/2011	1Year
Receiver	R&S	ESCI	100492	04/06/2011	1Year
Receiver	R&S	ESCI	101202	07/01/2012	1Year
Bilog Antenna	SCHWARZBECK	VULB 9168	VULB9168-438	04/06/2011	1Year
L.I.S.N.	SCHWARZBECK	NSLK8126	8126466	16/06/2011	1Year
Loop Antenna	R&S	FMZB1516	1516131	04/06/2011	1Year
ETS Horn Antenna	ETS	3160	SEL0076	12/08/2011	1Year
Cable	Resenberger	N/A	No.1	04/06/2011	1Year
Cable	SCHWARZBECK	N/A	No.2	04/06/2011	1Year
Cable	SCHWARZBECK	N/A	No.3	04/06/2011	1Year
Pre-amplifier	SCHWARZBECK	BBV9743	9743-019	06/06/2011	1Year
Pre-amplifier	R&S	AFS33-18002650-30-8P-44	SEL0080	06/06/2011	1Year

2 Test Procedure

POWER LINE CONDUCTED INTERFERENCE: The test procedure used was ANSI Standard C63.4-2003 using a 50 μ H LISN. Both Lines were observed. The bandwidth of the receiver was 10kHz with an appropriate sweep speed. The ambient temperature of the EUT was 25°C with a humidity of 58%.

RADIATION INTERFERENCE: The test procedure used was ANSI Standard C63.4-2003 using a ANRITSU spectrum analyzer with a pre-selector. The analyzer was calibrated in dB above a micro volt at the output of the antenna. The resolution bandwidth was 100kHz and the video bandwidth was 300 kHz up to 1 GHz and 1 MHz with a video BW of 3MHz above 1 GHz. The ambient temperature of the EUT was 25°C with a humidity of 58%.

FORMULA OF CONVERSION FACTORS: The Field Strength at 3m was established by adding the meter reading of the spectrum analyzer (which is set to read in units of dBuV) to the antenna correction factor supplied by the antenna manufacturer and cable loss. The antenna correction factors and cable loss are stated in terms of dB. The gain of the Pre-selector was accounted for in the Spectrum Analyzer Meter Reading.

Example:

Freq (MHz) METER READING + ACF + CABLE = FS

33.20 dBuV + 10.36 dB + 0.9 dB= 44.46 dBuV/m @ 3m

ANSI STANDARD C63.4-2003 10.1.7 MEASUREMENT PROCEDURES: The EUT was placed on a table 80 cm high and with dimensions of 1m by 1.5m. The EUT was placed in the center of the table (1.5m side). The table used for radiated measurements is capable of continuous rotation. When an emission was found, the table was rotated to produce the maximum signal strength. At this point, the antenna was raised and lowered from 1m to 4m. The antenna was placed in both the horizontal and vertical planes. The situation was similar for the conducted measurement except that the table did not rotate. The EUT was setup as described in ANSI Standard C63.4-2003 10.1.7 with the EUT 40 cm from the vertical ground wall.

3 Summary of Measurement

Test Item	Test Requirement	Standard Paragraph	Result
Antenna Requirement	FCC PART15	15.203	Compliance
Conducted Emission	FCC PART15	15.207	Not applicable
Radiation Emission	FCC PART15	15.209&15.239	Compliance
Bandwidth Requirement	FCC PART15	15.239	Compliance
Band edge Requirement	FCC PART15	15.239	Compliance

Note: The EUT has been tested as an independent unit. And Continual transmitting in maximum power (The new battery be used during Test).

The EUT has been tested on under the worst case test mode, has tested the modulation mode.

Input signals have been debugged to ensure that it is the worst mode.

The audio source and EUT worked during the measurements.

EUT only operates on one fixed frequency.

A continuously playing 1KHz modulation mode audio source (Name: IPod, Brand: Apple, Model: A1238, S/N: 2Z8181UQYMV) was connected during the test. The volume of the audio source was set to maximum to represent the worst case. The transmitter was transmitting continuously.

4 POWER LINE CONDUCTED EMISSION

4.1 Conducted Emission Limits(15.209)

Frequency MHz	Limits dB(μ V)	
	Quasi-peak Level	Average Level
0.15 -0.50	66 -56*	56 - 46*
0.50 -5.00	56	46
5.00 -30.00	60	50

Notes: 1. *Decreasing linearly with logarithm of frequency.

2. The lower limit shall apply at the transition frequencies.

3. The limit decreases in line with the logarithm of the frequency in the rang of 0.15 to 0.50 MHz.

4.1 Test Setup

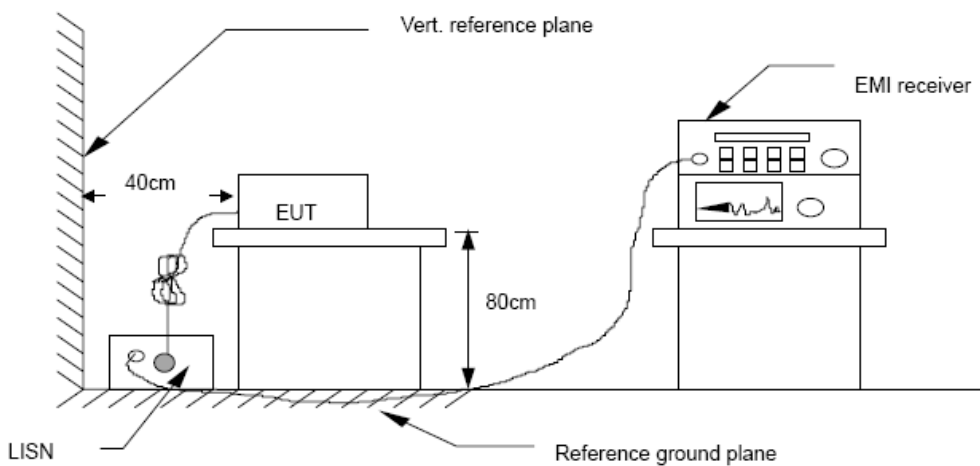

4.1 Test Procedure

The EUT is put on the plane 0.8m high above the ground by insulating support and is connected to the power mains through a line impedance stabilization network (L.I.S.N.). This provides a 50ohm coupling impedance for the EUT system. Please refer the block diagram of the test setup and photographs. Both sides of AC lines are checked to find out the maximum conducted emission. In order to find the maximum emission levels, the relative positions of equipment and all of the interface cables shall be changed according to ANSI C63.4-2003 on Conducted Emission Measurement. The bandwidth of test receiver (R & S ESCS30) is set at 9 kHz.

5.4 Test Results

EUT is power supply by battery, so the test not applicable.

5 Radiated Emission Test

6.1 Radiated Emission Limits(15.209&239)

Frequency (MHZ)	Field Strength Limits at 3 metres (watts,e.i.r.p.)		
	uV/m	dB uV/m	Measurement distance(m)
0.009-0.490	2400/F(kHz)	XX	300
0.490-1.705	24000/F(kHz)	XX	30
1.705-30	30	29.5	30
30~88	100(3nW)	40	3
88~216	150(6.8nW)	43.5	3
216~960	200(12nW)	46	3
Above960	500(75nW)	54	3
Carrier frequency	250	48(AV)	3
Carrier frequency		68(PK)	3

NOTE:

- a) The tighter limit applies at the band edges.
- b) Emission Level(dB uV/m)=20log Emission Level(uV/m)
- c) XX means the limit is unsure

6.2 Test Setup for Emission measurement

Test Setup for Emission Below 30MHz

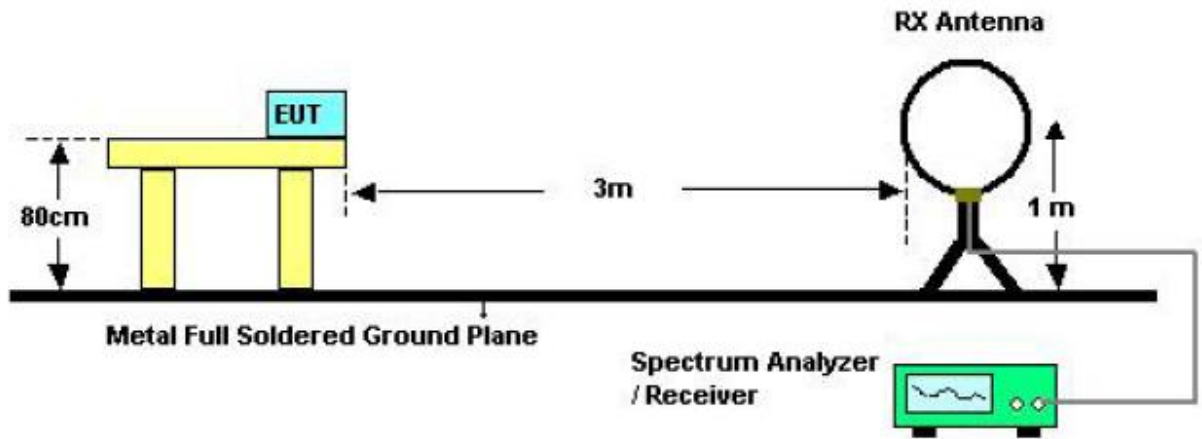

Test Setup for Emission above 30MHz

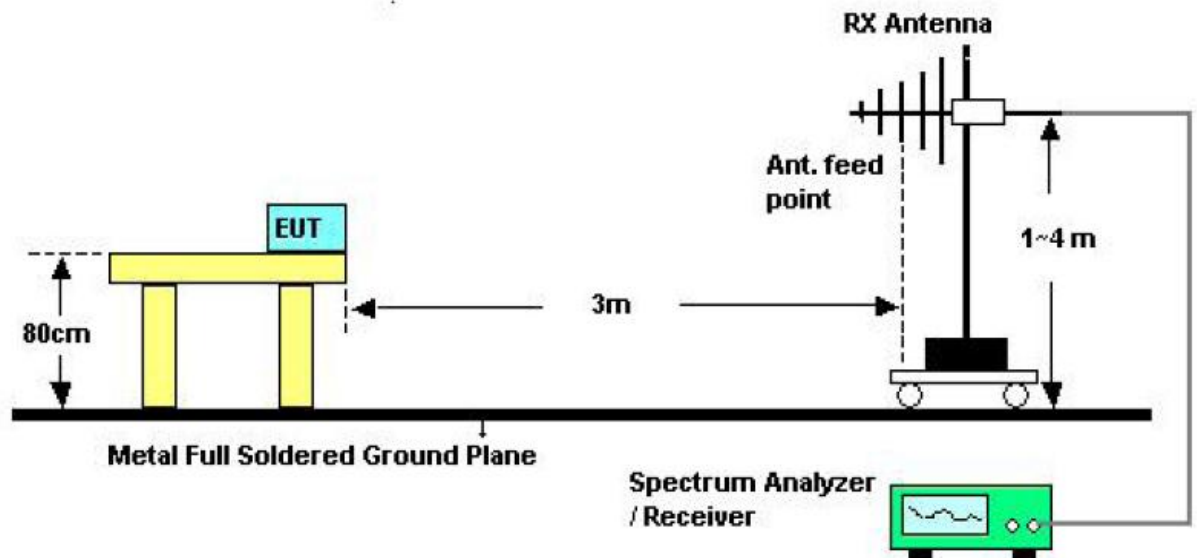

Test Setup for Emission above 1GHz

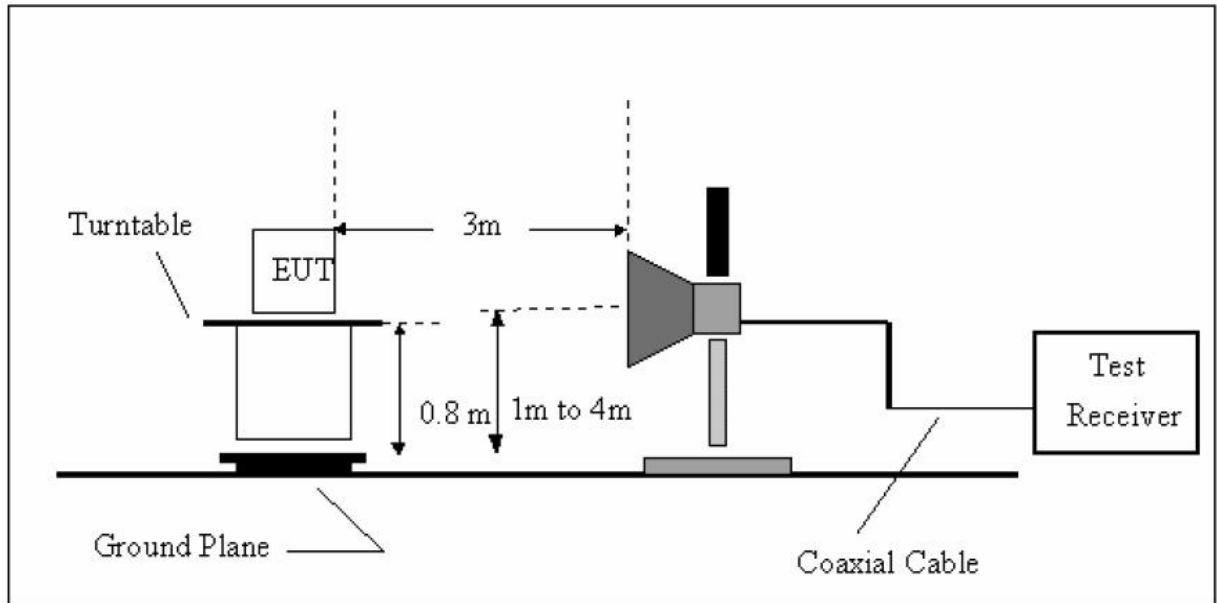

6.3 Test Procedure

- a) The measuring distance of 3m shall be used for measurements at frequency up to 1GHz and above 1 GHz, The EUT was placed on a rotating 0.8 m high above ground. The table was rotated 360 degrees to determine the position of the highest radiation
- b) The Test antenna shall vary between 1m and 4m. Both Horizontal and Vertical antenna are set to make measurement.
- c) The initial step in collecting conducted emission data is a spectrum analyzer Peak detector mode pre-scanning the measurement frequency range. Significant Peaks are then marked and then Qusia Peak Detector mode premeasured
- d) If Peak value comply with QP limit Below 1GHZ.The EUT deemed to comply with QP limit. But the Peak value and average value both need to comply with applicable limit above 1GHZ.
- e) For the actual test configuration, please see the test setup photo.

f) Test Equipment Setting For emission test:

9KHz-30MHz:
RBW 3KHZ VBW 10KHZ

30MHZ~1GHZ:
RBW 120KHZ VBW 300KHZ

Above 1GHZ :
RBW 1MHZ VBW 3MHZ for Peak value
RBW 1MHZ VBW 10HZ for Average Value

6.4 Test Condition

A continuously playing 1KHz modulation mode audio source (Name: IPod, Brand: Apple, Model: A1238, S/N: 2Z8181UQYMV) was connected during the test. The volume of the audio source was set to maximum to represent the worst case. The transmitter was transmitting continuously.

We have scanned the 10th harmonic from 9KHz to the EUT.

6.5 Test Results

Radiated Emissions Result of Outside the band (88~108MHZ)

EUT	RF wireless headphone	Model Name	KST-670B
Temperature	26°C	Relative Humidity	58%
Pressure	960hPa	Test voltage	DC 3V Supply by battery
Test Mode	TX	TX frequency	88.1MHZ

Antenna polarization: Vertical								
Frequency MHZ	Reading dBuV	Cable Loss dB	Antenna Factor dB	Amplifier Gain	Correct Factor dB	Measurement Result dBuV/m	Limit line dBuV/m	Over Margin
175.50	55.65	1.27	12.28	30.93	-17.38	38.27	43.50	-5.23
263.77	57.48	1.74	11.90	31.13	-17.49	39.99	46.00	-6.01
352.04	55.70	2.21	13.87	31.28	-15.20	40.50	46.00	-5.50
528.58	52.20	3.06	17.03	31.68	-11.59	40.61	46.00	-5.39
705.12	47.76	3.41	19.72	31.75	-8.62	39.14	46.00	-6.86
969.93	52.53	3.94	22.20	31.60	-5.46	47.07	54.00	-6.93
--	--	--	--	--	--	--	--	--

Antenna polarization: Horizontal								
Frequency MHZ	Reading dBuV	Cable Loss dB	Antenna Factor dB	Amplifier Gain	Correct Factor Db	Measurement Result dBuV/m	Limit line dBuV/m	Over Margin
175.50	57.01	1.27	12.28	30.93	-17.38	39.63	43.50	-3.87
264.74	56.47	1.74	11.96	31.13	-17.43	39.04	46.00	-6.96
352.04	54.83	2.21	13.87	31.28	-15.20	39.63	46.00	-6.37
440.31	54.25	2.68	15.72	31.47	-13.07	41.18	46.00	-4.82
616.85	49.91	3.23	18.62	31.81	-9.96	39.95	46.00	-6.05
793.39	47.75	3.59	20.66	31.66	-7.41	40.34	46.00	-5.66
--	--	--	--	--	--	--	--	--

Notes: --Means other frequency and mode comply with standard requirements and at least have 20dB margin.

The test mode is worst mode.

Correct Factor=Cable Loss+ Antenna Factor-Amplifier Gain

Measurement Result=Reading + Correct Factor

Margin=Measurement Result-Limit



Shenzhen Certification Technology Service Co., Ltd.
 2F, Building B, East Area of Nanchang Second Industrial Zone,
 Gushu 2nd Road, Bao'an District, Shenzhen 518126, P.R. China
 Tel: 4006786199 FAX: +86-755-26736857
 Website: <http://www.cessz.com> Email: Service@cessz.com

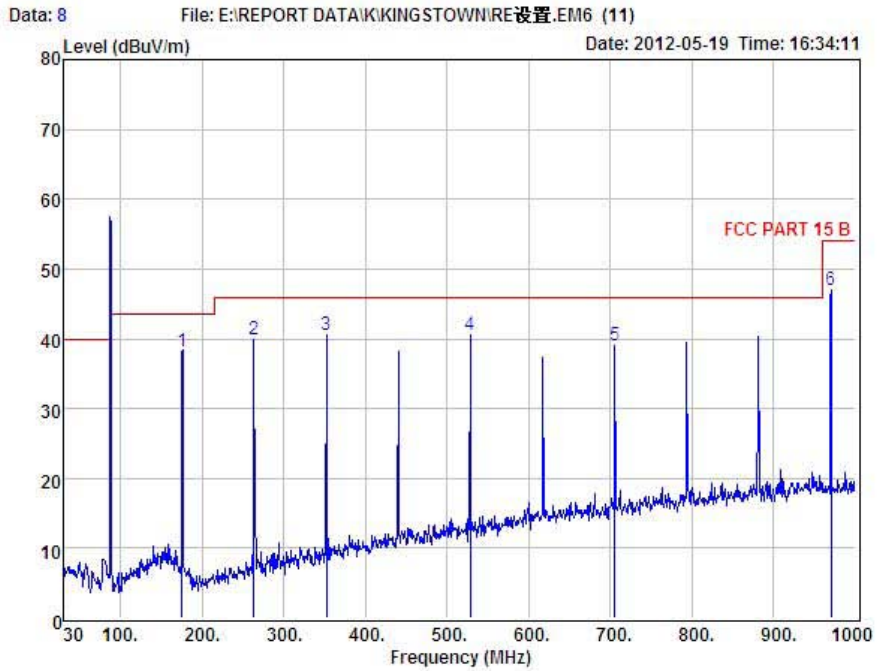

Condition : FCC PART 15 B 3m POL: VERTICAL
 EUT : RF wireless headphone
 Model No. : KST-670B
 Test Mode : Normal
 Power : DC 3V
 Test Engineer : Simple
 Remark :

Item	Freq MHz	Read Level dBuV	Antenna Factor dB	Preamp Factor dB	Cable Loss dB	Level dBuV	Limit dBuV	Margin dBuV	Remark
1	175.50	55.65	12.28	30.93	1.27	38.27	43.50	-5.23	QP
2	263.77	57.48	11.90	31.13	1.74	39.99	46.00	-6.01	QP
3	352.04	55.70	13.87	31.28	2.21	40.50	46.00	-5.50	QP
4	528.58	52.20	17.03	31.68	3.06	40.61	46.00	-5.39	QP
5	705.12	47.76	19.72	31.75	3.41	39.14	46.00	-6.86	QP
6	969.93	52.53	22.20	31.60	3.94	47.07	54.00	-6.93	QP



Shenzhen Certification Technology Service Co., Ltd.
 2F, Building B, East Area of Nanchang Second Industrial Zone,
 Gushu 2nd Road, Bao'an District, Shenzhen 518126, P.R. China
 Tel: 4006786199 FAX: +86-755-26736857
 Website: http://www.cessz.com Email: Service@cessz.com

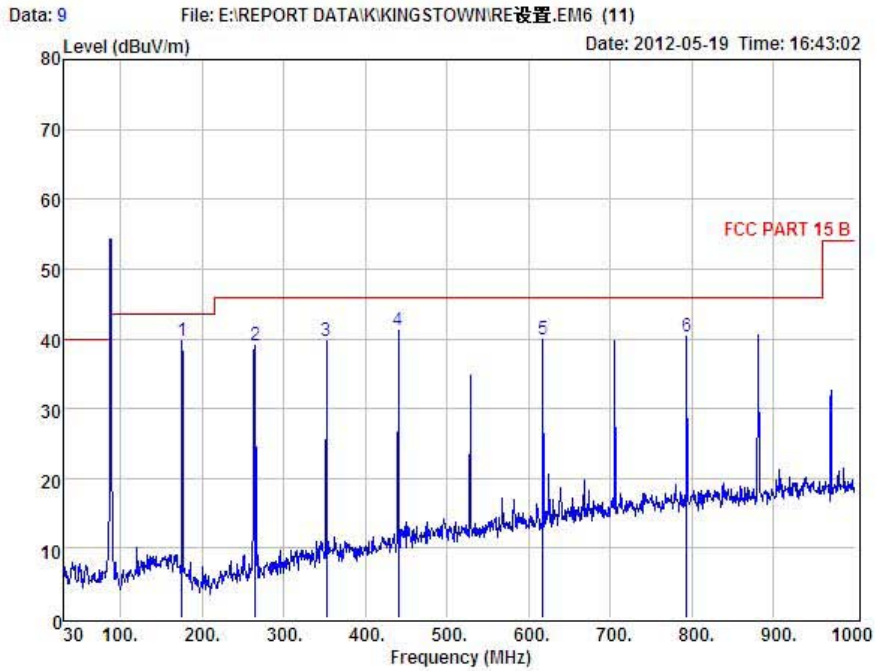

Condition : FCC PART 15 B 3m POL: HORIZONTAL
 EUT : RF wireless headphone
 Model No. : KST-670B
 Test Mode : Normal
 Power : DC 3V
 Test Engineer : Simple
 Remark :

Item	Freq MHz	Read Level dBuV	Antenna Factor dB	Preamp Factor dB	Cable Loss dB	Level dBuV	Limit dBuV	Margin dBuV	Remark
1	175.50	57.01	12.28	30.93	1.27	39.63	43.50	-3.87	QP
2	264.74	56.47	11.96	31.13	1.74	39.04	46.00	-6.96	QP
3	352.04	54.83	13.87	31.28	2.21	39.63	46.00	-6.37	QP
4	440.31	54.25	15.72	31.47	2.68	41.18	46.00	-4.82	QP
5	616.85	49.91	18.62	31.81	3.23	39.95	46.00	-6.05	QP
6	793.39	47.75	20.66	31.66	3.59	40.34	46.00	-5.66	QP

Radiated Emissions Result of Inside band (88~108MHZ)

EUT	RF wireless headphone	Model Name	66121
Temperature	26°C	Relative Humidity	58%
Pressure	960hPa	Test voltage	DC 3V Supply by battery
Test Mode	TX (iPod)	Antenna polarization	Horizontal/Vertical

Channel Low(88.1MHZ)									
Fre. MHz	Plority H/V	Reading dBuV	Antenna Factor dB	Cable Loss dB	Amplifier Gain dB	Correct Factor dB	Measure Result dBuV/m	Limit dBuV/m	Margin dB
88.1	H	73.42 (PK)	11.48	0.96	30.57	-18.13	55.29	68.00	-12.71
88.1	H	58.51 (AV)	11.48	0.96	30.57	-18.13	40.38	48.00	-7.62
--	H	--	--	--	--	--	--	--	--
88.1	V	76.74 (PK)	11.48	0.96	30.57	-18.13	58.61	68.00	-9.39
88.1	V	60.57 (AV)	11.48	0.96	30.57	-18.13	42.44	48.00	-5.56
--	V	--	--	--	--	--	--	--	--

Notes: --Means other frequency and mode comply with standard requirements and at least have 20dB margin.
 Correct Factor=Cable Loss+ Antenna Factor-Amplifier Gain
 Measurement Result=Reading + Correct Factor
 Margin=Measurement Result-Limit

6 Bandwidth Test

7.1 Limit for Bandwidth

The occupied bandwidth shall not exceed 200 KHZ

7.2 Method of measurement

a) The bandwidth is measured at an amplitude level reduced 20dB from the reference level. The reference level is the level of the highest amplitude signal observed from the transmitter at the fundamental frequency. Once the reference level is established, the equipment is conditioned with typical modulating signal to produce the worst-case (i.e. the widest) bandwidth.

b) The test receiver RBW set 10KHZ,VBW set 30KHZ

7.3 Test Setup

same as section 6.2

7.4 Test Results

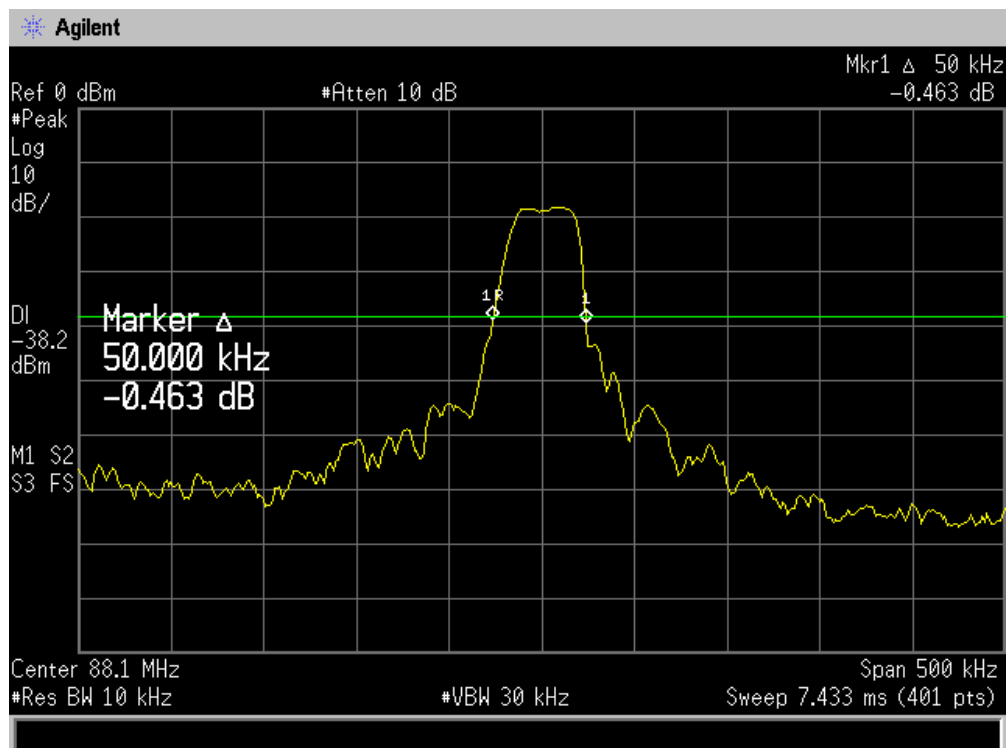

88.1MHZ bandwidth test plot

7 Band Edge Test

8.1 Test Limit

Please see the part 15.239a

8.2 Test Procedure

- a) Put the EUT on a 0.8m high table, power on the EUT. Emissions were scanned and measured rotating the EUT to 360 degrees, Find the maximum Emission
- b) Turning to frequency, then reduced 20dB from the reference level. The reference level is the level of the highest amplitude signal observed from the transmitter at the fundamental frequency.
- c) Check the spurious emissions out of band.
- d) RBW,VBW Setting, please see the following test plot.

8.3 Test Results

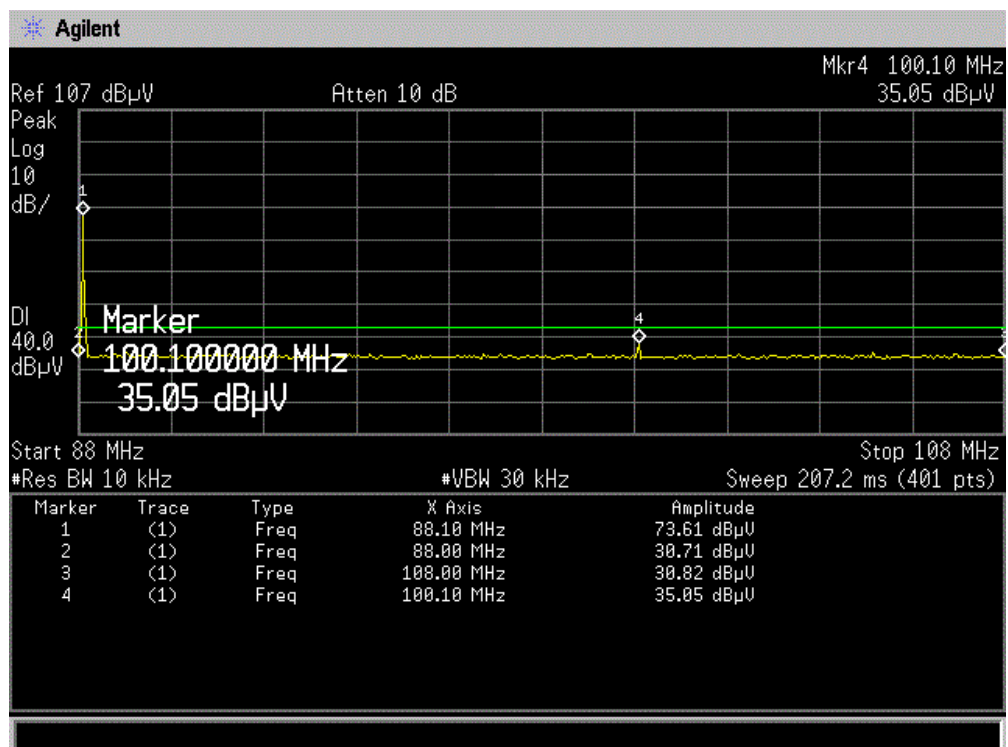

8 Antenna Requirement

9.1 Standard requirement

An intentional radiator shall be designed to ensure that no antenna other than that furnished by the responsible party shall be used with the device. The use of a permanently attached antenna or of an antenna that uses a unique coupling to the intentional radiator shall be considered sufficient to comply with the provisions of this Section. The manufacturer may design the unit so that a broken antenna can be replaced by the user, but the use of a standard antenna jack or electrical connector is prohibited.

9.2 Result

The device is integral antenna, it comply with the standard requirement.

9 Photographs of Test Setup

Photographs-Radiated Emission Test Setup in Chamber

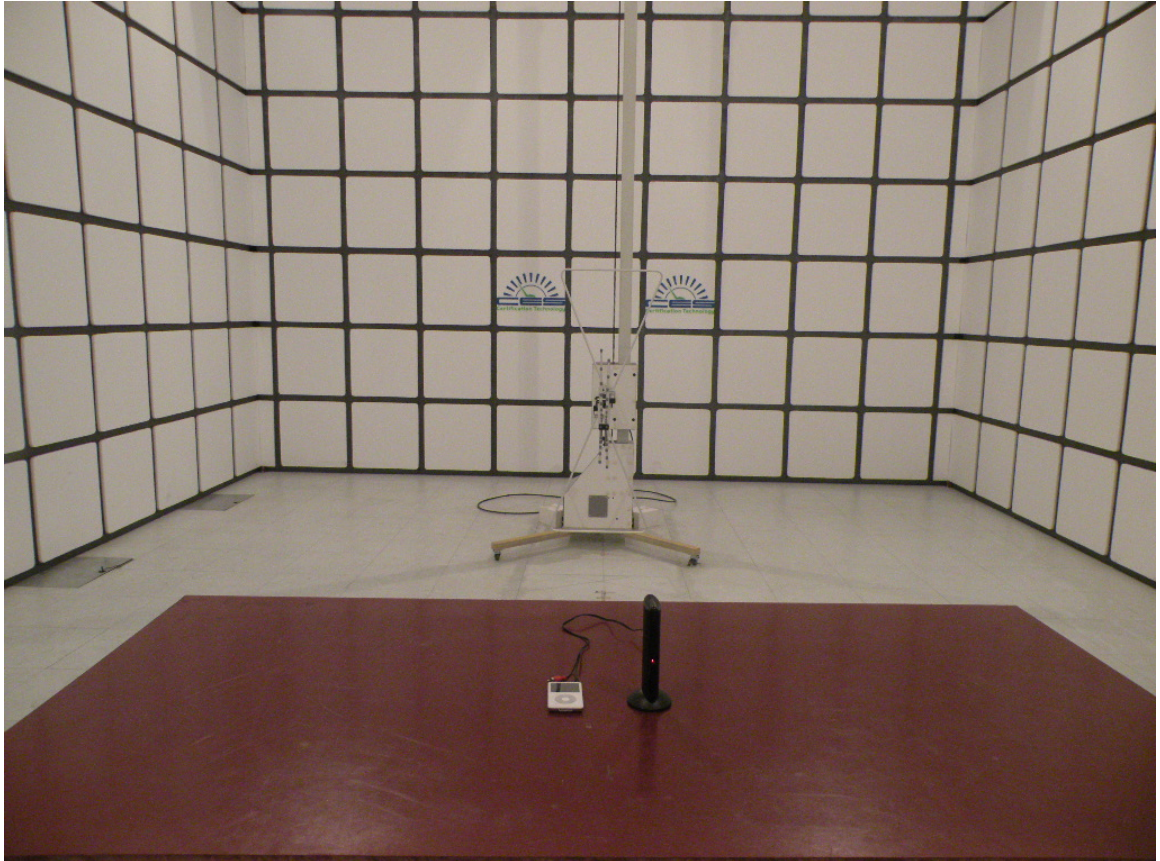

10 Photographs of EUT

Figure 1

Photo of EUT

Front View []

Rear View []

Top View [✓]

Bottom View []

Left View []

Right View []

Internal View []



Figure 2

Photo of EUT

Front View []

Rear View []

Top View []

Bottom View [✓]

Left View []

Right View []

Internal View []



Figure 3

Photo of EUT

Front View

Rear View

Top View

Bottom View

Left View

Right View

Internal View



Figure 4

Photo of EUT

Front View

Rear View

Top View

Bottom View

Left View

Right View

Internal View



Figure 5

Photo of EUT

Front View []

Rear View [✓]

Top View []

Bottom View []

Left View []

Right View []

Internal View []



Figure 6

Photo of EUT

Front View []

Rear View []

Top View []

Bottom View []

Left View []

Right View [✓]

Internal View []



Figure 7

Photo of EUT

Front View []

Rear View []

Top View []

Bottom View []

Left View []

Right View []

Internal View [✓]

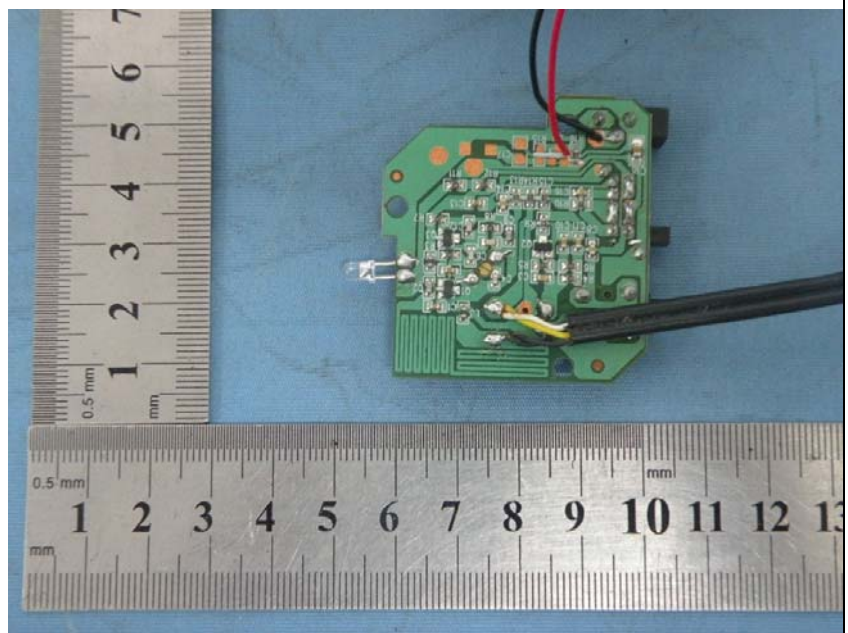

Figure 8

Photo of EUT

Front View []

Rear View []

Top View []

Bottom View []

Left View []

Right View []

Internal View [✓]

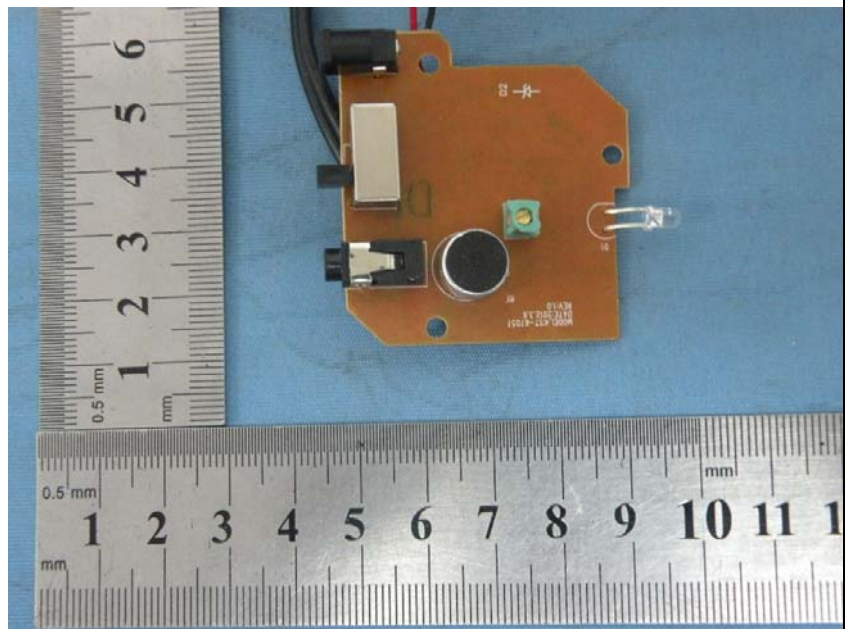

----- THE END OF REPORT-----