

ELECTROMAGNETIC EMISSIONS COMPLIANCE REPORT
INTENTIONAL RADIATOR CERTIFICATION TO
FCC PART 15 SUBPART C AND RSS-210 REQUIREMENT

OF

AutoSmart Controller

FCC ID: IN2TX72

IC: 3558A-HCT03

MODEL No.: 88083

BRAND NAME: N/A

REPORT NO: WE07090002

ISSUE DATE: Sep 27, 2007

Prepared for

HUNTER FAN COMPANY
2500 FRISCO AVE MEMPHIS, TN 38114, USA

Prepared by

SHENZHEN HUATONGWEI INTERNATIONAL
INSPECTION CO., LTD

d.b.a.

SHENZHEN HUATONGWEI INTERNATIONAL INSPECTION CO., LTD
HUATONGWEI BUILDING, KEJI RD. 12 S., HIGH-TECH PARK,
NANSHAN DISTRICT, SHENZHEN,
GUANGDONG, P.R.CHINA

TEL: 86-755-26748099

FAX: 86-755-26748005

VERIFICATION OF COMPLIANCE

Applicant:	Hunter Fan Company 2500 Frisco Ave Memphis , TN 38114, USA
Product Description:	AutoSmart Controller
Brand Name:	N/A
Model Number:	88083
Listed Model	N/A
Serial Number:	N/A
File Number:	WE07090002
Date of Test:	Sep 19, 2007 ~ Sep 20,2007

We hereby certify that:

The above equipment was tested by SHENZHEN HUA TONG WEI INTERNATIONAL INSPECTION CO., LTD. The test data, data evaluation, test procedures, and equipment configurations shown in this report were made in accordance with the procedures given in ANSI C63.4 (2003) and the energy emitted by the sample EUT tested as described in this report is in compliance with radiated emission limits of FCC Rules Part 15.231 and RSS-210 Issue 7 June 2007.

The test results of this report relate only to the tested sample identified in this report.

Approved By

Jimmy Li / Executive Manager
SHENZHEN HUA TONG WEI
INTERNATIONAL INSPECTION CO., LTD

Reviewed By

Tracy Qi / RF Engineer
SHENZHEN HUA TONG WEI
INTERNATIONAL INSPECTION CO., LTD

Table of Contents

1. GENERAL INFORMATION.....	5
1.1 PRODUCT DESCRIPTION.....	5
1.2 RELATED SUBMITTAL(S) / GRANT (S)	5
1.3 TEST METHODOLOGY	5
1.4 TEST FACILITY	5
1.5 SPECIAL ACCESSORIES.....	5
1.6 EQUIPMENT MODIFICATIONS.....	6
1.7. LABORATORY ACCREDITATIONS AND LISTINGS.....	6
2. SYSTEM TEST CONFIGURATION.....	8
2.1 EUT CONFIGURATION	8
2.2 EUT EXERCISE	8
2.3 TEST PROCEDURE	8
2.4 LIMITATION	8
2.5 CONFIGURATION OF TESTED SYSTEM.....	9
3. DESCRIPTION OF TEST MODES	9
4. CONDUCTED EMISSIONS TEST (NOT APPLICABLE TO THIS DEVICE)	10
4.1 MEASUREMENT PROCEDURE:.....	10
4.2 TEST SET-UP (BLOCK DIAGRAM OF CONFIGURATION).....	10
4.3 MEASUREMENT EQUIPMENT USED:.....	11
4.4 MEASUREMENT RESULT:.....	11
5. RADIATED EMISSION TEST.....	12
5.1 MEASUREMENT PROCEDURE.....	12
5.2 TEST SET-UP (BLOCK DIAGRAM OF CONFIGURATION).....	12
5.3 MEASUREMENT EQUIPMENT USED:.....	13
5.4 FIELD STRENGTH CALCULATION.....	13
5.5 MEASUREMENT RESULTS	14
6. 99% OCCUPIED BANDWIDTH	15
6.1 MEASUREMENT PROCEDURE.....	15
6.2 TEST SET-UP (BLOCK DIAGRAM OF CONFIGURATION).....	15
6.3 MEASUREMENT EQUIPMENT USED:.....	15
6.4 MEASUREMENT RESULTS:	15
7. RELEASE TIME MEASUREMENT	16
7.1 MEASUREMENT PROCEDURE.....	16
7.2 TEST SET-UP (BLOCK DIAGRAM OF CONFIGURATION).....	16
7.3 MEASUREMENT EQUIPMENT USED:.....	16
7.4 MEASUREMENT RESULTS:	16

APPENDIX 1 18
PHOTOGRAPHS OF SET UP 18
APPENDIX 2..... 20
PHOTOGRAPHS OF EUT..... 20

1. GENERAL INFORMATION

1.1 Product Description

The EUT is a short range, lower power, 433MHz work frequency (*for more details, refer to the user's manual of the EUT*). It is designed by way of utilizing the ASK modulation achieves the system operating.

A major technical descriptions of EUT is described as following:

- A). Operation Frequency: 433.920 MHz
- B). Modulation: ASK
- C). Antenna Designation: Non-User Replaceable (Integral without external RF Port)
- D). Power Supply: 3 V DC Powered by battery

1.2 Related Submittal(s) / Grant (s)

This submittal(s) (test report) is intended for FCC ID: IN2TX72 and IC: 3558A-HCT03 filing to comply with Section 15.231 of the FCC Part 15, Subpart C Rules and RSS-210 Issue 7 June 2007.

1.3 Test Methodology

Both conducted and radiated testing were performed according to the procedures in ANSI C63.4 (2003). Radiated testing was performed at an antenna to EUT distance 3 meters.

1.4 Test Facility

The fully anechoic chamber test site and conducted measurement facility used to collect the radiated data is located on the address of SHENZHEN HUA TONG WEI INTERNATIONAL INSPECTION CO., LTD Huatongwei Building, Keji Rd. 12 S., High-tech Park, Nanshan District, Shenzhen, Guangdong, P.R.China

The fully anechoic chamber Test Sites and the Line Conducted labs are constructed and calibrated to meet the FCC requirements in documents ANSI C63.4: 2003 and CISPR 22/EN 55022 requirements.

1.5 Special Accessories

Not available for this EUT intended for grant.

1.6 Equipment Modifications

Not available for this EUT intended for grant.

1.7. Laboratory Accreditations and listings

The test facility is recognized, certified, or accredited by the following organizations:

CNAS-Lab Code: L1225

Shenzhen Huatongwei International Inspection Co., Ltd has been assessed and proved to be in compliance with CNAS-CL01 Accreditation Criteria for Testing and Calibration Laboratories (identical to ISO/IEC 17025: 2005 General Requirements) for the Competence of Testing and Calibration Laboratories.

A2LA-Lab Cert. No. 2243.01

Shenzhen Huatongwei International Inspection Co., Ltd, EMC Laboratory has been accredited by A2LA for technical competence in the field of electrical testing, and proved to be in compliance with ISO/IEC 17025: 1999 General Requirements for the Competence of Testing and Calibration Laboratories and any additional program requirements in the identified field of testing. Valid time is from Aug 24, 2005 to Sept 30, 2007

FCC-Registration No.: 662850

Shenzhen Huatongwei International Inspection Co., Ltd, EMC Laboratory has been registered and fully described in a report filed with the FCC (Federal Communications Commission). The acceptance letter from the FCC is maintained in our files. Registration 662850, Renewal date September 12, 2006.

IC-Registration No.: 5377

The 3m Alternate Test Site of Shenzhen Huatongwei International Inspection Co., Ltd has been registered by Certification and Engineering Bureau of Industry Canada for the performance of radiated measurements with Registration No. 5377 on November 28th, 2005.

ACA

Shenzhen Huatongwei International Inspection Co., Ltd, EMC Laboratory can also perform testing for the Australian C-Tick mark as a result of our A2LA accreditation.

NEMKO-Aut. No.: ELA125

Shenzhen Huatongwei International Inspection Co., Ltd has been assessed the quality assurance system, the testing facilities, qualifications and testing practices of the relevant parts of the organization. The quality assurance system of the Laboratory has been validated against ISO/IEC 17025:2005 or equivalent. The laboratory also fulfils the conditions described in Nemko Document NLA-10.

VCCI

The 3m Semi-anechoic chamber (12.2m×7.95m×6.7m) and Shielded Room (8m×4m×3m) of Shenzhen Huatongwei International Inspection Co., Ltd has been registered in accordance with the Regulations for Voluntary Control Measures with Registration No.: R-2484. Date of Registration: December 20, 2006. Valid time is until December 19, 2009.

Main Ports Conducted Interference Measurement of Shenzhen Huatongwei International Inspection Co., Ltd has been registered in accordance with the Regulations for Voluntary Control Measures with Registration No.: C-2726. Date of Registration: December 20, 2006. Valid time is until December 19, 2009.

IECEE CB

Shenzhen Huatongwei International Inspection Co Ltd has been assessed and determined to fully comply with the requirements of ISO/IEC 17025: 2005-05, The Basic Rules, IECEE 01: 2006-10 and Rules of Procedure IECEE 02: 2006-10, and the relevant IECEE CB-Scheme Operational Documents.

It is therefore entitled to operate as a CB Testing Laboratory under the responsibility of Nemko A/S. This certificate remains valid until May 25th 2009 at which time it will be reissued by the IECEE Executive Secretary upon successful completion of the normally scheduled 3-year Reassessment Program administered by the IECEE CB Scheme.

DNV

Shenzhen Huatongwei International Inspection Co Ltd has been found to comply with the requirements of DNV towards subcontractor of EMC and safety testing services in conjunction with the EMC and Low voltage Directives and in the voluntary field. The acceptance is based on a formal quality Audit and follow-ups according to relevant parts of ISO/IEC Guide 17025(2005), in accordance with the requirements of the DNV Laboratory Quality Manual towards subcontractors. Valid until 09 Jul, 2010.

2. SYSTEM TEST CONFIGURATION

2.1 EUT Configuration

The EUT configuration for testing is installed on RF field strength measurement to meet the Commissions requirement and operating in a manner which intends to maximize its emission characteristics in a continuous normal application.

2.2 EUT Exercise

The Transmitter was operated in the normal operating mode. The TX frequency was fixed which was for the purpose of the measurements.

2.3 Test Procedure

2.3.1 Conducted Emissions

The EUT is placed on support table which is 0.8 m above ground plane. According to the requirements in Section 13.1.4.1 of ANSI C63.4-2003. Conducted emissions from the EUT measured in the frequency range between 0.15 MHz and 30MHz using CISPR Quasi-Peak and average detector mode.

2.3.2 Radiated Emissions

The EUT is a placed on as turn table which is 0.8 m above ground plane. The turn table shall rotate 360 degrees to determine the position of maximum emission level. EUT is set 3m away from the receiving antenna which varied from 1m to 4m to find out the highest emission. And also, each emission was to be maximized by changing the polarization of receiving antenna both horizontal and vertical.

2.4 Limitation

(1) Conducted Emission

According to section 15.207(a) Conducted Emission Limits is as following.

Frequency range MHz	Limits dB(uV)	
	Quasi-peak	Average
0.15 to 0.50	66 to 56	56 to 46
0.50 to 5	56	46
5 to 30	60	50
Note		
1.The lower limit shall apply at the transition frequencies		
2.The limit decreases linearly with the logarithm of the frequency in the range 0.15 MHz to 0.50 MHz.		

(2) Radiated Emission

a. Radiation Emission Measurement Limits According to FCC Part 15 Section 15.231(b) & RSS-210 Table 4

Frequency Range of Fundamental [MHz]	Field Strength of Fundamental Emission [Average] [V/m]	Field Strength of Spurious Emission [Average] [V/m]
40.66-40.70	2250	225
70-130	1250	125
130-174	1250-3750	125-375
174-260	3750	375
260-470	3750-12500	375-1250
Above 470	12500	1250

Where F is the frequency in MHz, The formulas for calculating the maximum permitted fundamental field strengths are as follows: for the band 130-174MHz, ()V/m at 3 meters= $56.81818(F)-6136.3636$; For the band 260-470MHz, ()V/m at 3 meters= $41.6667(F)-7083.3333$. The maximum permissible unwanted emission level is 20dB below the maximum permitted fundamental level.

b. Restricted Band Radiation Emission Measurement Limits According to FCC part 15 Section 15.205 and Section15.209; RSS-210 table1.

2.5 Configuration of Tested System

Fig. 2-1 Configuration of Tested System

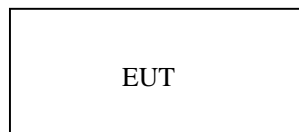

3. DESCRIPTION OF TEST MODES

1. The EUT has been tested under normal operating condition.
2. The EUT stay in continuous transmitting mode. Three axes (X, Y, and Z) are chosen for testing.

4. CONDUCTED EMISSIONS TEST (NOT APPLICABLE TO THIS DEVICE)

4.1 Measurement Procedure:

1. The equipment was set up as per the test configuration to simulate typical actual usage per the user's manual. The EUT is a tabletop system; a wooden table with a height of 0.8 meters is used and is placed on the ground plane as per ANSI C63.4.
2. Support equipment, if needed, was placed as per ANSI C63.4.
3. All I/O cables were positioned to simulate typical actual usage as per ANSI C63.4.
4. The EUT received DC8V power from the adapter, the adapter received AC120V/60Hz power through a Line Impedance Stabilization Network (LISN) which supplied power source and was grounded to the ground plane.
5. All support equipments received AC power from a second LISN, if any.
6. The EUT test program was started. Emissions were measured on each current carrying line of the EUT using a spectrum Analyzer / Receiver connected to the LISN powering the EUT. The LISN has two monitoring points: Line 1 (Hot Side) and Line 2 (Neutral Side). Two scans were taken: one with Line 1 connected to Analyzer / Receiver and Line 2 connected to a 50 ohm load; the second scan had Line 1 connected to a 50 ohm load and Line 2 connected to the Analyzer / Receiver.
7. Analyzer / Receiver scanned from 150 KHz to 30MHz for emissions in each of the test modes.
8. During the above scans, the emissions were maximized by cable manipulation.

4.2 Test SET-UP (Block Diagram of Configuration)

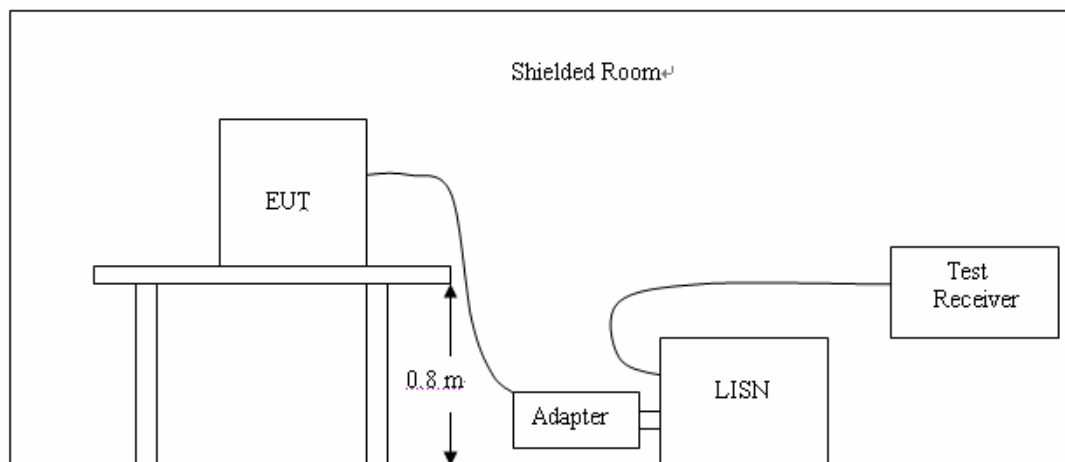

4.3 Measurement Equipment Used:

Conducted Emission Test Site # 3					
EQUIPMENT TYPE	MFR	MODEL NUMBER	SERIAL NUMBER	LAST CAL.	CAL DUE.
EMI TEST RECEIVER	ROHDE & SCHWARZ	ESCS30	100038	2006/10	2007/10
ARTIFICIAL MAINS	ROHDE & SCHWARZ	ESH2-Z5	100028	2006/10	2007/10
PULSE LIMITER	ROHDE & SCHWARZ	ESHSZ2	100044	2006/10	2007/10
EMI TEST SOFTWARE	ROHDE & SCHWARZ	ES-K1 V1.71	N/A	2006/10	2007/10

4.4 Measurement Result:

N/A

5. RADIATED EMISSION TEST

5.1 Measurement Procedure

Radiation Emission Measurement Limits According to FCC Part 15 Section 15.231(b) & RSS-210 Table 4

1. The EUT was placed on a turntable which is 0.8m above ground plane.
2. Maximum procedure was performed by raising the receiving antenna from 1m to 4m and rotating the turn table from 0°C to 360°C to acquire the highest emissions from EUT
3. And also, each emission was to be maximized by changing the polarization of receiving antenna both horizontal and vertical.
4. Repeat above procedures until all frequency measurements have been completed.

Note:

Three axes are chosen for pretest, the Z axis is the worst mode for final test.

5.2 Test SET-UP (Block Diagram of Configuration)

(A) Radiated Emission Test Set-Up, Frequency Below 30MHz

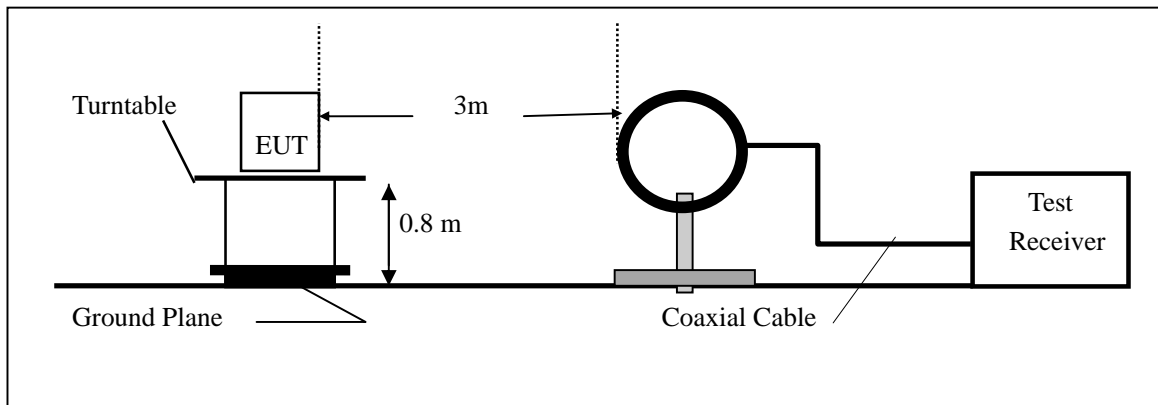

(B) Radiated Emission Test Set-Up, Frequency Below 1000MHz

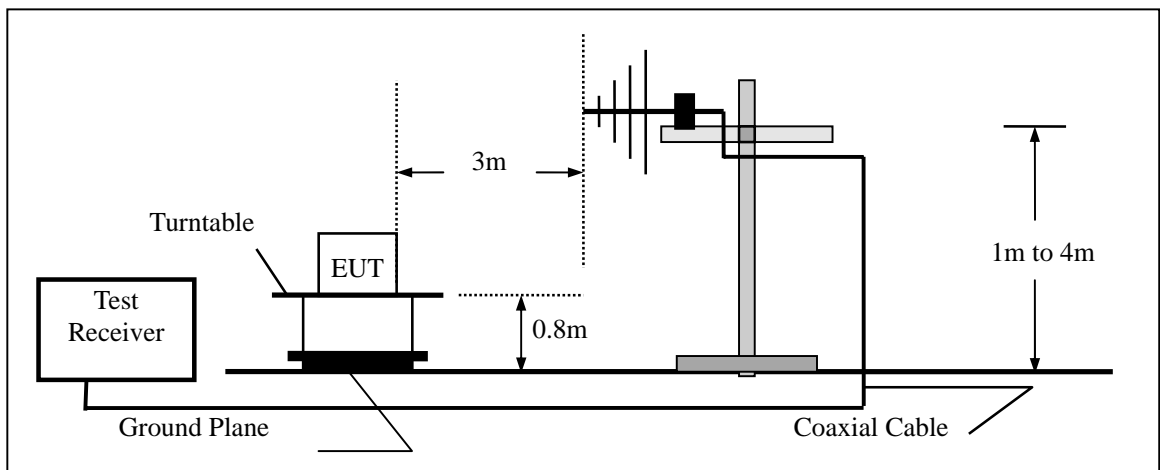

(C) Radiated Emission Test Set-Up, Frequency above 1000MHz

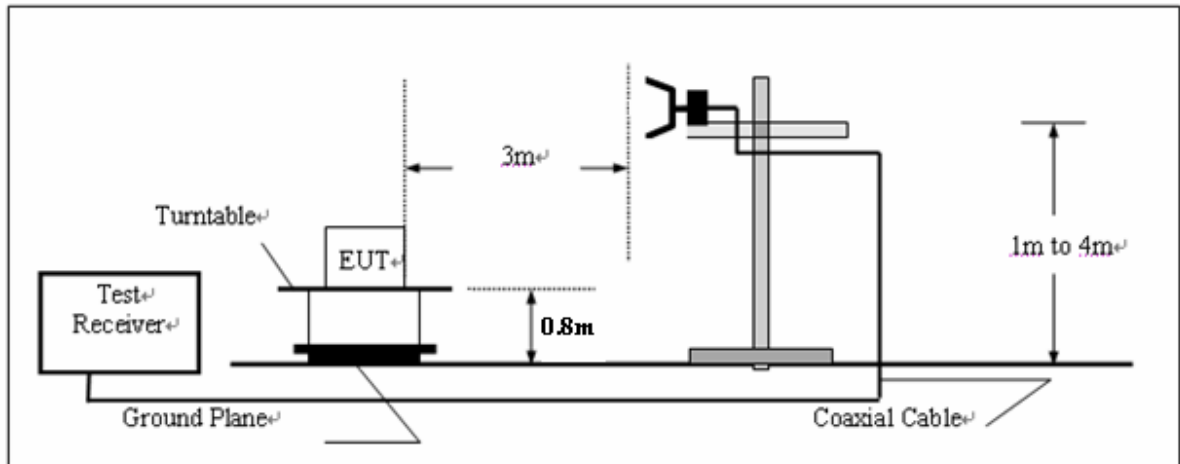

5.3 Measurement Equipment Used:

3/5 Anechoic Chamber Radiation Test Site # 4					
EQUIPMENT TYPE	MFR	MODEL NUMBER	SERIAL NUMBER	LAST CAL.	CAL DUE.
ULTRA-BROADBAND ANTENNA	ROHDE & SCHWARZ	HL562	100015	2007/10	2007/10
EMI TEST RECEIVER	ROHDE & SCHWARZ	ESI 26	100009	2006/10	2007/10
Double-Ridged-Waveguide Horn Antenna	ROHDE & SCHWARZ	HF906	100039	2006/10	2007/10
RF TEST PANEL	ROHDE & SCHWARZ	TS / RSP	335015/ 0017	N/A	N/A
TURNTABLE	ETS	2088	2149	N/A	N/A
ANTENNA MAST	ETS	2075	2346	N/A	N/A
EMI TEST SOFTWARE	ROHDE & SCHWARZ	ES-K1 V1.71	N/A	2006/10	2007/10

5.4 Field Strength Calculation

The field strength is calculated by adding the Antenna Factor and Cable Factor and subtracting the Amplifier Gain and Duty Cycle Correction Factor(if any) from the measured reading. The basic equation with a sample calculation is as follows:

$$FS = RA + AF + CL - AG$$

Where FS = Field Strength	CL = Cable Attenuation Factor (Cable Loss)
RA = Reading Amplitude	AG = Amplifier Gain
AF = Antenna Factor	

5.5 Measurement Results

Operation Mode: Transmitting Mode Test Date : Sep 19,2007
 Fundamental 433.920MHz Test By: Tracy Qi
 Frequency:
 Temperature : 23 °C Humidity : 53 %
 Judgment: Passed by -2.40 dB at 433.92 MHz Ant.Pol. Hor.

Freq. (MHz)	Ant.Pol. H/V	DetectorMode (PK/AV)	Reading (dBUV)	Ant./CL/ Amp. CF(dB)	Actual FS (dBUV/m)	Limit3m (dBUV/m)	Safe Margin (dB)	Note
433.92	V	Peak	52.00	20.10	72.10	80.80	-8.70	F
433.92	H	Peak	58.30	20.10	78.40	80.80	-2.40	F
867.84	V	Peak	10.30	24.90	35.20	60.80	-25.60	H
867.84	H	Peak	17.40	24.90	42.30	60.80	-18.50	H
1301.76	V		---					H
1301.76	H		---					H
2169.60	V		---					H
2169.60	H		---					H
30.00	H	Peak	2.20	21.20	23.40	40.00	-16.60	
30.00	V	Peak	3.00	21.20	24.20	40.00	-15.80	
Others			---					

Remark:

- (1) Measuring frequencies from 30 MHz to the 5 GHz.
- (2) "F" denotes fundamental frequency; "H" denotes spurious frequency. "E" denotes band edge frequency.
- (3) * denotes emission frequency which appearing within the Restricted Bands specified in provision of 15.205, then the general radiated emission limits in 15.209 apply.
- (4) Spurious radiated emissions of measurement within this frequency range shown "-" in the table above means the reading of emissions are attenuated more than 20dB below the 15.209 limit or the field strength is too small to be measured.
- (5) The IF bandwidth of EMI Test Receiver was 120KHz for measuring from 30 MHz to 1 GHz and 1 MHz for measuring above 1 GHz

6. 99% OCCUPIED BANDWIDTH

6.1 Measurement Procedure

The Bandwidth of Emission Limit According To RSS-210 A1.1.3

1. The EUT was placed on a turn table which is 0.8m above ground plane.
2. Set EUT as normal operation.
3. Set SPA Center Frequency = fundamental frequency, RBW=10 KHz, VBW= 30 KHz.
4. Set SPA Max hold. Mark peak, -20dB.

6.2 Test SET-UP (Block Diagram of Configuration)

Same as 5.2 Radiated Emission Measurement.

6.3 Measurement Equipment Used:

Same as 5.2 Radiated Emission Measurement.

6.4 Measurement Results:

20 dB Bandwidth Test Plot:

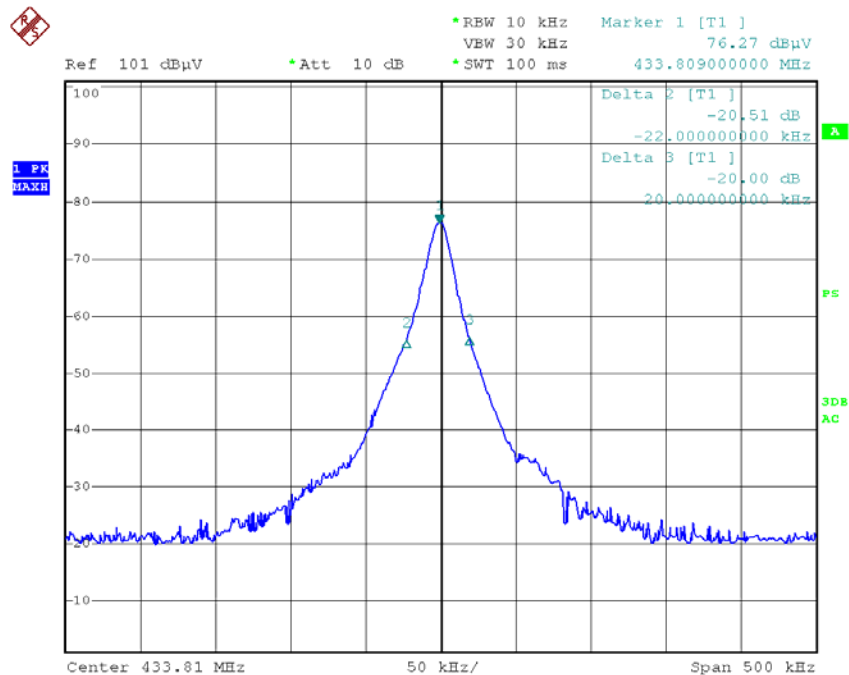

Date: 20.SEP.2007 00:25:18

7. RELEASE TIME MEASUREMENT

7.1 Measurement Procedure

Release Time Measurement According To FCC Part 15 Section 15.231(a)& RSS-210 A1.1.1

1. Set SPA Center Frequency = Fundamental frequency, RBW = 100 kHz, VBW = 300 kHz, Span = 0Hz.
2. Set EUT as normal operation and press Transmitter button.
3. Set SPA View. Delta Mark time.

7.2 Test SET-UP (Block Diagram of Configuration)

Same as 5.2 Radiated Emission Measurement.

7.3 Measurement Equipment Used:

Same as 5.2 Radiated Emission Measurement.

7.4 Measurement Results:

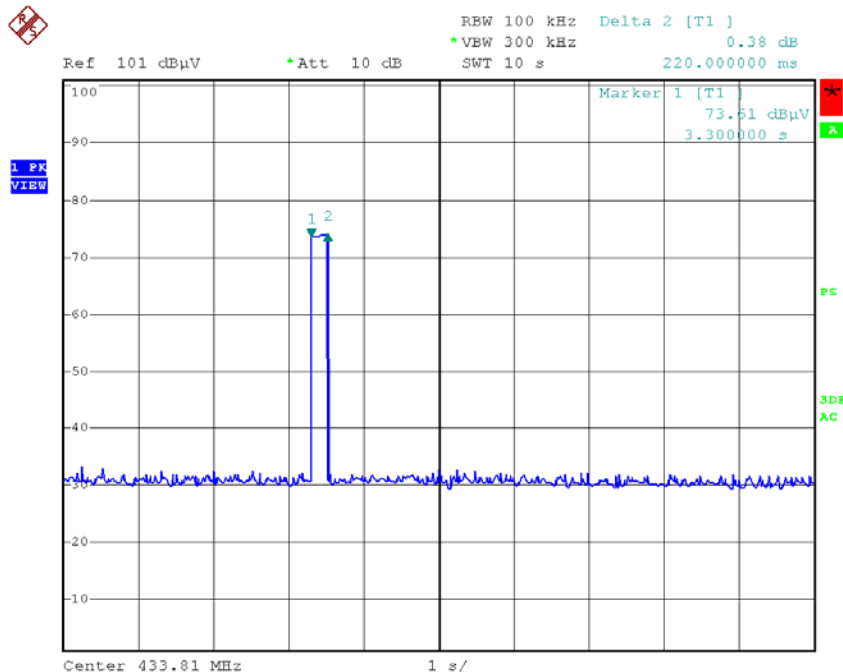

Date: 20.SEP.2007 00:29:12

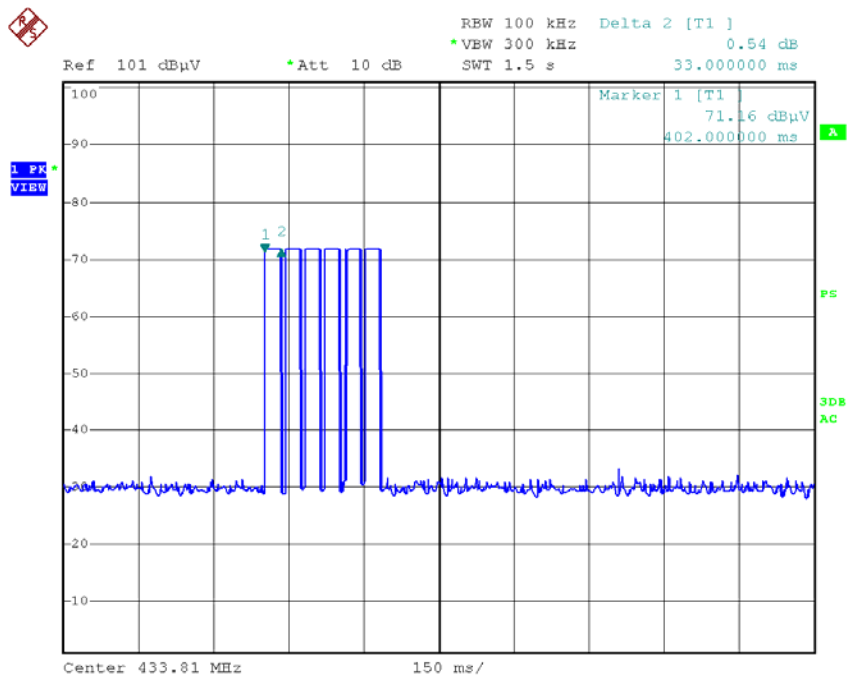

Date: 20.SEP.2007 00:36:34

Remark: Once the key is released the device stop transmitting in 5 seconds.

APPENDIX 1

PHOTOGRAPHS OF SET UP

Radiated Emission Setup Photo

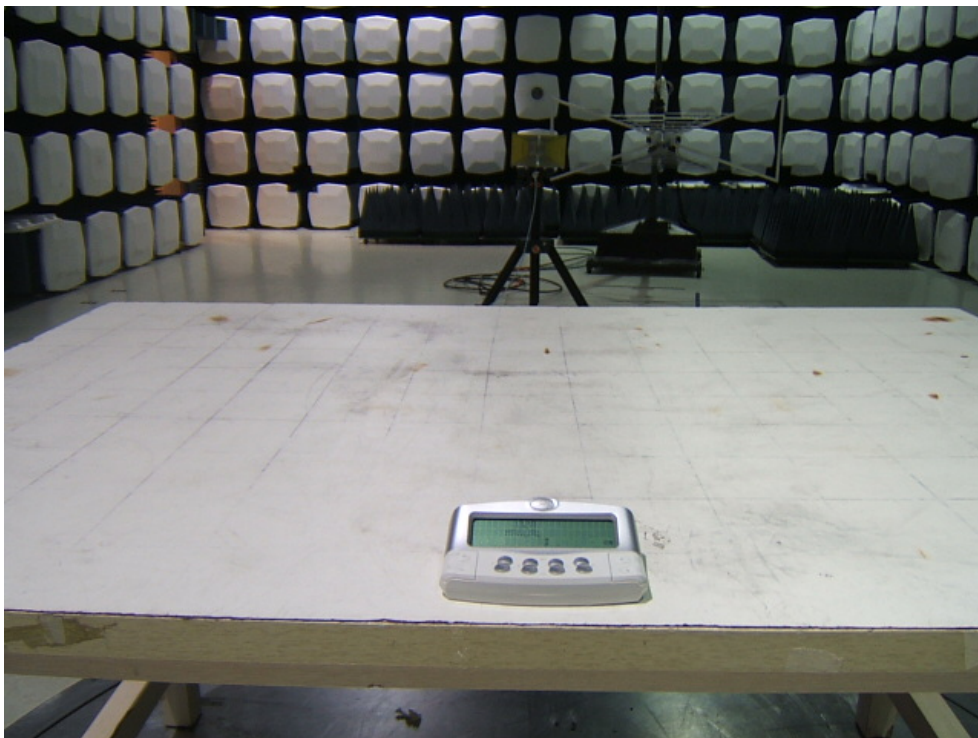
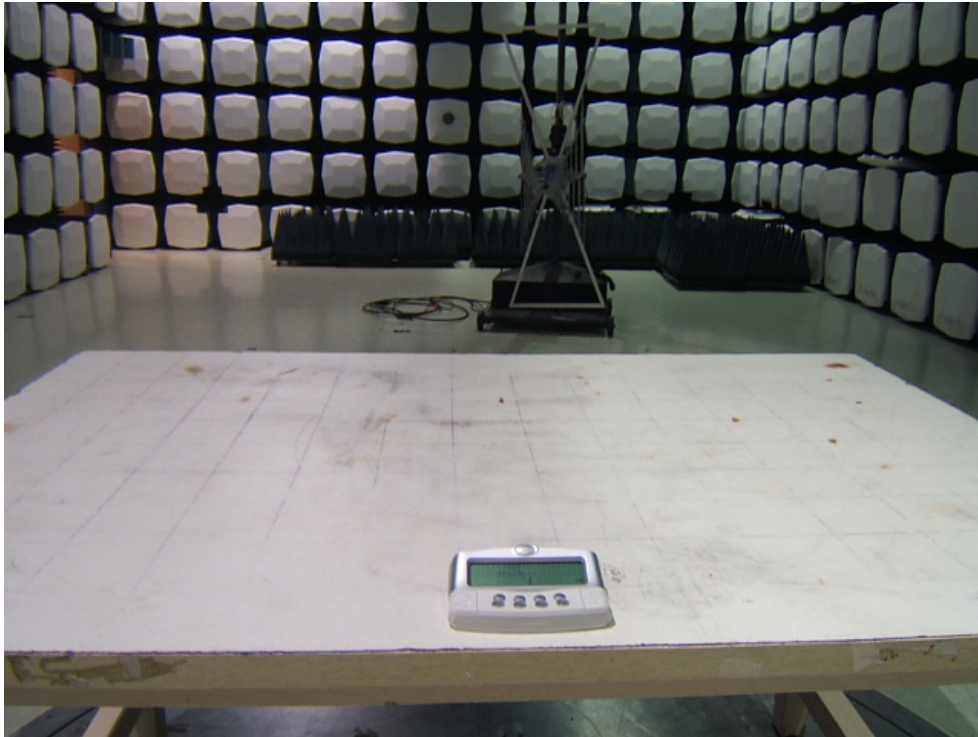

APPENDIX 2

PHOTOGRAPHS OF EUT

Top View of EUT



Bottom View of EUT



Front View of EUT



Back View of EUT



Left View of EUT



Right View of EUT



Internal Photos of EUT

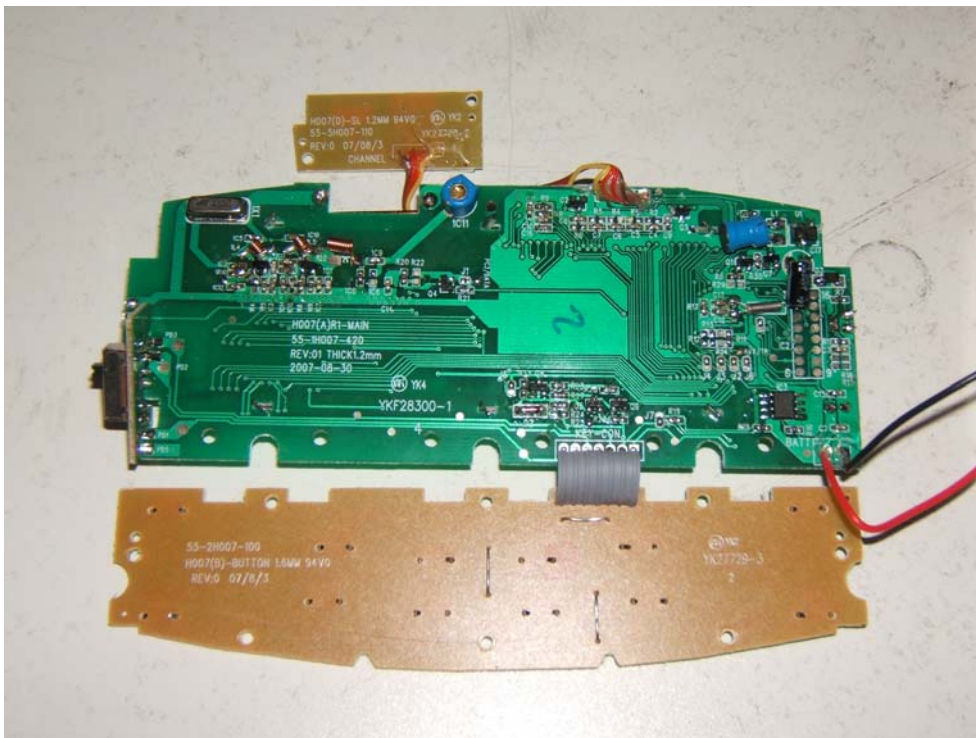



-----End of Report-----