

# TEST REPORT

For RF

Report No. .... : **CHEW23050066** Report Verification: 

Project No..... : **SHT2305029301EW**

FCC ID..... : **IN2TX57**

Applicant's name..... : **Hunter Fan Company**

Address..... : 7130 Goodlett Farms Pkwy, Suite 400, Memphis Tennessee  
38016 United States

Product Name ..... : **Remote Control for Ceiling Fan**

Trade Mark ..... : Hunter

Model No. .... : G1764-A1-000

Listed Model(s) ..... : G1764-A2-000,J0250-A1

Standard ..... : **FCC CFR Title 47 Part 15 Subpart C § 15.231**

Date of receipt of test sample..... : May 16, 2023

Date of testing..... : May 16, 2023- May 25, 2023

Date of issue..... : May 26, 2023

Result..... : **PASS**

Compiled by  
 (Position+Printed name+Signature): File administrator Fanghui Zhu

*Fanghui Zhu*

Supervised by  
 (Position+Printed name+Signature): Project Engineer Kiki Kong

*Kiki Kong*

Approved by  
 (Position+Printed name+Signature): RF Manager Hans Hu

*Hans Hu*

Testing Laboratory Name ..... : **Shenzhen Huatongwei International Inspection Co., Ltd.**

Address..... : 1/F, Bldg 3, Hongfa Hi-tech Industrial Park, Genyu Road,  
Tianliao, Gongming, Shenzhen, China

**Shenzhen Huatongwei International Inspection Co., Ltd. All rights reserved.**

This publication may be reproduced in whole or in part for non-commercial purposes as long as the Shenzhen Huatongwei International Inspection Co., Ltd. is acknowledged as copyright owner and source of the material. Shenzhen Huatongwei International Inspection Co., Ltd. takes no responsibility for and will not assume liability for damages resulting from the reader's interpretation of the reproduced material due to its placement and context. The test report merely correspond to the test sample.

## Contents

<b>1.</b>	<b>TEST STANDARDS AND REPORT VERSION</b>	<b>3</b>
1.1.	Test Standards	3
1.2.	Report version	3
<b>2.</b>	<b>TEST DESCRIPTION</b>	<b>4</b>
<b>3.</b>	<b>SUMMARY</b>	<b>5</b>
3.1.	Client Information	5
3.2.	Product Description	5
3.3.	Radio Specification Description	5
3.4.	Testing Laboratory Information	5
<b>4.</b>	<b>TEST CONFIGURATION</b>	<b>6</b>
4.1.	Test frequency list	6
4.2.	Descriptions of Test mode	6
4.3.	Test sample information	6
4.4.	Support unit used in test configuration and system	7
4.5.	Testing environmental condition	7
4.6.	Statement of the measurement uncertainty	7
4.7.	Equipment Used during the Test	8
<b>5.</b>	<b>TEST CONDITIONS AND RESULTS</b>	<b>9</b>
5.1.	Antenna Requirement	9
5.2.	AC Conducted Emission	10
5.3.	20dB bandwidth	11
5.4.	99% Occupied Bandwidth	12
5.5.	Transmission Time	13
5.6.	Duty Cycle Corrected Factor	14
5.7.	Radiated field strength of the fundamental signal	15
5.8.	Radiated Spurious Emission	17
<b>6.</b>	<b>TEST SETUP PHOTOS</b>	<b>23</b>
<b>7.</b>	<b>EXTERNAL AND INTERNAL PHOTOS</b>	<b>24</b>
7.1.	External Photos	24
7.2.	Internal Photos	30
<b>8.</b>	<b>APPENDIX REPORT</b>	<b>34</b>

# 1. TEST STANDARDS AND REPORT VERSION

## 1.1. Test Standards

The tests were performed according to following standards:

- [FCC CFR Title 47 Part 15 Subpart C § 15.231](#): Periodic operation in the band 40.66-40.70 MHz and above 70 MHz
- [ANSI C63.10:2013](#): American National Standard for Testing Unlicensed Wireless Devices

## 1.2. Report version

Revision No.	Date of issue	Description
N/A	2023-05-26	Original

## 2. TEST DESCRIPTION

Report clause	Test Items	Standard Requirement	Result	Test Engineer
5.1	Antenna Requirement	15.203	PASS	Xiaoqin Li
5.2	AC Conducted Emission	15.207	N/A	N/A
5.3	20dB Bandwidth	15.231(c)	PASS	Xiaoqin Li
5.4	99% Occupied Bandwidth	-	PASS <sup>*1</sup>	Xiaoqin Li
5.5	Transmission time	15.231(a)(1)	PASS	Xiaoqin Li
5.6	Duty cycle corrected factor	-	PASS <sup>*1</sup>	Xiaoqin Li
5.7	Field strength of the Fundamental signal	15.231(b)	PASS	Yifan Wang
5.8	Radiated Spurious Emission	15.231(b)/15.205/15.209	PASS	Yifan Wang

Note:

- The measurement uncertainty is not included in the test result.
- \*1: No requirement on standard, only report these test data.

### 3. SUMMARY

#### 3.1. Client Information

Applicant:	Hunter Fan Company
Address:	7130 Goodlett Farms Pkwy, Suite 400, Memphis Tennessee 38016 United States
Manufacturer:	Hunter Fan Company
Address:	7130 Goodlett Farms Pkwy, Suite 400, Memphis Tennessee 38016 United States
Factory:	Shenzhen H&T Intelligent Control CO., Ltd.
Address:	H&T Industrial Park, No.18 BaoShan Road, Tian Liao Community, Guangming new district, Shenzhen, Guangdong, China 518132

#### 3.2. Product Description

Main unit information:	
Product Name:	Remote Control for Ceiling Fan
Trade Mark:	Hunter
Model No.:	G1764-A1-000
Listed Model(s):	G1764-A2-000, J0250-A1
Power supply:	DC 3V from Battery
Hardware version:	V01
Software version:	V01

#### 3.3. Radio Specification Description

Operation frequency:	433.92MHz
Modulation:	OOK
Channel number:	1
Antenna type:	PCB Antenna

#### 3.4. Testing Laboratory Information

Laboratory Name	Shenzhen Huatongwei International Inspection Co., Ltd.	
Laboratory Location	1/F, Bldg 3, Hongfa Hi-tech Industrial Park, Genyu Road, Tianliao, Gongming, Shenzhen, China	
Contact information:	Phone: 86-755-26715499 E-mail: <a href="mailto:cs@szhtw.com.cn">cs@szhtw.com.cn</a> <a href="http://www.szhtw.com.cn">http://www.szhtw.com.cn</a>	
Qualifications	Type	Accreditation Number
	FCC	762235

## 4. TEST CONFIGURATION

### 4.1. Test frequency list

According to section ANSI C63.10 section 5.6.1,

Measurements of unlicensed wireless devices shall be performed and, if required, reported for each band in which the EUT can be operated with the device operating at the number of frequencies in each band specified in Table 4

**Table 4—Number of frequencies to be tested**

Frequency range in which device operates	Number of frequencies	Location in frequency range of operation
1 MHz or less	1	Middle
1 MHz to 10 MHz	2	1 near top and 1 near bottom
More than 10 MHz	3	1 near top, 1 near middle, and 1 near bottom

So test frequency as follow:

Channel	Frequency (MHz)
<b>CH<sub>M</sub></b>	<b>433.92</b>

### 4.2. Descriptions of Test mode

For RF test items
The engineering test program was provided and enabled to make EUT continuous transmit.
For Radiated spurious emissions test item:
The engineering test program was provided and enabled to make EUT continuous transmit. The EUT in each of three orthogonal axis emissions had been tested, but only the worst case (X axis) data Recorded in the report.

### 4.3. Test sample information

Test item	HTW sample no.
RF Conducted test items	Please refer to the description in the appendix report
RF Radiated test items	YPHT23050293001

Note:

RF Conducted test items: 20dB Bandwidth ,99% Occupied Bandwidth, Transmission time, Duty cycle corrected factor

RF Radiated test items: Field strength of the Fundamental signal

#### 4.4. Support unit used in test configuration and system

The EUT has been associated with peripherals and configuration operated in a manner tended to maximize its emission characteristics in a typical application.

The following peripheral devices and interface cables were connected during the measurement:

Whether support unit is used?			
✓ No			
Item	Equipment	Trade Name	Model No.
1			
2			

#### 4.5. Testing environmental condition

Type	Requirement	Actual
Temperature:	15~35°C	25°C
Relative Humidity:	25~75%	50%
Air Pressure:	860~1060mbar	1000mbar

#### 4.6. Statement of the measurement uncertainty

No.	Test Items	Measurement Uncertainty
1	AC Conducted Emission	3.21dB
2	20dB Bandwidth	0.002%
3	99% Occupied Bandwidth	0.002%
4	Transmission time	2.3ns
5	Duty cycle corrected factor	-
6	Field strength of the Fundamental signal	4.54dB for 30MHz-1GHz 5.10dB for above 1GHz
7	Radiated Spurious Emission	4.54dB for 30MHz-1GHz 5.10dB for above 1GHz

This uncertainty represents an expanded uncertainty expressed at approximately the 95% confidence level using a coverage factor of  $k=1.96$ .

## 4.7. Equipment Used during the Test

● Conducted test item							
Used	Test Equipment	Manufacturer	Equipment No.	Model No.	Serial No.	Last Cal. Date (YY-MM-DD)	Next Cal. Date (YY-MM-DD)
●	Signal and spectrum Analyzer	R&S	HTWE0242	FSV40	100048	2022/08/25	2023/08/24
●	Signal & Spectrum Analyzer	R&S	HTWE0262	FSW26	103440	2022/08/25	2023/08/24
●	Vector signal generator	R&S	HTWE0244	SMBV100A	260790	2023/05/23	2024/05/22
●	Test software	Tonscend	N/A	JS1120	N/A	N/A	N/A

● Radiated emission- Below 1GHz							
Used	Test Equipment	Manufacturer	Equipment No.	Model No.	Serial No.	Last Cal. Date (YY-MM-DD)	Next Cal. Date (YY-MM-DD)
●	Semi-Anechoic Chamber	Albatross projects	HTWE0127	SAC-3m-02	C11121	2018/09/30	2023/09/29
●	EMI Test Receiver	R&S	HTWE0099	ESCI	100900	2022/08/30	2023/08/29
●	Loop Antenna	R&S	HTWE0546	HFH2-Z2E	101073	2021/05/25	2024/05/24
●	Ultra-Broadband Antenna	SCHWARZBECK	HTWE0547	VULB9163	945	2022/05/23	2025/05/22
●	Pre-Amplifier	SCHWARZBECK	HTWE0295	BBV 9742	N/A	2022/11/04	2023/11/03
●	RF Connection Cable	HUBER+SUHNER	HTWE0062-01	N/A	N/A	2023/02/24	2024/02/23
●	RF Connection Cable	HUBER+SUHNER	HTWE0062-02	SUCOFLEX104	501184/4	2023/02/24	2024/02/23
●	Test Software	R&S	N/A	ES-K1	N/A	N/A	N/A

● Radiated emission- Above 1GHz							
Used	Test Equipment	Manufacturer	Equipment No.	Model No.	Serial No.	Last Cal. Date (YY-MM-DD)	Next Cal. Date (YY-MM-DD)
●	Semi-Anechoic Chamber	Albatross projects	HTWE0122	SAC-3m-01	C11121	2018/09/27	2023/09/26
●	Spectrum Analyzer	R&S	HTWE0098	FSP40	100597	2022/08/25	2023/08/24
●	Horn Antenna	ETS	HTWE0548	3117	240120	2022/05/20	2025/05/19
●	Horn Antenna	STEATITE	HTWE0549	QMS-00880	25661	2022/05/20	2025/05/19
●	Pre-amplifier	CD	HTWE0071	PAP-0102	12004	2022/11/04	2023/11/03
●	Broadband Pre-amplifier	SCHWARZBECK	HTWE0201	BBV 9718	9718-248	2023/02/27	2024/02/26
●	RF Connection Cable	HUBER+SUHNER	HTWE0120-01	6m 18GHz S Serisa	N/A	2023/02/24	2024/02/23
●	RF Connection Cable	HUBER+SUHNER	HTWE0120-02	6m 3GHz RG Serisa	N/A	2023/02/24	2024/02/23
●	RF Connection Cable	HUBER+SUHNER	HTWE0119-05	6m 3GHz RG Serisa	N/A	2023/02/24	2024/02/23
●	RF Connection Cable	HUBER+SUHNER	HTWE0120-04	6m 3GHz RG Serisa	N/A	2023/02/24	2024/02/23
●	Test Software	Audix	N/A	E3	N/A	N/A	N/A



## 5. TEST CONDITIONS AND RESULTS

### 5.1. Antenna Requirement

#### Requirement

#### **FCC CFR Title 47 Part 15 Subpart C Section 15.203:**

An intentional radiator shall be designed to ensure that no antenna other than that furnished by the responsible party shall be used with the device. The use of a permanently attached antenna or of an antenna that uses a unique coupling to the intentional radiator, the manufacturer may design the unit so that a broken antenna can be replaced by the user, but the use of a standard antenna jack or electrical connector is prohibited.

#### TEST RESULT

**Passed**       **Not Applicable**

The antenna type is a PCB antenna, please refer to the below antenna photo.

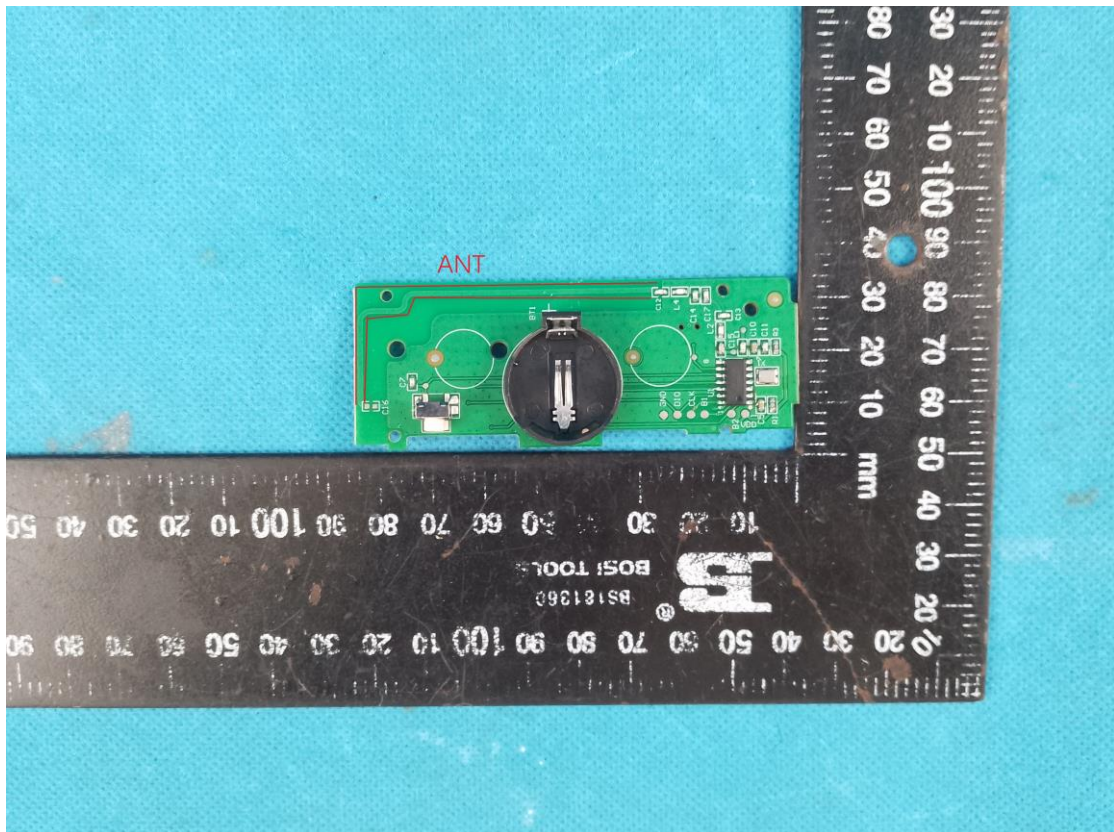

## 5.2. AC Conducted Emission

### LIMIT

#### FCC CFR Title 47 Part 15 Subpart C Section 15.207

Frequency range (MHz)	Limit (dBuV)	
	Quasi-peak	Average
0.15-0.5	66 to 56*	56 to 46*
0.5-5	56	46
5-30	60	50

\* Decreases with the logarithm of the frequency.

### TEST CONFIGURATION

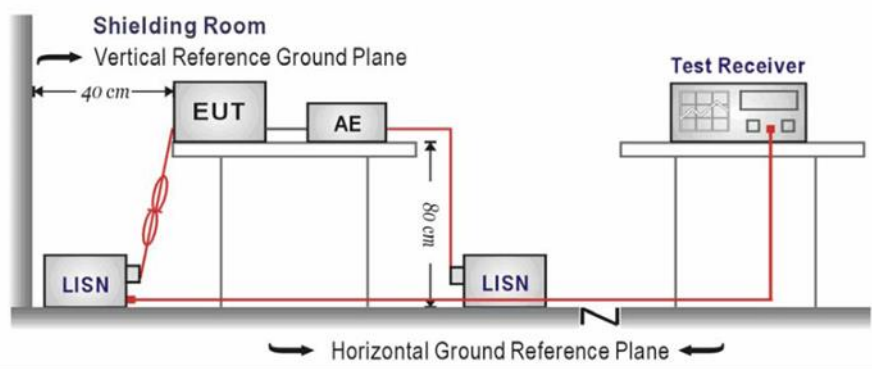

### TEST PROCEDURE

1. The EUT was setup according to ANSI C63.10 requirements.
2. The EUT was placed on a platform of nominal size, 1 m by 1.5 m, raised 80 cm above the conducting ground plane. The vertical conducting plane was located 40 cm to the rear of the EUT. All other surfaces of EUT were at least 80 cm from any other grounded conducting surface.
3. The EUT and simulators are connected to the main power through a line impedances stabilization network (LISN). The LISN provides a 50 ohm /50uH coupling impedance for the measuring equipment.
4. The peripheral devices are also connected to the main power through a LISN. (Please refer to the block diagram of the test setup and photographs)
5. Each current-carrying conductor of the EUT power cord, except the ground (safety) conductor, was individually connected through a LISN to the input power source.
6. The excess length of the power cord between the EUT and the LISN receptacle were folded back and forth at the center of the lead to form a bundle not exceeding 40 cm in length.
7. Conducted emissions were investigated over the frequency range from 0.15MHz to 30MHz using a receiver bandwidth of 9 kHz.
8. During the above scans, the emissions were maximized by cable manipulation.

### TEST MODE:

Please refer to the clause 4.2

### TEST RESULT

Passed  Not Applicable

### 5.3. 20dB bandwidth

#### LIMIT

The bandwidth of the emission shall be no wider than 0.25% of the center frequency for devices operating above 70MHz and below 900 MHz.

For devices operating above 900 MHz, the emission shall be no wider than 0.5% of the center frequency.

#### TEST CONFIGURATION

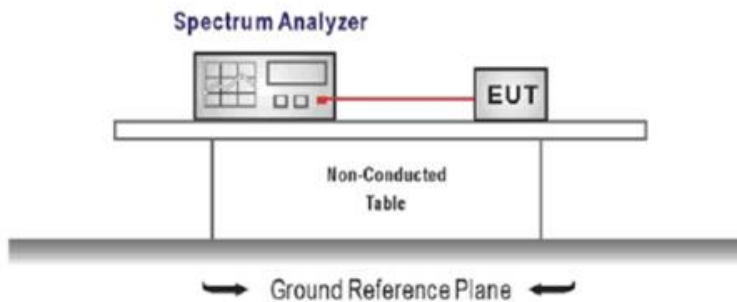

#### TEST PROCEDURE

1. Connect the antenna port(s) to the spectrum analyzer input.
2. Configure the spectrum analyzer as shown below (enter all losses between the transmitter output and the spectrum analyzer).  
Center Frequency = channel center frequency  
Span= approximately 2 to 3 times the 20 dB bandwidth  
RBW = 100 kHz, VBW  $\geq 3 \times$  RBW  
Sweep time= auto couple  
Detector = Peak  
Trace mode = max hold
3. Place the radio in continuous transmit mode, allow the trace to stabilize, view the transmitter waveform on the spectrum analyzer.
4. Measure the maximum width of the emission that is constrained by the frequencies associated with the two outermost amplitude points (upper and lower frequencies) that are attenuated by 20 dB relative to the maximum level measured in the fundamental emission, and record the pertinent measurements.

#### TEST MODE:

Please refer to the clause 4.2

#### TEST RESULT

Passed       Not Applicable

#### TEST DATA:

Refer to the appendix report on the section 8

## 5.4. 99% Occupied Bandwidth

### LIMIT

N/A

### TEST CONFIGURATION

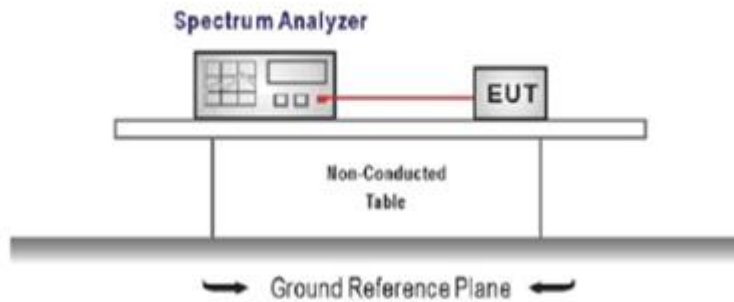

### TEST PROCEDURE

1. Connect the antenna port(s) to the spectrum analyzer input.
2. Configure the spectrum analyzer as shown below (enter all losses between the transmitter output and the spectrum analyzer).  
Center Frequency = channel center frequency  
Span  $\geq 1.5 \times$  OBW  
RBW = 1%~5%OBW  
VBW  $\geq 3 \times$  RBW  
Sweep time = auto couple  
Detector = Peak  
Trace mode = max hold
3. Place the radio in continuous transmit mode, allow the trace to stabilize, view the transmitter waveform on the spectrum analyzer.

### TEST MODE:

Please refer to the clause 4.2

### TEST RESULT

Passed       Not Applicable

### TEST DATA

Refer to the appendix report on the section 8

## 5.5. Transmission Time

### LIMIT

A manually operated transmitter shall employ a switch that will auto-matically deactivate the transmitter within not more than 5 seconds of being released.

### TEST CONFIGURATION

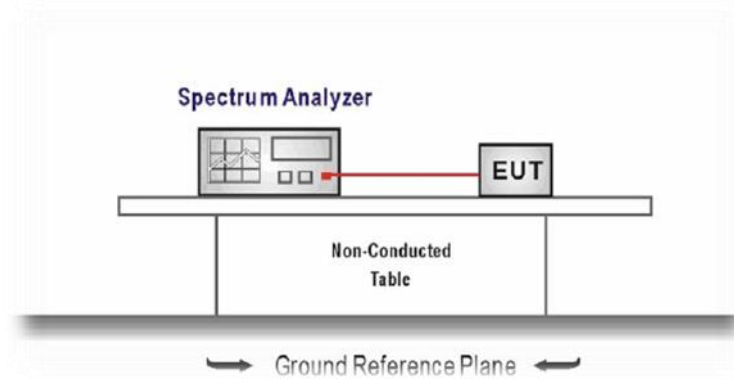

### TEST PROCEDURE

1. The transmitter output was connected to the spectrum analyzer through an attenuator, the path loss was compensated to the results for each measurement.
2. Set to the maximum power setting and enable the EUT transmit continuously
3. Use the following spectrum analyzer settings:  
Frequency=Center carrier frequency  
RBW=100kHz, VBW=300kHz, Span= zero,  
Sweep time= 10second, Detector function = peak, Trace = single
4. Measure and record the results in the test report.

### TEST MODE:

Please refer to the clause 4.2

### TEST RESULTS

Passed       Not Applicable

### TEST DATA

Refer to the appendix report on the section 8

## 5.6. Duty Cycle Corrected Factor

### LIMIT

N/A

### TEST CONFIGURATION

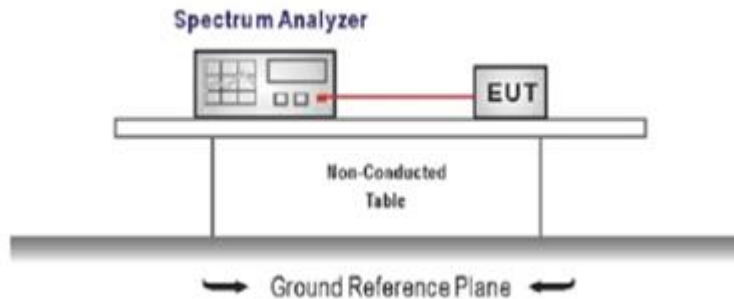

### TEST PROCEDURE

1. The transmitter output was connected to the spectrum analyzer through an attenuator, the path loss was compensated to the results for each measurement.
2. Set to the maximum power setting and enable the EUT transmit continuously
3. Use the following spectrum analyzer settings:  
Span=zero span, Frequency=centered channel, RBW= 1MHz, VBW  $\geq$  RBW  
Sweep time=as necessary to capture the entire dwell time,  
Detector function = peak, Trigger mode
4. Measure and record the duty cycle data

### TEST MODE:

Please refer to the clause 4.2

### TEST DATA

Refer to the appendix report on the section 8

## 5.7. Radiated field strength of the fundamental signal

### LIMIT

Fundamental frequency (MHz)	Field strength of fundamental (microvolts/meter)	Field strength of spurious emissions (microvolts/meter)
40.66-40.70	2,250	225
70-130	1,250	125
130-174	<sup>1</sup> 1,250 to 3,750	<sup>1</sup> 125 to 375
174-260	3,750	375
260-470	<sup>1</sup> 3,750 to 12,500	<sup>1</sup> 375 to 1,250
Above 470	12,500	1,250

<sup>1</sup>Linear interpolations.

### TEST CONFIGURATION

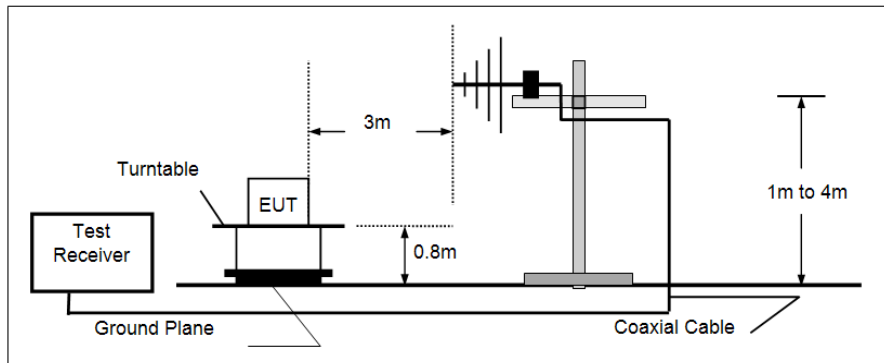

### TEST PROCEDURE

1. The EUT was setup and tested according to ANSI C63.10.
2. The EUT is placed on a turn table which is 0.8 meter above ground for below 1GHz, The turn table is rotated 360 degrees to determine the position of the maximum emission level.
3. The EUT was set 3 meters from the receiving antenna, which was mounted on the top of a variable height antenna tower.
4. For each suspected emission, the EUT was arranged to its worst case and then tune the Antenna tower (from 1 m to 4 m) and turntable (from 0 degree to 360 degrees) to find the maximum reading. A pre-amp and a high pass filter are used for the test in order to get better signal level to comply with the guidelines.
5. Set to the maximum power setting and enable the EUT transmit continuously.
6. Use the following spectrum analyzer settings
  - a) Span shall wide enough to fully capture the emission being measured;
  - b) RBW=120 kHz, VBW=300 kHz, Sweep=auto, Detector function=peak, Trace=max hold;

If the emission level of the EUT measured by the peak detector is 3 dB lower than the applicable limit, the peak emission level will be reported. Otherwise, the emission measurement will be repeated using the quasi-peak detector and reported.

### TEST MODE:

Please refer to the clause 4.2

### TEST RESULTS

Passed       Not Applicable

Note:

- 1) Level= Reading + Factor; Factor =Antenna Factor+ Cable Loss- Preamp Factor
- 2) Over Limit = Level - Limit



Polarization: Horizontal

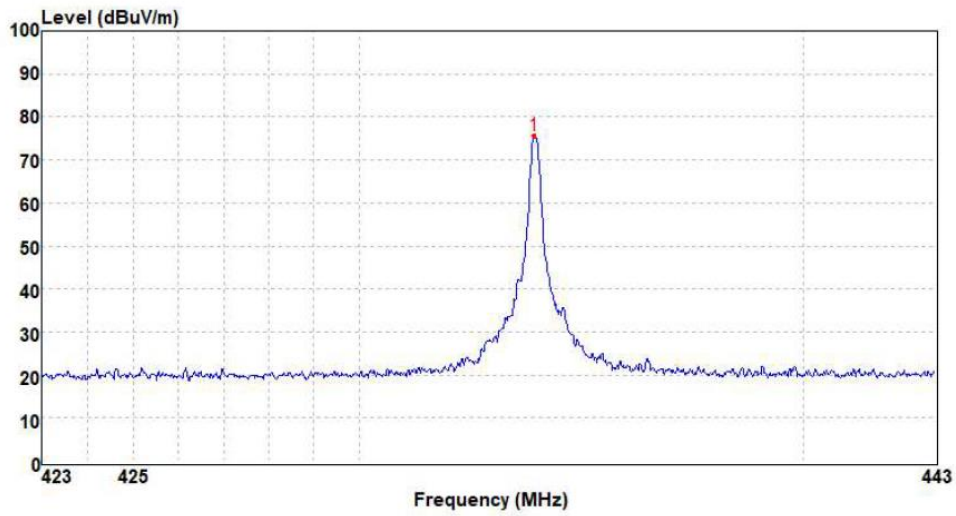

Polarization: Vertical

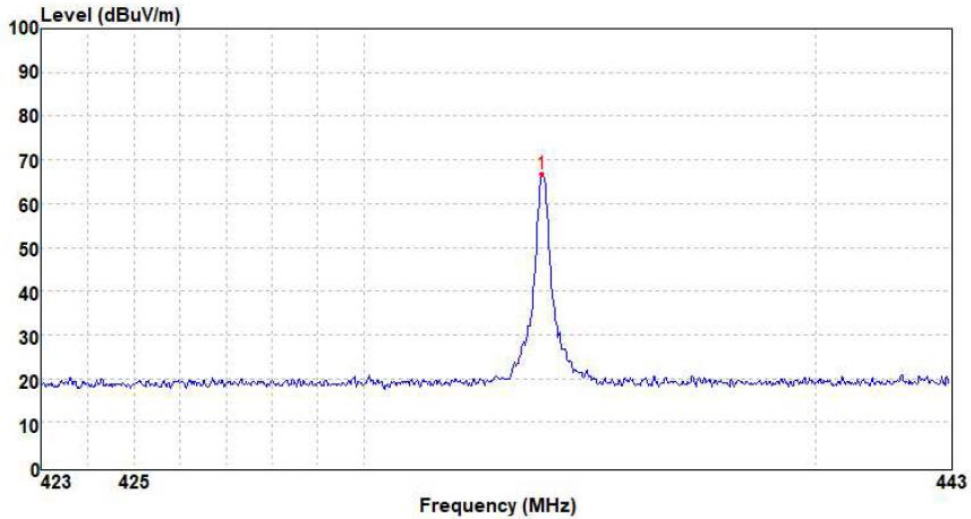

Fundamental of Peak								
No.	Freq. [MHz]	Reading [dBμV/m]	Factor [dB]	Level [dBμV/m]	Limit [dBμV/m]	Margin [dB]	Polarity	Detector
1	433.92	71.75	-5.10	66.65	100.80	34.15	Vertical	PK
2	433.92	80.83	-5.10	75.73	100.80	25.07	Horizontal	PK

Fundamental of Average								
No.	Freq. [MHz]	PK level [dBμV/m]	DCCF [dB]	Level [dBμV/m]	Limit [dBμV/m]	Margin [dB]	Polarity	Detector
1	433.92	66.65	-6.32	60.33	80.80	20.47	Vertical	AV
2	433.92	75.73	-6.32	69.41	80.80	11.39	Horizontal	AV



### 5.8. Radiated Spurious Emission

#### LIMIT

#### FCC CFR Title 47 Part 15 Subpart C Section 15.231(b)

Fundamental frequency (MHz)	Field strength of fundamental (microvolts/meter)	Field strength of spurious emissions (microvolts/meter)
40.66-40.70	2,250	225
70-130	1,250	125
130-174	<sup>1</sup> 1,250 to 3,750	<sup>1</sup> 125 to 375
174-260	3,750	375
260-470	<sup>1</sup> 3,750 to 12,500	<sup>1</sup> 375 to 1,250
Above 470	12,500	1,250

#### FCC CFR Title 47 Part 15 Subpart C Section 15.209

Frequency	Limit (dBuV/m)	Value
0.009 MHz ~0.49 MHz	2400/F(kHz) @300m	Quasi-peak
0.49 MHz ~ 1.705 MHz	24000/F(kHz) @30m	Quasi-peak
1.705 MHz ~30 MHz	30 @30m	Quasi-peak

Note: Limit dBuV/m @3m = Limit dBuV/m @300m + 40\*log(300/3)= Limit dBuV/m @300m +80,

Limit dBuV/m @3m = Limit dBuV/m @30m +40\*log(30/3)= Limit dBuV/m @30m + 40.

Frequency	Limit (dBuV/m @3m)	Value
30MHz~88MHz	40.00	Quasi-peak
88MHz~216MHz	43.50	Quasi-peak
216MHz~960MHz	46.00	Quasi-peak
960MHz~1GHz	54.00	Quasi-peak
Above 1GHz	54.00	Average
	74.00	Peak

#### TEST CONFIGURATION

- 9 kHz ~ 30 MHz

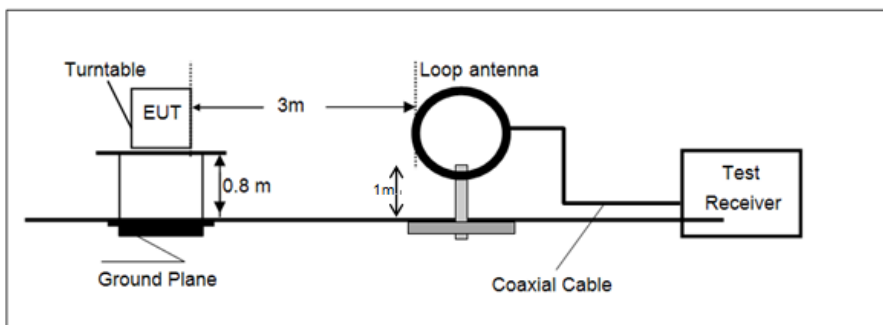

- 30 MHz ~ 1 GHz

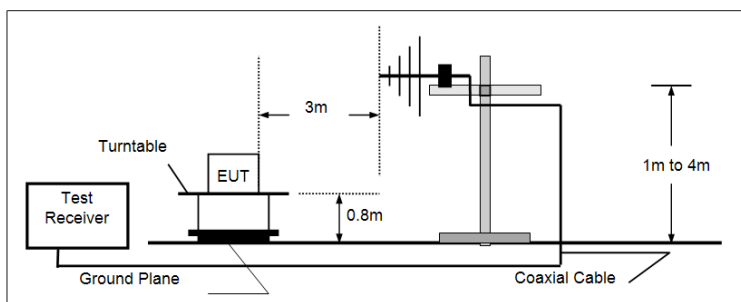

- Above 1 GHz

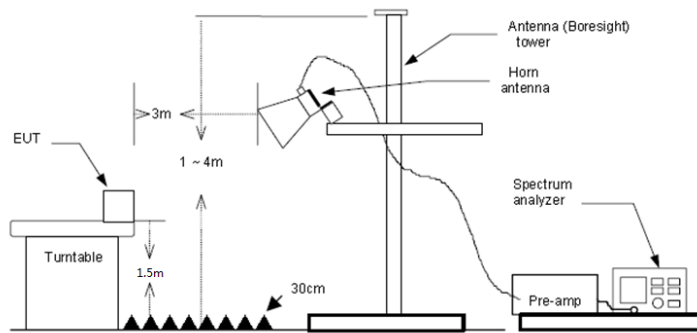

## **TEST PROCEDURE**

1. The EUT was setup and tested according to ANSI C63.10.
2. The EUT is placed on a turn table which is 0.8 meter above ground for below 1 GHz, and 1.5 m for above 1 GHz. The turn table is rotated 360 degrees to determine the position of the maximum emission level.
3. The EUT was set 3 meters from the receiving antenna, which was mounted on the top of a variable height antenna tower.
4. For each suspected emission, the EUT was arranged to its worst case and then tune the Antenna tower (from 1 m to 4 m) and turntable (from 0 degree to 360 degrees) to find the maximum reading. A pre-amp and a high pass filter are used for the test in order to get better signal level to comply with the guidelines.
5. Set to the maximum power setting and enable the EUT transmit continuously.
6. Use the following spectrum analyzer settings
  - a) Span shall wide enough to fully capture the emission being measured;
  - b) Below 1 GHz:
    - RBW=120 kHz, VBW=300 kHz, Sweep=auto, Detector function=peak, Trace=max hold;
    - If the emission level of the EUT measured by the peak detector is 3 dB lower than the applicable limit, the peak emission level will be reported. Otherwise, the emission measurement will be repeated using the quasi-peak detector and reported.
  - c) Set RBW=1MHz, VBW=3MHz for >1GHz, Sweep time=auto, Detector=peak, Trace=max hold for Peak measurement
    - For average measurement:
    - Average level = Peak level – DCCF

## **TEST MODE:**

Please refer to the clause 4.2

## **TEST RESULT**

**Passed**       **Not Applicable**

Note:

- 1) Level= Reading + Factor/Transd; Factor/Transd =Antenna Factor+ Cable Loss- Preamp Factor
- 2) Margin = Limit – Level
- 3) Over Limit = Level – Limit

## **FOR 9 kHz ~ 30 MHz**

The EUT was pre-scanned this frequency band, found the radiated level 20dB lower than the limit, so don't show data on this report.

**FOR 30 MHz ~ 1000 MHz**

Polarization:

Horizontal

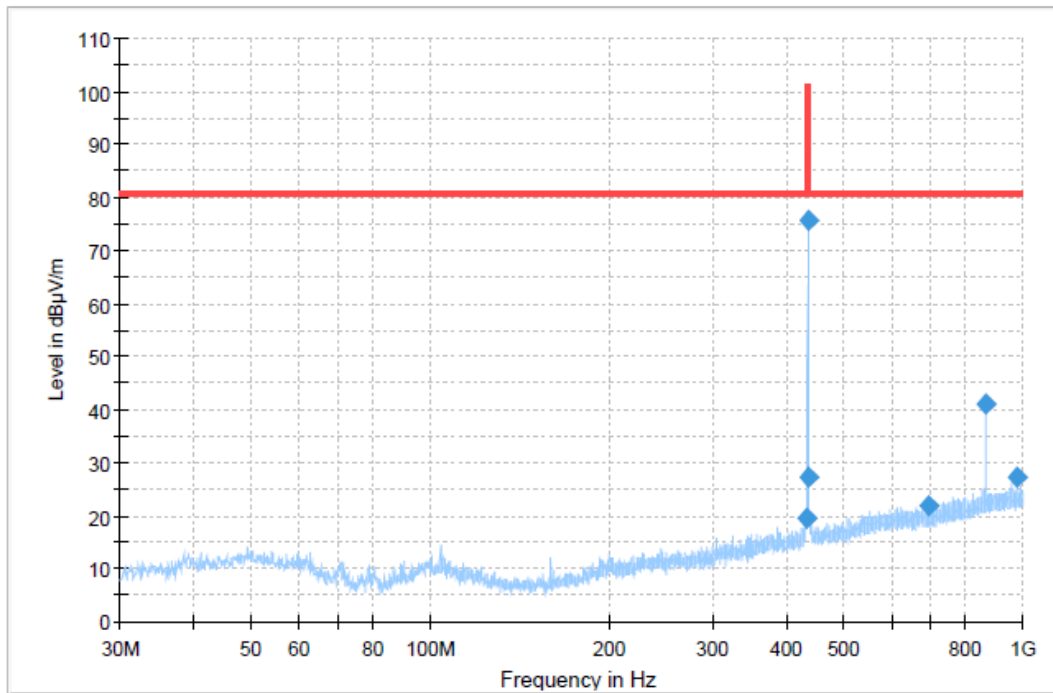

**Final Result**

Frequency (MHz)	MaxPeak (dBµV/m)	Limit (dBµV/m)	Margin (dB)	Height (cm)	Pol	Azimuth (deg)	Corr. (dB/m)
431.701250	19.63	80.80	61.17	100.0	H	326.0	-2.6
433.883750	75.72	100.80	25.08	100.0	H	298.0	-2.5
435.096250	27.37	80.80	53.43	100.0	H	298.0	-2.5
693.965000	22.02	80.80	58.78	100.0	H	46.0	1.3
867.837500	41.11	80.80	39.69	100.0	H	216.0	4.0
980.842500	27.23	80.80	53.57	300.0	H	219.0	4.8

Spurious Emission of Average								
No.	Freq. [MHz]	PK level [dBµV/m]	DCCF [dB]	Level [dBµV/m]	Limit [dBµV/m]	Margin [dB]	Polarity	Detector
1	431.70125	19.63	-6.32	13.31	60.80	47.49	Horizontal	AV
2	433.88375	75.72	-6.32	69.40	80.80	11.40	Horizontal	AV
3	435.09625	27.37	-6.32	21.05	60.80	39.75	Horizontal	AV
4	693.96500	22.02	-6.32	15.70	60.80	45.10	Horizontal	AV
5	867.83750	41.11	-6.32	34.79	60.80	26.01	Horizontal	AV
6	980.84250	27.23	-6.32	20.91	60.80	39.89	Horizontal	AV

Polarization:

Vertical

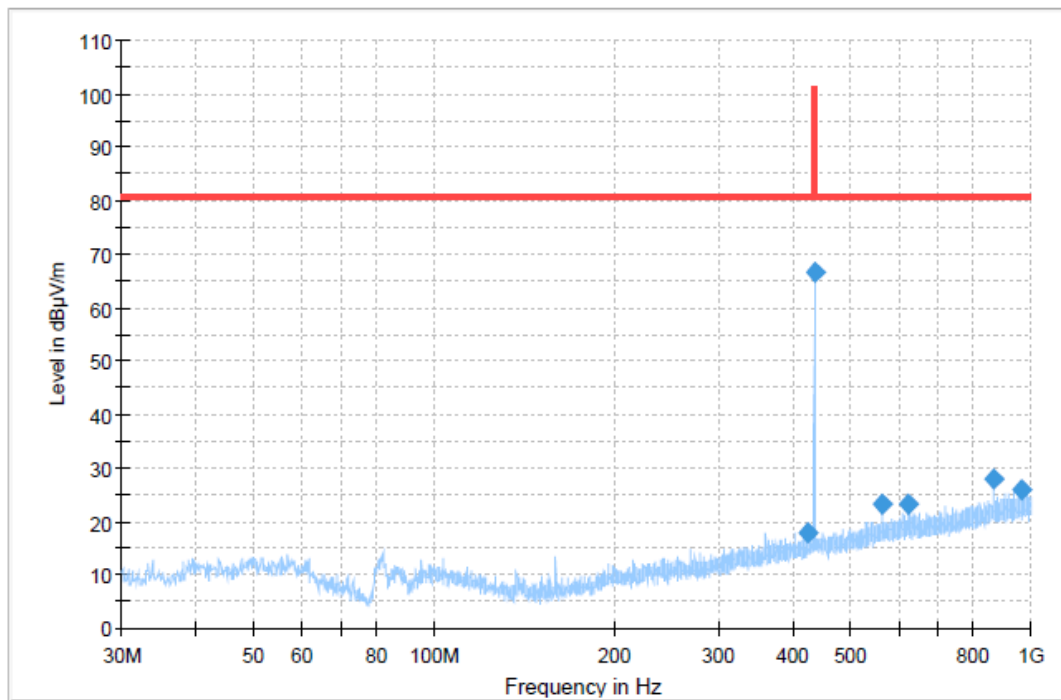

**Final Result**

Frequency (MHz)	MaxPeak (dBµV/m)	Limit (dBµV/m)	Margin (dB)	Height (cm)	Pol	Azimuth (deg)	Corr. (dB/m)
424.305000	17.98	80.80	62.82	100.0	V	342.0	-2.7
433.883750	66.76	100.80	34.04	100.0	V	45.0	-2.5
562.651250	23.14	80.80	57.66	100.0	V	81.0	0.2
625.095000	23.32	80.80	57.48	100.0	V	45.0	1.0
867.837500	28.00	80.80	52.80	100.0	V	26.0	4.0
967.990000	26.06	80.80	54.74	100.0	V	208.0	4.7

Spurious Emission of Average

No.	Freq. [MHz]	PK level [dBµV/m]	DCCF [dB]	Level [dBµV/m]	Limit [dBµV/m]	Margin [dB]	Polarity	Detector
1	424.30500	17.98	-6.32	11.66	60.80	49.14	Vertical	AV
2	433.88375	66.76	-6.32	60.44	80.80	20.36	Vertical	AV
3	562.65125	23.14	-6.32	16.82	60.80	43.98	Vertical	AV
4	625.09500	23.32	-6.32	17.00	60.80	43.8	Vertical	AV
5	867.83750	28.00	-6.32	21.68	60.80	39.12	Vertical	AV
6	967.99000	26.06	-6.32	19.74	60.80	41.06	Vertical	AV

**FOR 1 GHz ~ 5 GHz**

Polarization:

Horizontal

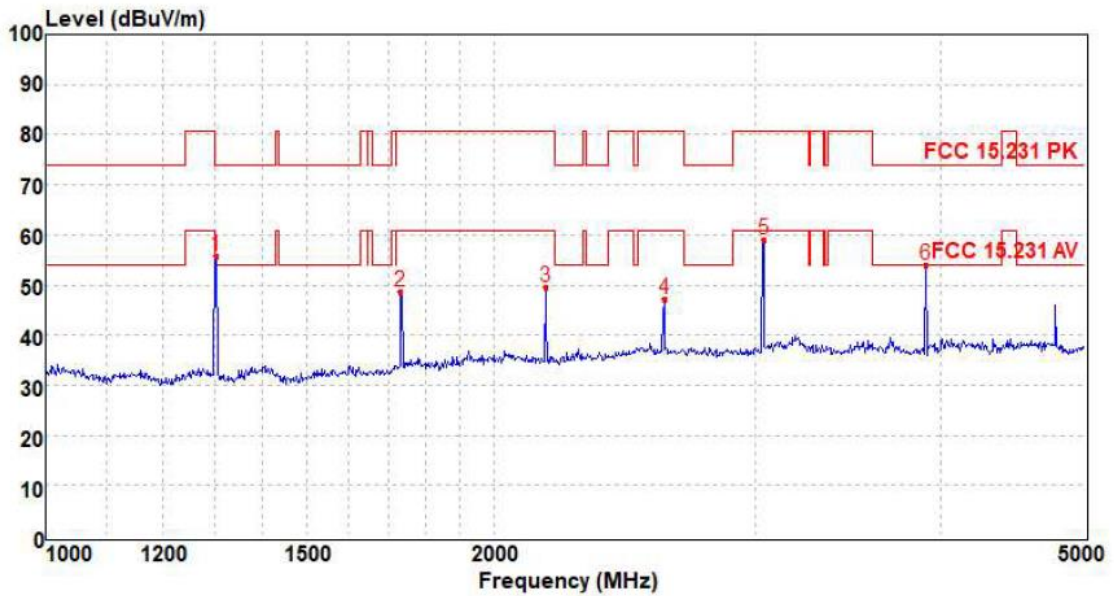

Mark	Frequency MHz	Reading dBuV/m	Antenna dB	Cable dB	Preamp dB	Level dBuV/m	Limit dBuV/m	Over limit	Remark
1	1302.06	67.05	28.48	2.95	42.70	55.78	74.00	-18.22	Peak
2	1734.00	58.00	29.65	3.38	42.37	48.66	80.80	-32.14	Peak
3	2168.73	56.71	31.30	3.76	42.31	49.46	80.80	-31.34	Peak
4	2605.48	52.38	32.89	4.14	42.08	47.33	80.80	-33.47	Peak
5	3040.80	63.90	32.75	4.48	41.92	59.21	80.80	-21.59	Peak
6	3908.66	57.27	33.13	5.11	41.61	53.90	74.00	-20.10	Peak

Spurious Emission of Average								
No.	Freq. [MHz]	PK level [dBuV/m]	DCCF [dB]	Level [dBuV/m]	Limit [dBuV/m]	Margin [dB]	Polarity	Detector
1	1302.06	55.78	-6.32	49.46	54.00	4.54	Horizontal	AV
2	1734.00	48.66	-6.32	42.34	60.80	18.46	Horizontal	AV
3	2168.73	49.46	-6.32	43.14	60.80	17.66	Horizontal	AV
4	2605.48	47.33	-6.32	41.01	60.80	19.79	Horizontal	AV
5	3040.80	59.21	-6.32	52.89	60.80	7.91	Horizontal	AV
6	3908.66	53.98	-6.32	47.66	54.00	6.34	Horizontal	AV

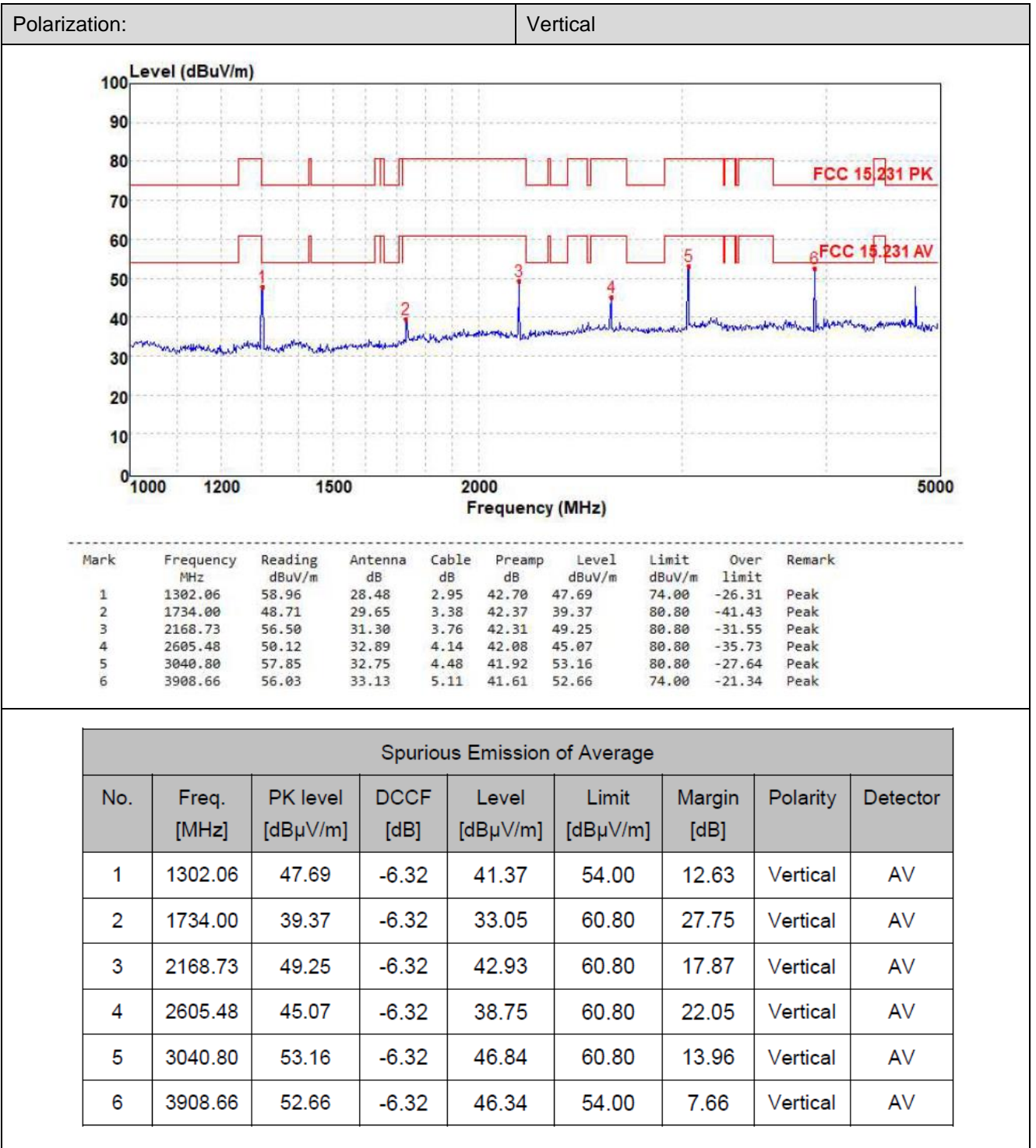



## 6. TEST SETUP PHOTOS

Radiated Emission

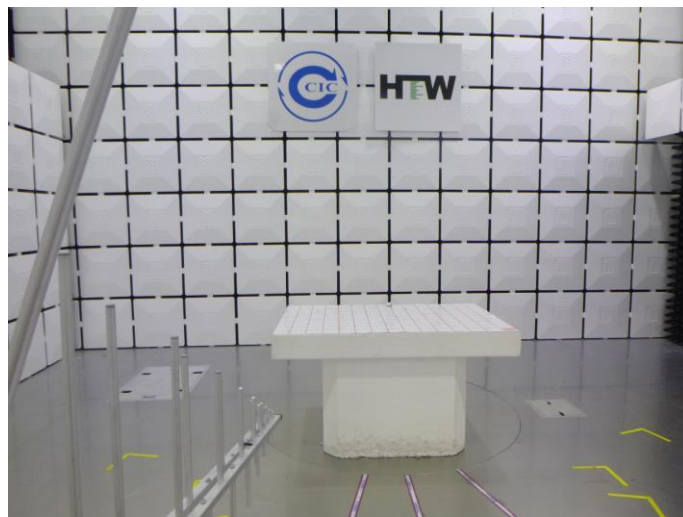
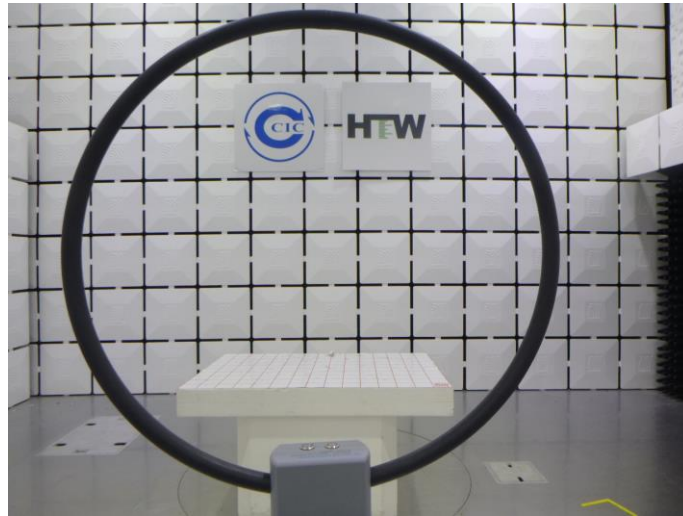

## 7. EXTERNAL AND INTERNAL PHOTOS

### 7.1. External Photos

G1764-A1-000

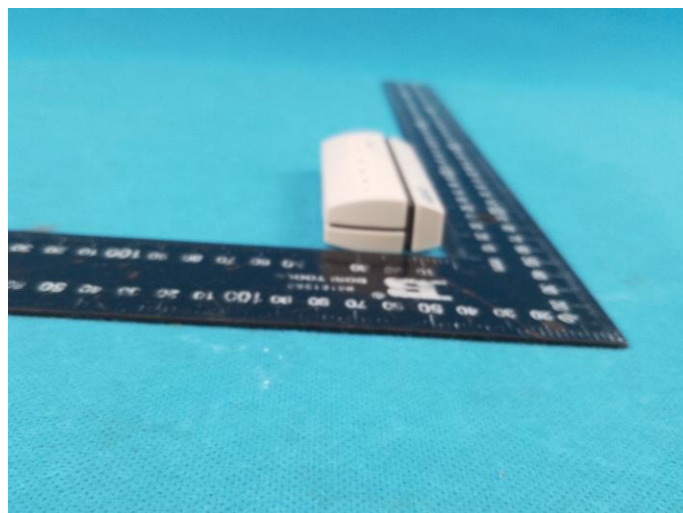
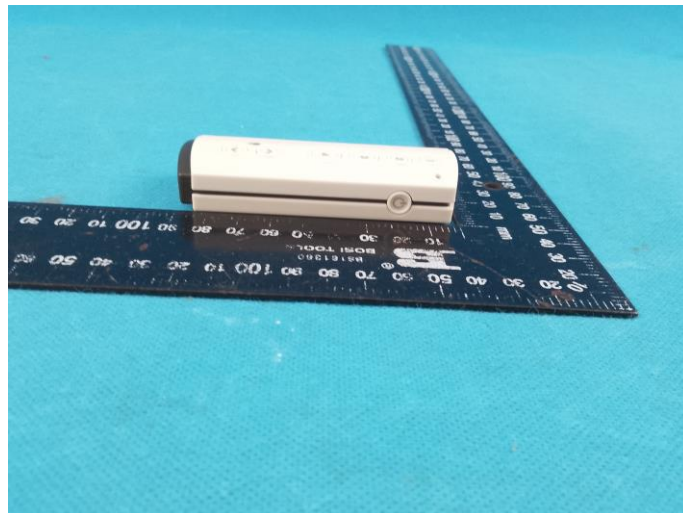



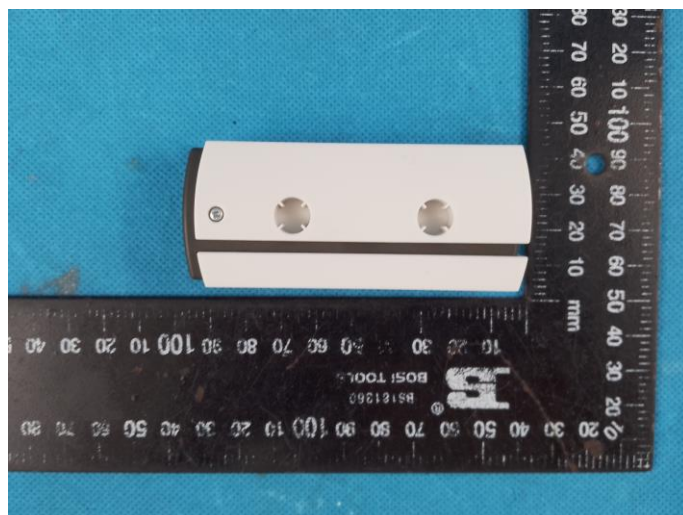
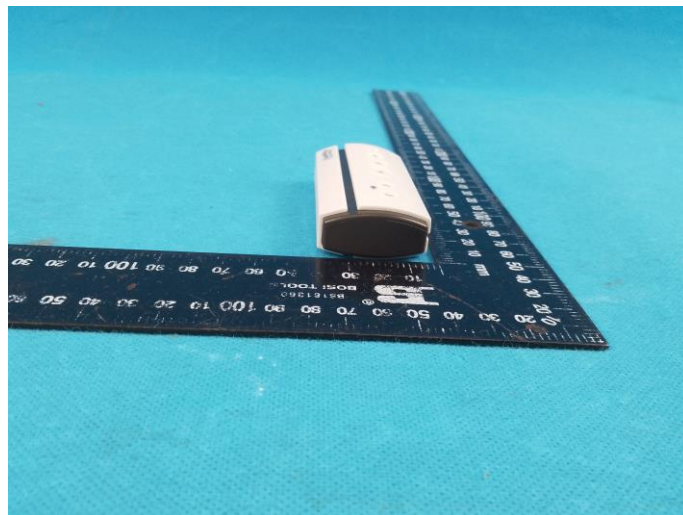
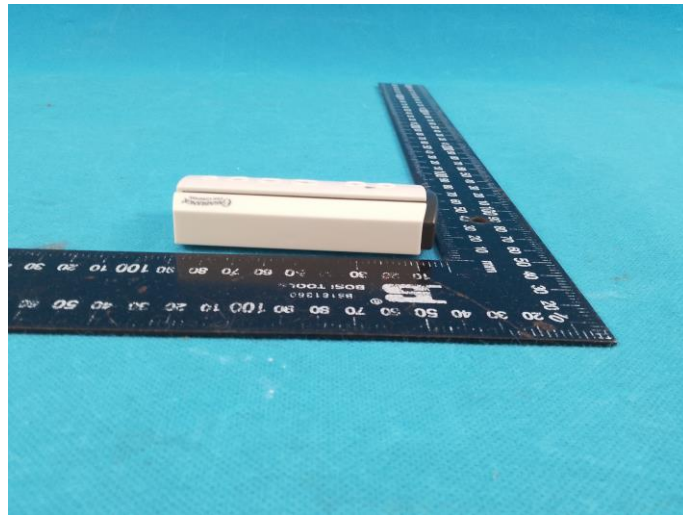

G1764-A2-000

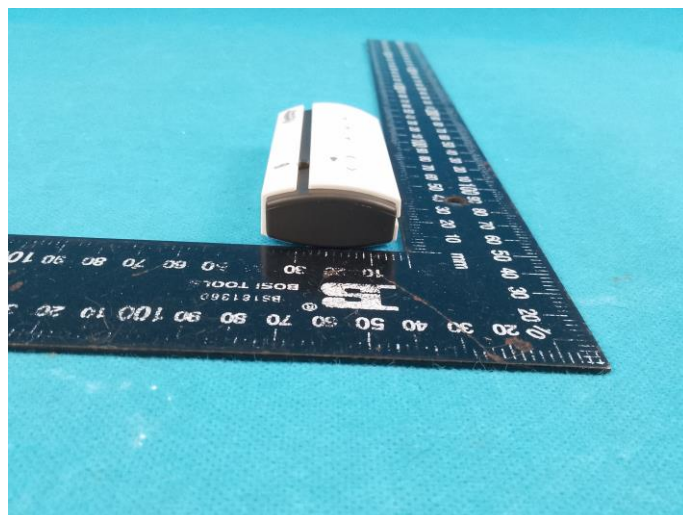
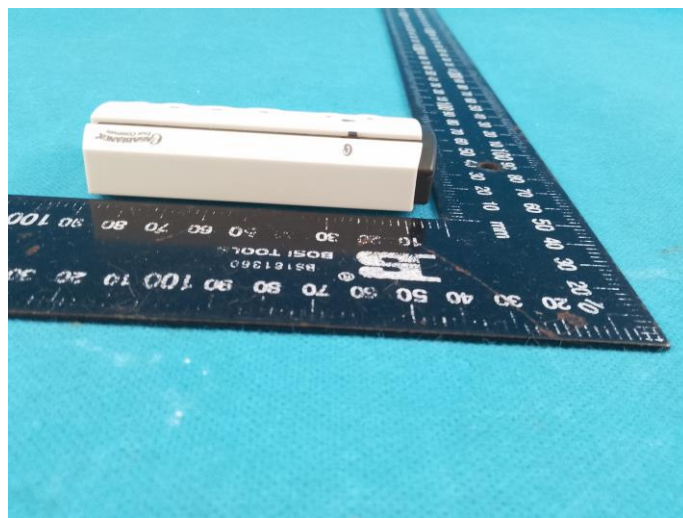
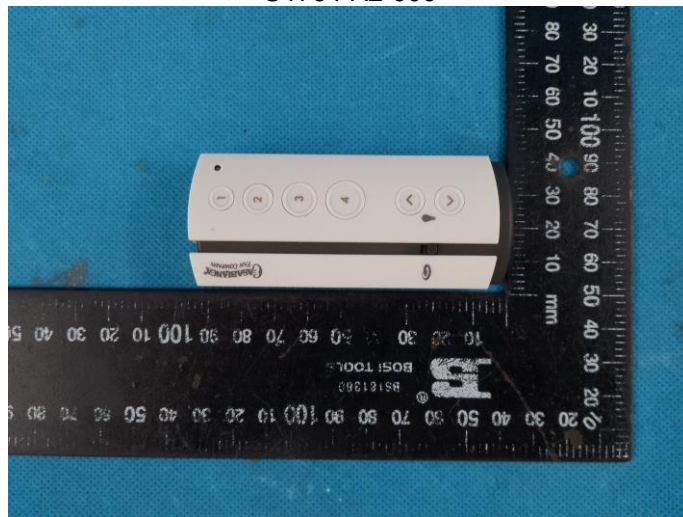

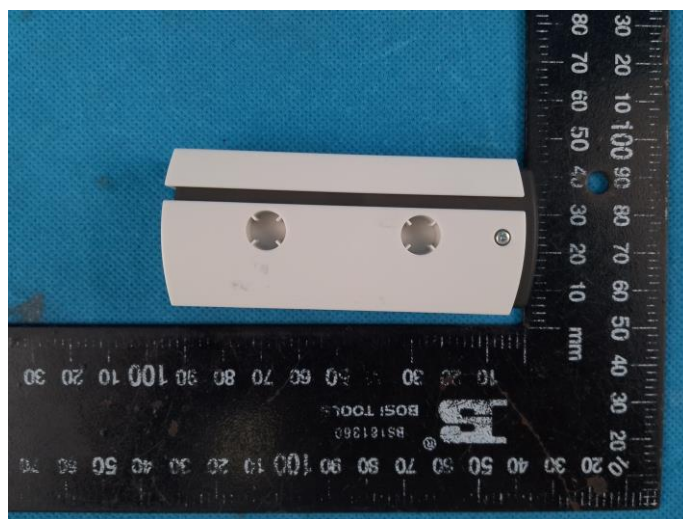
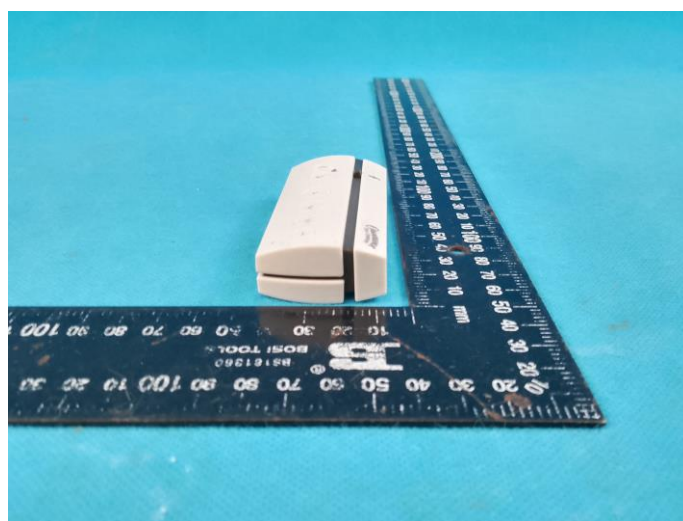
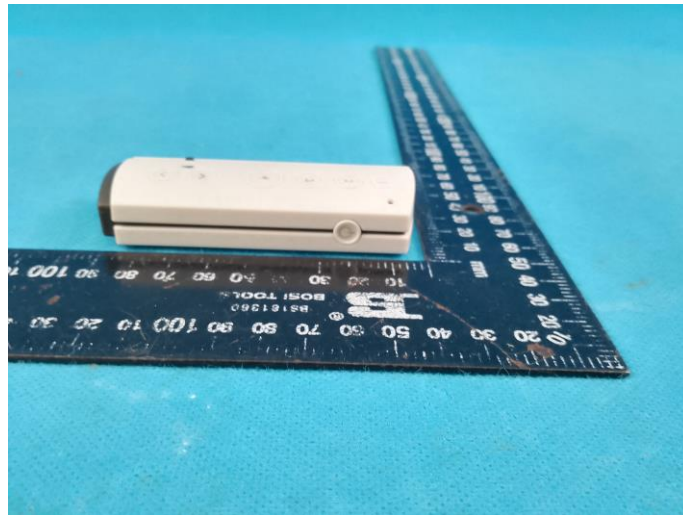



J0250-A1

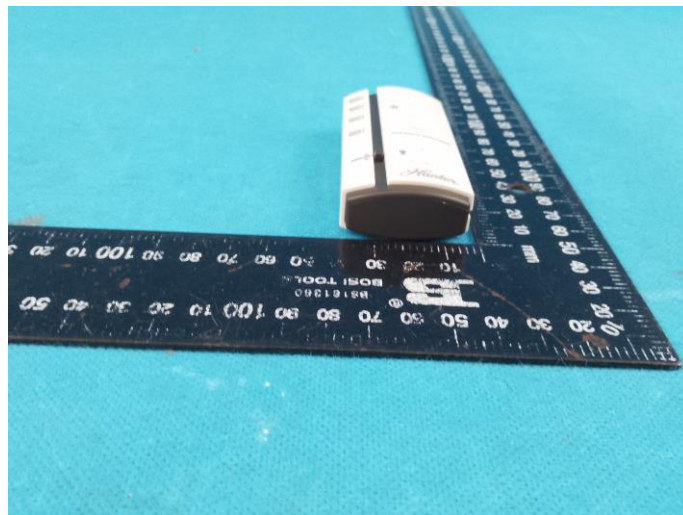
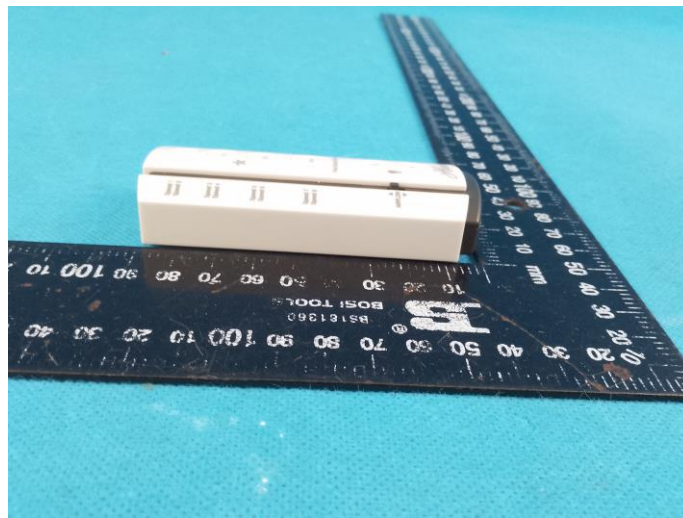
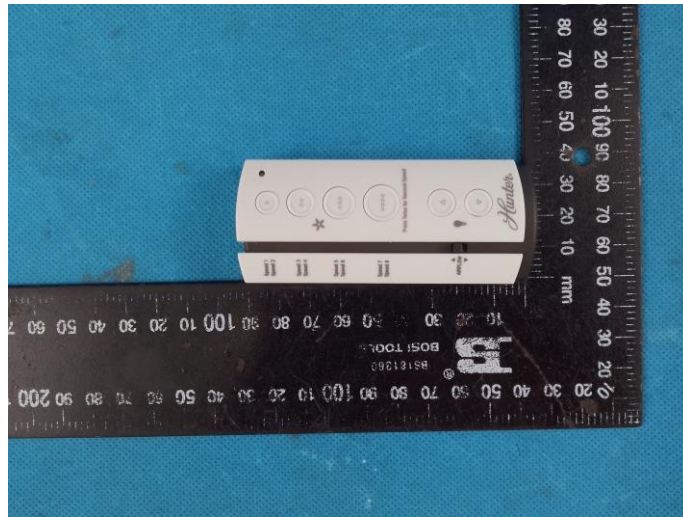

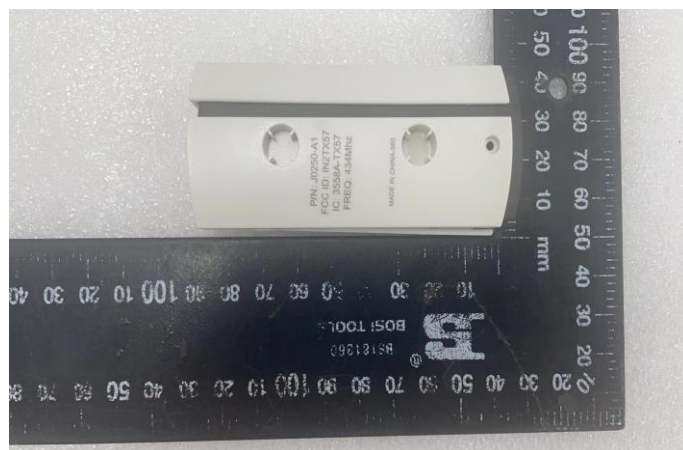
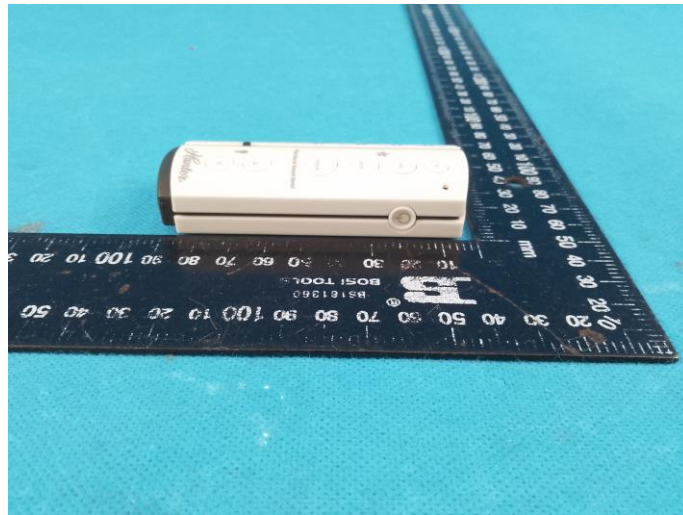

## 7.2. Internal Photos

G1764-A1-000

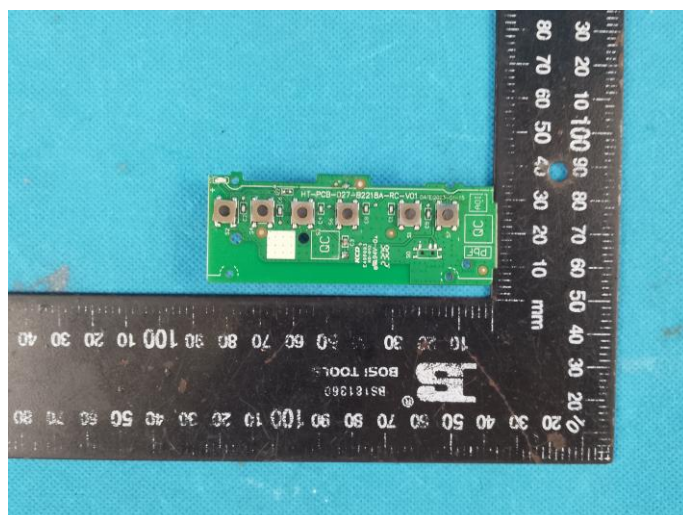
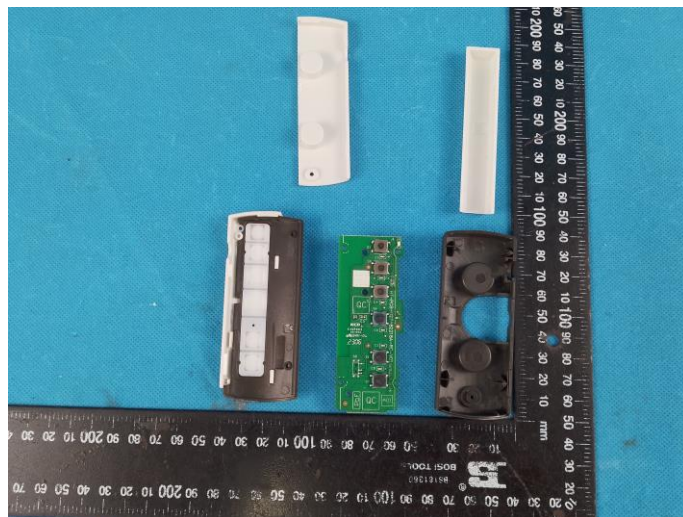
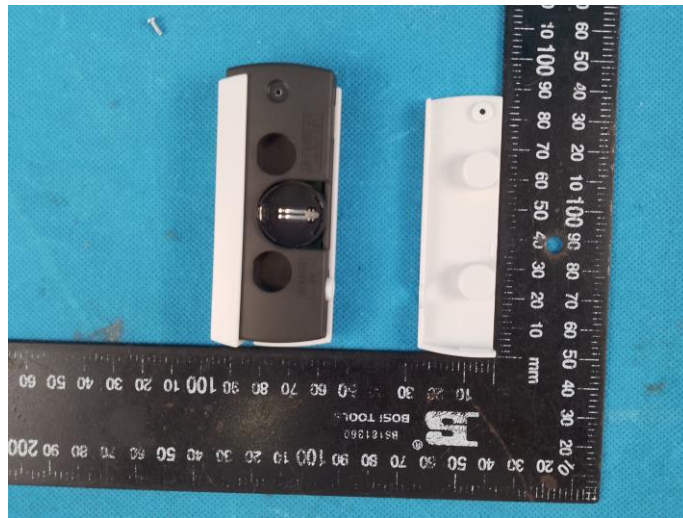



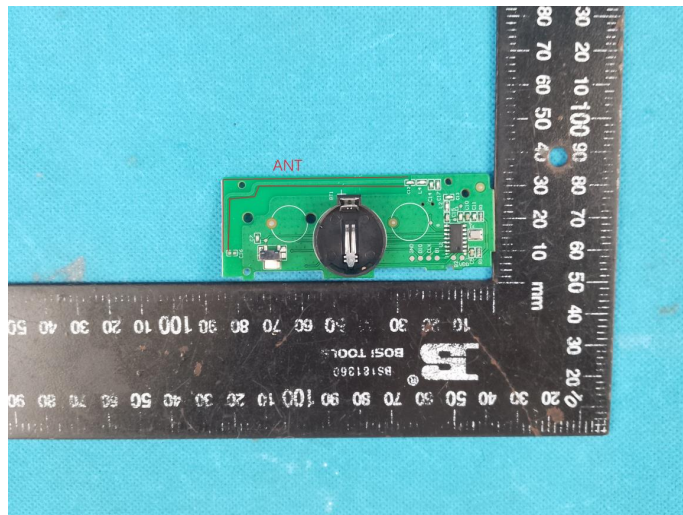

G1764-A2-000

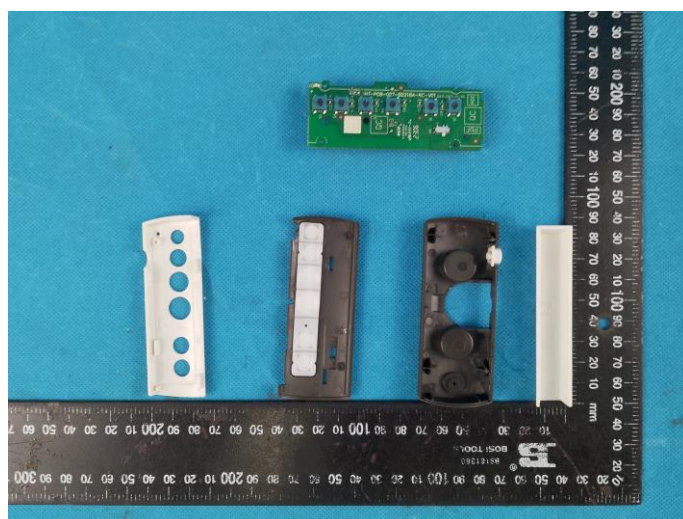

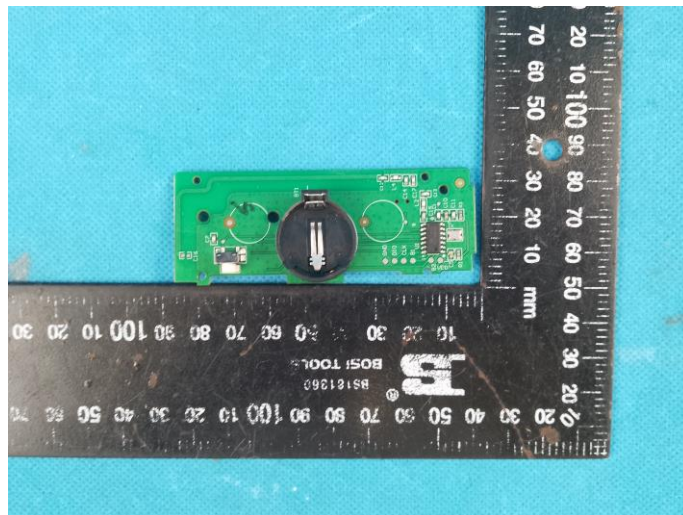
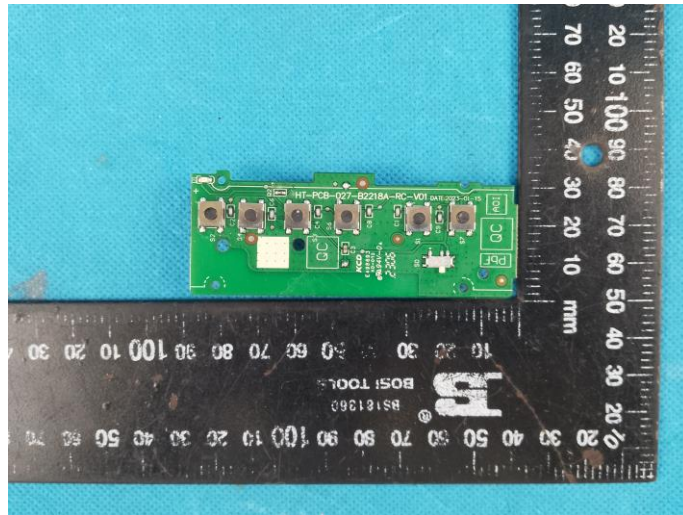

J0250-A1





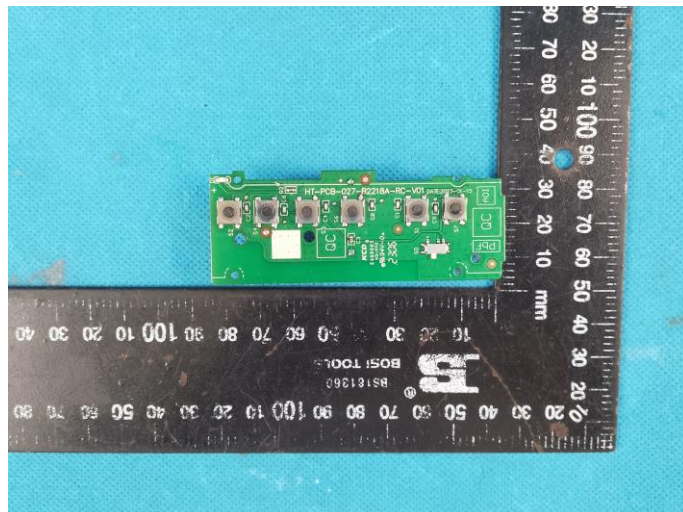
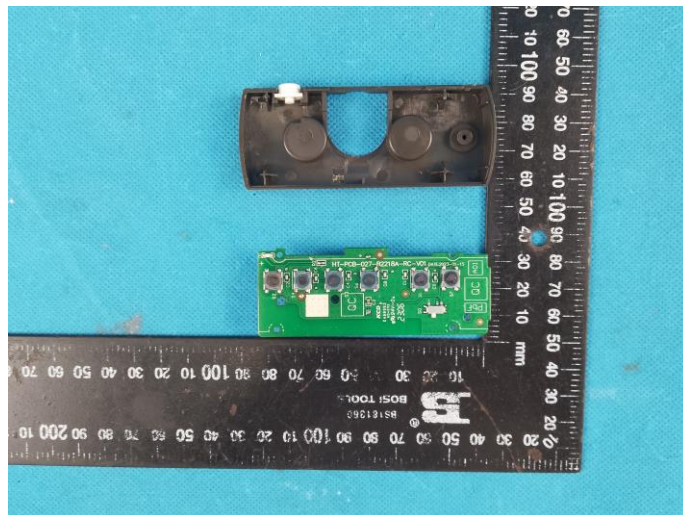
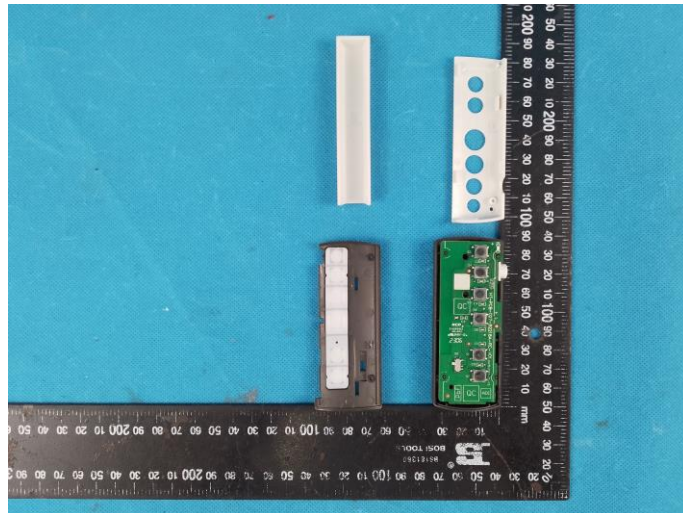

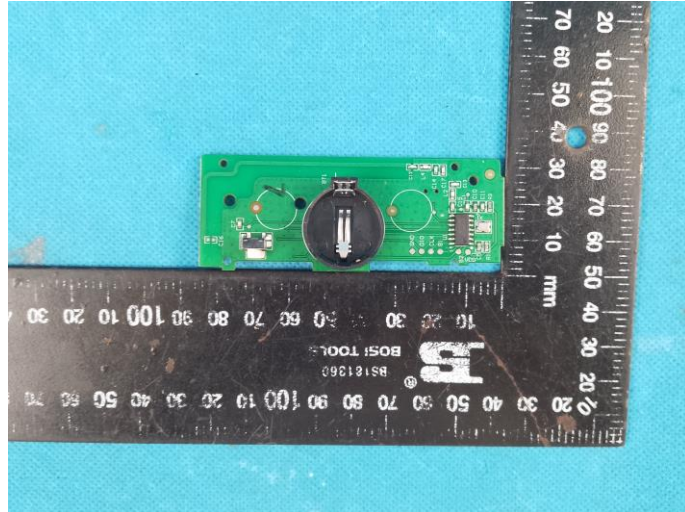

## 8. APPENDIX REPORT