



TEST REPORT

Report No. : **CHEW22020003** Report Verification: 

Project No..... : **SHT2201071603EW**

FCC ID..... : **IN2TX53**

Applicant's name..... : **Hunter Fan Company**

Address..... : 7130 Goodlett Farms Parkwy, Suite 400, Memphis TN 38016
United States Of America

Test item description : **Remote Control for Ceiling Fan**

Trade Mark : Hunter

Model/Type reference..... : K6731-05

Listed Model(s) : K6731-04,K6731-06,K6927-02,K6300-05,K6300-07

Standard : **FCC CFR Title 47 Part 15 Subpart C Section 15.231**

Date of receipt of test sample..... : Jan. 21, 2022

Date of testing..... : Jan. 22, 2022- Feb. 09, 2022

Date of issue..... : Feb. 10, 2022

Result..... : **PASS**

Compiled by
 (Position+Printed name+Signature): File administrator Silvia Li

Supervised by
 (Position+Printed name+Signature): Project Engineer Cheng Xiao

Approved by
 (Position+Printed name+Signature): RF Manager Hans Hu

Silvia Li

Cheng Xiao

Hans Hu

Testing Laboratory Name : **Shenzhen Huatongwei International Inspection Co., Ltd.**

Address..... : 1/F, Bldg 3, Hongfa Hi-tech Industrial Park, Genyu Road,
Tianliao, Gongming, Shenzhen, China

Shenzhen Huatongwei International Inspection Co., Ltd. All rights reserved.

This publication may be reproduced in whole or in part for non-commercial purposes as long as the Shenzhen Huatongwei International Inspection Co., Ltd. is acknowledged as copyright owner and source of the material. Shenzhen Huatongwei International Inspection Co., Ltd. takes no responsibility for and will not assume liability for damages resulting from the reader's interpretation of the reproduced material due to its placement and context. The test report merely correspond to the test sample.

Contents

1.	TEST STANDARDS AND REPORT VERSION	3
1.1.	Test Standards	3
1.2.	Report version	3
2.	TEST DESCRIPTION	4
3.	SUMMARY	5
3.1.	Client Information	5
3.2.	Product Description	5
3.3.	Radio Specification Description	5
3.4.	Testing Laboratory Information	5
4.	TEST CONFIGURATION	6
4.1.	Test frequency list	6
4.2.	Test mode	6
4.3.	Support unit used in test configuration and system	6
4.4.	Testing environmental condition	7
4.5.	Measurement uncertainty	7
4.6.	Equipment Used during the Test	8
5.	TEST CONDITIONS AND RESULTS	10
5.1.	Antenna Requirement	10
5.2.	AC Conducted Emission	11
5.3.	20dB bandwidth	12
5.4.	99% Occupied Bandwidth	13
5.5.	Transmission Time	14
5.6.	Duty Cycle Corrected Factor	15
5.7.	Radiated field strength of the fundamental signal	16
5.8.	Radiated Spurious Emission	18
6.	TEST SETUP PHOTOS	22
7.	EXTERANAL AND INTERNAL PHOTOS	23

1. TEST STANDARDS AND REPORT VERSION

1.1. Test Standards

The tests were performed according to following standards:

- [FCC Rules Part 15.231\(a\)](#): Periodic operation in the band 40.66–40.70 MHz and above 70 MHz.
- [ANSI C63.10:2013](#): American National Standard for Testing Unlicensed Wireless Devices

1.2. Report version

Revision No.	Date of issue	Description
N/A	2022-02-10	Original

2. TEST DESCRIPTION

Report clause	Test Items	Standard Requirement	Result
5.1	Antenna Requirement	15.203	PASS
5.2	AC Conducted Emission	15.207	N/A
5.3	20dB Bandwidth	15.231(c)	PASS
5.4	99% Occupied Bandwidth	-	PASS*1
5.5	Transmission time	15.231(a)(1)	PASS
5.6	Duty cycle corrected factor	-	PASS*1
5.7	Field strength of the Fundamental signal	15.231(b)	PASS
5.8	Radiated Spurious Emission	15.231(b)/15.205/15.209	PASS

Note:

- The measurement uncertainty is not included in the test result.
- *1: No requirement on standard, only report these test data.

3. SUMMARY

3.1. Client Information

Applicant:	Hunter Fan Company
Address:	7130 Goodlett Farms Parkwy, Suite 400, Memphis TN 38016 United States Of America
Manufacturer:	Shenzhen H&T Intelligent Control CO., Ltd.
Address:	H&T Industrial Park, No.18 BaoShan Road, Tian Liao Community, Guangming new district, Shenzhen, Guangdong, China 518132

3.2. Product Description

Name of EUT:	Remote Control for Ceiling Fan
Trade Mark:	Hunter
Model No.:	K6731-05
Listed Model(s):	K6731-04, K6731-06, K6927-02, K6300-05, K6300-07
Power supply:	DC 3V
Hardware version:	V02
Software version:	V01

3.3. Radio Specification Description

Operation frequency:	433.92MHz
Modulation:	OOK
Channel number:	1
Antenna type:	PCB Antenna

3.4. Testing Laboratory Information

Laboratory Name	Shenzhen Huatongwei International Inspection Co., Ltd.	
Laboratory Location	1/F, Bldg 3, Hongfa Hi-tech Industrial Park, Genyu Road, Tianliao, Gongming, Shenzhen, China	
Connect information:	Phone: 86-755-26715499 E-mail: cs@szhtw.com.cn http://www.szhtw.com.cn	
Qualifications	Type	Accreditation Number
	FCC	762235

4. TEST CONFIGURATION

4.1. Test frequency list

According to section ANSI C63.10 section 5.6.1,

Measurements of unlicensed wireless devices shall be performed and, if required, reported for each band in which the EUT can be operated with the device operating at the number of frequencies in each band specified in Table 4

Table 4—Number of frequencies to be tested

Frequency range in which device operates	Number of frequencies	Location in frequency range of operation
1 MHz or less	1	Middle
1 MHz to 10 MHz	2	1 near top and 1 near bottom
More than 10 MHz	3	1 near top, 1 near middle, and 1 near bottom

So test frequency as follow:

Channel	Frequency (MHz)
CH_M	433.92

4.2. Test mode

For RF test items
The engineering test program was provided and enabled to make EUT continuous transmit.
For Radiated spurious emissions test item:
The engineering test program was provided and enabled to make EUT continuous transmit. The EUT in each of three orthogonal axis emissions had been tested, but only the worst case (X axis) data Recorded in the report.

4.3. Support unit used in test configuration and system

The EUT has been associated with peripherals and configuration operated in a manner tended to maximize its emission characteristics in a typical application.

The following peripheral devices and interface cables were connected during the measurement:

Whether support unit is used?					
✓ No					
Item	Equipment	Trade Name	Model No.	FCC ID	Power cord
1					
2					

4.4. Testing environmental condition

Type	Requirement	Actual
Temperature:	15~35°C	25°C
Relative Humidity:	25~75%	50%
Air Pressure:	860~1060mbar	1000mbar

4.5. Measurement uncertainty

Test Item	Measurement Uncertainty
AC Conducted Emission (150kHz~30MHz)	3.00 dB
Radiated Emission (30MHz~1000MHz)	4.36 dB
Radiated Emissions (1GHz~25GHz)	5.10 dB
Peak Output Power	0.77dB
Power Spectral Density	0.77dB
Conducted Spurious Emission	0.77dB
6dB Bandwidth	70Hz for <1GHz 130Hz for >1GHz

This uncertainty represents an expanded uncertainty expressed at approximately the 95% confidence level using a coverage factor of $k=1.96$.

4.6. Equipment Used during the Test

● Conducted Emission							
Used	Test Equipment	Manufacturer	Equipment No.	Model No.	Serial No.	Last Cal. Date (YY-MM-DD)	Next Cal. Date (YY-MM-DD)
●	Shielded Room	Albatross projects	HTWE0114	N/A	N/A	2021/9/13	2022/9/12
●	EMI Test Receiver	R&S	HTWE0111	ESCI	101247	2021/9/13	2022/9/12
●	Artificial Mains	SCHWARZBECK	HTWE0113	NNLK 8121	573	2021/9/13	2022/9/12
●	Pulse Limiter	R&S	HTWE0033	ESH3-Z2	100499	2021/9/13	2022/9/12
●	RF Connection Cable	HUBER+SUHNER	HTWE0113-02	ENVIROFLE X_142	EF-NM-BNCM-2M	2021/9/13	2022/9/12
●	Test Software	R&S	N/A	ES-K1	N/A	N/A	N/A

● Radiated emission-6th test site							
Used	Test Equipment	Manufacturer	Equipment No.	Model No.	Serial No.	Last Cal. Date (YY-MM-DD)	Next Cal. Date (YY-MM-DD)
●	Semi-Anechoic Chamber	Albatross projects	HTWE0127	SAC-3m-02	C11121	2018/09/30	2022/09/29
●	EMI Test Receiver	R&S	HTWE0099	ESCI	100900	2021/9/14	2022/9/13
●	Loop Antenna	R&S	HTWE0170	HFH2-Z2	100020	2021/04/06	2022/04/05
●	Ultra-Broadband Antenna	SCHWARZBECK	HTWE0123	VULB9163	538	2021/04/06	2022/04/05
●	Pre-Amplifier	SCHWARZBECK	HTWE0295	BBV 9742	N/A	2021/11/5	2022/11/4
●	RF Connection Cable	HUBER+SUHNER	HTWE0062-01	N/A	N/A	2021/02/26	2022/02/25
●	RF Connection Cable	HUBER+SUHNER	HTWE0062-02	SUCOFLEX104	501184/4	2021/02/26	2022/02/25
●	Test Software	R&S	N/A	ES-K1	N/A	N/A	N/A

● Radiated emission-7th test site							
Used	Test Equipment	Manufacturer	Equipment No.	Model No.	Serial No.	Last Cal. Date (YY-MM-DD)	Next Cal. Date (YY-MM-DD)
●	Semi-Anechoic Chamber	Albatross projects	HTWE0122	SAC-3m-01	N/A	2018/09/27	2022/09/26
●	Spectrum Analyzer	R&S	HTWE0098	FSP40	100597	2021/9/13	2022/9/12
●	Horn Antenna	SCHWARZBECK	HTWE0126	9120D	1011	2020/04/01	2023/03/31
●	Broadband Horn Antenna	SCHWARZBECK	HTWE0103	BBHA9170	BBHA9170472	2020/4/27	2023/4/27
●	Pre-amplifier	CD	HTWE0071	PAP-0102	12004	2021/11/5	2022/11/4
●	Broadband Pre-amplifier	SCHWARZBECK	HTWE0201	BBV 9718	9718-248	2021/03/05	2022/03/04
●	RF Connection Cable	HUBER+SUHNER	HTWE0120-01	6m 18GHz S Serisa	N/A	2021/02/26	2022/02/25
●	RF Connection Cable	HUBER+SUHNER	HTWE0120-02	6m 3GHz RG Serisa	N/A	2021/02/26	2022/02/25
●	RF Connection Cable	HUBER+SUHNER	HTWE0120-03	6m 3GHz RG Serisa	N/A	2021/02/26	2022/02/25
●	RF Connection Cable	HUBER+SUHNER	HTWE0120-04	6m 3GHz RG Serisa	N/A	2021/02/26	2022/02/25
●	RF Connection Cable	HUBER+SUHNER	HTWE0121-01	6m 18GHz S Serisa	N/A	2021/02/26	2022/02/25
●	Test Software	Audix	N/A	E3	N/A	N/A	N/A

● RF Conducted Method						
Used	Test Equipment	Manufacturer	Model No.	Serial No.	Last Cal. Date (YY-MM-DD)	Next Cal. Date (YY-MM-DD)
●	Signal and spectrum Analyzer	R&S	FSV40	100048	2021/9/13	2022/9/12
●	Spectrum Analyzer	Agilent	N9020A	MY50510187	2021/9/13	2022/9/12
●	Power Meter	Anritsu	ML249A	N/A	2021/9/13	2022/9/12
○	Radio communication tester	R&S	CMW500	137688-Lv	2021/9/13	2022/9/12

5. TEST CONDITIONS AND RESULTS

5.1. Antenna Requirement

Requirement

FCC CFR Title 47 Part 15 Subpart C Section 15.203:

An intentional radiator shall be designed to ensure that no antenna other than that furnished by the responsible party shall be used with the device. The use of a permanently attached antenna or of an antenna that uses a unique coupling to the intentional radiator, the manufacturer may design the unit so that a broken antenna can be replaced by the user, but the use of a standard antenna jack or electrical connector is prohibited.

TEST RESULT

Passed **Not Applicable**

The antenna type is a PCB antenna, the directional gain of the antenna less than 6 dBi, please refer to the below antenna photo.

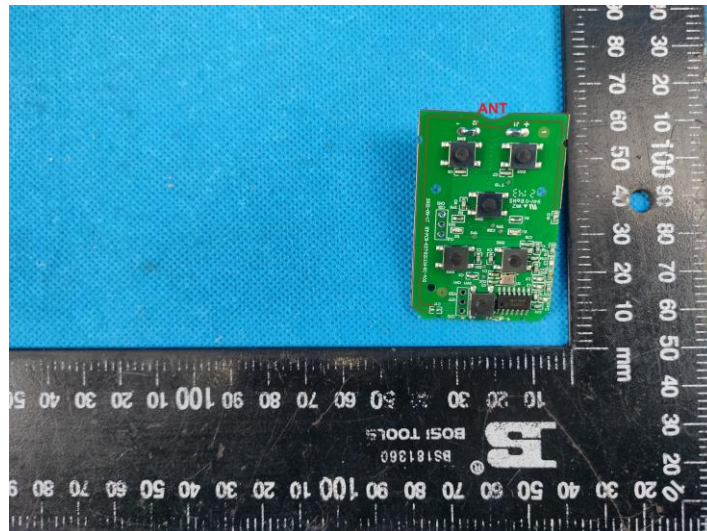

5.2. AC Conducted Emission

LIMIT

FCC CFR Title 47 Part 15 Subpart C Section 15.207

Frequency range (MHz)	Limit (dBuV)	
	Quasi-peak	Average
0.15-0.5	66 to 56*	56 to 46*
0.5-5	56	46
5-30	60	50

* Decreases with the logarithm of the frequency.

TEST CONFIGURATION

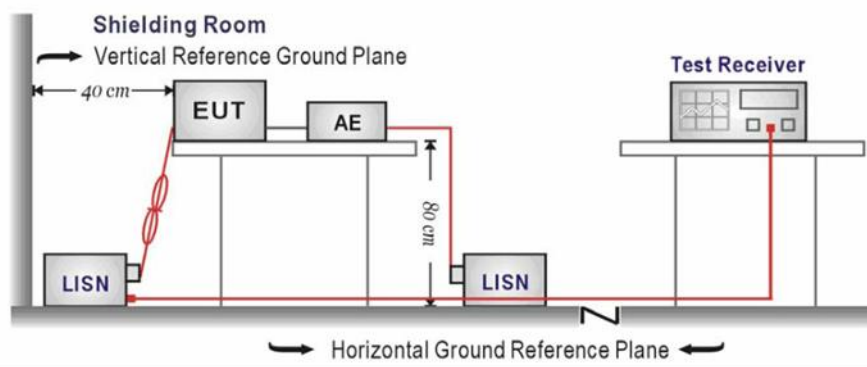

TEST PROCEDURE

1. The EUT was setup according to ANSI C63.10 requirements.
2. The EUT was placed on a platform of nominal size, 1 m by 1.5 m, raised 80 cm above the conducting ground plane. The vertical conducting plane was located 40 cm to the rear of the EUT. All other surfaces of EUT were at least 80 cm from any other grounded conducting surface.
3. The EUT and simulators are connected to the main power through a line impedances stabilization network (LISN). The LISN provides a 50 ohm /50uH coupling impedance for the measuring equipment.
4. The peripheral devices are also connected to the main power through a LISN. (Please refer to the block diagram of the test setup and photographs)
5. Each current-carrying conductor of the EUT power cord, except the ground (safety) conductor, was individually connected through a LISN to the input power source.
6. The excess length of the power cord between the EUT and the LISN receptacle were folded back and forth at the center of the lead to form a bundle not exceeding 40 cm in length.
7. Conducted emissions were investigated over the frequency range from 0.15MHz to 30MHz using a receiver bandwidth of 9 kHz.
8. During the above scans, the emissions were maximized by cable manipulation.

TEST MODE:

Please refer to the clause 4.2

TEST RESULT

Passed Not Applicable

5.3. 20dB bandwidth

LIMIT

The bandwidth of the emission shall be no wider than 0.25% of the center frequency for devices operating above 70MHz and below 900 MHz.

For devices operating above 900 MHz, the emission shall be no wider than 0.5% of the center frequency.

TEST CONFIGURATION

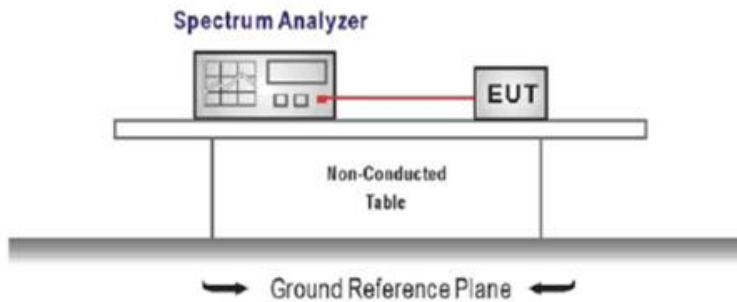

TEST PROCEDURE

1. Connect the antenna port(s) to the spectrum analyzer input.
2. Configure the spectrum analyzer as shown below (enter all losses between the transmitter output and the spectrum analyzer).
Center Frequency = channel center frequency
Span= approximately 2 to 3 times the 20 dB bandwidth
RBW = 100 kHz, VBW $\geq 3 \times$ RBW
Sweep time= auto couple
Detector = Peak
Trace mode = max hold
3. Place the radio in continuous transmit mode, allow the trace to stabilize, view the transmitter waveform on the spectrum analyzer.
4. Measure the maximum width of the emission that is constrained by the frequencies associated with the two outermost amplitude points (upper and lower frequencies) that are attenuated by 20 dB relative to the maximum level measured in the fundamental emission, and record the pertinent measurements.

TEST MODE:

Please refer to the clause 4.2

TEST RESULT

Passed Not Applicable

TEST Data

Please refer to appendix A on the appendix report

5.4. 99% Occupied Bandwidth

LIMIT

N/A

TEST CONFIGURATION

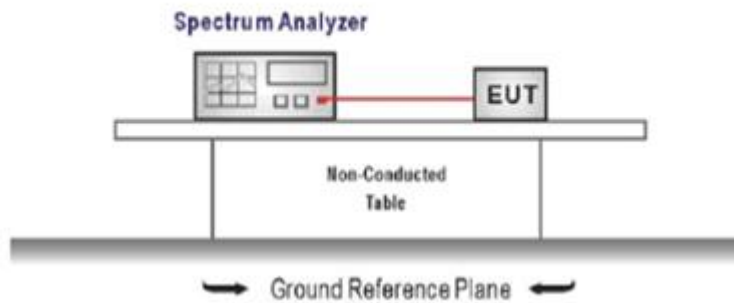

TEST PROCEDURE

1. Connect the antenna port(s) to the spectrum analyzer input.
2. Configure the spectrum analyzer as shown below (enter all losses between the transmitter output and the spectrum analyzer).
Center Frequency = channel center frequency
Span $\geq 1.5 \times$ OBW
RBW = 1%~5%OBW
VBW $\geq 3 \times$ RBW
Sweep time = auto couple
Detector = Peak
Trace mode = max hold
3. Place the radio in continuous transmit mode, allow the trace to stabilize, view the transmitter waveform on the spectrum analyzer.

TEST MODE:

Please refer to the clause 4.2

TEST RESULT

Passed Not Applicable

TEST Data

Please refer to appendix B on the appendix report

5.5. Transmission Time

LIMIT

A manually operated transmitter shall employ a switch that will auto-matically deactivate the transmitter within not more than 5 seconds of being released.

TEST CONFIGURATION

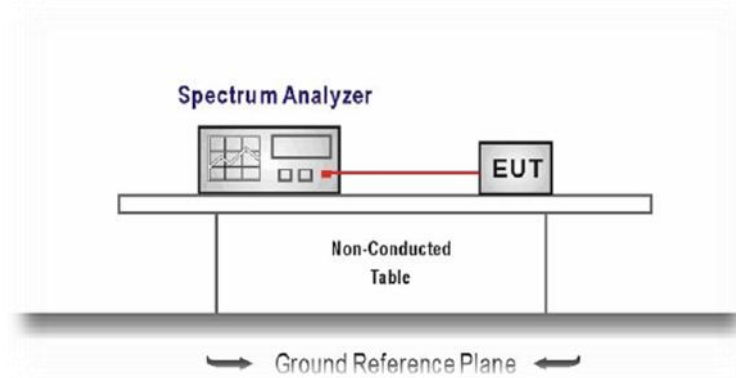

TEST PROCEDURE

1. The transmitter output was connected to the spectrum analyzer through an attenuator, the path loss was compensated to the results for each measurement.
2. Set to the maximum power setting and enable the EUT transmit continuously
3. Use the following spectrum analyzer settings:
Frequency=Center carrier frequency
RBW=100kHz, VBW=300kHz, Span= zero,
Sweep time= 10second, Detector function = peak, Trace = single
4. Measure and record the results in the test report.

TEST MODE:

Please refer to the clause 4.2

TEST RESULTS

Passed Not Applicable

TEST Data

Please refer to appendix C on the appendix report

5.6. Duty Cycle Corrected Factor

LIMIT

N/A

TEST CONFIGURATION

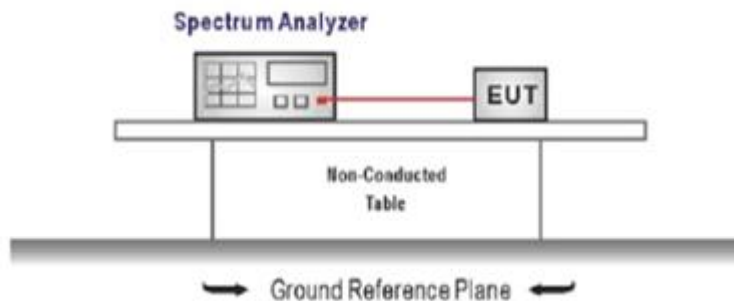

TEST PROCEDURE

1. The transmitter output was connected to the spectrum analyzer through an attenuator, the path loss was compensated to the results for each measurement.
2. Set to the maximum power setting and enable the EUT transmit continuously
3. Use the following spectrum analyzer settings:
Span=zero span, Frequency=centered channel, RBW= 1MHz, VBW \geq RBW
Sweep time=as necessary to capture the entire dwell time,
Detector function = peak, Trigger mode
4. Measure and record the duty cycle data

TEST MODE:

Please refer to the clause 4.2

TEST Data

Please refer to appendix D on the appendix report

5.7. Radiated field strength of the fundamental signal

LIMIT

Fundamental frequency (MHz)	Field strength of fundamental (microvolts/meter)	Field strength of spurious emissions (microvolts/meter)
40.66-40.70	2,250	225
70-130	1,250	125
130-174	¹ 1,250 to 3,750	¹ 125 to 375
174-260	3,750	375
260-470	¹ 3,750 to 12,500	¹ 375 to 1,250
Above 470	12,500	1,250

¹Linear interpolations.

TEST CONFIGURATION

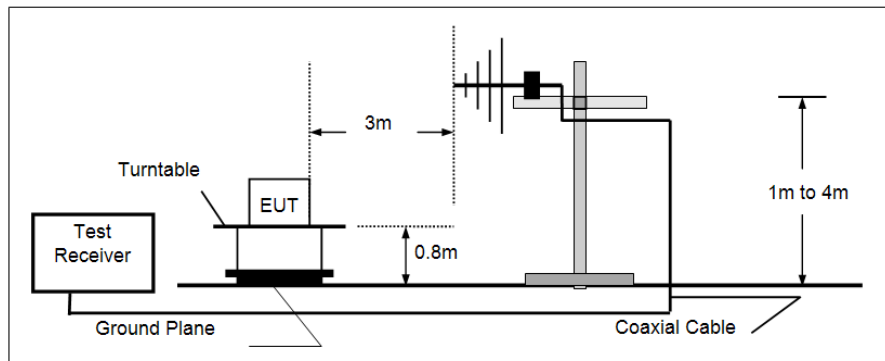

TEST PROCEDURE

1. The EUT was setup and tested according to ANSI C63.10.
2. The EUT is placed on a turn table which is 0.8 meter above ground for below 1GHz, The turn table is rotated 360 degrees to determine the position of the maximum emission level.
3. The EUT was set 3 meters from the receiving antenna, which was mounted on the top of a variable height antenna tower.
4. For each suspected emission, the EUT was arranged to its worst case and then tune the Antenna tower (from 1 m to 4 m) and turntable (from 0 degree to 360 degrees) to find the maximum reading. A pre-amp and a high pass filter are used for the test in order to get better signal level to comply with the guidelines.
5. Set to the maximum power setting and enable the EUT transmit continuously.
6. Use the following spectrum analyzer settings
 - a) Span shall wide enough to fully capture the emission being measured;
 - b) RBW=120 kHz, VBW=300 kHz, Sweep=auto, Detector function=peak, Trace=max hold;

If the emission level of the EUT measured by the peak detector is 3 dB lower than the applicable limit, the peak emission level will be reported. Otherwise, the emission measurement will be repeated using the quasi-peak detector and reported.

TEST MODE:

Please refer to the clause 4.2

TEST RESULTS

Passed Not Applicable

Note:

- 1) Level= Reading + Factor; Factor =Antenna Factor+ Cable Loss- Preamp Factor
- 2) Over Limit = Level - Limit

Test channel		CH _M						
No.	Freq. [MHz]	Reading [dB μ V/m]	Factor [dB]	Level [dB μ V/m]	Limit [dB μ V/m]	Margin [dB]	Polarity	Detector
1	443.92	58.38	24.67	83.25	100.80	17.55	Vertical	PK
2	443.92	51.07	24.68	75.75	100.80	25.05	Horizontal	PK

No.	Freq. [MHz]	PK level [dB μ V/m]	DCCF [dB]	Level [dB μ V/m]	Limit [dB μ V/m]	Margin [dB]	Polarity	Detector
1	433.92	83.25	-8.81	74.44	80.80	6.36	Vertical	AV
2	433.92	75.75	-8.81	66.94	80.80	13.86	Horizontal	AV

5.8. Radiated Spurious Emission

LIMIT

FCC CFR Title 47 Part 15 Subpart C Section 15.231(b)

Fundamental frequency (MHz)	Field strength of fundamental (microvolts/meter)	Field strength of spurious emissions (microvolts/meter)
40.66-40.70	2,250	225
70-130	1,250	125
130-174	¹ 1,250 to 3,750	¹ 125 to 375
174-260	3,750	375
260-470	¹ 3,750 to 12,500	¹ 375 to 1,250
Above 470	12,500	1,250

FCC CFR Title 47 Part 15 Subpart C Section 15.209

Frequency	Limit (dBuV/m)	Value
0.009 MHz ~0.49 MHz	2400/F(kHz) @300m	Quasi-peak
0.49 MHz ~ 1.705 MHz	24000/F(kHz) @30m	Quasi-peak
1.705 MHz ~30 MHz	30 @30m	Quasi-peak

Note: Limit dBuV/m @3m = Limit dBuV/m @300m + 40*log(300/3)= Limit dBuV/m @300m +80,

Limit dBuV/m @3m = Limit dBuV/m @30m +40*log(30/3)= Limit dBuV/m @30m + 40.

Frequency	Limit (dBuV/m @3m)	Value
30MHz~88MHz	40.00	Quasi-peak
88MHz~216MHz	43.50	Quasi-peak
216MHz~960MHz	46.00	Quasi-peak
960MHz~1GHz	54.00	Quasi-peak
Above 1GHz	54.00	Average
	74.00	Peak

TEST CONFIGURATION

- 9 kHz ~ 30 MHz

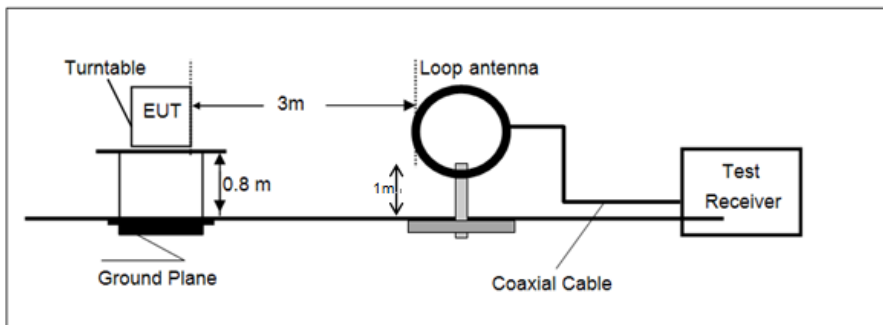

- 30 MHz ~ 1 GHz

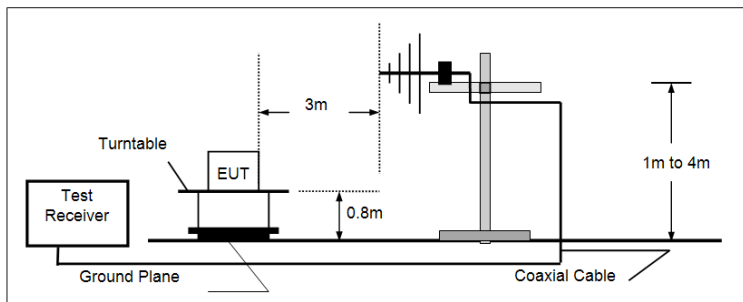

- Above 1 GHz

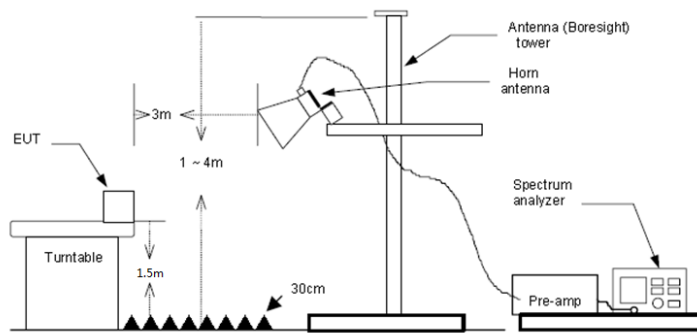

TEST PROCEDURE

1. The EUT was setup and tested according to ANSI C63.10.
 2. The EUT is placed on a turn table which is 0.8 meter above ground for below 1 GHz, and 1.5 m for above 1 GHz. The turn table is rotated 360 degrees to determine the position of the maximum emission level.
 3. The EUT was set 3 meters from the receiving antenna, which was mounted on the top of a variable height antenna tower.
 4. For each suspected emission, the EUT was arranged to its worst case and then tune the Antenna tower (from 1 m to 4 m) and turntable (from 0 degree to 360 degrees) to find the maximum reading. A pre-amp and a high pass filter are used for the test in order to get better signal level to comply with the guidelines.
 5. Set to the maximum power setting and enable the EUT transmit continuously.
 6. Use the following spectrum analyzer settings
 - a) Span shall wide enough to fully capture the emission being measured;
 - b) Below 1 GHz:
 - RBW=120 kHz, VBW=300 kHz, Sweep=auto, Detector function=peak, Trace=max hold;
 - If the emission level of the EUT measured by the peak detector is 3 dB lower than the applicable limit, the peak emission level will be reported. Otherwise, the emission measurement will be repeated using the quasi-peak detector and reported.
 - c) Set RBW=1MHz, VBW=3MHz for >1GHz, Sweep time=auto, Detector=peak, Trace=max hold for Peak measurement
- For average measurement:
Average level = Peak level – DCCF

TEST MODE:

Please refer to the clause 4.2

TEST RESULT

Passed **Not Applicable**

Note:

- 1) Level= Reading + Factor/Transd; Factor/Transd =Antenna Factor+ Cable Loss- Preamp Factor
- 2) Margin = Limit – Level
- 3) Over Limit = Level – Limit

TEST DATA FOR 9 kHz ~ 30 MHz

The EUT was pre-scanned this frequency band, found the radiated level 20dB lower than the limit, so don't show data on this report.

TEST DATA FOR 30 MHz ~ 1000 MHz

Polarization: Horizontal

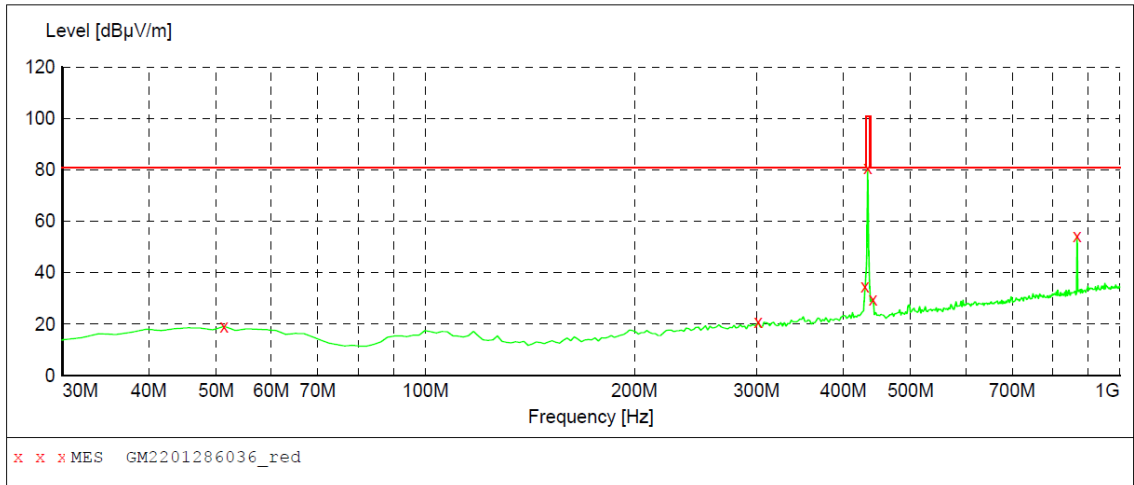

MEASUREMENT RESULT: "GM2201286036_red"

1/28/2022 3:05PM

Frequency MHz	Level dBµV/m	Transd dB	Limit dBµV/m	Margin dB	Det.	Height cm	Azimuth deg	Polarization
51.340000	19.20	-9.1	80.8	61.6	PEAK	300.0	332.00	HORIZONTAL
301.600000	20.90	-7.3	80.8	59.9	PEAK	300.0	21.00	HORIZONTAL
429.640000	34.60	-3.5	80.8	46.2	PEAK	100.0	214.00	HORIZONTAL
433.520000	80.60	-3.4	100.8	20.2	PEAK	300.0	226.00	HORIZONTAL
441.280000	29.70	-3.3	80.8	51.1	PEAK	100.0	242.00	HORIZONTAL
868.080000	54.30	6.1	80.8	26.5	PEAK	100.0	214.00	HORIZONTAL

Polarization: Vertical

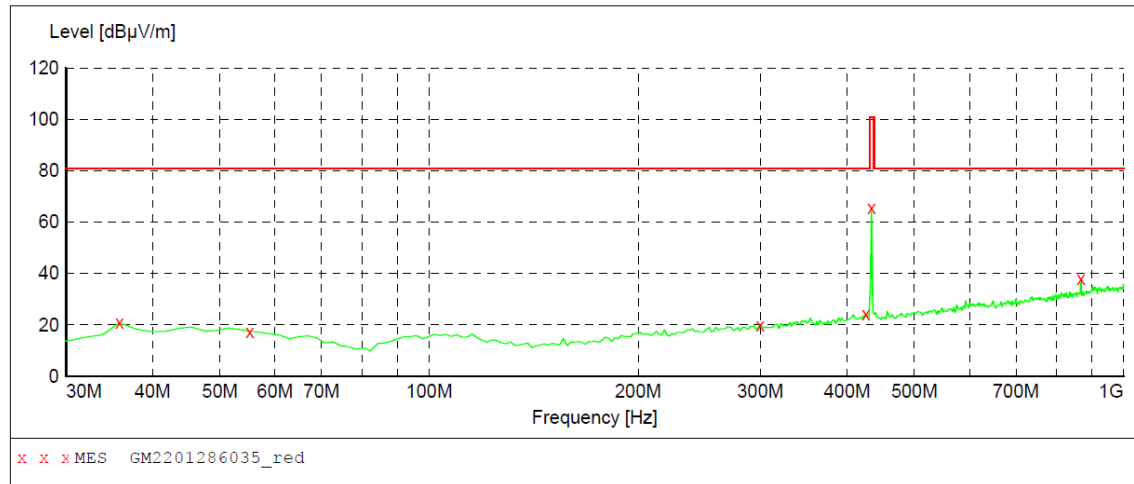

MEASUREMENT RESULT: "GM2201286035_red"

1/28/2022 3:01PM

Frequency MHz	Level dBµV/m	Transd dB	Limit dBµV/m	Margin dB	Det.	Height cm	Azimuth deg	Polarization
35.820000	20.80	-11.3	80.8	60.0	PEAK	100.0	277.00	VERTICAL
55.220000	17.50	-9.2	80.8	63.3	PEAK	100.0	37.00	VERTICAL
299.660000	19.70	-7.3	80.8	61.1	PEAK	100.0	132.00	VERTICAL
425.760000	24.10	-3.5	80.8	56.7	PEAK	100.0	63.00	VERTICAL
433.520000	65.40	-3.4	100.8	35.4	PEAK	100.0	231.00	VERTICAL
868.080000	38.00	6.1	80.8	42.8	PEAK	100.0	348.00	VERTICAL

TEST DATA FOR 1 GHz ~ 5 GHz

Polarization: **Horizontal**

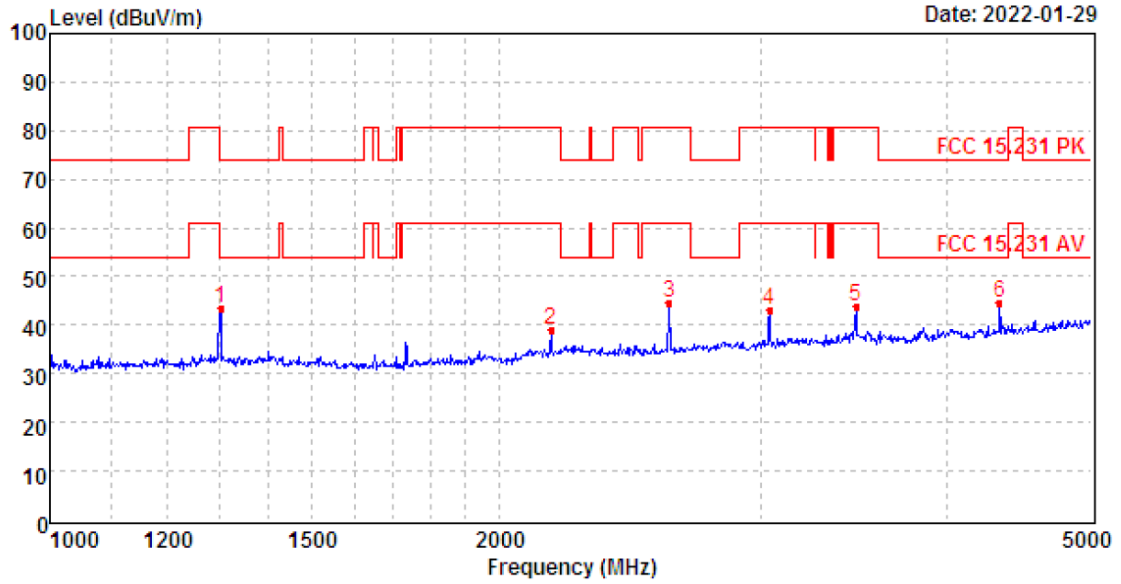

Mark	Frequency MHz	Reading dBuV/m	Antenna dB	Cable dB	Preamp dB	Level dBuV/m	Limit dBuV/m	Over limit	Remark
1	1302.06	49.85	26.01	4.03	36.30	43.59	74.00	-30.41	Peak
2	2168.73	43.34	27.89	5.26	37.39	39.10	80.80	-41.70	Peak
3	2605.48	48.49	27.52	5.84	37.07	44.78	80.80	-36.02	Peak
4	3040.80	45.56	28.78	6.24	37.51	43.07	80.80	-37.73	Peak
5	3475.38	44.78	29.00	6.77	36.58	43.97	80.80	-36.83	Peak
6	4339.71	42.63	30.46	7.89	36.21	44.77	74.00	-29.23	Peak

Polarization: **Vertical**

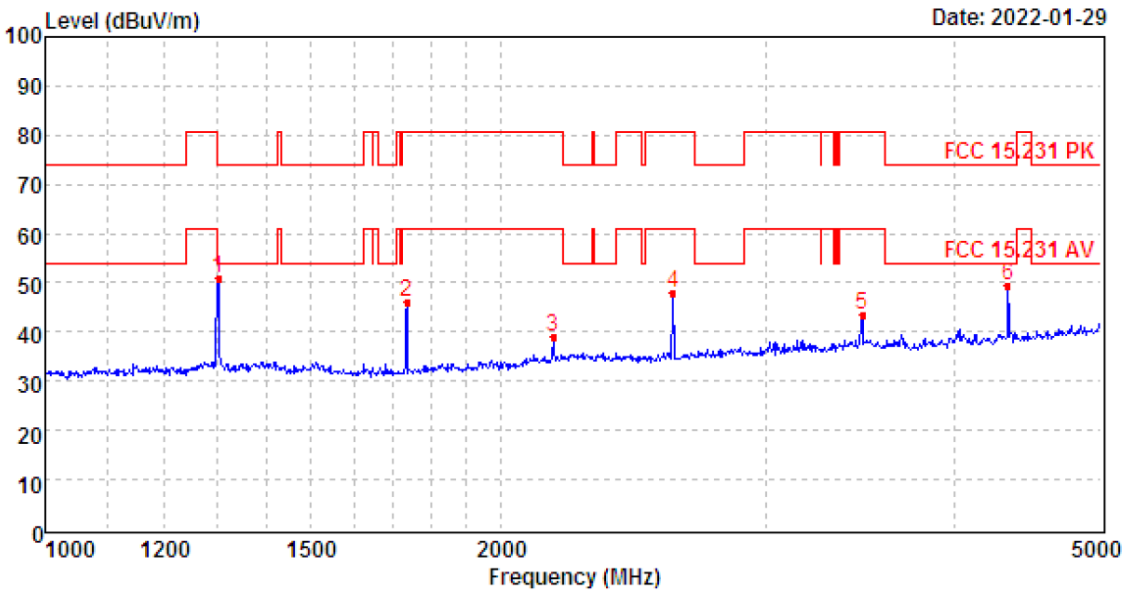

Mark	Frequency MHz	Reading dBuV/m	Antenna dB	Cable dB	Preamp dB	Level dBuV/m	Limit dBuV/m	Over limit	Remark
1	1302.06	57.01	26.01	4.03	36.30	50.75	74.00	-23.25	Peak
2	1736.79	53.55	25.17	4.66	37.16	46.22	80.80	-34.58	Peak
3	2168.73	43.16	27.89	5.26	37.39	38.92	80.80	-41.88	Peak
4	2605.48	51.64	27.52	5.84	37.07	47.93	80.80	-32.87	Peak
5	3475.38	44.37	29.00	6.77	36.58	43.56	80.80	-37.24	Peak
6	4339.71	47.16	30.46	7.89	36.21	49.30	74.00	-24.70	Peak

6. TEST SETUP PHOTOS

Radiated Emission

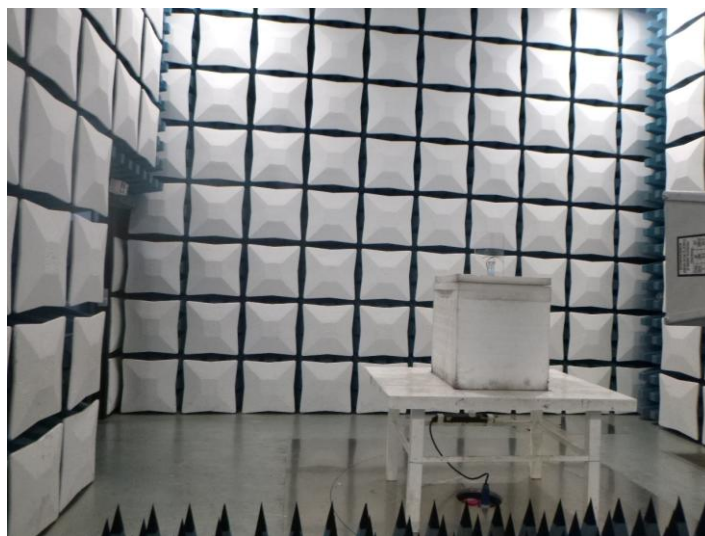

7. EXTERANAL AND INTERNAL PHOTOS

EXTERANAL PHOTOS

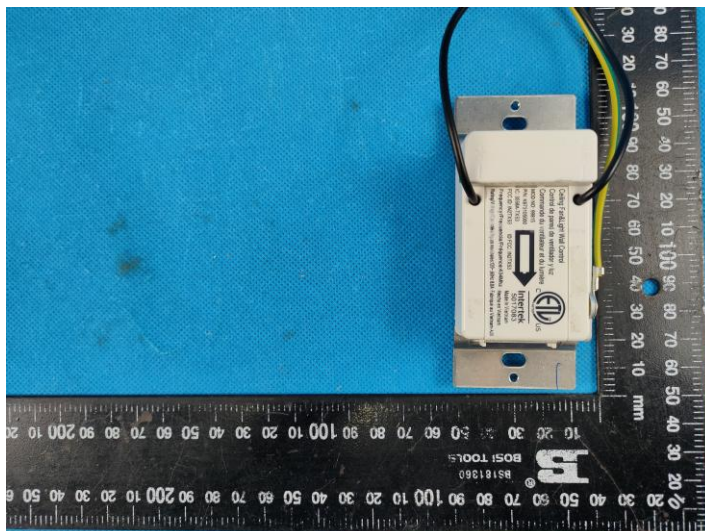
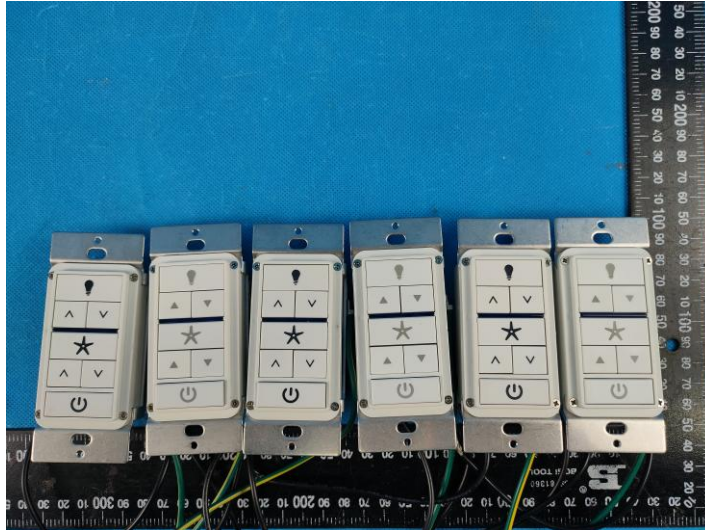

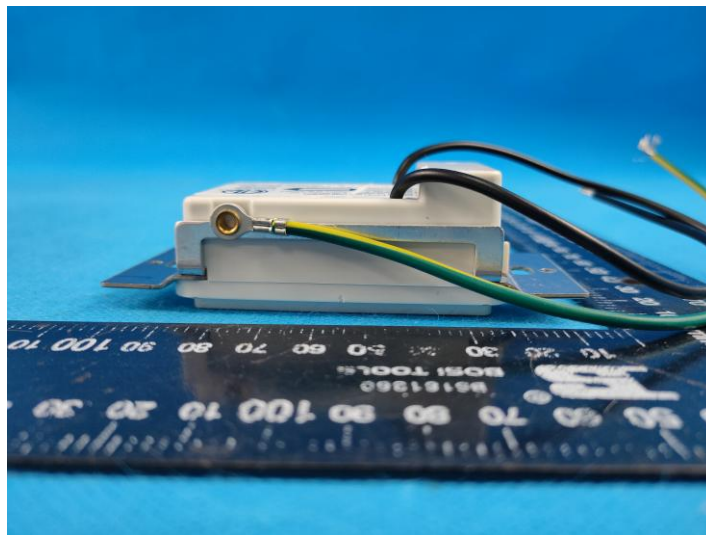
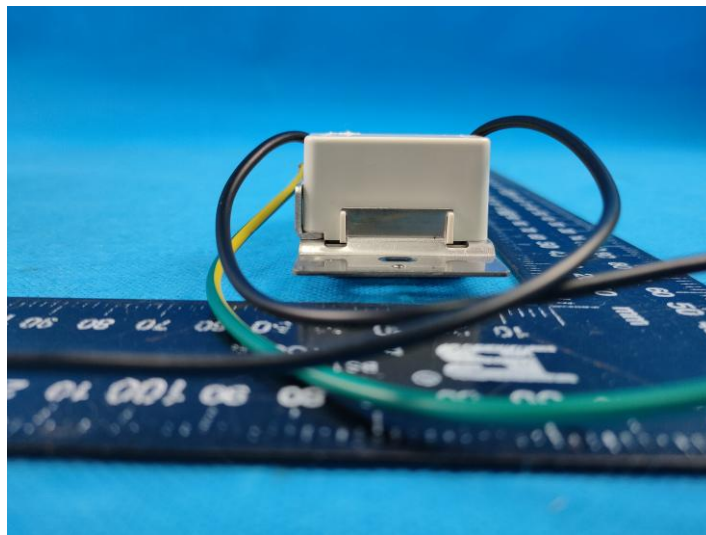
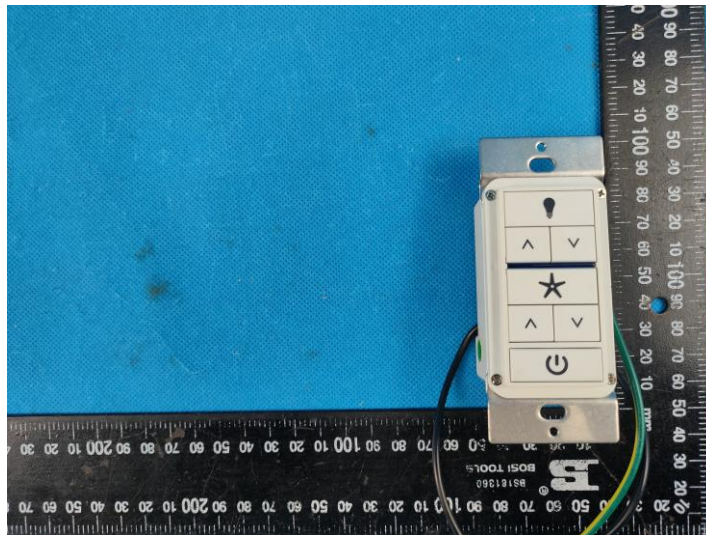

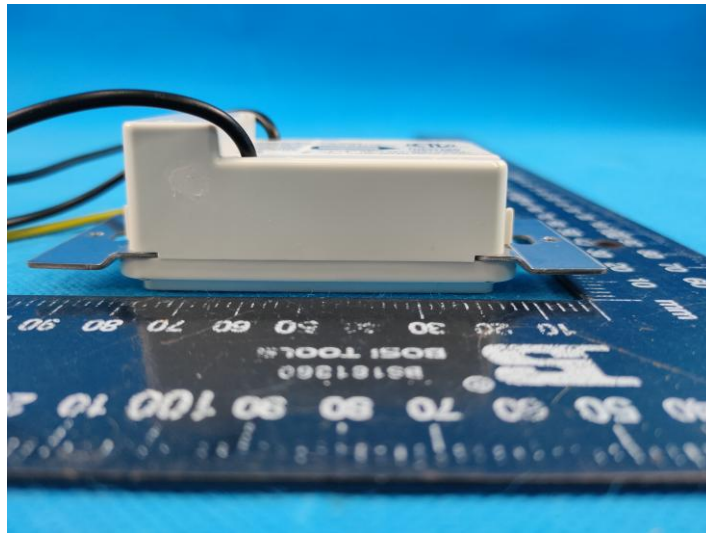
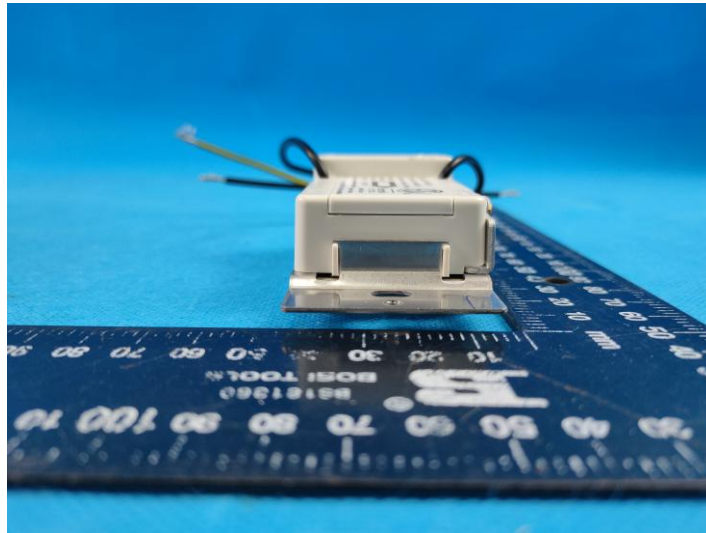

INTERNAL PHOTOS

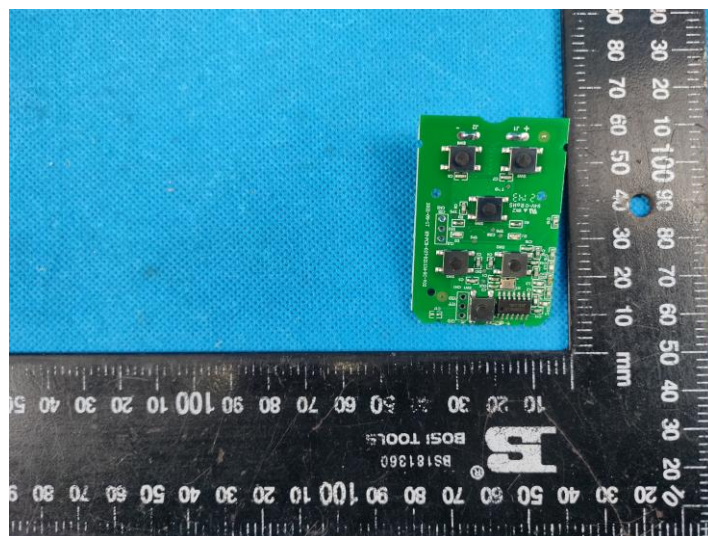
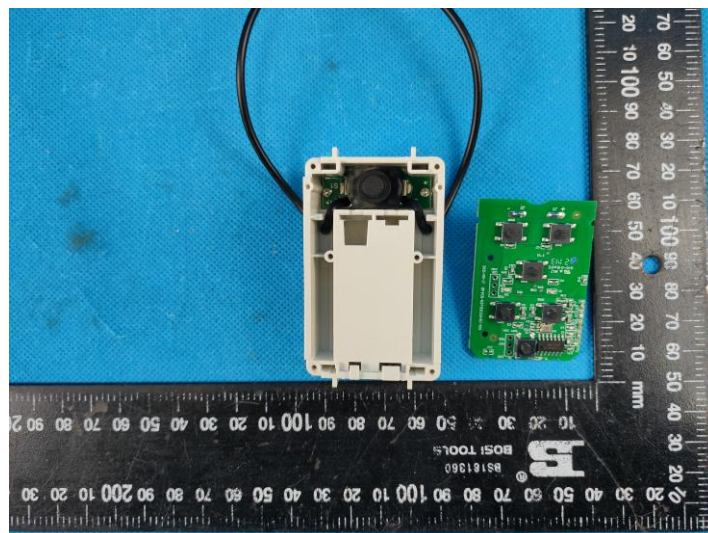
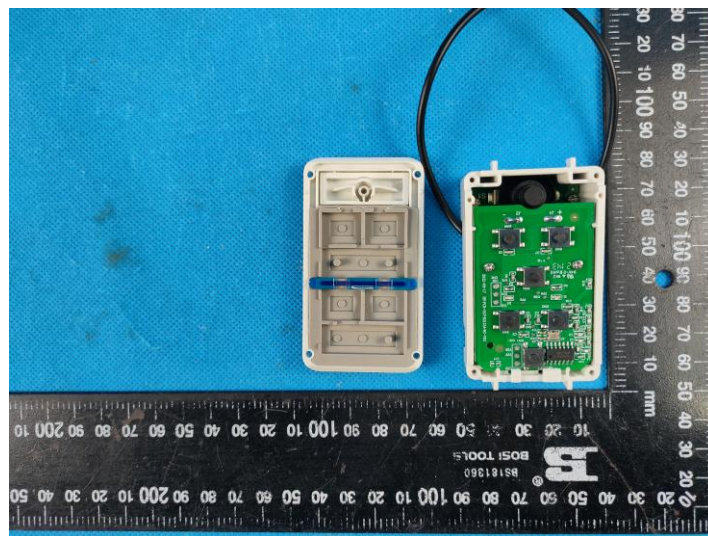

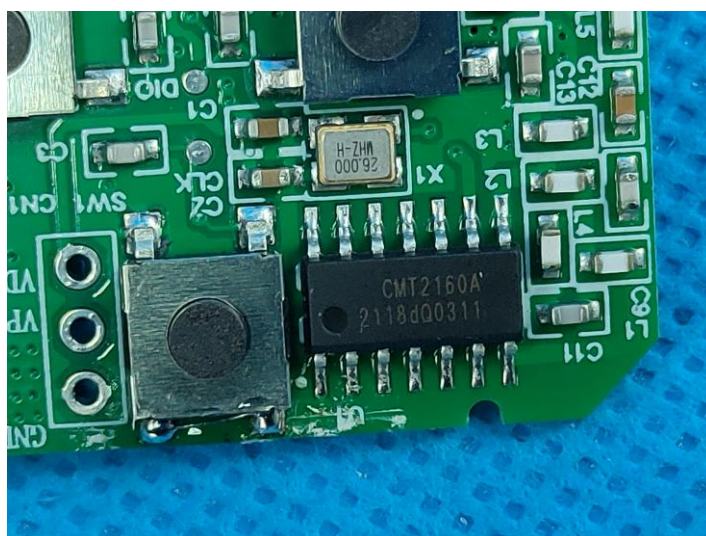
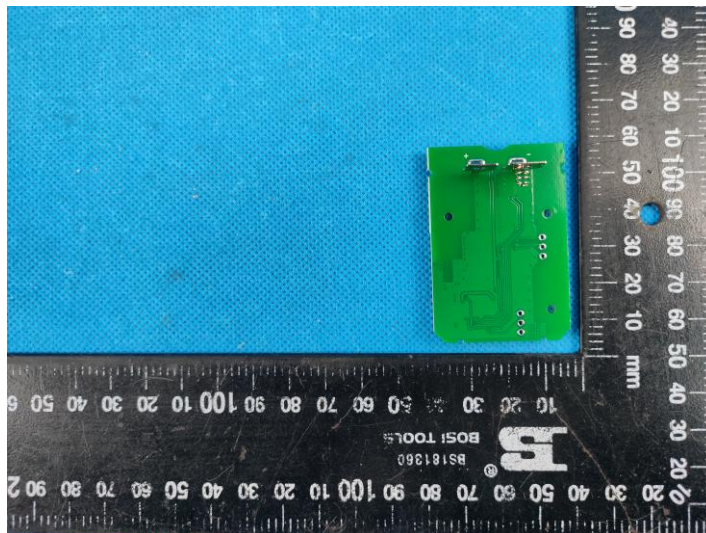
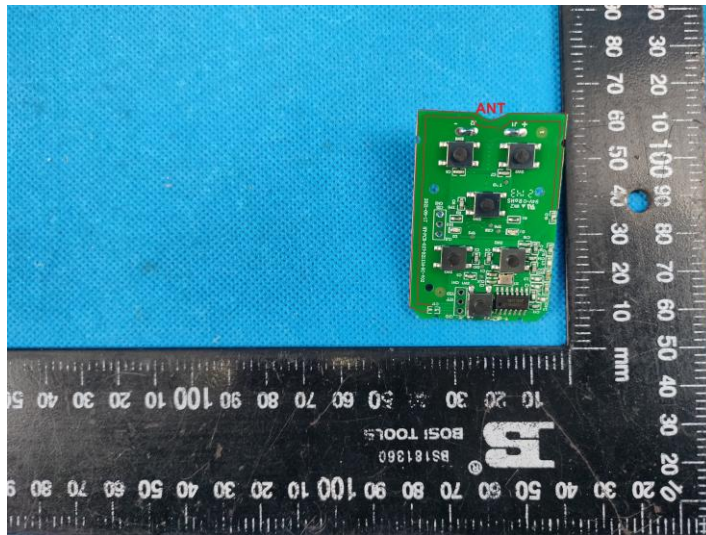

-----End of Report-----

APPENDIX REPORT

Project No.	SHT2201071603EW		
Test sample No.	YPHT22010716001	Model No.	K6731-05
Start test date	2022-01-27	Finish date	2022-01-27
Temperature	23.8℃	Humidity	37%
Test Engineer	Hailey Chen	Auditor	Xiaodong Zheo

Appendix clause	Test item	Result
A	20dB Bandwidth	PASS
B	99% Occupied Bandwidth	PASS
C	Deactivation Time	PASS
D	Duty Cycle Corrected Factor	PASS

Appendix A: 20dB bandwidth

Test Channel	20dB Bandwidth (kHz)	Limit (kHz)	Result
CH _M	8.1	1084.8	Pass

NOTE:Limit=0.25%*Center Frequency=1084.8 kHz

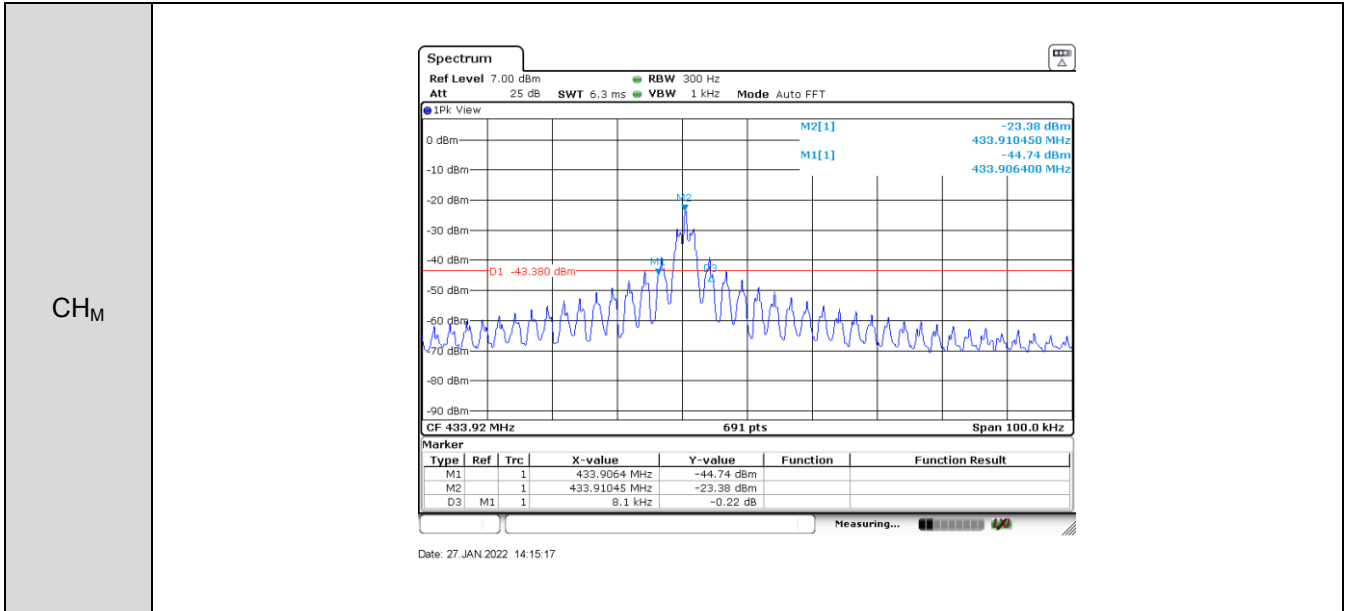

Appendix B: 99% Occupied Bandwidth

Test Channel	99% Occupied Bandwidth (kHz)	Limit (kHz)	Result
CH _M	35.31	-	Pass

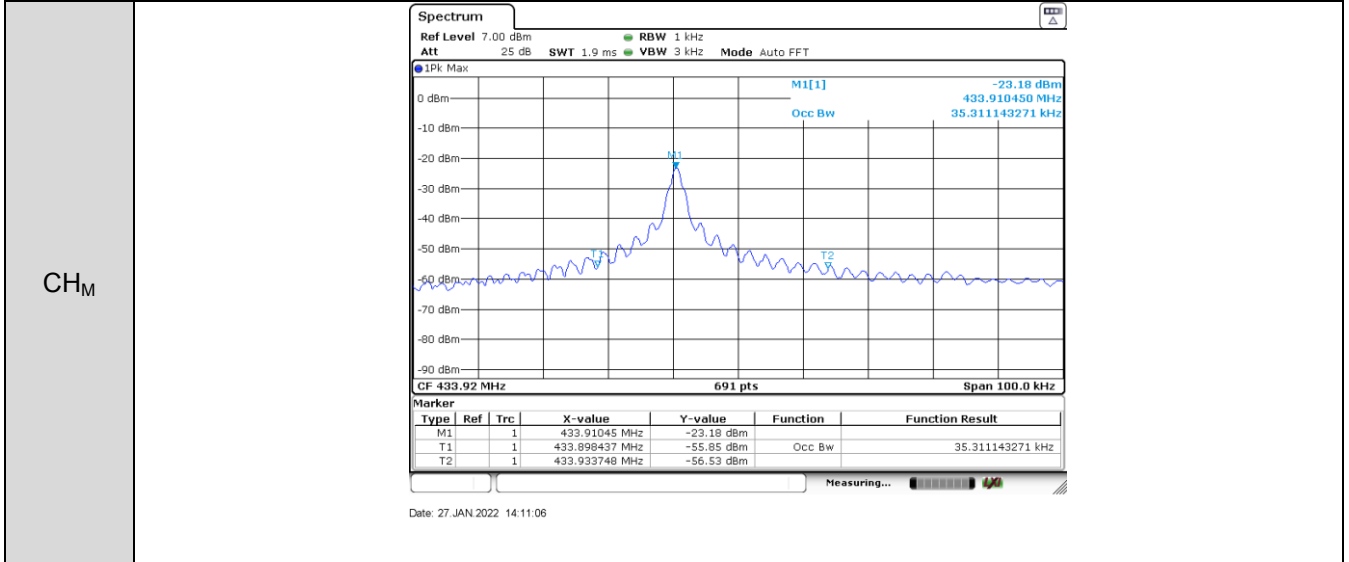

Appendix C: Deactivation Time

Transmission time (second)	Limit (second)	Result
0.34058	5	Pass

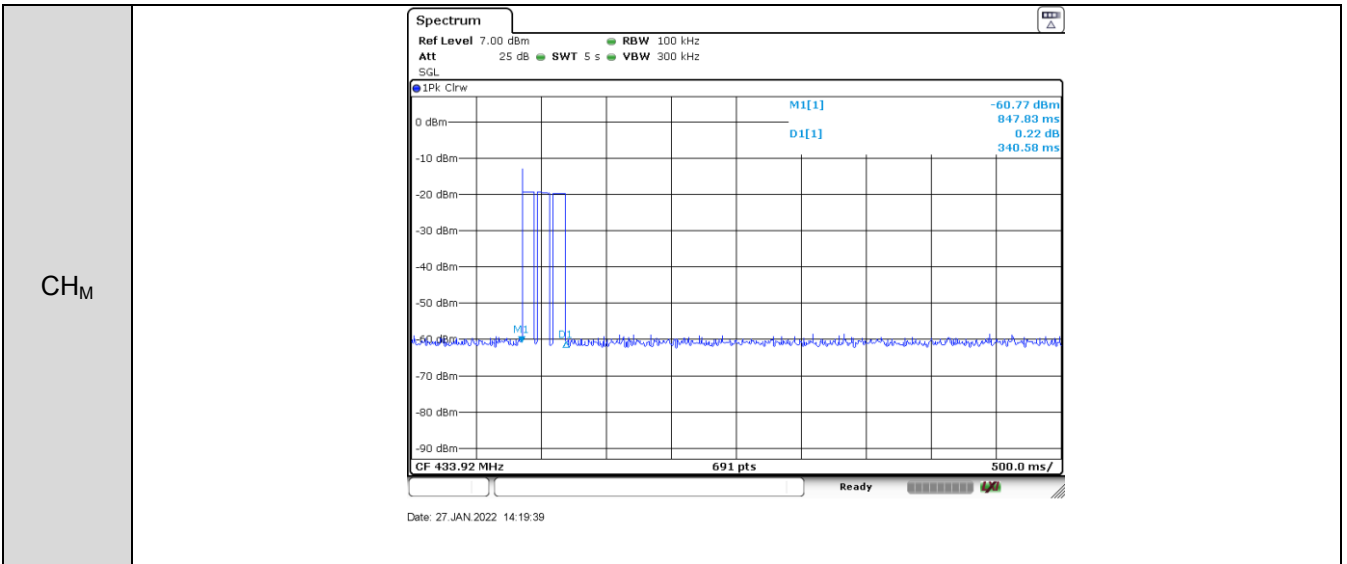

Appendix D: Duty Cycle Corrected Factor

T _{ON1} (ms) :	0.290
T _{ON1} number	20
T _{ON2} (ms) :	0.435
T _{ON2} number	46
T _{ON3} (ms) :	0.870
T _{ON3} number	12
Period (ms) :	100
Duty Cycle :	$= (0.290 \times 20 + 0.435 \times 46 + 0.870 \times 12) / 100 = 0.3625$
Duty Cycle Corrected Factor:	$= 20 \times \log(0.3625) = -8.8138$

Note:

- 1) Duty cycle = $T_{on1} \times T_{ON1} \text{ number} + T_{on2} \times T_{ON2} \text{ number} + T_{on3} \times T_{ON3} \text{ number} / T_{period}$
- 2) Duty Cycle Corrected Factor/DCCF = $20 \times \log(\text{Duty Cycle})$

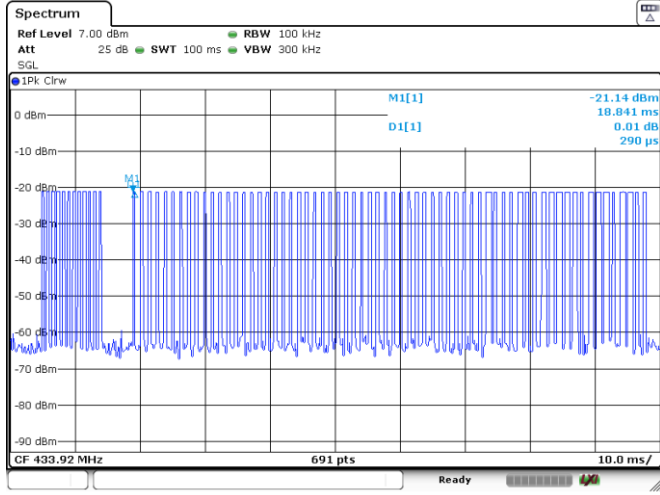
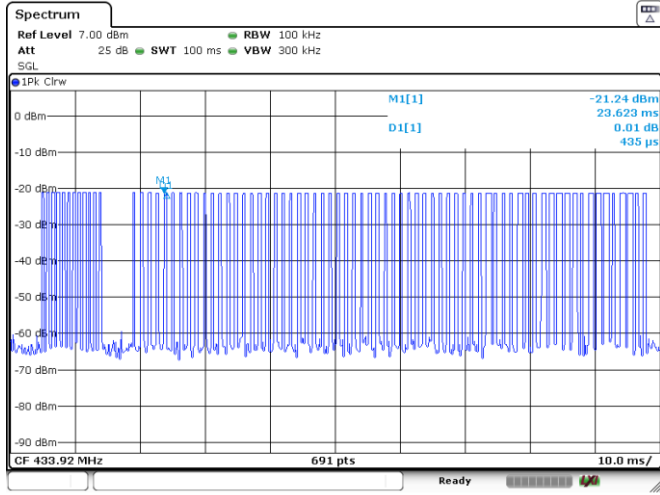
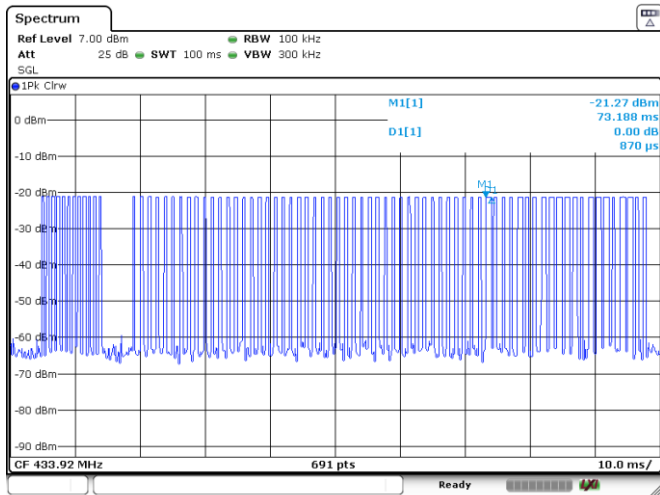
<p>T_{ON1} (ms) :</p>	 <p>Spectrum Ref Level 7.00 dBm Att 25 dB RBW 100 kHz SWT 100 ms VBW 300 kHz SGL 1Pk Clrw M1[1] -21.14 dBm D1[1] 18.841 ms 0.01 dB 290 μs CF 433.92 MHz 691 pts 10.0 ms/ Ready Date: 27 JAN 2022 14:21:00</p>
<p>T_{ON2} (ms) :</p>	 <p>Spectrum Ref Level 7.00 dBm Att 25 dB RBW 100 kHz SWT 100 ms VBW 300 kHz SGL 1Pk Clrw M1[1] -21.24 dBm D1[1] 23.623 ms 0.01 dB 435 μs CF 433.92 MHz 691 pts 10.0 ms/ Ready Date: 27 JAN 2022 14:21:26</p>
<p>T_{ON3} (ms) :</p>	 <p>Spectrum Ref Level 7.00 dBm Att 25 dB RBW 100 kHz SWT 100 ms VBW 300 kHz SGL 1Pk Clrw M1[1] -21.27 dBm D1[1] 73.188 ms 0.00 dB 870 μs CF 433.92 MHz 691 pts 10.0 ms/ Ready Date: 27 JAN 2022 14:22:00</p>

Period (ms) :

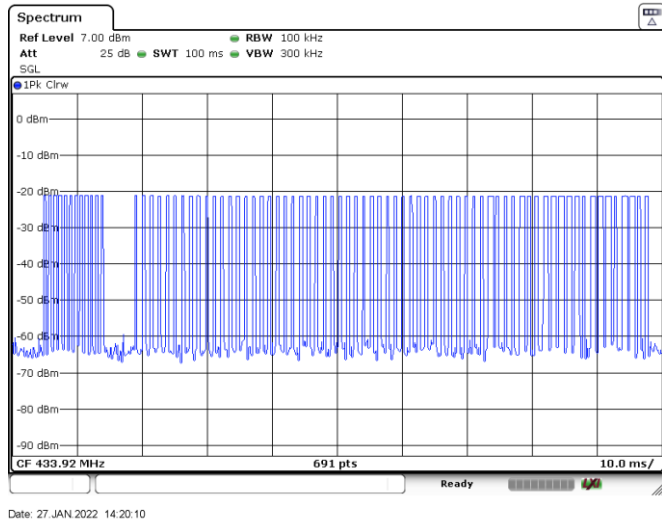

-----End of Report-----