

Testing and certification of,
consultancy and research concerning,
electronic and electric appliances,
systems, installations and
telecommunication systems

**TEST REPORT OF A 2.4 GHz. LOW POWER RLAN PCMCIA CARD,
BRAND APPLE, TYPE 630-37XX (BUILT-IN IN P19 BASESTATION),
IN CONFORMITY WITH FCC PART 15, ED. MAY 24, 2001.**

**TNO Physics and Electronics Laboratory
P.O. Box 15
9822 ZG Niekerk (NL)
Smidshornerweg 18
9822 TL Niekerk (NL)**

Telephone: +31 594 505005
Telefax: +31 594 504804

E-mail: eps@certi.tno.nl



FCC ID: IMRAPP2411R
 Description of EUT: 2.4 GHz. low power RLAN PCMCIA Card
 Manufacturer: Apple Computer, Inc.
 Brand mark: Apple
 Built-in in type: P19 Basestation

MEASUREMENT/TECHNICAL REPORT

Apple Computers, Inc.

2.4 GHz. low power RLAN PCMCIA Card

FCC ID EUT: IMRAPP2411R

December 19, 2001

This report concerns (check one):		Original grant	<input type="checkbox"/> Class 1 change
Equipment type: Direct Sequence Spread Spectrum Transceiver			
Deferred grant requested per 47 CFR 0.457(d)(1)(ii)?		Yes	<input type="checkbox"/> No
If yes defer until:		<u>January 15, 2001</u>	
Apple Computer, Inc. USA, 1 Infinite Loop, Cupertino CA 95014 , USA.			
Report prepared by:	Name	: D. H. Kruijer, B.Sc. E.E. and B.Sc. T.M.	
	Company name	: TNO Certification EPS	
	Address	: Smidshornerweg 18	
	Postal code/city	: 9822 ZG Niekerk	
	Mailing address	: P.O. Box 15	
	City/Place/Postal code	: 9822 ZG Niekerk	
	Address	: Smidshornerweg 18	
	Country	: The Netherlands	
	Telephone number	: + 31 594 50 50 05	
	Telefax number	: + 31 594 50 48 04	
	E-mail	: eps@certi.tno.nl	

The data taken for this test and report herein was done in accordance with FCC Part 15 and measurement procedures of ANSI C63.4-1992. TNO Certification EPS at Niekerk, The Netherlands, certifies that the data is accurate and contains a true representation of the emission-profile of the Equipment Under Test (EUT) on the date of the test noted in the test report. I have reviewed the test report and find it to be an accurate description of the test(s) performed and the EUT so tested.

Date: December 19, 2001

Signature:
P. de Beer

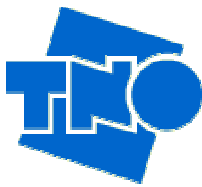
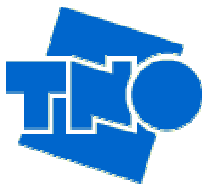

Table of Contents		Page
1	General information.....	4
1.1	Product description.....	4
1.2	Related submittal(s)/grant(s).....	4
1.3	Tested system details.....	4
1.4	Test methodology.....	5
1.5	Test facility.....	5
2	Product labelling.....	6
2.1	FCC ID Label.....	6
2.2	Location of the FCC ID Label on the EUT.....	6
3	System test configuration.....	7
3.1	Justification.....	7
3.2	EUT exercise software.....	7
3.3	Special accessories.....	8
3.4	Equipment modifications.....	8
3.5	Configuration of the tested system.....	8
4	Block diagram(s) of the tested model.....	8
5	Conducted and radiated measurement photos.....	9
5.1	Conducted emission configuration.....	9
5.2	Radiated emission configuration.....	10
6	Radiated emission data.....	11
6.1	Radiated emission data in accordance with FCC 15.109 and FCC 15.209, receive mode.....	11
6.2	Radiated emission data in restricted bands in accordance with FCC 15.107 and FCC 15.207, transmit mode.....	14
7	Conducted emission data at the AC power line terminals in accordance with FCC 15.107 and FCC 15.207.....	20
8	Testresults of measurements in accordance with FCC 15.247.....	23
8.1	Minimum 6 dB bandwidth.....	23
8.2	Maximum peak output power of the intentional radiator.....	23
8.3	Radiated emission data outside restricted bands in a 100 kHz bandwidth.....	24
8.4	Conducted emission data outside restricted bands in a 100 kHz bandwidth.....	25
8.5	Peak power spectral density conducted from the intentional radiator in any 3 kHz band.....	25
8.6	Processing gain of a direct sequence system.....	26
9	Plots of measurement data.....	27
9.1	Emission in restricted bands nearest to the band 2400 - 2483.5 MHz.....	28
9.1.1	Average values in restricted band 2310 - 2390 MHz.....	28
9.1.2	Peak values in restricted band 2310 - 2390 MHz.....	29
9.1.3	Average values in restricted band 2483.5 - 2500 MHz.....	30
9.1.4	Peak values in restricted band 2483.5 - 2500 MHz.....	31
9.2	Minimum 6 dB bandwidth.....	32
9.3	Conducted emission.....	34
9.4	Peak power spectral density conducted from the intentional radiator in any 3 kHz band.....	36
10	List of used measuring equipment.....	38



1 General information.

1.1 Product description.

The 2.4 GHz low power RLAN MiniPCI card, brand Apple, type 630-37XX, is designed to operate in the 2.4 GHz ISM frequency band, Channels 1 to 11 (2412 MHz to 2462 MHz), as specified by the Federal Communications Commission in the USA.

The 2.4 GHz low power RLAN MiniPCI card, brand Apple, type 630-37XX, utilises Direct Sequence Spread Spectrum (DSSS) technology.

The 2.4 GHz low power RLAN MiniPCI card, brand Apple, type 630-37XX, is intended for use in notebooks and personal computers, which incorporate an integrated antenna. Only antennas which have been certified by the Federal Communications Commission for use with this specific 2.4 GHz low power RLAN MiniPCI card may be connected to the antenna of this device.

1.2 Related submittal(s)/grant(s).

Not applicable.

1.3 Tested system details.

The FCC ID's for all equipment, plus descriptions of all cables used in the tested system (included inserted cards, which have grants) are:

Model	Serial/model number	FCC ID	Description	Cable Descriptions
Apple PCMCIA card	-01UT41300015	-IMRAPPC2411R	-Wireless LAN	-
P19 Basestation	-UV33181ZZD	-n.a. DoC	-Airport Basestation	-Unshielded power cord to AC Mains -USB cable to laptop
P25 Powerbook	-PT313511	-n.a. (DoC)	-For input to Basestation	-USB cable to Basestation -Power cord to AC-netadapter

Table 1.1: tested system details.

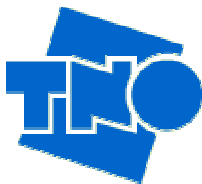

FCC ID: IMRAPP2411R
Description of EUT: 2.4 GHz. low power RLAN PCMCIA Card
Manufacturer: Apple Computer, Inc.
Brand mark: Apple
Built-in in type: P19 Basestation

1.4 Test methodology.

The test methodology used has been based on the requirements of FCC Part 15, issue May 24, 2001, relevant clauses 15.107, 15.109, 15.205, 15.207, 15.209 and 15.247. The used measuring methods are based on the ANSI C63.4 - 1992 document.

Radiated tests above 30 MHz were performed at a distance of 3 meter. Below 30 MHz the measurement was carried out at a distance of 10 meter. The eventual found results will be calculated to values for the required measuring distance of 30/300 meter.

Fieldstrength measurements on frequencies above 1 GHz were measured with appropriate pre-amplifiers, antennas and a spectrum analyser. At found frequencies the actual level at the input of the pre-amplifier was generated with aid of a signal generator. The output level of the signal generator was increased with the antenna-factor to obtain the fieldstrength.

1.5 Test facility

The FCC has per Public Notice declared that the measurement facilities located at the TNO Certification EPS. Located in Niekerk, Smidshornerweg 18, The Netherlands, has been reviewed and found to be in compliance with the requirements of section 2.948 of the FCC rules per October 23, 2000.

The description of the measuring facilities have been filed at the FCC's Offices The facility has been added to the list of those who perform these measurement services for the public on a fee basis. An up-to-date list of such public test facilities is available on the Internet on the FCC Website at <http://www.fcc.gov>, E-Filing and OET Equipment Authorisation Electronic Filing.

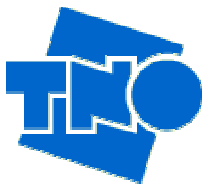

FCC ID: IMRAPPC2411R
Description of EUT: 2.4 GHz. low power RLAN PCMCIA Card
Manufacturer: Apple Computer, Inc.
Brand mark: Apple
Built-in in type: P19 Basestation

2 Product labelling.

2.1 FCC ID Label.

The following label shall be attached to the device under test.

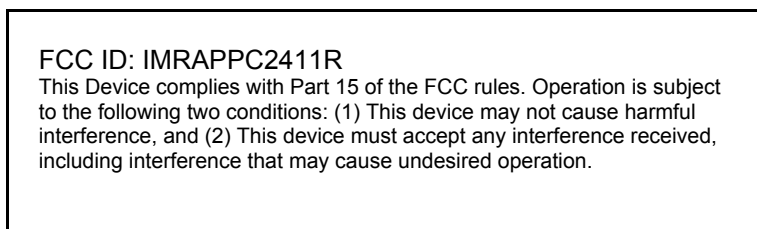

Figure 2.1: FCC ID.

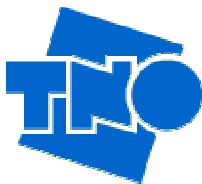

Figure 2.2: FCC ID, label.

2.2 Location of the FCC ID Label on the EUT.

The FCC ID Label will be placed on the frontside of the 2.4 GHz RLAN PCMCIA Card.

See attached documentation-sheet for more detailed information.



3 System test configuration.

3.1 Justification.

The system was configured for testing in a typical fashion (as a customer would normally use it).

The justification of cables and equipment has been carried out as prescribed in the ANSI C63.4-1992 document.

The measurements were performed at the lowest operating frequency (channel 1: 2412 MHz), the operating frequency in the middle of the specified frequency band (channel 6: 2437 MHz) and the highest operating frequency (channel 11: 2462 MHz).

Channel	operating frequencies (MHz)	Rated output power (dBm)	test performed
1	2412	20	Yes
2	2417	20	No
3	2422	20	No
4	2427	20	No
5	2432	20	No
6	2437	20	Yes
7	2442	20	No
8	2447	20	No
9	2452	20	No
10	2457	20	No
11	2462	20	Yes

Table 3.1: operating frequencies and rated output power levels.

To complete the configuration required by the FCC, the transmitter was tested in the P21 Tower with the antenna connected to the antenna port.

The transmitter antenna connector is unique and is non-interchangeable.

3.2 EUT exercise software.

The EUT was enabled to transmit or receive continuously.



3.3 Special accessories.

No special accessories are used to achieve FCC compliance.

3.4 Equipment modifications.

No modifications have been made to the equipment to achieve compliance.

Applicant Signature : n.a.
Typed/Printed Name : n.a.

Date : n.a.
Position : n.a.

3.5 Configuration of the tested system.

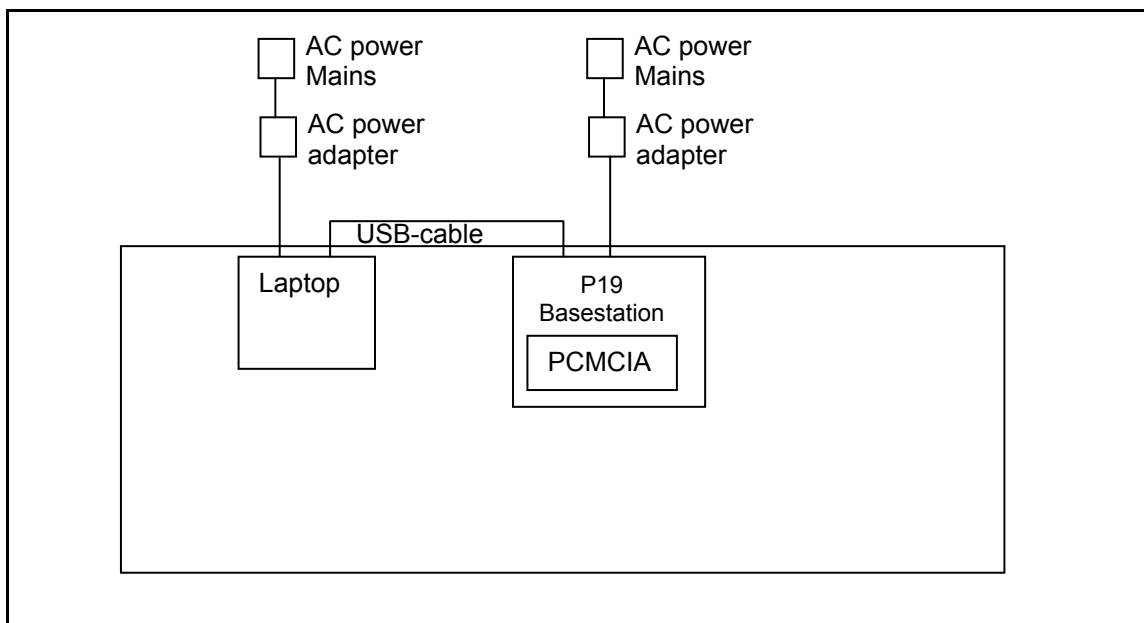

Figure 3.1: configuration of the tested system.

4 Block diagram(s) of the tested model.

Information is annexed in the technical documentation supplied by the applicant.



FCC ID: IMRAPP2411R
Description of EUT: 2.4 GHz. low power RLAN PCMCIA Card
Manufacturer: Apple Computer, Inc.
Brand mark: Apple
Built-in in type: P19 Basestation

5 Conducted and radiated measurement photos.

5.1 Conducted emission configuration.



Figure 5.1: front picture of testconfiguration.



Figure 5.2: back picture of testconfiguration.



FCC ID: IMRAPP2411R
Description of EUT: 2.4 GHz. low power WLAN PCMCIA Card
Manufacturer: Apple Computer, Inc.
Brand mark: Apple
Built-in in type: P19 Basestation

5.2 Radiated emission configuration.



Figure 5.3: front picture of test configuration, for testing above 1 GHz.

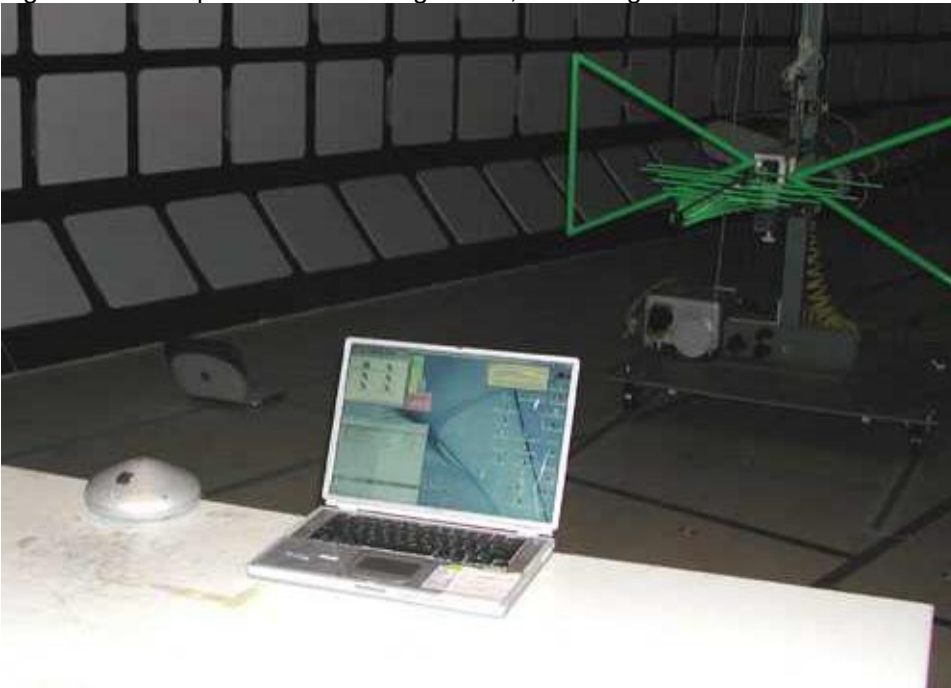

Figure 5.4: front picture of test configuration, for testing below 1 GHz.



6 Radiated emission data

6.1 Radiated emission data in accordance with FCC 15.109 and FCC 15.209, receive mode.

Reception on channel 1, 2412 MHz.

Frequency (MHz)	Results for horizontal and vertical polarisation of measurement antenna (dB μ V/m)		Detector type: QP=Quasi peak AV=Average PK=Peak	Resolution Bandwidth of field strength meter (kHz)	Limits (dB μ V/m)
	Vertical	Horizontal			
487.32	32.4	36.2	QP	120	46.0
499.60	31.0	33.4	QP	120	46.0
624.41	38.4	38.8	QP	120	46.0
675.57	33.4	34.0	QP	120	46.0
712.39	31.3	<30.0	QP	120	46.0
751.27	34.7	38.6	QP	120	46.0
788.10	33.4	38.8	QP	120	46.0
863.81	34.3	37.9	QP	120	46.0
876.08	35.9	42.6	QP	120	46.0
900.64	33.7	40.0	QP	120	46.0
937.46	<30.0	40.3	QP	120	46.0
951.79	<30.0	33.6	QP	120	46.0
1000.89	<30.0	42.7	QP	120	46.0
other freq.	<30.0	<30.0	PK	1000	74.0

Table 6.1: radiated emission data on channel 1.

Note: Above 1 GHz, the peak values are below the limits for measurement with the average detector. Therefore, not all spurious emissions are measured with the average detector.

Test personnel:

Tester signature:

Date: December 19, 2001

Name

: D.H. Kruijer



Reception on channel 6: 2437 MHz.

Frequency (MHz)	Results for horizontal and vertical polarisation of measurement antenna (dB μ V/m)		Detector type: QP=Quasi peak AV=Average PK=Peak	Resolution Bandwidth of field strength meter (kHz)	Limits (dB μ V/m)
	Vertical	Horizontal			
30 - 1000	<30.0	<30.0	QP	120	40.0 - 54
1062	<35.0	40.06	PK	1000	74.0
1195	<35.0	47.23	PK	1000	74.0
1200	41.46	<35.0	PK	1000	74.0
1333	38.27	<35.0	PK	1000	74.0
1603	42.97	47.21	PK	1000	74.0
1727	36.01	<35.0	PK	1000	74.0
1860	<35.0	41.02	PK	1000	74.0
1998	37.82	40.35	PK	1000	74.0
2131	<35.0	42.97	PK	1000	74.0
2135	40.35	<35.0	PK	1000	74.0
2406	<35.0	41.89	PK	1000	74.0
2677	<35.0	39.31	PK	1000	74.0
2800	<35.0	37.33	PK	1000	74.0
2925	40.53	46.06	PK	1000	74.0
3442	39.23	44.55	PK	1000	74.0
3836	43.21	42.35	PK	1000	74.0
5042	<35.0	39.48	PK	1000	74.0
other freq.	<35.0	<35.0	PK	1000	74.0

Table 6.2: radiated emission data on channel 6.

Note: Above 1 GHz, the peak values are below the limits for measurement with the average detector. Therefore, not all spurious emissions are measured with the average detector.

Test personnel:

Tester signature:

Date: December 19, 2001

Name

: D.H. Kruiter



Reception on channel 11: 2462 MHz.

Frequency (MHz)	Results for horizontal and vertical polarisation of measurement antenna (dB μ V/m)		Detector type: QP=Quasi peak AV=Average PK=Peak	Resolution Bandwidth of field strength meter (kHz)	Limits (dB μ V/m)
	Vertical	Horizontal			
30 -1000	<30.0	<30.0	QK	120	40.0 - 54.0
1062	34.28	40.77	PK	1000	74.0
1195	<35.0	46.26	PK	1000	74.0
1200	40.49	<35.0	PK	1000	74.0
1328	38.49	45.24	PK	1000	74.0
1599	43.37	<35.0	PK	1000	74.0
1603	<35.0	46.50	PK	1000	74.0
1727	36.01	<35.0	PK	1000	74.0
2002	38.16	40.24	PK	1000	74.0
2131	<35.0	42.75	PK	1000	74.0
2135	40.82	<35.0	PK	1000	74.0
2397	<35.0	43.23	PK	1000	74.0
2401	39.18	<35.0	PK	1000	74.0
2667	34.98	<35.0	PK	1000	74.0
2925	40.56	46.85	PK	1000	74.0
3442	39.67	43.78	PK	1000	74.0
3836	44.39	40.89	PK	1000	74.0
3984	41.03	39.18	PK	1000	74.0
5042	<35.0	37.72	PK	1000	74.0
other freq.	<35.0	<35.0	PK	1000	74.0

Table 6.3: radiated emission data on channel 11.

Note: Above 1 GHz, the peak values are below the limits for measurement with the average detector. Therefore, not all spurious emissions are measured with the average detector.

Test personnel:

Tester signature:

Date: December 19, 2001

Name : D.H. Kruiter



6.2 Radiated emission data in restricted bands in accordance with FCC 15.107 and FCC 15.207, transmit mode.

The following data lists the significant emission frequencies, measured levels in accordance with FCC 15.205.

Transmitting on channel 1, 2412 MHz

Frequency (MHz)	Results for horizontal and vertical polarisation of measurement antenna (dB μ V/m)		Detector type: QP=Quasi peak AV=Average PK=Peak	Resolution Bandwidth of field strength meter (kHz)	Limits (dB μ V/m)
	Vertical	Horizontal			
487.32	33.0	36.2	QP	120	46.0
499.60	32.5	36.1	QP	120	46.0
624.41	38.4	38.8	QP	120	46.0
675.57	35.1	36.0	QP	120	46.0
712.39	31.3	<30.0	QP	120	46.0
751.27	35.4	38.6	QP	120	46.0
788.10	33.4	38.8	QP	120	46.0
829.02	36.0	<30.0	QP	120	46.0
863.81	34.3	37.9	QP	120	46.0
876.08	36.0	42.8	QP	120	46.0
900.64	34.2	41.3	QP	120	46.0
937.46	34.5	41.9	QP	120	46.0
951.79	<30.0	35.3	QP	120	46.0
1000.89	<30.0	43.4	PK	1000	54.0

Table 6.4a: radiated emission data on channel 1.

Note: Radiated emission tests are performed with all bitrates. The highest values are given here. Above 1 GHz, the peak values are below the limits for measurement with the average detector. Therefore, not all spurious emissions are measured with the average detector.

Test personnel:

Tester signature:

Date: December 19, 2001

Name:

D.H. Kruijter



Frequency (MHz)	Results for horizontal and vertical polarisation of measurement antenna (dB μ V/m)		Detector type: QP=Quasi peak AV=Average PK=Peak	Resolution Bandwidth of field strength meter (kHz)	Limits (dB μ V/m)
	Vertical	Horizontal			
1011.54	<40.0	40.0	PK	1000	54.0
1124.65	<40.0	42.3	PK	1000	54.0
1249.30	42.3	40.2	PK	1000	54.0
1313.93	<40.0	42.3	PK	1000	54.0
1662.49	47.0	<40.0	PK	1000	54.0
1957.96	44.2	<40.0	PK	1000	54.0
2382.69	42.8	<40.0	PK	1000	54.0
17700.00	46.8	<40.0	PK	1000	54.0
17816.67	46.8	<40.0	PK	1000	54.0
17850.00	<40.0	47.2	PK	1000	54.0
17866.67	<40.0	46.8	PK	1000	54.0
17875.00	<40.0	48.8	PK	1000	54.0
17883.33	47.2	<40.0	PK	1000	54.0
17916.67	47.3	<40.0	PK	1000	54.0
17933.33	47.5	<40.0	PK	1000	54.0
17941.67	47.8	47.8	PK	1000	54.0
17950.00	47.8	48.5	PK	1000	54.0
18000.00	47.7	<40.0	PK	1000	54.0
22573.33	41.8	<40.0	PK	1000	54.0
22923.33	41.3	<40.0	PK	1000	54.0
23121.67	41.0	<40.0	PK	1000	54.0
23133.33	42.8	<40.0	PK	1000	54.0
23191.67	41.8	<40.0	PK	1000	54.0
23215.00	41.7	<40.0	PK	1000	54.0
24626.67	42.8	<40.0	PK	1000	54.0
24708.33	43.3	<40.0	PK	1000	54.0
other freq.	<40.0	<40.0	PK	1000	54.0

Table 6.4b: radiated emission data on channel 1.

Note: Radiated emission tests are performed with all bitrates. The highest values are given here. Above 1 GHz, the peak values are below the limits for measurement with the average detector. Therefore, not all spurious emissions are measured with the average detector.

Test personnel:

Tester signature:

Date: December 19, 2001

Name:

D.H. Kruiter



Transmitting on channel 6: 2437 MHz.

Frequency (MHz)	Results for horizontal and vertical polarisation of measurement antenna (dBµV/m)		Detector type: QP=Quasi peak AV=Average PK=Peak	Resolution Bandwidth of field strength meter (Khz)	Limits (dBµV/m)
	Vertical	Horizontal			
487.32	32.4	35.7	QP	120	46.0
499.60	33.9	36.1	QP	120	46.0
563.03	31.3	<30.0	QP	120	46.0
599.86	<30.0	32.8	QP	120	46.0
624.41	38.1	38.1	QP	120	46.0
675.57	36.5	34.6	QP	120	46.0
712.39	30.9	33.2	QP	120	46.0
751.27	35.5	38.6	QP	120	46.0
788.10	38.0	39.3	QP	120	46.0
824.93	<30.0	31.1	QP	120	46.0
863.81	32.6	38.0	QP	120	46.0
876.08	37.3	41.3	QP	120	46.0
900.64	32.2	42.0	QP	120	46.0
937.46	35.1	41.2	QP	120	46.0
951.79	<30.0	33.9	QP	120	46.0
1000.89	40.7	45.2	PK	1000	54.0

Table 6.5a: radiated emission data on channel 6.

Note: Radiated emission tests are performed with all bitrates. The highest values are given here. Above 1 GHz, the peak values are below the limits for measurement with the average detector. Therefore, not all spurious emissions are measured with the average detector.

Test personnel:

Tester signature:

Date: December 19, 2001

Name

: D.H. Kruiter



Frequency (MHz)	Results for horizontal and vertical polarisation of measurement antenna (dB μ V/m)		Detector type: QP=Quasi peak AV=Average PK=Peak	Resolution Bandwidth of field strength meter (Khz)	Limits (dB μ V/m)
	Vertical	Horizontal			
1124.65	<30.0	41.8	PK	1000	54.0
1249.30	42.3	<30.0	PK	1000	54.0
1251.61	<30.0	41.8	PK	1000	54.0
1701.73	42.7	<30.0	PK	1000	54.0
1927.95	40.8	<30.0	PK	1000	54.0
11926.67	<30.0	40.2	PK	1000	54.0
17350.00	43.7	<30.0	PK	1000	54.0
17941.67	<30.0	48.3	PK	1000	54.0
17966.67	48.5	48.7	PK	1000	54.0
17975.00	48.7	48.5	PK	1000	54.0
17983.33	<30.0	49.0	PK	1000	54.0
18000.00	<30.0	48.2	PK	1000	54.0
24230.00	42.7	<30.0	PK	1000	54.0
24265.00	43.2	<30.0	PK	1000	54.0
24941.67	43.8	<30.0	PK	1000	54.0
24953.33	44.0	<30.0	PK	1000	54.0
other freq.	<30.0	<30.0	PK	1000	54.0

Table 6.5b: radiated emission data on channel 6.

Note: Radiated emission tests are performed with all bitrates. The highest values are given here. Above 1 GHz, the peak values are below the limits for measurement with the average detector. Therefore, not all spurious emissions are measured with the average detector.

Test personnel:

Tester signature:

Date: December 19, 2001

Name

: D.H. Kruiter



Transmitting on channel 11: 2462 MHz.

Frequency (MHz)	Results for horizontal and vertical polarisation of measurement antenna (dB μ V/m)		Detector type: QP=Quasi peak AV=Average PK=Peak	Resolution Bandwidth of field strength meter (kHz)	Limits (dB μ V/m)
	Vertical	Horizontal			
43.32	32.2	<30.0	QP	120	46.0
374.79	31.2	<30.0	QP	120	46.0
499.60	35.1	30.4	QP	120	46.0
524.15	31.2	<30.0	QP	120	46.0
563.03	32.0	<30.0	QP	120	46.0
599.86	33.1	32.7	QP	120	46.0
624.41	38.0	38.0	QP	120	46.0
712.39	<30.0	33.7	QP	120	46.0
724.67	<30.0	30.6	QP	120	46.0
751.27	36.2	36.6	QP	120	46.0
788.10	35.7	36.9	QP	120	46.0
824.93	<30.0	31.5	QP	120	46.0
863.81	32.3	33.3	QP	120	46.0
876.08	36.3	39.2	QP	120	46.0
900.64	32.2	36.5	QP	120	46.0
925.19	<30.0	31.4	QP	120	46.0
937.46	<30.0	35.2	QP	120	46.0
951.79	<30.0	33.0	QP	120	46.0
1000.89	40.2	44.7	QP	120	46.0

Table 6.6a: radiated emission data on channel 11.

Note: Radiated emission tests are performed with all bitrates. The highest values are given here. Above 1 GHz, the peak values are below the limits for measurement with the average detector. Therefore, not all spurious emissions are measured with the average detector.

Test personnel:

Tester signature:

Date: December 3, 2001

Name:

D.H. Kruijter

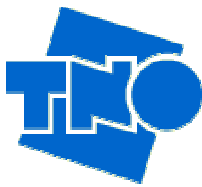

Frequency (MHz)	Results for horizontal and vertical polarisation of measurement antenna (dB μ V/m)		Detector type: QP=Quasi peak AV=Average PK=Peak	Resolution Bandwidth of field strength meter (kHz)	Limits (dB μ V/m)
	Vertical	Horizontal			
1124.65	39.7	42.7	PK	1000	56.0
1237.76	40.0	39.0	PK	1000	56.0
1249.30	44.8	41.0	PK	1000	56.0
1270.07	<35.0	39.0	PK	1000	56.0
1300.08	38.0	38.0	PK	1000	56.0
1364.72	39.3	<35.0	PK	1000	56.0
1376.26	40.5	40.5	PK	1000	56.0
1433.97	37.8	<35.0	PK	1000	56.0
1500.91	<35.0	38.3	PK	1000	56.0
1738.67	43.5	<35.0	PK	1000	56.0
1957.96	<35.0	38.7	PK	1000	56.0
1999.51	<35.0	38.0	PK	1000	56.0
2027.21	40.5	<35.0	PK	1000	56.0
2246.50	39.7	<35.0	PK	1000	56.0
2483.50	44.0	39.7	PK	1000	56.0
2492.47	41.0	37.0	PK	1000	56.0
2517.26	38.7	<35.0	PK	1000	56.0
2546.80	<35.0	35.8	PK	1000	56.0
2551.02	37.7	<35.0	PK	1000	56.0
2745.67	38.0	36.2	PK	1000	56.0
5914.67	35.0	35.0	PK	1000	56.0
11915.00	39.3	<35.0	PK	1000	56.0
11938.33	39.8	40.3	PK	1000	56.0
17883.33	<35.0	47.7	PK	1000	56.0
17933.33	48.5	<35.0	PK	1000	56.0
17958.33	48.0	<35.0	PK	1000	56.0
17975.00	<35.0	48.3	PK	1000	56.0
18000.00	47.7	48.0	PK	1000	56.0
24930.00	44.5	<35.0	PK	1000	56.0
other freq.	<35.0	<35.0	PK	1000	56.0

Table 6.6b: radiated emission data on channel 11.

Note: Radiated emission tests are performed with all bitrates. The highest values are given here. Above 1 GHz, the peak values are below the limits for measurement with the average detector. Therefore, not all spurious emissions are measured with the average detector.

Test personnel:

Tester signature:

Date: December 19, 2001

Name:

D.H. Kruijer



7 Conducted emission data at the AC power line terminals in accordance with FCC 15.107 and FCC 15.207.

The following table lists worst case conducted emission data from transmissions / receptions with various bitrates on various channels in accordance with FCC 15.207 and FCC 15.207. The conducted test was performed with the EUT exercise program loaded.

Frequency (MHz)	Results dB(µV) Line 1	Results dB(µV) Line 2	Limits dB(µV)	Margin (dB) Line 1	Margin (dB) Line 2	Result
0.400	43.5	44.4	48.0	4.5	3.6	PASS
0.510	41.0	n.a.	48.0	7.0	n.a.	PASS
0.670	41.0	40.0	48.0	7.0	8.0	PASS
0.700	41.5	40.9	48.0	6.5	7.1	PASS
0.800	45.1	42.1	48.0	2.9	5.9	PASS
0.880	45.9	44.5	48.0	2.1	3.5	PASS
1.290	43.8	n.a.	48.0	4.2	n.a.	PASS
1.370	43.2	44.1	48.0	4.8	3.9	PASS
1.420	42.5	n.a.	48.0	5.5	n.a.	PASS
2.060	39.7	39.2	48.0	8.3	8.8	PASS
2.120	39.8	39.9	48.0	8.2	8.1	PASS
2.510	39.3	38.1	48.0	8.7	9.9	PASS
3.660	34.8	n.a.	48.0	13.2	n.a.	PASS
3.890	35.9	34.9	48.0	12.1	13.1	PASS
4.390	n.a.	35.2	48.0	n.a.	12.8	PASS
5.100	32.2	31.6	48.0	15.8	16.4	PASS
5.430	32.2	32.0	48.0	15.8	16.0	PASS
9.680	36.5	29.7	48.0	11.5	18.3	PASS
12.970	26.0	n.a.	48.0	22.0	n.a.	PASS
13.010	30.8	n.a.	48.0	17.2	n.a.	PASS
13.520	26.3	25.8	48.0	21.7	22.2	PASS
19.420	n.a.	27.1	48.0	n.a.	20.9	PASS
19.960	28.1	n.a.	48.0	19.9	n.a.	PASS
21.090	28.2	n.a.	48.0	19.8	n.a.	PASS
25.000	26.4	26.5	48.0	21.6	21.5	PASS

Table 7.1: worst case disturbance voltage levels for channel 1 with different bitrates.

Measurement results are peak results. The highest values from the different bitrates are displayed. The conducted emission measurement has been carried with AC supply voltage of 120 V.

Test personnel:

Tester signature:

Date: December 19, 2001

Name:

D.H. Kruiter



Frequency (MHz)	Results dB(μV) Line 1	Results dB(μV) Line 2	Limits dB(μV)	Margin (dB) Line 1	Margin (dB) Line 2	Result
0.400	43.4	43.9	48.0	4.6	4.1	PASS
0.530	41.4	n.a.	48.0	6.6	n.a.	PASS
0.700	n.a.	40.7	48.0	n.a.	7.3	PASS
0.800	44.4	43.1	48.0	3.6	4.9	PASS
0.830	44.9	43.7	48.0	3.1	4.3	PASS
0.860	44.7	44.4	48.0	3.3	3.6	PASS
1.290	n.a.	43.5	48.0	n.a.	4.5	PASS
1.330	43.9	43.9	48.0	4.1	4.1	PASS
1.430	42.0	42.9	48.0	6.0	5.1	PASS
2.100	40.5	40.3	48.0	7.5	7.7	PASS
2.330	40.0	n.a.	48.0	8.0	n.a.	PASS
2.500	39.0	36.8	48.0	9.0	11.2	PASS
2.560	n.a.	36.3	48.0	n.a.	11.7	PASS
2.620	37.0	n.a.	48.0	11.0	n.a.	PASS
3.410	n.a.	36.1	48.0	n.a.	11.9	PASS
3.690	35.7	n.a.	48.0	12.3	n.a.	PASS
3.920	35.2	35.1	48.0	12.8	12.9	PASS
4.410	35.1	n.a.	48.0	12.9	n.a.	PASS
5.130	n.a.	32.8	48.0	n.a.	15.2	PASS
5.700	33.0	n.a.	48.0	15.0	n.a.	PASS
6.280	32.4	32.0	48.0	15.6	16.0	PASS
7.170	30.4	n.a.	48.0	17.6	n.a.	PASS
7.960	30.9	30.3	48.0	17.1	17.7	PASS
8.290	30.0	n.a.	48.0	18.0	n.a.	PASS
10.870	25.4	n.a.	48.0	22.6	n.a.	PASS
12.820	26.0	25.7	48.0	22.0	22.3	PASS
14.340	n.a.	25.9	48.0	n.a.	22.1	PASS
16.910	n.a.	26.0	48.0	n.a.	22.0	PASS
18.470	n.a.	27.2	48.0	n.a.	20.8	PASS
19.790	27.9	n.a.	48.0	20.1	n.a.	PASS
19.920	27.7	n.a.	48.0	20.3	n.a.	PASS
20.390	28.7	n.a.	48.0	19.3	n.a.	PASS
21.050	28.0	n.a.	48.0	20.0	n.a.	PASS
25.000	25.4	26.5	48.0	22.6	21.5	PASS

Table 7.2: worst case disturbance voltage levels for channel 6 with different bitrates.

Measurement results are peak results. The highest values from the different bitrates are displayed. The conducted emission measurement has been carried with AC supply voltage of 120 V.

Test personnel:

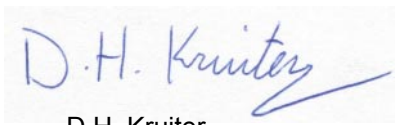
Tester signature: 

Date: December 19, 2001

Name: D.H. Kruiter



Frequency (MHz)	Results dB(μV) Line 1	Results dB(μV) Line 2	Limits dB(μV)	Margin (dB) Line 1	Margin (dB) Line 2	Result
0.400	42.0	43.3	48.0	6.0	4.7	PASS
0.500	n.a.	40.7	48.0	n.a.	7.3	PASS
0.700	41.1	39.8	48.0	6.9	8.2	PASS
0.810	43.9	42.5	48.0	4.1	5.5	PASS
0.860	44.7	43.9	48.0	3.3	4.1	PASS
0.880	44.6	43.8	48.0	3.4	4.2	PASS
1.320	43.7	43.5	48.0	4.3	4.5	PASS
1.410	41.2	42.8	48.0	6.8	5.2	PASS
2.100	40.2	39.5	48.0	7.8	8.5	PASS
2.270	39.7	39.3	48.0	8.3	8.7	PASS
2.490	n.a.	38.3	48.0	n.a.	9.7	PASS
2.510	37.7	25.5	48.0	10.3	22.5	PASS
2.620	37.5	36.3	48.0	10.5	11.7	PASS
3.950	35.4	34.6	48.0	12.6	13.6	PASS
4.140	35.6	n.a.	48.0	12.4	n.a.	PASS
4.360	35.5	n.a.	48.0	12.5	n.a.	PASS
4.440	n.a.	34.7	48.0	n.a.	13.3	PASS
4.970	33.2	n.a.	48.0	14.8	n.a.	PASS
5.110	33.2	31.9	48.0	14.8	16.1	PASS
5.630	32.0	32.1	48.0	16.0	15.9	PASS
6.280	32.2	32.2	48.0	15.8	15.8	PASS
7.400	30.7	30.7	48.0	17.3	17.3	PASS
7.510	30.1	n.a.	48.0	17.9	n.a.	PASS
7.860	30.0	30.4	48.0	18.0	17.6	PASS
8.000	n.a.	30.2	48.0	n.a.	17.8	PASS
11.580	n.a.	26.1	48.0	n.a.	21.9	PASS
12.060	26.6	n.a.	48.0	21.4	n.a.	PASS
12.610	25.9	26.1	48.0	22.1	21.9	PASS
13.770	26.2	n.a.	48.0	21.8	n.a.	PASS
13.920	n.a.	25.8	48.0	n.a.	22.2	PASS
14.480	n.a.	25.8	48.0	n.a.	22.2	PASS
16.170	n.a.	27.3	48.0	n.a.	20.7	PASS
18.280	n.a.	26.8	48.0	n.a.	21.2	PASS
19.150	29.1	27.0	48.0	18.9	21.0	PASS
19.870	28.2	n.a.	48.0	19.8	n.a.	PASS
20.130	28.2	n.a.	48.0	19.8	n.a.	PASS
21.020	27.9	n.a.	48.0	20.1	n.a.	PASS
25.000	25.6	26.3	48.0	22.4	21.7	PASS

Table 7.3: worst case disturbance voltage levels for channel 11 with different bitrates.

Measurement results are peak results. The highest values from the different bitrates are displayed. The conducted emission measurement has been carried with AC supply voltage of 120 V.

Test personnel:

Tester signature:

Date: December 19, 2001

Name:

D.H. Kruijer



8 Testresults of measurements in accordance with FCC 15.247.

8.1 Minimum 6 dB bandwidth.

Bitrate	Minimum 6 dB bandwidth (kHz)			Limit (kHz)
	Channel 1 2412 MHz	Channel 6 2437 MHz	Channel 11 2462 MHz	
1 Mbit/s	10280	10200	10280	>500
2 Mbit/s	10050	10050	10050	>500
5.5 Mbit/s	10280	10200	10280	>500
11 Mbit/s	11480	11480	11180	>500

Table 8.1: data concerning minimum 6 dB bandwidth.

Test personnel:

Tester signature:

Date: December 3, 2001

Name:

O. H. Hoekstra

8.2 Maximum peak output power of the intentional radiator.

Bitrate	Maximum peak output power (dBm)			Limit (dBm)
	Channel 1 2412 MHz	Channel 6 2437 MHz	Channel 11 2462 MHz	
1 Mbit/s	18.8	18.8	18.8	30.0
2 Mbit/s	18.8	18.8	18.8	30.0
5.5 Mbit/s	18.3	18.3	18.3	30.0
11 Mbit/s	18.7	18.7	18.7	30.0

Table 8.2: data concerning maximum peak output power of the intentional radiator.

Maximum values from measurements with supply voltages varied between 85% and 115% are noted down here. There are no differences in measurement results due to voltage variations between 85% and 115%. As the antenna gain does not exceed 6 dBi, no reduction of the maximum peak output power is required.

Test personnel:

Tester signature:

Date: December 3, 2001

Name:

O. H. Hoekstra



8.3 Radiated emission data outside restricted bands in a 100 kHz bandwidth

These radiated emission shall be at least 20 dB below the highest level in a 100 kHz bandwidth within the band.

Frequency (MHz)	dB below working channel (based on field strength)	Limits (dB)
2398.1	-34.4	<-20.0
2400	-37.1	<-20.0
Other frequencies	<-40.0	<-20.0

Table 8.3: data concerning radiated emission outside restricted bands in a 100 kHz bandwidth.

Note: Worst case situations for transmissions with all bitrate / channel 1, channel 6, and channel 11 combinations.

Test personnel:

Tester signature:

Date: December 3, 2001

Name:

O.H. Hoekstra



8.4 Conducted emission data outside restricted bands in a 100 kHz bandwidth

These emissions shall be at least 20 dB below the highest level in a 100 kHz bandwidth within the band.

Frequency (MHz)	dB below working channel	Limits (dB)
2398.1	-34.4	-20.0
2400	-37.1	-20.0

Table 8.4: data concerning conducted emission outside restricted bands in a 100 kHz bandwidth.

Note: Summary for transmissions with all bitrate / channel 1, channel 6, channel 11 combinations.

Test personnel:

Tester signature:

Date: December 3, 2001

Name : O. H. Hoekstra

8.5 Peak power spectral density conducted from the intentional radiator in any 3 kHz band.

Bitrate	Peak power spectral density in any 3 kHz band (dBm)			Limit (dBm)
	Channel 1 2412 MHz	Channel 6 2437 MHz	Channel 11 2462 MHz	
1 Mbit/s	-9.0	-8.9	-9.0	<8.0
2 Mbit/s	-8.9	-8.6	-8.7	<8.0
5.5 Mbit/s	-9.0	-8.8	-8.8	<8.0
11 Mbit/s	-6.5	-6.2	-6.2	<8.0

Table 8.5: data concerning peak power spectral density.

Test personnel:

Tester signature:

Date: December 3, 2001

Name: O. H. Hoekstra



FCC ID: IMRAPP2411R
Description of EUT: 2.4 GHz. low power RLAN PCMCIA Card
Manufacturer: Apple Computer, Inc.
Brand mark: Apple
Built-in in type: P19 Basestation

8.6 Processing gain of a direct sequence system.

The results are available in a separate test report.

Test personnel:

Tester signature:

A handwritten signature in blue ink, appearing to read 'O. H. Hoekstra'.

Date: December 3, 2001

Name:

O. H. Hoekstra



FCC ID: IMRAPP2411R
Description of EUT: 2.4 GHz. low power RLAN PCMCIA Card
Manufacturer: Apple Computer, Inc.
Brand mark: Apple
Built-in in type: P19 Basestation

9 Plots of measurement data.

For reference purposes and spectrum analyzer settings during the measurements, a selection of plots of measurement data is presented here.

Test personnel:

Tester signature:

A handwritten signature in blue ink, appearing to read 'O. H. Hoekstra'.

Date: December 3, 2001

Name:

O. H. Hoekstra



9.1 Emission in restricted bands nearest to the band 2400 - 2483.5 MHz.

9.1.1 Average values in restricted band 2310 - 2390 MHz.

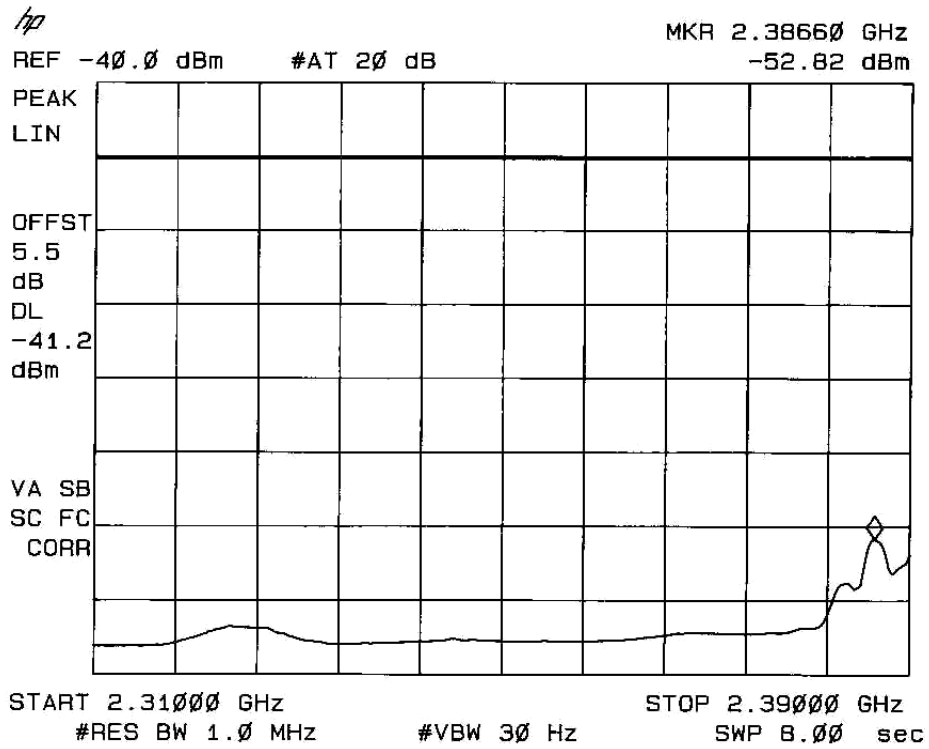

Figure 9.1: average values in restricted band, All bitrate settings, conducted measurement, corrected for 2 dBi antenna gain and 2.6 dB cable losses. 54 dB μ V/m :: -41.2 dBm display line setting.



FCC ID: IMRAPP2411R
Description of EUT: 2.4 GHz. low power RLAN PCMCIA Card
Manufacturer: Apple Computer, Inc.
Brand mark: Apple
Built-in in type: P19 Basestation

9.1.2 Peak values in restricted band 2310 - 2390 MHz.

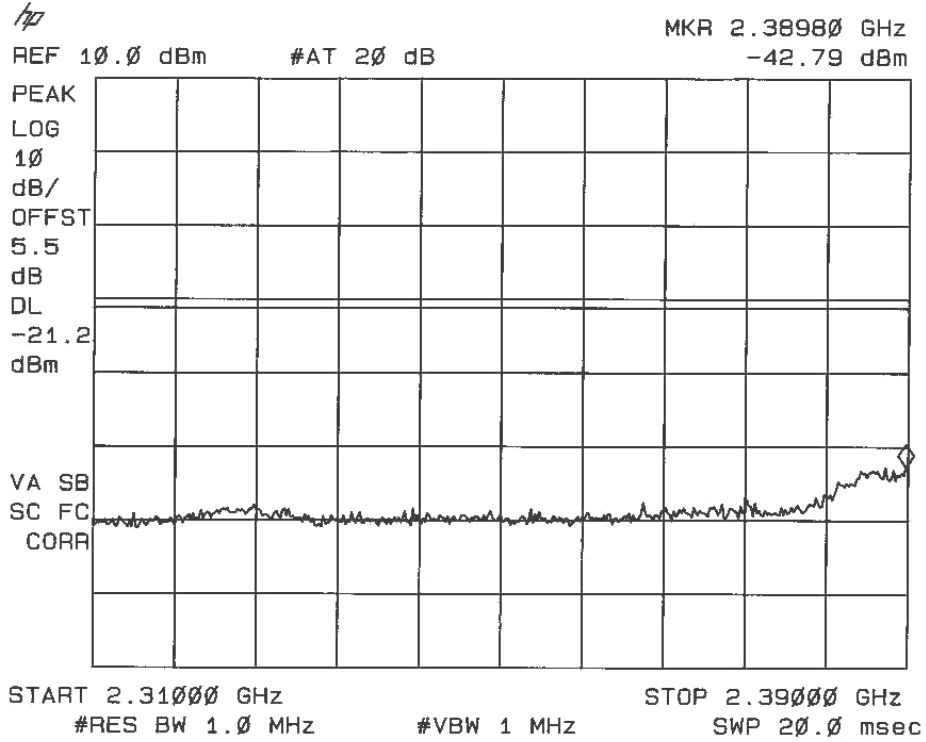
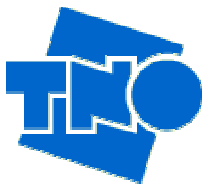

Figure 9.2: peak values in restricted band, All bitrate settings, conducted measurement, corrected for 2 dBi antenna gain and 2.6 dB cable losses. 74 dB μ V/m :: -21.2 dBm display line setting.



9.1.3 Average values in restricted band 2483.5 - 2500 MHz.

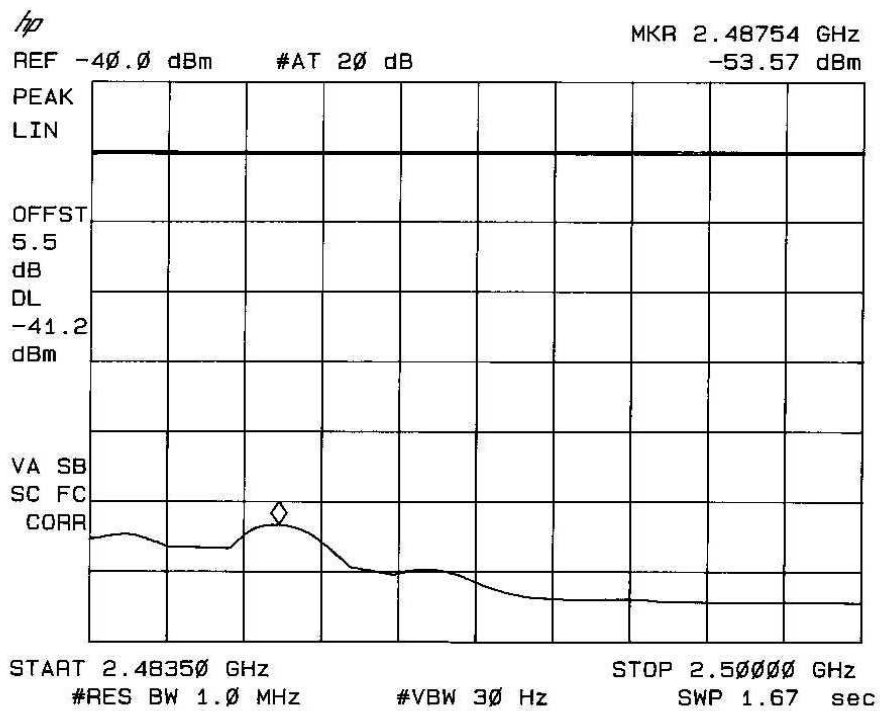
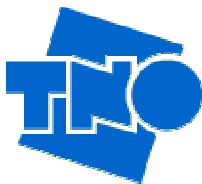

Figure 9.3: average values in restricted band, All bitrate settings, conducted measurement, corrected for 2 dBi antenna gain and 2.6 dB cable losses. 54 dB μ V/m :: -41.2 dBm display line setting.



9.1.4 Peak values in restricted band 2483.5 - 2500 MHz.

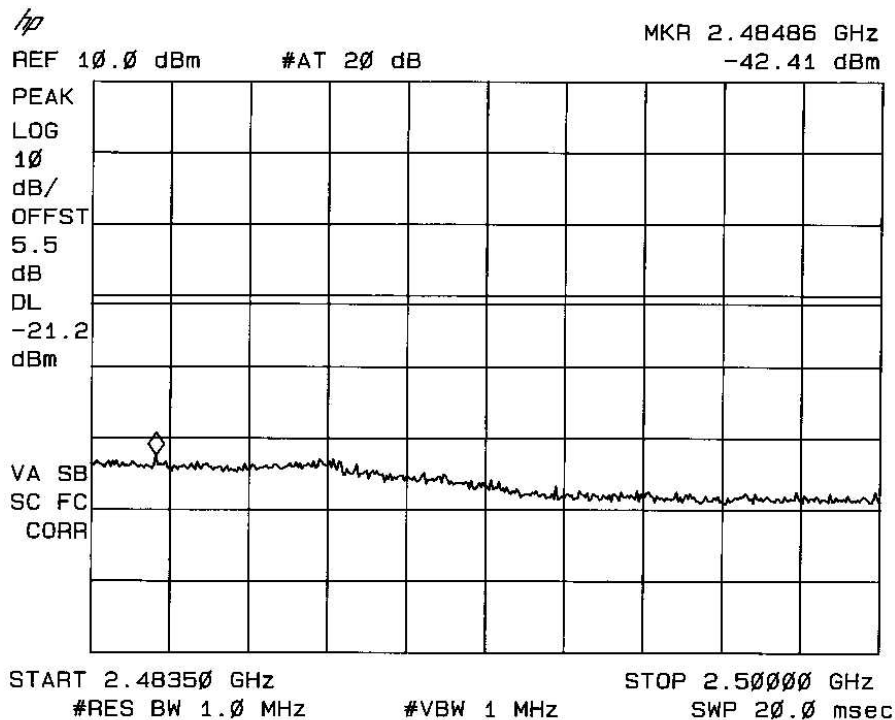

Figure 9.4: peak values in restricted band, All bitrate settings, conducted measurement, corrected for 2 dBi antenna gain and 2.6 dB cable losses. 74 dBµV/m :: -21.2 dBm display line setting.



9.2 Minimum 6 dB bandwidth.

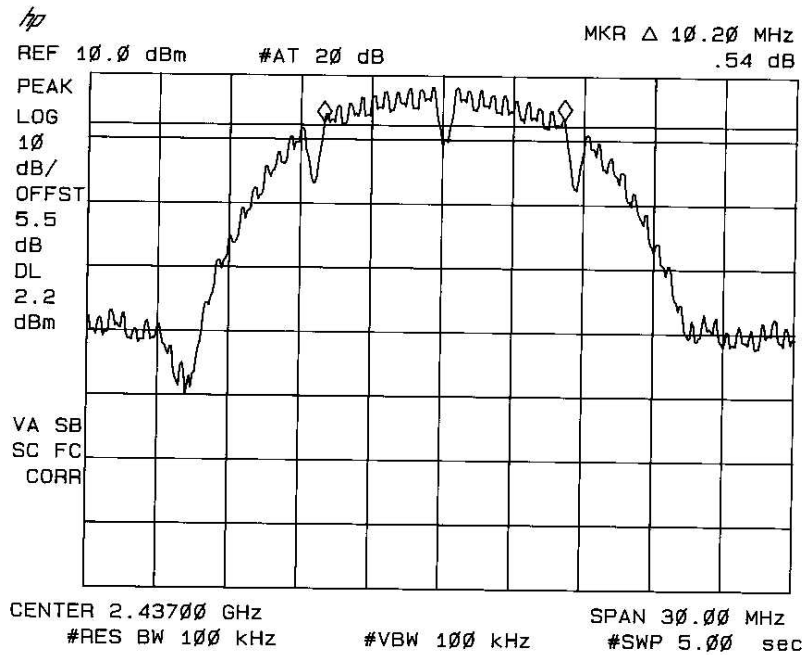

Figure 9.5: minimum 6 dB bandwidth at 1 Mbit/s.

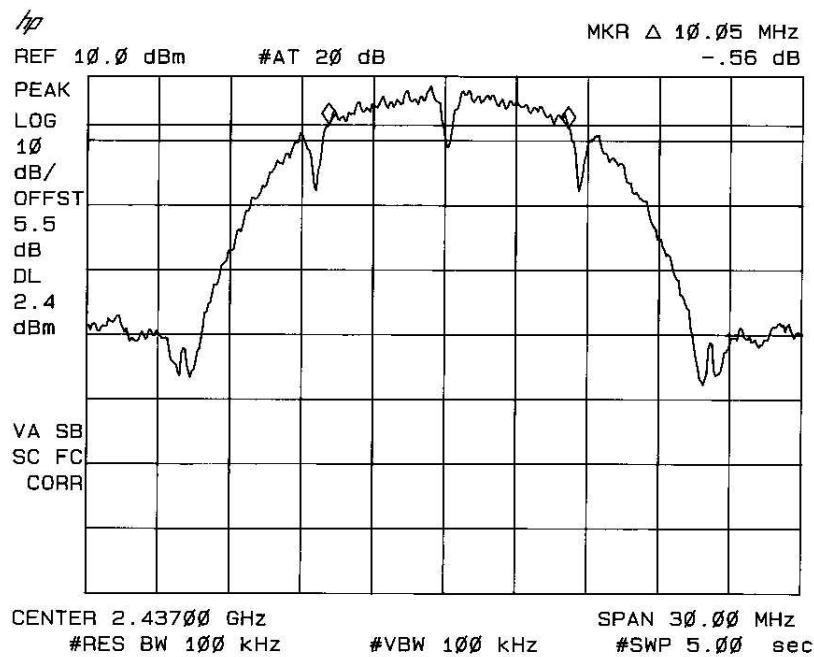

Figure 9.6: minimum 6 dB bandwidth at 2 Mbit/s.

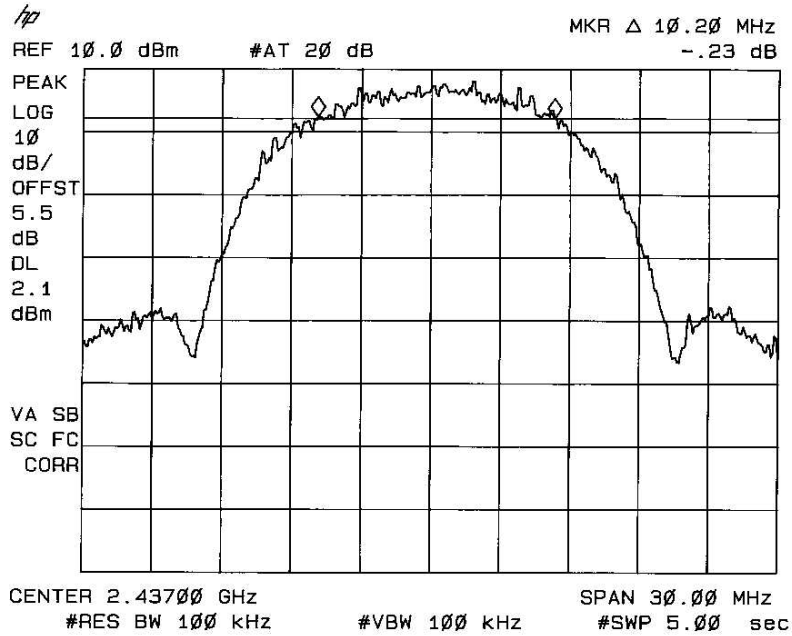
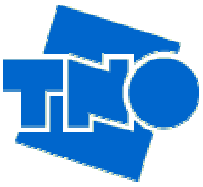

Figure 9.7: minimum 6 dB bandwidth at 5.5 Mbit/s.

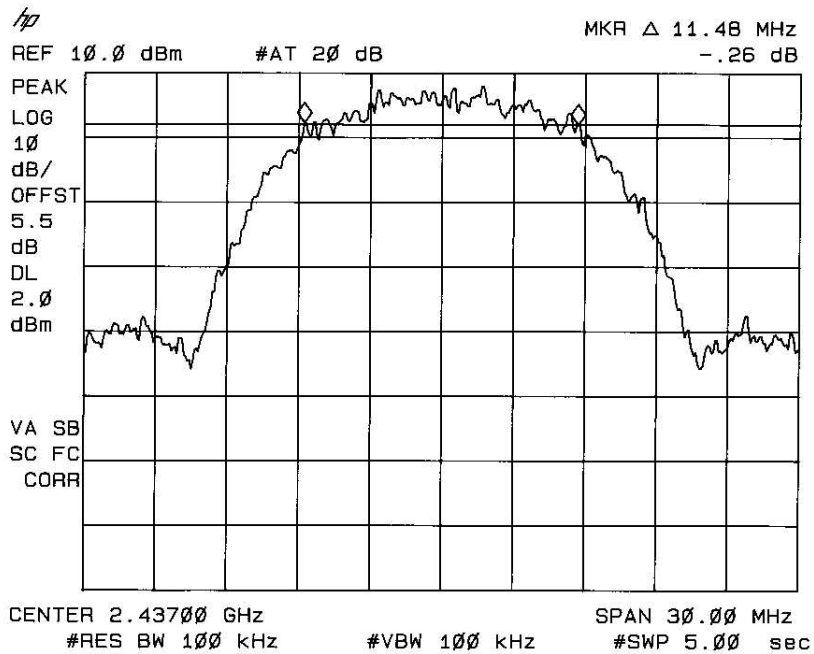
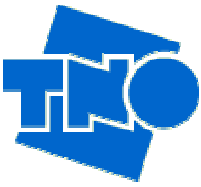

Figure 9.8: minimum 6 dB bandwidth at 11 Mbit/s.



9.3 Conducted emission

Data outside restricted bands in a 100 kHz bandwidth shall be at least 20 dB below the highest level in a 100 kHz bandwidth within the band.

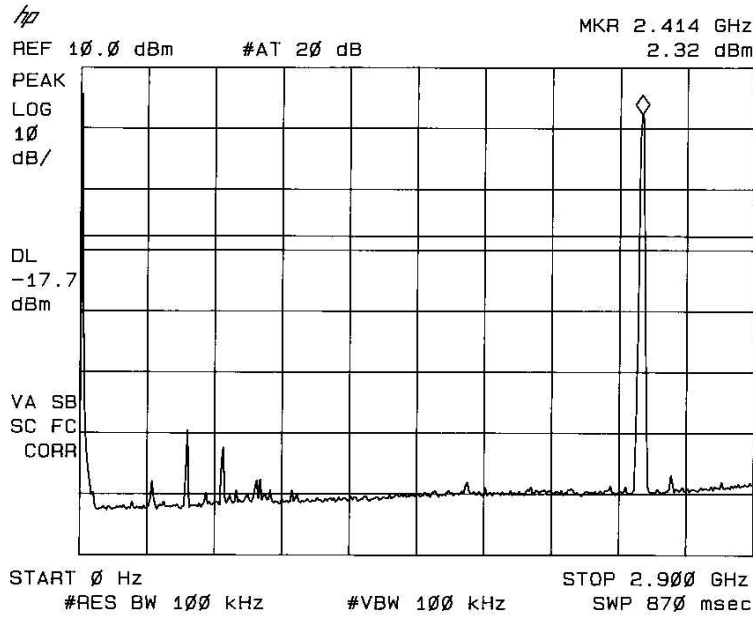

Figure 9.9: conducted emission outside restricted band. Display line :: -20 dB limit line. Corrected (offset) for cable losses.

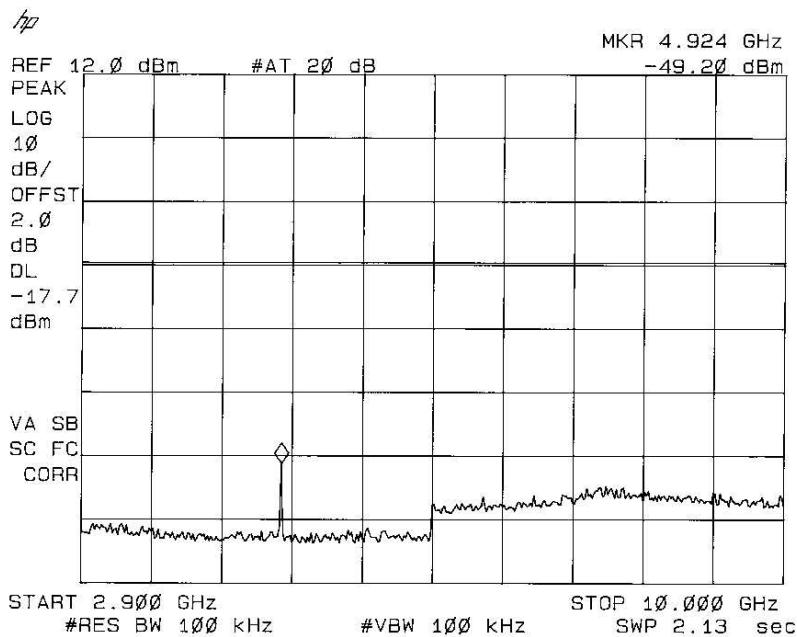

Figure 9.10: conducted emission outside restricted band. Display line :: -20 dB limit line. Corrected (offset) for cable losses.

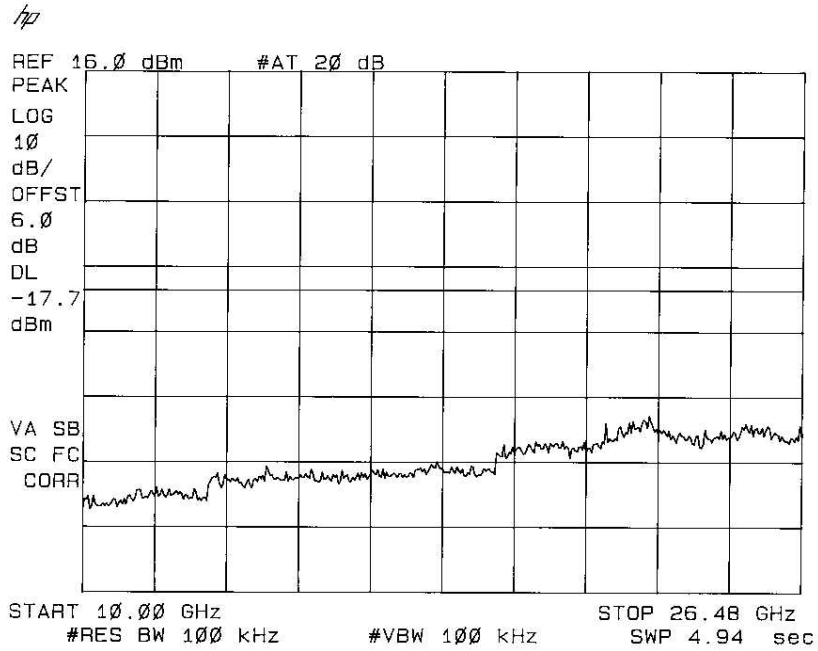
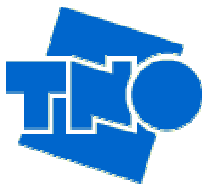

Figure 9.11: conducted emission outside restricted band. Display line :: -20 dB limit line. Corrected (offset) for cable losses.



9.4 Peak power spectral density conducted from the intentional radiator in any 3 kHz band.

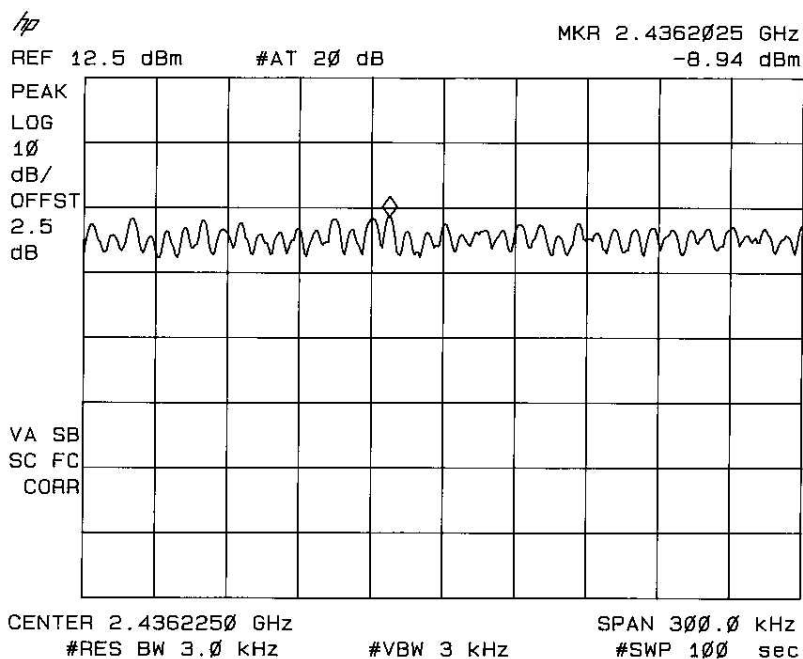

Figure 9.12: peak power density in a 3 kHz bandwidth at 1 Mbit/s. Corrected (offset) for cable losses.

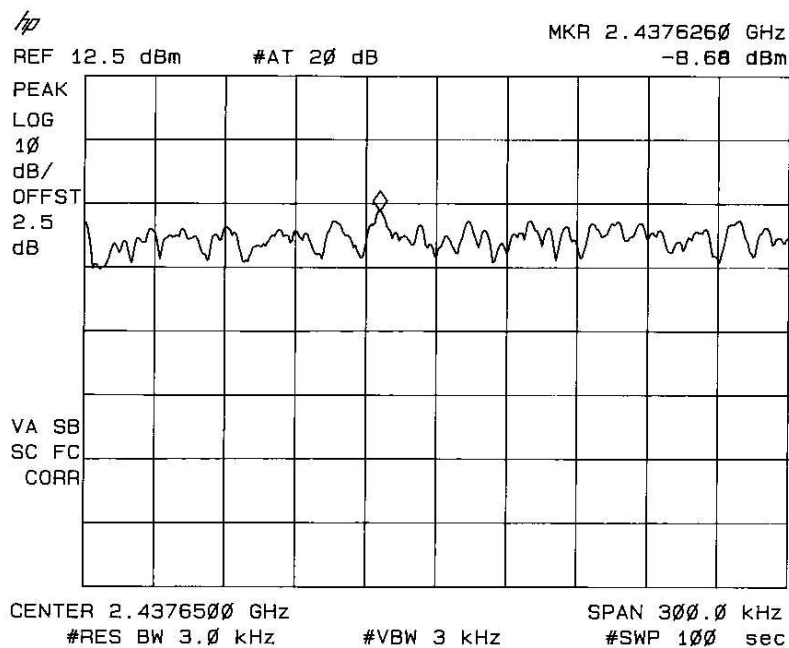

Figure 9.13: peak power density in a 3 kHz bandwidth at 2 Mbit/s. Corrected (offset) for cable losses.



FCC ID: IMRAPP2411R
Description of EUT: 2.4 GHz. low power RLAN PCMCIA Card
Manufacturer: Apple Computer, Inc.
Brand mark: Apple
Built-in in type: P19 Basestation

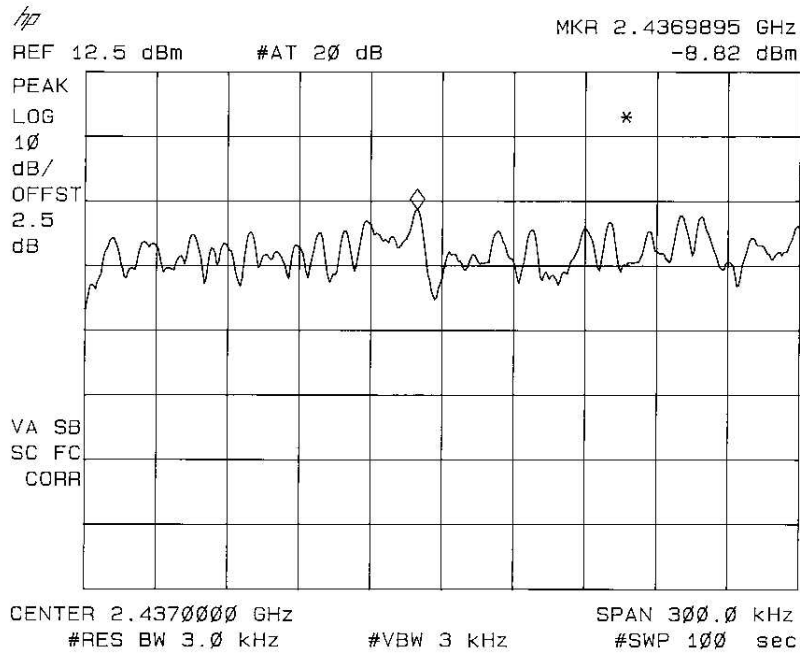

Figure 9.14: peak power density in a 3 kHz bandwidth at 5.5 Mbit/s. Corrected (offset) for cable losses.

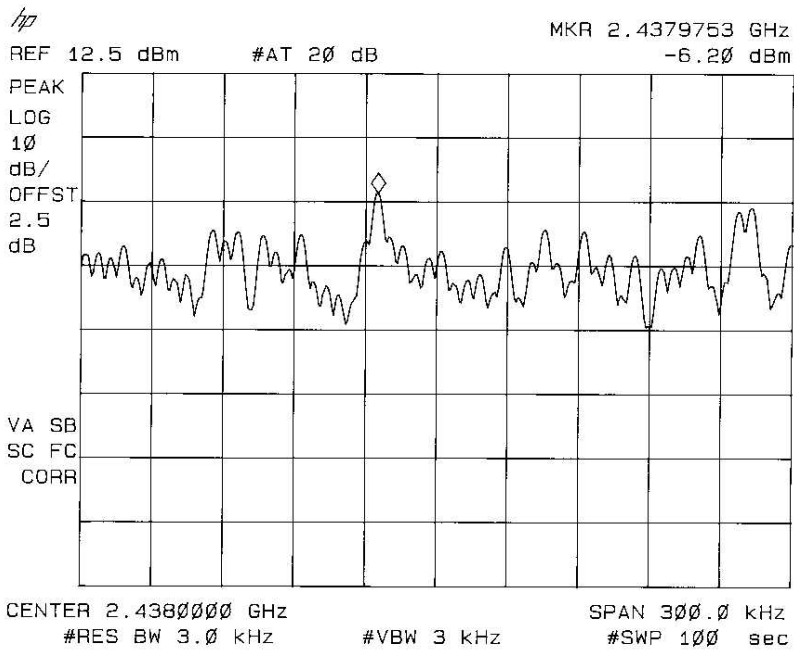

Figure 9.15: peak power density in a 3 kHz bandwidth at 11 Mbit/s. Corrected (offset) for cable losses.



10 List of used measuring equipment.

TNO number	Description	Brand	Type
12471	Biconical antenna 20 MHz - 200 MHz	EATON	94455-1
12473	Log-per antenna 200 - 1000 MHz	EATON	96005
12476	Antenna mast	EMCO	TR3
12477	Antenna mast 1 - 4 mtr	Poelstra	--
12482	Loop antenna	EMCO	6507
12483	Guidehorn	EMCO	3115
12484	Guidehorn	EMCO	3115
12488	Guidehorn 18 - 26.5 GHz	EMCO	RA42-K-F-4B-C
12533	Signalgenerator	MARCONI	2032
12559	Digital storage oscilloscope	Le Croy	9310M
12561	DC Power Supply 20A / 70V	DELTA	SM7020D
12567	Plotter	Hewlett Packard	7440A
12605	calibrated dipole 28 MHz - 1 GHz	EMCO	3121c
12608	HF milliwattmeter	Hewlett Packard	HP435a
12609	Power sensor 10 MHz - 18 GHz	Hewlett Packard	HP8481A
12636	Polyester chamber	Polyforce	--
12640	Temperature chamber	Heraeus	VEM03/500
13664	Spectrum analyzer	Hewlett Packard	HP8593E
13078	Preamplifier 0.1 GHz - 12 GHz	Miteq	AMF-3D-001120-35-14p
13452	Digital multi meter	Hewlett Packard	34401A
13526	Signalgenerator 20 GHz	Hewlett Packard	83620A
13594	Preamplifier 10 GHz - 25 GHz	Miteq	AMF-6D-100250-10p
13886	Open Area testsite	Comtest	--
14051	Anechoic room	Comtest	--
14450	2.4 GHz bandrejectfilter	BSC	XN-1783
15633	Biconilog Testantenna	Chase	CBL 6111B
15667	Measuring receiver	R&S	ESCS30
99045	DC Power Supply 3A / 30V	DELTA	E030/3
99055	Non-conducting support	Nmi	--
99061	Non-conducting support 150cm	Nmi	--
99068	Detector N-F/BNC-F	Radiall	R451576000
99069	Cable 5m RG214	Nmi	--
99071	Cable 10m RG214	Nmi	--
99076	Bandpassfilter 4 - 10 GHz	Reactel	7AS-7G-6G-511
99077	Regulating trafo	RFT	LTS006
99112	Tripod	Chase	--
99136	Bandpassfilter 10 - 26.5 GHz	Reactel	9HS-10G/26.5G-S11
99220	Regulating trafo	RFT	LTS020

Table 10.1: list of used measuring equipment.