

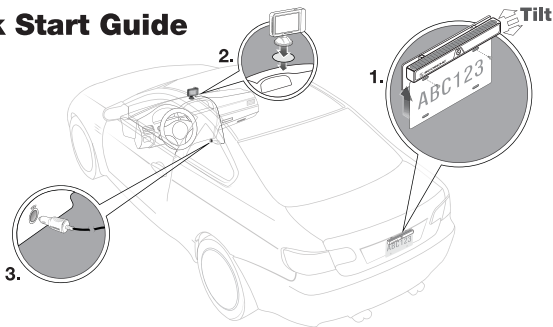

**WBUSSPF43**  
**WIRELESS UNIVERSAL**  
**BACKUP SOLAR CAMERA**  
**Quick Start Guide**

## Quick Start Guide



### IMPORTANT!

Fully charge the camera's battery by unscrewing the weatherproof cover and plugging the unit into a standard USB-A charger with the provided USB-C cable before beginning installation. Access the charging port by removing one Phillips head screw from weatherproof cover to expose charging port and rest button located underneath.

### Installation Tips:

- Choose a flat surface for the monitor, temporarily hold the monitor on that location and look for a safe place to route the monitor's power cord from the monitor to the 12-volt power source socket.
- Before mounting the monitor, thoroughly clean the area to remove any dirt or oils.
- Peel the backing located under the monitor and firmly press it in place.
- Test functionality before routing.

- Mount and install solar powered camera to the license plate.

**Note:** Tilt the camera upwards to expose the mounting holes. Camera frame is equipped with a hinge to help angle the camera for mounting and positioning. The camera's mounting bracket sits behind the license plate.

**Recommended:** Use Factory Fasteners. If original hardware is not available, use included hardware.

#### Option 1: For Vehicles with no overhanging obstructions

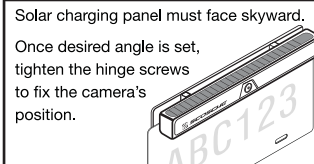
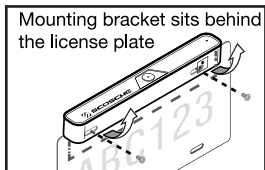

#### Option 2: For Vehicles with overhanging obstructions or vehicle bodywork.

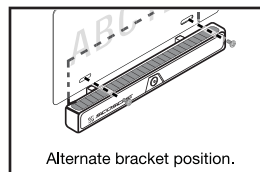
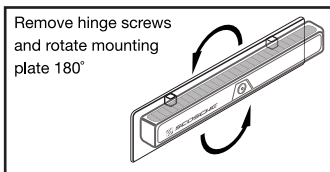

- Mount the monitor to desired location and connect the USB power cord to the device. See right side for mounting steps.

**Note:** Clean mounting location thoroughly of debris and dust for the best suction.



- Connect the power cord to the vehicle's 12V power socket. Also, connect the USB Type-C to the monitor's power port located on the side of the device.

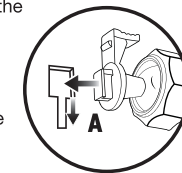

- Align the ball joints opposite end to the monitor's back mounting slot. Once aligned, slide to secure into place (A).

- Firmly apply the suction mount to the windshield or dash (B) and press on the lever to secure suction grip (C).

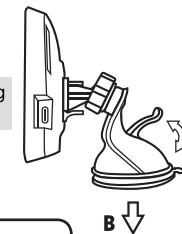

**Note:** Make sure lever is released before applying to the windshield, for best results.

**TECH SUPPORT** ! If you have any questions or need technical assistance with the installation, or the most current application please call or visit us on the web at: (800) 363-4490 x1 | [www.scosche.com/contact](http://www.scosche.com/contact)

## Warning

### Safety Driving

This product is intended to assist in safe driving habits allowing the driver to view a broader area behind the vehicle while in reverse. It is the driver's sole responsibility for the safe operation of the vehicle when in reverse and to always look in the direction the vehicle is traveling. This Product is not intended as a replacement for using the rear-view mirror and looking behind while backing the vehicle. The monitor is only an aid and not designed to show the actual distance to an object. Be aware of blind spots and that the image on the monitor may be misleading.

### VEHICLE LAWS & REGULATIONS

Many States and jurisdictions have laws & regulations that govern: TV screens/monitors in view of the driver, mounting cameras on vehicles as well as mounting objects on or near license plate. Before using this product, it is the owner's sole responsibility to be aware of any and all laws that apply to his/ her specific installation when using this product.

### INSTALLATION PRECAUTIONS

These instructions are provided as a general guide and do not apply to all vehicles.

For information on your specific vehicle, questions regarding the installation or operation, call SCOSCHE® Tech Support Dept: **(800) 363-4490 Ext. 1.**

You may also visit our website at [www.scosche.com/contact](http://www.scosche.com/contact) or email us at: [techsupport@scosche.com](mailto:techsupport@scosche.com)

### FCC Warning

This device complies with Part 15 of the FCC Rules. Operation is subject to the following two

#### conditions

(1) this device may not cause harmful interference, and  
(2) this device must accept any interference received, including interference that may cause

undesired operation. Changes or modifications not expressly approved by the party responsible

for compliance could void the user's authority to operate the equipment.

Note 1: This equipment has been tested and found to comply with the limits

for a Class B digital

device, pursuant to part 15 of the FCC Rules. These limits are designed to

provide reasonable protection against harmful interference in a residential installation. This equipment generates,

uses and can radiate radio frequency energy and, if not installed and used

in accordance with the

instructions, may cause harmful interference to radio communications.

However, there is no

guarantee that interference will not occur in a particular installation. If this

equipment does

cause harmful interference to radio or television reception, which can be

determined by turning

the equipment off and on, the user is encouraged to try to correct the

interference by one or

more of the following measures:

—Reorient or relocate the receiving antenna.

—Increase the separation between the equipment and receiver.

—Connect the equipment into an outlet on a circuit different from that to

which the receiver is connected.

—Consult the dealer or an experienced radio/TV technician for help.

Note 2: 1.Changes or modifications to this unit not expressly approved by the party responsible

for compliance could void the user's authority to operate the equipment.

2. The minimum separation generally be used is at least 20 cm.



## WBUSSPF43

WIRELESS UNIVERSAL  
BACKUP SOLAR CAMERA

**Synchronizing & Features**

## Synchronizing

### Synchronizing Monitor to your Camera

**A.** Charge camera unit before proceeding. Fully charge the camera's battery by unscrewing the weatherproof cover and plugging the unit into a standard USBA charger with the provided USBC cable, see Figure A.

**Note:** Remove No.1 Phillips head screw from weatherproof cover to expose charging port and rest button located underneath. If the daily solar charging is not enough, the battery indicator on the LCD display informs the driver when manual charging is needed.

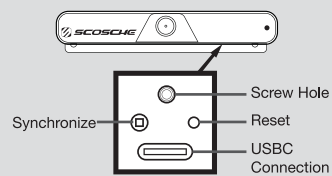

**B.** Once fully charged press Sync button on camera to begin pairing mode (A).

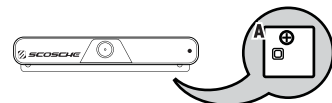

Note: Sync is accessible at all times, cover on or off).

**C.** Press Menu "M" on the back of the monitor and hold for 3S+ until the monitor enters pairing mode. If pairing is successful, the monitor will display a camera signal. If the pairing process fails to sync the monitor will display **pairing fail**.

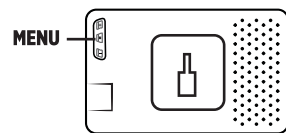

Back of Monitor

## Features

1. Power: Type-c, 5V
2. MENU: Press M to menu setting
3. Press "+" to increase the value
4. Press "-" to decrease the value
5. **Default settings:**  
Press the "+" and "-" to adjust the various settings, see available settings below:
  - Brightness      - Contrast      -Mirror Image
  - Guide Line Off      - Auto Power off with 60S.
6. **Timeout Setting**  
Monitor enters timeout after certain time of no activity. Screen will turn on automatically with most vehicles ignition\* Vehicles with a constant-powered cigarette lighter adapter will need to be activated manually each time. To reactivate monitor press any button. Options for Sleep Mode include the following:
  - 30 Seconds    -45 Seconds    - 60 Seconds    - 90 Seconds
  - Off (default setting after powered on)

### 7. Capacitive Touch Button

Manually wake up the system when needed (such as when arriving at your destination after driving). When the timeout setting is set to OFF, the system will remain ON once activated until turned off manually with the capacitive touch button.

**Note:** Scosche logo (C) is a touch capacitive button. Keep button clear of debris and gently clean when needed. When powered on a visual display of the backup camera's field of vision will display on the screen (D).

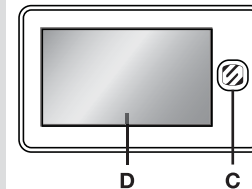

### 8. Built-in battery, charging through solar panel or type-c 5V

- Red Indicator Light On = Charging
- Red Indicator Light Off = Camera is fully charged.
- Blue Indicator Light On= Camera is in use
- Blue Indicator Light Off= Timeout Mode

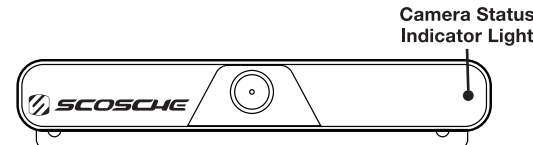

### IC warning

This device complies with Industry Canada licence-exempt RSS standard(s).

Operation is subject to the following two conditions:

(1) This device may not cause interference and (2) this device must accept any interference,

including interference that may cause undesired operation of the device.

Le présent appareil est conforme aux CNR d'Industrie Canada applicables aux appareils radio exempts de licence. L'exploitation est autorisée aux deux conditions suivantes :

(1) l'appareil ne doit pas produire de brouillage, et

(2) l'utilisateur de l'appareil doit accepter tout brouillage radioélectrique subi, même si le brouillage

est susceptible d'en compromettre le fonctionnement.

Under Industry Canada regulations, this radio transmitter may only operate using an antenna of a

type and maximum (or lesser) gain approved for the transmitter by Industry Canada. To reduce

potential radio interference to other users, the antenna type and its gain should be so chosen that

the equivalent isotropically radiated power (e.i.r.p.) is not more than that necessary for successful

communication.

Conformément à la réglementation d'Industrie Canada, le présent émetteur radio peut

fonctionner avec une antenne d'un type et d'un gain maximal (ou inférieur) approuvé pour

l'émetteur par Industrie Canada. Dans le but de réduire les risques de

### brouillage

radioélectrique à l'intention des autres utilisateurs, il faut choisir le type d'antenne et son gain de

sorte que la puissance isotrope rayonnée équivalente (p.i.r.e.) ne dépasse pas l'intensité

nécessaire à l'établissement d'une communication satisfaisante.

This radio transmitter (identify the device by certification number, or model number if Category II)

has been approved by Industry Canada to operate with the antenna types listed below with the

maximum permissible gain and required antenna impedance for each antenna type indicated.

Antenna types not included in this list, having a gain greater than the maximum gain indicated for

that type, are strictly prohibited for use with this device.

Le présent émetteur radio (identifier le dispositif par son numéro de certification ou son

numéro de modèle s'il fait partie du matériel de catégorie I) a été approuvé par Industrie

Canada pour fonctionner avec les types d'antenne énumérés ci-dessous et ayant un gain

admissible maximal et l'impédance requise pour chaque type d'antenne. Les types d'antenne non

inclus dans cette liste, ou dont le gain est supérieur au gain maximal indiqué, sont strictement

interdits pour l'exploitation de l'émetteur.

The minimum separation generally be used is at least 20 cm.

La distance minimale généralement utilisée est d'au moins 20 cm.