

# TEST REPORT

Report No.: BCTC2304408542-2E

---

Applicant: Scosche Industries Inc.

---

Product Name: Power bank

---

Model/Type Ref.: PBQ5MS2

---

Tested Date: 2023-04-23 to 2023-05-08

---

Issued Date: 2023-05-10

---

**Shenzhen BCTC Testing Co., Ltd.**

# FCC ID: IKQPBQ5MS2

Product Name: Power bank  
Trademark: Scosche  
Model/Type Ref.: PBQ5MS2, PBQ5MS2WT  
Prepared For: Scosche Industries Inc.  
Address: 1550 Pacific Ave. Oxnard CA 93033 USA  
Manufacturer: Scosche Industries Inc.  
Address: 1550 Pacific Ave. Oxnard CA 93033 USA  
Prepared By: Shenzhen BCTC Testing Co., Ltd.  
Address: 1-2/F., Building B, Pengzhou Industrial Park, No.158, Fuyuan 1st Road, Tangwei, Fuhai Subdistrict, Bao'an District, Shenzhen, Guangdong, China  
Sample Received Date: 2023-04-23  
Sample tested Date: 2023-04-23 to 2023-05-08  
Report No.: BCTC2304408542-2E  
Test Standards: FCC Part15.209  
ANSI C63.10-2013  
Test Results: PASS

Tested by:

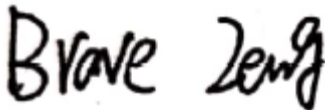

Brave Zeng/ Project Handler

Approved by:



Zero Zhou/Reviewer

The test report is effective only with both signature and specialized stamp. This result(s) shown in this report refer only to the sample(s) tested. Without written approval of Shenzhen BCTC Testing Co., Ltd, this report can't be reproduced except in full. The tested sample(s) and the sample information are provided by the client.

## Table of Content

Test Report Declaration	Page
1. Version .....	4
2. Test Summary .....	5
3. Measurement Uncertainty .....	6
4. Product Information and Test Setup .....	7
4.1 Product Information .....	7
4.2 Test Setup Configuration .....	7
4.3 Support Equipment .....	8
4.4 Test Mode .....	8
5. Test Facility and Test Instrument Used .....	9
5.1 Test Facility .....	9
5.2 Test Instrument Used .....	9
6. Conducted Emissions .....	11
6.1 Block Diagram Of Test Setup .....	11
6.2 Limit .....	11
6.3 Test Procedure .....	11
6.4 EUT Operating Conditions .....	12
6.5 Test Result .....	13
7. Radiated Emissions .....	15
7.1 Block Diagram Of Test Setup .....	15
7.2 Limit .....	16
7.3 Test Procedure .....	16
7.4 Test Result .....	17
8. Bandwidth Test .....	20
9. Antenna Requirements .....	22
10. EUT Test Setup Photographs .....	23

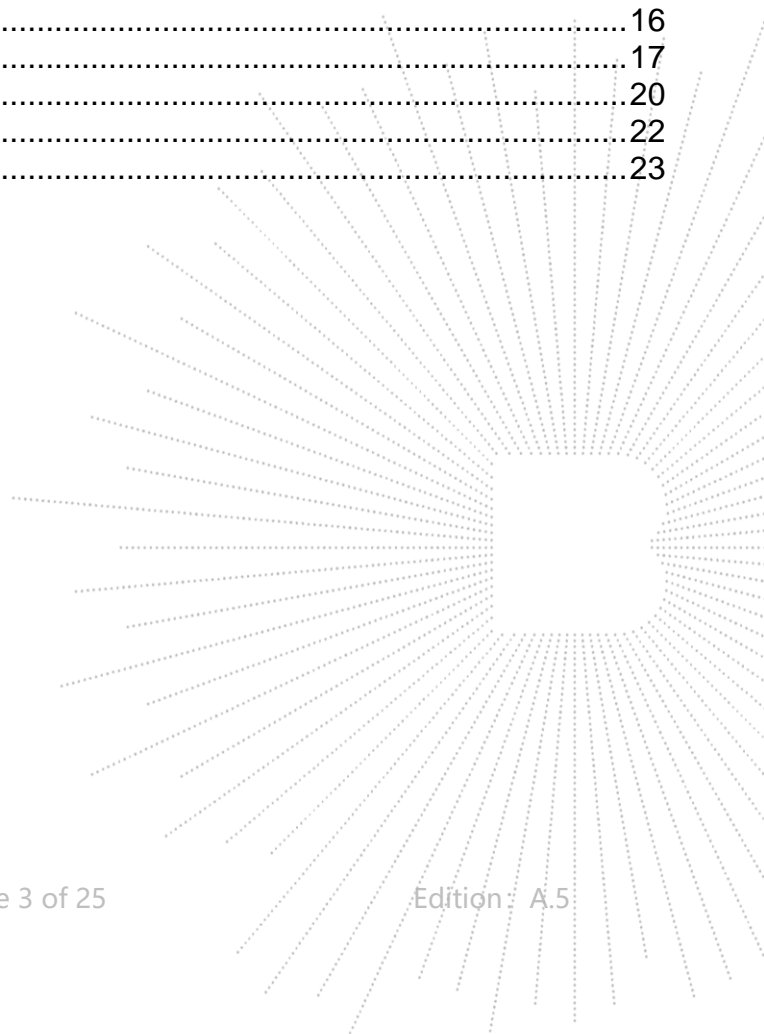

**1. Version**

Report No.	Issue Date	Description	Approved
BCTC2304408542-2E	2023-05-10	Original	Valid

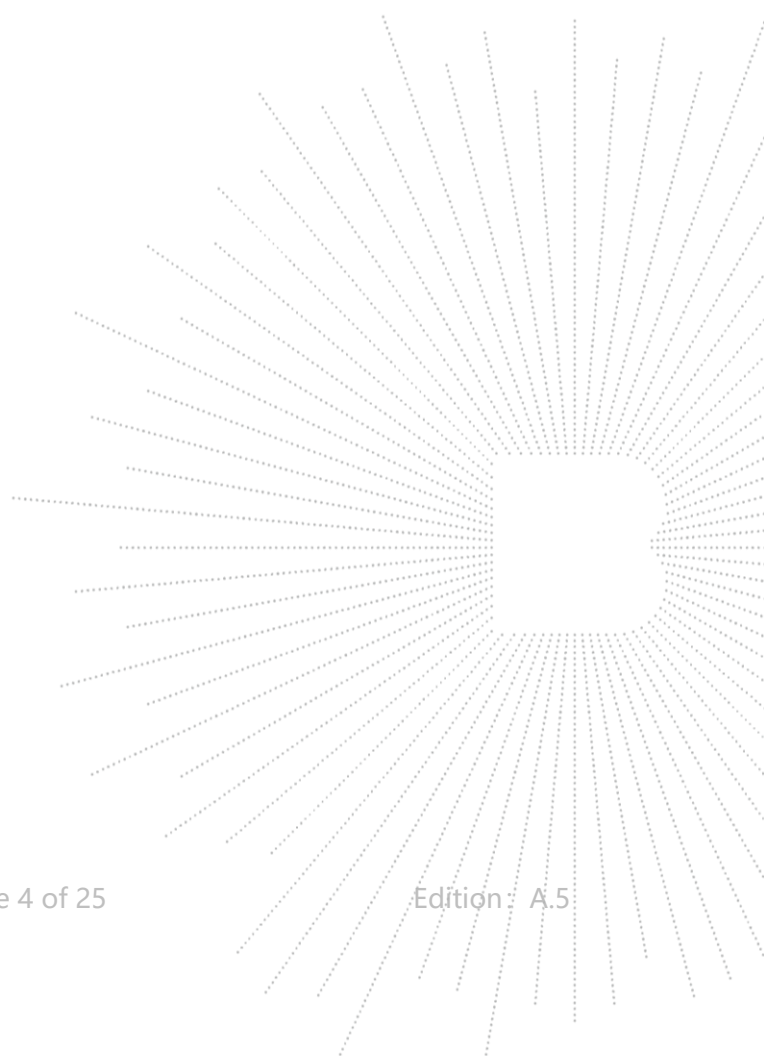

## 2. Test Summary

The Product has been tested according to the following specifications:

No.	Test Parameter	Clause No	Results
1	Conducted Emission	15.207	PASS
2	Radiated Emission	15.209	PASS
3	20dB Bandwidth	15.215	PASS
4	Antenna Requirement	15.203	PASS

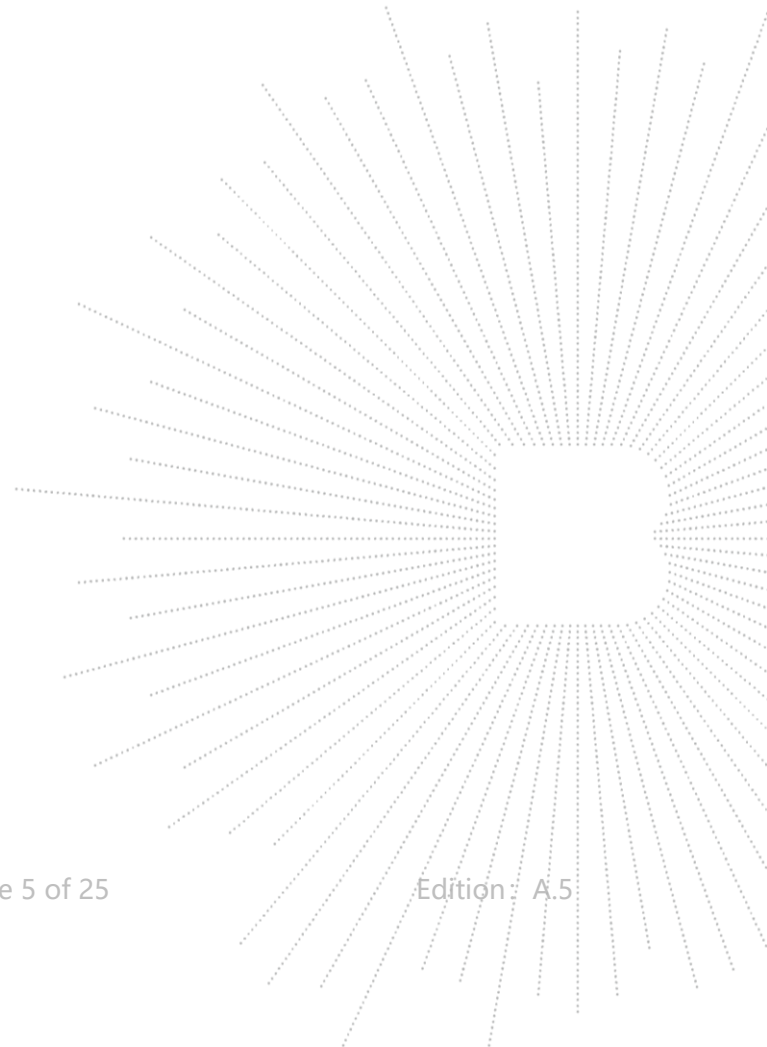

### 3. Measurement Uncertainty

Where relevant, the following measurement uncertainty levels have been estimated for tests performed on the Product as specified in CISPR 16-4-2. This uncertainty represents an expanded uncertainty expressed at approximately the 95% confidence level using a coverage factor of  $k=2$ .

No.	Item	Uncertainty
1	3m chamber Radiated spurious emission(9kHz-30MHz)	U=3.7dB
2	3m chamber Radiated spurious emission(30MHz-1GHz)	U=4.3dB
3	3m chamber Radiated spurious emission(1GHz-18GHz)	U=4.5dB
4	3m chamber Radiated spurious emission(18GHz-40GHz)	U=3.34dB
5	Conducted Emission(150kHz-30MHz)	U=3.20dB
6	Conducted Adjacent channel power	U=1.38dB
7	Conducted output power uncertainty Above 1G	U=1.576dB
8	Conducted output power uncertainty below 1G	U=1.28dB
9	humidity uncertainty	U=5.3%
10	Temperature uncertainty	U=0.59°C

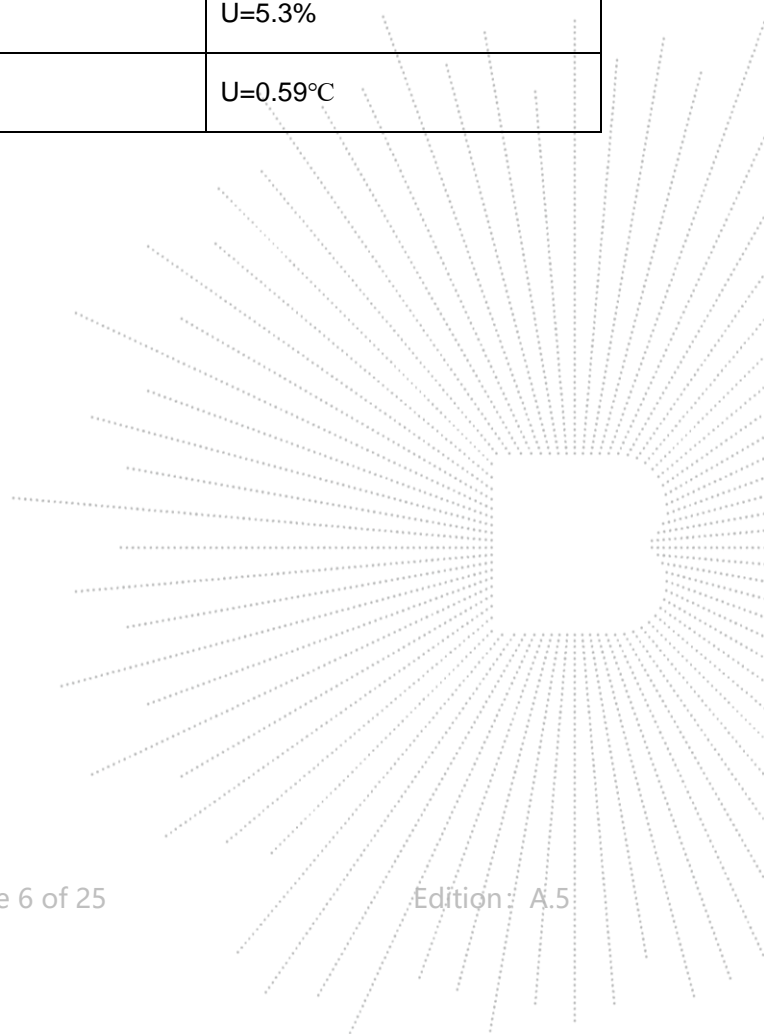

## 4. Product Information and Test Setup

### 4.1 Product Information

Model/Type reference:	PBQ5MS2, PBQ5MS2WT
Model differences:	Our production units bearing the following model numbers are identical in circuitry and electrical, mechanical and physical construction; The difference is only in model names.
Modulation:	ASK
Operation Frequency:	112-205KHz
Antenna installation:	Loop coil antenna
Ratings:	Input(Power Bank) : 5V/2A Input /Output: 5V/2A Wireless: 5W/7.5W/10W
Adapter:	Input: AC100-240V,50/60Hz Output: 5V/2A

### 4.2 Test Setup Configuration

See test photographs attached in EUT TEST SETUP Photographs for the actual connections between Product and support equipment.

Conducted Emission

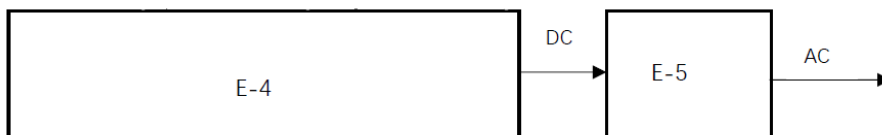

Radiated Spurious Emission:

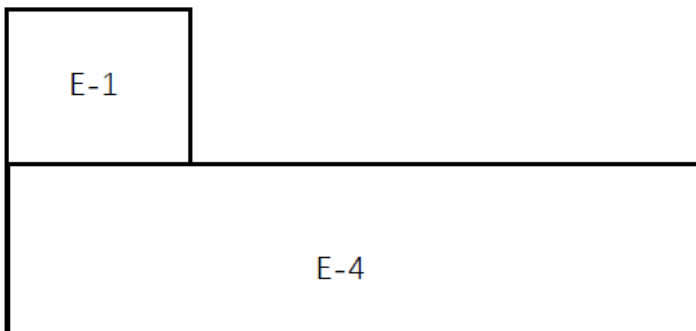

### 4.3 Support Equipment

No.	Device Type	Brand	Model	Series No.	Note
E-1	Dummy load	N/A	DL01	N/A	Auxiliary
E-4	Power bank	N/A	QIC37	N/A	EUT
E-5	Adapter	N/A	N/A	N/A	Auxiliary

Notes:

1. All the equipment/cables were placed in the worst-case configuration to maximize the emission during the test.
2. Grounding was established in accordance with the manufacturer's requirements and conditions for the intended use.
3. The wireless charge did not work while the sample was being charged

### 4.4 Test Mode

To investigate the maximum EMI emission characteristics generates from EUT, the test system was pre-scanning tested base on the consideration of following EUT operation mode or test configuration mode which possible have effect on EMI emission level. Each of these EUT operation mode(s) or test config

Test Modes 1	Charge
Test Modes 2	No-load mode
Test Modes 3	Half-load mode
Test Modes 4	Full load mode

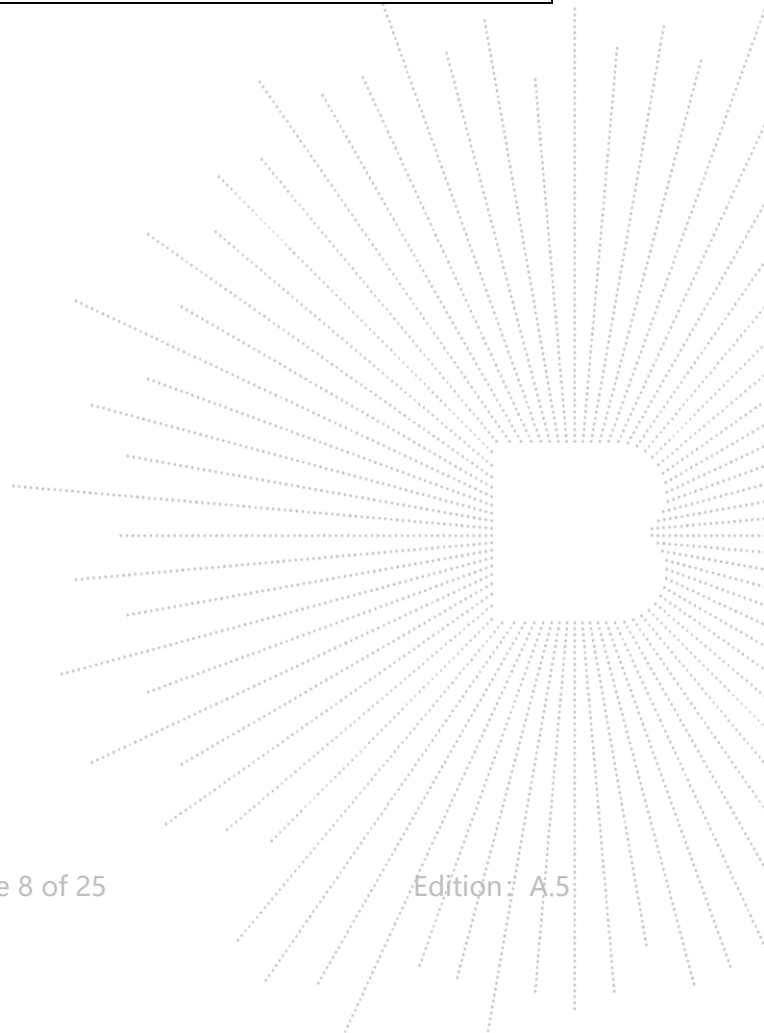



## 5. Test Facility and Test Instrument Used

### 5.1 Test Facility

All measurement facilities used to collect the measurement data are located at Shenzhen BCTC Testing Co., Ltd. Address: 1-2/F., Building B, Pengzhou Industrial Park, No.158, Fuyuan 1st Road, Zhancheng, Fuhai Subdistrict, Bao'an District, Shenzhen, Guangdong, China. The site and apparatus are constructed in conformance with the requirements of ANSI C63.4 and CISPR 16-1-1 other equivalent standards.

FCC Test Firm Registration Number: 712850

A2LA certificate registration number is: CN1212

ISED Registered No.: 23583

ISED CAB identifier: CN0017

### 5.2 Test Instrument Used

Conducted emissions Test					
Equipment	Manufacturer	Model#	Serial#	Last Cal.	Next Cal.
Receiver	R&S	ESR3	102075	May 24, 2022	May 23, 2023
LISN	R&S	ENV216	101375	May 24, 2022	May 23, 2023
Software	Frad	EZ-EMC	EMC-CON 3A1	\	\
Attenuator	\	10dB DC-6GHz	1650	May 24, 2022	May 23, 2023

RF Conducted Test					
Equipment	Manufacturer	Model#	Serial#	Last Cal.	Next Cal.
Power Meter	Keysight	E4419	\	May 24, 2022	May 23, 2023
Power Sensor (AV)	Keysight	E9300A	\	May 24, 2022	May 23, 2023
Signal Analyzer 20kHz-26.5GHz	Keysight	N9020A	MY49100060	May 24, 2022	May 23, 2023
Spectrum Analyzer 9kHz-40GHz	R&S	FSP40	\	May 24, 2022	May 23, 2023

Radiated Emissions Test (966 Chamber)					
Equipment	Manufacturer	Model#	Serial#	Last Cal.	Next Cal.
966 chamber	ChengYu	966 Room	966	Jun. 06. 2020	Jun. 05, 2023
Receiver	R&S	ESR3	102075	May 24, 2022	May 23, 2023
Receiver	R&S	ESRP	101154	May 24, 2022	May 23, 2023
Amplifier	SKET	LAPA_01G18 G-45dB	\	May 24, 2022	May 23, 2023
Amplifier	Schwarzbeck	BBV9744	9744-0037	May 24, 2022	May 23, 2023
TRILOG Broadband Antenna	Schwarzbeck	VULB9163	942	May 26, 2022	May 25, 2023
Horn Antenna	Schwarzbeck	BBHA9120D	1541	May 24, 2022	May 23, 2023
Horn Antenn (18GHz-40GHz)	Schwarzbeck	BBHA9170	00822	Jun. 15, 2021	May 23, 2023
Amplifier (18GHz-40GHz)	MITEQ	TTA1840-35- HG	2034381	May 26, 2022	May 25, 2023
Loop Antenna (9kHz-30MHz)	Schwarzbeck	FMZB1519B	00014	May 26, 2022	May 25, 2023
RF cables1 (9kHz-30MHz)	Huber+Suhnar	9kHz-30MHz	B1702988-000 8	May 26, 2022	May 25, 2023
RF cables2 (30MHz-1GHz)	Huber+Suhnar	30MHz-1GHz	1486150	May 26, 2022	May 25, 2023
RF cables3 (1GHz-40GHz)	Huber+Suhnar	1GHz-40GHz	1607106	May 26, 2022	May 25, 2023
Power Metter	Keysight	E4419	\	May 26, 2022	May 25, 2023
Power Sensor (AV)	Keysight	E9300A	\	May 26, 2022	May 25, 2023
Signal Analyzer 20kHz-26.5G Hz	Keysight	N9020A	MY49100060	May 26, 2022	May 25, 2023
Spectrum Analyzer 9kHz-40GHz	R&S	FSP 40	\	May 26, 2022	May 25, 2023
Software	Frad	EZ-EMC	FA-03A2 RE	\	\

## 6. Conducted Emissions

### 6.1 Block Diagram Of Test Setup

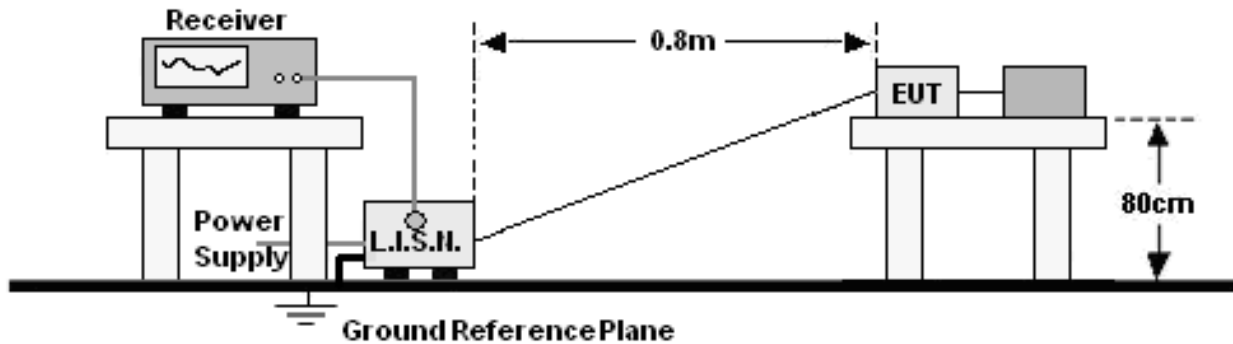

### 6.2 Limit

FREQUENCY (MHz)	Limit (dBuV)	
	Quas-peak	Average
0.15 -0.5	66 - 56 *	56 - 46 *
0.50 -5.0	56.00	46.00
5.0 -30.0	60.00	50.00

Notes:  
 1. \*Decreasing linearly with logarithm of frequency.  
 2. The lower limit shall apply at the transition frequencies.

### 6.3 Test Procedure

Receiver Parameters	Setting
Attenuation	10 dB
Start Frequency	0.15 MHz
Stop Frequency	30 MHz
IF Bandwidth	9 kHz

- The Product was placed on a nonconductive table 0.8 m above the horizontal ground reference plane, and 0.4 m from the vertical ground reference plane, and connected to the main through Line Impedance Stability Network (L.I.S.N).
- The RBW of the receiver was set at 9 kHz in 150 kHz ~ 30MHz with Peak and AVG detector in Max Hold mode. Run the receiver's pre-scan to record the maximum disturbance generated from Product in all power lines in the full band.
- For each frequency whose maximum record was higher or close to limit, measure its QP and AVG values and record.

## 6.4 EUT Operating Conditions

The EUT was configured for testing in a typical fashion (as a customer would normally use it). The EUT has been programmed to continuously transmit during test. This operating condition was tested and used to collect the included data.

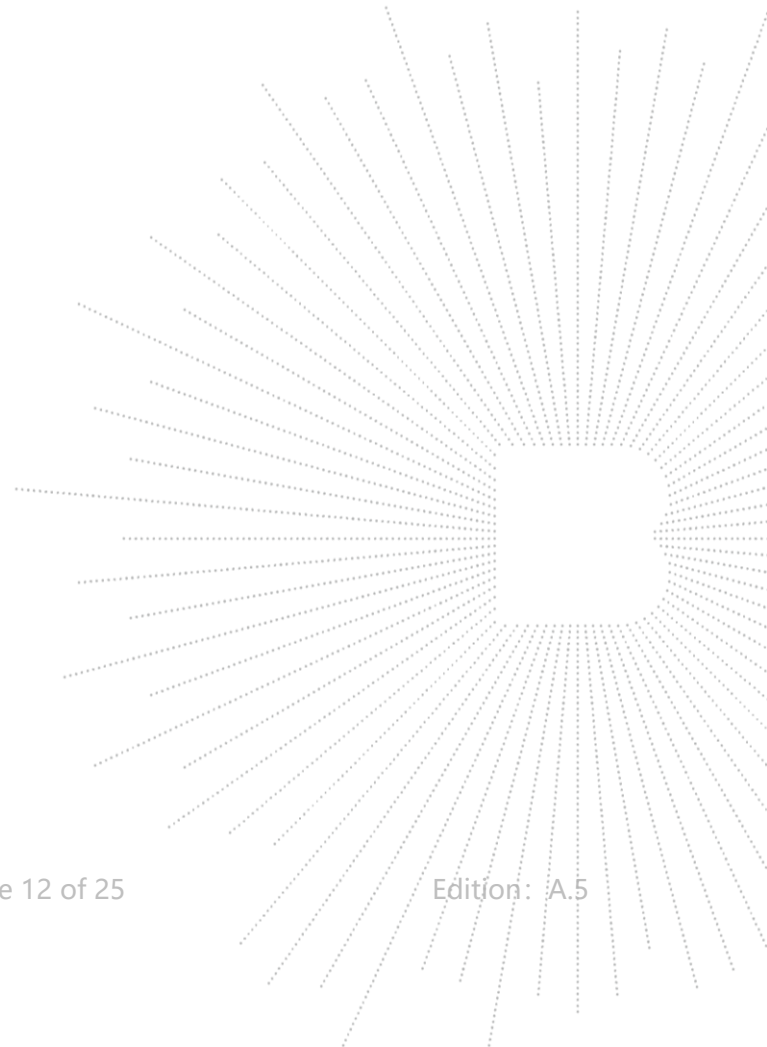

### 6.5 Test Result

Temperature:	26 °C	Relative Humidity:	54%
Pressure:	101kPa	Phase:	L
Test Voltage :	AC 120V/60Hz	Test Mode:	Mode 1

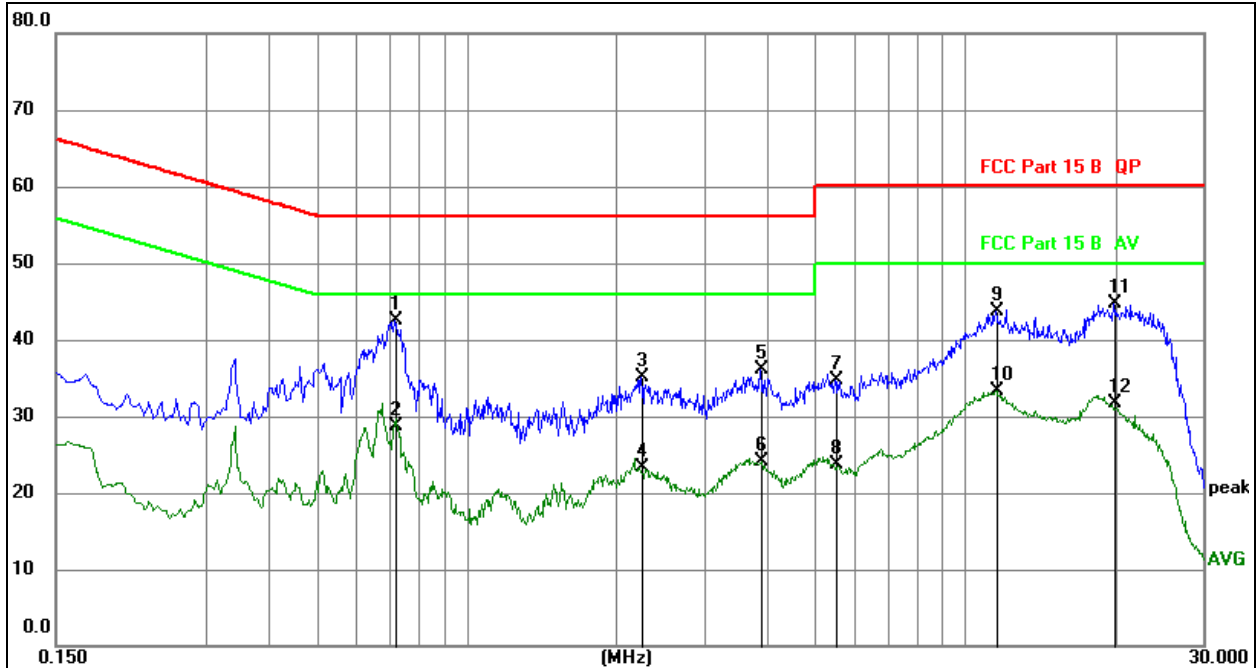

**Remark:**

1. All readings are Quasi-Peak and Average values.
2. Factor = Insertion Loss + Cable Loss.
3. Measurement=Reading Level+ Correct Factor
4. Over=Measurement-Limit

No. Mk.	Freq. MHz	Reading Level dB	Correct Factor dB	Measure- ment dBuV	Limit dBuV	Over dB	Detector	Comment
1 *	0.7169	32.29	10.14	42.43	56.00	-13.57	QP	
2	0.7169	18.49	10.14	28.63	46.00	-17.37	AVG	
3	2.2468	24.84	10.20	35.04	56.00	-20.96	QP	
4	2.2468	13.06	10.20	23.26	46.00	-22.74	AVG	
5	3.8895	25.83	10.24	36.07	56.00	-19.93	QP	
6	3.8895	13.93	10.24	24.17	46.00	-21.83	AVG	
7	5.4960	24.40	10.30	34.70	60.00	-25.30	QP	
8	5.4960	13.45	10.30	23.75	50.00	-26.25	AVG	
9	11.5575	33.31	10.39	43.70	60.00	-16.30	QP	
10	11.5575	22.99	10.39	33.38	50.00	-16.62	AVG	
11	19.8870	34.21	10.54	44.75	60.00	-15.25	QP	
12	19.8870	21.14	10.54	31.68	50.00	-18.32	AVG	

Temperature:	26 °C	Relative Humidity:	54%
Pressure:	101kPa	Phase:	N
Test Voltage :	AC 120V/60Hz	Test Mode:	Mode 1

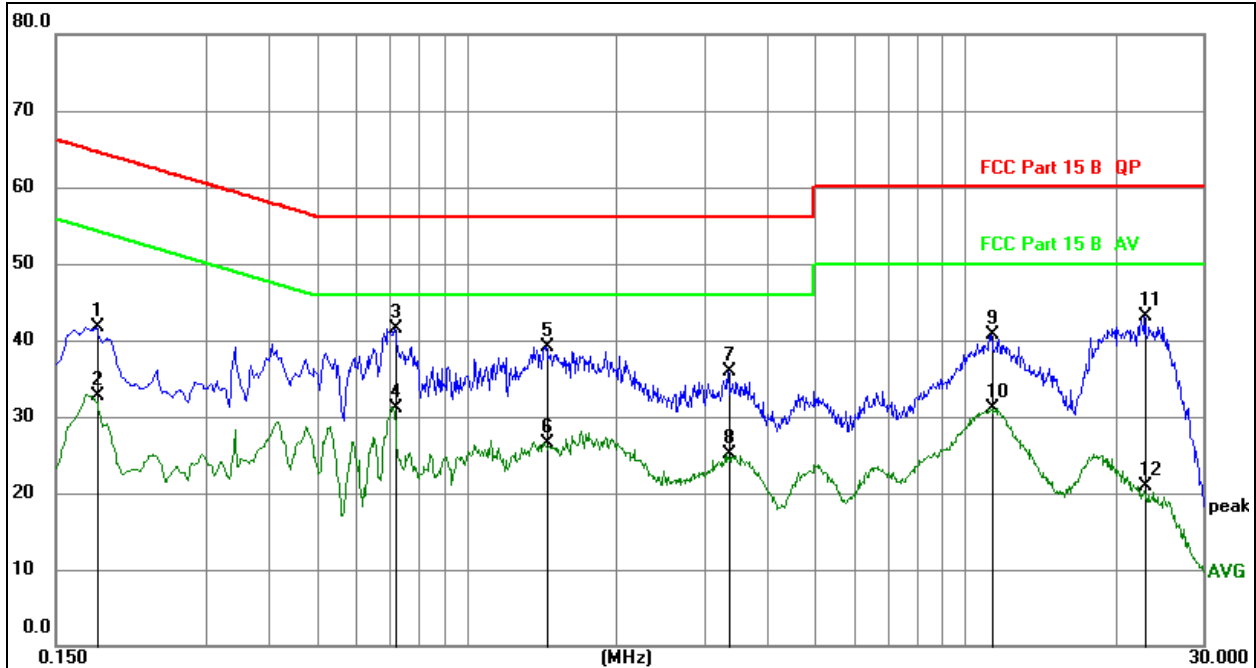
**Remark:**

1. All readings are Quasi-Peak and Average values.
2. Factor = Insertion Loss + Cable Loss.
3. Measurement=Reading Level+ Correct Factor
4. Over=Measurement-Limit

No. Mk.	Freq.	Reading Level	Correct Factor	Measurement	Limit	Over	Detector	Comment
	MHz		dB	dBuV	dBuV	dB		
1	0.1814	31.38	10.24	41.62	64.42	-22.80	QP	
2	0.1814	22.47	10.24	32.71	54.42	-21.71	AVG	
3 *	0.7188	31.43	10.14	41.57	56.00	-14.43	QP	
4	0.7188	21.00	10.14	31.14	46.00	-14.86	AVG	
5	1.4458	28.95	10.17	39.12	56.00	-16.88	QP	
6	1.4458	16.35	10.17	26.52	46.00	-19.48	AVG	
7	3.3540	25.72	10.23	35.95	56.00	-20.05	QP	
8	3.3540	14.93	10.23	25.16	46.00	-20.84	AVG	
9	11.3055	30.35	10.39	40.74	60.00	-19.26	QP	
10	11.3055	20.79	10.39	31.18	50.00	-18.82	AVG	
11	22.9875	32.66	10.53	43.19	60.00	-16.81	QP	
12	22.9875	10.33	10.53	20.86	50.00	-29.14	AVG	

Note: The worst Mode is Mode 1

## 7. Radiated Emissions

### 7.1 Block Diagram Of Test Setup

(A) Radiated Emission Test-Up Frequency Below 30MHz

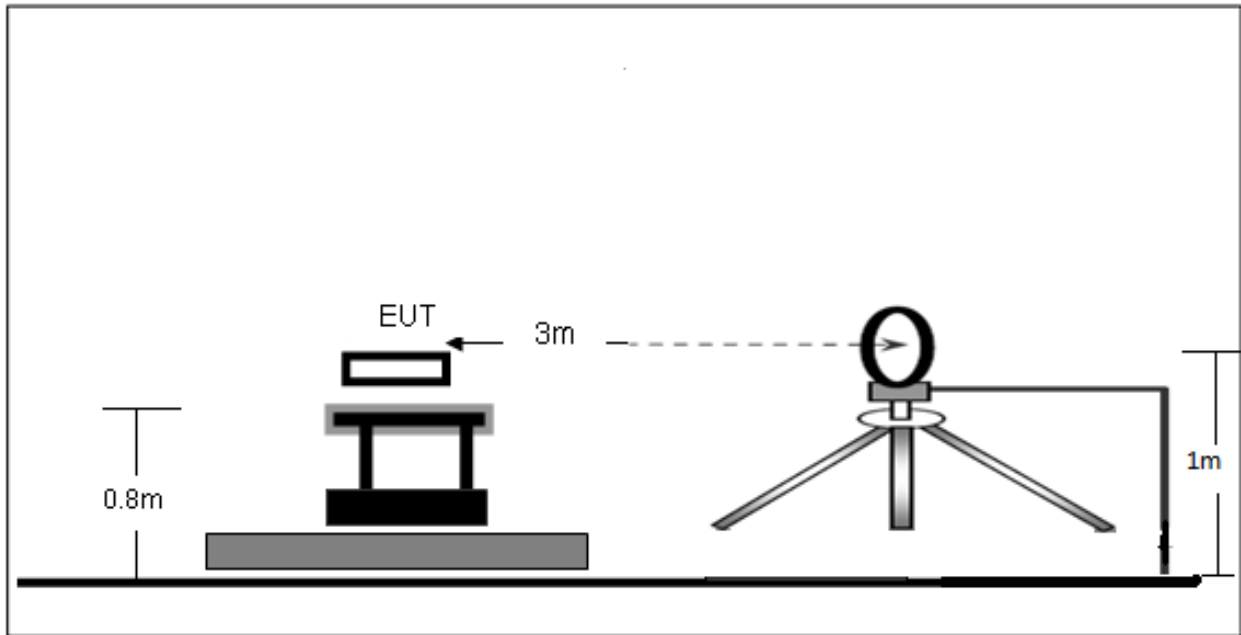

(B) Radiated Emission Test-Up Frequency 30MHz~1GHz

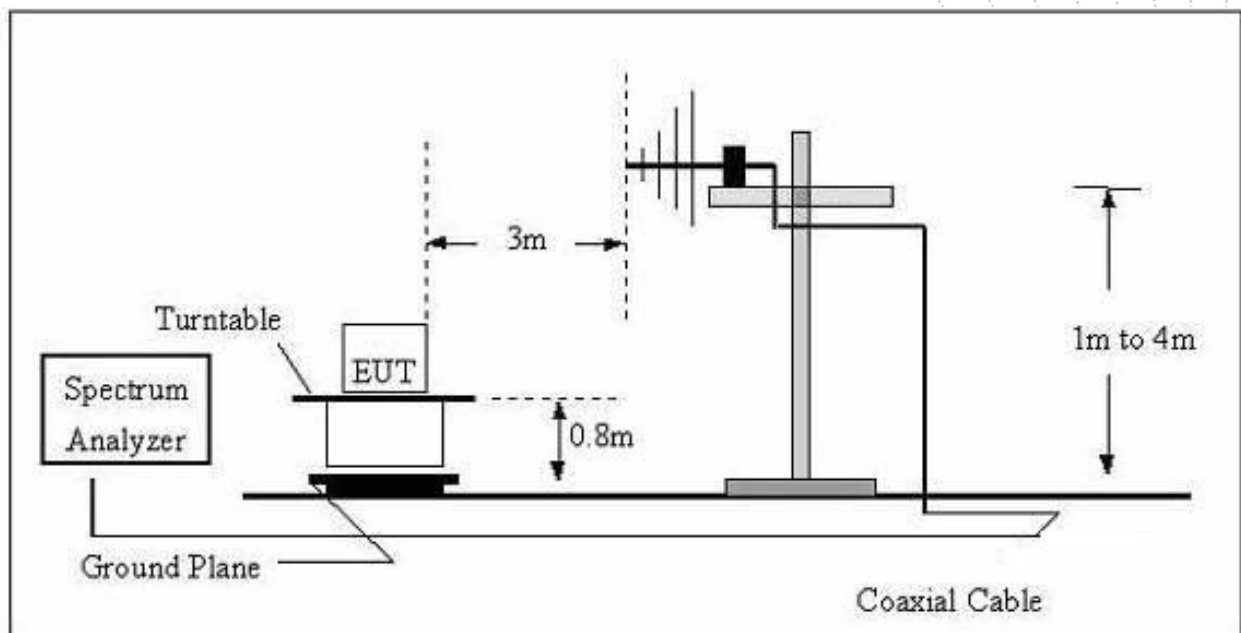

## 7.2 Limit

FCC §15.209; §15.205.

Frequency (MHz)	Field Strength uV/m	Distance (m)	Field Strength Limit at 3m Distance	
			uV/m	dBuV/m
0.009 ~ 0.490	2400/F(kHz)	300	10000 * 2400/F(kHz)	$20\log^{(2400/F(kHz))} + 80$
0.490 ~ 1.705	24000/F(kHz)	30	100 * 24000/F(kHz)	$20\log^{(24000/F(kHz))} + 40$
1.705 ~ 30	30	30	100 * 30	$20\log^{(30)} + 40$
30 ~ 88	100	3	100	$20\log^{(100)}$
88 ~ 216	150	3	150	$20\log^{(150)}$
216 ~ 960	200	3	200	$20\log^{(200)}$
Above 960	500	3	500	$20\log^{(500)}$

## 7.3 Test Procedure

Receiver Parameter	Setting
Attenuation	Auto
9kHz~150kHz	RBW 200Hz for QP
150kHz~30MHz	RBW 9kHz for QP
30MHz~1000MHz	RBW 120kHz for QP

Below 1GHz test procedure as below:

- The EUT was placed on the top of a rotating table 0.8 meters above the ground at a 3 meter semi-anechoic chamber. The table was rotated 360 degrees to determine the position of the highest radiation.
- The EUT was set 3 meters away from the interference-receiving antenna, which was mounted on the top of a variable-height antenna tower.
- The antenna height is varied from one meter to four meters above the ground to determine the maximum value of the field strength. Both horizontal and vertical polarizations of the antenna are set to make the measurement.
- For each suspected emission, the EUT was arranged to its worst case and then the antenna was tuned to heights from 1 meter to 4 meters (for the test frequency of below 30MHz, the antenna was tuned to heights 1 meter) and the rotatable table was turned from 0 degrees to 360 degrees to find the maximum reading.
- The test-receiver system was set to Peak Detect Function and Specified Bandwidth with Maximum Hold Mode.
- If the emission level of the EUT in peak mode was 10dB lower than the limit specified, then testing could be stopped and the peak values of the EUT would be reported. Otherwise the emissions that did not have 10dB margin would be re-tested one by one using peak, quasi-peak or average method as specified and then reported in a data sheet.
- Different between above is the test site, change from Semi- Anechoic Chamber to fully Anechoic Chamber and change form table 0.8 metre to 1.5 metre( Above 18GHz the distance is 1 meter and table is 1.5 metre).
- Test the EUT in the lowest channel ,the middle channel ,the Highest channel.



## 7.4 Test Result

Below 30MHz

Temperature:	26°C	Relative Humidity:	54%
Pressure:	101 kpa	Test Voltage :	AC 120V/60Hz
Test Mode :	Mode 4	Polarization:	Perpendicular

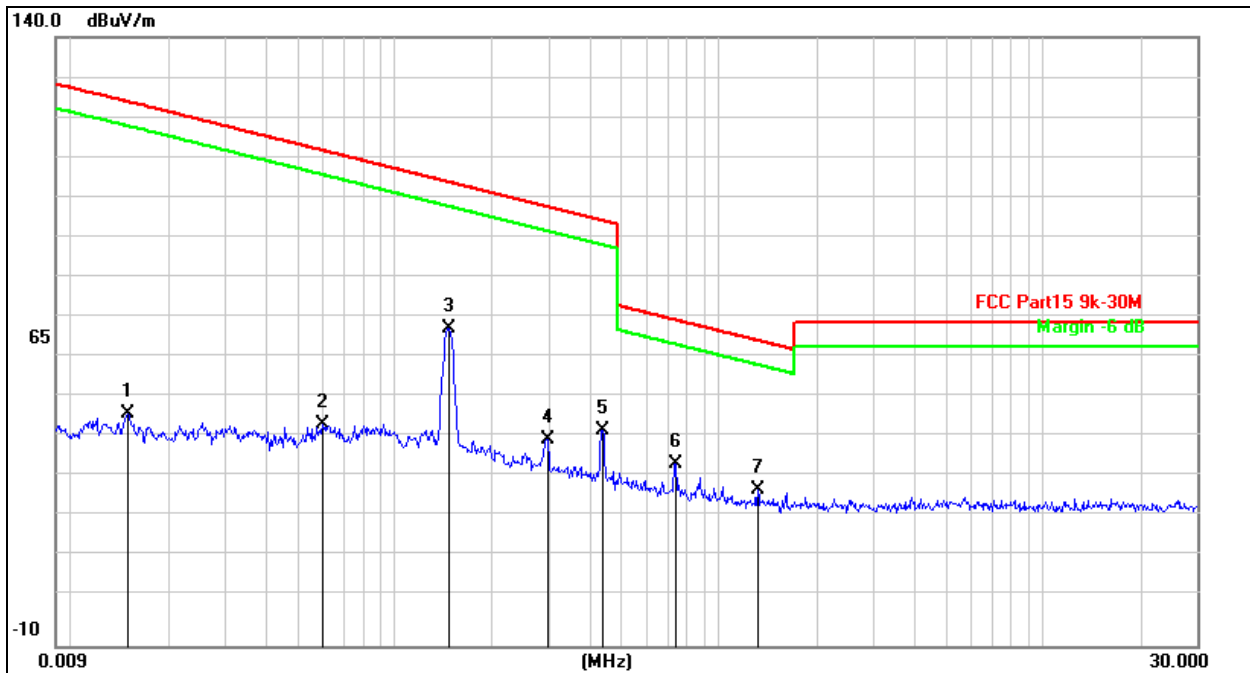

Remark:

1. Factor = Antenna Factor + Cable Loss – Pre-amplifier.
2. Measurement=Reading Level+ Correct Factor
3. Over=Measurement-Limit

No.	Mk.	Freq.	Reading Level	Correct Factor	Measurement	Limit	Over	Antenna Height	Table Degree	
		MHz	dBuV	dB	dBuV/m	dB/m	dB	cm	degree	Comment
1		0.0150	57.75	-10.55	47.20	124.0	-76.88			peak
2		0.0601	55.14	-10.61	44.53	112.0	-67.50			peak
3		0.1466	78.31	-10.02	68.29	104.2	-35.99			peak
4		0.2969	50.91	-10.28	40.63	98.15	-57.52			peak
5		0.4382	53.43	-10.27	43.16	94.77	-51.61			peak
6	*	0.7365	45.20	-10.25	34.95	70.27	-35.32			peak
7		1.3207	38.68	-10.21	28.47	65.21	-36.74			peak

Note: The worst Mode is Mode 4

Between 30MHz – 1GHz

Temperature:	26°C	Relative Humidity:	54%
Pressure:	101 kPa	Test Voltage:	AC 120V/60Hz
Test Mode:	Mode 4	Polarization:	Horizontal

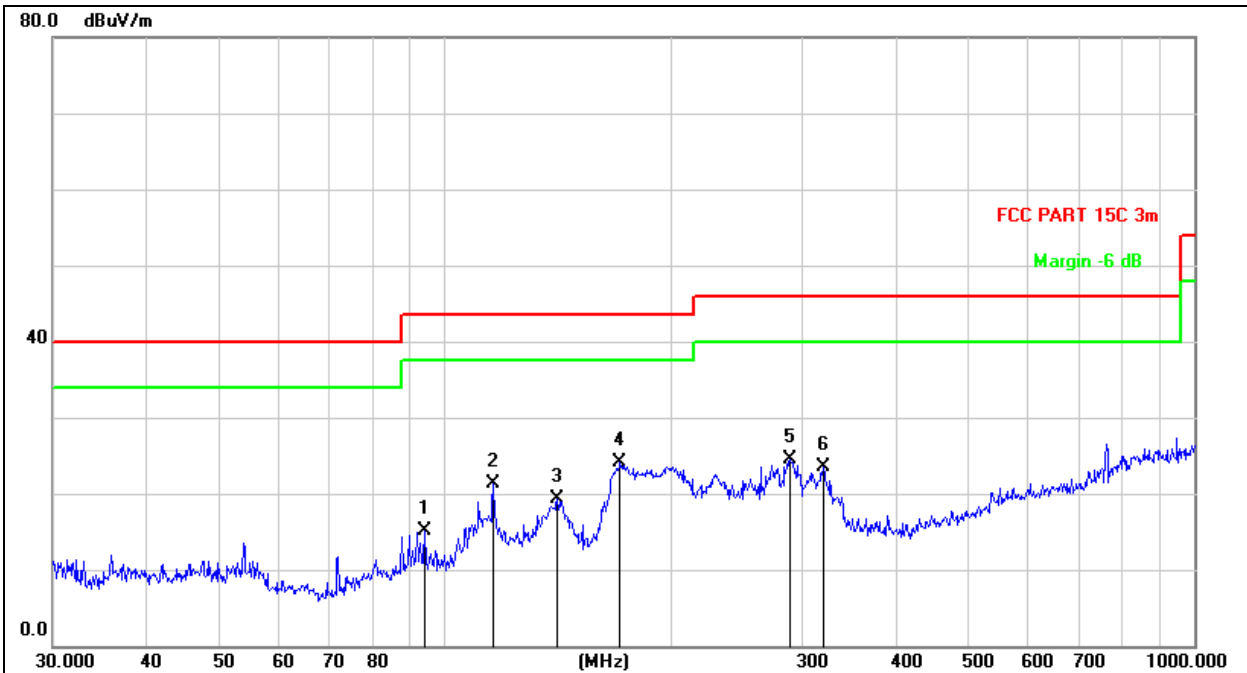

Remark:

1. Factor = Antenna Factor + Cable Loss – Pre-amplifier.
2. Measurement = Reading Level + Correct Factor
3. Over = Measurement - Limit

No. Mk.	Freq. MHz	Reading Level dBuV	Correct Factor dB	Measure- ment dBuV/m	Limit dB/m	Over dB	Detector	Antenna Height cm	Table Degree	Comment
1	94.0979	26.00	-10.84	15.16	43.50	-28.34	QP			
2	116.1321	29.86	-8.54	21.32	43.50	-22.18	QP			
3	141.3298	25.58	-6.33	19.25	43.50	-24.25	QP			
4 *	171.3926	31.24	-7.18	24.06	43.50	-19.44	QP			
5	289.0021	30.61	-6.02	24.59	46.00	-21.41	QP			
6	319.9370	28.58	-5.15	23.43	46.00	-22.57	QP			

Temperature:	26°C	Relative Humidity:	54%
Pressure:	101 kpa	Test Voltage :	AC 120V/60Hz
Test Mode:	Mode 4	Polarization:	Vertical

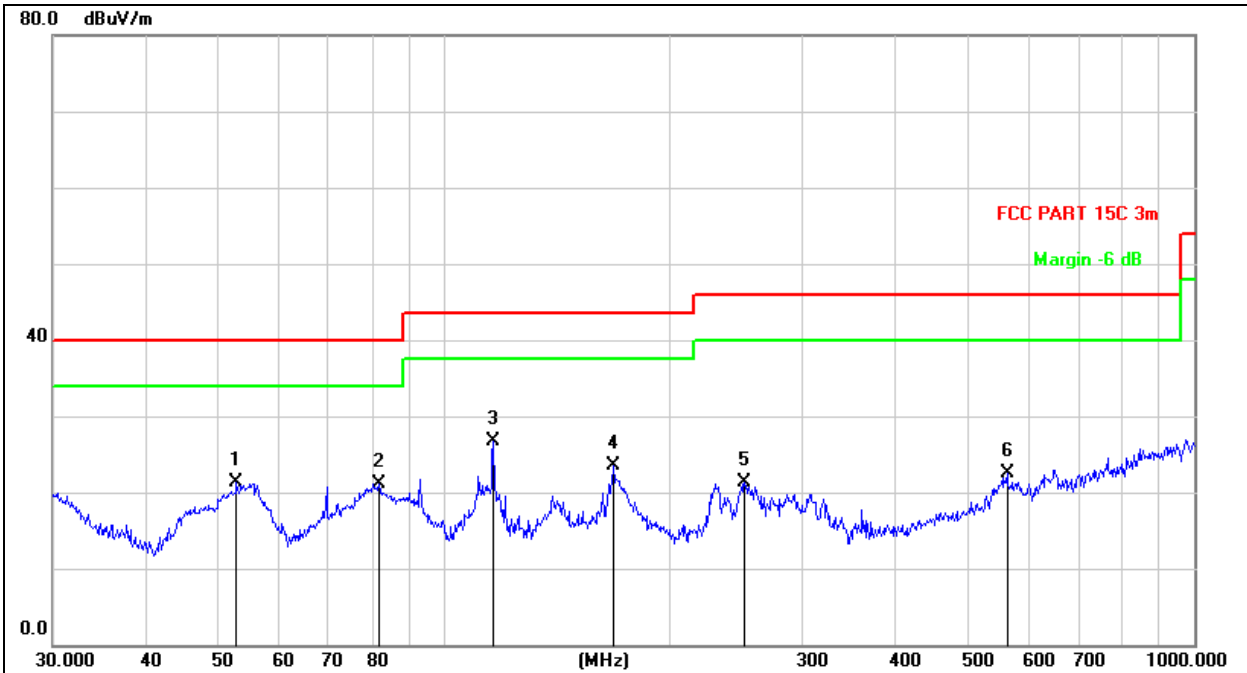
**Remark:**

1. Factor = Antenna Factor + Cable Loss – Pre-amplifier.
2. Measurement=Reading Level+ Correct Factor
3. Over=Measurement-Limit

No.	Mk.	Freq. MHz	Reading Level dBuV	Correct Factor dB	Measure- ment dBuV/m	Limit dB/m	Over dB	Detector
1		52.7600	30.53	-9.29	21.24	40.00	-18.76	QP
2		81.7833	32.70	-11.64	21.06	40.00	-18.94	QP
3	*	116.1321	35.31	-8.54	26.77	43.50	-16.73	QP
4		167.8243	30.34	-6.91	23.43	43.50	-20.07	QP
5		251.1804	28.64	-7.34	21.30	46.00	-24.70	QP
6		562.6624	21.85	0.67	22.52	46.00	-23.48	QP

Note: The worst Mode is Mode 4

## 8. Bandwidth Test

1. Set RBW = 1%~5% OBW.
2. Set the video bandwidth (VBW)  $\geq 3 \times$  RBW.
3. Detector = Peak.
4. Trace mode = max hold.
5. Sweep = auto couple.
6. Allow the trace to stabilize.
7. Measure the maximum width of the emission that is constrained by the frequencies associated with the two outermost amplitude points (upper and lower frequencies) that are attenuated by 20 dB relative to the maximum level measured in the fundamental emission.

### TEST SETUP

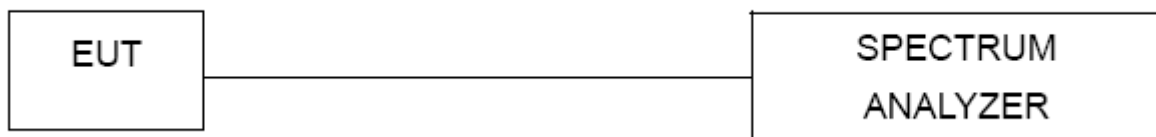

Temperature:	26 °C	Relative Humidity:	54%
Pressure:	101kPa		

Frequency (KHz)	20dB bandwidth (KHz)	Result
146.8	2.72	Pass

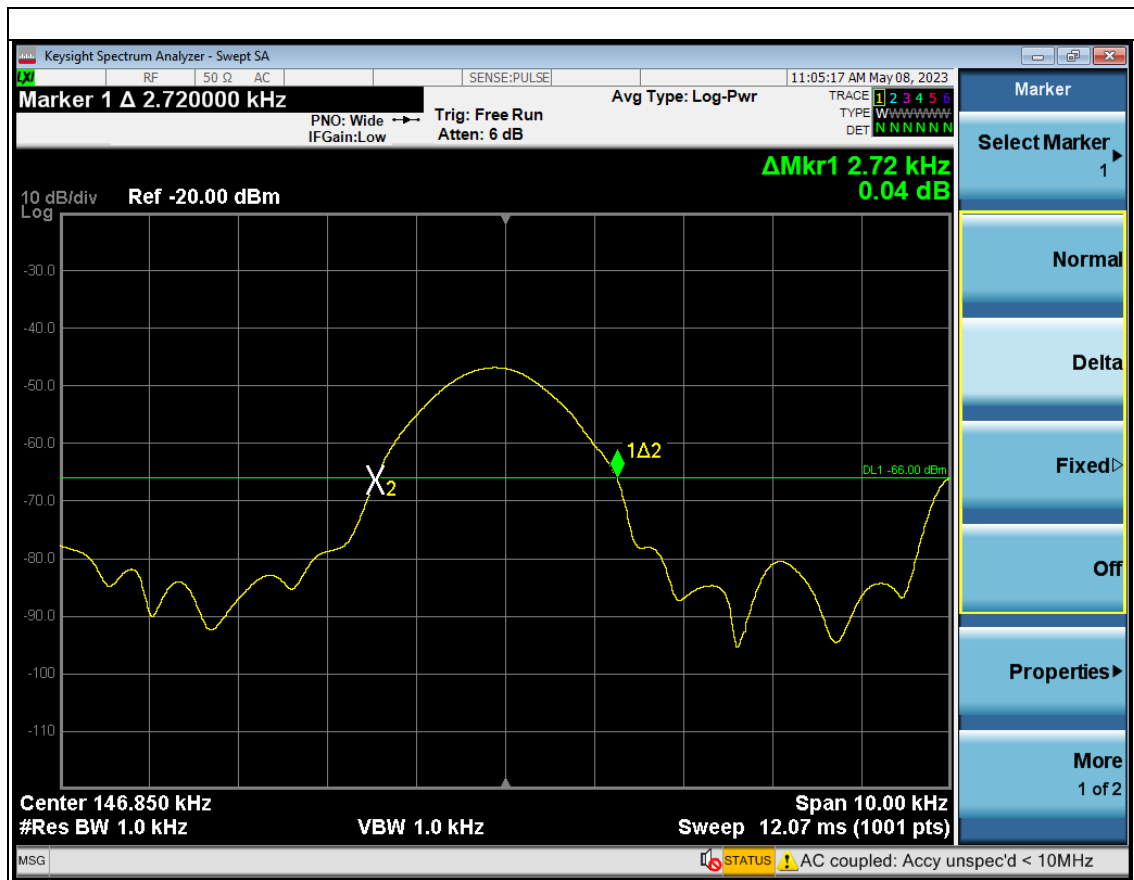

## 9. Antenna Requirements

For intentional device, according to FCC 47 CFR Section 15.203, An intentional radiator shall be designed to ensure that no antenna other than that furnished by the responsible party shall be used with the device. The use of a permanently attached antenna or of an antenna that uses a unique coupling to the intentional radiator shall be considered sufficient to comply with the provisions of this section. The manufacturer may design the unit so that a broken antenna can be replaced by the user, but the use of a standard antenna jack or electrical connector is prohibited. The antenna used for this product is Inductive loop coil antenna.

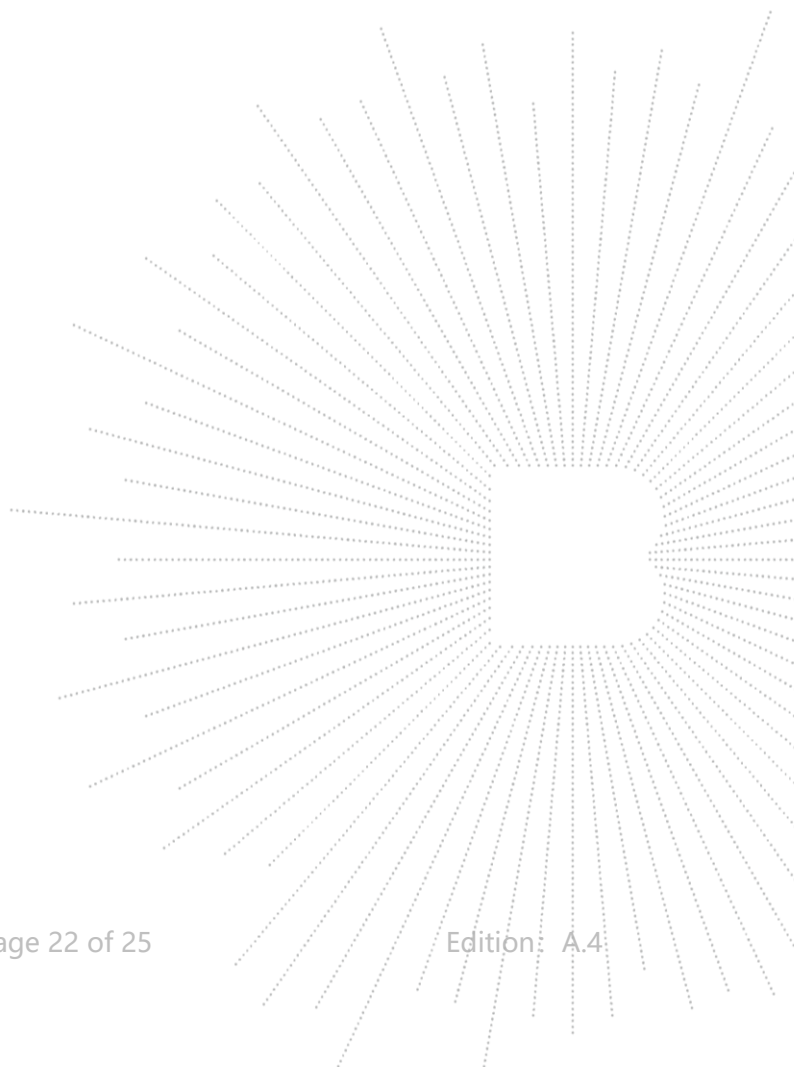

## 10. EUT Test Setup Photographs

### Conducted emissions



### Radiated Measurement Photos





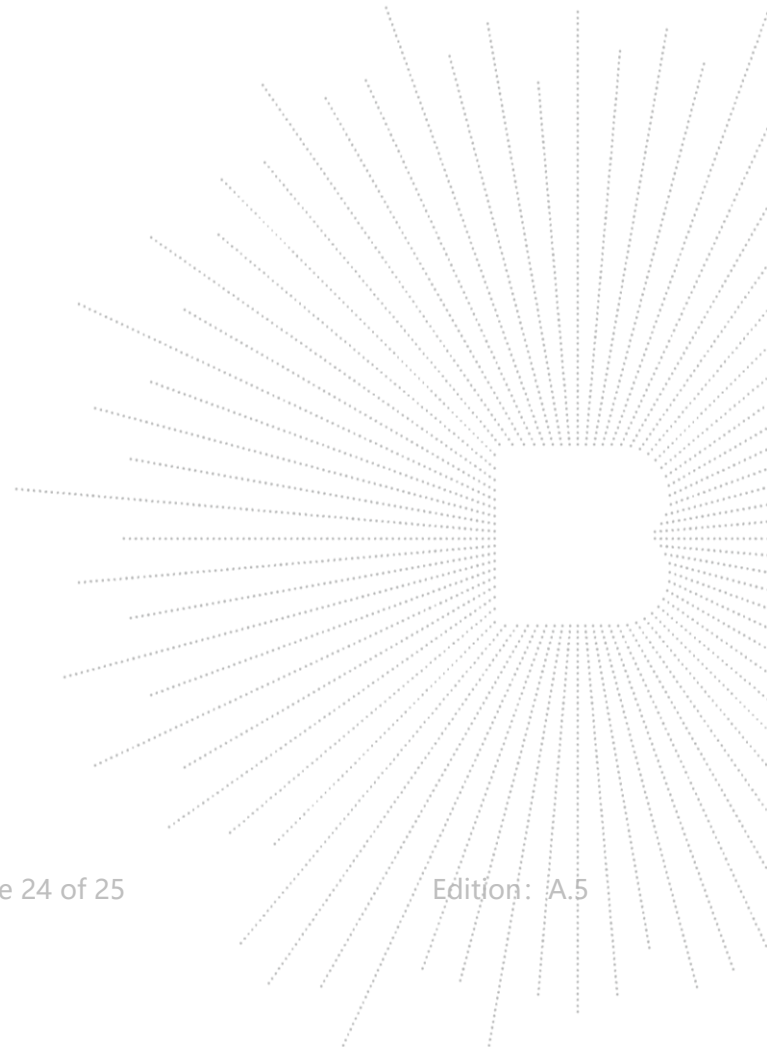
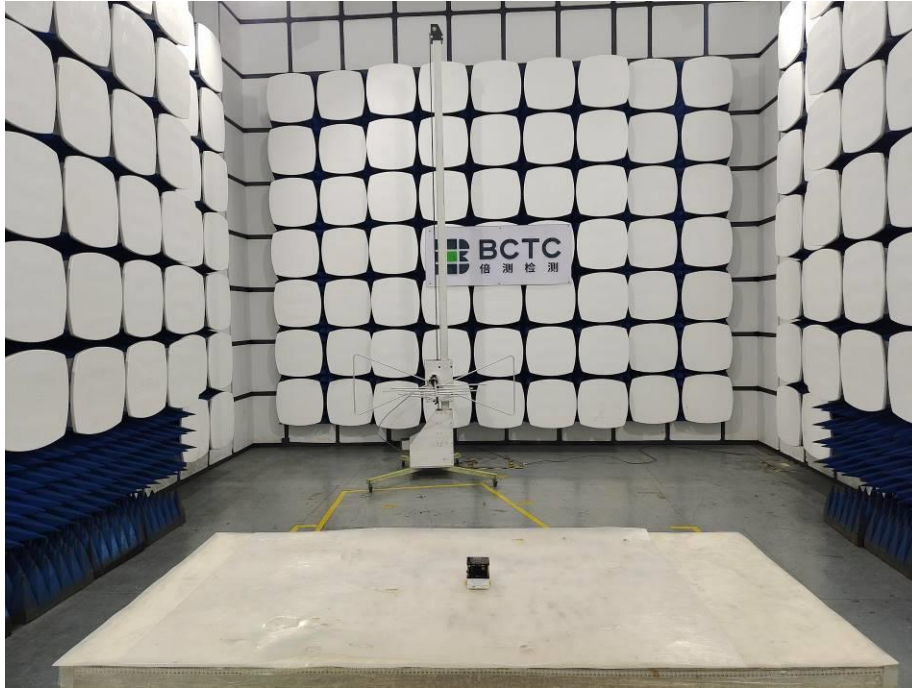



## STATEMENT

- 1.The equipment lists are traceable to the national reference standards.
- 2.The test report can not be partially copied unless prior written approval is issued from our lab.
- 3.The test report is invalid without stamp of laboratory.
- 4.The test report is invalid without signature of person(s) testing and authorizing.
- 5.The test process and test result is only related to the Unit Under Test.
- 6.The quality system of our laboratory is in accordance with ISO/IEC17025.
- 7.If there is any objection to report, the client should inform issuing laboratory within 15 days from the date of receiving test report.

Address:

1-2/F., Building B, Pengzhou Industrial Park, No.158, Fuyuan 1st Road, Tangwei, Fuhai Subdistrict, Bao'an District, Shenzhen, Guangdong, China

TEL:400-788-9558

P.C.: 518103

FAX:0755-33229357

Website:<http://www.chnbctc.com>

E-Mail:[bctc@bctc-lab.com.cn](mailto:bctc@bctc-lab.com.cn)

\*\*\*\*\* END \*\*\*\*\*

