



## FCC 47 CFR PART 15 SUBPART C

for

**e-Dice**

**Model: e-Dice**

**Brand: SCOSCHE**

**Test Report Number:**

**C130603Z06-RP1**

Issued for

**Scosche Industries Inc**

**1550 Pacific Ave, Oxnard, CA 93033, USA**

Issued by:

**Compliance Certification Services (Shenzhen) Inc.**

No.10-1, Mingkeda Logistics Park, No.18 Huanguan South Rd.,

Guan Lan Town, Baoan District, Shenzhen, China

TEL: 86-755-28055000

FAX: 86-755-28055221

Issued Date: August 20, 2013



TESTING CERT #2861.01

**Note:** *This report shall not be reproduced except in full, without the written approval of Compliance Certification Services Inc. This document may be altered or revised by Compliance Certification Services Inc. personnel only, and shall be noted in the revision section of the document. The client should not use it to claim product endorsement by TAF, A2LA, NVLAP, NIST or any government agencies. The test results in the report only apply to the tested sample.*



Revision History

Rev.	Issue No.	Revisions	Effect Page	Revised By
00	C130603Z06-RP1	Initial Issue	ALL	Sinphy Xie



**TABLE OF CONTENTS**

**1 TEST CERTIFICATION..... 4**

**2 TEST RESULT SUMMARY..... 5**

**3 EUT DESCRIPTION ..... 6**

**4 TEST METHODOLOGY ..... 7**

    4.1. DESCRIPTION OF TEST MODES ..... 7

**5 SETUP OF EQUIPMENT UNDER TEST..... 8**

    5.1. DESCRIPTION OF SUPPORT UNITS..... 8

    5.2. CONFIGURATION OF SYSTEM UNDER TEST ..... 8

**6 FACILITIES AND ACCREDITATIONS ..... 9**

    6.1. FACILITIES..... 9

    6.2. ACCREDITATIONS ..... 9

    6.3. MEASUREMENT UNCERTAINTY..... 9

**7 FCC PART 15.247 REQUIREMENTS..... 10**

    7.1. POWER LINE CONDUCTED EMISSIONS MEASUREMENT ..... 10

    7.2. SPURIOUS EMISSIONS MEASUREMENT..... 13

    7.3. 6dB BANDWIDTH MEASUREMENT ..... 26

    7.4. PEAK OUTPUT POWER ..... 29

    7.5. BAND EDGES MEASUREMENT..... 33

    7.6. PEAK POWER SPECTRAL DENSITY MEASUREMENT..... 39



# 1 TEST CERTIFICATION

<b>Product</b>	e-Dice
<b>Model</b>	e-Dice
<b>Brand</b>	SCOSCHE
<b>Tested</b>	June 3~ August 20, 2013
<b>Applicant</b>	<b>Scosche Industries Inc</b> 1550 Pacific Ave, Oxnard, CA 93033, USA
<b>Manufacturer</b>	<b>Sunitec Enterprise Co., Ltd</b> No.2, Qilin Road 2, RunTang Ind, Dan-Keng Village Fu Min Community, Guan-Lan Town, BaoAn District, Shenzhen Guangdong China

APPLICABLE STANDARDS			
Standard	Test Type	Standard	Test Type
15.207(a)	Power Line Conducted Emissions	15.247(d) 15.209(a)	<ul style="list-style-type: none"> <li>● Spurious Emissions</li> <li>● Conducted Measurement</li> <li>● Radiated Emissions</li> </ul>
15.247(a)(2)	6dB Bandwidth Measurement	15.247(b)(3) 15.247(b)(4)	Peak Power Measurement
15.247(d)	Band Edges Measurement	15.247(e)	Peak Power Spectral Density

### We hereby certify that:

The above equipment was tested by Compliance Certification Services Inc. The test data, data evaluation, test procedures, and equipment configurations shown in this report were made in accordance with the procedures given in **ANSI C63.4: 2009** and the energy emitted by the sample EUT tested as described in this report is in compliance with the requirements of FCC Rules Part 15.207, 15.209, 15.247.

The test results of this report relate only to the tested sample EUT identified in this report.

**Approved by:**

**Reviewed by:**

---

**Tom Gan**  
Supervisor of EMC Dept.  
Compliance Certification Service Inc.

---

**Ruby Zhang**  
Supervisor of Report Dept.  
Compliance Certification Service Inc.



## 2 TEST RESULT SUMMARY

APPLICABLE STANDARDS			
Standard	Test Type	Result	Remark
15.247(a)(2)	6dB Bandwidth Measurement	Pass	Meet the requirement of limit.
15.247(b)(3) 15.247(b)(4)	Peak Power Measurement	Pass	Meet the requirement of limit.
15.247(d)	Band Edges Measurement	Pass	Meet the requirement of limit.
15.247(e)	Peak Power Spectral Density	Pass	Meet the requirement of limit.
15.247(d) 15.209(a)	<ul style="list-style-type: none"><li>● Spurious Emissions</li><li>● Conducted Measurement</li><li>● Radiated Emissions</li></ul>	Pass	Meet the requirement of limit.
15.207(a)	Power line Conducted Emissions	N/A	Not applicable, since the EUT powered by the Coin battery.

Note: 1. The statements of test result on the above are decided by the request of test standard only; the measurement uncertainties are not factored into this compliance determination.  
2. The information of measurement uncertainty is available upon the customer's request.



### 3 EUT DESCRIPTION

<b>Product</b>	e-Dice
<b>Model</b>	e-Dice
<b>Brand</b>	SCOSCHE
<b>Model Discrepancy</b>	N/A
<b>Identify Number</b>	C130603Z06-RP1
<b>Received Date</b>	June 3, 2013
<b>Power Supply</b>	DC3.0V supplied by the Coin battery
<b>Frequency Range</b>	2402-2480 MHz
<b>Transmit Power</b>	-2.88dBm
<b>Modulation Technique</b>	GFSK for 1Mbps
<b>Number of Channels</b>	40 Channels
<b>Antenna Specification</b>	Multilayer Ceramic Antenna with 0dBi gain (Max)
<b>Temperature Range</b>	-20°C ~+70°C

**Note:** 1. The sample selected for test was engineering sample that approximated to production product and was provided by manufacturer.

2. This submittal(s) (test report) is intended for FCC ID: IKQBLEDIE filing to comply with Section 15.207, 15.209 and 15.247 of the FCC Part 15, Subpart C Rules.



## 4 TEST METHODOLOGY

### 4.1. DESCRIPTION OF TEST MODES

The EUT has been tested under operating condition.

Software used to control the EUT for staying in continuous transmitting and receiving mode is programmed.

Test Item	Test mode	Worse mode
Conducted Emission	Not applicable, since the EUT powered by the Coin battery.	<input type="checkbox"/>
Radiated Emission	<b>Mode 1: TX</b>	<input checked="" type="checkbox"/>

After verification, all tests were carried out with the worst case test modes as shown below except radiated spurious emission below 1GHz, which worst case was in normal link mode only.



## **5 SETUP OF EQUIPMENT UNDER TEST**

### **5.1. DESCRIPTION OF SUPPORT UNITS**

The EUT has been tested as an independent unit together with other necessary accessories or support units. The following support units or accessories were used to form a representative test configuration during the tests.

<b>No.</b>	<b>Equipment</b>	<b>Model No.</b>	<b>Serial No.</b>	<b>FCC ID</b>	<b>Brand</b>	<b>Data Cable</b>	<b>Power Cord</b>
1	Notebook	PP24L	R349CA00	N/A	DELL	Unshielded 1.50m	Unshielded 1.80m

**Note:**

Grounding was established in accordance with the manufacturer’s requirements and conditions for the intended use.

### **5.2. CONFIGURATION OF SYSTEM UNDER TEST**

See test photographs attached in Appendix II for the actual connections between EUT and support equipment.





## 6 FACILITIES AND ACCREDITATIONS

### 6.1. FACILITIES

All measurement facilities used to collect the measurement data are located at **No. 10-1, Mingkeda Logistics Park, No.18 Huanguan South RD. Guan Lan Town, Baoan District, Shenzhen China**

The sites are constructed in conformance with the requirements of ANSI C63.4, ANSI C63.7 and CISPR Publication 22. All receiving equipment conforms to CISPR Publication 16-1, "Radio Interference Measuring Apparatus and Measurement Methods."

### 6.2. ACCREDITATIONS

Our laboratories are accredited and approved by the following accreditation body according to ISO/IEC 17025.

<b>USA</b>	<b>A2LA</b>
<b>China</b>	<b>CNAS</b>

The measuring facility of laboratories has been authorized or registered by the following approval agencies.

<b>USA</b>	<b>FCC</b>
<b>Japan</b>	<b>VCCI(C-3478, R-3135, T-652, G-624)</b>
<b>Canada</b>	<b>INDUSTRY CANADA</b>
<b>Taiwan</b>	<b>BSMI</b>
<b>Norway</b>	<b>Nemko</b>

Copies of granted accreditation certificates are available for downloading from our web site, <http://www.ccsrf.com>

### 6.3. MEASUREMENT UNCERTAINTY

Where relevant, the following measurement uncertainty levels have been estimated for tests performed on the EUT as specified in CISPR 16-4-2:

<b>Parameter</b>	<b>Uncertainty</b>
Radiated Emission, 30 to 200 MHz Test Site : 966(2)	+/-3.6880dB
Radiated Emission, 200 to 1000 MHz Test Site : 966(2)	+/-3.6695dB
Radiated Emission, 1 to 8 GHz	+/-5.1782dB
Radiated Emission, 8 to 18 GHz	+/-5.2173dB
Conducted Emissions	+/-3.6836dB
Band Width	178kHz
Peak Output Power MU	+/-1.906dB
Band Edge MU	+/-0.182dB
Channel Separation MU	416.178Hz
Duty Cycle MU	0.054ms
Frequency Stability MU	226Hz

This uncertainty represents an expanded uncertainty expressed at approximately the 95% confidence level using a coverage factor of k=2.

The measured result is above (below) the specification limit by a margin less than the measurement uncertainty; it is therefore not possible to state compliance based on the 95% level of confidence. However, the result indicates that compliance (non-compliance) is more probable than non-compliance) with the specification limit.



## 7 FCC PART 15.247 REQUIREMENTS

### 7.1. POWER LINE CONDUCTED EMISSIONS MEASUREMENT

#### 7.1.1. LIMITS OF CONDUCTED EMISSIONS MEASUREMENT

According to §15.207(a), except as shown in paragraphs (b) and (c) of this section, for an intentional radiator that is designed to be connected to the public utility (AC) power line, the radio frequency voltage that is conducted back onto the AC power line on any frequency or frequencies within the band 150 kHz to 30 MHz shall not exceed the limits in the following table, as measured using a 50 μH/50 ohms line impedance stabilization network (LISN). Compliance with the provisions of this paragraph shall be based on the measurement of the radio frequency voltage between each power line and ground at the power terminal. The lower limit applies at the boundary between the frequency ranges.

Frequency Range (MHz)	Limits (dBμV)	
	Quasi-peak	Average
0.15 to 0.50	66 to 56*	56 to 46*
0.50 to 5	56	46
5 to 30	60	50

**NOTE:**

- (1) The lower limit shall apply at the transition frequencies.
- (2) The limit decreases in line with the logarithm of the frequency in the range of 0.15 to 0.50 MHz.
- (3) All emanations from a class A/B digital device or system, including any network of conductors and apparatus connected thereto, shall not exceed the level of field strengths specified above.

#### 7.1.2. TEST INSTRUMENTS

Conducted Emission Test Site					
Name of Equipment	Manufacturer	Model Number	Serial Number	Last Calibration	Due Calibration
ESCI EMI TEST RECEIVER.ESCI	ROHDE&SCHWARZ	ESCI	100783	03/09/2013	03/08/2014
LISN(EUT)	ROHDE&SCHWARZ	ENV216	101543-WX	04/20/2013	04/19/2014
LISN	EMCO	3825/2	8901-1459	03/09/2013	03/08/2014
Temp. / Humidity Meter	VICTOR	HTC-1	N/A	03/04/2013	03/03/2014
Test S/W	FARAD	EZ-EMC/ CCS-3A1-CE			

- NOTE:**
- 1. The calibration interval of the above test instruments is 12 months and the calibrations are traceable to NML/ROC and NIST/USA.
  - 2. N.C.R = No Calibration Request.



**7.1.3. TEST PROCEDURES** (please refer to measurement standard)

- The EUT and Support equipment, if needed, was placed on a non-conducted table, which is 0.8m above the ground plane and 0.4m away from the conducted wall.
- The test equipment EUT installed received AC main power, through a Line Impedance Stabilization Network (LISN), which supplied power source and was grounded to the ground plane. All support equipment power received from a second LISN. The two LISNs provide 50 ohm/ 50uH of coupling impedance for the measuring instrument.
- The EUT test program was started. Emissions were measured on each current carrying line of the EUT using an EMI Test Receiver connected to the LISN powering the EUT.
- The frequency range from 150 kHz to 30 MHz was searched. The test data of the worst-case condition(s) was recorded. Emission levels under limit 20dB were not recorded.



7.1.4. TEST SETUP

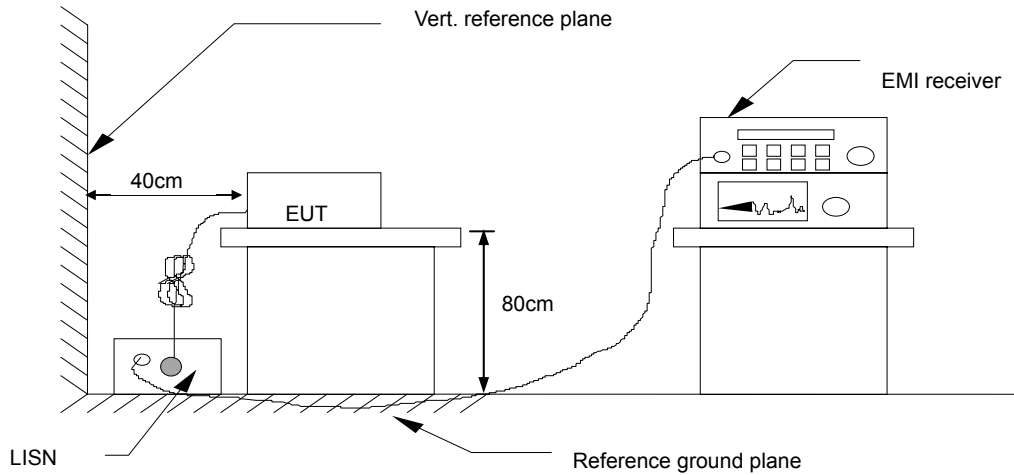

For the actual test configuration, please refer to the related item - Photographs of the Test Configuration.

7.1.5. DATA SAMPLE

Frequency (MHz)	QuasiPeak Reading (dBuV)	Average Reading (dBuV)	Correction Factor (dB)	QuasiPeak Result (dBuV)	Average Result (dBuV)	QuasiPeak Limit (dBuV)	Average Limit (dBuV)	QuasiPeak Margin (dB)	Average Margin (dB)	Remark (Pass/Fail)
X.XXXX	34.99	19.33	10.15	45.14	29.48	65.99	56.00	-20.85	-26.52	Pass

- Factor = Insertion loss of LISN + Cable Loss
- Result = Quasi-peak Reading/ Average Reading + Factor
- Limit = Limit stated in standard
- Margin = Result (dBuV) – Limit (dBuV)

7.1.6. TEST RESULTS

Not applicable, since the EUT powered by the Coin battery.



## **7.2. SPURIOUS EMISSIONS MEASUREMENT**

### **7.2.1. LIMITS OF CONDUCTED EMISSIONS MEASUREMENT**

According to §15.247(d), in any 100 kHz bandwidth outside the frequency bands in which the spread spectrum intentional radiator is operating, the radio frequency power that is produced by the intentional radiator shall be at least 20 dB below that in the 100 kHz bandwidth within the band that contains the highest level of the desired power, based on either an RF conducted or a radiated measurement, provided the transmitter demonstrates compliance with the peak conducted power limits. In addition, radiated emissions which fall in the restricted bands, as defined in §15.205(a), must also comply with the radiated emission limits specified in 15.209(a) (see Section 15.205(c)).

### **7.2.2. TEST INSTRUMENTS**

<b>Name of Equipment</b>	<b>Manufacturer</b>	<b>Model</b>	<b>Serial Number</b>	<b>Last Calibration</b>	<b>Due Calibration</b>
Spectrum Analyzer	Agilent	E4446A	US44300399	03/09/2013	03/08/2014

### **7.2.3. TEST PROCEDURE** (please refer to measurement standard)

Conducted RF measurements of the transmitter output were made to confirm that the EUT antenna port conducted emissions meet the specified limit and to identify any spurious signals that require further investigation or measurements on the radiated emissions site.

The transmitter output is connected to the spectrum analyzer. The resolution bandwidth is set to 100 kHz. The video bandwidth is set to 300 kHz.

Measurements are made over the 30MHz to 26.5GHz range with the transmitter set to the lowest, middle, and highest channels.



7.2.4. TEST RESULTS

Test Plot

CH Low (30MHz ~26.5GHz)

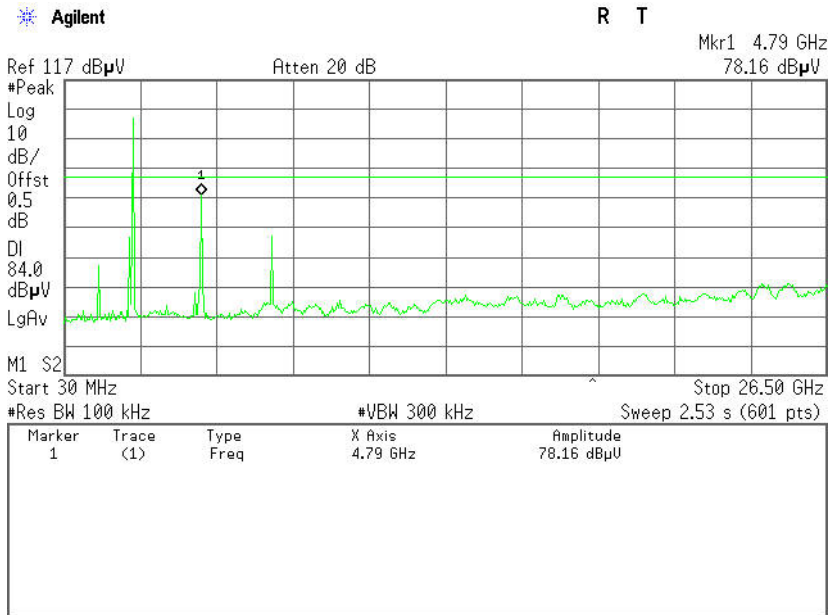

CH Low (2.31GHz ~2.41GHz)

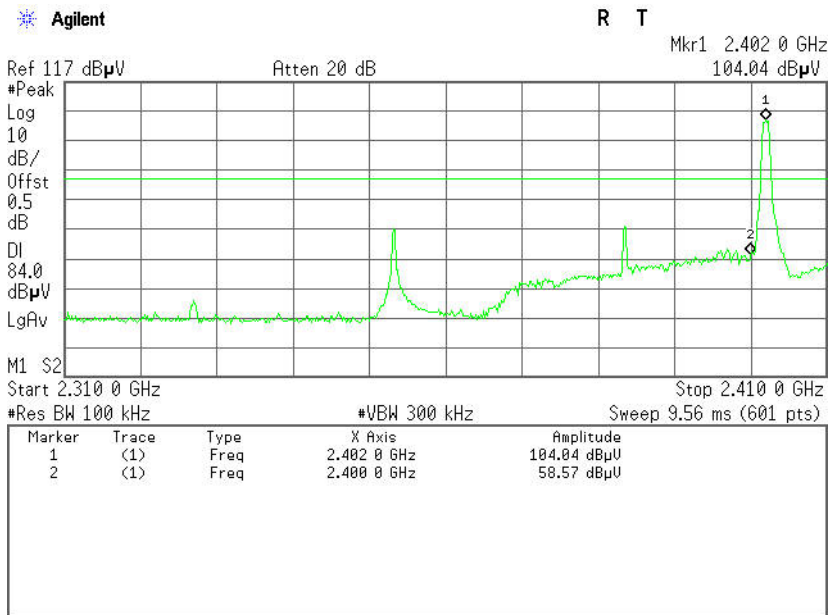



CH Mid (30MHz ~26.5GHz)

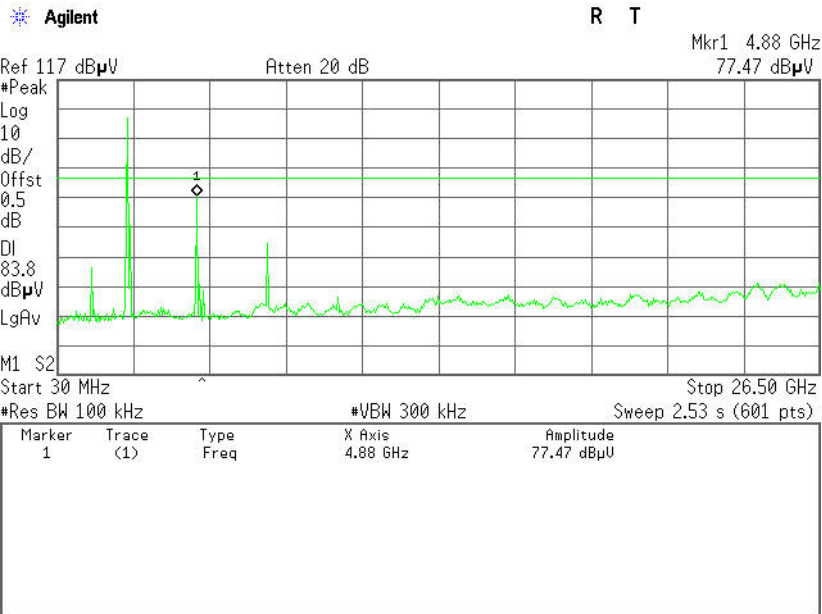



### CH High (30MHz ~26.5GHz)

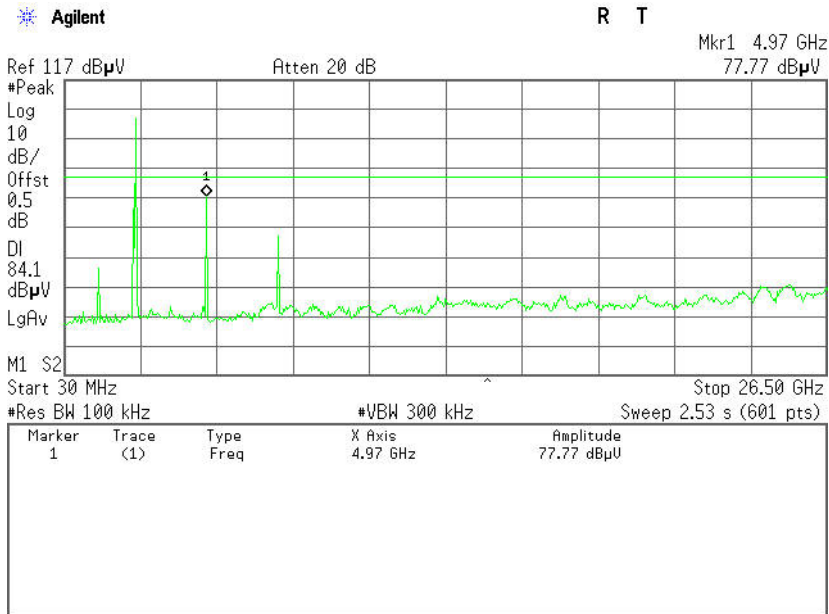

### CH High( 2.475GHz ~2.5GHz)

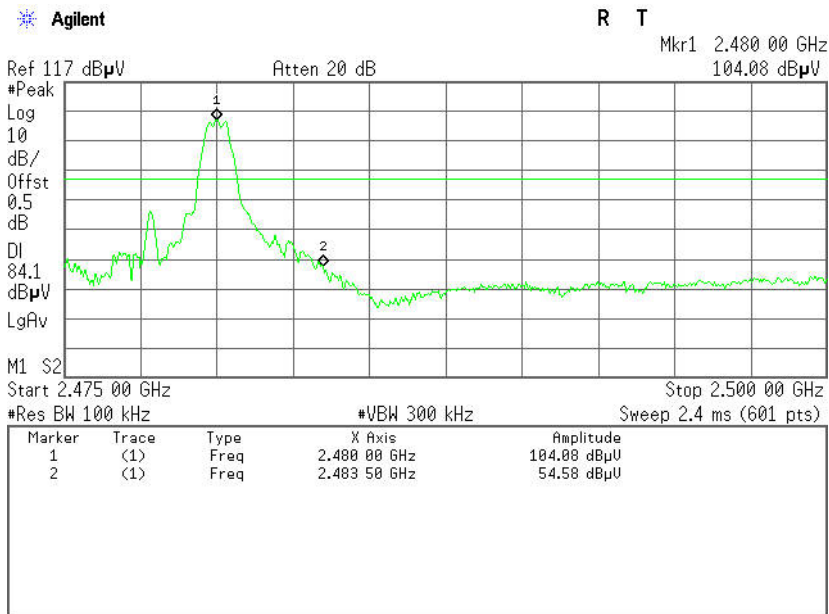





7.2.4.1. LIMITS OF RADIATED EMISSIONS MEASUREMENT

According to §15.209(a), except as provided elsewhere in this Subpart, the emissions from an intentional radiator shall not exceed the field strength levels specified in the following table:

Frequency (MHz)	Field Strength (mV/m)	Measurement Distance (m)
0.009-0.490	2400/F(kHz)	300
0.490-1.705	24000/F(kHz)	30
1.705-30.0	30	30
30-88	100*	3
88-216	150*	3
216-960	200*	3
Above 960	500	3

Remark: Except as provided in paragraph (g), fundamental emissions from intentional radiators operating under this Section shall not be located in the frequency bands 54-72 MHz, 76-88 MHz, 174-216 MHz or 470-806 MHz. However, operation within these frequency bands is permitted under other sections of this Part, e.g., Sections 15.231 and 15.241.

1. In the emission table above, the tighter limit applies at the band edges.

Frequency (MHz)	Field Strength (µV/m at 3-meter)	Field Strength (dBµV/m at 3-meter)
30-88	100	40
88-216	150	43.5
216-960	200	46
Above 960	500	54

NOTE: (1) The lower limit shall apply at the transition frequencies.  
(2) Emission level (dBuV/m) = 20 log Emission level (uV/m).



**7.2.4.2. TEST INSTRUMENTS**

<b>Radiated Emission Test Site 966(2)</b>					
<b>Name of Equipment</b>	<b>Manufacturer</b>	<b>Model Number</b>	<b>Serial Number</b>	<b>Last Calibration</b>	<b>Due Calibration</b>
PSA Series Spectrum Analyzer	Agilent	E4446A	US44300399	03/09/2013	03/08/2014
EMI TEST RECEIVER	ROHDE&SCHWARZ	ESCI	100783	03/09/2013	03/08/2014
Amplifier	MITEQ	AM-1604-3000	1123808	03/18/2013	03/18/2014
High Noise Amplifier	Agilent	8449B	3008A01838	03/18/2013	03/18/2014
Board-Band Horn Antenna	Schwarzbeck	BBHA 9170	9170-497	06/21/2013	06/21/2014
Bilog Antenna	SCHAFFNER	CBL6143	5082	03/02/2013	03/01/2014
Horn Antenna	SCHWARZBECK	BBHA9120	D286	03/02/2013	03/01/2014
Loop Antenna	A、R、A	PLA-1030/B	1029	03/23/2013	03/23/2014
Turn Table	N/A	N/A	N/A	N.C.R	N.C.R
Controller	Sunol Sciences	SC104V	022310-1	N.C.R	N.C.R
Controller	CT	N/A	N/A	N.C.R	N.C.R
Temp. / Humidity Meter	Anymetre	JR913	N/A	03/04/2013	03/03/2014
Test S/W	FARAD	LZ-RF / CCS-SZ-3A2			

- NOTE:**
1. The calibration interval of the above test instruments is 12 months and the calibrations are traceable to NML/ROC and NIST/USA.
  2. The FCC Site Registration number is 101879.
  3. N.C.R = No Calibration Required.

**7.2.4.3. TEST PROCEDURE (please refer to measurement standard)**

1. The EUT is placed on a turntable, which is 0.8m above ground plane.
2. The turntable shall be rotated for 360 degrees to determine the position of maximum emission level.
3. EUT is set 3m away from the receiving antenna, which is varied from 1m to 4m to find out the highest emissions.
4. Maximum procedure was performed on the six highest emissions to ensure EUT compliance.
5. And also, each emission was to be maximized by changing the polarization of receiving antenna both horizontal and vertical.
6. Set the spectrum analyzer in the following setting as:
  - Below 1GHz:
    - RBW=100kHz / VBW=300kHz / Sweep=AUTO
  - Above 1GHz:
    - (a) PEAK: RBW=VBW=1MHz / 3 MHz / Sweep=AUTO
    - (b) AVERAGE: RBW=1MHz / VBW=10Hz / Sweep=AUTO
7. Repeat above procedures until the measurements for all frequencies are complete.



7.2.4.4. TEST SETUP

Below 30MHz

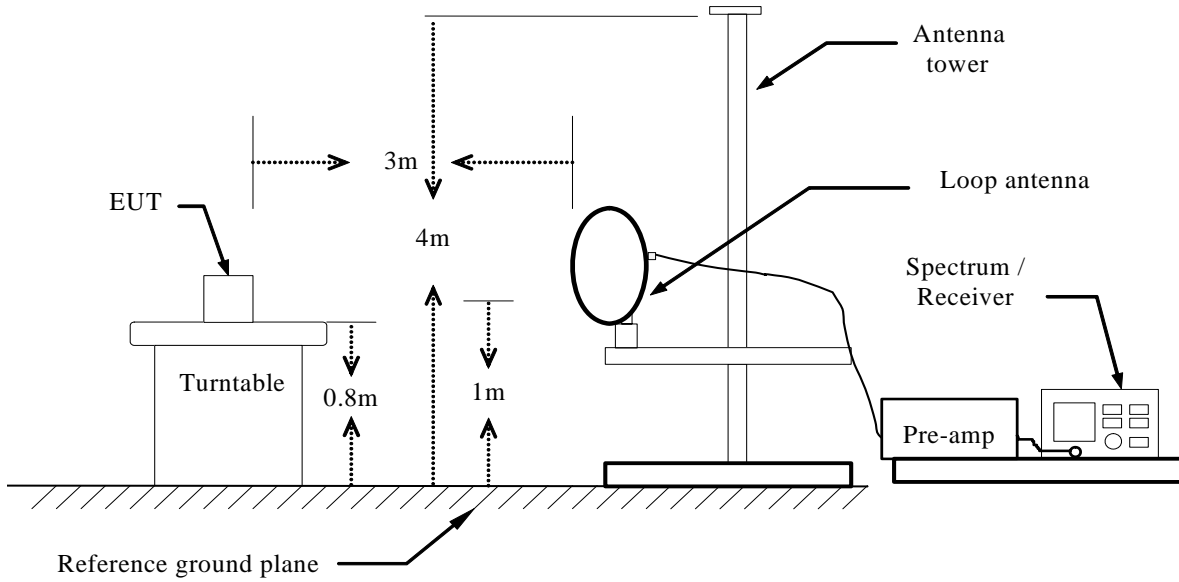

Below 1 GHz

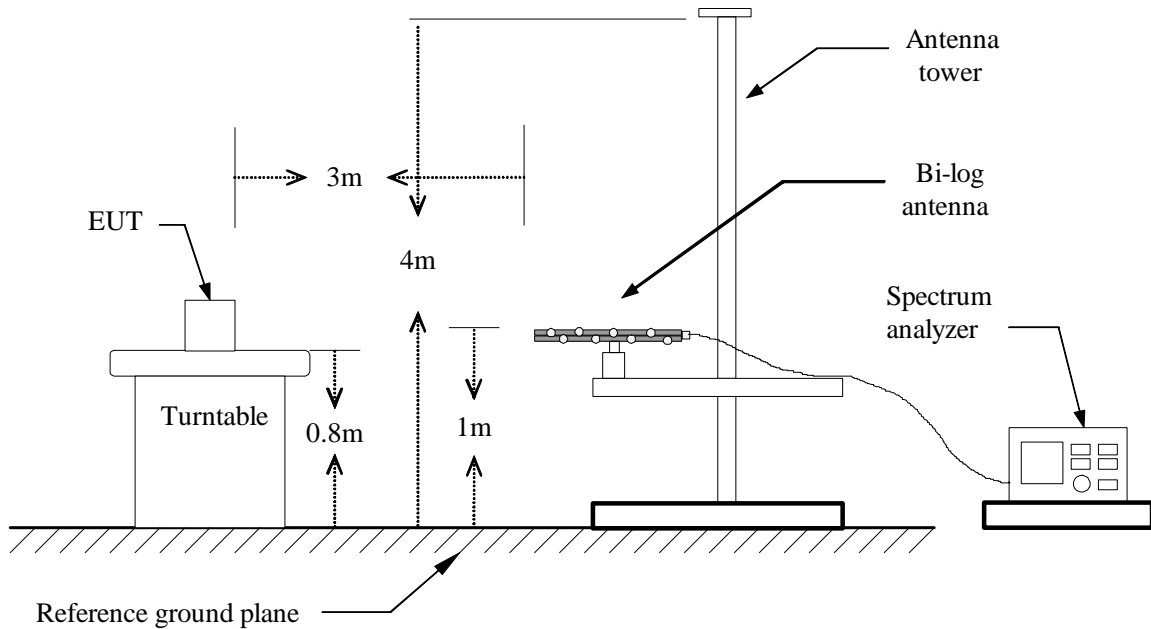



Above 1 GHz

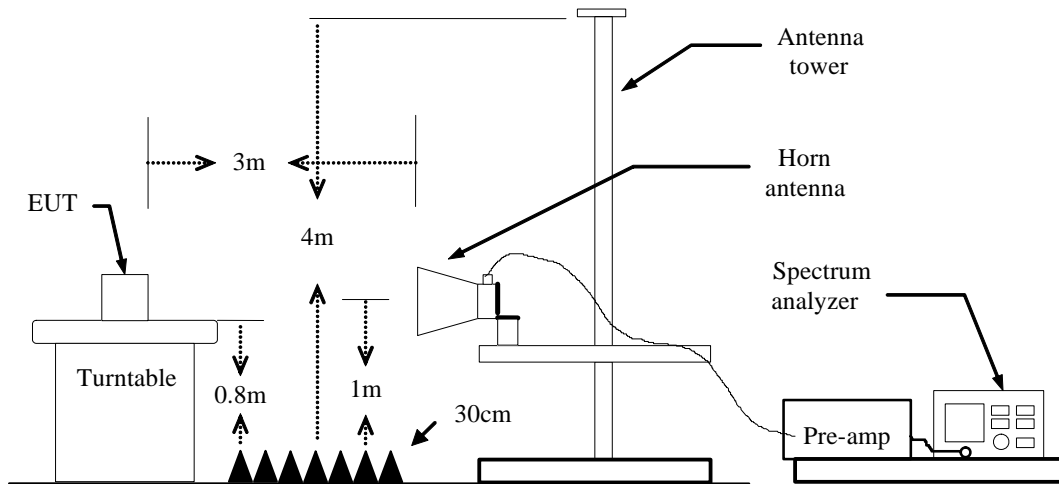

For the actual test configuration, please refer to the related item – Photographs of the Test Configuration.



7.2.4.5. DATA SAMPLE

Below 1GHz

Frequency (MHz)	Reading (dBuV)	Correct Factor (dB/m)	Result (dBuV/m)	Limit (dBuV/m)	Margin (dB)	Antenna Pole (V/H)	Remark
XXX.XXXX	53.41	-18.63	34.78	43.50	-8.72	V	QP

Frequency (MHz) = Emission frequency in MHz  
 Reading (dBuV) = Uncorrected Analyzer / Receiver reading  
 Correct Factor (dB/m) = Antenna factor + Cable loss – Amplifier gain  
 Result (dBuV/m) = Reading (dBuV) + Corr. Factor (dB/m)  
 Limit (dBuV/m) = Limit stated in standard  
 Margin (dB) = Result (dBuV/m) – Limit (dBuV/m)  
 Q.P. = Quasi-peak Reading

Above 1GHz

Frequency (MHz)	Reading (dBuV)	Correction Factor (dB/m)	Result (dBuV/m)	Limit (dBuV/m)	Margin (dB)	Antenna Pole (V/H)	Remark
XXXX.XXXX	62.09	-11.42	50.67	74.00	-23.33	V	Peak
XXXX.XXXX	49.78	-11.42	38.36	54.00	-15.64	V	AVG

Frequency (MHz) = Emission frequency in MHz  
 Reading (dBuV) = Uncorrected Analyzer / Receiver reading  
 Correction Factor (dB/m) = Antenna factor + Cable loss – Amplifier gain  
 Result (dBuV/m) = Reading (dBuV) + Corr. Factor (dB/m)  
 Limit (dBuV/m) = Limit stated in standard  
 Margin (dB) = Result (dBuV/m) – Limit (dBuV/m)  
 Peak = Peak Reading  
 AVG = Average Reading

Calculation Formula

Margin (dB) = Result (dBuV/m) – Limits (dBuV/m)  
 Result (dBuV/m) = Reading (dBuV) + Correction Factor



7.2.4.6. TEST RESULTS

Operation Mode: TX

Test Date: August 20, 2013

Temperature: 24°C

Tested by: Mack Li

Humidity: 52% RH

Polarity: Ver. / Hor.

(The chart below shows the highest readings taken from the final data.)

Frequency (MHz)	Reading (dBµV)	Correction Factor (dB/m)	Result (dBµV/m)	Limit (dBµV/m)	Margin (dB)	Antenna Pole (V/H)	Remark
246.6333	36.23	-17.43	18.80	46.00	-27.20	V	QP
421.2333	33.06	-15.17	17.89	46.00	-28.11	V	QP
560.2667	32.56	-13.67	18.89	46.00	-27.11	V	QP
639.4833	33.60	-12.81	20.79	46.00	-25.21	V	QP
738.1000	32.40	-10.77	21.63	46.00	-24.37	V	QP
827.0167	34.10	-10.55	23.55	46.00	-22.45	V	QP
259.5667	32.66	-17.97	14.69	46.00	-31.31	H	QP
435.7833	33.06	-14.91	18.15	46.00	-27.85	H	QP
476.2000	32.61	-14.53	18.08	46.00	-27.92	H	QP
607.1500	32.48	-12.46	20.02	46.00	-25.98	H	QP
725.1667	32.16	-10.74	21.42	46.00	-24.58	H	QP
825.4000	33.95	-10.63	23.32	46.00	-22.68	H	QP

\*\*Remark: No emission found between lowest internal used/generated frequency to 30MHz.

Notes:

1. Radiated emissions measured in frequency range from 9kHz to 1GHz were made with an instrument using Quasi-peak detector mode.
2. Data of measurement within this frequency range shown " --- " in the table above means the reading of emissions are attenuated more than 20dB below the permissible limits or the field strength is too small to be measured.
3. The IF bandwidth of Receiver between 30MHz to 1GHz was 120kHz.
4. Frequency (MHz). = Emission frequency in MHz  
 Reading (dBµV/m) = Receiver reading  
 Correction Factor (dB) = Antenna factor + Cable loss – Amplifier gain  
 Limit (dBµV/m) = Limit stated in standard  
 Margin (dB) = Measured (dBµV/m) – Limits (dBµV/m)  
 Antenna Pol e(H/V) = Current carrying line of reading



**Above 1 GHz**

**Operation Mode:** TX / CH Low  
**Temperature:** 24°C  
**Humidity:** 52% RH

**Test Date:** August 16, 2013  
**Tested by:** Mack Li  
**Polarity:** Ver. / Hor.

Frequency (MHz)	Reading (dBuV)	Correction Factor (dB/m)	Result (dBuV/m)	Limit (dBuV/m)	Margin (dB)	Antenna Pole (V/H)	Remark
3790.0000	46.04	-2.52	43.52	74.00	-30.48	V	Peak
4375.0000	45.29	-0.91	44.38	74.00	-29.62	V	Peak
4810.0000	48.15	0.46	48.61	74.00	-25.39	V	Peak
5320.0000	45.05	1.53	46.58	74.00	-27.42	V	Peak
5740.0000	45.00	2.52	47.52	74.00	-26.48	V	Peak
6565.0000	44.73	4.72	49.45	74.00	-24.55	V	Peak
3895.0000	45.81	-2.51	43.30	74.00	-30.70	H	Peak
4405.0000	45.40	-0.81	44.59	74.00	-29.41	H	Peak
4810.0000	49.00	0.46	49.46	74.00	-24.54	H	Peak
5080.0000	45.52	1.41	46.93	74.00	-27.07	H	Peak
5635.0000	45.17	2.08	47.25	74.00	-26.75	H	Peak
6340.0000	44.71	4.09	48.80	74.00	-25.20	H	Peak

**REMARKS:**

1. Measuring frequencies from 1 GHz to the 10th harmonic of highest fundamental frequency.
2. Radiated emissions measured in frequency above 1000MHz were made with an instrument using peak/average detector mode.
3. Average test would be performed if the peak result were greater than the average limit or as required by the applicant.
4. Data of measurement within this frequency range shown " --- " in the table above means the reading of emissions are attenuated more than 20dB below the permissible limits or the field strength is too small to be measured.
5. Measurements above show only up to 6 maximum emissions noted, or would be lesser, with " N/A " remark, if no specific emissions from the EUT are recorded (ie: margin>20dB from the applicable limit) and considered that's already beyond the background noise floor.
6. Margin (dB) = Remark result (dBuV/m) – Average limit (dBuV/m).



Operation Mode: TX / CH Mid

Test Date: August 16, 2013

Temperature: 24°C

Tested by: Mack Li

Humidity: 52% RH

Polarity: Ver. / Hor.

Frequency (MHz)	Reading (dBuV)	Correction Factor (dB/m)	Result (dBuV/m)	Limit (dBuV/m)	Margin (dB)	Antenna Pole (V/H)	Remark
3835.0000	45.80	-2.50	43.30	74.00	-30.70	V	Peak
4405.0000	45.43	-0.81	44.62	74.00	-29.38	V	Peak
4885.0000	46.55	0.80	47.35	74.00	-26.65	V	Peak
5695.0000	44.86	2.33	47.19	74.00	-26.81	V	Peak
6490.0000	44.22	4.51	48.73	74.00	-25.27	V	Peak
6970.0000	45.28	6.20	51.48	74.00	-22.52	V	Peak
3880.0000	46.09	-2.51	43.58	74.00	-30.42	H	Peak
4360.0000	45.59	-0.97	44.62	74.00	-29.38	H	Peak
4885.0000	47.14	0.80	47.94	74.00	-26.06	H	Peak
5425.0000	44.84	1.57	46.41	74.00	-27.59	H	Peak
5890.0000	44.80	2.92	47.72	74.00	-26.28	H	Peak
6220.0000	45.96	3.74	49.70	74.00	-24.30	H	Peak

REMARKS:

1. Measuring frequencies from 1 GHz to the 10th harmonic of highest fundamental frequency.
2. Radiated emissions measured in frequency above 1000MHz were made with an instrument using peak/average detector mode.
3. Average test would be performed if the peak result were greater than the average limit or as required by the applicant.
4. Data of measurement within this frequency range shown " --- " in the table above means the reading of emissions are attenuated more than 20dB below the permissible limits or the field strength is too small to be measured.
5. Measurements above show only up to 6 maximum emissions noted, or would be lesser, with " N/A " remark, if no specific emissions from the EUT are recorded (ie: margin>20dB from the applicable limit) and considered that's already beyond the background noise floor.
6. Margin (dB) = Remark result (dBuV/m) – Average limit (dBuV/m).





Operation Mode: TX / CH High
Temperature: 24°C
Humidity: 52% RH

Test Date: August 16, 2013
Tested by: Mack Li
Polarity: Ver. / Hor.

Table with 8 columns: Frequency (MHz), Reading (dBuV), Correction Factor (dB/m), Result (dBuV/m), Limit (dBuV/m), Margin (dB), Antenna Pole (V/H), Remark. It contains two groups of data rows.

REMARKS:

- 1. Measuring frequencies from 1 GHz to the 10th harmonic of highest fundamental frequency.
2. Radiated emissions measured in frequency above 1000MHz were made with an instrument using peak/average detector mode.
3. Average test would be performed if the peak result were greater than the average limit or as required by the applicant.
4. Data of measurement within this frequency range shown " --- " in the table above means the reading of emissions are attenuated more than 20dB below the permissible limits or the field strength is too small to be measured.
5. Measurements above show only up to 6 maximum emissions noted, or would be lesser, with " N/A " remark, if no specific emissions from the EUT are recorded (ie: margin>20dB from the applicable limit) and considered that's already beyond the background noise floor.
6. Margin (dB) = Remark result (dBuV/m) – Average limit (dBuV/m).



### 7.3. 6dB BANDWIDTH MEASUREMENT

#### 7.3.1. LIMITS

According to §15.247(a)(2), systems using digital modulation techniques may operate in the 902 - 928 MHz, 2400 - 2483.5 MHz, and 5725 - 5850 MHz bands. The minimum 6 dB bandwidth shall be at least 500 kHz.

#### 7.3.2. TEST INSTRUMENTS

Name of Equipment	Manufacturer	Model	Serial Number	Last Calibration	Calibration Due
Spectrum Analyzer	Agilent	E4446A	US44300399	03/09/2013	03/08/2014

#### 7.3.3. TEST PROCEDURES (please refer to measurement standard)

1. Place the EUT on the table and set it in the transmitting mode.
2. Remove the antenna from the EUT and then connect a low loss RF cable from the antenna port to the spectrum analyzer.
3. Set the spectrum analyzer as RBW = 100kHz, VBW = 300kHz, Span = 3MHz, Sweep = 1ms.
4. Mark the peak frequency and -6dB (upper and lower) frequency.
5. Repeat until all the rest channels are investigated.

#### 7.3.4. TEST SETUP

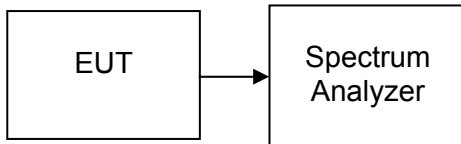

#### 7.3.5. TEST RESULTS

No non-compliance noted

#### Test Data

Channel	Frequency (MHz)	Bandwidth (kHz)	Limit (kHz)	Margin (kHz)
Low	2402	718.946	>500	PASS
Mid	2440	703.889		PASS
High	2480	713.578		PASS



**Test Plot**

**6dB Bandwidth (CH Low)**

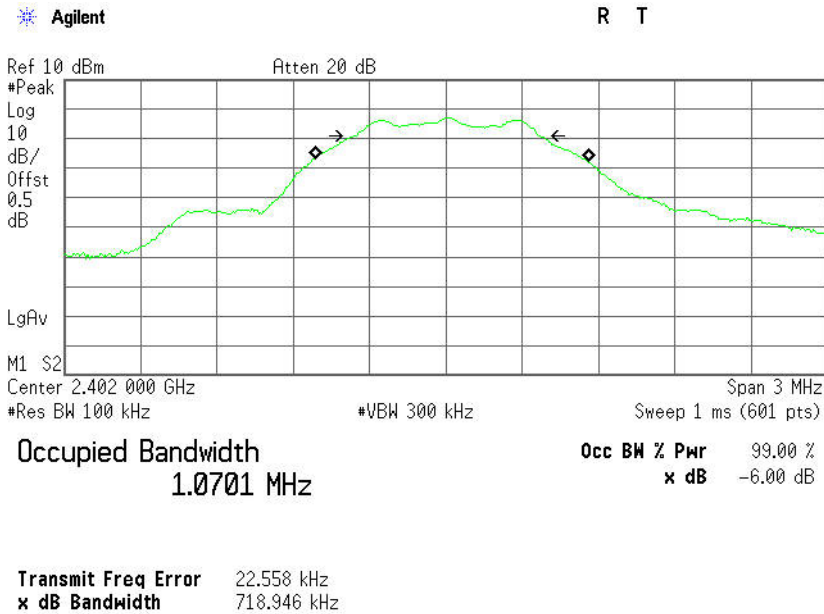

**6dB Bandwidth (CH Mid)**

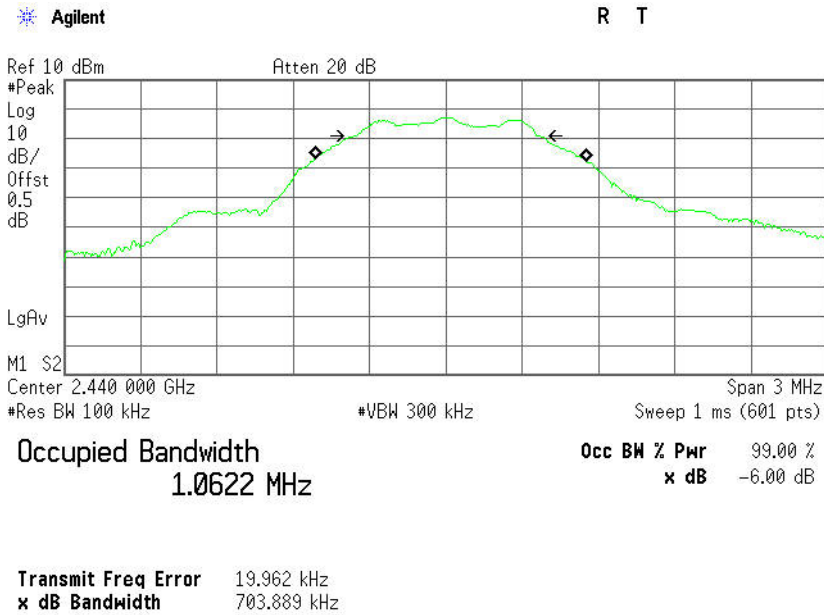



**6dB Bandwidth (CH High)**

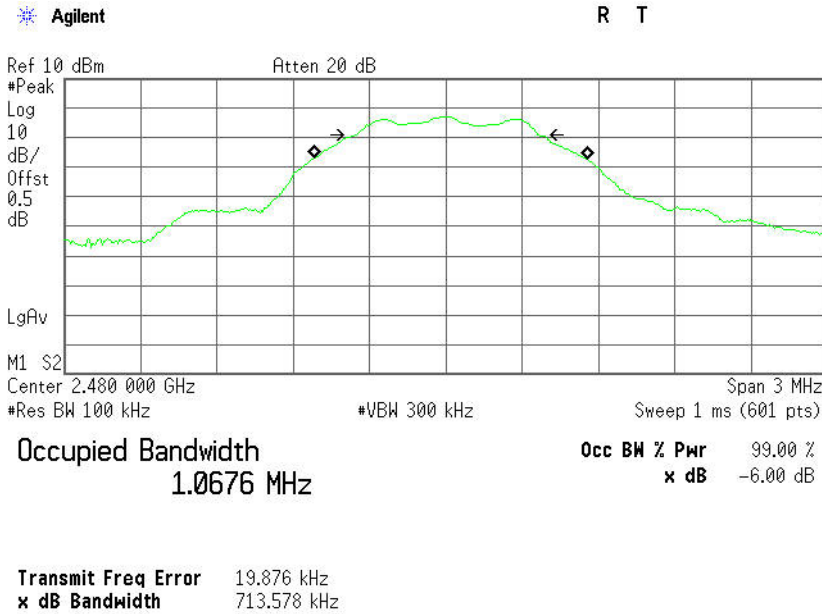



## 7.4. PEAK OUTPUT POWER

### 7.4.1. LIMITS

The maximum peak output power of the intentional radiator shall not exceed the following:

1. According to §15.247(b)(3), for systems using digital modulation in the bands of 902-928 MHz, 2400-2483.5 MHz, and 5725-5850 MHz: 1 Watt.
2. According to §15.247(b)(4), the conducted output power limit specified in paragraph (b) of this section is based on the use of antennas with directional gains that do not exceed 6 dBi. Except as shown in paragraph (c) of this section, if transmitting antennas of directional gain greater than 6 dBi are used, the conducted output power from the intentional radiator shall be reduced below the stated values in paragraphs (b)(1), (b)(2), and (b)(3) of this section, as appropriate, by the amount in dB that the directional gain of the antenna exceeds 6 dBi.

### 7.4.2. TEST INSTRUMENTS

Name of Equipment	Manufacturer	Model	Serial Number	Last Calibration	Calibration Due
Spectrum Analyzer	Agilent	E4446A	US44300399	03/09/2013	03/08/2014

### 7.4.3. TEST PROCEDURES (please refer to measurement standard)

1. Set span to encompass the entire emission bandwidth (EBW) of the signal.
2. Set RBW = 1 MHz.
3. Set VBW  $\geq$  3 MHz.
4. Use sample detector mode if bin width (i.e., span/number of points in spectrum display)  $<$  0.5 RBW. Otherwise use peak detector mode.
5. Use a video trigger with the trigger level set to enable triggering only on full power pulses. Transmitter must operate at full control power for entire sweep of every sweep. If the device transmits continuously, with no off intervals or reduced power intervals, the trigger may be set to "free run".
6. Trace average 100 traces in power averaging mode.
7. Compute power by integrating the spectrum across the 26 dB EBW of the signal. The integration can be performed using the spectrum analyzer's band power measurement function with band limits set equal to the EBW band edges or by summing power levels in each 1 MHz band in linear power terms. The 1 MHz band power levels to be summed can be obtained by averaging, in linear power terms, power levels in each frequency bin across the 1 MHz.



7.4.4. TEST SETUP

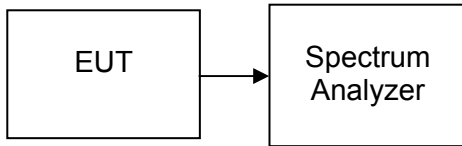

7.4.5. TEST RESULTS

No non-compliance noted

Test Data

Channel	Frequency (MHz)	Output Power (dBm)	Output Power (W)	Limit (W)	Result
Low	2402	-3.03	0.00050	1	PASS
Mid	2440	-2.88	0.00052		PASS
High	2480	-3.03	0.00050		PASS



**Test Plot**

**Peak power (CH Low)**

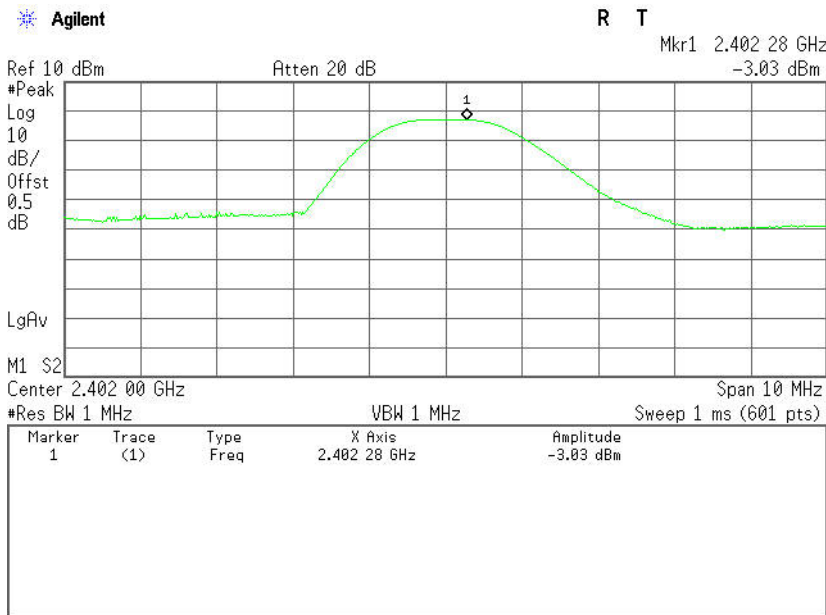

**Peak power (CH Mid)**

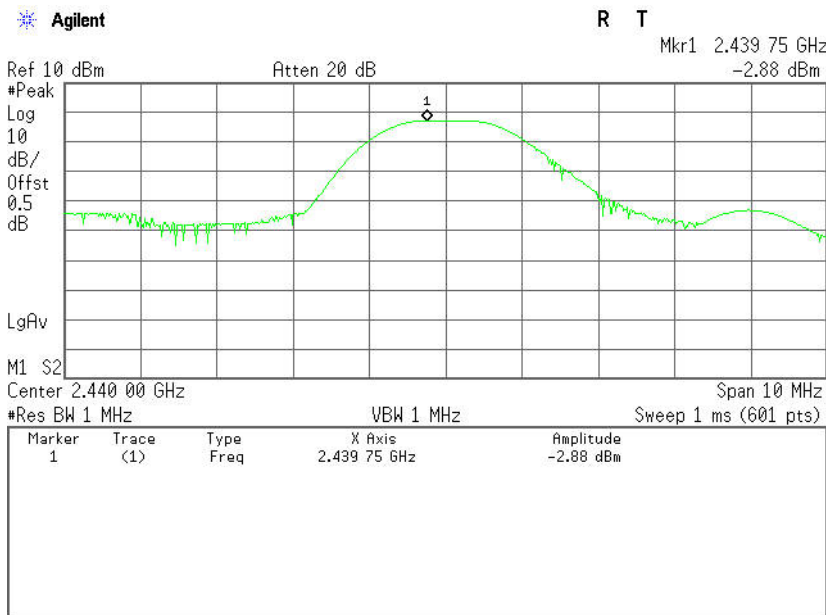



### Peak power (CH High)

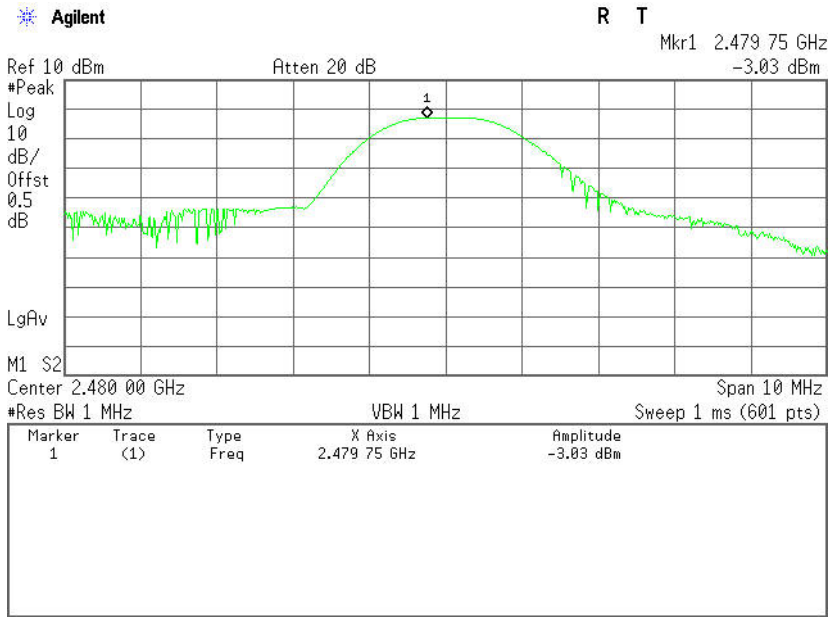





7.5. BAND EDGES MEASUREMENT

7.5.1. LIMITS

According to §15.247(d), in any 100 kHz bandwidth outside the frequency bands in which the spread spectrum intentional radiator in operating, the radio frequency power that is produced by the intentional radiator shall be at least 20 dB below that in the 100 kHz bandwidth within the band that contains the highest level of the desired power, based on either an RF conducted or a radiated measurement, provided the transmitter demonstrates compliance with the peak conducted power limits. In addition, radiated emissions which fall in the restricted bands, as defined in §15.205(a), must also comply with the radiated emission limits specified in 15.209(a) (see Section 15.205(c)).

7.5.2. TEST INSTRUMENTS

Radiated Emission Test Site 966(2)					
Name of Equipment	Manufacturer	Model Number	Serial Number	Last Calibration	Due Calibration
PSA Series Spectrum Analyzer	Agilent	E4446A	US44300399	03/09/2013	03/08/2014
EMI TEST RECEIVER	ROHDE&SCHWARZ	ESCI	100783	03/09/2013	03/08/2014
Amplifier	MITEQ	AM-1604-3000	1123808	03/18/2013	03/18/2014
High Noise Amplifier	Agilent	8449B	3008A01838	03/18/2013	03/18/2014
Board-Band Horn Antenna	Schwarzbeck	BBHA 9170	9170-497	06/21/2013	06/21/2014
Bilog Antenna	SCHAFFNER	CBL6143	5082	03/02/2013	03/01/2014
Horn Antenna	SCHWARZBECK	BBHA9120	D286	03/02/2013	03/01/2014
Loop Antenna	A、 R、 A	PLA-1030/B	1029	03/23/2013	03/23/2014
Turn Table	N/A	N/A	N/A	N.C.R	N.C.R
Controller	Sunol Sciences	SC104V	022310-1	N.C.R	N.C.R
Controller	CT	N/A	N/A	N.C.R	N.C.R
Temp. / Humidity Meter	Anymetre	JR913	N/A	03/04/2013	03/03/2014
Antenna Tower	SUNOL	TLT2	N/A	N.C.R	N.C.R
Test S/W	FARAD	LZ-RF / CCS-SZ-3A2			

- NOTE:** 1. The calibration interval of the above test instruments is 12 months and the calibrations are traceable to NML/ROC and NIST/USA.  
 2. The FCC Site Registration number is 101879.  
 3. N.C.R = No Calibration Required.



**7.5.3. TEST PROCEDURES** (please refer to measurement standard)

1. The EUT is placed on a turntable, which is 0.8m above the ground plane.
2. The turntable shall be rotated for 360 degrees to determine the position of maximum emission level.
3. EUT is set 3m away from the receiving antenna, which is varied from 1m to 4m to find out the highest emission.
4. Set the spectrum analyzer in the following setting in order to capture the lower and upper band-edges of the emission:
  - (a) PEAK: RBW=VBW=1MHz / Sweep=AUTO
  - (b) AVERAGE: RBW=1MHz / VBW=10Hz / Sweep=AUTO
5. Repeat the procedures until all the PEAK and AVERAGE versus POLARIZATION are

**7.5.4. TEST SETUP**

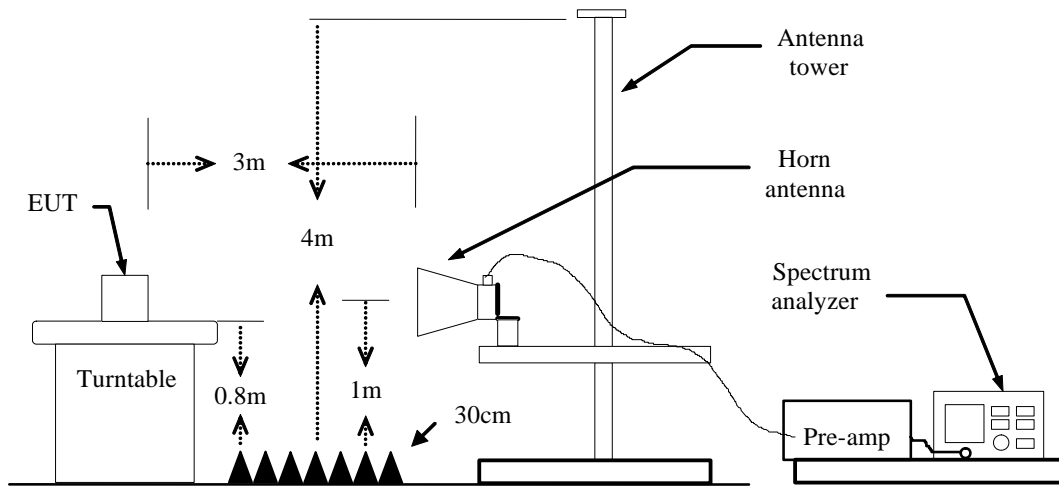



7.5.5. TEST RESULTS

Test Plot

Band Edges (CH Low)

Detector mode: Peak

Polarity: Vertical

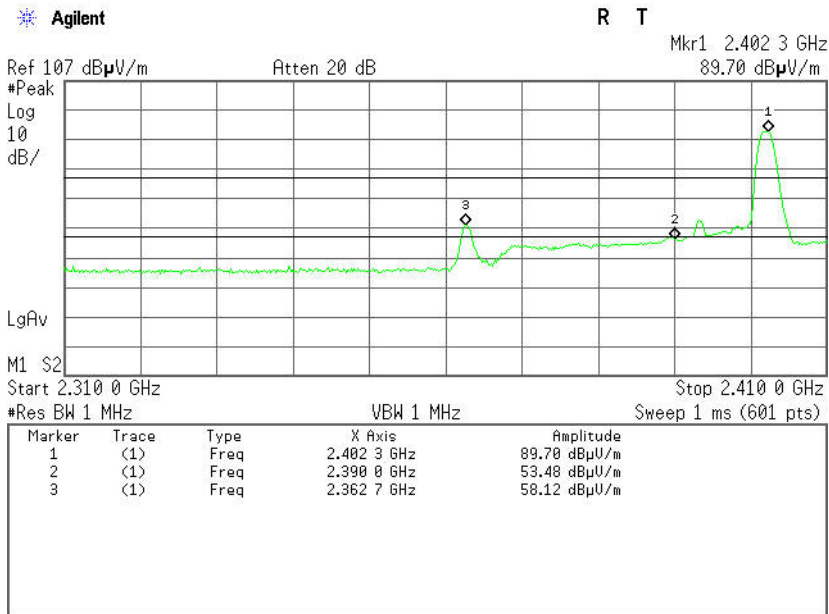

Detector mode: Average

Polarity: Vertical

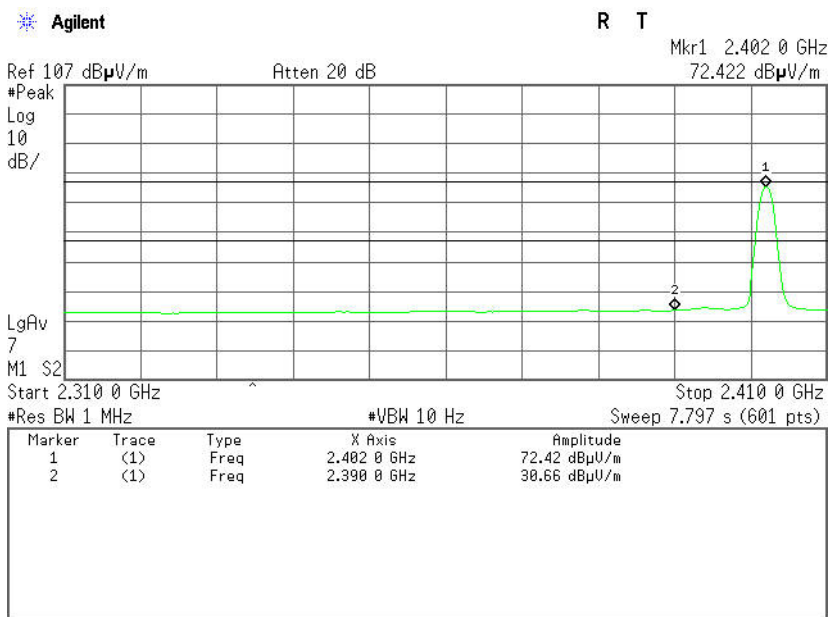



Detector mode: Peak

Polarity: Horizontal

Agilent

R T

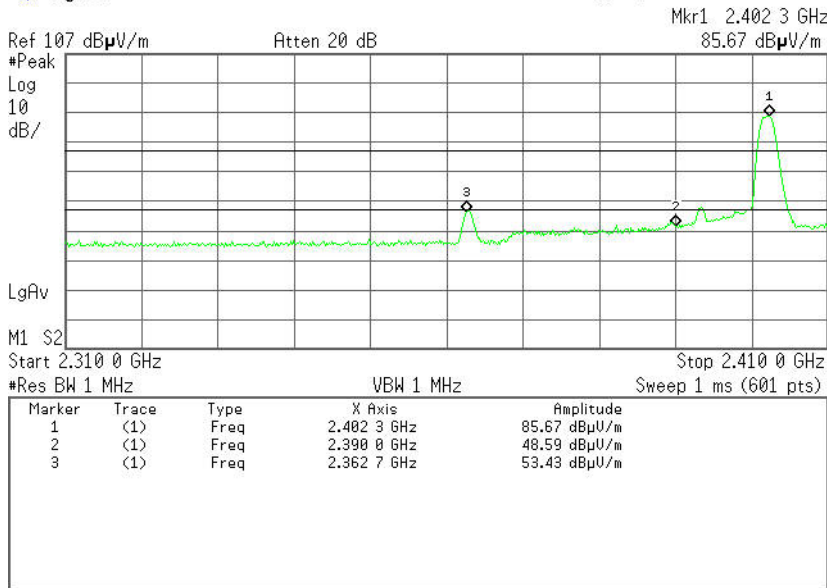

Detector mode: Average

Polarity: Horizontal

Agilent

R T

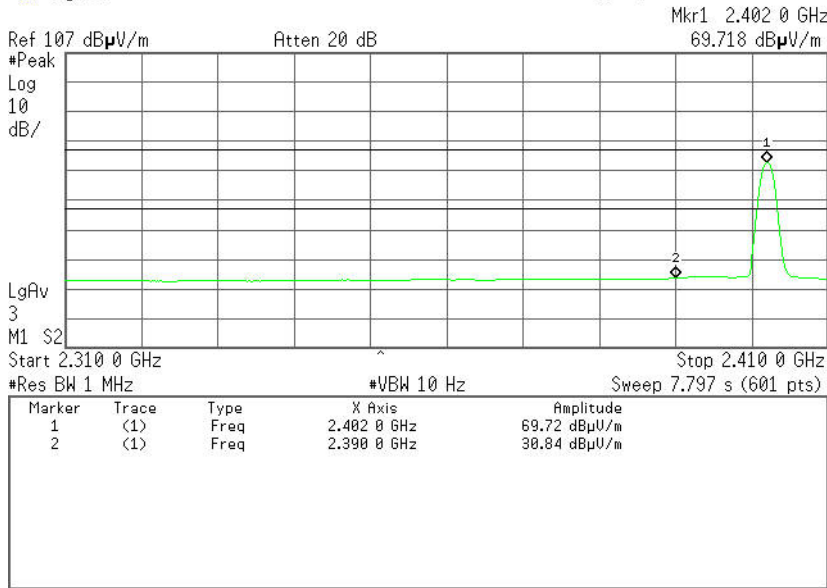



Band Edges (CH High)

Detector mode: Peak

Polarity: Vertical

Agilent

R T

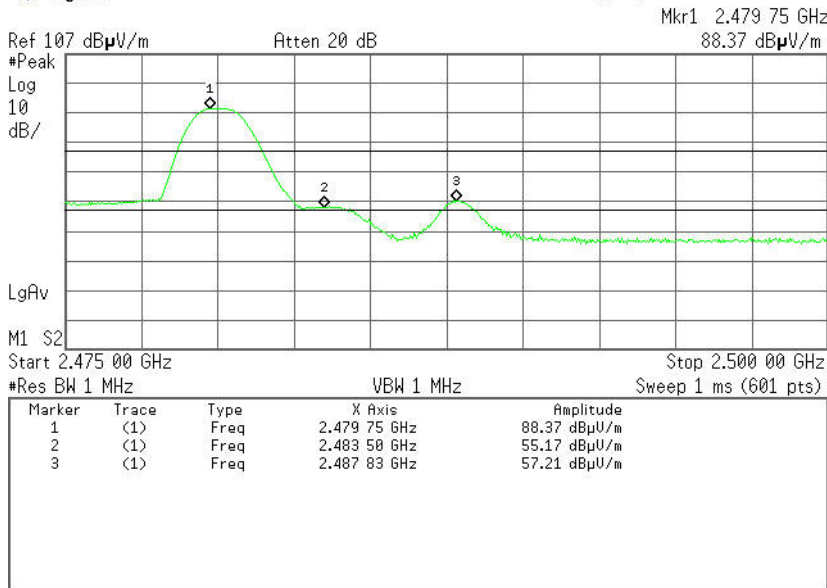

Detector mode: Average

Polarity: Vertical

Agilent

R T

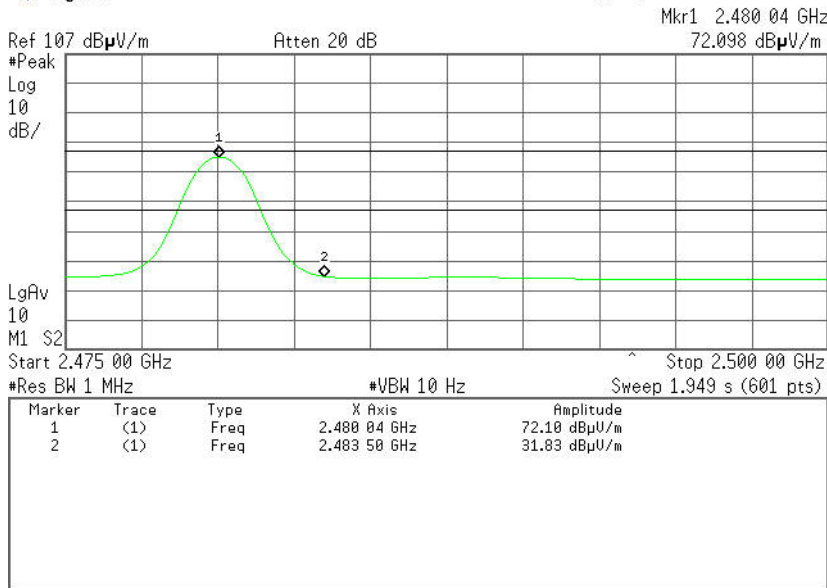



Detector mode: Peak

Polarity: Horizontal

Agilent

R T

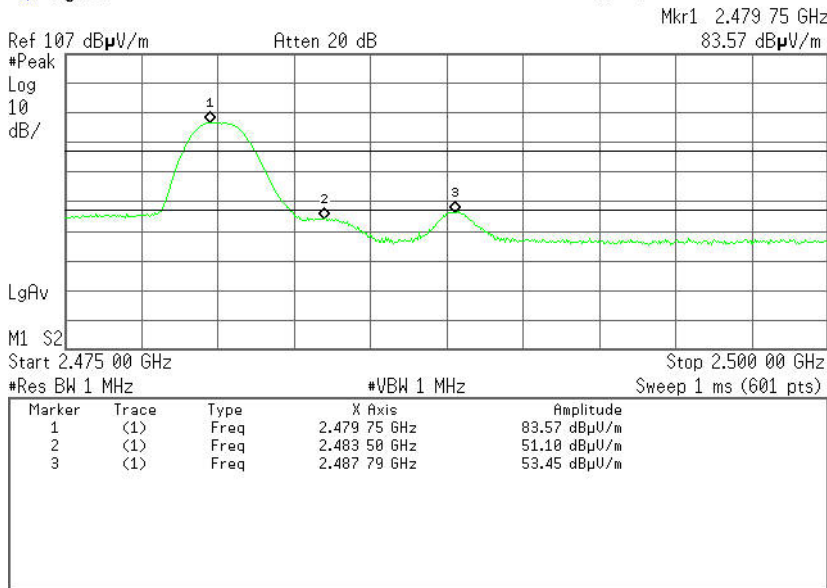

Detector mode: Average

Polarity: Horizontal

Agilent

R T

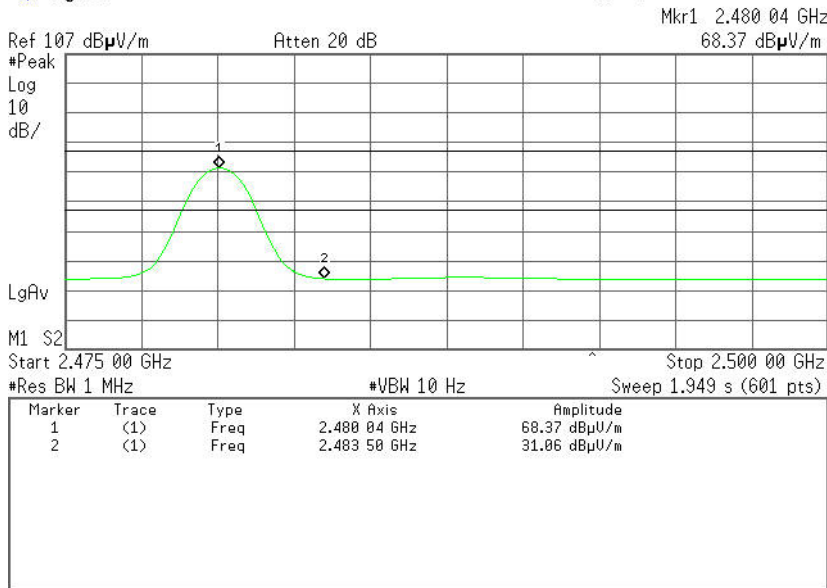



## 7.6. PEAK POWER SPECTRAL DENSITY MEASUREMENT

### 7.6.1. LIMITS

According to §15.247(e), for digitally modulated systems, the power spectral density conducted from the intentional radiator to the antenna shall not be greater than 8 dBm in any 3 kHz band during any time interval of continuous transmission.

According to §15.247(f), the digital modulation operation of the hybrid system, with the frequency hopping turned off, shall comply with the power density requirements of paragraph (d) of this section.

### 7.6.2. TEST INSTRUMENTS

Name of Equipment	Manufacturer	Model	Serial Number	Last Calibration	Calibration Due
Spectrum Analyzer	Agilent	E4446A	US44300399	03/09/2013	03/08/2014

### 7.6.3. TEST PROCEDURES (please refer to measurement standard)

1. Place the EUT on the table and set it in transmitting mode.  
Remove the antenna from the EUT and then connect a low loss RF cable from the antenna port to the spectrum analyzer.
2. Set the spectrum analyzer as RBW = 3kHz, VBW = 10kHz, Span = 3MHz, Sweep=316.3ms
3. Record the max. reading.
4. Repeat the above procedure until the measurements for all frequencies are completed.

### 7.6.4. TEST SETUP

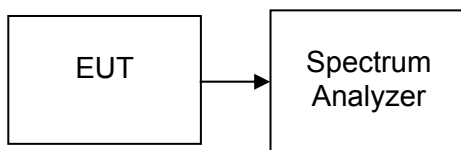



**7.6.5. TEST RESULTS**

*No non-compliance noted*

**Test Data**

Channel	Frequency (MHz)	PPSD (dBm)	Limit (dBm)	Test Result
Low	2402	-16.75	8.00	PASS
Mid	2440	-14.41		PASS
High	2480	-13.48		PASS





Test Plot

PPSD (CH Low)

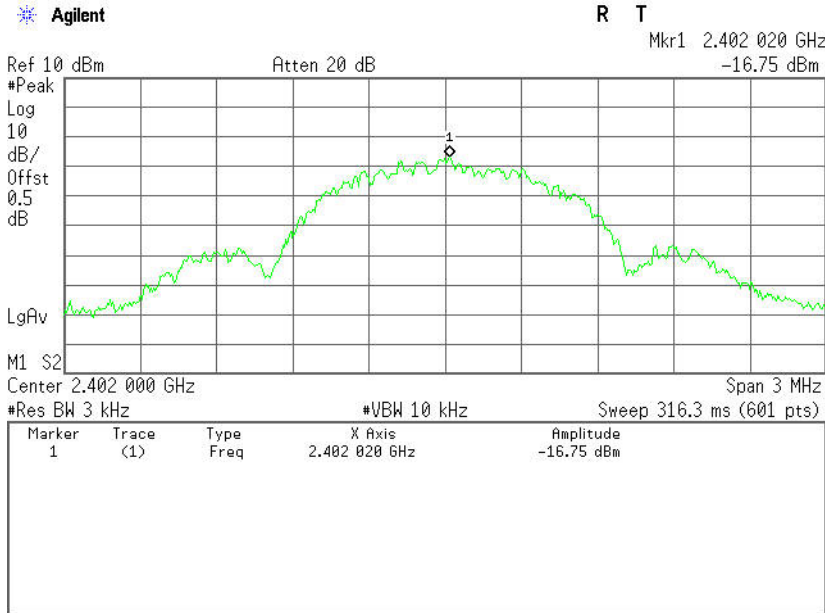

PPSD (CH Mid)

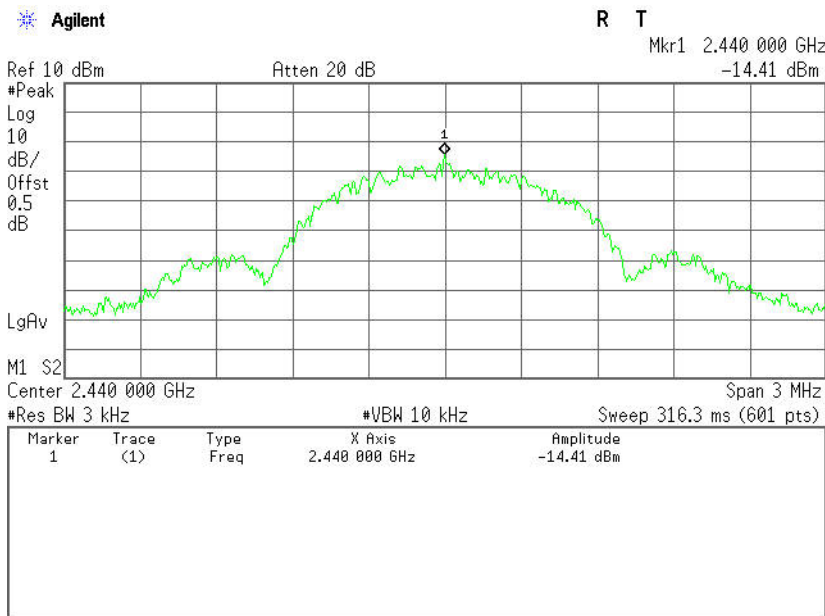



### PPSD (CH High)

