

TEST REPORT

FCC ID: IKQBTFM

Product: Bluetooth FM Transmitter

Model No.: BTFM

Additional Model No.: N/A

Trade Mark: SCOSCHE

Report No.: TCT150514E003

Issued Date: Aug. 07, 2015

Issued for:

Scosche Industries, Inc.

1550 Pacific Ave. Oxnard, CA 93033, USA

Issued By:

Shenzhen Tongce Testing Lab.

1F, Leinuo Watch Building, Fuyong Town, Baoan Dist, Shenzhen, China

TEL: +86-755-27673339

FAX: +86-755-27673332

Note: This report shall not be reproduced except in full, without the written approval of Shenzhen Tongce Testing Lab.

This document may be altered or revised by Shenzhen Tongce Testing Lab. personnel only, and shall be noted in the revision section of the document. The test results in the report only apply to the tested sample.

TABLE OF CONTENTS

1. Test Certification.....	3
2. Test Result Summary	4
3. EUT Description.....	5
4. Genera Information.....	6
4.1. Test environment and mode.....	6
4.2. Description of Support Units.....	6
5. Facilities and Accreditations	7
5.1. Facilities	7
5.2. Location	7
5.3. Measurement Uncertainty.....	7
6. Test Results and Measurement Data	8
6.1. Antenna requirement	8
6.2. Conducted Emission.....	9
6.3. Conducted Output Power	10
6.4. Emission Bandwidth	13
6.5. Power Spectral Density.....	16
6.6. Test Specification.....	16
6.7. Conducted Band Edge and Spurious Emission Measurement	19
6.8. Radiated Spurious Emission Measurement.....	22
Appendix A: Photographs of Test Setup	
Appendix B: Photographs of EUT	

1. Test Certification

Product:	Bluetooth FM Transmitter
Model No.:	BTFM
Additional Model No.:	N/A
Applicant:	Scosche Industries, Inc.
Address:	1550 Pacific Ave. Oxnard, CA 93033, USA
Manufacturer:	Shenzhen James Audio Technology Co., Ttd.
Address:	4F, Building A, Rongli Industrial Park, Miaoxi Industrial Zone, Xinghua Community, Guanlan Street, Longhua New District, Shenzhen, China
Date of Test:	May 14 – Jun. 04, 2015
Applicable Standards:	FCC CFR Title 47 Part 15 Subpart C Section 15.247 KDB 558074 D01 DTS Meas Guidance v03r02

The above equipment has been tested by Shenzhen Tongce Testing Lab. and found compliance with the requirements set forth in the technical standards mentioned above. The results of testing in this report apply only to the product/system, which was tested. Other similar equipment will not necessarily produce the same results due to production tolerance and measurement uncertainties.

Tested By:**SKY****Date:****Jun. 04, 2015****Reviewed By:****Joe Zhou****Date:****Aug. 07, 2015****Approved By:****Tomsin****Date:****Aug. 07, 2015**

2. Test Result Summary

Requirement	CFR 47 Section	Result
Antenna requirement	§15.203/§15.247 (c)	PASS
AC Power Line Conducted Emission	§15.207	N/A
Conducted Peak Output Power	§15.247 (b)(3)	PASS
6dB Emission Bandwidth	§15.247 (a)(2)	PASS
Power Spectral Density	§15.247 (e)	PASS
Band Edge	§15.247(d)	PASS
Spurious Emission	§15.205/§15.209	PASS

Note:

1. PASS: Test item meets the requirement.
2. Fail: Test item does not meet the requirement.
3. N/A: Test case does not apply to the test object.
4. The test result judgment is decided by the limit of test standard.

3. EUT Description

Product Name:	Bluetooth FM Transmitter
Model :	BTFM
Additional Model:	N/A
Trade Mark:	SCOSCHE
Operation Frequency:	2402MHz~2480MHz
Channel Separation:	2MHz
Number of Channel:	40
Modulation Technology:	GFSK
Antenna Type:	PCB Antenna
Antenna Gain:	0dBi
Power Supply:	DC 12V

Operation Frequency each of channel

Channel	Frequency	Channel	Frequency	Channel	Frequency	Channel	Frequency
0	2402MHz	10	2422MHz	20	2442MHz	30	2462MHz
1	2404MHz	11	2424MHz	21	2444MHz	31	2464MHz
...
8	2418MHz	18	2438MHz	28	2458MHz	38	2478MHz
9	2420MHz	19	2440MHz	29	2460MHz	39	2480MHz

Remark: Channel 0, 19 & 39 have been tested.

4. General Information

4.1. Test environment and mode

Operating Environment:	
Temperature:	25.0 °C
Humidity:	56 % RH
Atmospheric Pressure:	1010 mbar
Test Mode:	
Engineering mode:	Keep the EUT in continuous transmitting by select channel and modulations
<p>The sample was placed 0.8m above the ground plane of 3m chamber. Measurements in both horizontal and vertical polarities were performed. During the test, each emission was maximized by: having the EUT continuously working, investigated all operating modes, rotated about all 3 axis (X, Y & Z) and considered typical configuration to obtain worst position, manipulating interconnecting cables, rotating the turntable, varying antenna height from 1m to 4m in both horizontal and vertical polarizations. The emissions worst-case are shown in Test Results of the following pages.</p>	

4.2. Description of Support Units

The EUT has been tested as an independent unit together with other necessary accessories or support units. The following support units or accessories were used to form a representative test configuration during the tests.

Equipment	Model No.	Serial No.	FCC ID	Trade Name
/	/	/	/	/

Note:

1. All the equipment/cables were placed in the worst-case configuration to maximize the emission during the test.
2. Grounding was established in accordance with the manufacturer's requirements and conditions for the intended use.

5. Facilities and Accreditations

5.1. Facilities

The test facility is recognized, certified, or accredited by the following organizations:

- FCC - Registration No.: 572331

Shenzhen Tongce Testing Lab

The 3m Semi-anechoic chamber has been registered and fully described in a report with the (FCC) Federal Communications Commission. The acceptance letter from the FCC is maintained in our files.

- IC - Registration No.: 10668A-1

The 3m Semi-anechoic chamber of Shenzhen TCT Testing Technology Co., Ltd. has been registered by Certification and Engineering Bureau of Industry Canada for radio equipment testing

- CNAS - Registration No.: CNAS L6165

Shenzhen TCT Testing Technology Co., Ltd. is accredited to ISO/IEC 17025:2005 General Requirements for the Competence of Testing and Calibration laboratories for the competence of testing. The Registration No. is CNAS L6165.

5.2. Location

Shenzhen TCT Testing Technology Co., Ltd.

Address: 1F, Building 1, Yibaolai Industrial Par Qiaotou Village, Fuyong Town Shenzhen, China

5.3. Measurement Uncertainty

The reported uncertainty of measurement $y \pm U$, where expanded uncertainty U is based on a standard uncertainty multiplied by a coverage factor of $k=2$, providing a level of confidence of approximately 95 %.

No.	Item	MU
1	Conducted Emission	$\pm 2.56\text{dB}$
2	RF power, conducted	$\pm 0.12\text{dB}$
3	Spurious emissions, conducted	$\pm 0.11\text{dB}$
4	All emissions, radiated(<1G)	$\pm 3.92\text{dB}$
5	All emissions, radiated(>1G)	$\pm 4.28\text{dB}$
6	Temperature	$\pm 0.1^\circ\text{C}$
7	Humidity	$\pm 1.0\%$

6. Test Results and Measurement Data

6.1. Antenna requirement

Standard requirement:	FCC Part15 C Section 15.203 /247(c)
15.203 requirement: An intentional radiator shall be designed to ensure that no antenna other than that furnished by the responsible party shall be used with the device. The use of a permanently attached antenna or of an antenna that uses a unique coupling to the intentional radiator, the manufacturer may design the unit so that a broken antenna can be replaced by the user, but the use of a standard antenna jack or electrical connector is prohibited.	
15.247(c) (1)(i) requirement: (i) Systems operating in the 2400-2483.5 MHz band that is used exclusively for fixed. Point-to-point operations may employ transmitting antennas with directional gain greater than 6dBi provided the maximum conducted output power of the intentional radiator is reduced by 1 dB for every 3 dB that the directional gain of the antenna exceeds 6dBi.	
E.U.T Antenna:	
The Bluetooth antenna is an internal PCB antenna which permanently attached, and the best case gain of the antenna is 0dBi.	
	

6.2. Conducted Emission

6.2.1. Test Specification

Test Requirement:	FCC Part15 C Section 15.207														
Test Method:	FCC: ANSI C63.4:2009														
Frequency Range:	150 kHz to 30 MHz														
Receiver setup:	RBW=9 kHz, VBW=30 kHz, Sweep time=auto														
Limits:	<table border="1"> <thead> <tr> <th rowspan="2">Frequency range (MHz)</th> <th colspan="2">Limit (dBuV)</th> </tr> <tr> <th>Quasi-peak</th> <th>Average</th> </tr> </thead> <tbody> <tr> <td>0.15-0.5</td> <td>66 to 56*</td> <td>56 to 46*</td> </tr> <tr> <td>0.5-5</td> <td>56</td> <td>46</td> </tr> <tr> <td>5-30</td> <td>60</td> <td>50</td> </tr> </tbody> </table>	Frequency range (MHz)	Limit (dBuV)		Quasi-peak	Average	0.15-0.5	66 to 56*	56 to 46*	0.5-5	56	46	5-30	60	50
Frequency range (MHz)	Limit (dBuV)														
	Quasi-peak	Average													
0.15-0.5	66 to 56*	56 to 46*													
0.5-5	56	46													
5-30	60	50													
Test Setup:	<p><i>Remark:</i> E.U.T: Equipment Under Test LISN: Line Impedance Stabilization Network Test table height=0.8m</p>														
Test Mode:	Charging + transmitting with modulation														
Test Procedure:	<ol style="list-style-type: none"> The E.U.T and simulators are connected to the main power through a line impedance stabilization network (L.I.S.N.). This provides a 50ohm/50uH coupling impedance for the measuring equipment. The peripheral devices are also connected to the main power through a LISN that provides a 50ohm/50uH coupling impedance with 50ohm termination. (Please refer to the block diagram of the test setup and photographs). Both sides of A.C. line are checked for maximum conducted interference. In order to find the maximum emission, the relative positions of equipment and all of the interface cables must be changed according to ANSI C63.4: 2014 on conducted measurement. 														
Test Result:	N/A														
Remark	The EUT is powered by car's power DC 12V, So not applicable.														

6.3. Maximum Peak Conducted Output Power

6.3.1. Test Specification

Test Requirement:	FCC Part15 C Section 15.247 (b)(3)
Test Method:	FCC: ANSI C63.4:2009 and KDB558074
Limit:	30dBm
Test Setup:	 <p style="text-align: center;">Spectrum Analyzer EUT</p>
Test Mode:	Refer to Section 4.1 for Details
Test Procedure:	<ol style="list-style-type: none"> 1. The testing follows the Measurement Procedure of FCC KDB No. 558074 DTS D01 Meas. Guidance v03r02. 2. Set spectrum analyzer as following: <ol style="list-style-type: none"> a) Set the RBW \geq DTS bandwidth. b) Set VBW \geq 3 \times RBW. c) Set span \geq 3 x RBW d) Sweep time = auto couple. e) Detector = peak. f) Trace mode = max hold. g) Allow trace to fully stabilize. h) Use peak marker function to determine the peak amplitude level.
Test Result:	PASS

6.3.2. Test Instruments

Equipment	Manufacturer	Model	Serial Number	Calibration Due
Spectrum Analyzer	R&S	FSU	200054	Sep. 15, 2015

Note: The calibration interval of the above test instruments is 12 months and the calibrations are traceable to international system unit (SI).

6.3.3. Test Data

BT LE mode			
Test channel	Maximum Conducted Peak Output Power (dBm)	Limit (dBm)	Result
Lowest	2.95	30.00	PASS
Middle	3.70	30.00	PASS
Highest	3.64	30.00	PASS

Test plots as follows:

BT LE mode

Lowest channel

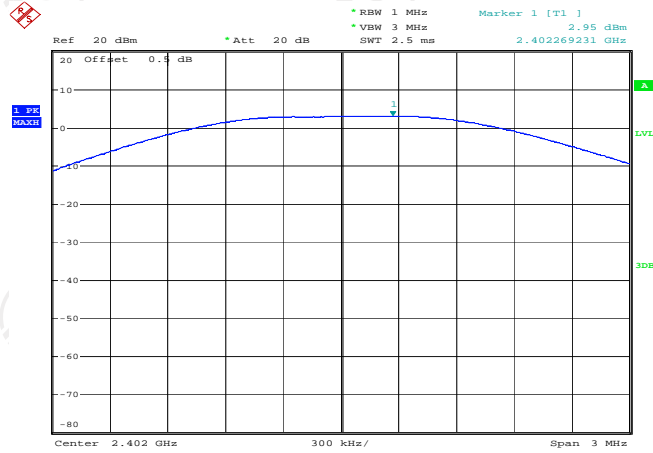

Date: 26.MAY.2015 13:07:12

Middle channel

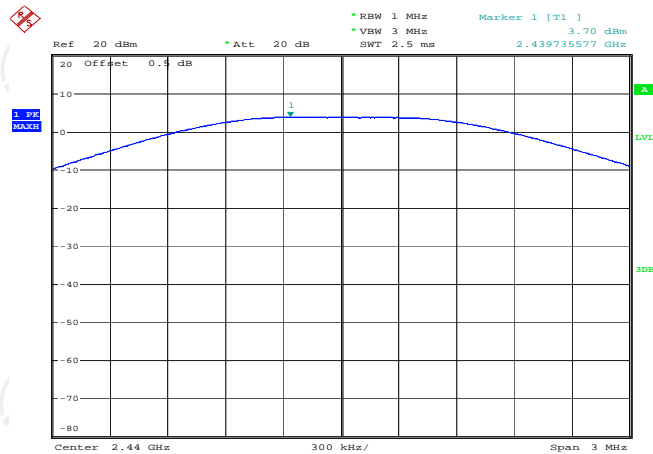

Date: 26.MAY.2015 13:02:32

Highest channel

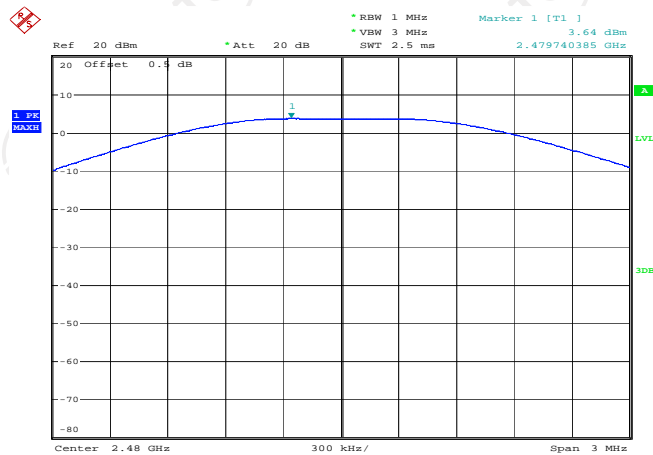

Date: 26.MAY.2015 13:04:57

6.4. Emission Bandwidth

6.4.1. Test Specification

Test Requirement:	FCC Part15 C Section 15.247 (a)(2)
Test Method:	FCC: ANSI C63.4:2009 and KDB558074
Limit:	>500kHz
Test Setup:	 <p style="text-align: center;">Spectrum Analyzer EUT</p>
Test Mode:	Refer to Section 4.1 for Details
Test Procedure:	<ol style="list-style-type: none"> 1. The testing follows FCC KDB Publication No. 558074 DTS D01 Meas. Guidance v03r02. 2. The testing follows FCC KDB Publication No. 558074 DTS D01 Meas. Guidance v03r02. 3. Set to the maximum power setting and enable the EUT transmit continuously. 4. Make the measurement with the spectrum analyzer's resolution bandwidth (RBW) = 100 kHz. Set the Video bandwidth (VBW) = 300 kHz. In order to make an accurate measurement. The 6dB bandwidth must be greater than 500 kHz. 5. Measure and record the results in the test report.
Test Result:	PASS

6.4.2. Test Instruments

RF Test Room				
Equipment	Manufacturer	Model	Serial Number	Calibration Due
Spectrum Analyzer	R&S	FSU	200054	Sep. 15, 2015

Note: The calibration interval of the above test instruments is 12 months and the calibrations are traceable to international system unit (SI).

6.4.3. Test data

Test channel	6dB Emission Bandwidth (kHz)	Limit	Result
	BT LE mode		
Lowest	689.10	>500k	PASS
Middle	689.10	>500k	
Highest	692.31	>500k	

Test plots as follows:

BT LE mode

Lowest channel

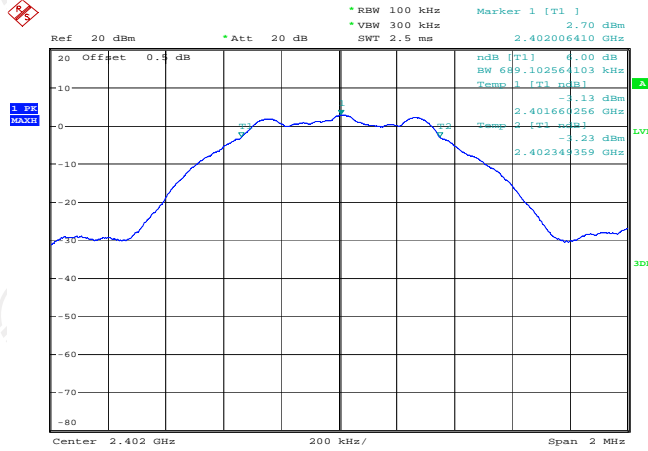

Date: 26.MAY.2015 12:56:02

Middle channel

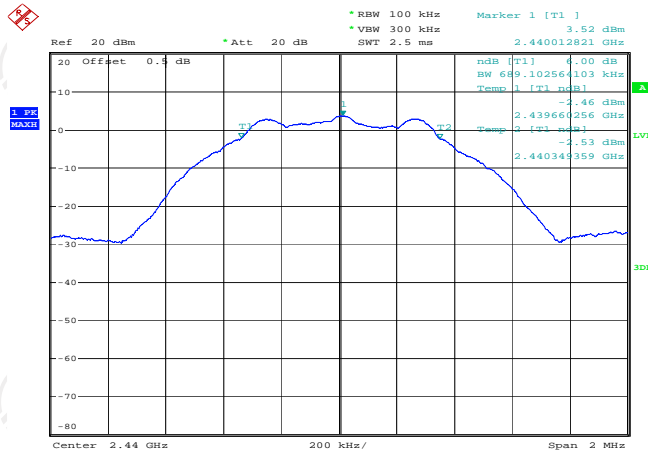

Date: 26.MAY.2015 13:03:24

Highest channel

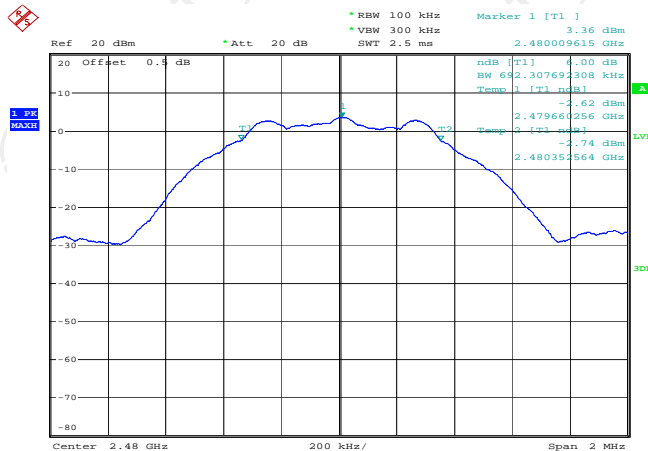

Date: 26.MAY.2015 13:05:33

6.5. Power Spectral Density

6.5.1. Test Specification

Test Requirement:	FCC Part15 C Section 15.247 (e)
Test Method:	FCC: ANSI C63.4:2009 and KDB558074
Limit:	The peak power spectral density shall not be greater than 8dBm in any 3kHz band at any time interval of continuous transmission.
Test Setup:	 <p style="text-align: center;">Spectrum Analyzer EUT</p>
Test Mode:	Refer to Section 4.1 for Details
Test Procedure:	<ol style="list-style-type: none"> 1. The testing follows Measurement Procedure 10.2 Method PKPSD of FCC KDB Publication No.558074 D01 DTS Meas. Guidance v03r02 2. The RF output of EUT was connected to the spectrum analyzer by RF cable and attenuator. The path loss was compensated to the results for each measurement. 3. Set to the maximum power setting and enable the EUT transmit continuously. 4. Make the measurement with the spectrum analyzer's resolution bandwidth (RBW): $3\text{ kHz} \leq \text{RBW} \leq 100\text{ kHz}$. Video bandwidth VBW $\geq 3 \times \text{RBW}$. In order to make an accurate measurement, set the span to 1.5 times DTS Channel Bandwidth. (6dB BW) 5. Detector = peak, Sweep time = auto couple, Trace mode = max hold, Allow trace to fully stabilize. Use the peak marker function to determine the maximum power level. 6. Measure and record the results in the test report.
Test Result:	PASS

6.5.2. Test Instruments

RF Test Room				
Equipment	Manufacturer	Model	Serial Number	Calibration Due
Spectrum Analyzer	R&S	FSU	200054	Sep. 15, 2015

Note: The calibration interval of the above test instruments is 12 months and the calibrations are traceable to international system unit (SI).

6.5.3. Test data

Test channel	Power Spectral Density (dBm/3kHz)		
	BT LE mode	Limit	Result
Lowest	2.71	8dBm/3kHz	PASS
Middle	3.49	8dBm/3kHz	
Highest	3.43	8dBm/3kHz	

Test plots as follows:

Lowest channel

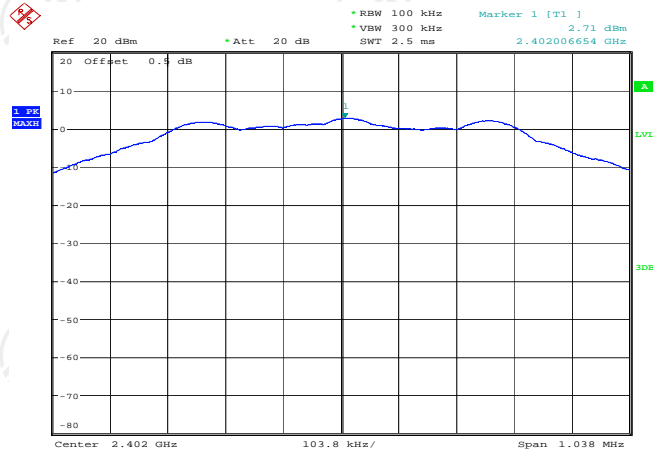

Date: 26.MAY.2015 12:59:18

Middle channel

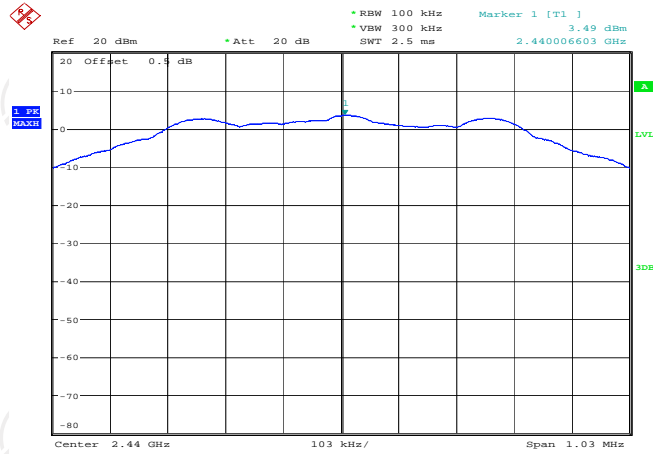

Date: 26.MAY.2015 13:04:18

Highest channel

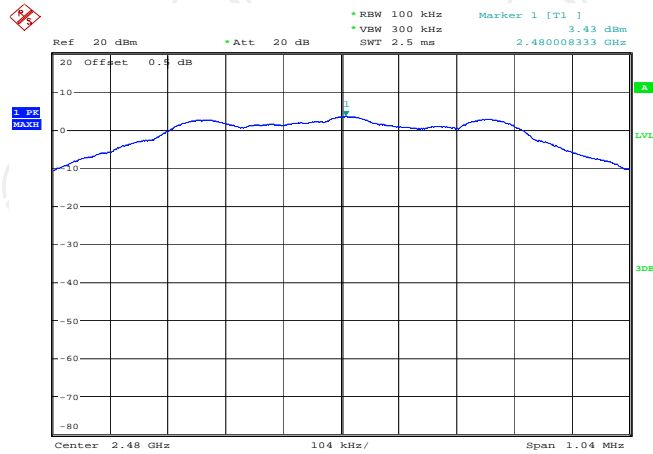

Date: 26.MAY.2015 13:06:13

6.6. Conducted Band Edge and Spurious Emission Measurement

6.6.1. Test Specification

Test Requirement:	FCC Part15 C Section 15.247 (d)
Test Method:	FCC: ANSI C63.4:2009 and KDB558074
Limit:	In any 100 kHz bandwidth outside of the authorized frequency band, the emissions which fall in the non-restricted bands shall be attenuated at least 20 dB / 30dB relative to the maximum PSD level in 100 kHz by RF conducted measurement and radiated emissions which fall in the restricted bands, as defined in Section 15.205(a), must also comply with the radiated emission limits specified in Section 15.209(a).
Test Setup:	<p>The diagram illustrates the test setup. On the left is a Spectrum Analyzer with a green screen and two ports. It is connected via a cable to a small white rectangular attenuator. This attenuator is further connected to a yellow rectangular Equipment Under Test (EUT).</p> <p style="text-align: center;">Spectrum Analyzer EUT</p>
Test Mode:	Refer to Section 4.1 for Details
Test Procedure:	<ol style="list-style-type: none"> 1. The testing follows FCC KDB Publication No. 558074 D01 DTS Meas. Guidance v03r02. 2. The RF output of EUT was connected to the spectrum analyzer by RF cable and attenuator. The path loss was compensated to the results for each measurement. 3. Set to the maximum power setting and enable the EUT transmit continuously. 4. Set RBW = 100 kHz, VBW=300 kHz, Peak Detector. Unwanted Emissions measured in any 100 kHz bandwidth outside of the authorized frequency band shall be attenuated by at least 20 dB relative to the maximum in-band peak PSD level in 100 kHz when maximum peak conducted output power procedure is used. If the transmitter complies with the conducted power limits based on the use of RMS averaging over a time interval, the attenuation required under this paragraph shall be 30 dB instead of 20 dB per 15.247(d). 5. Measure and record the results in the test report. 6. The RF fundamental frequency should be excluded against the limit line in the operating frequency band.
Test Result:	PASS

6.6.2. Test Instruments

RF Test Room				
Equipment	Manufacturer	Model	Serial Number	Calibration Due
Spectrum Analyzer	R&S	FSU	200054	Sep. 15, 2015
Spectrum Analyzer	Agilent	N9020A	MY49100060	Oct. 21, 2015

Note: The calibration interval of the above test instruments is 12 months and the calibrations are traceable to international system unit (SI).

6.6.3. Test Data

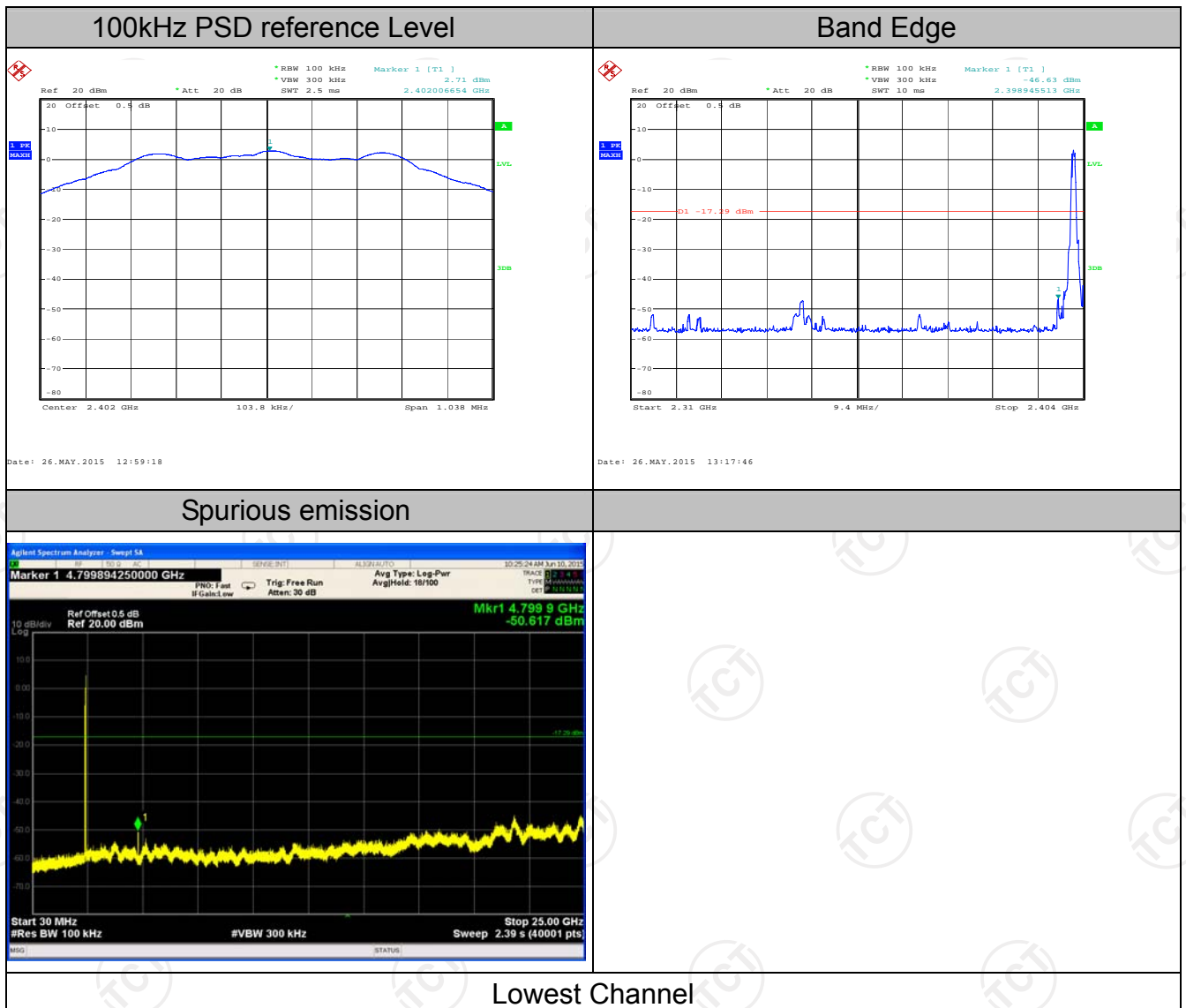

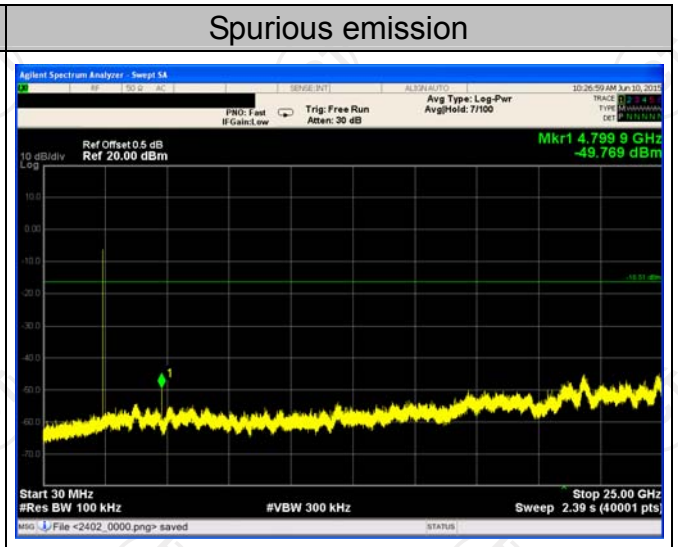
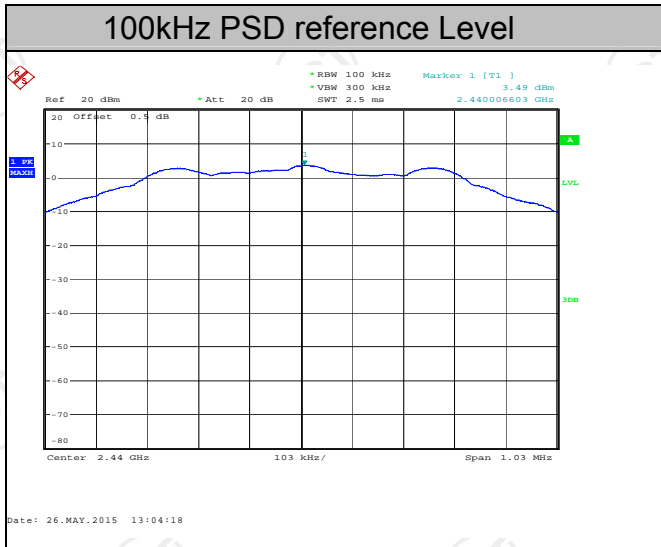

Middle Channel

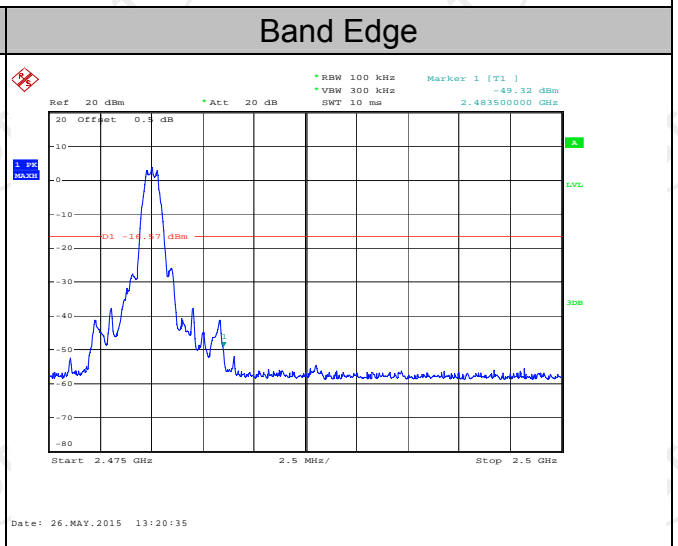
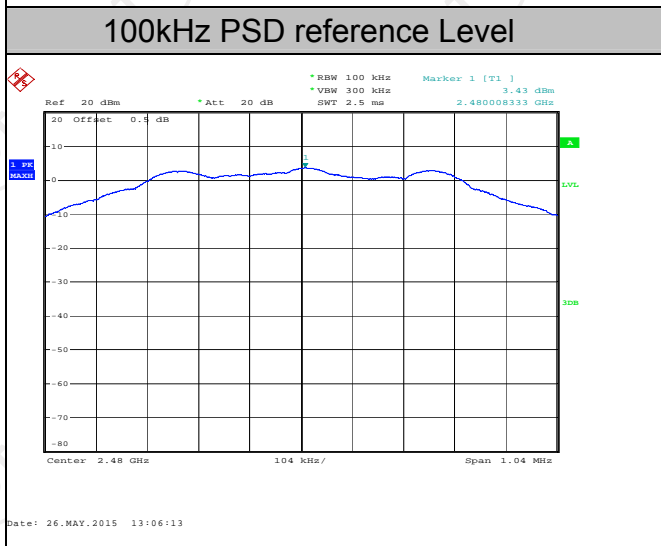

Spurious emission

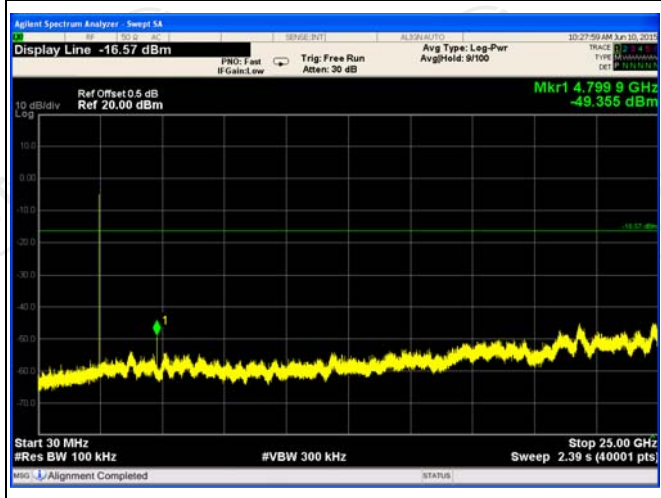

Highest Channel

6.7. Radiated Spurious Emission Measurement

6.7.1. Test Specification

Test Requirement:	FCC Part15 C Section 15.209				
Test Method:	FCC: ANSI C63.4: 2009 and ANSI C63.10: 2009				
Frequency Range:	9 kHz to 25 GHz				
Measurement Distance:	3 m				
Antenna Polarization:	Horizontal & Vertical				
Operation mode:	Refer to Section 4.1 for Details				
Receiver Setup:	Frequency	Detector	RBW	VBW	Remark
	9kHz- 150kHz	Quasi-peak	200Hz	1kHz	Quasi-peak Value
	150kHz- 30MHz	Quasi-peak	9kHz	30kHz	Quasi-peak Value
	30MHz-1GHz	Quasi-peak	100KHz	300KHz	Quasi-peak Value
	Above 1GHz	Peak	1MHz	3MHz	Peak Value
		Peak	1MHz	10Hz	Average Value
Limit:	Frequency	Field Strength (microvolts/meter)	Measurement Distance (meters)		
	0.009-0.490	2400/F(KHz)	300		
	0.490-1.705	24000/F(KHz)	30		
	1.705-30	30	30		
	30-88	100	3		
	88-216	150	3		
	216-960	200	3		
	Above 960	500	3		
	Frequency	Field Strength (microvolts/meter)	Measurement Distance (meters)	Detector	
	Above 1GHz	500	3	Average	
		5000	3	Peak	
Test setup:	For radiated emissions below 30MHz				
	<p>Distance = 3m</p> <p>EUT</p> <p>Turn table</p> <p>Ground Plane</p> <p>Pre -Amplifier</p> <p>Receiver</p> <p>Computer</p>				
	30MHz to 1GHz				

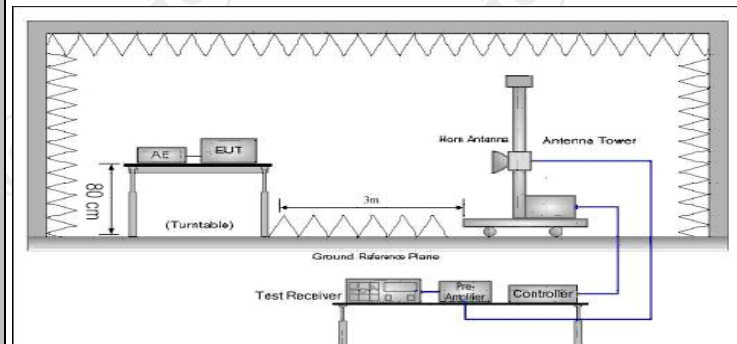
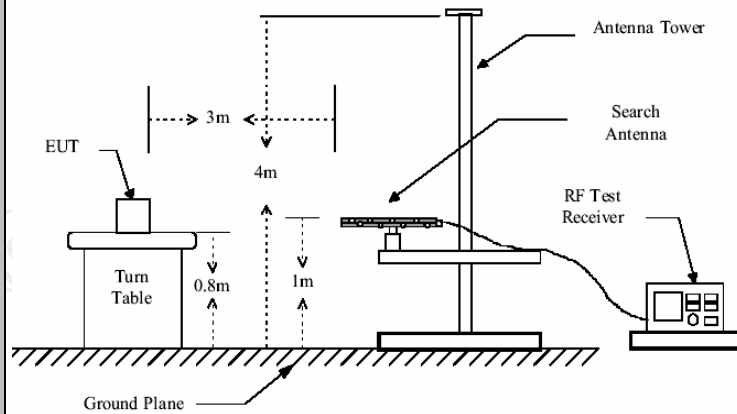

Test Procedure:

1. The testing follows FCC KDB Publication No. 558074 D01 DTS Meas. Guidance v03r02.
2. The EUT was arranged to its worst case and then tune the antenna tower (from 1 m to 4 m) and turntable (from 0 degree to 360 degrees) to find the maximum reading. A pre-amp and a high PASS filter are used for the test in order to get better signal level.
3. The EUT was placed on a turntable with 0.8 meter above ground.
4. The EUT was set 3 meters from the interference receiving antenna, which was mounted on the top of a variable height antenna tower.
5. Corrected Reading: Antenna Factor + Cable Loss + Read Level - Preamp Factor = Level
6. For measurement below 1GHz, If the emission level of the EUT measured by the peak detector is 3 dB lower than the applicable limit, the peak emission level will be reported. Otherwise, the emission measurement will be repeated using the quasi-peak detector and reported.
7. Use the following spectrum analyzer settings:
 - (1) Span shall wide enough to fully capture the emission being measured;
 - (2) Set RBW=100 kHz for $f < 1 \text{ GHz}$; $\text{VBW} \geq \text{RBW}$; Sweep = auto; Detector function = peak; Trace = max hold;
 - (3) Set RBW = 1 MHz, VBW= 3MHz for $f \geq 1 \text{ GHz}$

	for peak measurement. For average measurement: VBW = 10 Hz, when duty cycle is no less than 98 percent. $VBW \geq 1/T$, when duty cycle is less than 98 percent where T is the minimum transmission duration over which the transmitter is on and is transmitting at its maximum power control level for the tested mode of operation.
Test results:	PASS

6.7.2. Test Instruments

Radiated Emission Test Site (966)				
Name of Equipment	Manufacturer	Model	Serial Number	Calibration Due
ESPI Test Receiver	ROHDE&SCHW ARZ	ESVD	100008	Sep.16 , 2015
Spectrum Analyzer	ROHDE&SCHW ARZ	FSEM	848597/001	Sep.16 , 2015
Spectrum Analyzer	Agilent	N9020A	MY49100060	Oct. 21, 2015
Pre-amplifier	EM Electronics Corporation CO.,LTD	EM30265	07032613	Sep.16 , 2015
Pre-amplifier	HP	8447D	2727A05017	Sep.16 , 2015
Loop antenna	ZHINAN	ZN30900A	12024	Dec.14 , 2015
Broadband Antenna	Schwarzbeck	VULB9163	340	Sep.16 , 2015
Horn Antenna	Schwarzbeck	BBHA 9120D	631	Sep.16 , 2015
Horn Antenna	Schwarzbeck	BBHA 9170	373	Sep.16 , 2015
Coax cable	TCT	RE-low-01	N/A	Sep.15 , 2015
Coax cable	TCT	RE-high-02	N/A	Sep.15 , 2015
Coax cable	TCT	RE-low-03	N/A	Sep.15 , 2015
Coax cable	TCT	RE-High-04	N/A	Sep.15 , 2015
Antenna Mast	CCS	CC-A-4M	N/A	Sep.15 , 2015
EMI Test Software	Shurple Technology	EZ-EMC	N/A	N/A

Note: The calibration interval of the above test instruments is 12 months and the calibrations are traceable to international system unit (SI).

6.7.3. Test Data

Please refer to following diagram for individual
Below 1GHz

Horizontal:

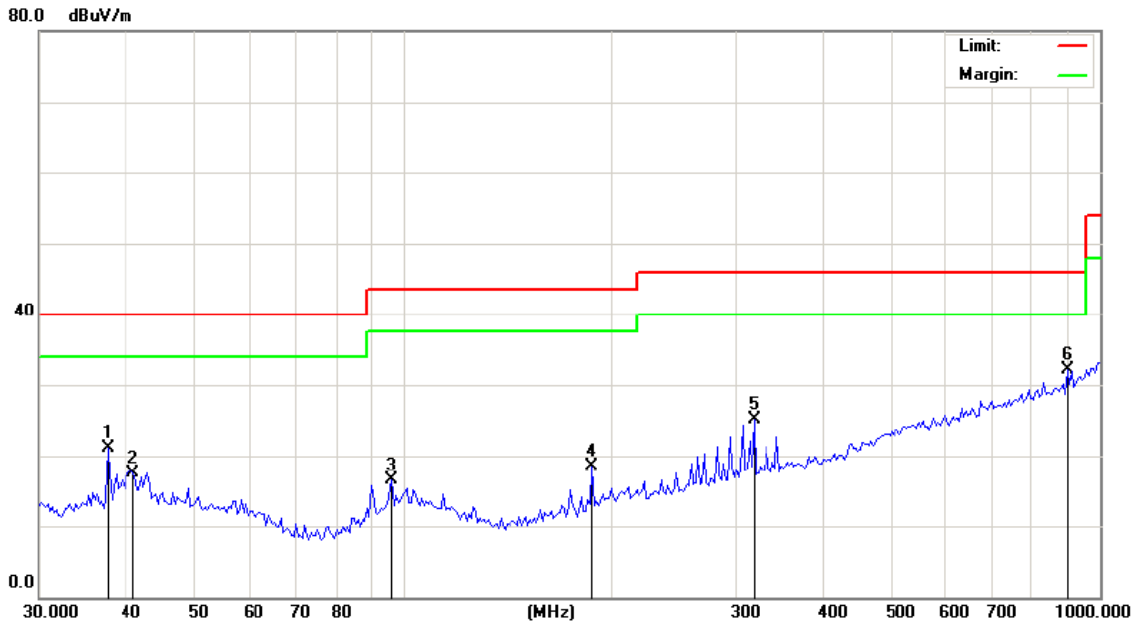

Site: Polarization: *Horizontal* Temperature: 25
Limit: FCC Part 15B Class B RE_3 m Power: DC 12V Humidity: 56 %

No.	Mk.	Freq. MHz	Reading Level dBuV	Correct Factor dB	Measure- ment dBuV/m	Limit dBuV/m	Over dB	Antenna Height cm	Table Degree	Comment
1		37.5648	33.88	-12.78	21.10	40.00	-18.90	peak	0	
2		40.8700	30.02	-12.44	17.58	40.00	-22.42	peak	0	
3		96.3230	28.41	-12.00	16.41	43.50	-27.09	peak	0	
4		186.4684	31.19	-12.62	18.57	43.50	-24.93	peak	0	
5		318.0875	33.01	-7.87	25.14	46.00	-20.86	peak	0	
6	*	899.9577	29.39	2.67	32.06	46.00	-13.94	peak	0	

Vertical:

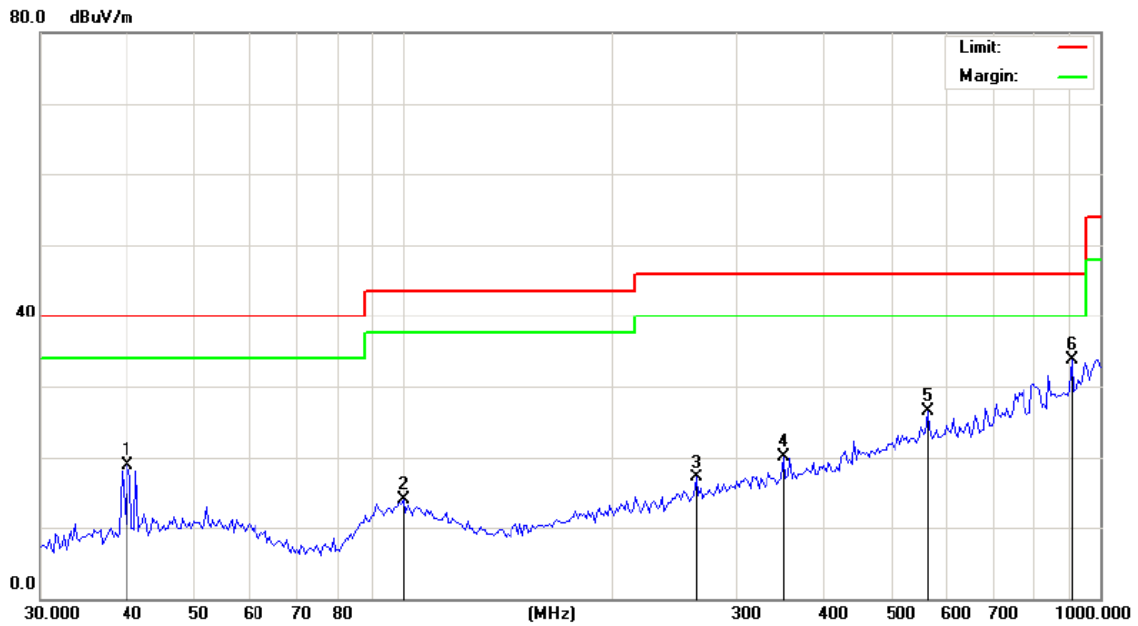

Site: Polarization: **Vertical** Temperature: 25
 Limit: FCC Part 15B Class B RE_3 m Power: DC 12V Humidity: 56 %

No. Mk.	Freq. MHz	Reading Level dBuV	Correct Factor dB	Measurement dBuV/m	Limit dBuV/m	Over dB	Antenna Height cm	Table Degree	Detector	Comment
1	40.0172	31.39	-12.47	18.92	40.00	-21.08	0	peak		
2	99.7676	25.29	-11.47	13.82	43.50	-29.68	0	peak		
3	263.1154	26.70	-9.51	17.19	46.00	-28.81	0	peak		
4	350.9721	27.25	-7.20	20.05	46.00	-25.95	0	peak		
5	565.9776	28.76	-2.28	26.48	46.00	-19.52	0	peak		
6 *	912.6951	30.58	3.10	33.68	46.00	-12.32	0	peak		

Note: 1. The low frequency, which started from 9KHz~30MHz, was pre-scanned and the result which was 20dB lower than the limit line per 15.31(o) was not reported

2. Measurements were conducted in all three channels (high, middle, low), and the worst case Mode (Highest channel) was submitted only.

Test Result of Radiated Spurious at Band edges

Modulation Type: GFSK

Low channel: 2402 MHz

Frequency (MHz)	Ant. Pol. H/V	Peak reading (dB μ V)	Correction Factor (dB/m)	Peak Final Emission Level	Peak limit (dB μ V/m)	AV limit (dB μ V/m)
2310	H	37.59	-4.20	33.39	74.00	54.00
2388.89	H	38.89	-4.20	34.69	74.00	54.00
2390	H	38.45	-3.94	34.51	74.00	54.00
2310	V	37.95	-4.20	33.75	74.00	54.00
2388.89	V	39.08	-4.20	34.88	74.00	54.00
2390	V	38.89	-3.94	34.95	74.00	54.00

Modulation Type: GFSK

Low channel: 2480 MHz

Frequency (MHz)	Ant. Pol. H/V	Peak reading (dB μ V)	Correction Factor (dB/m)	Peak Final Emission Level	Peak limit (dB μ V/m)	AV limit (dB μ V/m)
2483.5	H	38.54	-3.60	34.94	74.00	54.00
2486.7	H	37.56	-3.50	34.06	74.00	54.00
2500	H	35.75	-3.34	32.41	74.00	54.00
2483.5	V	37.56	-3.60	33.96	74.00	54.00
2486.7	V	36.57	-3.50	33.07	74.00	54.00
2500	V	35.28	-3.34	31.94	74.00	54.00

Note:

1. Peak Final Emission Level=Peak Reading + Correction Factor;
2. Correction Factor= Antenna Factor + Cable loss – Pre-amplifier

Above 1GHz

Low channel: 2402 MHz									
Frequency (MHz)	Ant. Pol. H/V	Peak reading (dB μ V)	AV reading (dB μ V)	Correction Factor (dB/m)	Emission Level		Peak limit (dB μ V/m)	AV limit (dB μ V/m)	Margin (dB)
					Peak (dB μ V/m)	AV (dB μ V/m)			
4804	H	37.56	---	0.66	38.22	---	74.00	54.00	-15.78
7206	H	33.89	---	9.50	43.39	---	74.00	54.00	-10.61
---	H	---	---	---	---	---	---	---	---
4804	V	37.54	---	0.66	38.2	---	74.00	54.00	-15.80
7206	V	35.64	---	9.50	45.14	---	74.00	54.00	-8.86
---	V	---	---	---	---	---	---	---	---

Middle channel: 2440MHz									
Frequency (MHz)	Ant. Pol. H/V	Peak reading (dB μ V)	AV reading (dB μ V)	Correction Factor (dB/m)	Emission Level		Peak limit (dB μ V/m)	AV limit (dB μ V/m)	Margin (dB)
					Peak (dB μ V/m)	AV (dB μ V/m)			
4880	H	38.79	---	0.99	39.78	---	74.00	54.00	-14.22
7320	H	34.86	---	9.85	44.71	---	74.00	54.00	-9.29
---	H	---	---	---	---	---	---	---	---
4880	V	38.93	---	0.99	39.92	---	74.00	54.00	-14.08
7320	V	34.58	---	9.85	44.43	---	74.00	54.00	-9.57
---	V	---	---	---	---	---	---	---	---

High channel: 2480 MHz									
Frequency (MHz)	Ant. Pol. H/V	Peak reading (dB μ V)	AV reading (dB μ V)	Correction Factor (dB/m)	Emission Level		Peak limit (dB μ V/m)	AV limit (dB μ V/m)	Margin (dB)
					Peak (dB μ V/m)	AV (dB μ V/m)			
4960	H	39.06	---	1.33	40.39	---	74.00	54.00	-13.61
7440	H	36.03	---	10.22	46.25	---	74.00	54.00	-7.75
---	H	---	---	---	---	---	---	---	---
4960	V	38.25	---	1.33	39.58	---	74.00	54.00	-14.42
7440	V	34.66	---	10.22	44.88	---	74.00	54.00	-9.12
---	V	---	---	---	---	---	---	---	---

Note:

1. Emission Level=Peak Reading + Correction Factor; Correction Factor= Antenna Factor + Cable loss – Pre-amplifier
2. Margin (dB) = Emission Level (Peak) (dB μ V/m)-Average limit (dB μ V/m)
3. The emission levels of other frequencies are very lower than the limit and not show in test report.
4. Measurements were conducted from 1 GHz to the 10th harmonic of highest fundamental frequency. The highest test frequency is 25GHz.
5. Data of measurement shown "---" in the above table mean that the reading of emissions is attenuated more than 20 dB below the limits or the field strength is too small to be measured.

*******END OF REPORT*******