



FCC RF Test Report

APPLICANT : Motorola Mobility LLC
EQUIPMENT : Mobile Cellular Phone
BRAND NAME : Motorola
MODEL NAME : XT2171-2
FCC ID : IHDT56ZX4
STANDARD : 47 CFR Part 2, 22(H), 24(E), 27(M)
CLASSIFICATION : PCS Licensed Transmitter Held to Ear (PCE)
TEST DATE(S) : Sep. 26, 2021 ~ Oct. 08, 2021

We, Sporton International (ShenZhen) Inc., would like to declare that the tested sample has been evaluated in accordance with the procedures given in ANSI C63.26-2015 and shown compliance with the applicable technical standards.

The test results in this report apply exclusively to the tested model / sample. Without written approval of Sporton International (ShenZhen) Inc., the test report shall not be reproduced except in full.

Reviewed by: Derreck Chen / Supervisor

Approved by: Eric Shih / Manager



Sporton International (ShenZhen) Inc.

1/F, 2/F, Bldg 5, Shiling Industrial Zone, Xinwei Village, Xili, Nanshan, Shenzhen, 518055

People's Republic of China



TABLE OF CONTENTS

REVISION HISTORY 3
SUMMARY OF TEST RESULT 4
1 GENERAL DESCRIPTION 5
1.1 Applicant 5
1.2 Manufacturer 5
1.3 Product Feature of Equipment Under Test 5
1.4 Product Specification of Equipment Under Test 6
1.5 Modification of EUT 6
1.6 Specification of Accessory 7
1.7 Re-use of Measured Data 8
1.8 Maximum EIRP Power and Emission Designator 9
1.9 Testing Location 10
1.10 Test Software 10
1.11 Applicable Standards 10
2 TEST CONFIGURATION OF EQUIPMENT UNDER TEST 11
2.1 Test Mode 11
2.2 Connection Diagram of Test System 12
2.3 Support Unit used in test configuration and system 12
2.4 Measurement Results Explanation Example 12
2.5 Frequency List of Low/Middle/High Channels 13
3 CONDUCTED TEST ITEMS 14
3.1 Measuring Instruments 14
3.2 Test Setup 14
3.3 Test Result of Conducted Test 14
3.4 Conducted Output Power and EIRP 15
3.5 Peak-to-Average Ratio 16
3.6 Occupied Bandwidth 17
3.7 Conducted Band Edge 18
3.8 Conducted Spurious Emission 19
3.9 Frequency Stability 20
4 RADIATED TEST ITEMS 21
4.1 Measuring Instruments 21
4.2 Test Setup 21
4.3 Test Result of Radiated Test 22
4.4 Radiated Spurious Emission 23
5 LIST OF MEASURING EQUIPMENT 24
6 UNCERTAINTY OF EVALUATION 25
APPENDIX A. TEST RESULTS OF CONDUCTED TEST
APPENDIX B. TEST RESULTS OF RADIATED TEST
APPENDIX C. TEST SETUP PHOTOGRAPHS
APPENDIX D. REFERENCE REPORT



REVISION HISTORY

REPORT NO.	VERSION	DESCRIPTION	ISSUED DATE
FG180410B	Rev. 01	Initial issue of report	Oct. 08, 2021



SUMMARY OF TEST RESULT

Report Section	FCC Rule	Description	Limit	Result	Remark
3.4	§2.1046	Conducted Output Power	-	Report Only	-
	§27.50(h)(2)	Equivalent Isotropic Radiated Power (Band 41)	EIRP < 2Watt	PASS	-
3.5	-	Peak-to-Average Ratio	<13 dB	PASS	-
3.6	§2.1049	Occupied Bandwidth	Report Only	Report Only	-
3.7	§27.53(m)(4)	Conducted Band Edge Measurement (Band 41)	§27.53(m)(4)	PASS	-
3.8	§2.1051 §27.53(m)(4)	Conducted Spurious Emission (Band 41)	< 55+10log ₁₀ (P[Watts])	PASS	-
3.9	§2.1055 §27.54	Frequency Stability Temperature & Voltage	Within Authorized Band	PASS	-
4.4	§2.1053 §27.53(m)(4)	Radiated Spurious Emission (Band 41)	< 55+10log ₁₀ (P[Watts])	PASS	Under limit 17.89 dB at 10336.360MHz

Declaration of Conformity:

The test results with all measurement uncertainty excluded are presented in accordance with the regulation limits or requirements declared by manufacturers.

Comments and Explanations:

The declared of product specification for EUT presented in the report are provided by the manufacturer, and the manufacturer takes all the responsibilities for the accuracy of product specification.



1 General Description

1.1 Applicant

Motorola Mobility LLC
222 W, Merchandise Mart Plaza, Chicago IL 60654 USA

1.2 Manufacturer

Motorola Mobility LLC
222 W, Merchandise Mart Plaza, Chicago IL 60654 USA

1.3 Product Feature of Equipment Under Test

Product Feature	
Equipment	Mobile Cellular Phone
Brand Name	Motorola
Model Name	XT2171-2
FCC ID	IHDT56ZX4
IMEI Code	Conducted: 352867310022377&352867310022385 Radiation: 352867310021536/352867310021544
HW Version	DVT2
SW Version	RRYA31.Q3-23
EUT Stage	Identical Prototype



1.4 Product Specification of Equipment Under Test

Standards-related Product Specification	
Tx Frequency	LTE Band 2 : 1850 MHz ~ 1910 MHz LTE Band 5 : 824 MHz ~ 849 MHz LTE Band 7 : 2500 MHz ~ 2570 MHz LTE Band 26 : 824 MHz ~ 849 MHz LTE Band 38 : 2570 MHz ~ 2620 MHz LTE Band 41 : 2535 MHz ~ 2655 MHz
Rx Frequency	LTE Band 2 : 1930 MHz ~ 1990 MHz LTE Band 5 : 869 MHz ~ 894 MHz LTE Band 7 : 2620 MHz ~ 2690 MHz LTE Band 26 : 869 MHz ~ 894 MHz LTE Band 38 : 2570 MHz ~ 2620 MHz LTE Band 41 : 2535 MHz ~ 2655 MHz
Bandwidth	LTE Band 2 : 1.4MHz / 3MHz / 5MHz / 10MHz / 15MHz / 20MHz LTE Band 5 : 1.4MHz / 3MHz / 5MHz / 10MHz LTE Band 7 : 5MHz / 10MHz / 15MHz / 20MHz LTE Band 26 : 1.4MHz / 3MHz / 5MHz / 10MHz / 15MHz LTE Band 38 : 5MHz / 10MHz / 15MHz / 20MHz LTE Band 41 : 5MHz / 10MHz / 15MHz / 20MHz
Maximum Output Power to Antenna	LTE Band 41 : 23.07 dBm
Maximum Output Power to Antenna	LTE Band 41 : -2.6 dBi
Type of Modulation	QPSK / 16QAM / 64QAM / 256QAM

Note: For QAM modulation mode, the whole testing has assessed 16QAM&64QAM mode by referring to their higher conducted power.

1.5 Modification of EUT

No modifications are made to the EUT during all test items.



1.6 Specification of Accessory

Specification of Accessory				
AC Adapter 1(US)	Brand Name	Motorola(Chenyang)	Model Name	MC-101
AC Adapter 1(EU)	Brand Name	Motorola(Chenyang)	Model Name	MC-102
AC Adapter 1(UK)	Brand Name	Motorola(Chenyang)	Model Name	MC-103
AC Adapter 1(AU)	Brand Name	Motorola(Chenyang)	Model Name	MC-105
AC Adapter 2(US)	Brand Name	Motorola(Salcomp)	Model Name	MC-101
AC Adapter 2(EU)	Brand Name	Motorola(Salcomp)	Model Name	MC-102
AC Adapter 2(UK)	Brand Name	Motorola(Salcomp)	Model Name	MC-103
AC Adapter 2(AU)	Brand Name	Motorola(Salcomp)	Model Name	MC-105
AC Adapter 3(US)	Brand Name	Motorola(Aohai)	Model Name	MC-101
AC Adapter 3(EU)	Brand Name	Motorola(Aohai)	Model Name	MC-102
AC Adapter 3(UK)	Brand Name	Motorola(Aohai)	Model Name	MC-103
AC Adapter 3(AU)	Brand Name	Motorola(Aohai)	Model Name	MC-105
AC Adapter 4(US)	Brand Name	Motorola(Chenyang)	Model Name	MC-201
AC Adapter 4(AR)	Brand Name	Motorola(Chenyang)	Model Name	MC-206
AC Adapter 5(US)	Brand Name	Motorola(Acbel)	Model Name	MC-201
AC Adapter 5(AR)	Brand Name	Motorola(Acbel)	Model Name	MC-206
AC Adapter 5(Chile)	Brand Name	Motorola(Acbel)	Model Name	MC-209
AC Adapter 6(IN)	Brand Name	Motorola(Chenyang)	Model Name	MC-204
AC Adapter 7(IN)	Brand Name	Motorola(Aohai)	Model Name	MC-204
AC Adapter 8 (BR Local build)	Brand Name	Motorola(Salcomp)	Model Name	MC-207
AC Adapter 9 (BR Local build)	Brand Name	Motorola(Flex)	Model Name	MC-207
AC Adapter 10(US)	Brand Name	Motorola(Chenyang)	Model Name	MC-201
Earphone 1	Brand Name	Motorola(Juwei)	Model Name	MH202(JWEP1182-T03H)
Earphone 2	Brand Name	Motorola(New Leader)	Model Name	MH202(NLD-EM313A-11SF)
Earphone 3	Brand Name	Motorola(Juwei)	Model Name	MH191(JWEP1209-T03H)
Earphone 4	Brand Name	Motorola(New Leader)	Model Name	MH191(NLD-EM313A-21SF)
USB Cable 1	Brand Name	Motorola(Chuangyitong)	Model Name	88806-024
USB Cable 2	Brand Name	Motorola(SUNTOPS)	Model Name	336258
USB Cable 3	Brand Name	Motorola(I SHENG)	Model Name	SC18C28955
Battery	Brand Name	Motorola(ATL)	Model Name	JK50



1.7 Re-use of Measured Data

1.7.1 Introduction Section

This application re-uses data collected on a similar device. The subject device of this application (Model: XT2171-2, FCC ID: IHDT56ZX4) is electrically identical to the reference device (Model: XT2171-1, FCC ID: IHDT56ZX3) for the portions of the circuitry corresponding to the data being re-used, as treated by KDB Publication 484596 D01.

The applicant takes full responsibility that the test data as referenced in this report represent compliance for this FCC ID: IHDT56ZX4.

1.7.2 Difference Section

The main difference between FCC ID: IHDT56ZX3 and FCC ID: IHDT56ZX4 is as below:

- Remove WCDMA Band IV, LTE Band 4/12/13/17/66 and 5G NR n66.
- Add WCDMA Band XIX, LTE Band 18/19/20/32/41 and 5G NR n20/n38/n41/n77.

Other differences and all the details of similarity and difference can be found in the confidential documents (XT2171-2_Operational Description of Product Equality Declaration).

1.7.3 Reference detail Section:

Equipment Class	Reference FCC ID	Folder Test	Report Title/Section
PCE	IHDT56ZX3	Part22H.24E.27L.27M.27H.27F (Report No. FG180409B)	All sections applicable for LTE Band 2/5/7/7C/26/38

1.7.4 Spot Check Verification Data Section

Conducted power test against the variant model based on the worst-case condition from the original model was performed in this filing to demonstrate the test data from original model remains representative for the variant model and LTE Band 41 to full test.

Summary for power spot check for each rule entry and technology is listed as below:

Test Item	Mode	IHDT56ZX3 Worst Result	IHDT56ZX4 Worst Result	Difference (dB)
Conducted Power (dBm)	LTE Band 2	22.50	22.70	0.20
	LTE Band 5	22.59	22.79	0.20
	LTE Band 7	22.70	22.90	0.20
	LTE Band 26	22.60	22.80	0.20



	LTE Band 38	23.06	23.06	0
--	-------------	-------	-------	---

Conclusion:

Based on the spot check test result, the test data from the original model is representative for the variant model. The power level spot check is shown within expected level compliant to limit line.

We are using power and ERP/EIRP measurements from the original parent model reports to list on the grant.

We confirm that the test data reuse policy of FCC KDB 484596 D01 Referencing Test Data v01 has been followed and the test data as referenced from the parent model report represents compliance with new FCC ID.

1.8 Maximum EIRP Power and Emission Designator

LTE Band 41		QPSK		16QAM/64QAM	
BW (MHz)	Frequency Range (MHz)	Maximum EIRP(W)	Emission Designator (99%OBW)	Maximum EIRP(W)	Emission Designator (99%OBW)
5	2537.5 ~ 2652.5	0.1109	4M53G7D	0.0918	4M52W7D
10	2540.0 ~ 2650.0	0.1102	9M05G7D	0.0916	9M07W7D
15	2542.5 ~ 2647.5	0.1084	13M5G7D	0.0883	13M5W7D
20	2545.0 ~ 2645.0	0.1114	17M9G7D	0.0910	17M9W7D

Note: All modulations have been tested, and only the worst test results of PSK & QAM are shown in the report.



1.9 Testing Location

Sporton International (Shenzhen) Inc. is accredited to ISO/IEC 17025:2017 by American Association for Laboratory Accreditation with Certificate Number 5145.01.

Test Firm	Sporton International (Shenzhen) Inc.		
Test Site Location	1/F, 2/F, Bldg 5, Shiling Industrial Zone, Xinwei Village, Xili, Nanshan, Shenzhen, 518055 People's Republic of China TEL: +86-755-86379589 FAX: +86-755-86379595		
Test Site No.	Sporton Site No.	FCC Designation No.	FCC Test Firm Registration No.
	TH01-SZ	CN1256	421272

Test Firm	Sporton International (Shenzhen) Inc.		
Test Site Location	101, 1st Floor, Block B, Building 1, No. 2, Tengfeng 4th Road, Fenghuang Community, Fuyong Street, Baoan District, Shenzhen City Guangdong Province China 518103 TEL: +86-755-33202398		
Test Site No.	Sporton Site No.	FCC Designation No.	FCC Test Firm Registration No.
	03CH01-SZ	CN1256	421272

1.10 Test Software

Item	Site	Manufacture	Name	Version
1.	03CH01-SZ	AUDIX	E3	6.2009-8-24

1.11 Applicable Standards

According to the specifications of the manufacturer, the EUT must comply with the requirements of the following standards:

- 47 CFR Part 2, 22(H), 24(E), 27(M)
- ANSI C63.26-2015
- FCC KDB 971168 D01 Power Meas License Digital Systems v03r01
- FCC KDB 412172 D01 Determining ERP and EIRP v01r01

Remark:

1. All test items were verified and recorded according to the standards and without any deviation during the test.
2. This EUT has also been tested and complied with the requirements of FCC Part 15, Subpart B, recorded in a separate test report.



2 Test Configuration of Equipment Under Test

2.1 Test Mode

Antenna port conducted and radiated test items listed below are performed according to KDB 971168 D01 Power Meas License Digital Systems v03r01 with maximum output power.

Radiated measurements are performed by rotating the EUT in three different orthogonal test planes to find the maximum emission.

Test Items	Band	Bandwidth (MHz)						Modulation				RB #			Test Channel			
		1.4	3	5	10	15	20	QPSK	16QAM	64QAM	256 QAM	1	Half	Full	L	M	H	
Max. Output Power	41	-	-	v	v	v	v	v	v	v	v	v	v	v	v	v	v	
Peak-to-Average Ratio	41	-	-				v	v	v	v		v		v	v	v	v	
26dB and 99% Bandwidth	41	-	-	v	v	v	v	v	v	v				v	v	v	v	
Conducted Band Edge	41	-	-	v	v	v	v	v	v	v		v		v			v	
Conducted Spurious Emission	41	-	-	v	v	v	v	v	v	v		v			v	v	v	
Frequency Stability	41	-	-		v			v						v		v		
E.I.R.P	41	-	-	v	v	v	v	v	v	v		v			v	v	v	
Radiated Spurious Emission	41	Worst Case															v	
Note	1. The mark "v " means that this configuration is chosen for testing 2. The mark "-" means that this bandwidth is not supported. 3. The device is investigated from 30MHz to 10 times of fundamental signal for radiated spurious emission test under different RB size/offset and modulations in exploratory test. Subsequently, only the worst case emissions are reported.																	

2.2 Connection Diagram of Test System

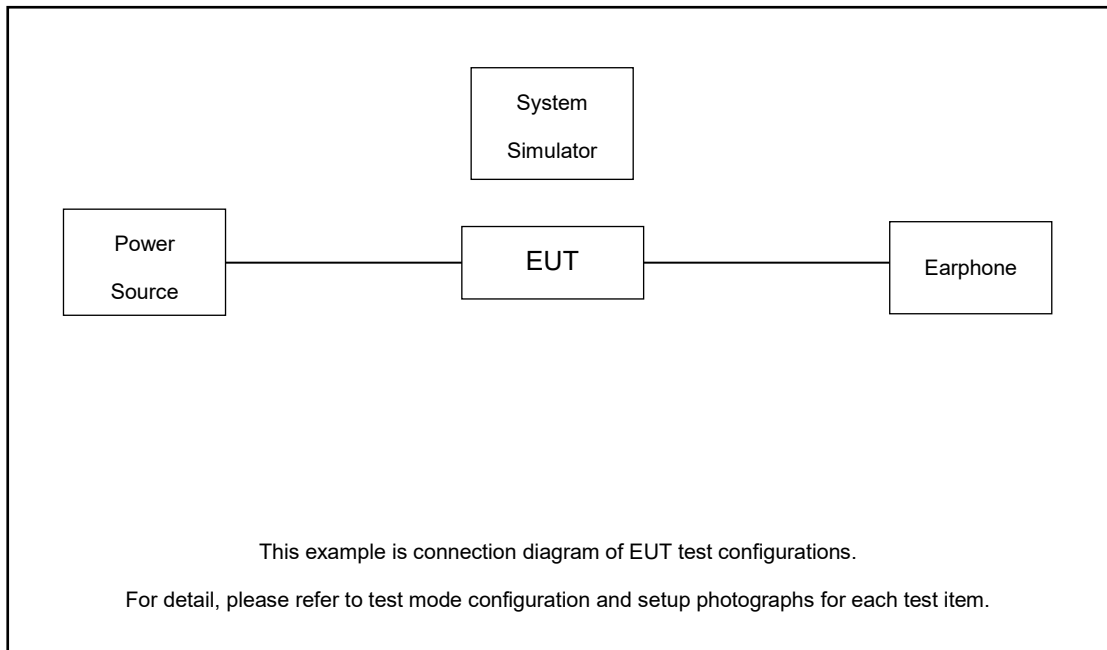

2.3 Support Unit used in test configuration and system

Item	Equipment	Trade Name	Model No.	FCC ID	Data Cable	Power Cord
1.	LTE Base Station	Anritsu	MT8820C	N/A	N/A	Unshielded, 1.8 m

2.4 Measurement Results Explanation Example

For all conducted test items:

The offset level is set in the spectrum analyzer to compensate the RF cable loss and attenuator factor between EUT conducted output port and spectrum analyzer. With the offset compensation, the spectrum analyzer reading level is exactly the EUT RF output level.

The spectrum analyzer offset is derived from RF cable loss and attenuator factor.

Offset = RF cable loss + attenuator factor.

Following shows an offset computation example with cable loss 5.0 dB and 10dB attenuator.

Example :

$$\begin{aligned} \text{Offset(dB)} &= \text{RF cable loss(dB)} + \text{attenuator factor(dB)} \\ &= 5.0 + 10 = 15.0 \text{ (dB)} \end{aligned}$$



2.5 Frequency List of Low/Middle/High Channels

LTE Band 41 Channel and Frequency List				
BW [MHz]	Channel/Frequency(MHz)	Lowest	Middle	Highest
20	Channel	40140	40640	41140
	Frequency	2545	2595	2645
15	Channel	40115	40640	41165
	Frequency	2542.5	2595	2647.5
10	Channel	40090	40640	41190
	Frequency	2540	2595	2650
5	Channel	40065	40640	41215
	Frequency	2537.5	2595	2652.5

3 Conducted Test Items

3.1 Measuring Instruments

See list of measuring instruments of this test report.

3.2 Test Setup

3.2.1 Conducted Output Power

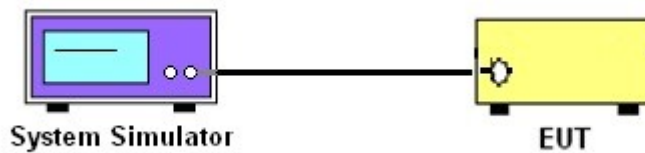

3.2.2 Peak-to-Average Ratio, Occupied Bandwidth, Conducted Band-Edge and Conducted Spurious Emission



3.2.3 Frequency Stability

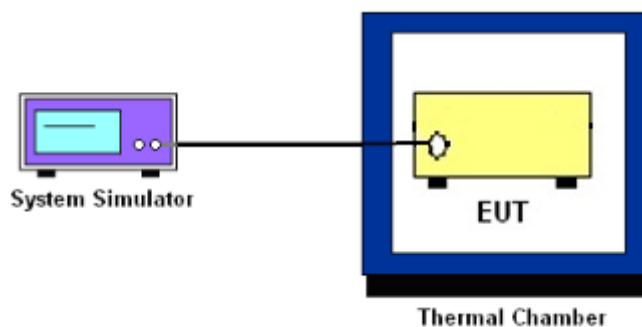

3.3 Test Result of Conducted Test

Please refer to Appendix A.



3.4 Conducted Output Power and EIRP

3.4.1 Description of the Conducted Output Power Measurement and EIRP Measurement

A system simulator was used to establish communication with the EUT. Its parameters were set to force the EUT transmitting at maximum output power. The measured power in the radio frequency on the transmitter output terminals shall be reported.

The EIRP of mobile transmitters must not exceed 2 Watts for LTE Band 41.

According to KDB 412172 D01 Power Approach,

$EIRP = P_T + G_T - L_C$, $ERP = EIRP - 2.15$, where

P_T = transmitter output power in dBm

G_T = gain of the transmitting antenna in dBi

L_C = signal attenuation in the connecting cable between the transmitter and antenna in dB

3.4.2 Test Procedures

1. The testing follows ANSI C63.26 Section 5.2
2. The transmitter output port was connected to the system simulator.
3. Set EUT at maximum power through the system simulator.
4. Select lowest, middle, and highest channels for each band and different modulation.
5. Measure and record the power level from the system simulator.



3.5 Peak-to-Average Ratio

3.5.1 Description of the PAR Measurement

Power Complementary Cumulative Distribution Function (CCDF) curves provide a means for characterizing the power peaks of a digitally modulated signal on a statistical basis. A CCDF curve depicts the probability of the peak signal amplitude exceeding the average power level. Most contemporary measurement instrumentation include the capability to produce CCDF curves for an input signal provided that the instrument's resolution bandwidth can be set wide enough to accommodate the entire input signal bandwidth. In measuring transmissions in this band using an average power technique, the peak-to-average ratio (PAR) of the transmission may not exceed 13 dB.

3.5.2 Test Procedures

1. The testing follows ANSI C63.26 Section 5.2.3.4 (CCDF).
2. The EUT was connected to spectrum and system simulator via a power divider.
3. Set the CCDF (Complementary Cumulative Distribution Function) option in spectrum analyzer.
4. The highest RF powers were measured and recorded the maximum PAPR level associated with a probability of 0.1 %.
5. Record the deviation as Peak to Average Ratio.



3.6 Occupied Bandwidth

3.6.1 Description of Occupied Bandwidth Measurement

The occupied bandwidth is the width of a frequency band such that, below the lower and above the upper frequency limits, the mean powers emitted are each equal to a specified percentage 0.5% of the total mean transmitted power.

The 26 dB emission bandwidth is defined as the frequency range between two points, one above and one below the carrier frequency, at which the spectral density of the emission is attenuated 26 dB below the maximum in-band spectral density of the modulated signal. Spectral density (power per unit bandwidth) is to be measured with a detector of resolution bandwidth equal to approximately 1.0% of the emission bandwidth.

3.6.2 Test Procedures

1. The testing follows ANSI C63.26 Section 5.4
2. The EUT was connected to spectrum analyzer and system simulator via a power divider.
3. The spectrum analyzer center frequency is set to the nominal EUT channel center frequency. The span range for the spectrum analyzer shall be between two and five times the anticipated OBW.
4. The nominal resolution bandwidth (RBW) shall be in the range of 1 to 5 % of the anticipated OBW, and the VBW shall be at least 3 times the RBW.
5. Set the detection mode to peak, and the trace mode to max hold.
6. Determine the reference value: Set the EUT to transmit a modulated signal. Allow the trace to stabilize. Set the spectrum analyzer marker to the highest level of the displayed trace.
(this is the reference value)
7. Determine the “-26 dB down amplitude” as equal to (Reference Value – X).
8. Place two markers, one at the lowest and the other at the highest frequency of the envelope of the spectral display such that each marker is at or slightly below the “-X dB down amplitude” determined in step 6. If a marker is below this “-X dB down amplitude” value it shall be placed as close as possible to this value. The OBW is the positive frequency difference between the two markers.
9. Use the 99 % power bandwidth function of the spectrum analyzer and report the measured bandwidth.



3.7 Conducted Band Edge

3.7.1 Description of Conducted Band Edge Measurement

27.53(m)(4)

For mobile digital stations, the attenuation factor shall be not less than $40 + 10 \log (P)$ dB on all frequencies between the channel edge and 5 megahertz from the channel edge, $43 + 10 \log (P)$ dB on all frequencies between 5 megahertz and X megahertz from the channel edge, and $55 + 10 \log (P)$ dB on all frequencies more than X megahertz from the channel edge, where X is the greater of 6 megahertz or the actual emission bandwidth as defined in paragraph (m)(6) of this section. In addition, the attenuation factor shall not be less that $43 + 10 \log (P)$ dB on all frequencies between 2490.5 MHz and 2496 MHz and $55 + 10 \log (P)$ dB at or below 2490.5 MHz. Mobile Satellite Service licensees operating on frequencies below 2495 MHz may also submit a documented interference complaint against BRS licensees operating on channel BRS Channel 1 on the same terms and conditions as adjacent channel BRS or EBS licensees.

3.7.2 Test Procedures

1. The testing follows ANSI C63.26 section 5.7
2. The EUT was connected to spectrum analyzer and system simulator via a power divider.
3. The band edges of low and high channels for the highest RF powers were measured.
4. Set RBW \geq 1% EBW in the 1MHz band immediately outside and adjacent to the band edge.
5. Beyond the 1 MHz band from the band edge, RBW=1MHz was used.
6. Set spectrum analyzer with RMS detector.
7. The RF fundamental frequency should be excluded against the limit line in the operating frequency band.
8. Checked that all the results comply with the emission limit line.

Example:

The limit line is derived from $43 + 10\log(P)$ dB below the transmitter power P(Watts)
= P(W)- [43 + 10log(P)] (dB)
= [30 + 10log(P)] (dBm) - [43 + 10log(P)] (dB) = -13dBm.

9. For LTE Band 41, the other 40 dB, and 55 dB have additionally applied same calculation above.



3.8 Conducted Spurious Emission

3.8.1 Description of Conducted Spurious Emission Measurement

The power of any emission outside of the authorized operating frequency ranges must be lower than the transmitter power (P) by a factor of at least $43 + 10 \log (P)$ dB.

For Band 41:

The power of any emission outside of the authorized operating frequency ranges must be lower than the transmitter power (P) by a factor of at least $55 + 10 \log (P)$ dB.

It is measured by means of a calibrated spectrum analyzer and scanned from 30 MHz up to a frequency including its 10th harmonic.

3.8.2 Test Procedures

1. The testing follows ANSI C63.26 section 5.7
2. The EUT was connected to spectrum analyzer and system simulator via a power divider.
3. The RF output of EUT was connected to the spectrum analyzer by RF cable and attenuator. The path loss was compensated to the results for each measurement.
4. The middle channel for the highest RF power within the transmitting frequency was measured.
5. The conducted spurious emission for the whole frequency range was taken.
6. Make the measurement with the spectrum analyzer's RBW = 1MHz, VBW = 3MHz.
7. Set spectrum analyzer with RMS detector.
8. Taking the record of maximum spurious emission.
9. The RF fundamental frequency should be excluded against the limit line in the operating frequency band.
10. The limit line is derived from $43 + 10\log(P)$ dB below the transmitter power P(Watts)
 $= P(W) - [43 + 10\log(P)]$ (dB)
 $= [30 + 10\log(P)]$ (dBm) - $[43 + 10\log(P)]$ (dB)
 $= -13$ dBm.
11. For Band 41
The limit line is derived from $55 + 10\log(P)$ dB below the transmitter power P(Watts)
 $= P(W) - [55 + 10\log(P)]$ (dB)
 $= [30 + 10\log(P)]$ (dBm) - $[55 + 10\log(P)]$ (dB)
 $= -25$ dBm.



3.9 Frequency Stability

3.9.1 Description of Frequency Stability Measurement

The frequency stability shall be measured by variation of ambient temperature and variation of primary supply voltage to ensure that the fundamental emission stays within the authorized frequency block. The frequency stability of the transmitter shall be maintained within $\pm 0.00025\%$ ($\pm 2.5\text{ppm}$) of the center frequency.

3.9.2 Test Procedures for Temperature Variation

1. The testing follows ANSI C63.26 section 5.6.4
2. The EUT was set up in the thermal chamber and connected with the system simulator.
3. With power OFF, the temperature was decreased to -30°C and the EUT was stabilized before testing. Power was applied and the maximum change in frequency was recorded within one minute.
4. With power OFF, the temperature was raised in 10°C step up to 50°C . The EUT was stabilized at each step for at least half an hour. Power was applied and the maximum frequency change was recorded within one minute.

3.9.3 Test Procedures for Voltage Variation

1. The testing follows ANSI C63.26 section 5.6.5
2. The EUT was placed in a temperature chamber at $20\pm 5^{\circ}\text{C}$ and connected with the system simulator.
3. The power supply voltage to the EUT was varied from 85% to 115% of the nominal value for other than hand carried battery equipment.
4. For hand carried, battery powered equipment, reduce the primary ac or dc supply voltage to the battery operating end point, which shall be specified by the manufacturer.
5. The variation in frequency was measured for the worst case.

4 Radiated Test Items

4.1 Measuring Instruments

See list of measuring instruments of this test report.

4.2 Test Setup

4.2.1 For radiated test below 30MHz

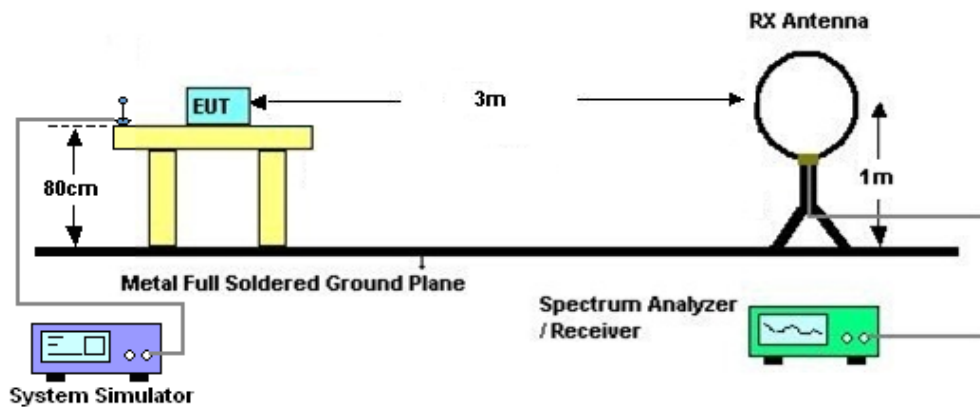

4.2.2 For radiated test from 30MHz to 1GHz

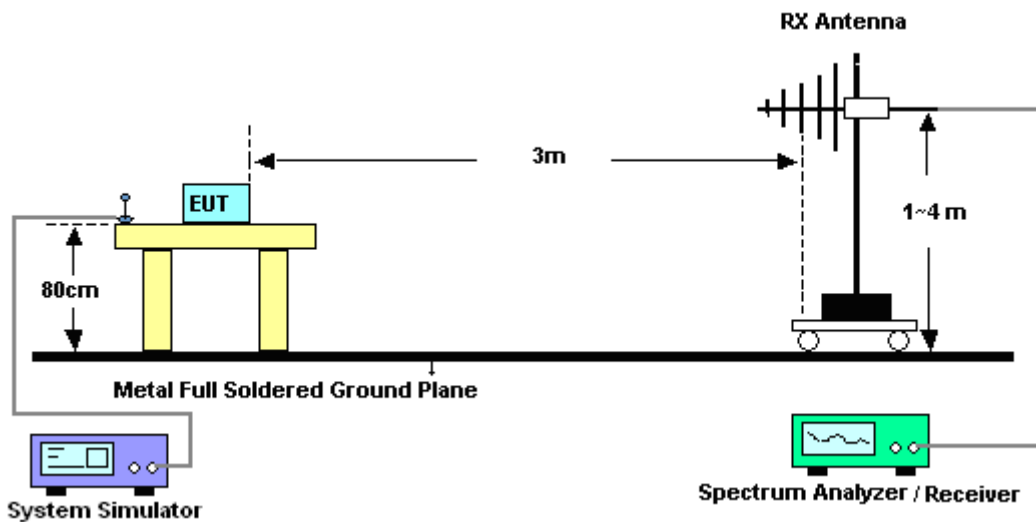

4.2.3 For radiated test above 1GHz

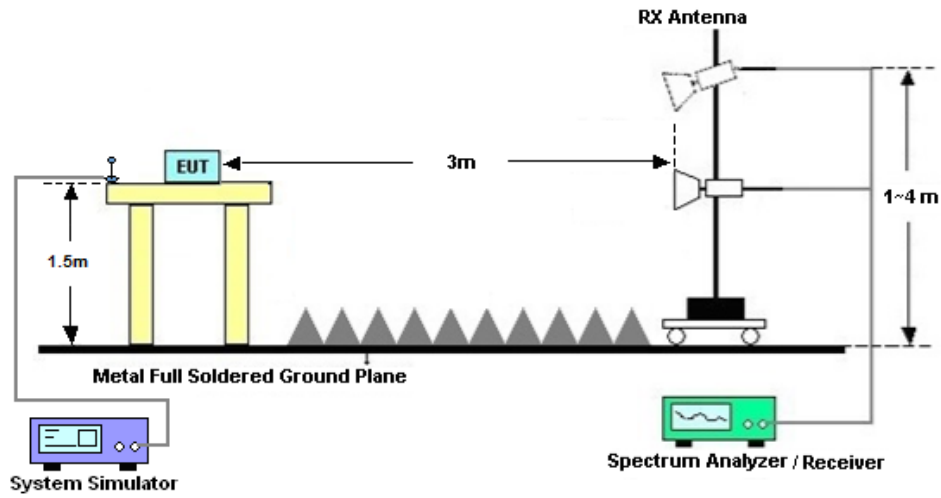

4.3 Test Result of Radiated Test

The low frequency, which started from 9 kHz to 30MHz, was pre-scanned and the result which was 20dB lower than the limit line was not reported.

Please refer to Appendix B.



4.4 Radiated Spurious Emission

4.4.1 Description of Radiated Spurious Emission

The radiated spurious emission was measured by substitution method according to ANSI C63.26.

For Band 41

The power of any emission outside of the authorized operating frequency ranges must be attenuated below the transmitter power (P) by a factor of at least $55 + 10 \log (P)$ dB.

The spectrum is scanned from 30 MHz up to a frequency including its 10th harmonic.

4.4.2 Test Procedures

1. The testing follows ANSI C63.26 Section 5.5
2. The EUT was placed on a turntable with 0.8 meter height for frequency below 1GHz and 1.5 meter height for frequency above 1GHz respectively above ground.
3. The EUT was set 3 meters from the receiving antenna mounted on the antenna tower.
4. The table was rotated 360 degrees to determine the position of the highest spurious emission.
5. The height of the receiving antenna is varied between 1m to 4m to search the maximum spurious emission for both horizontal and vertical polarizations.
6. During the measurement, the system simulator parameters were set to force the EUT transmitting at maximum output power.
7. Make the measurement with the spectrum analyzer's RBW = 1MHz, VBW = 3MHz, taking the record of maximum spurious emission.
8. A horn antenna was substituted in place of the EUT and was driven by a signal generator.
9. Tune the output power of signal generator to the same emission level with EUT maximum spurious emission.
10. $EIRP \text{ (dBm)} = S.G. \text{ Power} - Tx \text{ Cable Loss} + Tx \text{ Antenna Gain}$
11. $ERP \text{ (dBm)} = EIRP - 2.15$
12. The RF fundamental frequency should be excluded against the limit line in the operating frequency band.
The limit line is derived from $43 + 10\log(P)$ dB below the transmitter power P(Watts)
 $= P(W) - [43 + 10\log(P)] \text{ (dB)}$
 $= [30 + 10\log(P)] \text{ (dBm)} - [43 + 10\log(P)] \text{ (dB)}$
 $= -13\text{dBm}.$
13. For Band 41:
The limit line is derived from $55 + 10\log(P)$ dB below the transmitter power P(Watts)



5 List of Measuring Equipment

Instrument	Manufacturer	Model No.	Serial No.	Characteristics	Calibration Date	Test Date	Due Date	Remark
Spectrum Analyzer	R&S	FSV40	101078	10Hz~40GHz	Apr. 08, 2021	Sep. 26, 2021~ Oct. 08, 2021	Apr. 07, 2022	Conducted (TH01-SZ)
DC Power Supply	TTI	PL330P	290070	Max 32V , 3A	Oct. 15, 2020	Sep. 26, 2021~ Oct. 08, 2021	Oct. 14, 2021	Conducted (TH01-SZ)
Power Divider	TOJOIN	PS-2SM-04 265	60.06.020.007 7	0.4GHz~26.5GHz	Dec. 26, 2020	Sep. 26, 2021~ Oct. 08, 2021	Dec. 25, 2021	Conducted (TH01-SZ)
Thermal Chamber	Ten Billion Hongzhangroup	LP-150U	H2014081803	-40~+150°C	Jul. 14, 2021	Sep. 26, 2021~ Oct. 08, 2021	Jul. 13, 2022	Conducted (TH01-SZ)
EMI Test Receiver&SA	Agilent	N9038A	MY52260185	20Hz~26.5GHz	Dec. 03, 2020	Sep. 28, 2021	Dec. 02, 2021	Radiation (03CH01-SZ)
Loop Antenna	R&S	HFH2-Z2	100354	9kHz~30MHz	Jun. 22, 2021	Sep. 28, 2021	Jun. 21, 2022	Radiation (03CH01-SZ)
Bilog Antenna	TeseQ	CBL6112D	35407	30MHz-2GHz	Jul. 15, 2021	Sep. 28, 2021	Jul. 14, 2022	Radiation (03CH01-SZ)
Double Ridge Horn Antenna	ETS-Lindgren	3117	00119436	1GHz~18GHz	Jul. 25, 2021	Sep. 28, 2021	Jul. 24, 2022	Radiation (03CH01-SZ)
SHF-EHF Horn	com-power	AH-840	101071	18Ghz-40GHz	Apr. 11, 2021	Sep. 28, 2021	Apr. 10, 2022	Radiation (03CH01-SZ)
LF Amplifier	Burgeon	BPA-530	102209	0.01~3000Mhz	Apr. 07, 2021	Sep. 28, 2021	Apr. 06, 2022	Radiation (03CH01-SZ)
HF Amplifier	MITEQ	AMF-7D-00 101800-30-1 0P-R	1943528	1GHz~18GHz	Oct. 16, 2020	Sep. 28, 2021	Oct. 15, 2021	Radiation (03CH01-SZ)
HF Amplifier	KEYSIGHT	83017A	MY53270105	0.5GHz~26.5Ghz	Oct. 16, 2020	Sep. 28, 2021	Oct. 15, 2021	Radiation (03CH01-SZ)
HF Amplifier	MITEQ	TTA1840-35 -HG	1871923	18GHz~40GHz	Jul. 21, 2021	Sep. 28, 2021	Jul. 20, 2022	Radiation (03CH01-SZ)
AC Power Source	Chroma	61601	616010001985	N/A	NCR	Sep. 28, 2021	NCR	Radiation (03CH01-SZ)
Turn Table	EM	EM1000	N/A	0~360 degree	NCR	Sep. 28, 2021	NCR	Radiation (03CH01-SZ)
Antenna Mast	EM	EM1000	N/A	1 m~4 m	NCR	Sep. 28, 2021	NCR	Radiation (03CH01-SZ)

NCR: No Calibration Required



6 Uncertainty of Evaluation

The measurement uncertainties shown below were calculated in accordance with the requirements of ANSI 63.26-2015. All the measurement uncertainty value were shown with a coverage K=2 to indicate 95% level of confidence. The measurement data show herein meets or exceeds the CISPR measurement uncertainty values specified in CISPR 16-4-2 and can be compared directly to specified limit to determine compliance.

Uncertainty of Radiated Emission Measurement (30 MHz ~ 1000 MHz)

Measuring Uncertainty for a Level of Confidence of 95% (U = 2Uc(y))	2.48dB
---	--------

Uncertainty of Radiated Emission Measurement (1 GHz ~ 18 GHz)

Measuring Uncertainty for a Level of Confidence of 95% (U = 2Uc(y))	3.53dB
---	--------

Uncertainty of Radiated Emission Measurement (18 GHz ~ 40 GHz)

Measuring Uncertainty for a Level of Confidence of 95% (U = 2Uc(y))	4.02dB
---	--------



Appendix A. Test Results of Conducted Test

Conducted Output Power(Average power)

LTE Band 41:

BW [MHz]	Modulation	RB Size	RB Offset	Power Low Ch. / Freq.	Power Middle Low Ch. / Freq.	Power High Ch. / Freq.
Channel				40140	40640	41140
Frequency (MHz)				2545	2595	2645
20	QPSK	1	0	22.77	22.96	22.97
20	QPSK	1	49	22.80	22.92	22.85
20	QPSK	1	99	22.82	23.07	23.00
20	QPSK	50	0	21.86	22.04	22.00
20	QPSK	50	24	21.95	22.12	22.04
20	QPSK	50	50	21.93	22.10	22.02
20	QPSK	100	0	21.97	22.12	22.03
20	16QAM	1	0	21.90	22.10	22.08
20	16QAM	1	49	21.90	22.06	21.97
20	16QAM	1	99	21.92	22.19	21.99
20	16QAM	50	0	20.86	21.05	21.06
20	16QAM	50	24	21.00	21.14	21.07
20	16QAM	50	50	20.98	21.17	21.03
20	16QAM	100	0	20.97	21.13	21.06
20	64QAM	1	0	20.76	20.89	20.97
20	64QAM	1	49	20.81	20.95	20.80
20	64QAM	1	99	20.79	21.01	20.91
20	64QAM	50	0	19.91	20.08	20.12
20	64QAM	50	24	20.04	20.16	20.10
20	64QAM	50	50	20.03	20.18	20.08
20	64QAM	100	0	20.16	20.28	20.20
20	256QAM	1	0	17.40	17.65	17.67
20	256QAM	1	49	17.52	17.74	17.51
20	256QAM	1	99	17.51	17.78	17.45
20	256QAM	50	0	17.45	17.89	17.62



20	256QAM	50	24	17.58	17.94	17.63
20	256QAM	50	50	17.52	17.87	17.58
20	256QAM	100	0	17.51	17.81	17.64
Channel				40115	40640	41165
Frequency (MHz)				2542.5	2595	2647.5
15	QPSK	1	0	22.68	22.73	22.95
15	QPSK	1	37	22.70	22.73	22.88
15	QPSK	1	74	22.73	22.81	22.93
15	QPSK	36	0	21.87	21.81	22.04
15	QPSK	36	20	21.88	21.90	22.01
15	QPSK	36	39	21.88	21.91	22.00
15	QPSK	75	0	21.90	21.91	22.03
15	16QAM	1	0	21.80	21.90	22.05
15	16QAM	1	37	21.80	21.81	21.95
15	16QAM	1	74	21.89	22.01	22.06
15	16QAM	36	0	20.81	20.78	20.98
15	16QAM	36	20	20.84	20.91	20.99
15	16QAM	36	39	20.83	20.86	20.96
15	16QAM	75	0	20.90	20.96	21.05
15	64QAM	1	0	20.69	20.74	20.88
15	64QAM	1	37	20.71	20.67	20.72
15	64QAM	1	74	20.71	20.77	20.98
15	64QAM	36	0	19.94	19.91	20.15
15	64QAM	36	20	19.98	20.01	20.11
15	64QAM	36	39	19.96	20.03	20.11
15	64QAM	75	0	20.01	20.05	20.15
15	256QAM	1	0	17.34	17.67	17.34
15	256QAM	1	37	17.55	17.55	17.33
15	256QAM	1	74	17.29	17.45	17.50
15	256QAM	36	0	17.40	17.63	17.30
15	256QAM	36	20	17.26	17.65	17.32
15	256QAM	36	39	17.26	17.60	17.50
15	256QAM	75	0	17.25	17.73	17.41
Channel				40090	40640	41190
Frequency (MHz)				2540	2595	2650
10	QPSK	1	0	22.93	22.94	23.02



10	QPSK	1	25	22.91	22.98	23.00
10	QPSK	1	49	22.98	22.99	23.00
10	QPSK	25	0	21.97	21.95	22.17
10	QPSK	25	12	22.02	22.08	22.17
10	QPSK	25	25	22.04	22.09	22.15
10	QPSK	50	0	22.02	22.06	22.17
10	16QAM	1	0	22.03	22.07	22.22
10	16QAM	1	25	21.91	21.98	22.13
10	16QAM	1	49	21.98	22.05	22.12
10	16QAM	25	0	21.04	21.02	21.17
10	16QAM	25	12	21.07	21.14	21.25
10	16QAM	25	25	21.05	21.10	21.19
10	16QAM	50	0	21.05	21.09	21.18
10	64QAM	1	0	21.01	20.96	21.14
10	64QAM	1	25	20.95	20.91	21.04
10	64QAM	1	49	20.97	20.94	21.07
10	64QAM	25	0	20.09	20.01	20.23
10	64QAM	25	12	20.15	20.18	20.25
10	64QAM	25	25	20.09	20.14	20.23
10	64QAM	50	0	20.06	20.10	20.22
10	256QAM	1	0	17.40	17.45	17.64
10	256QAM	1	25	17.39	17.73	17.24
10	256QAM	1	49	17.50	17.72	17.31
10	256QAM	25	0	17.29	17.58	17.33
10	256QAM	25	12	17.48	17.71	17.48
10	256QAM	25	25	17.29	17.70	17.38
10	256QAM	50	0	17.22	17.56	17.61
Channel				40065	40640	41215
Frequency (MHz)				2537.5	2595	2652.5
5	QPSK	1	0	22.87	22.84	23.01
5	QPSK	1	12	23.03	23.03	23.05
5	QPSK	1	24	22.90	22.98	23.00
5	QPSK	12	0	21.99	21.96	22.11
5	QPSK	12	7	22.02	22.07	22.14
5	QPSK	12	13	21.97	22.05	22.11
5	QPSK	25	0	21.96	22.06	22.09



5	16QAM	1	0	22.00	22.03	22.14
5	16QAM	1	12	22.04	22.11	22.14
5	16QAM	1	24	22.11	22.15	22.23
5	16QAM	12	0	20.98	20.91	21.05
5	16QAM	12	7	20.96	21.04	21.08
5	16QAM	12	13	20.98	21.05	21.06
5	16QAM	25	0	21.01	21.03	21.11
5	64QAM	1	0	21.04	20.80	20.96
5	64QAM	1	12	21.02	21.03	21.11
5	64QAM	1	24	21.15	20.91	21.22
5	64QAM	12	0	20.10	20.07	20.18
5	64QAM	12	7	20.10	20.13	20.22
5	64QAM	12	13	20.03	20.11	20.15
5	64QAM	25	0	20.08	20.09	20.18
5	256QAM	1	0	17.26	17.61	17.45
5	256QAM	1	12	17.46	17.62	17.38
5	256QAM	1	24	17.34	17.49	17.37
5	256QAM	12	0	17.48	17.78	17.46
5	256QAM	12	7	17.29	17.68	17.60
5	256QAM	12	13	17.33	17.69	17.48
5	256QAM	25	0	17.48	17.69	17.43



EIRP

LTE Band 41 (G _T - L _C = -2.6dB) QPSK									
Bandwidth	5M			10M			15M		
Channel	40065	40640	41215	40090	40640	41190	40115	40640	41165
	(Low)	(Mid)	(High)	(Low)	(Mid)	(High)	(Low)	(Mid)	(High)
Frequency (MHz)	2537.5	2595	2652.5	2540	2595	2650	2542.5	2595	2647.5
Conducted Power (dBm)	23.03	23.03	23.05	22.93	22.94	23.02	22.68	22.73	22.95
Conducted Power (Watts)	0.2009	0.2009	0.2018	0.1963	0.1968	0.2004	0.1854	0.1875	0.1972
EIRP(dBm)	20.43	20.43	20.45	20.33	20.34	20.42	20.08	20.13	20.35
EIRP(Watts)	0.1104	0.1104	0.1109	0.1079	0.1081	0.1102	0.1019	0.1030	0.1084

LTE Band 41 (G _T - L _C = -2.6dB) QPSK			
Bandwidth	20M		
Channel	40140	40640	41140
	(Low)	(Mid)	(High)
Frequency (MHz)	2545	2595	2645
Conducted Power (dBm)	22.82	23.07	23.00
Conducted Power (Watts)	0.1914	0.2028	0.1995
EIRP(dBm)	20.22	20.47	20.40
EIRP(Watts)	0.1052	0.1114	0.1096



LTE Band 41 (G _T - L _C = -2.6dB) 16QAM									
Bandwidth	5M			10M			15M		
Channel	40065	40640	41215	40090	40640	41190	40115	40640	41165
	(Low)	(Mid)	(High)	(Low)	(Mid)	(High)	(Low)	(Mid)	(High)
Frequency (MHz)	2537.5	2595	2652.5	2540	2595	2650	2542.5	2595	2647.5
Conducted Power (dBm)	22.11	22.15	22.23	22.03	22.07	22.22	21.89	22.01	22.06
Conducted Power (Watts)	0.1626	0.1641	0.1671	0.1596	0.1611	0.1667	0.1545	0.1589	0.1607
EIRP(dBm)	19.51	19.55	19.63	19.43	19.47	19.62	19.29	19.41	19.46
EIRP(Watts)	0.0893	0.0902	0.0918	0.0877	0.0885	0.0916	0.0849	0.0873	0.0883

LTE Band 41 (G _T - L _C = -2.6dB) 16QAM			
Bandwidth	20M		
Channel	40140	40640	41140
	(Low)	(Mid)	(High)
Frequency (MHz)	2545	2595	2645
Conducted Power (dBm)	21.92	22.19	21.99
Conducted Power (Watts)	0.1556	0.1656	0.1581
EIRP(dBm)	19.32	19.59	19.39
EIRP(Watts)	0.0855	0.0910	0.0869



LTE Band 41 (G _T - L _C = -2.6dB) 64QAM									
Bandwidth	5M			10M			15M		
Channel	40065	40640	41215	40090	40640	41190	40115	40640	41165
	(Low)	(Mid)	(High)	(Low)	(Mid)	(High)	(Low)	(Mid)	(High)
Frequency (MHz)	2537.5	2595	2652.5	2540	2595	2650	2542.5	2595	2647.5
Conducted Power (dBm)	21.15	20.91	21.22	21.01	20.96	21.14	20.71	20.77	20.98
Conducted Power (Watts)	0.1303	0.1233	0.1324	0.1262	0.1247	0.1300	0.1178	0.1194	0.1253
EIRP(dBm)	18.55	18.31	18.62	18.41	18.36	18.54	18.11	18.17	18.38
EIRP(Watts)	0.0716	0.0678	0.0728	0.0693	0.0685	0.0714	0.0647	0.0656	0.0689

LTE Band 41 (G _T - L _C = -2.6dB) 64QAM			
Bandwidth	20M		
Channel	40140	40640	41140
	(Low)	(Mid)	(High)
Frequency (MHz)	2545	2595	2645
Conducted Power (dBm)	20.79	21.01	20.91
Conducted Power (Watts)	0.1199	0.1262	0.1233
EIRP(dBm)	18.19	18.41	18.31
EIRP(Watts)	0.0659	0.0693	0.0678



LTE Band 41

Peak-to-Average Ratio

Mode	LTE Band 41 / 20MHz				
Mod.	QPSK		16QAM		Limit: 13dB
RB Size	1RB	Full RB	1RB	Full RB	Result
Lowest CH	3.57	5.36	5.28	5.80	PASS
Middle CH	4.20	5.28	5.91	6.35	
Highest CH	3.91	5.04	4.78	6.38	
Mode	LTE Band 41 / 20MHz				
Mod.	64QAM				Limit: 13dB
RB Size	1RB	Full RB			Result
Lowest CH	5.39	5.68	-	-	PASS
Middle CH	5.62	6.03	-	-	
Highest CH	5.77	6.32	-	-	



LTE Band 41 / 20MHz / QPSK

Lowest Channel / 1RB

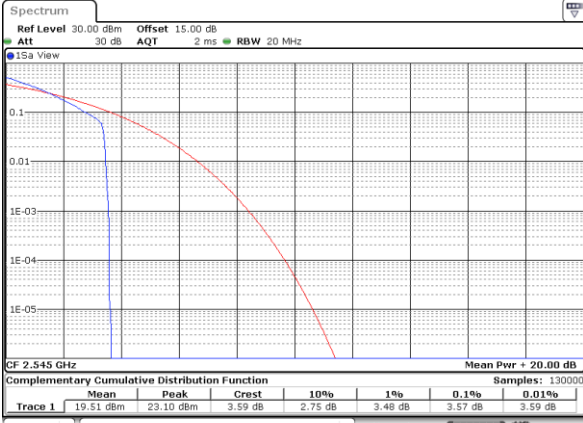

Date: 26_SEP.2021 16:04:51

Lowest Channel / Full RB

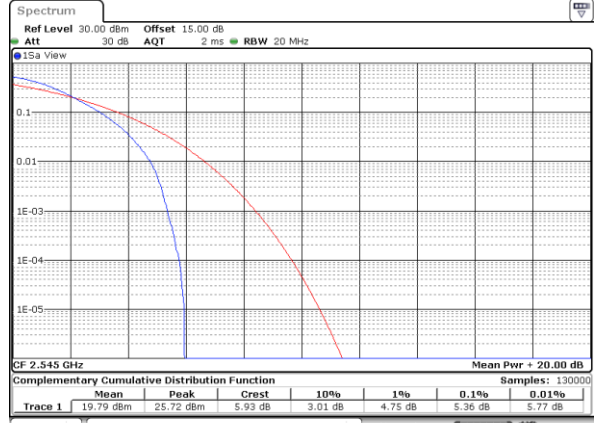

Date: 26_SEP.2021 15:50:03

Middle Channel / 1RB

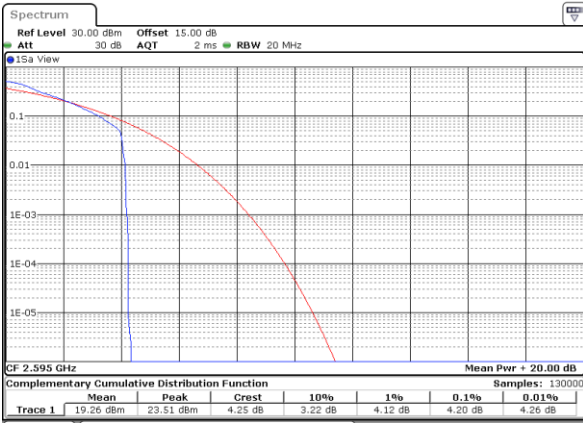

Date: 26_SEP.2021 16:01:47

Middle Channel / Full RB

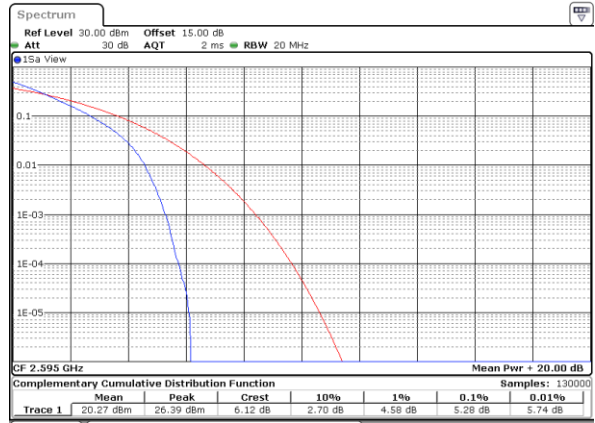

Date: 26_SEP.2021 15:57:04

Highest Channel / 1RB

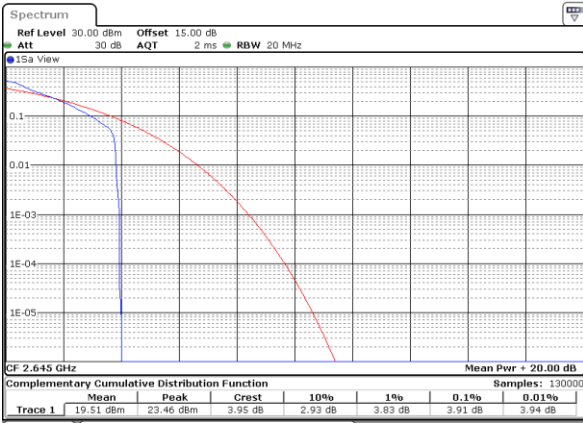

Date: 26_SEP.2021 16:01:15

Highest Channel / Full RB

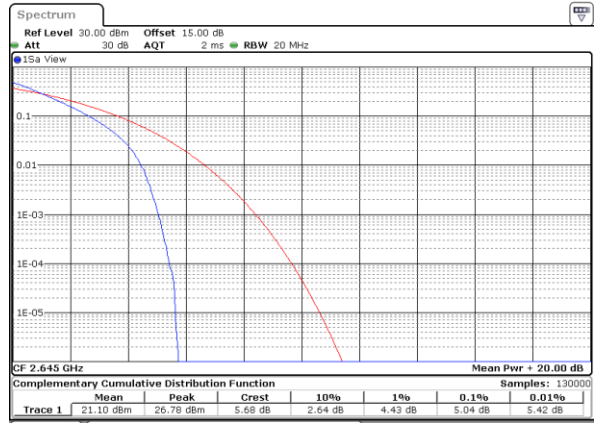

Date: 26_SEP.2021 15:57:57



LTE Band 41 / 20MHz / 16QAM

Lowest Channel / 1RB

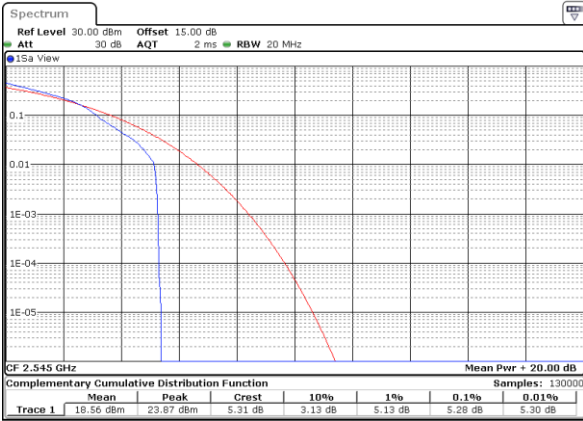

Date: 26_SEP.2021 16:05:44

Lowest Channel / Full RB

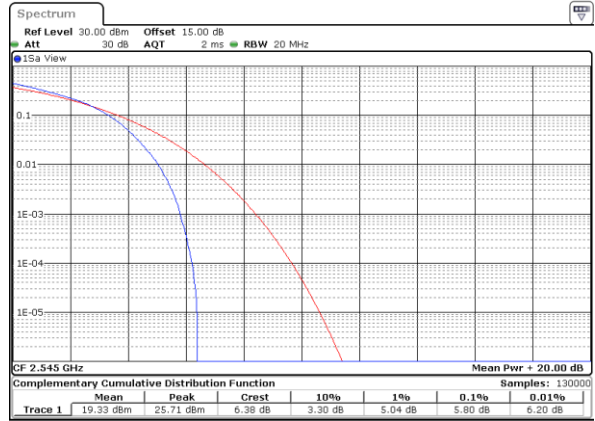

Date: 26_SEP.2021 15:50:32

Middle Channel / 1RB

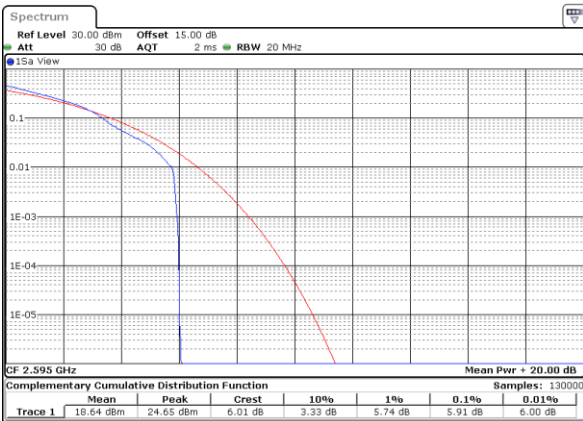

Date: 26_SEP.2021 16:02:01

Middle Channel / Full RB

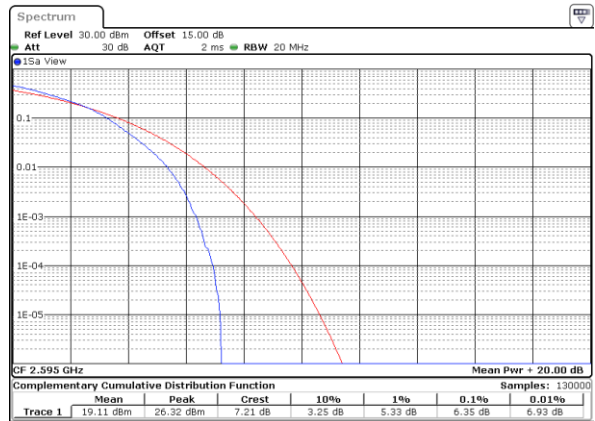

Date: 26_SEP.2021 15:56:31

Highest Channel / 1RB



Date: 26_SEP.2021 16:00:23

Highest Channel / Full RB



Date: 26_SEP.2021 15:58:26



LTE Band 41 / 20MHz / 64QAM

Lowest Channel / 1RB

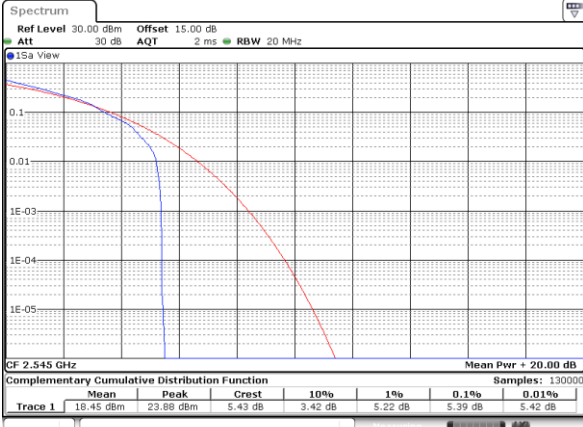

Date: 26_SEP.2021 16:06:33

Lowest Channel / Full RB

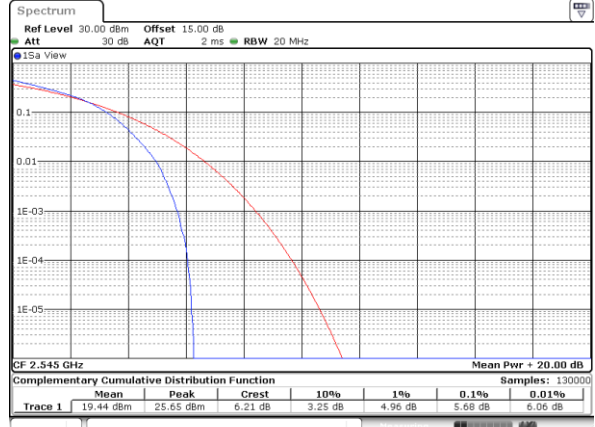

Date: 26_SEP.2021 15:50:57

Middle Channel / 1RB

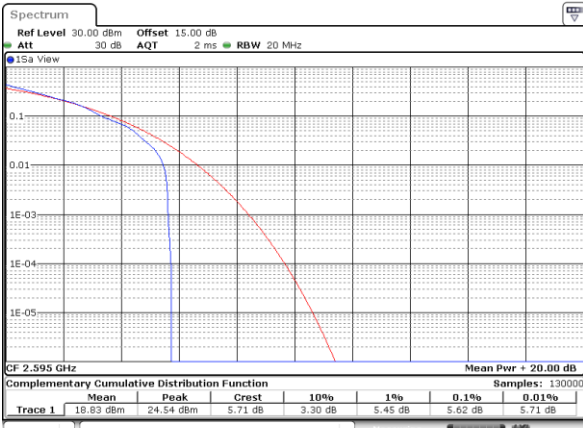

Date: 26_SEP.2021 16:03:03

Middle Channel / Full RB

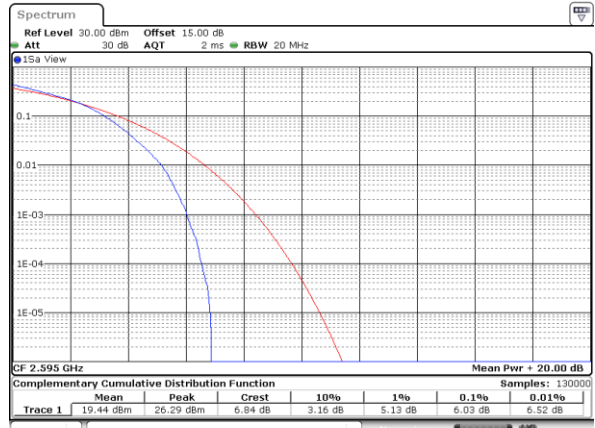

Date: 26_SEP.2021 15:56:10

Highest Channel / 1RB

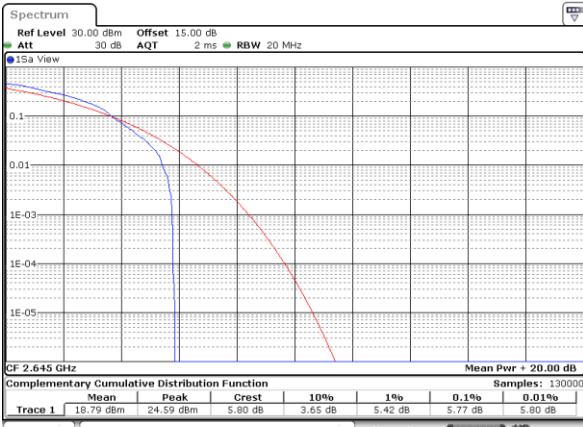

Date: 26_SEP.2021 15:59:40

Highest Channel / Full RB

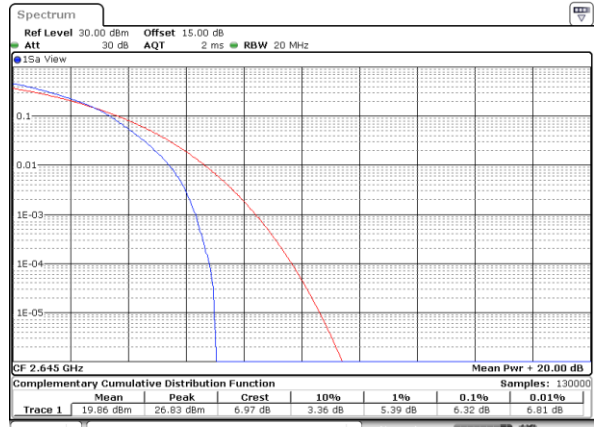

Date: 26_SEP.2021 15:59:07



26dB Bandwidth

Mode	LTE Band 41 : 26dB BW(MHz)											
BW	1.4MHz		3MHz		5MHz		10MHz		15MHz		20MHz	
Mod.	QPSK	16QAM	QPSK	16QAM	QPSK	16QAM	QPSK	16QAM	QPSK	16QAM	QPSK	16QAM
Lowest CH	-	-	-	-	4.96	4.78	9.89	9.81	14.63	14.18	18.70	18.70
Middle CH	-	-	-	-	4.88	4.81	9.71	9.63	14.24	14.12	18.90	18.82
Highest CH	-	-	-	-	4.88	4.77	9.85	9.61	14.45	14.33	18.62	18.62
Mode	LTE Band 41 : 26dB BW(MHz)											
BW	1.4MHz		3MHz		5MHz		10MHz		15MHz		20MHz	
Mod.	64QAM		64QAM		64QAM		64QAM		64QAM		64QAM	
Lowest CH	-	-	-	-	4.83	-	9.69	-	14.30	-	18.78	-
Middle CH	-	-	-	-	4.85	-	9.73	-	14.51	-	18.82	-
Highest CH	-	-	-	-	4.80	-	9.73	-	14.27	-	18.86	-



LTE Band 41

Lowest Channel / 5MHz / QPSK

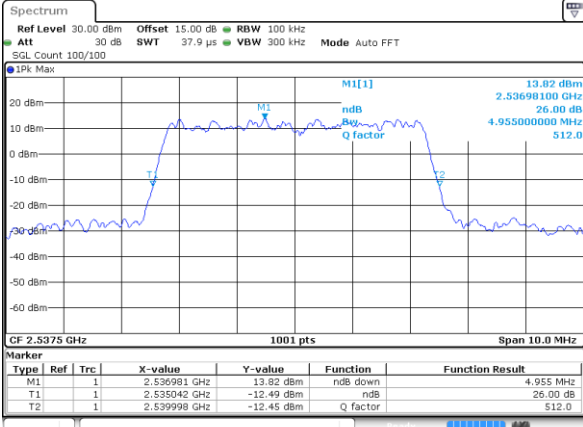

Date: 26 SEP 2021 15:56:23

Lowest Channel / 5MHz / 16QAM

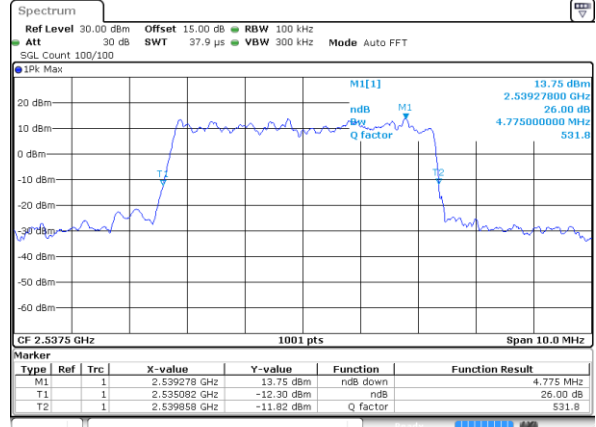

Date: 26 SEP 2021 15:56:58

Middle Channel / 5MHz / QPSK

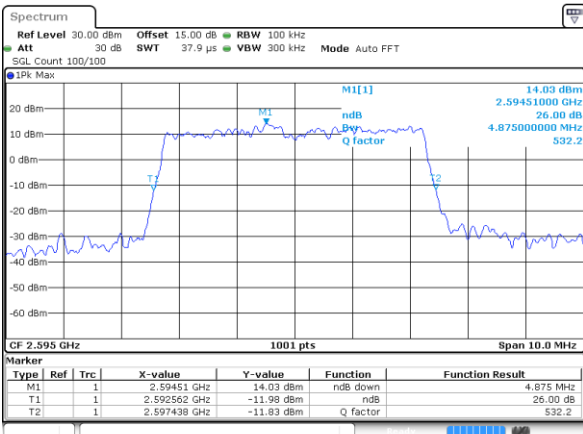

Date: 26 SEP 2021 15:59:03

Middle Channel / 5MHz / 16QAM

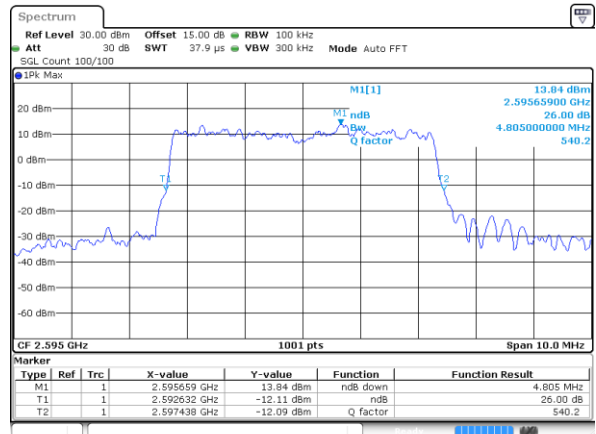

Date: 26 SEP 2021 15:58:36

Highest Channel / 5MHz / QPSK

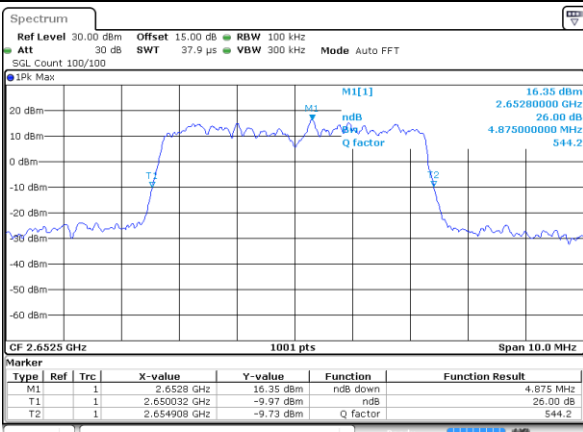

Date: 26 SEP 2021 15:59:47

Highest Channel / 5MHz / 16QAM

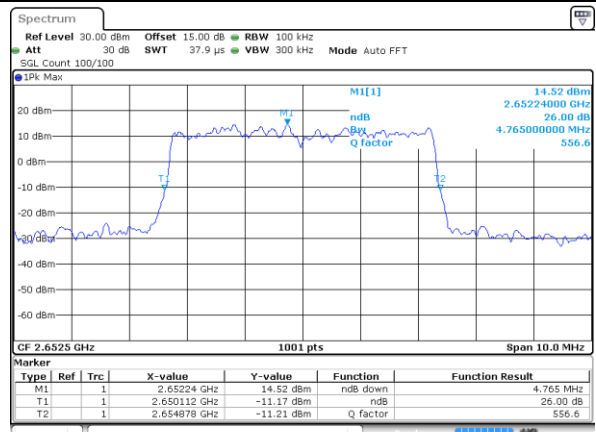

Date: 26 SEP 2021 16:00:18



LTE Band 41

Lowest Channel / 10MHz / QPSK

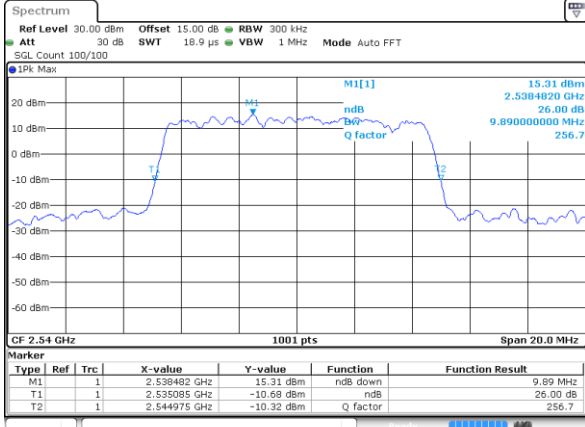

Date: 26 SEP 2021 16:01:40

Lowest Channel / 10MHz / 16QAM

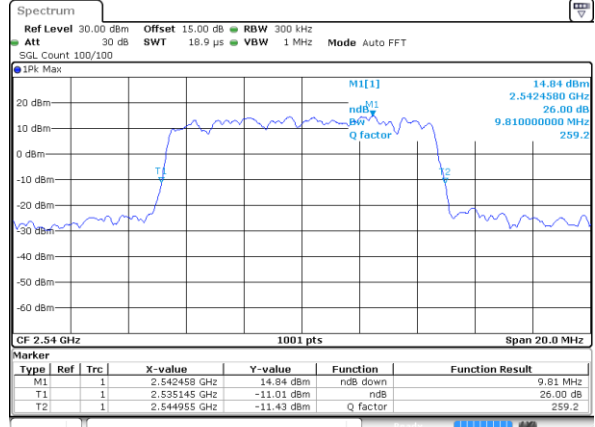

Date: 26 SEP 2021 16:02:12

Middle Channel / 10MHz / QPSK

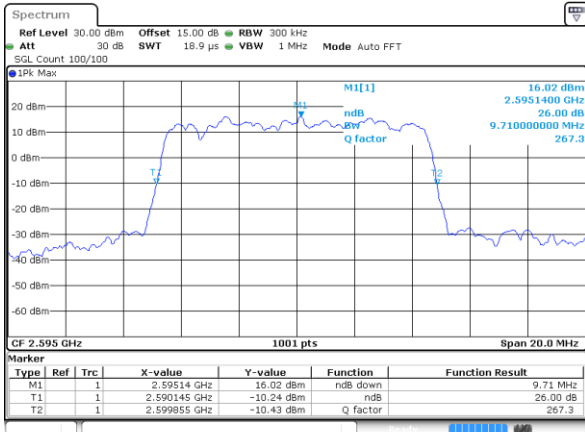

Date: 26 SEP 2021 16:04:09

Middle Channel / 10MHz / 16QAM

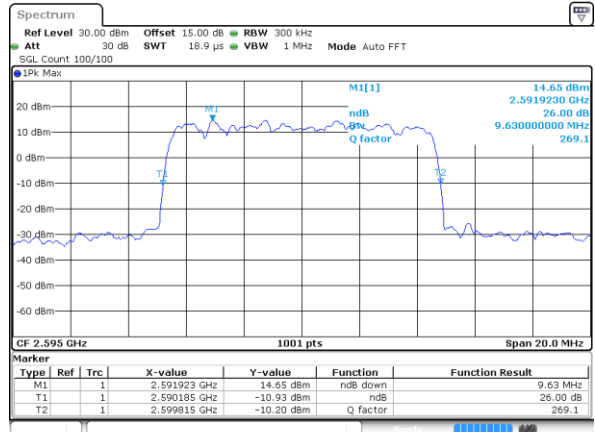

Date: 26 SEP 2021 16:03:44

Highest Channel / 10MHz / QPSK

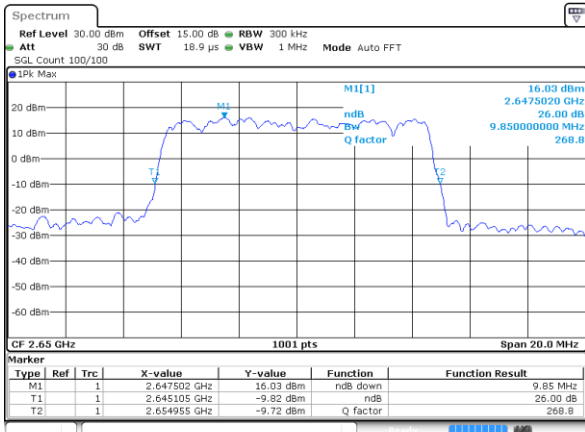

Date: 26 SEP 2021 16:04:46

Highest Channel / 10MHz / 16QAM

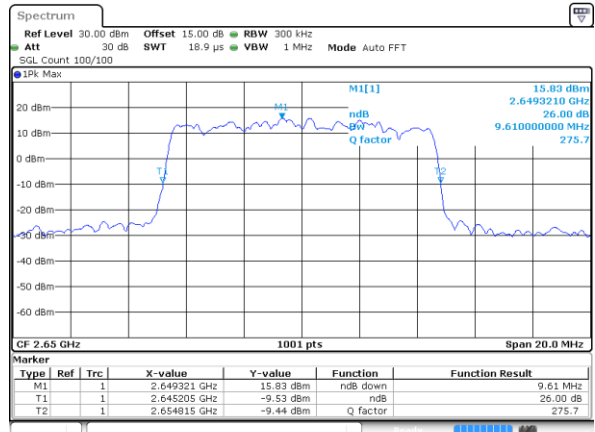

Date: 26 SEP 2021 16:05:37



LTE Band 41

Lowest Channel / 15MHz / QPSK

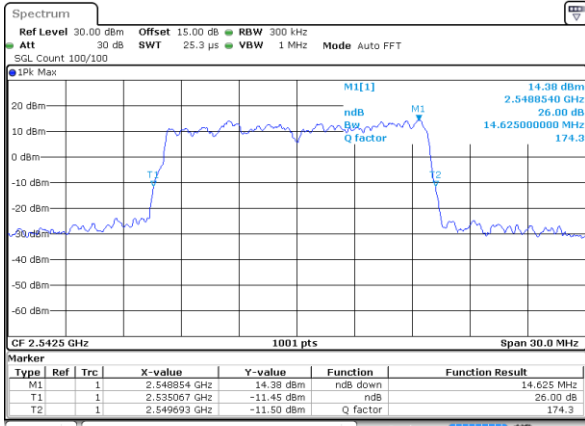

Date: 26 SEP 2021 16:07:11

Lowest Channel / 15MHz / 16QAM

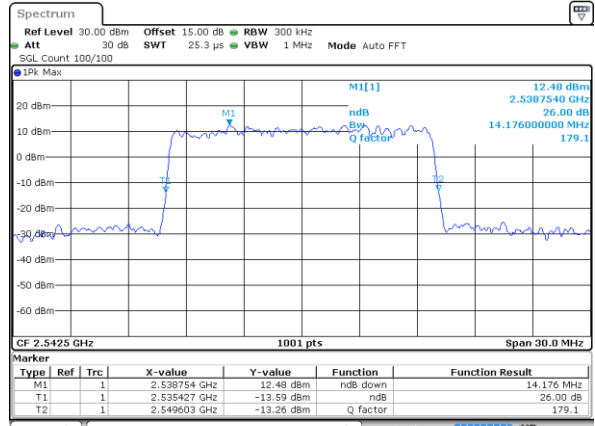

Date: 26 SEP 2021 16:07:42

Middle Channel / 15MHz / QPSK

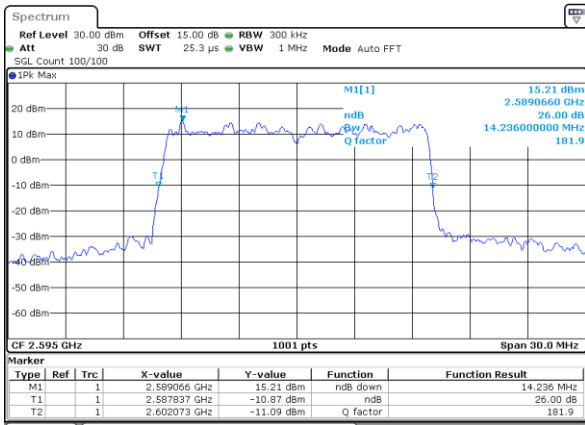

Date: 26 SEP 2021 16:10:12

Middle Channel / 15MHz / 16QAM

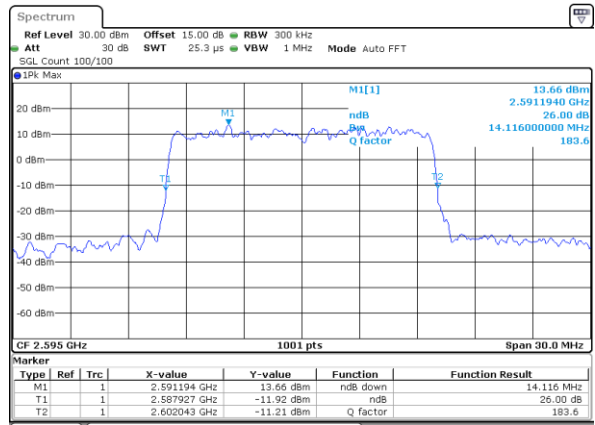

Date: 26 SEP 2021 16:09:36

Highest Channel / 15MHz / QPSK

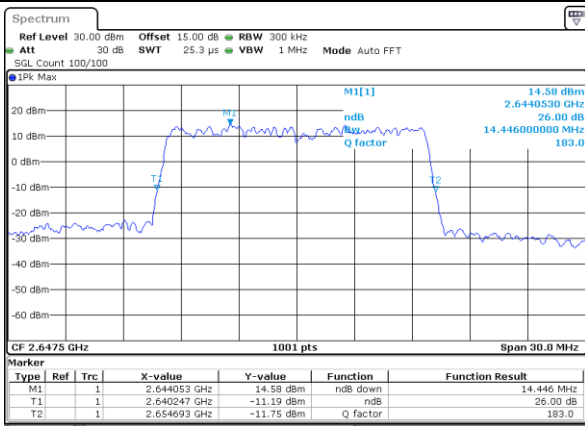

Date: 26 SEP 2021 16:10:43

Highest Channel / 15MHz / 16QAM

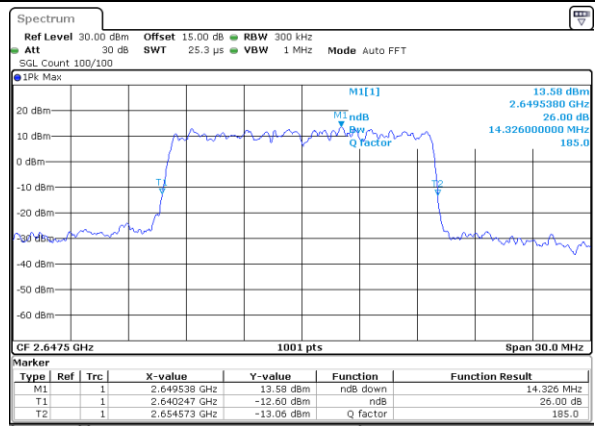

Date: 26 SEP 2021 16:11:14



LTE Band 41

Lowest Channel / 20MHz / QPSK

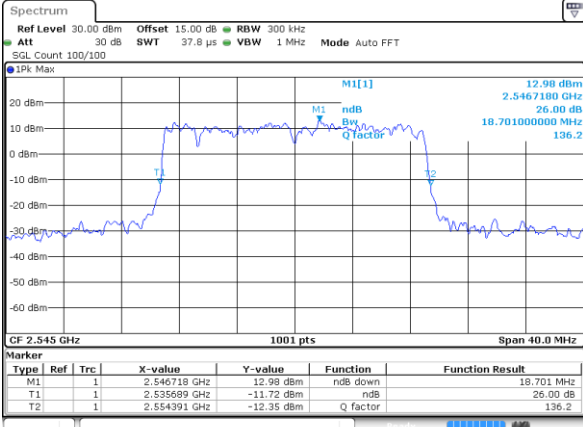

Date: 26 SEP 2021 16:13:05

Lowest Channel / 20MHz / 16QAM

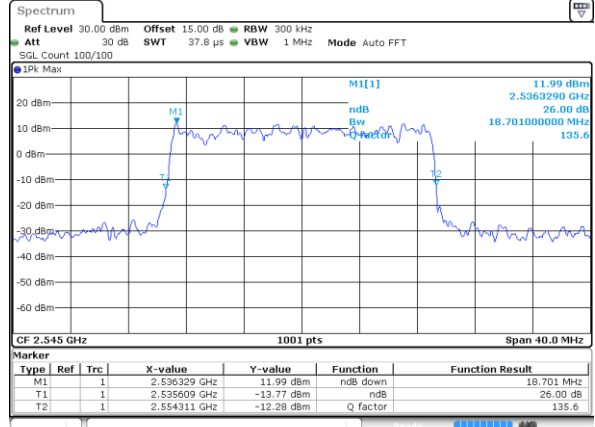

Date: 26 SEP 2021 16:13:39

Middle Channel / 20MHz / QPSK

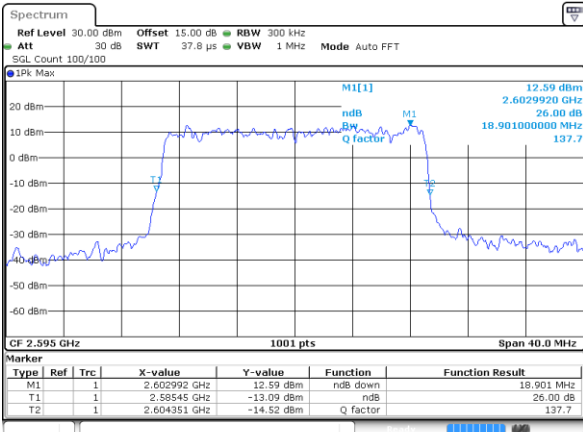

Date: 26 SEP 2021 16:17:08

Middle Channel / 20MHz / 16QAM

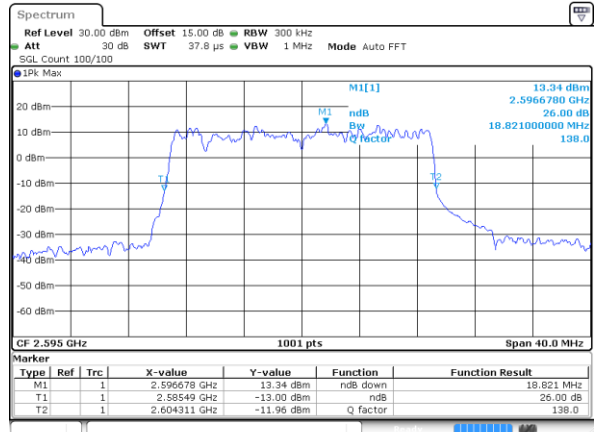

Date: 26 SEP 2021 16:16:25

Highest Channel / 20MHz / QPSK

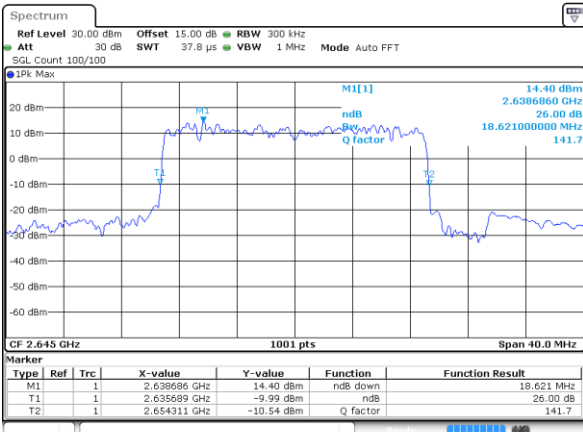

Date: 26 SEP 2021 16:17:57

Highest Channel / 20MHz / 16QAM

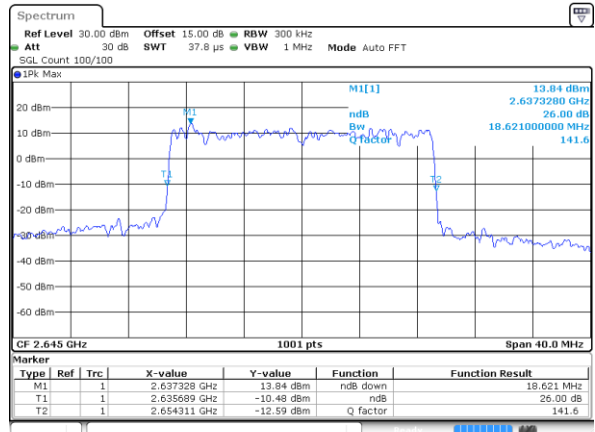

Date: 26 SEP 2021 16:18:57



LTE Band 41

Lowest Channel / 5MHz / 64QAM

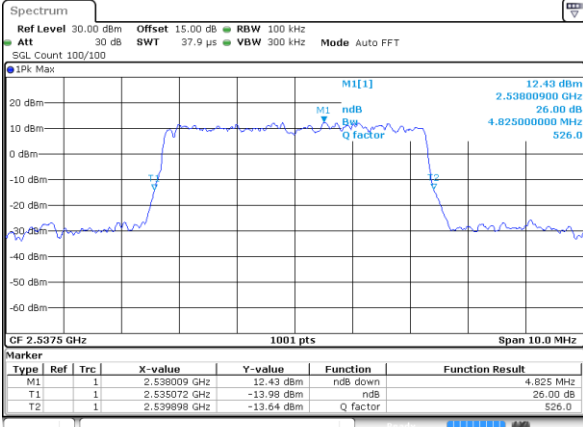

Date: 26 SEP 2021 15:57:34

Lowest Channel / 10MHz / 64QAM

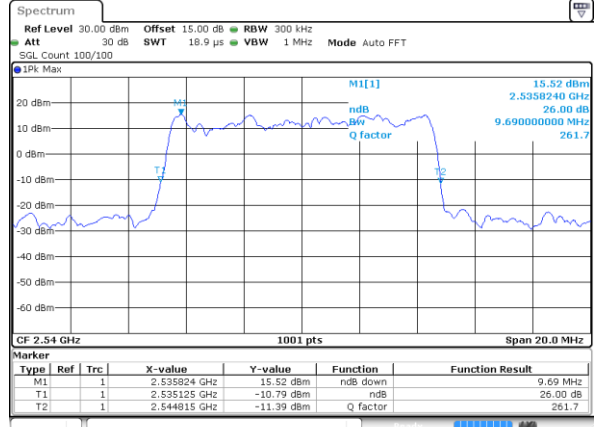

Date: 26 SEP 2021 16:02:42

Middle Channel / 5MHz / 64QAM

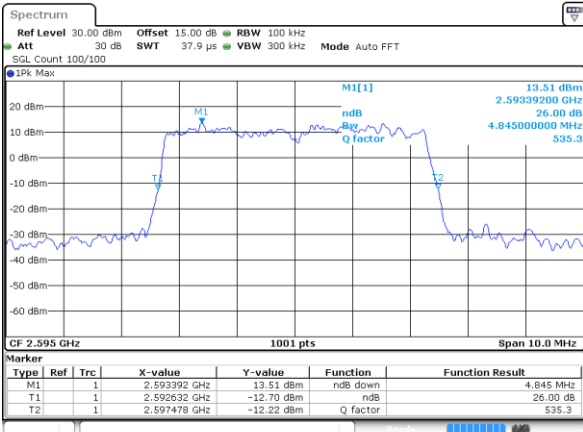

Date: 26 SEP 2021 15:58:06

Middle Channel / 10MHz / 64QAM

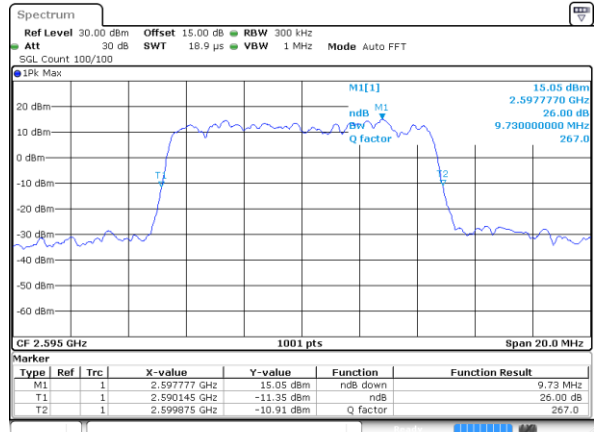

Date: 26 SEP 2021 16:03:09

Highest Channel / 5MHz / 64QAM

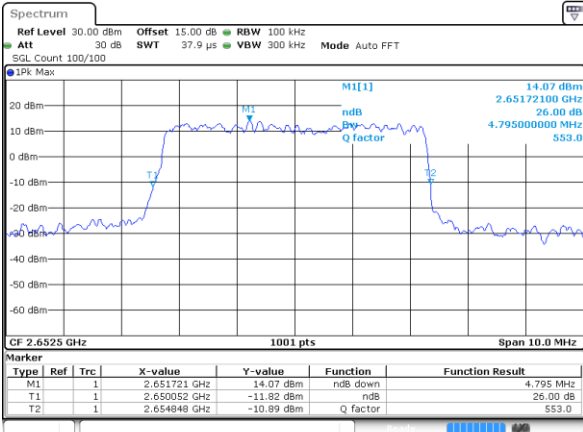

Date: 26 SEP 2021 16:00:53

Highest Channel / 10MHz / 64QAM

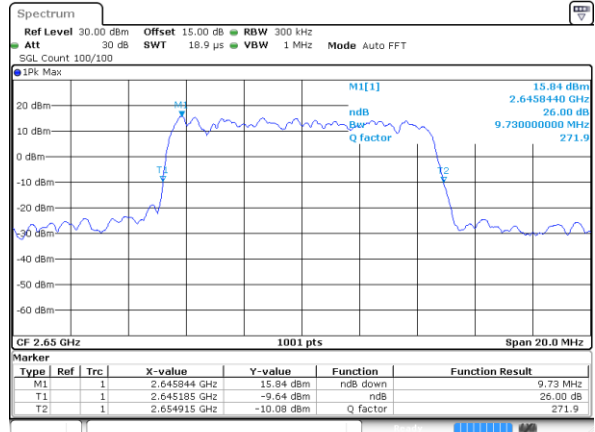

Date: 26 SEP 2021 16:06:32



LTE Band 41

Lowest Channel / 15MHz / 64QAM

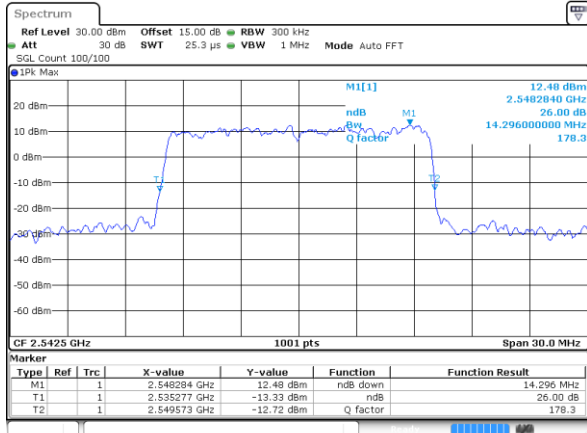

Date: 26 SEP 2021 16:08:15

Lowest Channel / 20MHz / 64QAM

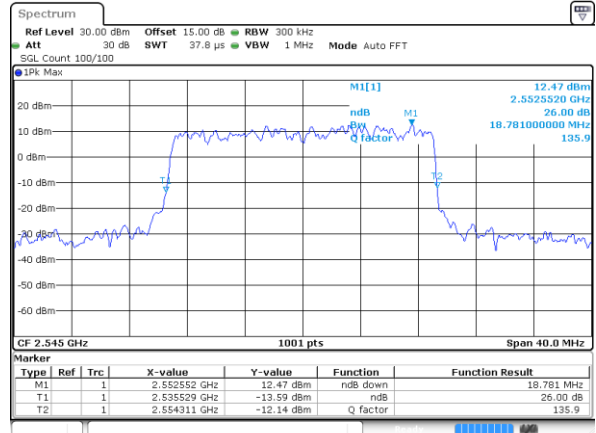

Date: 26 SEP 2021 16:14:24

Middle Channel / 15MHz / 64QAM

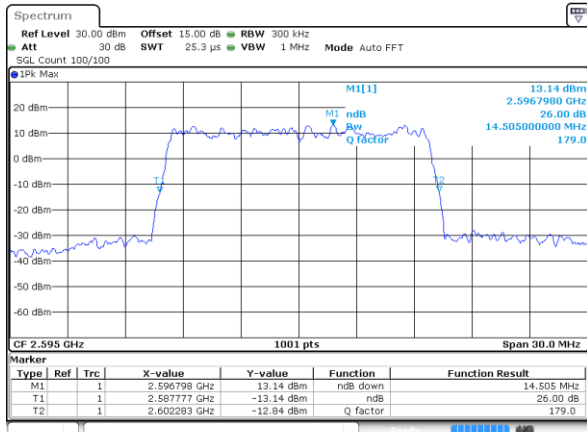

Date: 26 SEP 2021 16:08:55

Middle Channel / 20MHz / 64QAM

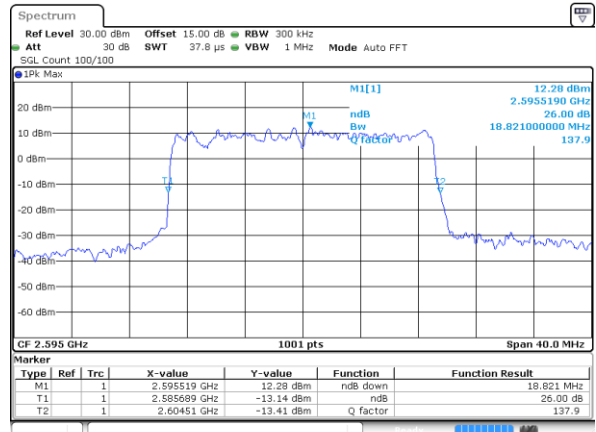

Date: 26 SEP 2021 16:10:06

Highest Channel / 15MHz / 64QAM

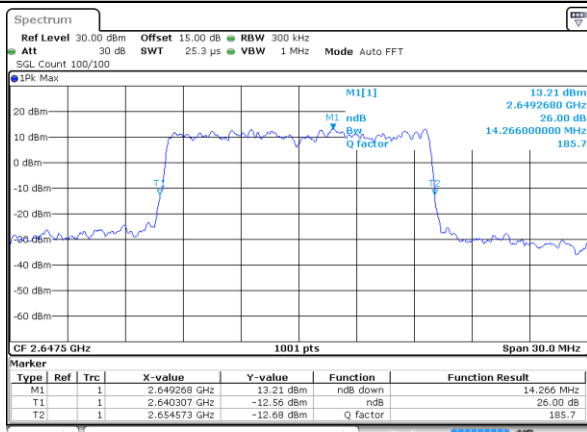

Date: 26 SEP 2021 16:12:02

Highest Channel / 20MHz / 64QAM

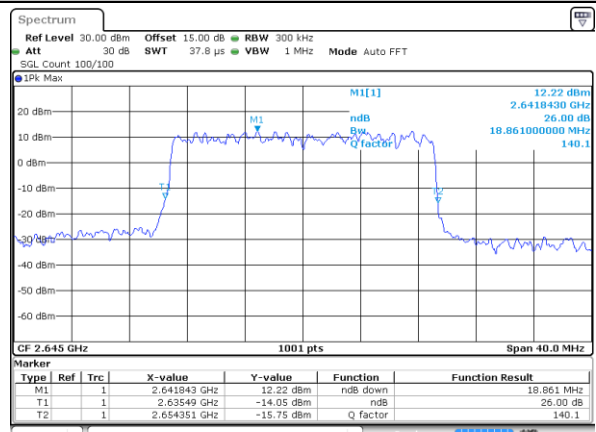

Date: 26 SEP 2021 16:19:42



Occupied Bandwidth

Mode	LTE Band 41 : 99%OBW(MHz)											
BW	1.4MHz		3MHz		5MHz		10MHz		15MHz		20MHz	
Mod.	QPSK	16QAM	QPSK	16QAM	QPSK	16QAM	QPSK	16QAM	QPSK	16QAM	QPSK	16QAM
Lowest CH	-	-	-	-	4.48	4.50	9.05	9.03	13.37	13.46	17.82	17.86
Middle CH	-	-	-	-	4.53	4.50	9.05	9.03	13.49	13.37	17.78	17.90
Highest CH	-	-	-	-	4.48	4.48	9.03	9.07	13.46	13.46	17.94	17.86
Mode	LTE Band 41 : 99%OBW(MHz)											
BW	1.4MHz		3MHz		5MHz		10MHz		15MHz		20MHz	
Mod.	64QAM		64QAM		64QAM		64QAM		64QAM		64QAM	
Lowest CH	-	-	-	-	4.48	-	8.99	-	13.49	-	17.90	-
Middle CH	-	-	-	-	4.48	-	9.03	-	13.46	-	17.82	-
Highest CH	-	-	-	-	4.52	-	8.99	-	13.49	-	17.86	-



LTE Band 41

Lowest Channel / 5MHz / QPSK

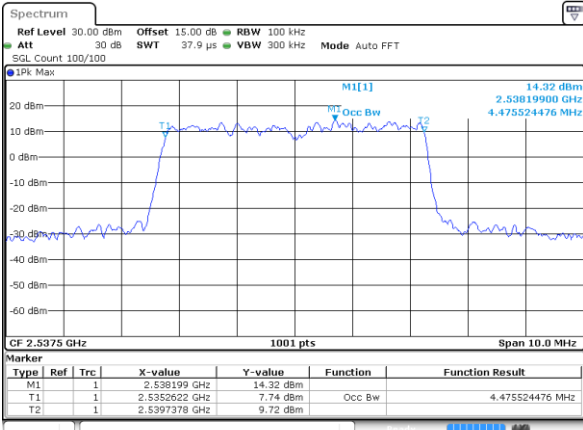

Date: 26 SEP 2021 15:56:02

Lowest Channel / 5MHz / 16QAM

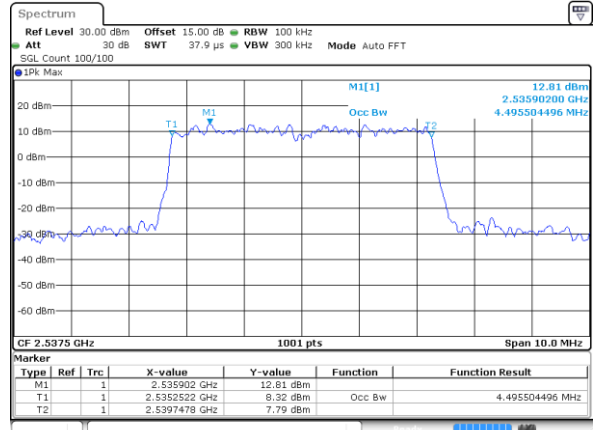

Date: 26 SEP 2021 15:56:37

Middle Channel / 5MHz / QPSK

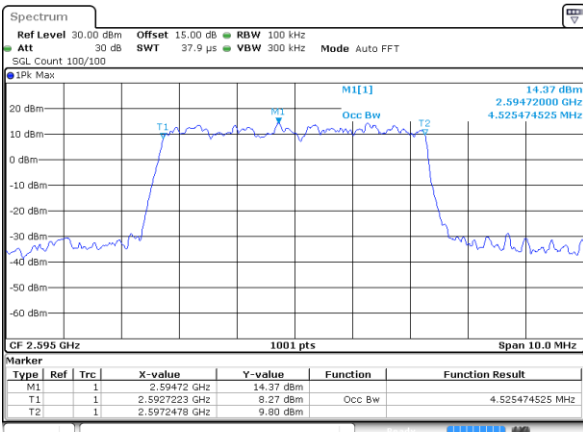

Date: 26 SEP 2021 15:58:49

Middle Channel / 5MHz / 16QAM

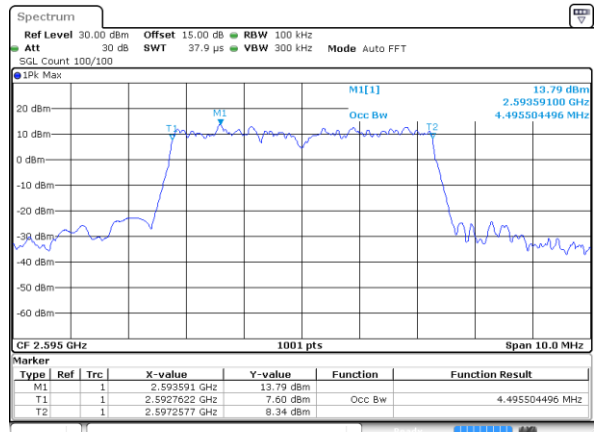

Date: 26 SEP 2021 15:58:22

Highest Channel / 5MHz / QPSK

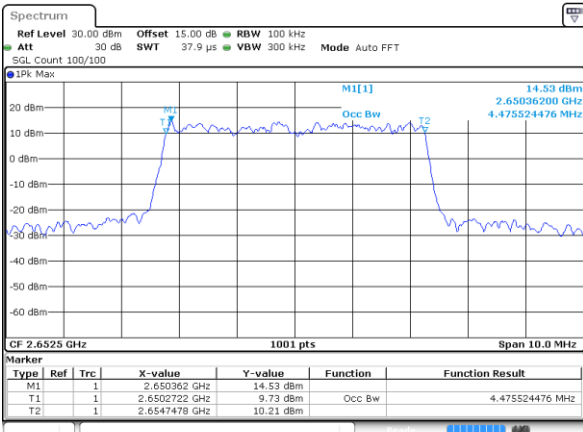

Date: 26 SEP 2021 15:59:35

Highest Channel / 5MHz / 16QAM

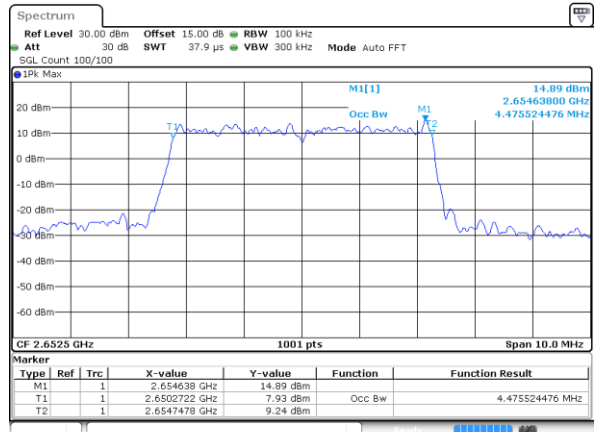

Date: 26 SEP 2021 16:00:04



LTE Band 41

Lowest Channel / 10MHz / QPSK

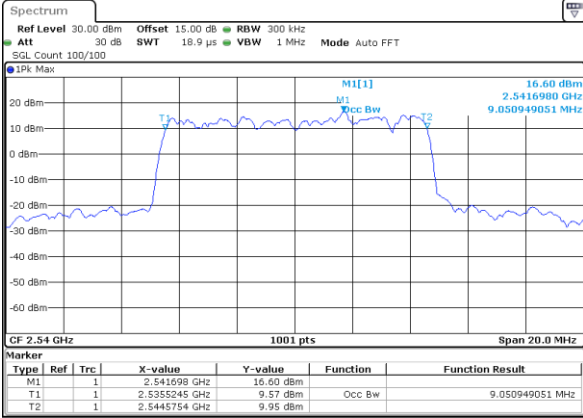

Date: 26 SEP 2021 16:01:23

Lowest Channel / 10MHz / 16QAM

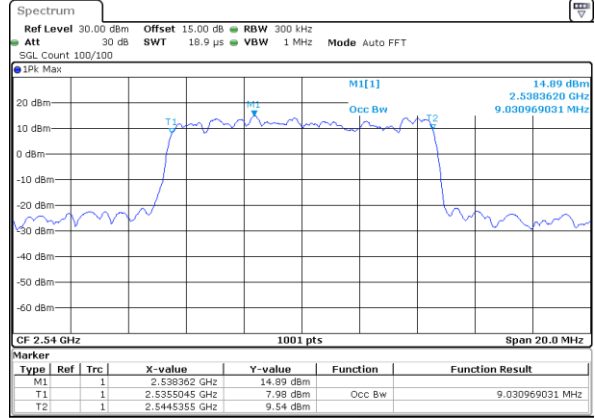

Date: 26 SEP 2021 16:01:59

Middle Channel / 10MHz / QPSK

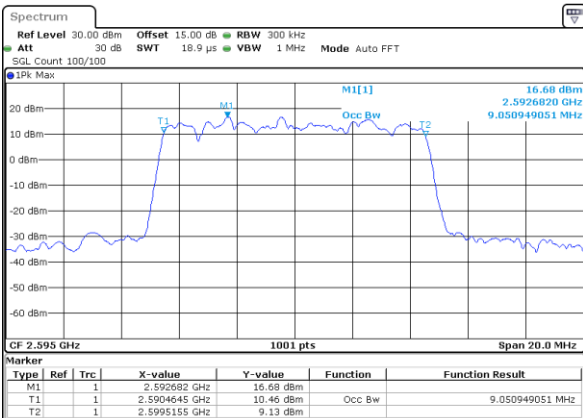

Date: 26 SEP 2021 16:03:56

Middle Channel / 10MHz / 16QAM

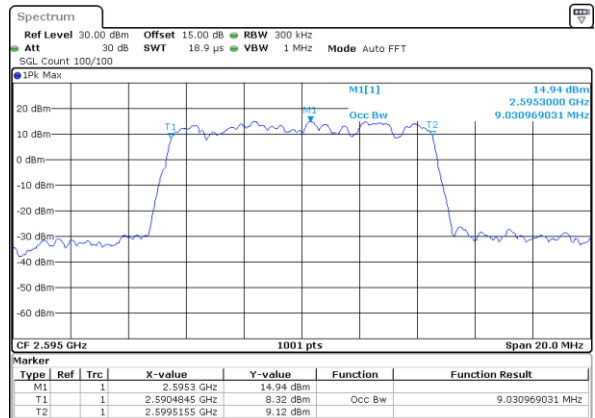

Date: 26 SEP 2021 16:03:27

Highest Channel / 10MHz / QPSK

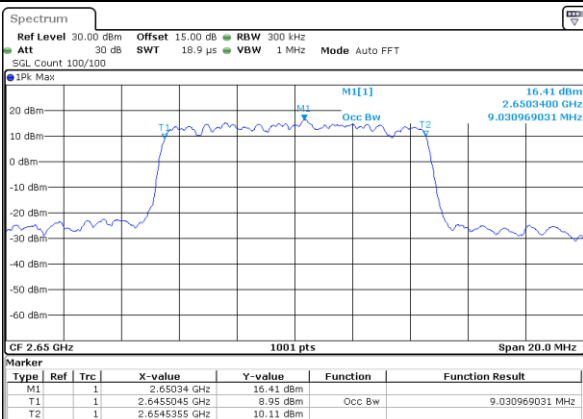

Date: 26 SEP 2021 16:04:24

Highest Channel / 10MHz / 16QAM

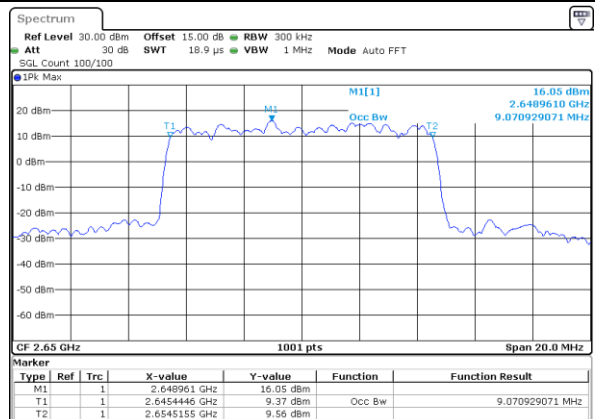

Date: 26 SEP 2021 16:05:06



LTE Band 41

Lowest Channel / 15MHz / QPSK

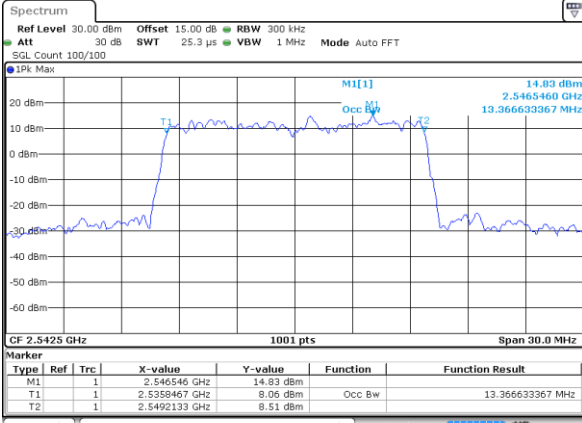

Date: 26 SEP 2021 16:07:00

Lowest Channel / 15MHz / 16QAM

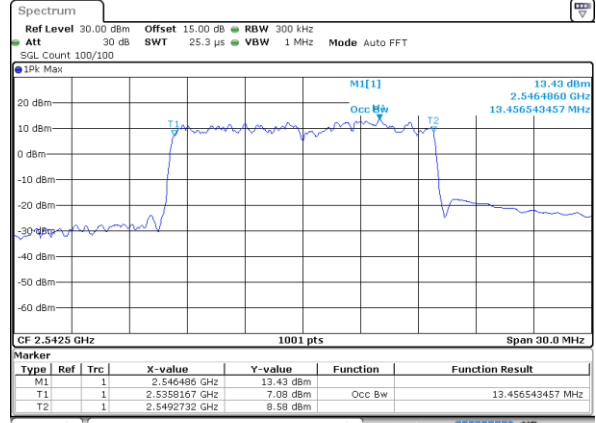

Date: 26 SEP 2021 16:07:30

Middle Channel / 15MHz / QPSK

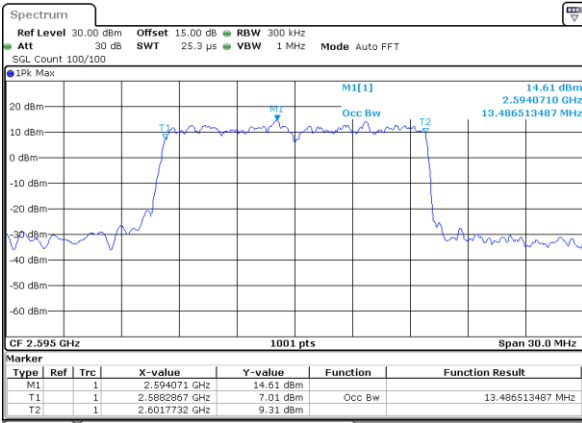

Date: 26 SEP 2021 16:09:56

Middle Channel / 15MHz / 16QAM

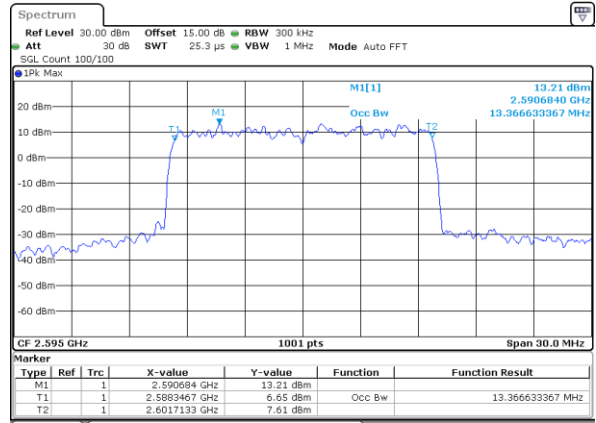

Date: 26 SEP 2021 16:09:16

Highest Channel / 15MHz / QPSK

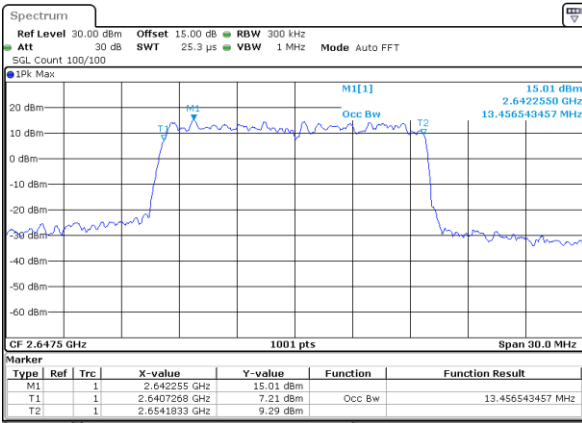

Date: 26 SEP 2021 16:10:27

Highest Channel / 15MHz / 16QAM

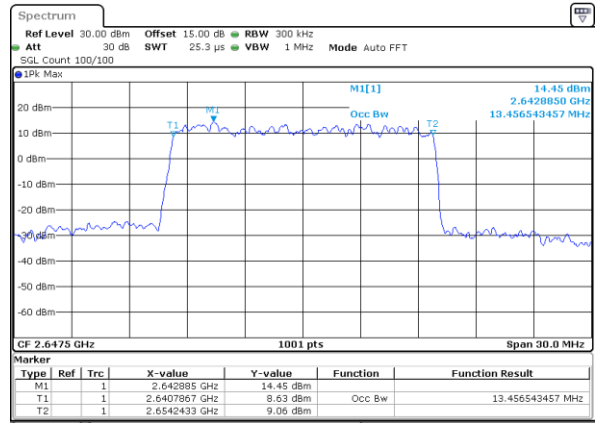

Date: 26 SEP 2021 16:11:02



LTE Band 41

Lowest Channel / 20MHz / QPSK

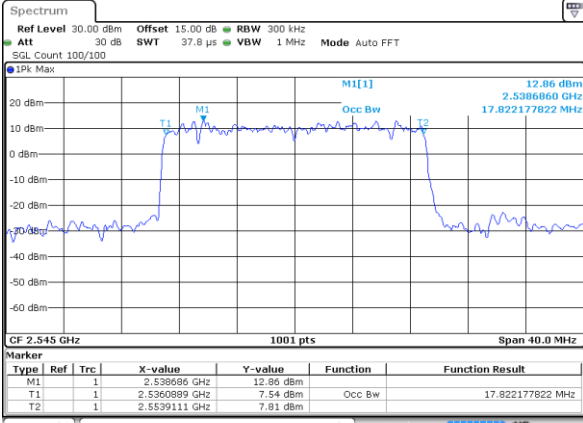

Date: 26 SEP 2021 16:12:43

Lowest Channel / 20MHz / 16QAM

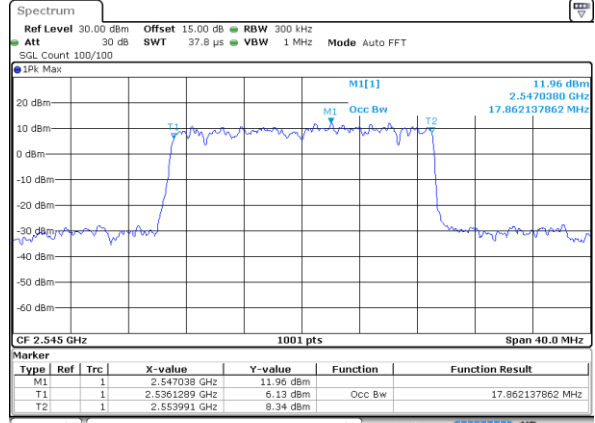

Date: 26 SEP 2021 16:13:19

Middle Channel / 20MHz / QPSK

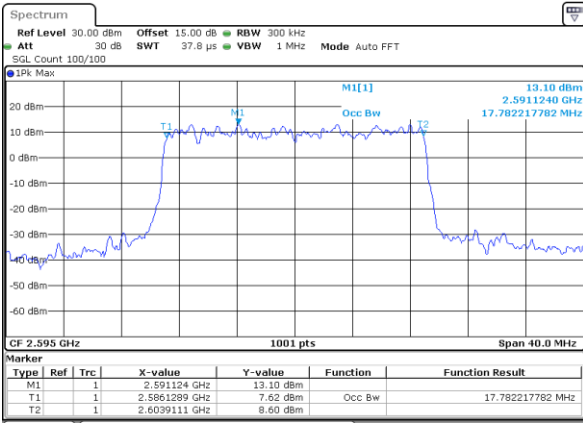

Date: 26 SEP 2021 16:16:43

Middle Channel / 20MHz / 16QAM

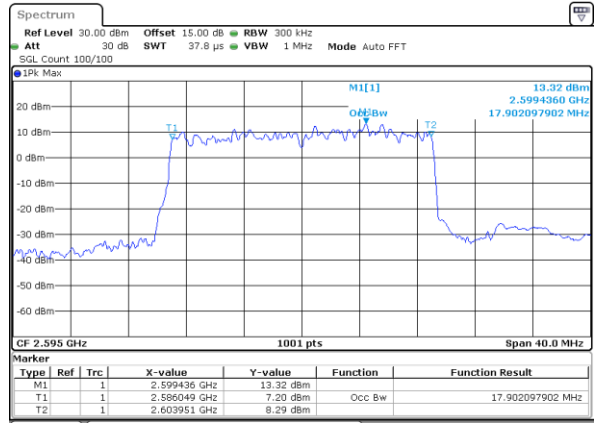

Date: 26 SEP 2021 16:16:13

Highest Channel / 20MHz / QPSK

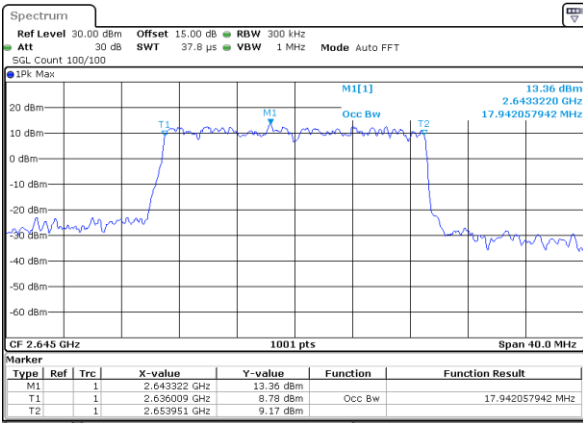

Date: 26 SEP 2021 16:17:34

Highest Channel / 20MHz / 16QAM

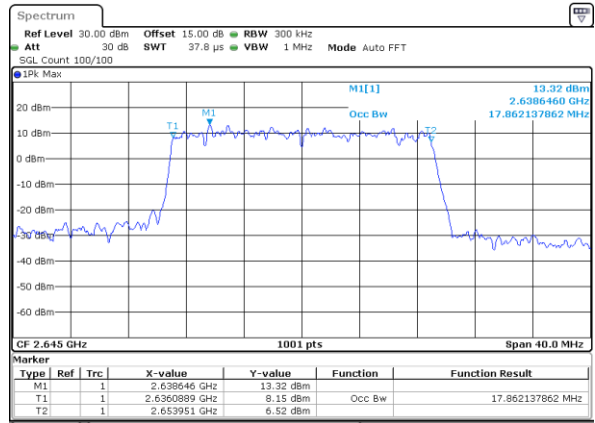

Date: 26 SEP 2021 16:18:41



LTE Band 41

Lowest Channel / 5MHz / 64QAM

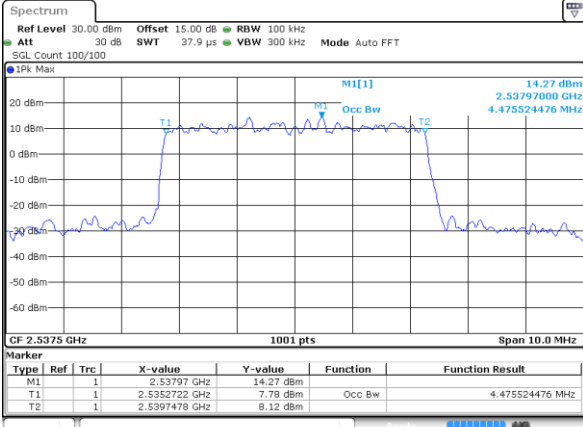

Date: 26 SEP 2021 15:57:22

Lowest Channel / 10MHz / 64QAM

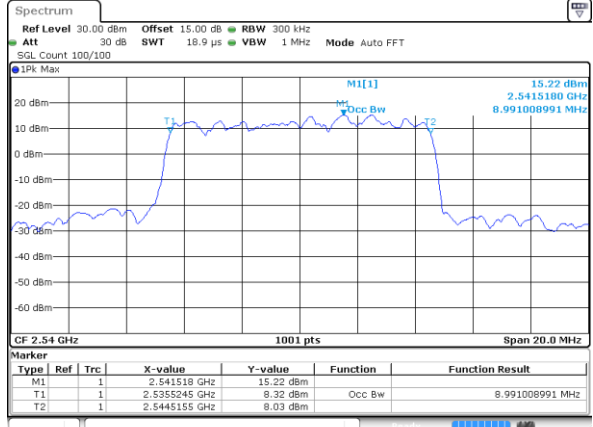

Date: 26 SEP 2021 16:02:28

Middle Channel / 5MHz / 64QAM

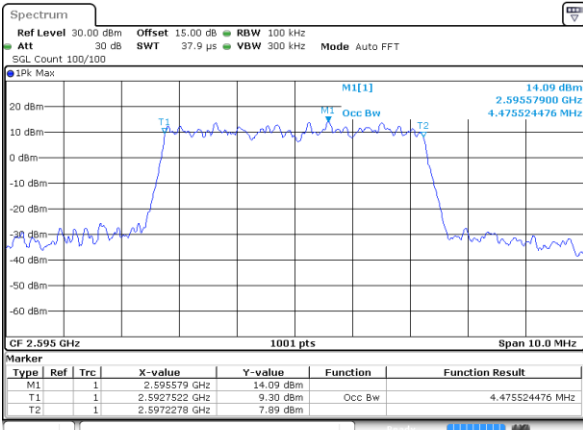

Date: 26 SEP 2021 15:57:50

Middle Channel / 10MHz / 64QAM

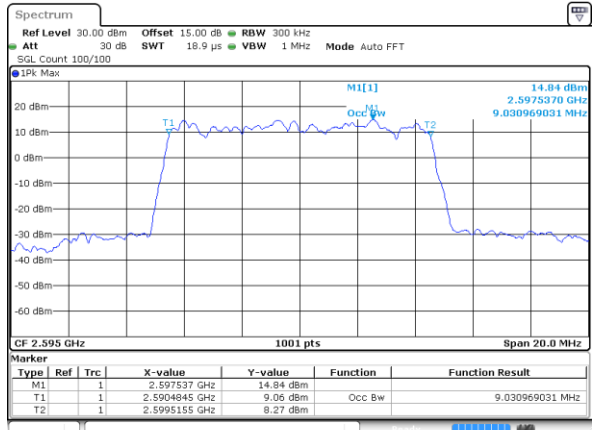

Date: 26 SEP 2021 16:02:57

Highest Channel / 5MHz / 64QAM

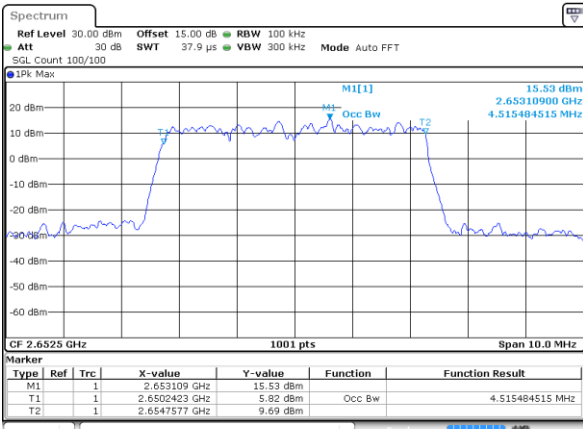

Date: 26 SEP 2021 16:00:38

Highest Channel / 10MHz / 64QAM

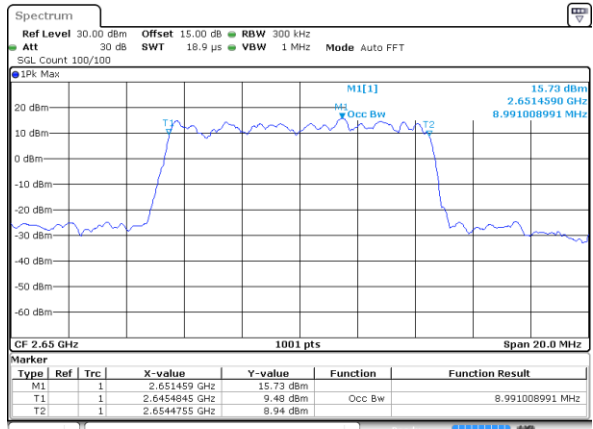

Date: 26 SEP 2021 16:06:13



LTE Band 41

Lowest Channel / 15MHz / 64QAM

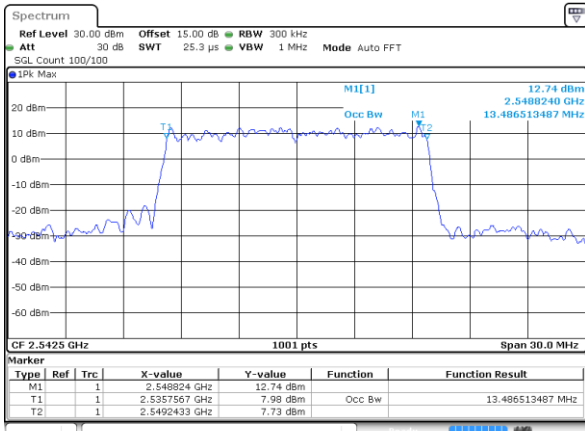

Date: 26 SEP 2021 16:08:03

Lowest Channel / 20MHz / 64QAM

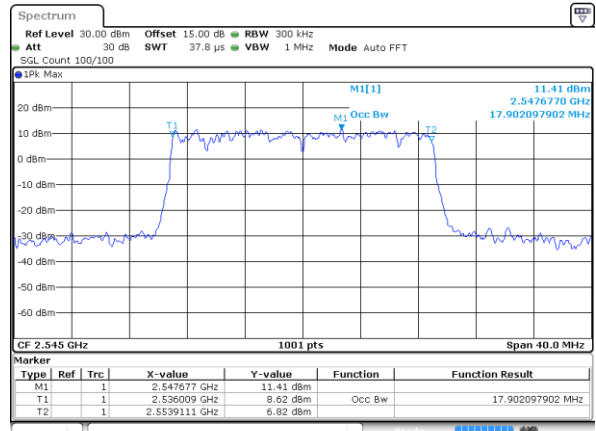

Date: 26 SEP 2021 16:13:59

Middle Channel / 15MHz / 64QAM

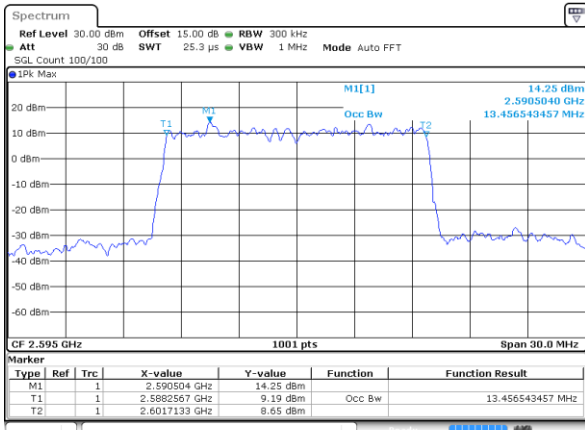

Date: 26 SEP 2021 16:08:43

Middle Channel / 20MHz / 64QAM

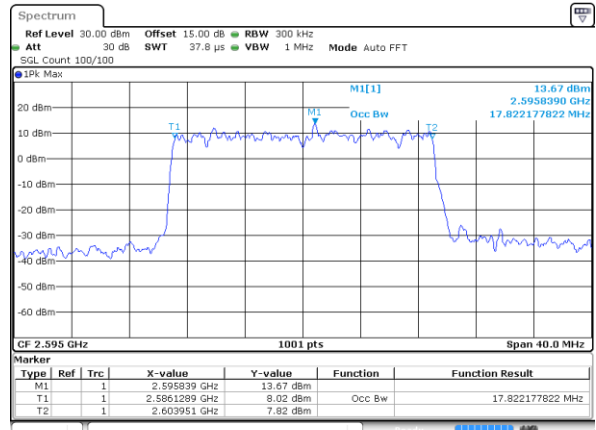

Date: 26 SEP 2021 16:14:53

Highest Channel / 15MHz / 64QAM

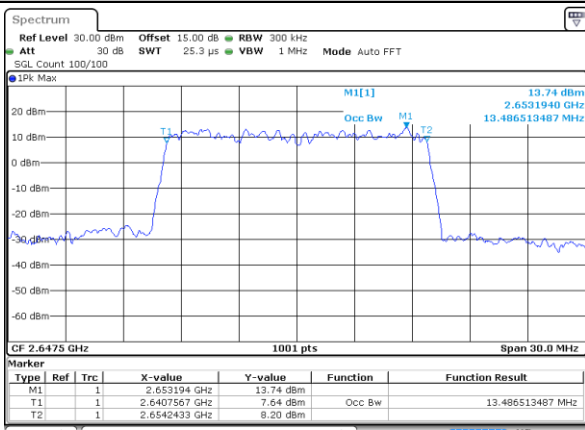

Date: 26 SEP 2021 16:11:28

Highest Channel / 20MHz / 64QAM

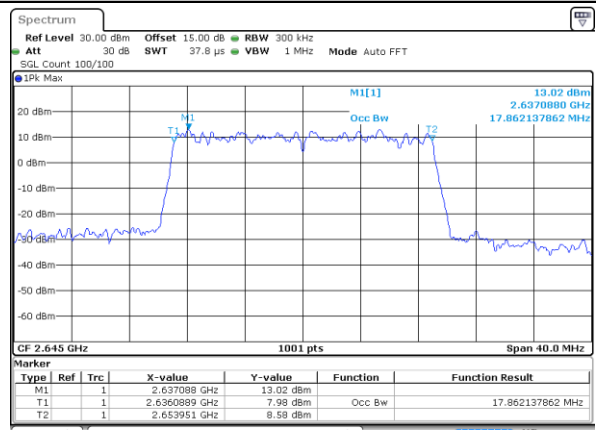

Date: 26 SEP 2021 16:19:31



Conducted Band Edge

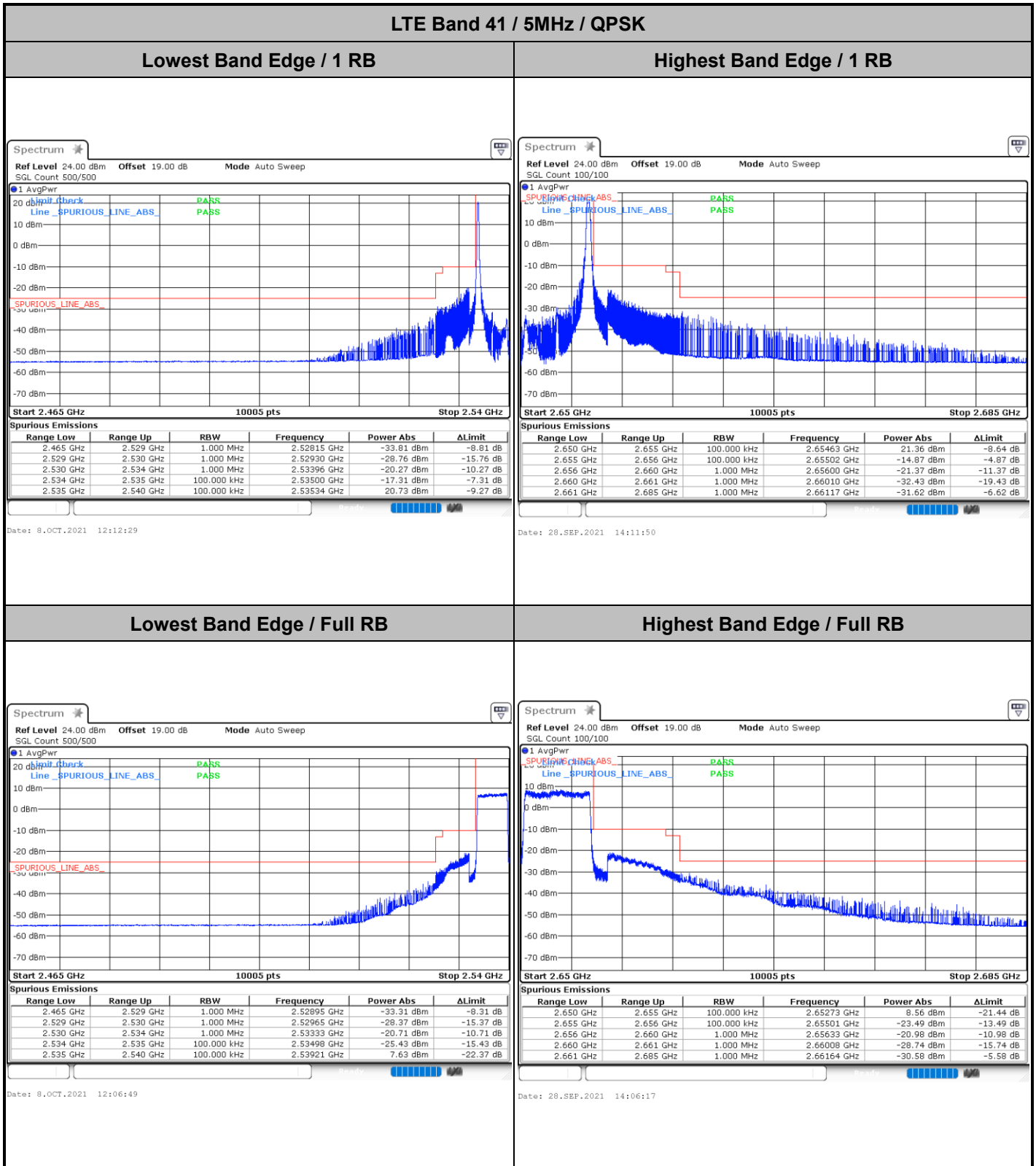



LTE Band 41 / 5MHz / 16QAM

Lowest Band Edge / 1RB

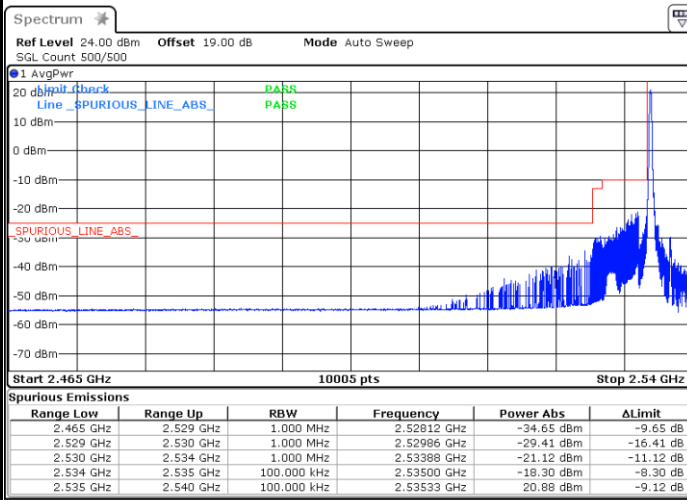

Date: 8.OCT.2021 12:11:31

Highest Band Edge / 1 RB

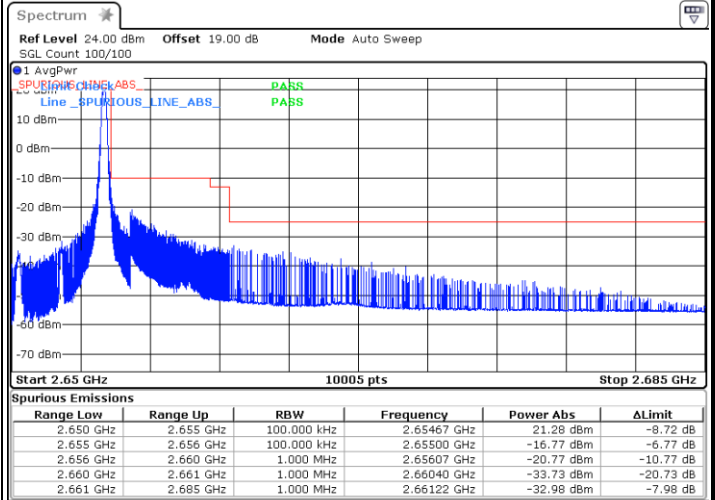

Date: 28.SEP.2021 14:11:11

Lowest Band Edge / Full RB

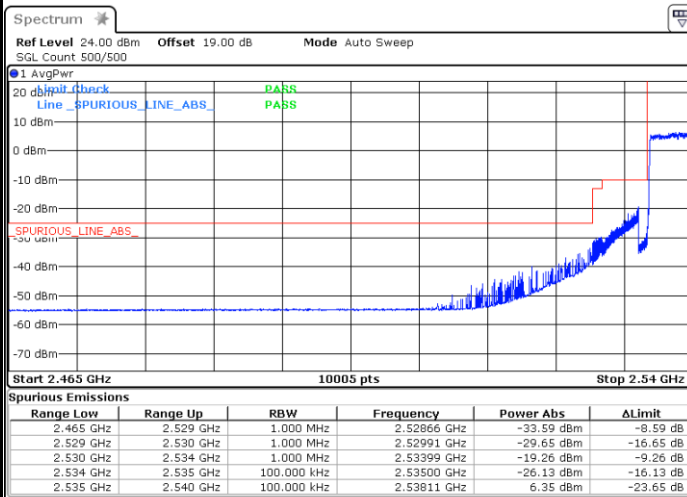

Date: 8.OCT.2021 12:07:57

Highest Band Edge / Full RB

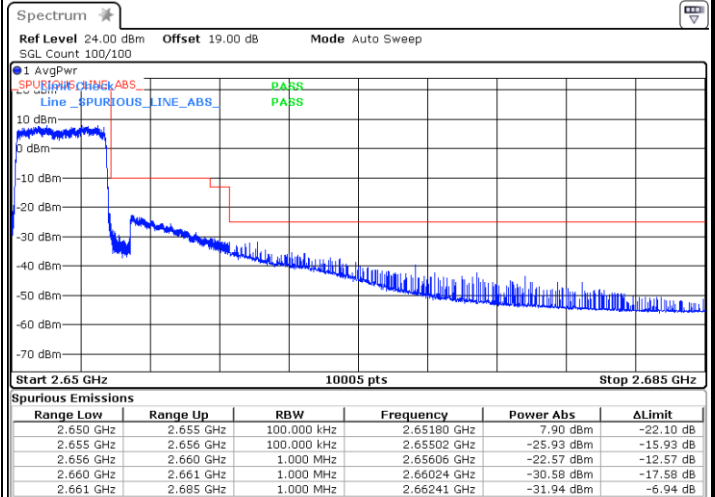

Date: 28.SEP.2021 14:07:51