

09_WLAN2.4G_802.11b 1Mbps_Left Cheek_0mm_Ch1

Communication System: UID 0, 802.11b (0); Frequency: 2412 MHz; Duty Cycle: 1:1.017
Medium: HSL_2450 Medium parameters used: $f = 2412$ MHz; $\sigma = 1.742$ S/m; $\epsilon_r = 39.379$; $\rho = 1000$ kg/m³

Ambient Temperature : 23.3 °C; Liquid Temperature : 22.8 °C

DASY5 Configuration:

- Probe: EX3DV4 - SN3857; ConvF(7.44, 7.44, 7.44); Calibrated: 2020.9.25
- Sensor-Surface: 1.4mm (Mechanical Surface Detection)
- Electronics: DAE4 Sn1338; Calibrated: 2020.11.27
- Phantom: SAM Twin Phantom; Type: SAM Twin; Serial: TP-1503
- Measurement SW: DASY52, Version 52.10 (4); SEMCAD X Version 14.6.14 (7483)

Area Scan (101x101x1): Interpolated grid: dx=1.200 mm, dy=1.200 mm

Maximum value of SAR (interpolated) = 0.544 W/kg

Zoom Scan (7x7x7)/Cube 0: Measurement grid: dx=5mm, dy=5mm, dz=5mm

Reference Value = 16.02 V/m; Power Drift = -0.08 dB

Peak SAR (extrapolated) = 0.627 W/kg

SAR(1 g) = 0.322 W/kg; SAR(10 g) = 0.147 W/kg

Maximum value of SAR (measured) = 0.486 W/kg

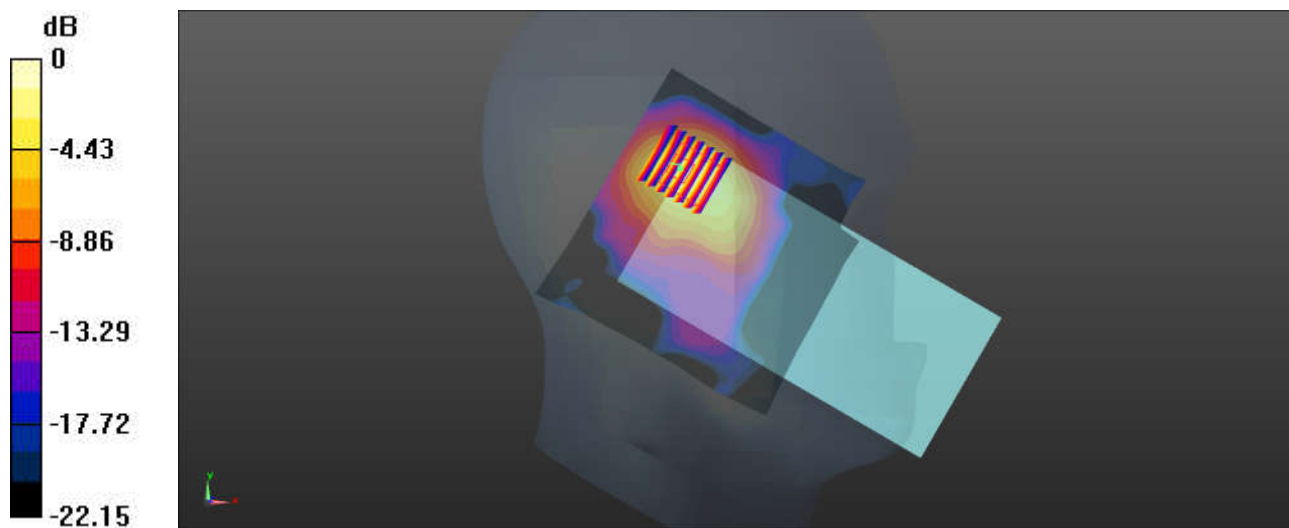

0 dB = 0.486 W/kg = -3.13 dBW/kg

10_Bluetooth_1Mbps_Left Cheek_0mm_Ch0

Communication System: UID 0, Bluetooth (0); Frequency: 2402 MHz; Duty Cycle: 1:1.287
 Medium: HSL_2450 Medium parameters used: $f = 2402$ MHz; $\sigma = 1.735$ S/m; $\epsilon_r = 39.381$; $\rho = 1000$ kg/m³

Ambient Temperature : 23.3 °C; Liquid Temperature : 22.8 °C

DASY5 Configuration:

- Probe: EX3DV4 - SN3857; ConvF(7.44, 7.44, 7.44); Calibrated: 2020.9.25
- Sensor-Surface: 1.4mm (Mechanical Surface Detection)
- Electronics: DAE4 Sn1338; Calibrated: 2020.11.27
- Phantom: SAM Twin Phantom; Type: SAM Twin; Serial: TP-1503
- Measurement SW: DASY52, Version 52.10 (4); SEMCAD X Version 14.6.14 (7483)

Area Scan (71x81x1): Interpolated grid: dx=1.200 mm, dy=1.200 mm
 Maximum value of SAR (interpolated) = 0.165 W/kg

Zoom Scan (7x7x7)/Cube 0: Measurement grid: dx=5mm, dy=5mm, dz=5mm
 Reference Value = 8.210 V/m; Power Drift = 0.07 dB
 Peak SAR (extrapolated) = 0.172 W/kg
SAR(1 g) = 0.057 W/kg; SAR(10 g) = 0.031 W/kg
 Maximum value of SAR (measured) = 0.139 W/kg

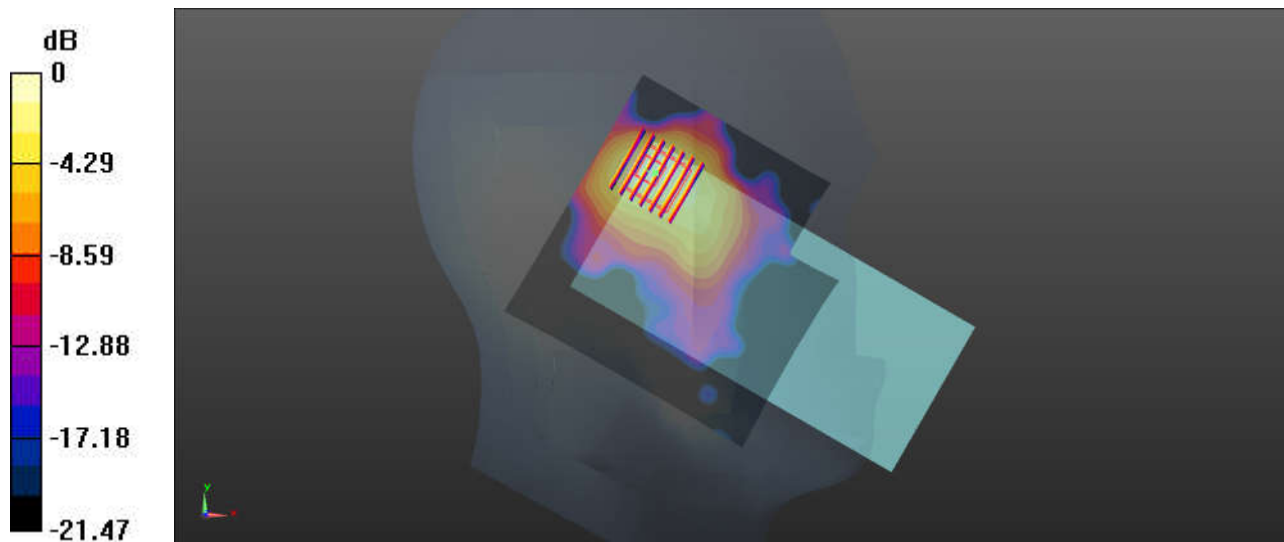

0 dB = 0.139 W/kg = -8.57 dBW/kg

11_GSM850_GPRS (2 Tx slots)_Back_5mm_Ch189

Communication System: UID 0, GSM850 (0); Frequency: 836.4 MHz; Duty Cycle: 1:4.15
Medium: HSL_835 Medium parameters used: $f = 836.4$ MHz; $\sigma = 0.939$ S/m; $\epsilon_r = 42.438$; $\rho = 1000$ kg/m³

Ambient Temperature : 23.3 °C; Liquid Temperature : 22.6 °C

DASY5 Configuration:

- Probe: EX3DV4 - SN3857; ConvF(9.18, 9.18, 9.18); Calibrated: 2020.9.25
- Sensor-Surface: 1.4mm (Mechanical Surface Detection)
- Electronics: DAE4 Sn1338; Calibrated: 2020.11.27
- Phantom: SAM Twin Phantom; Type: SAM Twin; Serial: TP-1503
- Measurement SW: DASY52, Version 52.10 (4); SEMCAD X Version 14.6.14 (7483)

Area Scan (81x81x1): Interpolated grid: dx=1.500 mm, dy=1.500 mm

Maximum value of SAR (interpolated) = 1.13 W/kg

Zoom Scan (6x6x7)/Cube 0: Measurement grid: dx=8mm, dy=8mm, dz=5mm

Reference Value = 33.58 V/m; Power Drift = -0.14 dB

Peak SAR (extrapolated) = 1.44 W/kg

SAR(1 g) = 0.701 W/kg; SAR(10 g) = 0.389 W/kg

Maximum value of SAR (measured) = 1.12 W/kg

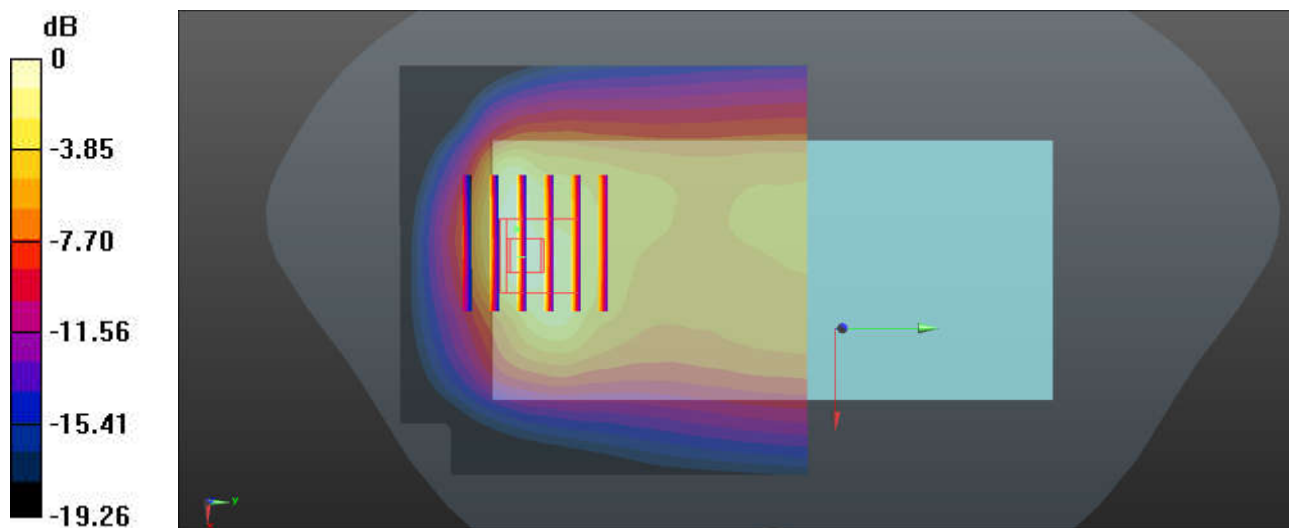

0 dB = 1.12 W/kg = 0.49 dBW/kg

12_GSM1900_GPRS (2 Tx slots)_Bottom Side_5mm_Ch810

Communication System: UID 0, PCS (0); Frequency: 1909.8 MHz; Duty Cycle: 1:4.15
Medium: HSL_1900 Medium parameters used: $f = 1910$ MHz; $\sigma = 1.437$ S/m; $\epsilon_r = 38.564$; $\rho = 1000$ kg/m³
Ambient Temperature : 23.2 °C; Liquid Temperature : 22.7 °C

- DASY5 Configuration:
- Probe: EX3DV4 - SN3857; ConvF(7.81, 7.81, 7.81); Calibrated: 2020.9.25
 - Sensor-Surface: 1.4mm (Mechanical Surface Detection)
 - Electronics: DAE4 Sn1338; Calibrated: 2020.11.27
 - Phantom: SAM Twin Phantom; Type: SAM Twin; Serial: TP-1503
 - Measurement SW: DASY52, Version 52.10 (4); SEMCAD X Version 14.6.14 (7483)

Area Scan (41x81x1): Interpolated grid: dx=1.500 mm, dy=1.500 mm
Maximum value of SAR (interpolated) = 1.62 W/kg

Zoom Scan (5x5x7)/Cube 0: Measurement grid: dx=8mm, dy=8mm, dz=5mm
Reference Value = 33.73 V/m; Power Drift = -0.08 dB
Peak SAR (extrapolated) = 1.86 W/kg
SAR(1 g) = 0.959 W/kg; SAR(10 g) = 0.475 W/kg
Maximum value of SAR (measured) = 1.53 W/kg

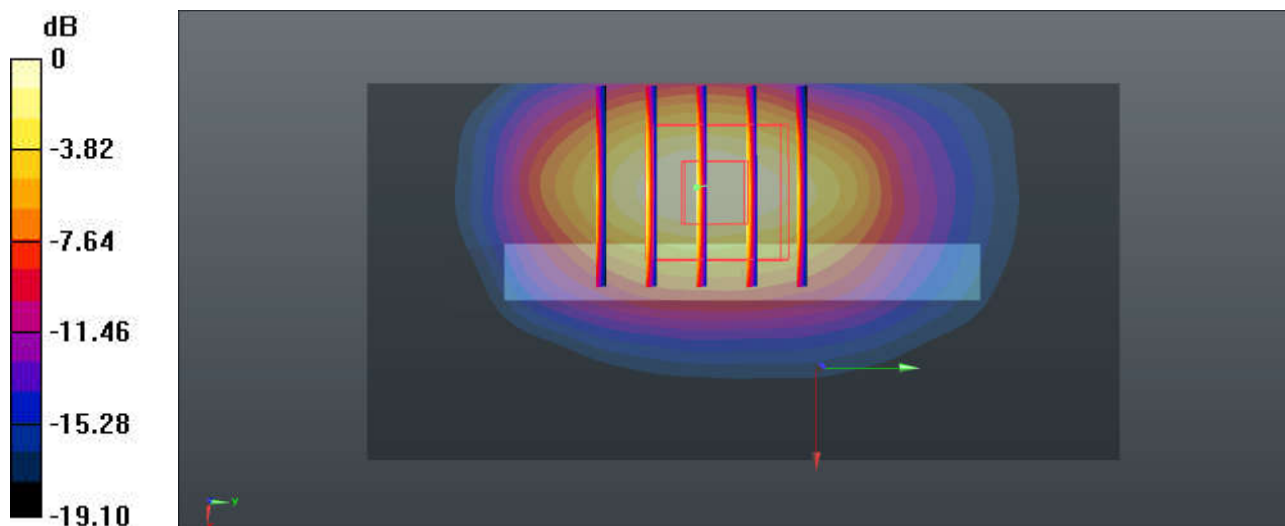

0 dB = 1.53 W/kg = 1.85 dBW/kg

13_WCDMA II_RMC 12.2Kbps_Bottom Side_5mm_Ch9538

Communication System: UID 0, WCDMA (0); Frequency: 1907.6 MHz; Duty Cycle: 1:1
Medium: HSL_1900 Medium parameters used: $f = 1908$ MHz; $\sigma = 1.436$ S/m; $\epsilon_r = 38.573$; $\rho = 1000$ kg/m³
Ambient Temperature : 23.2 °C; Liquid Temperature : 22.7 °C

DASY5 Configuration:

- Probe: EX3DV4 - SN3857; ConvF(7.81, 7.81, 7.81); Calibrated: 2020.9.25
- Sensor-Surface: 3mm (Mechanical Surface Detection)
- Electronics: DAE4 Sn1338; Calibrated: 2020.11.27
- Phantom: SAM Twin Phantom; Type: SAM Twin; Serial: TP-1503
- Measurement SW: DASY52, Version 52.10 (4); SEMCAD X Version 14.6.14 (7483)

Area Scan (51x101x1): Interpolated grid: dx=1.200 mm, dy=1.200 mm
Maximum value of SAR (interpolated) = 1.97 W/kg

Zoom Scan (5x5x7)/Cube 0: Measurement grid: dx=8mm, dy=8mm, dz=5mm
Reference Value = 35.94 V/m; Power Drift = -0.06 dB
Peak SAR (extrapolated) = 2.39 W/kg
SAR(1 g) = 1.28 W/kg; SAR(10 g) = 0.639 W/kg
Maximum value of SAR (measured) = 1.63 W/kg

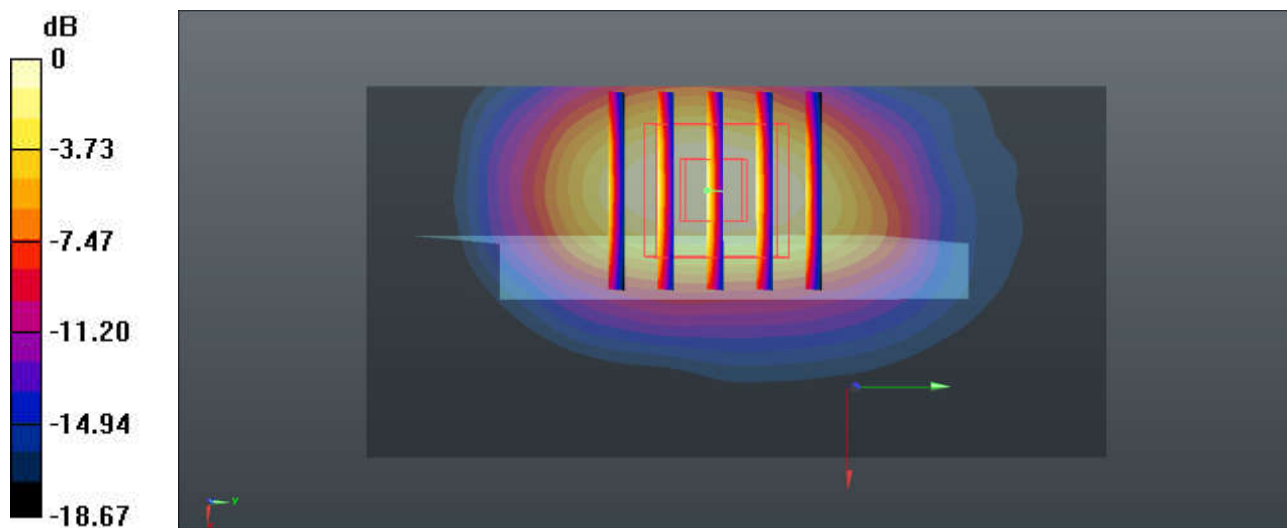

0 dB = 1.63 W/kg = 2.12 dBW/kg

14_WCDMA V_RMC 12.2Kbps_Back_5mm_Ch4182

Communication System: UID 0, WCDMA (0); Frequency: 836.4 MHz; Duty Cycle: 1:1
Medium: HSL_835 Medium parameters used: $f = 836.4$ MHz; $\sigma = 0.939$ S/m; $\epsilon_r = 42.438$; $\rho = 1000$ kg/m³

Ambient Temperature : 23.3 °C; Liquid Temperature : 22.6 °C

DASY5 Configuration:

- Probe: EX3DV4 - SN3857; ConvF(9.18, 9.18, 9.18); Calibrated: 2020.9.25
- Sensor-Surface: 1.4mm (Mechanical Surface Detection)
- Electronics: DAE4 Sn1338; Calibrated: 2020.11.27
- Phantom: SAM Twin Phantom; Type: SAM Twin; Serial: TP-1503
- Measurement SW: DASY52, Version 52.10 (4); SEMCAD X Version 14.6.14 (7483)

Area Scan (81x81x1): Interpolated grid: dx=1.500 mm, dy=1.500 mm

Maximum value of SAR (interpolated) = 0.893 W/kg

Zoom Scan (6x6x7)/Cube 0: Measurement grid: dx=8mm, dy=8mm, dz=5mm

Reference Value = 28.93 V/m; Power Drift = -0.13 dB

Peak SAR (extrapolated) = 1.10 W/kg

SAR(1 g) = 0.538 W/kg; SAR(10 g) = 0.302 W/kg

Maximum value of SAR (measured) = 0.849 W/kg

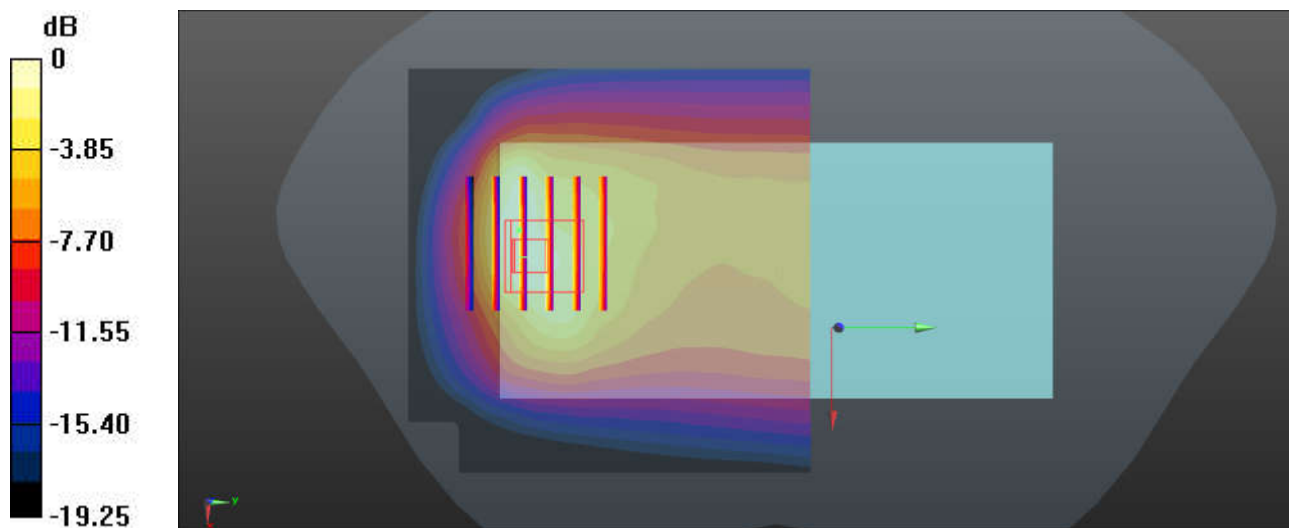

0 dB = 0.849 W/kg = -0.71 dBW/kg

15_LTE Band 2_20M_QPSK_1RB_0Offset_Bottom Side_5mm_Ch19100

Communication System: UID 0, LTE-FDD (0); Frequency: 1900 MHz; Duty Cycle: 1:1
Medium: HSL_1900 Medium parameters used: $f = 1900$ MHz; $\sigma = 1.431$ S/m; $\epsilon_r = 38.637$; $\rho = 1000$ kg/m³

Ambient Temperature : 23.2 °C; Liquid Temperature : 22.7 °C

DASY5 Configuration:

- Probe: EX3DV4 - SN3857; ConvF(7.81, 7.81, 7.81); Calibrated: 2020.9.25
- Sensor-Surface: 1.4mm (Mechanical Surface Detection)
- Electronics: DAE4 Sn1338; Calibrated: 2020.11.27
- Phantom: SAM Twin Phantom; Type: SAM Twin; Serial: TP-1503
- Measurement SW: DASY52, Version 52.10 (4); SEMCAD X Version 14.6.14 (7483)

Area Scan (31x81x1): Interpolated grid: dx=1.500 mm, dy=1.500 mm

Maximum value of SAR (interpolated) = 2.10 W/kg

Zoom Scan (5x5x7)/Cube 0: Measurement grid: dx=8mm, dy=8mm, dz=5mm

Reference Value = 38.35 V/m; Power Drift = -0.02 dB

Peak SAR (extrapolated) = 2.49 W/kg

SAR(1 g) = 1.24 W/kg; SAR(10 g) = 0.605 W/kg

Maximum value of SAR (measured) = 1.99 W/kg

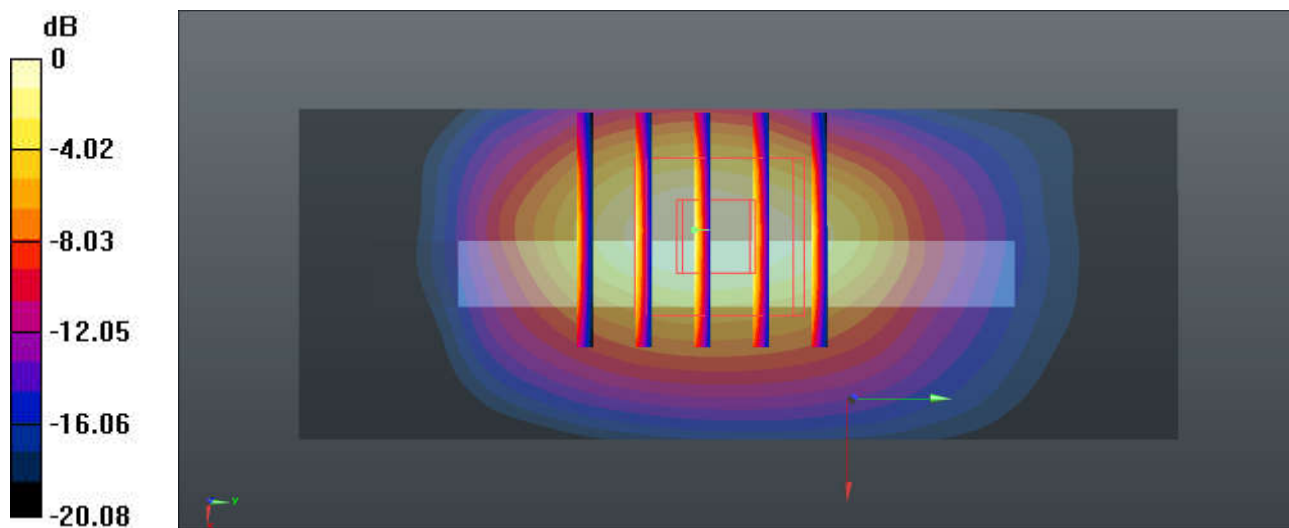

0 dB = 1.99 W/kg = 2.99 dBW/kg

16_LTE Band 7_20M_QPSK_1RB_0Offset_Back_5mm_Ch20850

Communication System: UID 0, LTE-FDD (0); Frequency: 2510 MHz; Duty Cycle: 1:1
Medium: HSL_2600 Medium parameters used: $f = 2510$ MHz; $\sigma = 1.94$ S/m; $\epsilon_r = 40.714$; $\rho = 1000$ kg/m³

Ambient Temperature : 23.1 °C; Liquid Temperature : 22.9 °C

DASY5 Configuration:

- Probe: EX3DV4 - SN3857; ConvF(7.19, 7.19, 7.19); Calibrated: 2020.9.25
- Sensor-Surface: 1.4mm (Mechanical Surface Detection)
- Electronics: DAE4 Sn1338; Calibrated: 2020.11.27
- Phantom: SAM Twin Phantom; Type: SAM Twin; Serial: TP-1503
- Measurement SW: DASY52, Version 52.10 (4); SEMCAD X Version 14.6.14 (7483)

Area Scan (101x101x1): Interpolated grid: dx=1.200 mm, dy=1.200 mm

Maximum value of SAR (interpolated) = 1.53 W/kg

Zoom Scan (7x7x7)/Cube 0: Measurement grid: dx=5mm, dy=5mm, dz=5mm

Reference Value = 27.39 V/m; Power Drift = -0.03 dB

Peak SAR (extrapolated) = 2.57 W/kg

SAR(1 g) = 1.18 W/kg; SAR(10 g) = 0.610 W/kg

Maximum value of SAR (measured) = 2.06 W/kg

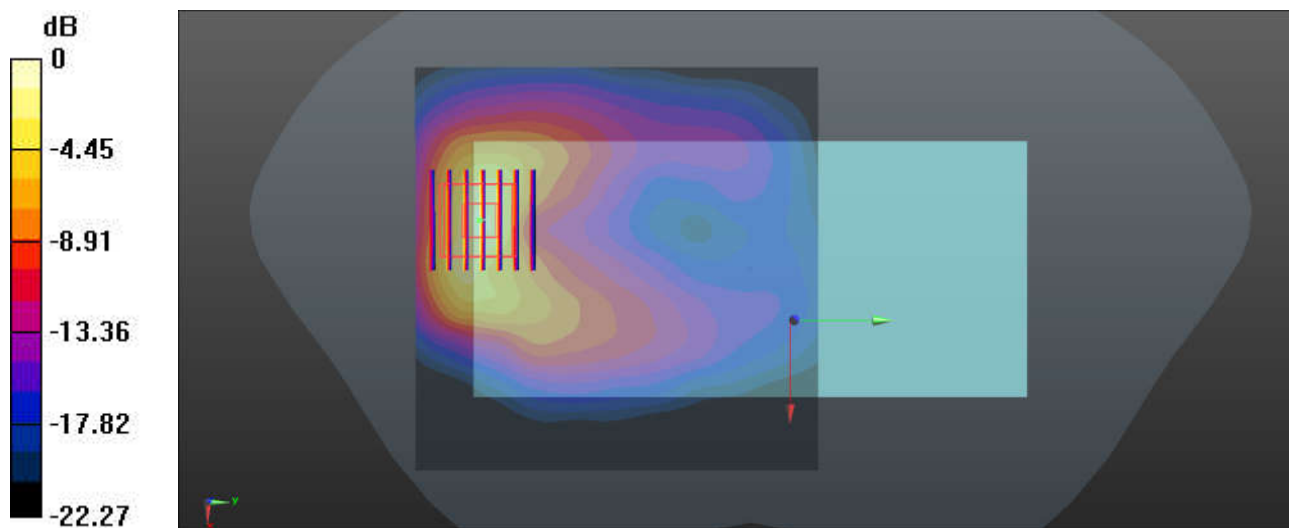

0 dB = 2.06 W/kg = 3.14 dBW/kg

17_LTE Band 26_15M_QPSK_1RB_0Offset_Back_5mm_Ch26865

Communication System: UID 0, LTE-FDD (0); Frequency: 831.5 MHz; Duty Cycle: 1:1
Medium: HSL_835 Medium parameters used: $f = 831.5$ MHz; $\sigma = 0.937$ S/m; $\epsilon_r = 42.457$; $\rho = 1000$ kg/m³
Ambient Temperature : 23.3 °C; Liquid Temperature : 22.6 °C

DASY5 Configuration:

- Probe: EX3DV4 - SN3857; ConvF(9.18, 9.18, 9.18); Calibrated: 2020.9.25
- Sensor-Surface: 1.4mm (Mechanical Surface Detection)
- Electronics: DAE4 Sn1338; Calibrated: 2020.11.27
- Phantom: SAM Twin Phantom; Type: SAM Twin; Serial: TP-1503
- Measurement SW: DASY52, Version 52.10 (4); SEMCAD X Version 14.6.14 (7483)

Area Scan (81x81x1): Interpolated grid: dx=1.500 mm, dy=1.500 mm
Maximum value of SAR (interpolated) = 1.03 W/kg

Zoom Scan (6x6x7)/Cube 0: Measurement grid: dx=8mm, dy=8mm, dz=5mm
Reference Value = 29.49 V/m; Power Drift = -0.13 dB
Peak SAR (extrapolated) = 1.17 W/kg
SAR(1 g) = 0.627 W/kg; SAR(10 g) = 0.365 W/kg
Maximum value of SAR (measured) = 0.946 W/kg

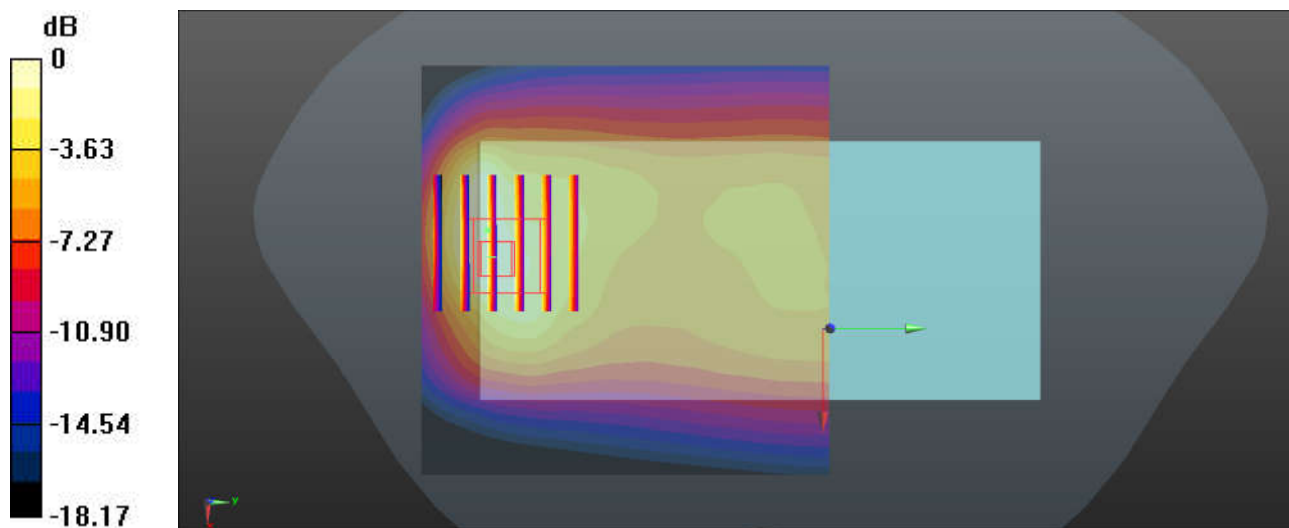

0 dB = 0.946 W/kg = -0.24 dBW/kg

18_LTE Band 41_20M_QPSK_1RB_0Offset_Bottom Side_5mm_Ch41490

Communication System: UID 0, LTE-TDD (0); Frequency: 2680 MHz; Duty Cycle: 1:1.59
Medium: HSL_2600 Medium parameters used: $f = 2680$ MHz; $\sigma = 2.078$ S/m; $\epsilon_r = 40.424$; $\rho = 1000$ kg/m³

Ambient Temperature : 23.1 °C; Liquid Temperature : 22.9 °C

DASY5 Configuration:

- Probe: EX3DV4 - SN3857; ConvF(7.19, 7.19, 7.19); Calibrated: 2020.9.25
- Sensor-Surface: 1.4mm (Mechanical Surface Detection)
- Electronics: DAE4 Sn1338; Calibrated: 2020.11.27
- Phantom: SAM Twin Phantom; Type: SAM Twin; Serial: TP-1503
- Measurement SW: DASY52, Version 52.10 (4); SEMCAD X Version 14.6.14 (7483)

Area Scan (51x101x1): Interpolated grid: dx=1.200 mm, dy=1.200 mm

Maximum value of SAR (interpolated) = 1.42 W/kg

Zoom Scan (7x7x7)/Cube 0: Measurement grid: dx=5mm, dy=5mm, dz=5mm

Reference Value = 27.39 V/m; Power Drift = -0.01 dB

Peak SAR (extrapolated) = 1.73 W/kg

SAR(1 g) = 0.840 W/kg; SAR(10 g) = 0.369 W/kg

Maximum value of SAR (measured) = 1.42 W/kg

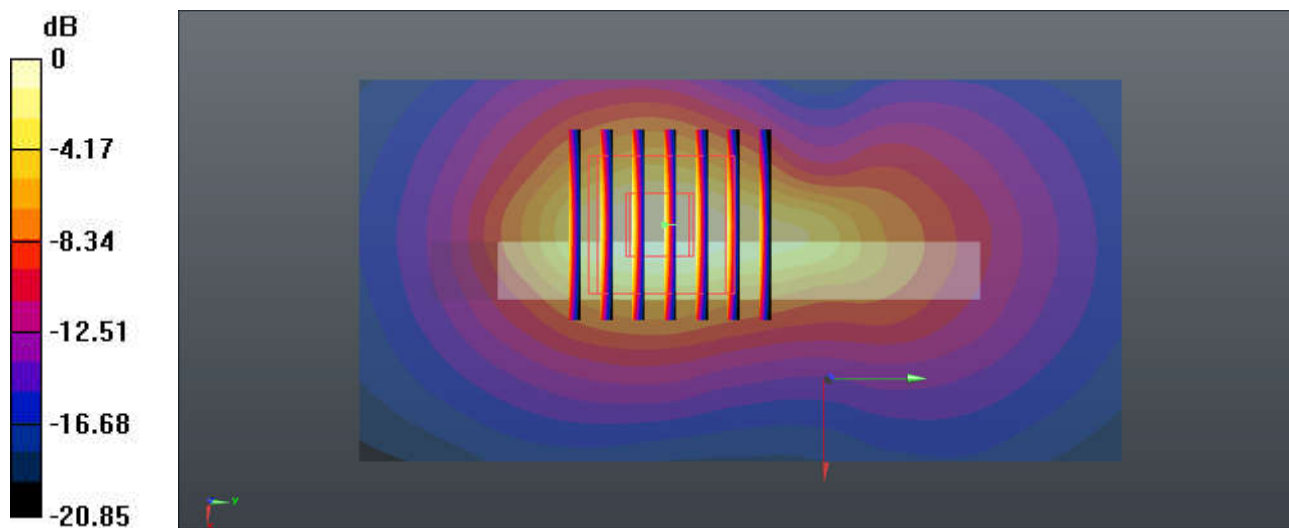

0 dB = 1.42 W/kg = 1.52 dBW/kg

19_WLAN2.4G_802.11b 1Mbps_Top Side_5mm_Ch1

Communication System: UID 0, WLAN2.4GHz (0); Frequency: 2412 MHz; Duty Cycle: 1:1.017
Medium: HSL_2450 Medium parameters used: $f = 2412$ MHz; $\sigma = 1.742$ S/m; $\epsilon_r = 39.379$; $\rho = 1000$ kg/m³

Ambient Temperature : 23.3 °C; Liquid Temperature : 22.8 °C

DASY5 Configuration:

- Probe: EX3DV4 - SN3857; ConvF(7.44, 7.44, 7.44); Calibrated: 2020.9.25
- Sensor-Surface: 1.4mm (Mechanical Surface Detection)
- Electronics: DAE4 Sn1338; Calibrated: 2020.11.27
- Phantom: SAM Twin Phantom; Type: SAM Twin; Serial: TP-1503
- Measurement SW: DASY52, Version 52.10 (4); SEMCAD X Version 14.6.14 (7483)

Area Scan (51x101x1): Interpolated grid: dx=1.200 mm, dy=1.200 mm

Maximum value of SAR (interpolated) = 0.746 W/kg

Zoom Scan (7x7x7)/Cube 0: Measurement grid: dx=5mm, dy=5mm, dz=5mm

Reference Value = 20.59 V/m; Power Drift = 0.13 dB

Peak SAR (extrapolated) = 1.02 W/kg

SAR(1 g) = 0.250 W/kg; SAR(10 g) = 0.113 W/kg

Maximum value of SAR (measured) = 0.795 W/kg

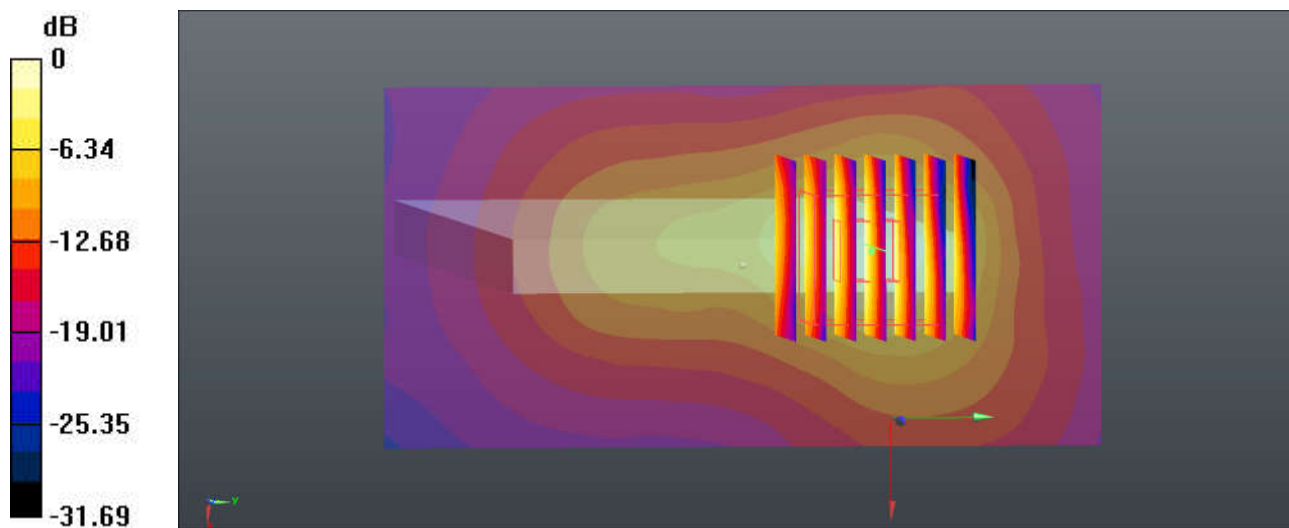

0 dB = 0.795 W/kg = -1.00 dBW/kg

20_Bluetooth_1Mbps_Top Side_5mm_Ch0

Communication System: UID 0, Bluetooth (0); Frequency: 2402 MHz; Duty Cycle: 1:1.287
Medium: HSL_2450 Medium parameters used: $f = 2402$ MHz; $\sigma = 1.735$ S/m; $\epsilon_r = 39.381$; $\rho = 1000$ kg/m³

Ambient Temperature : 23.3 °C; Liquid Temperature : 22.8 °C

DASY5 Configuration:

- Probe: EX3DV4 - SN3857; ConvF(7.44, 7.44, 7.44); Calibrated: 2020.9.25
- Sensor-Surface: 1.4mm (Mechanical Surface Detection)
- Electronics: DAE4 Sn1338; Calibrated: 2020.11.27
- Phantom: SAM Twin Phantom; Type: SAM Twin; Serial: TP-1503
- Measurement SW: DASY52, Version 52.10 (4); SEMCAD X Version 14.6.14 (7483)

Area Scan (51x101x1): Interpolated grid: dx=1.200 mm, dy=1.200 mm

Maximum value of SAR (interpolated) = 0.111 W/kg

Zoom Scan (7x7x7)/Cube 0: Measurement grid: dx=5mm, dy=5mm, dz=5mm

Reference Value = 8.049 V/m; Power Drift = -0.08 dB

Peak SAR (extrapolated) = 0.140 W/kg

SAR(1 g) = 0.062 W/kg; SAR(10 g) = 0.023 W/kg

Maximum value of SAR (measured) = 0.106 W/kg

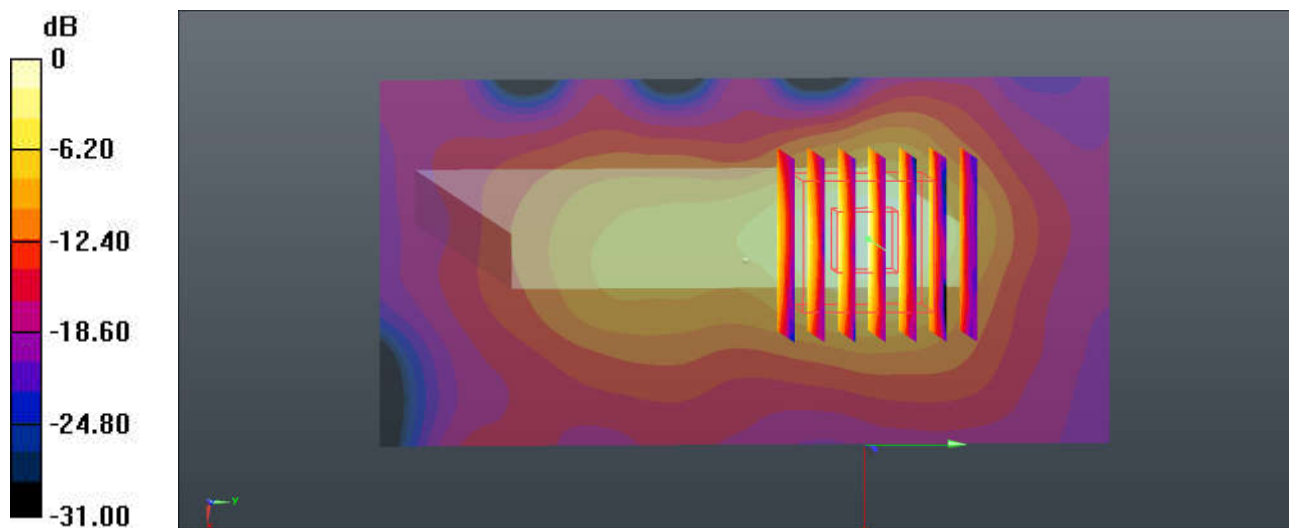

0 dB = 0.106 W/kg = -9.75 dBW/kg

21_GSM850_GPRS (2 Tx slots)_Back_5mm_Ch189

Communication System: UID 0, GSM850 (0); Frequency: 836.4 MHz; Duty Cycle: 1:4.15
Medium: HSL_835 Medium parameters used: $f = 836.4$ MHz; $\sigma = 0.939$ S/m; $\epsilon_r = 42.438$; $\rho = 1000$ kg/m³

Ambient Temperature : 23.3 °C; Liquid Temperature : 22.6 °C

DASY5 Configuration:

- Probe: EX3DV4 - SN3857; ConvF(9.18, 9.18, 9.18); Calibrated: 2020.9.25
- Sensor-Surface: 1.4mm (Mechanical Surface Detection)
- Electronics: DAE4 Sn1338; Calibrated: 2020.11.27
- Phantom: SAM Twin Phantom; Type: SAM Twin; Serial: TP-1503
- Measurement SW: DASY52, Version 52.10 (4); SEMCAD X Version 14.6.14 (7483)

Area Scan (81x81x1): Interpolated grid: dx=1.500 mm, dy=1.500 mm

Maximum value of SAR (interpolated) = 1.13 W/kg

Zoom Scan (6x6x7)/Cube 0: Measurement grid: dx=8mm, dy=8mm, dz=5mm

Reference Value = 33.58 V/m; Power Drift = -0.14 dB

Peak SAR (extrapolated) = 1.44 W/kg

SAR(1 g) = 0.701 W/kg; SAR(10 g) = 0.389 W/kg

Maximum value of SAR (measured) = 1.12 W/kg

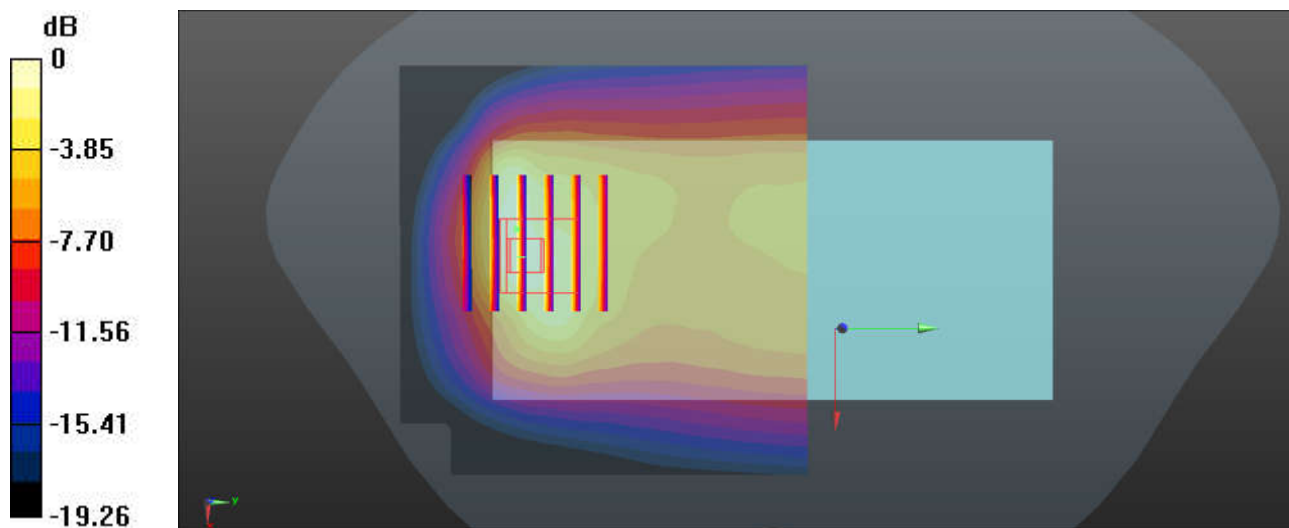

0 dB = 1.12 W/kg = 0.49 dBW/kg

22_GSM1900_GPRS (2 Tx slots)_Back_5mm_Ch661

Communication System: UID 0, PCS (0); Frequency: 1880 MHz; Duty Cycle: 1:4.15

Medium: HSL_1900 Medium parameters used: $f = 1880$ MHz; $\sigma = 1.424$ S/m; $\epsilon_r = 38.827$; $\rho = 1000$ kg/m³

Ambient Temperature : 23.2 °C; Liquid Temperature : 22.7 °C

DASY5 Configuration:

- Probe: EX3DV4 - SN3857; ConvF(7.81, 7.81, 7.81); Calibrated: 2020.9.25
- Sensor-Surface: 1.4mm (Mechanical Surface Detection)
- Electronics: DAE4 Sn1338; Calibrated: 2020.11.27
- Phantom: SAM Twin Phantom; Type: SAM Twin; Serial: TP-1503
- Measurement SW: DASY52, Version 52.10 (4); SEMCAD X Version 14.6.14 (7483)

Area Scan (81x81x1): Interpolated grid: dx=1.500 mm, dy=1.500 mm

Maximum value of SAR (interpolated) = 1.73 W/kg

Zoom Scan (5x5x7)/Cube 0: Measurement grid: dx=8mm, dy=8mm, dz=5mm

Reference Value = 34.55 V/m; Power Drift = 0.08 dB

Peak SAR (extrapolated) = 2.11 W/kg

SAR(1 g) = 0.971 W/kg; SAR(10 g) = 0.550 W/kg

Maximum value of SAR (measured) = 1.69 W/kg

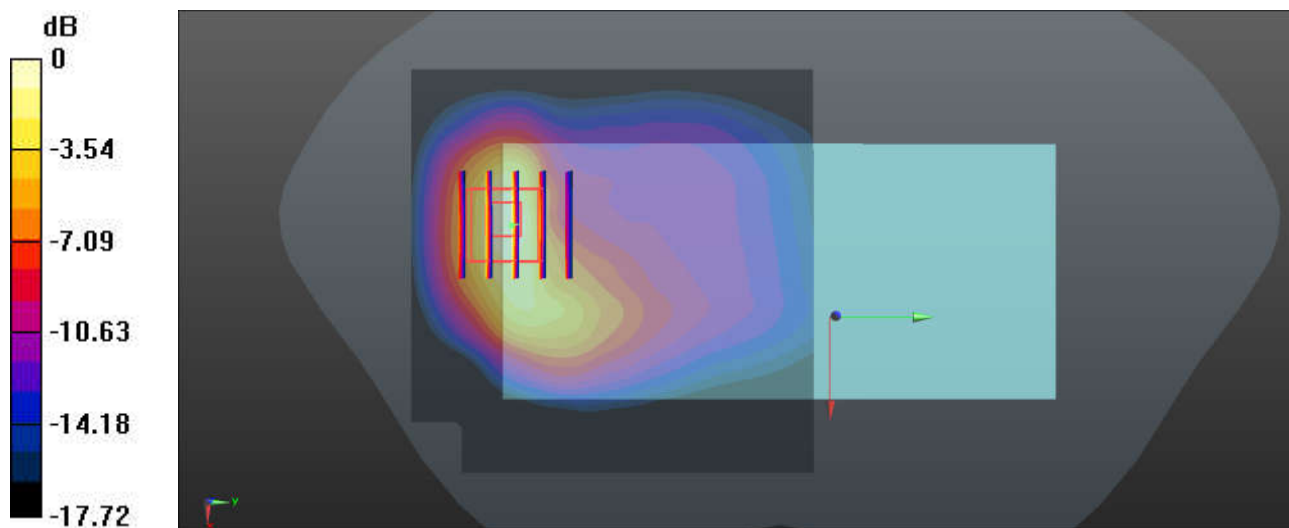

0 dB = 1.69 W/kg = 2.28 dBW/kg

23_WCDMA II_RMC 12.2Kbps_Back_5mm_Ch9400

Communication System: UID 0, WCDMA (0); Frequency: 1880 MHz; Duty Cycle: 1:1
Medium: HSL_1900 Medium parameters used: $f = 1880$ MHz; $\sigma = 1.424$ S/m; $\epsilon_r = 38.827$; $\rho = 1000$ kg/m³

Ambient Temperature : 23.2 °C; Liquid Temperature : 22.7 °C

DASY5 Configuration:

- Probe: EX3DV4 - SN3857; ConvF(7.81, 7.81, 7.81); Calibrated: 2020.9.25
- Sensor-Surface: 1.4mm (Mechanical Surface Detection)
- Electronics: DAE4 Sn1338; Calibrated: 2020.11.27
- Phantom: SAM Twin Phantom; Type: SAM Twin; Serial: TP-1503
- Measurement SW: DASY52, Version 52.10 (4); SEMCAD X Version 14.6.14 (7483)

Area Scan (81x81x1): Interpolated grid: dx=1.500 mm, dy=1.500 mm
Maximum value of SAR (interpolated) = 1.64 W/kg

Zoom Scan (5x5x7)/Cube 0: Measurement grid: dx=8mm, dy=8mm, dz=5mm
Reference Value = 38.61 V/m; Power Drift = 0.11 dB
Peak SAR (extrapolated) = 2.35 W/kg
SAR(1 g) = 1.23 W/kg; SAR(10 g) = 0.635 W/kg
Maximum value of SAR (measured) = 1.90 W/kg

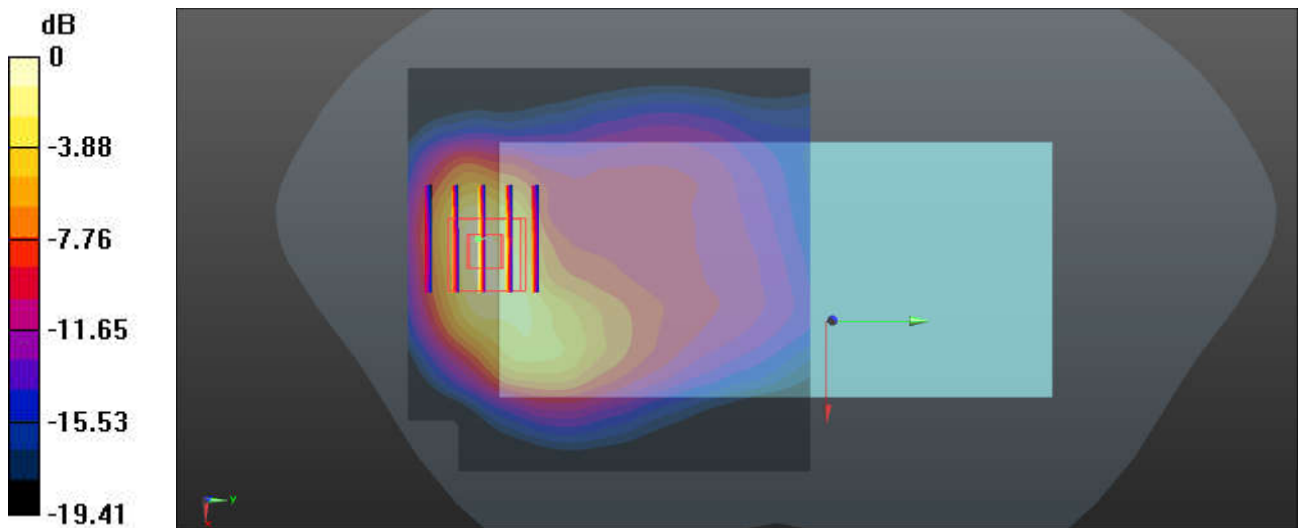

0 dB = 1.90 W/kg = 2.79 dBW/kg

24_WCDMA V_RMC 12.2Kbps_Back_5mm_Ch4182

Communication System: UID 0, WCDMA (0); Frequency: 836.4 MHz; Duty Cycle: 1:1
Medium: HSL_835 Medium parameters used: $f = 836.4$ MHz; $\sigma = 0.939$ S/m; $\epsilon_r = 42.438$; $\rho = 1000$ kg/m³
Ambient Temperature : 23.3 °C; Liquid Temperature : 22.6 °C

DASY5 Configuration:

- Probe: EX3DV4 - SN3857; ConvF(9.18, 9.18, 9.18); Calibrated: 2020.9.25
- Sensor-Surface: 1.4mm (Mechanical Surface Detection)
- Electronics: DAE4 Sn1338; Calibrated: 2020.11.27
- Phantom: SAM Twin Phantom; Type: SAM Twin; Serial: TP-1503
- Measurement SW: DASY52, Version 52.10 (4); SEMCAD X Version 14.6.14 (7483)

Area Scan (81x81x1): Interpolated grid: dx=1.500 mm, dy=1.500 mm
Maximum value of SAR (interpolated) = 0.893 W/kg

Zoom Scan (6x6x7)/Cube 0: Measurement grid: dx=8mm, dy=8mm, dz=5mm
Reference Value = 28.93 V/m; Power Drift = -0.13 dB
Peak SAR (extrapolated) = 1.10 W/kg
SAR(1 g) = 0.538 W/kg; SAR(10 g) = 0.302 W/kg
Maximum value of SAR (measured) = 0.849 W/kg

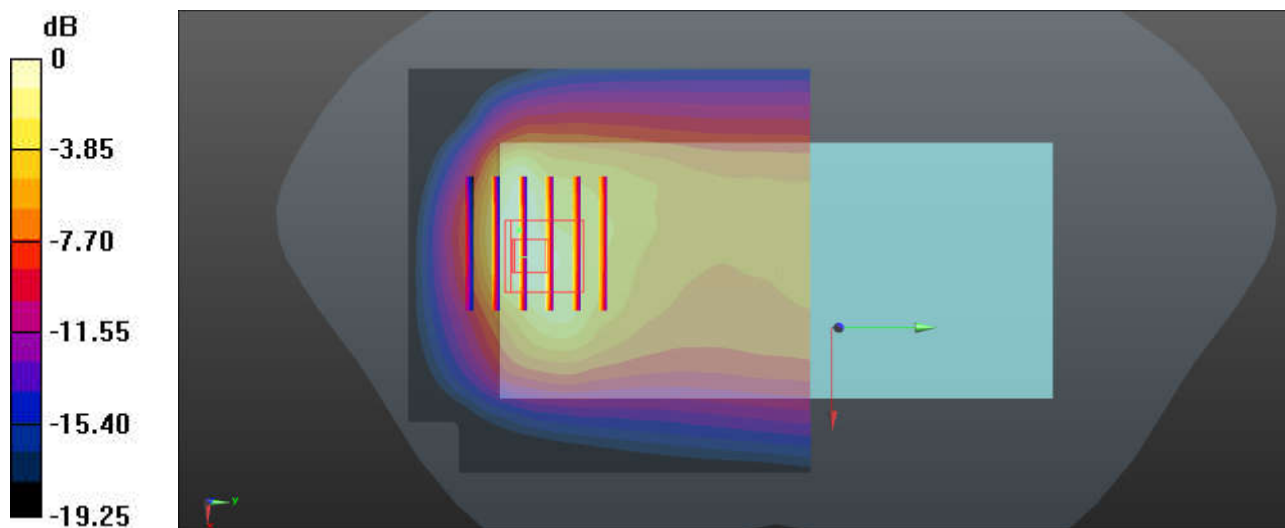

0 dB = 0.849 W/kg = -0.71 dBW/kg

25_LTE Band 2_20M_QPSK_1RB_0Offset_Back_5mm_Ch19100

Communication System: UID 0, LTE-FDD (0); Frequency: 1900 MHz; Duty Cycle: 1:1
Medium: HSL_1900 Medium parameters used: $f = 1900$ MHz; $\sigma = 1.431$ S/m; $\epsilon_r = 38.637$; $\rho = 1000$ kg/m³
Ambient Temperature : 23.2 °C; Liquid Temperature : 22.7 °C

DASY5 Configuration:

- Probe: EX3DV4 - SN3857; ConvF(7.81, 7.81, 7.81); Calibrated: 2020.9.25
- Sensor-Surface: 1.4mm (Mechanical Surface Detection)
- Electronics: DAE4 Sn1338; Calibrated: 2020.11.27
- Phantom: SAM Twin Phantom; Type: SAM Twin; Serial: TP-1503
- Measurement SW: DASY52, Version 52.10 (4); SEMCAD X Version 14.6.14 (7483)

Area Scan (81x81x1): Interpolated grid: dx=1.500 mm, dy=1.500 mm
Maximum value of SAR (interpolated) = 1.90 W/kg

Zoom Scan (6x6x7)/Cube 0: Measurement grid: dx=8mm, dy=8mm, dz=5mm
Reference Value = 36.80 V/m; Power Drift = 0.02 dB
Peak SAR (extrapolated) = 2.26 W/kg
SAR(1 g) = 1.19 W/kg; SAR(10 g) = 0.619 W/kg
Maximum value of SAR (measured) = 1.85 W/kg

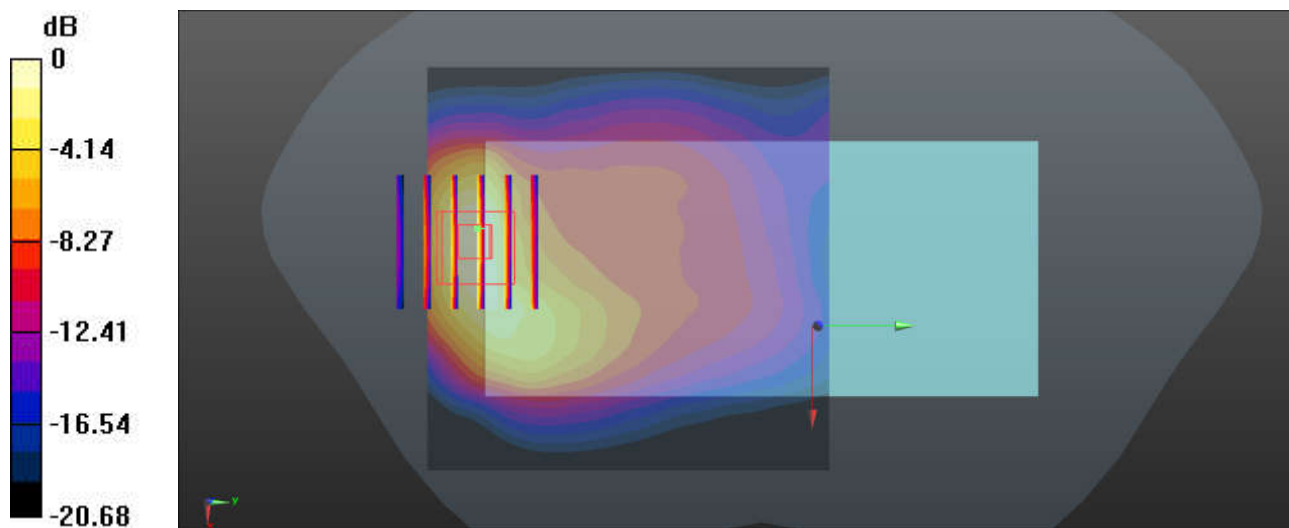

0 dB = 1.85 W/kg = 2.67 dBW/kg

26_LTE Band 7_20M_QPSK_1RB_0Offset_Back_5mm_Ch20850

Communication System: UID 0, LTE-FDD (0); Frequency: 2510 MHz; Duty Cycle: 1:1
Medium: HSL_2600 Medium parameters used: $f = 2510$ MHz; $\sigma = 1.94$ S/m; $\epsilon_r = 40.714$; $\rho = 1000$ kg/m³

Ambient Temperature : 23.1 °C; Liquid Temperature : 22.9 °C

DASY5 Configuration:

- Probe: EX3DV4 - SN3857; ConvF(7.19, 7.19, 7.19); Calibrated: 2020.9.25
- Sensor-Surface: 1.4mm (Mechanical Surface Detection)
- Electronics: DAE4 Sn1338; Calibrated: 2020.11.27
- Phantom: SAM Twin Phantom; Type: SAM Twin; Serial: TP-1503
- Measurement SW: DASY52, Version 52.10 (4); SEMCAD X Version 14.6.14 (7483)

Area Scan (101x101x1): Interpolated grid: dx=1.200 mm, dy=1.200 mm
Maximum value of SAR (interpolated) = 1.53 W/kg

Zoom Scan (7x7x7)/Cube 0: Measurement grid: dx=5mm, dy=5mm, dz=5mm
Reference Value = 27.39 V/m; Power Drift = -0.03 dB
Peak SAR (extrapolated) = 2.57 W/kg
SAR(1 g) = 1.18 W/kg; SAR(10 g) = 0.490 W/kg
Maximum value of SAR (measured) = 2.06 W/kg

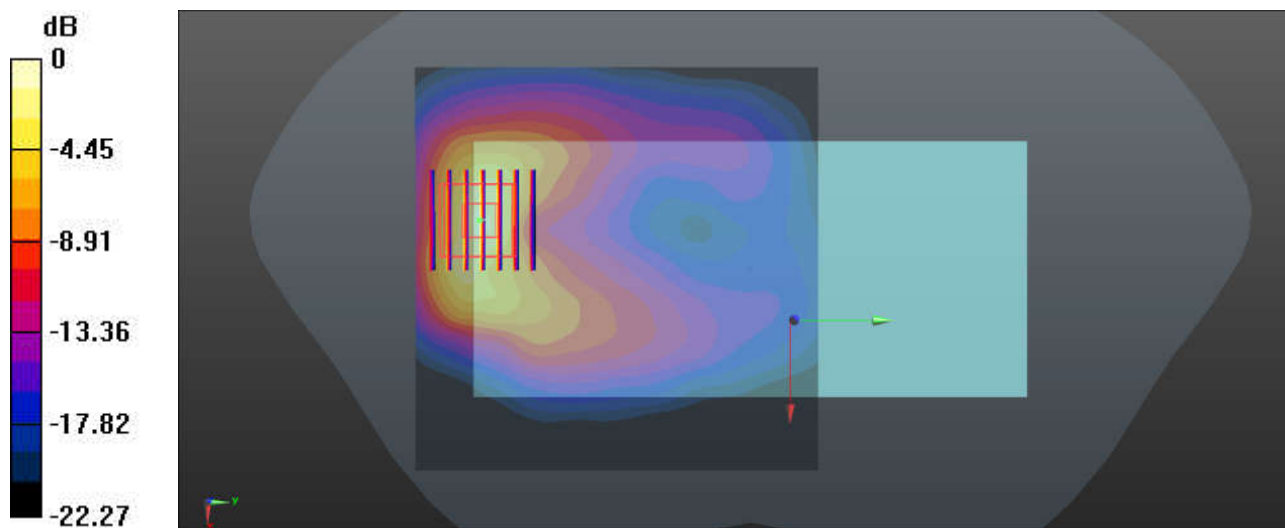

0 dB = 2.06 W/kg = 3.14 dBW/kg

27_LTE Band 26_15M_QPSK_1RB_0Offset_Back_5mm_Ch26865

Communication System: UID 0, LTE-FDD (0); Frequency: 831.5 MHz; Duty Cycle: 1:1
Medium: HSL_835 Medium parameters used: $f = 831.5$ MHz; $\sigma = 0.937$ S/m; $\epsilon_r = 42.457$; $\rho = 1000$ kg/m³
Ambient Temperature : 23.3 °C; Liquid Temperature : 22.6 °C

DASY5 Configuration:

- Probe: EX3DV4 - SN3857; ConvF(9.18, 9.18, 9.18); Calibrated: 2020.9.25
- Sensor-Surface: 1.4mm (Mechanical Surface Detection)
- Electronics: DAE4 Sn1338; Calibrated: 2020.11.27
- Phantom: SAM Twin Phantom; Type: SAM Twin; Serial: TP-1503
- Measurement SW: DASY52, Version 52.10 (4); SEMCAD X Version 14.6.14 (7483)

Area Scan (81x81x1): Interpolated grid: dx=1.500 mm, dy=1.500 mm
Maximum value of SAR (interpolated) = 1.03 W/kg

Zoom Scan (6x6x7)/Cube 0: Measurement grid: dx=8mm, dy=8mm, dz=5mm
Reference Value = 29.49 V/m; Power Drift = -0.13 dB
Peak SAR (extrapolated) = 1.17 W/kg
SAR(1 g) = 0.627 W/kg; SAR(10 g) = 0.365 W/kg
Maximum value of SAR (measured) = 0.946 W/kg

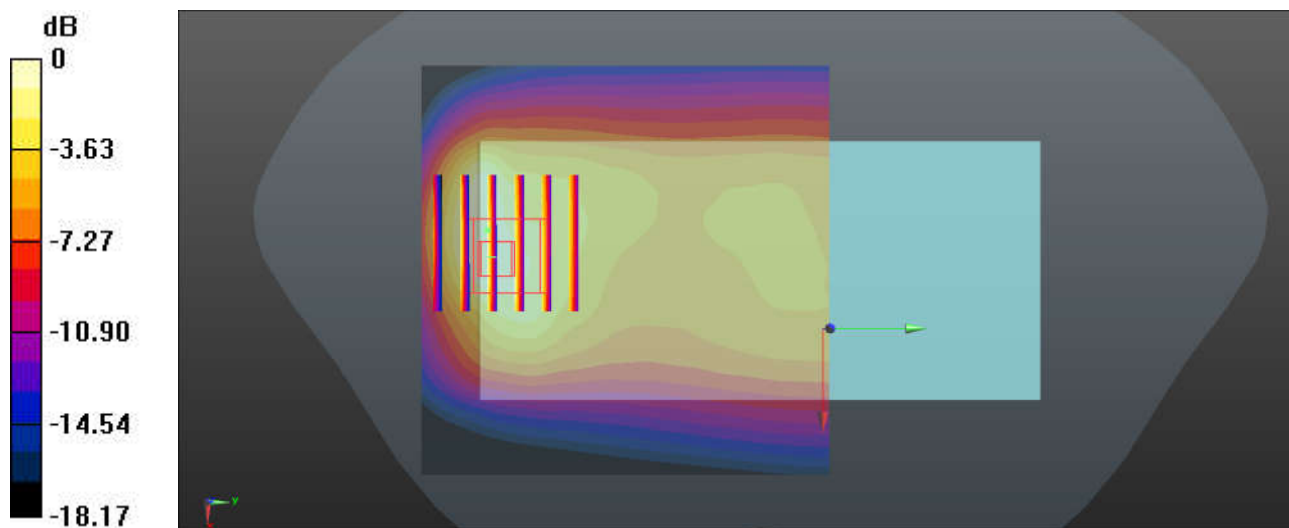

0 dB = 0.946 W/kg = -0.24 dBW/kg

28_LTE Band 41_20M_QPSK_1RB_0Offset_Back_5mm_Ch41490

Communication System: UID 0, LTE-TDD (0); Frequency: 2680 MHz; Duty Cycle: 1:1.59
Medium: HSL_2600 Medium parameters used: $f = 2680$ MHz; $\sigma = 2.078$ S/m; $\epsilon_r = 40.424$; $\rho = 1000$ kg/m³

Ambient Temperature : 23.1 °C; Liquid Temperature : 22.9 °C

DASY5 Configuration:

- Probe: EX3DV4 - SN3857; ConvF(7.19, 7.19, 7.19); Calibrated: 2020.9.25
- Sensor-Surface: 1.4mm (Mechanical Surface Detection)
- Electronics: DAE4 Sn1338; Calibrated: 2020.11.27
- Phantom: SAM Twin Phantom; Type: SAM Twin; Serial: TP-1503
- Measurement SW: DASY52, Version 52.10 (4); SEMCAD X Version 14.6.14 (7483)

Area Scan (101x101x1): Interpolated grid: dx=1.200 mm, dy=1.200 mm

Maximum value of SAR (interpolated) = 1.06 W/kg

Zoom Scan (7x7x7)/Cube 0: Measurement grid: dx=5mm, dy=5mm, dz=5mm

Reference Value = 21.30 V/m; Power Drift = 0.06 dB

Peak SAR (extrapolated) = 1.31 W/kg

SAR(1 g) = 0.612 W/kg; SAR(10 g) = 0.294 W/kg

Maximum value of SAR (measured) = 1.07 W/kg

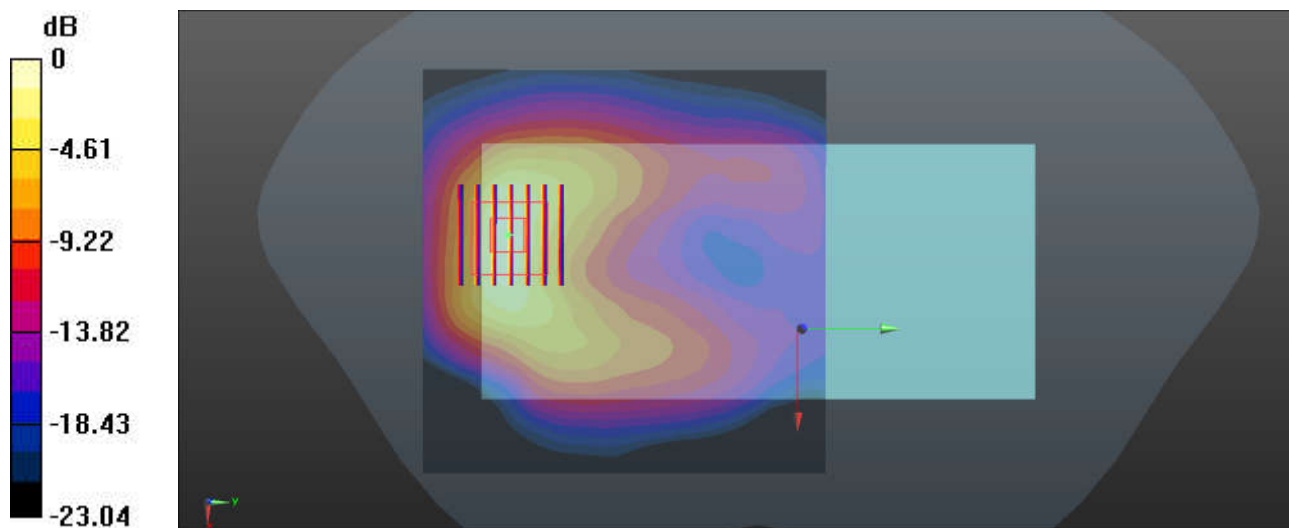

0 dB = 1.07 W/kg = 0.29 dBW/kg

29_WLAN2.4GHz_802.11b 1Mbps_Back_5mm_Ch1

Communication System: UID 0, 802.11g (0); Frequency: 2412 MHz; Duty Cycle: 1:1.017
Medium: HSL_2450 Medium parameters used: $f = 2412$ MHz; $\sigma = 1.818$ S/m; $\epsilon_r = 39.144$; $\rho = 1000$ kg/m³
Ambient Temperature : 23.3 °C; Liquid Temperature : 22.8 °C

- DASY5 Configuration:
- Probe: EX3DV4 - SN3857; ConvF(7.44, 7.44, 7.44); Calibrated: 2020.9.25
 - Sensor-Surface: 1.4mm (Mechanical Surface Detection)
 - Electronics: DAE4 Sn1338; Calibrated: 2020.11.27
 - Phantom: SAM Twin Phantom; Type: SAM Twin; Serial: TP-1503
 - Measurement SW: DASY52, Version 52.10 (4); SEMCAD X Version 14.6.14 (7483)

Area Scan (71x141x1): Interpolated grid: dx=1.200 mm, dy=1.200 mm
Maximum value of SAR (interpolated) = 0.442 W/kg

Zoom Scan (7x7x7)/Cube 0: Measurement grid: dx=5mm, dy=5mm, dz=5mm
Reference Value = 14.67 V/m; Power Drift = 0.01 dB
Peak SAR (extrapolated) = 0.792 W/kg
SAR(1 g) = 0.246 W/kg; SAR(10 g) = 0.146 W/kg
Maximum value of SAR (measured) = 0.508 W/kg

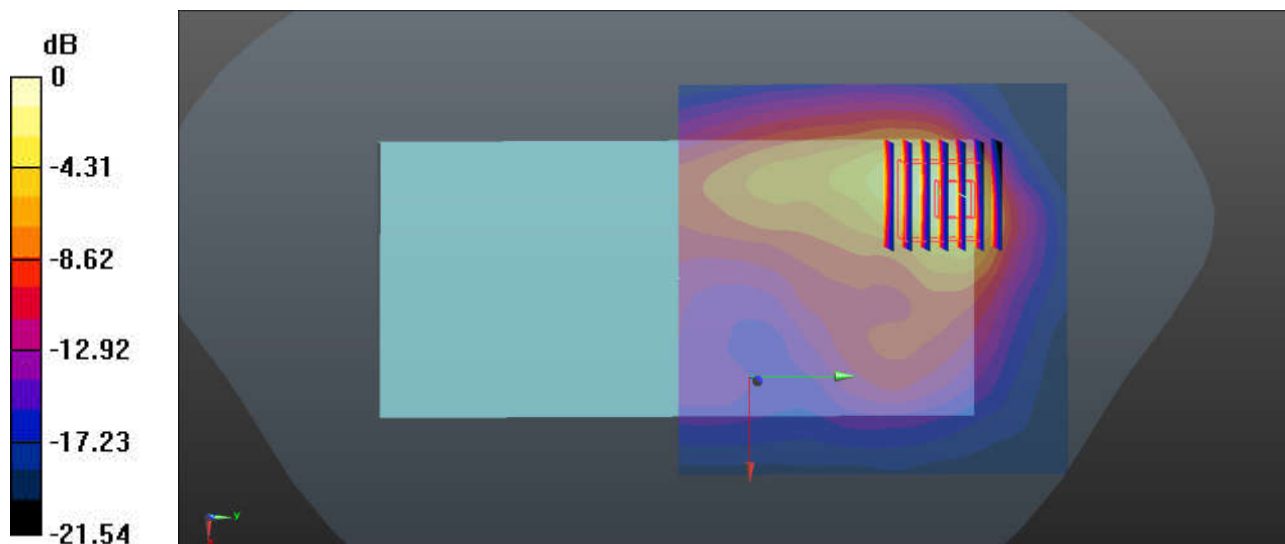

0 dB = 0.508 W/kg = -2.94 dBW/kg

30_Bluetooth_1Mbps_Back_5mm_Ch0

Communication System: UID 0, Bluetooth (0); Frequency: 2402 MHz; Duty Cycle: 1:1.287
Medium: HSL_2450 Medium parameters used: $f = 2402$ MHz; $\sigma = 1.735$ S/m; $\epsilon_r = 39.381$; $\rho = 1000$ kg/m³

Ambient Temperature : 23.3 °C; Liquid Temperature : 22.8 °C

DASY5 Configuration:

- Probe: EX3DV4 - SN3857; ConvF(7.44, 7.44, 7.44); Calibrated: 2020.9.25
- Sensor-Surface: 1.4mm (Mechanical Surface Detection)
- Electronics: DAE4 Sn1338; Calibrated: 2020.11.27
- Phantom: SAM Twin Phantom; Type: SAM Twin; Serial: TP-1503
- Measurement SW: DASY52, Version 52.10 (4); SEMCAD X Version 14.6.14 (7483)

Area Scan (91x91x1): Interpolated grid: dx=1.200 mm, dy=1.200 mm

Maximum value of SAR (interpolated) = 0.160 W/kg

Zoom Scan (7x8x7)/Cube 0: Measurement grid: dx=5mm, dy=5mm, dz=5mm

Reference Value = 8.752 V/m; Power Drift = 0.09 dB

Peak SAR (extrapolated) = 0.211 W/kg

SAR(1 g) = 0.053 W/kg; SAR(10 g) = 0.033 W/kg

Maximum value of SAR (measured) = 0.154 W/kg

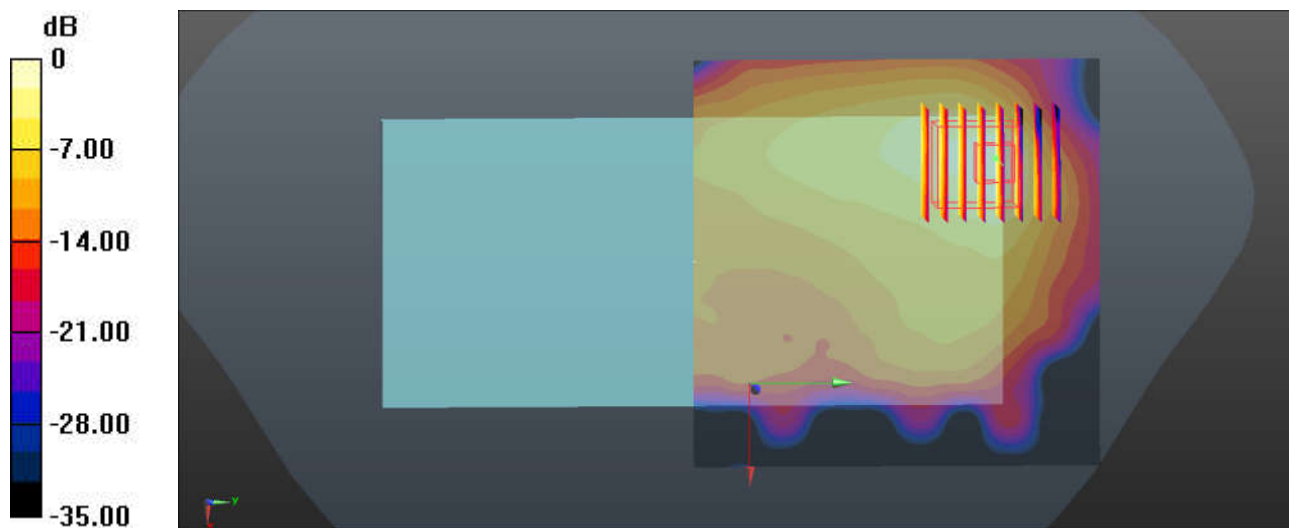

0 dB = 0.154 W/kg = -8.12 dBW/kg

31_GSM1900_GPRS (2 Tx slots)_Bottom Side_0mm_Ch661

Communication System: UID 0, PCS (0); Frequency: 1880 MHz; Duty Cycle: 1:4.15
Medium: HSL_1900 Medium parameters used: $f = 1880$ MHz; $\sigma = 1.424$ S/m; $\epsilon_r = 38.827$; $\rho = 1000$ kg/m³
Ambient Temperature : 23.2 °C; Liquid Temperature : 22.7 °C

DASY5 Configuration:

- Probe: EX3DV4 - SN3857; ConvF(7.81, 7.81, 7.81); Calibrated: 2020.9.25
- Sensor-Surface: 1.4mm (Mechanical Surface Detection)
- Electronics: DAE4 Sn1338; Calibrated: 2020.11.27
- Phantom: SAM Twin Phantom; Type: SAM Twin; Serial: TP-1503
- Measurement SW: DASY52, Version 52.10 (4); SEMCAD X Version 14.6.14 (7483)

Area Scan (41x81x1): Interpolated grid: dx=1.500 mm, dy=1.500 mm
Maximum value of SAR (interpolated) = 3.32 W/kg

Zoom Scan (5x5x7)/Cube 0: Measurement grid: dx=8mm, dy=8mm, dz=5mm
Reference Value = 48.02 V/m; Power Drift = -0.07 dB
Peak SAR (extrapolated) = 3.81 W/kg
SAR(1 g) = 1.73 W/kg; SAR(10 g) = 0.781 W/kg
Maximum value of SAR (measured) = 3.00 W/kg

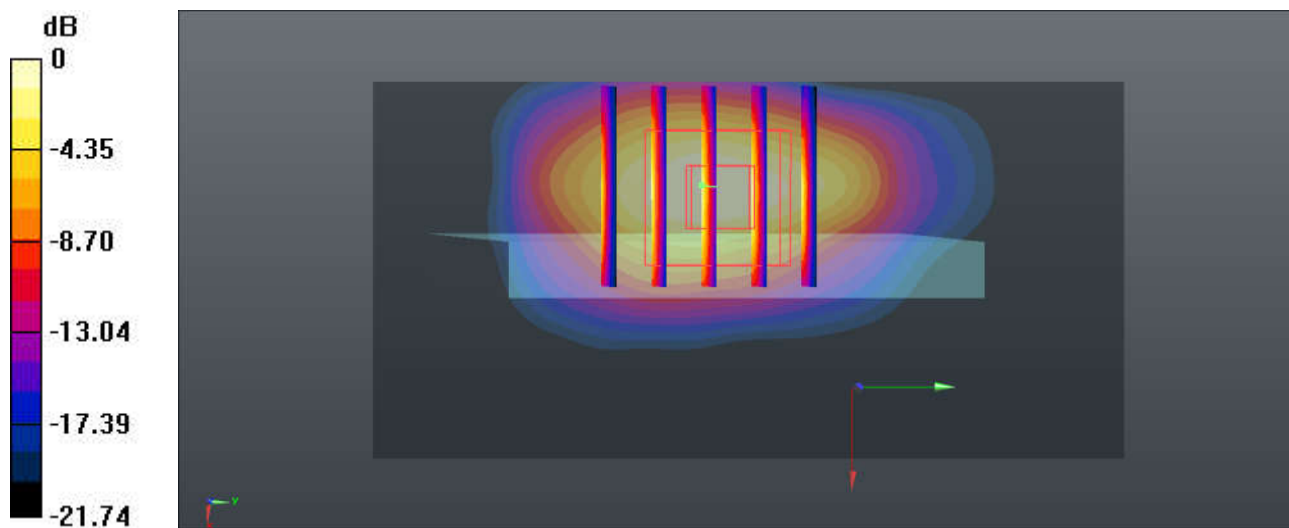

0 dB = 3.00 W/kg = 4.77 dBW/kg

32_WCDMA II_RMC 12.2Kbps_Bottom Side_0mm_Ch9400

Communication System: UID 0, WCDMA (0); Frequency: 1880 MHz; Duty Cycle: 1:1
Medium: HSL_1900 Medium parameters used: $f = 1880$ MHz; $\sigma = 1.424$ S/m; $\epsilon_r = 38.827$; $\rho = 1000$ kg/m³
Ambient Temperature : 23.2 °C; Liquid Temperature : 22.7 °C

DASY5 Configuration:

- Probe: EX3DV4 - SN3857; ConvF(7.81, 7.81, 7.81); Calibrated: 2020.9.25
- Sensor-Surface: 1.4mm (Mechanical Surface Detection)
- Electronics: DAE4 Sn1338; Calibrated: 2020.11.27
- Phantom: SAM Twin Phantom; Type: SAM Twin; Serial: TP-1503
- Measurement SW: DASY52, Version 52.10 (4); SEMCAD X Version 14.6.14 (7483)

Area Scan (41x81x1): Interpolated grid: dx=1.500 mm, dy=1.500 mm
Maximum value of SAR (interpolated) = 4.77 W/kg

Zoom Scan (5x5x7)/Cube 0: Measurement grid: dx=8mm, dy=8mm, dz=5mm
Reference Value = 55.40 V/m; Power Drift = 0.01 dB
Peak SAR (extrapolated) = 5.56 W/kg
SAR(1 g) = 2.38 W/kg; SAR(10 g) = 1.05 W/kg
Maximum value of SAR (measured) = 4.44 W/kg

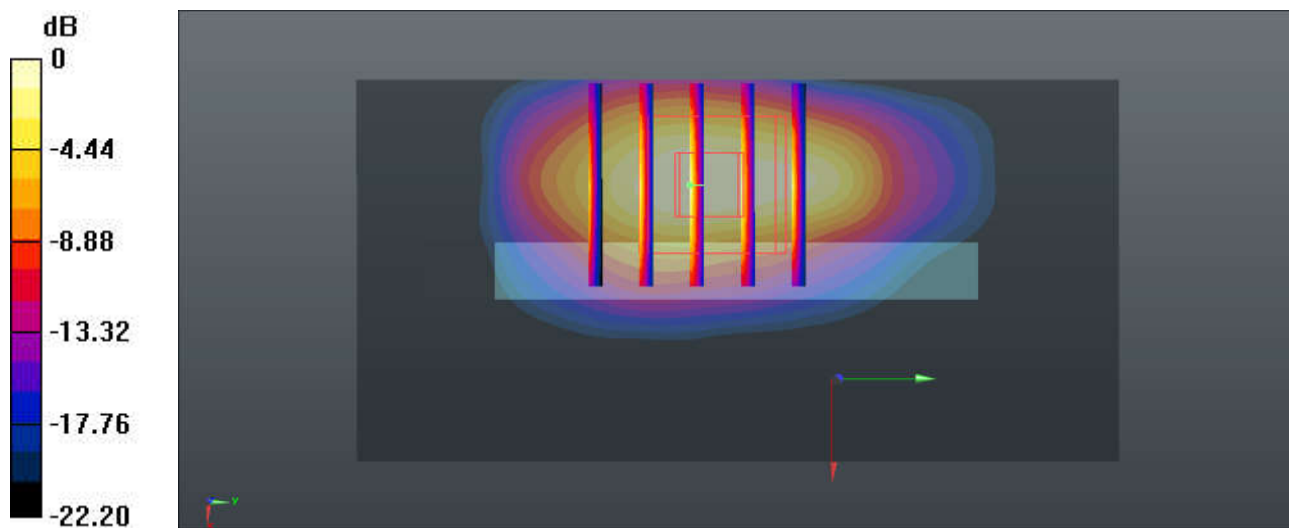

0 dB = 4.44 W/kg = 6.47 dBW/kg

33_LTE Band 2_20M_QPSK_1RB_0Offset_Bottom Side_0mm_Ch18900

Communication System: UID 0, LTE-FDD (0); Frequency: 1880 MHz; Duty Cycle: 1:1
Medium: HSL_1900 Medium parameters used: $f = 1880$ MHz; $\sigma = 1.424$ S/m; $\epsilon_r = 38.827$; $\rho = 1000$ kg/m³
Ambient Temperature : 23.2 °C; Liquid Temperature : 22.7 °C

DASY5 Configuration:

- Probe: EX3DV4 - SN3857; ConvF(7.81, 7.81, 7.81); Calibrated: 2020.9.25
- Sensor-Surface: 1.4mm (Mechanical Surface Detection)
- Electronics: DAE4 Sn1338; Calibrated: 2020.11.27
- Phantom: SAM Twin Phantom; Type: SAM Twin; Serial: TP-1503
- Measurement SW: DASY52, Version 52.10 (4); SEMCAD X Version 14.6.14 (7483)

Area Scan (51x101x1): Interpolated grid: dx=1.200 mm, dy=1.200 mm
Maximum value of SAR (interpolated) = 5.48 W/kg

Zoom Scan (5x5x7)/Cube 0: Measurement grid: dx=8mm, dy=8mm, dz=5mm
Reference Value = 61.09 V/m; Power Drift = -0.12 dB
Peak SAR (extrapolated) = 8.51 W/kg
SAR(1 g) = 3.89 W/kg; SAR(10 g) = 1.74 W/kg
Maximum value of SAR (measured) = 5.32 W/kg

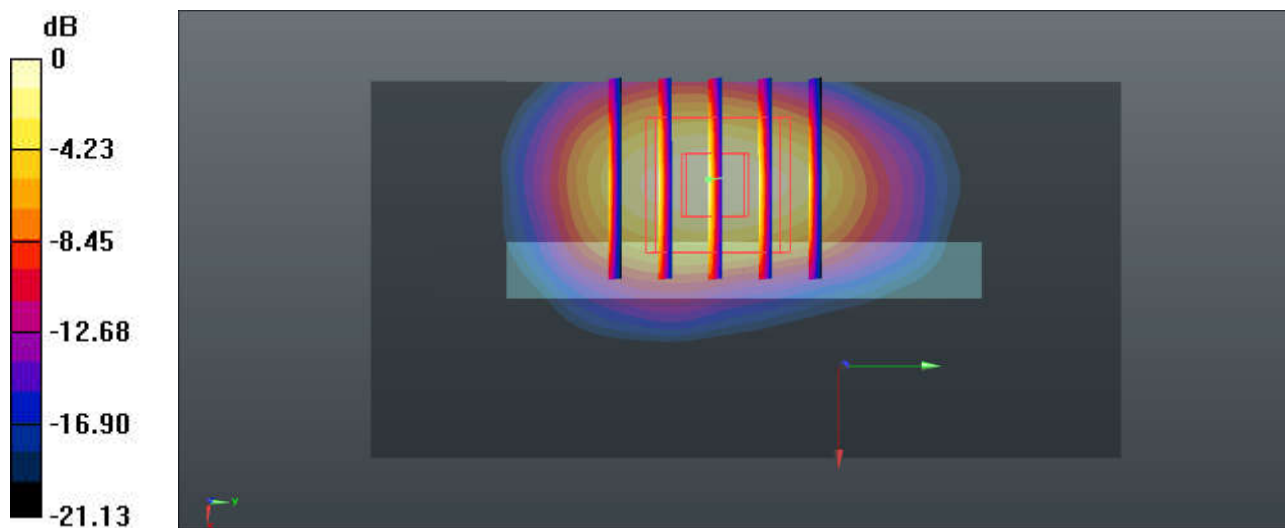

0 dB = 5.32 W/kg = 7.26 dBW/kg

34_LTE Band 7_20M_QPSK_1RB_0Offset_Back_0mm_Ch21100

Communication System: UID 0, LTE-FDD (0); Frequency: 2535 MHz; Duty Cycle: 1:1
Medium: HSL_2600 Medium parameters used: $f = 2535$ MHz; $\sigma = 1.961$ S/m; $\epsilon_r = 40.668$; $\rho = 1000$ kg/m³
Ambient Temperature : 23.1 °C; Liquid Temperature : 22.9 °C

DASY5 Configuration:

- Probe: EX3DV4 - SN3857; ConvF(7.19, 7.19, 7.19); Calibrated: 2020.9.25
- Sensor-Surface: 1.4mm (Mechanical Surface Detection)
- Electronics: DAE4 Sn1338; Calibrated: 2020.11.27
- Phantom: SAM Twin Phantom; Type: SAM Twin; Serial: TP-1503
- Measurement SW: DASY52, Version 52.10 (4); SEMCAD X Version 14.6.14 (7483)

Area Scan (101x101x1): Interpolated grid: dx=1.200 mm, dy=1.200 mm
Maximum value of SAR (interpolated) = 4.80 W/kg

Zoom Scan (9x7x7)/Cube 0: Measurement grid: dx=5mm, dy=5mm, dz=5mm
Reference Value = 51.28 V/m; Power Drift = 0.02 dB
Peak SAR (extrapolated) = 11.2 W/kg
SAR(1 g) = 3.84 W/kg; SAR(10 g) = 1.4 W/kg
Maximum value of SAR (measured) = 7.96 W/kg

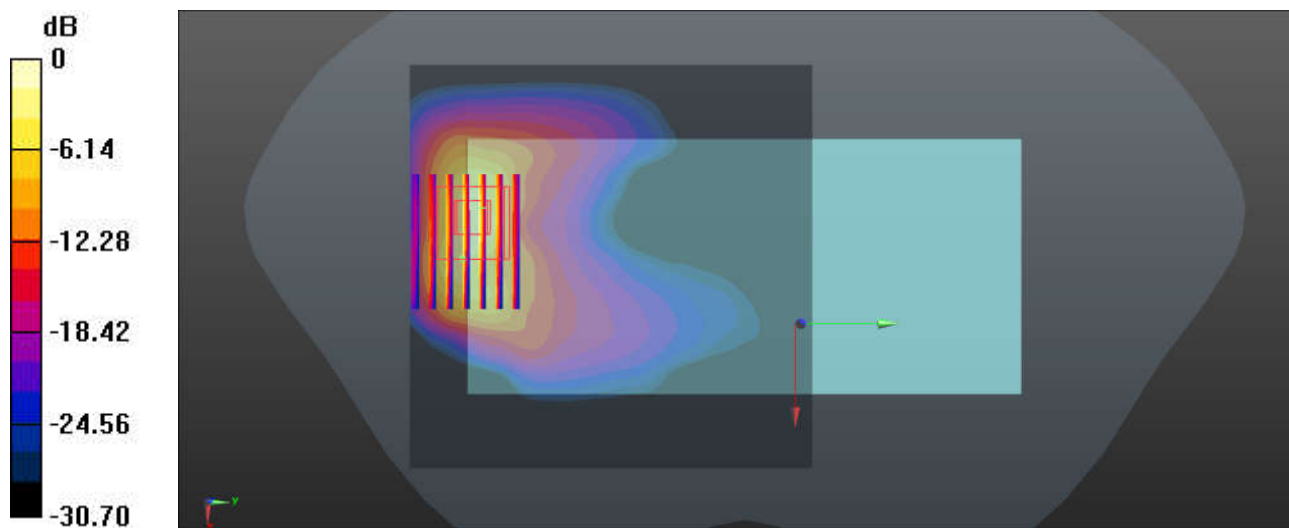

0 dB = 7.96 W/kg = 9.01 dBW/kg



Appendix C. DASYS Calibration Certificate

The DASYS calibration certificates are shown as follows.



Accredited by the Swiss Accreditation Service (SAS)
The Swiss Accreditation Service is one of the signatories to the EA
Multilateral Agreement for the recognition of calibration certificates

Accreditation No.: **SCS 0108**

Client **Sporton**

Certificate No: **D835V2-4d258_May20**

CALIBRATION CERTIFICATE

Object **D835V2 - SN:4d258**

Calibration procedure(s) **QA CAL-05.v11
Calibration Procedure for SAR Validation Sources between 0.7-3 GHz**

Calibration date: **May 07, 2020**

This calibration certificate documents the traceability to national standards, which realize the physical units of measurements (SI).
The measurements and the uncertainties with confidence probability are given on the following pages and are part of the certificate.

All calibrations have been conducted in the closed laboratory facility: environment temperature (22 ± 3)°C and humidity < 70%.

Calibration Equipment used (M&TE critical for calibration)

Primary Standards	ID #	Cal Date (Certificate No.)	Scheduled Calibration
Power meter NRP	SN: 104778	01-Apr-20 (No. 217-03100/03101)	Apr-21
Power sensor NRP-Z91	SN: 103244	01-Apr-20 (No. 217-03100)	Apr-21
Power sensor NRP-Z91	SN: 103245	01-Apr-20 (No. 217-03101)	Apr-21
Reference 20 dB Attenuator	SN: BH9394 (20k)	31-Mar-20 (No. 217-03106)	Apr-21
Type-N mismatch combination	SN: 310982 / 06327	31-Mar-20 (No. 217-03104)	Apr-21
Reference Probe EX3DV4	SN: 7349	31-Dec-19 (No. EX3-7349_Dec19)	Dec-20
DAE4	SN: 601	27-Dec-19 (No. DAE4-601_Dec19)	Dec-20

Secondary Standards	ID #	Check Date (in house)	Scheduled Check
Power meter E4419B	SN: GB39512475	30-Oct-14 (in house check Feb-19)	In house check: Oct-20
Power sensor HP 8481A	SN: US37292783	07-Oct-15 (in house check Oct-18)	In house check: Oct-20
Power sensor HP 8481A	SN: MY41092317	07-Oct-15 (in house check Oct-18)	In house check: Oct-20
RF generator R&S SMT-06	SN: 100972	15-Jun-15 (in house check Oct-18)	In house check: Oct-20
Network Analyzer Agilent E8358A	SN: US41080477	31-Mar-14 (in house check Oct-19)	In house check: Oct-20

Calibrated by:	Name Jeffrey Katzman	Function Laboratory Technician	Signature
Approved by:	Name Katja Pokovic	Function Technical Manager	Signature

Issued: May 7, 2020

This calibration certificate shall not be reproduced except in full without written approval of the laboratory.



Accredited by the Swiss Accreditation Service (SAS)

The Swiss Accreditation Service is one of the signatories to the EA Multilateral Agreement for the recognition of calibration certificates

Accreditation No.: **SCS 0108**

Glossary:

TSL	tissue simulating liquid
ConvF	sensitivity in TSL / NORM x,y,z
N/A	not applicable or not measured

Calibration is Performed According to the Following Standards:

- IEEE Std 1528-2013, "IEEE Recommended Practice for Determining the Peak Spatial-Averaged Specific Absorption Rate (SAR) in the Human Head from Wireless Communications Devices: Measurement Techniques", June 2013
- IEC 62209-1, "Measurement procedure for the assessment of Specific Absorption Rate (SAR) from hand-held and body-mounted devices used next to the ear (frequency range of 300 MHz to 6 GHz)", July 2016
- IEC 62209-2, "Procedure to determine the Specific Absorption Rate (SAR) for wireless communication devices used in close proximity to the human body (frequency range of 30 MHz to 6 GHz)", March 2010
- KDB 865664, "SAR Measurement Requirements for 100 MHz to 6 GHz"

Additional Documentation:

- DASY4/5 System Handbook

Methods Applied and Interpretation of Parameters:

- Measurement Conditions:** Further details are available from the Validation Report at the end of the certificate. All figures stated in the certificate are valid at the frequency indicated.
- Antenna Parameters with TSL:** The dipole is mounted with the spacer to position its feed point exactly below the center marking of the flat phantom section, with the arms oriented parallel to the body axis.
- Feed Point Impedance and Return Loss:** These parameters are measured with the dipole positioned under the liquid filled phantom. The impedance stated is transformed from the measurement at the SMA connector to the feed point. The Return Loss ensures low reflected power. No uncertainty required.
- Electrical Delay:** One-way delay between the SMA connector and the antenna feed point. No uncertainty required.
- SAR measured:** SAR measured at the stated antenna input power.
- SAR normalized:** SAR as measured, normalized to an input power of 1 W at the antenna connector.
- SAR for nominal TSL parameters:** The measured TSL parameters are used to calculate the nominal SAR result.

The reported uncertainty of measurement is stated as the standard uncertainty of measurement multiplied by the coverage factor $k=2$, which for a normal distribution corresponds to a coverage probability of approximately 95%.

Measurement Conditions

DASY system configuration, as far as not given on page 1.

DASY Version	DASY5	V52.10.4
Extrapolation	Advanced Extrapolation	
Phantom	Modular Flat Phantom	
Distance Dipole Center - TSL	15 mm	with Spacer
Zoom Scan Resolution	dx, dy, dz = 5 mm	
Frequency	835 MHz \pm 1 MHz	

Head TSL parameters

The following parameters and calculations were applied.

	Temperature	Permittivity	Conductivity
Nominal Head TSL parameters	22.0 °C	41.5	0.90 mho/m
Measured Head TSL parameters	(22.0 \pm 0.2) °C	42.2 \pm 6 %	0.92 mho/m \pm 6 %
Head TSL temperature change during test	< 0.5 °C	----	----

SAR result with Head TSL

SAR averaged over 1 cm ³ (1 g) of Head TSL	Condition	
SAR measured	250 mW input power	2.39 W/kg
SAR for nominal Head TSL parameters	normalized to 1W	9.44 W/kg \pm 17.0 % (k=2)

SAR averaged over 10 cm ³ (10 g) of Head TSL	condition	
SAR measured	250 mW input power	1.55 W/kg
SAR for nominal Head TSL parameters	normalized to 1W	6.13 W/kg \pm 16.5 % (k=2)

Appendix (Additional assessments outside the scope of SCS 0108)

Antenna Parameters with Head TSL

Impedance, transformed to feed point	51.0 Ω - 2.5 j Ω
Return Loss	- 31.5 dB

General Antenna Parameters and Design

Electrical Delay (one direction)	1.387 ns
----------------------------------	----------

After long term use with 100W radiated power, only a slight warming of the dipole near the feedpoint can be measured.

The dipole is made of standard semirigid coaxial cable. The center conductor of the feeding line is directly connected to the second arm of the dipole. The antenna is therefore short-circuited for DC-signals. On some of the dipoles, small end caps are added to the dipole arms in order to improve matching when loaded according to the position as explained in the "Measurement Conditions" paragraph. The SAR data are not affected by this change. The overall dipole length is still according to the Standard.

No excessive force must be applied to the dipole arms, because they might bend or the soldered connections near the feedpoint may be damaged.

Additional EUT Data

Manufactured by	SPEAG
-----------------	-------

DASY5 Validation Report for Head TSL

Date: 07.05.2020

Test Laboratory: SPEAG, Zurich, Switzerland

DUT: Dipole 835 MHz; Type: D835V2; Serial: D835V2 - SN:4d258

Communication System: UID 0 - CW; Frequency: 835 MHz

Medium parameters used: $f = 835$ MHz; $\sigma = 0.92$ S/m; $\epsilon_r = 42.2$; $\rho = 1000$ kg/m³

Phantom section: Flat Section

Measurement Standard: DASY5 (IEEE/IEC/ANSI C63.19-2011)

DASY52 Configuration:

- Probe: EX3DV4 - SN7349; ConvF(9.89, 9.89, 9.89) @ 835 MHz; Calibrated: 31.12.2019
- Sensor-Surface: 1.4mm (Mechanical Surface Detection)
- Electronics: DAE4 Sn601; Calibrated: 27.12.2019
- Phantom: Flat Phantom 4.9 (front); Type: QD 00L P49 AA; Serial: 1001
- DASY52 52.10.4(1527); SEMCAD X 14.6.14(7483)

Dipole Calibration for Head Tissue/Pin=250 mW, d=15mm/Zoom Scan (7x7x7)/Cube 0:

Measurement grid: dx=5mm, dy=5mm, dz=5mm

Reference Value = 62.60 V/m; Power Drift = 0.04 dB

Peak SAR (extrapolated) = 3.55 W/kg

SAR(1 g) = 2.39 W/kg; SAR(10 g) = 1.55 W/kg

Smallest distance from peaks to all points 3 dB below = 16 mm

Ratio of SAR at M2 to SAR at M1 = 67%

Maximum value of SAR (measured) = 3.16 W/kg

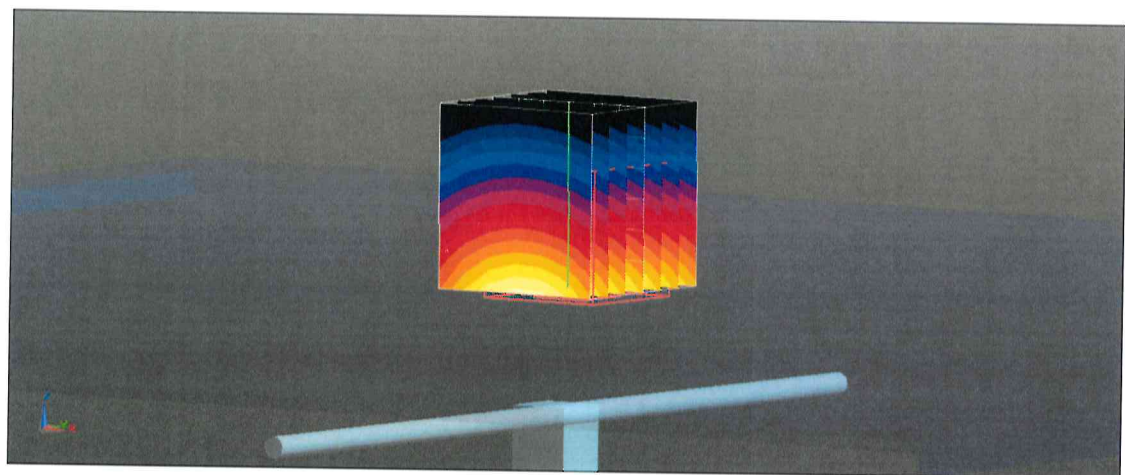
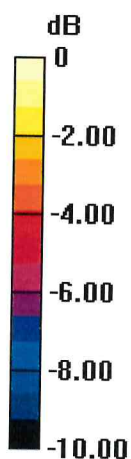

0 dB = 3.16 W/kg = 5.00 dBW/kg

Impedance Measurement Plot for Head TSL

