

# FCC SAR Test Report

APPLICANT : Motorola Mobility LLC  
EQUIPMENT : Mobile Cellular Phone  
BRAND NAME : Motorola  
MODEL NAME : XT2167-1  
FCC ID : IHDT56ZV5  
STANDARD : FCC 47 CFR Part 2 (2.1093)

We, Sporton International (Kunshan) Inc., would like to declare that the tested sample has been evaluated in accordance with the test procedures given in 47 CFR Part 2.1093 and FCC KDB and has been in compliance with the applicable technical standards.

The test results in this report apply exclusively to the tested model / sample. Without written approval of Sporton International (Kunshan) Inc., the test report shall not be reproduced except in full.



Reviewed by: Nick Hu / Supervisor

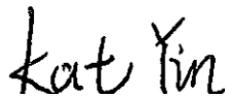

Approved by: Kat Yin / Manager



**Sporton International (Kunshan) Inc.**

No. 1098, Pengxi North Road, Kunshan Economic Development Zone Jiangsu Province 215300  
People's Republic of China



Table of Contents

1. Statement of Compliance ..... 4
2. Administration Data ..... 5
3. Guidance Applied ..... 5
4. Equipment Under Test (EUT) Information ..... 6
4.1 General Information ..... 6
4.2 General LTE SAR Test and Reporting Considerations ..... 8
5. Proximity Sensor Triggering Test ..... 10
6. RF Exposure Limits ..... 12
6.1 Uncontrolled Environment ..... 12
6.2 Controlled Environment ..... 12
7. Specific Absorption Rate (SAR) ..... 13
7.1 Introduction ..... 13
7.2 SAR Definition ..... 13
8. System Description and Setup ..... 14
8.1 E-Field Probe ..... 15
8.2 Data Acquisition Electronics (DAE) ..... 15
8.3 Phantom ..... 16
8.4 Device Holder ..... 17
9. Measurement Procedures ..... 18
9.1 Spatial Peak SAR Evaluation ..... 18
9.2 Power Reference Measurement ..... 19
9.3 Area Scan ..... 19
9.4 Zoom Scan ..... 20
9.5 Volume Scan Procedures ..... 20
9.6 Power Drift Monitoring ..... 20
10. Test Equipment List ..... 21
11. System Verification ..... 22
11.1 Tissue Simulating Liquids ..... 22
11.2 Tissue Verification ..... 23
11.3 System Performance Check Results ..... 24
12. RF Exposure Positions ..... 25
12.1 Ear and handset reference point ..... 25
12.2 Definition of the cheek position ..... 26
12.3 Definition of the tilt position ..... 27
12.4 Body Worn Accessory ..... 28
12.5 Product Specific 10g SAR Exposure ..... 29
12.6 Wireless Router ..... 29
13. Conducted RF Output Power (Unit: dBm) ..... 30
14. Antenna Location ..... 41
15. SAR Test Results ..... 42
15.1 Head SAR ..... 45
15.2 Hotspot SAR ..... 48
15.3 Body Worn Accessory SAR ..... 53
15.4 Product specific 10g SAR ..... 57
15.5 Repeated SAR Measurement ..... 60
16. Simultaneous Transmission Analysis ..... 61
16.1 Head Exposure Conditions ..... 62
16.2 Hotspot Exposure Conditions ..... 63
16.3 Body-Worn Accessory Exposure Conditions ..... 65
16.4 Product Specific 10g SAR Exposure Conditions ..... 66
16.5 SPLSR Evaluation and Analysis ..... 68
17. Uncertainty Assessment ..... 72
18. References ..... 73
Appendix A. Plots of System Performance Check
Appendix B. Plots of High SAR Measurement
Appendix C. DASYS Calibration Certificate
Appendix D. Test Setup Photos
Appendix E. Conducted RF Output Power Table





### 1. Statement of Compliance

The maximum results of Specific Absorption Rate (SAR) found during testing for **Motorola Mobility LLC, Mobile Cellular Phone, XT2167-1**, are as follows.

Highest 1g SAR Summary						
Equipment Class	Frequency Band		Head (Separation 0mm)	Hotspot (Separation 5mm)	Body-worn (Separation 5mm)	Highest Simultaneous Transmission 1g SAR (W/kg)
			1g SAR (W/kg)			
Licensed	GSM	GSM850	0.44	1.10	1.10	1.58
		GSM1900	0.10	1.39	1.39	
	WCDMA	Band II	0.14	1.33	1.33	
		Band IV	0.33	<b>1.44</b>	<b>1.44</b>	
		Band V	0.51	1.18	1.18	
	LTE	Band 2	0.16	1.42	1.42	
		Band 7	0.82	1.40	1.40	
		Band 12	0.51	0.63	0.63	
		Band 13	0.39	0.61	0.61	
		Band 26/ Band 5	0.49	0.97	0.97	
		Band 66/ Band 4	0.33	1.40	1.41	
DTS	WLAN	2.4GHz WLAN	0.81	0.66	0.66	1.55
NII		5GHz WLAN	<b>1.15</b>	1.14	1.16	1.58
DSS	Bluetooth	2.4GHz Bluetooth	0.15	0.11	0.11	1.55
Highest 10g SAR Summary						
Equipment Class	Frequency Band		Product Specific 10g SAR (W/kg) (Separation 0mm)		Highest Simultaneous Transmission 10g SAR (W/kg)	
License	GSM	GSM1900	2.93		3.61	
	WCDMA	Band II	3.35			
		Band IV	<b>3.56</b>			
	LTE	Band 2	3.41			
		Band 7	2.99			
	Band 66/ Band 4	3.22				
NII	WLAN	5GHz WLAN	1.94		3.61	
Date of Testing:			2021/8/3 ~ 2021/8/20			
<b>Remark:</b> This device supports both LTE B4/B5 and B66/B26. Since the supported frequency span for LTE B4/B5 falls completely within the supports frequency span for LTE B66/B26, both LTE bands have the same target power, and both LTE bands share the same transmission path; therefore, SAR was only assessed for LTE B66/B26.						

<b>Declaration of Conformity:</b>
The test results with all measurement uncertainty excluded are presented in accordance with the regulation limits or requirements declared by manufacturers.
<b>Comments and Explanations:</b>
The declared of product specification for EUT presented in the report are provided by the manufacturer, and the manufacturer takes all the responsibilities for the accuracy of product specification.

This device is in compliance with Specific Absorption Rate (SAR) for general population/uncontrolled exposure limits (1.6 W/kg for Partial-Body 1g SAR, 4.0 W/kg for Product Specific 10g SAR) specified in FCC 47 CFR part 2 (2.1093) and ANSI/IEEE C95.1-1992, and had been tested in accordance with the measurement methods and procedures specified in IEEE 1528-2013 and FCC KDB publications.



### 2. Administration Data

Sporton International (Kunshan) Inc. is accredited to ISO/IEC 17025:2017 by American Association for Laboratory Accreditation with Certificate Number 5145.02.

Testing Laboratory			
Test Firm	Sporton International (Kunshan) Inc.		
Test Site Location	No. 1098, Pengxi North Road, Kunshan Economic Development Zone Jiangsu Province 215300 People's Republic of China TEL : +86-512-57900158 FAX : +86-512-57900958		
Test Site No.	Sporton Site No.	FCC Designation No.	FCC Test Firm Registration No.
	SAR07-KS	CN1257	314309

Applicant	
Company Name	Motorola Mobility LLC
Address	222 W,Merchandise Mart Plaza, Chicago IL 60654 USA

Manufacturer	
Company Name	Motorola Mobility LLC
Address	222 W,Merchandise Mart Plaza, Chicago IL 60654 USA

### 3. Guidance Applied

The Specific Absorption Rate (SAR) testing specification, method, and procedure for this device is in accordance with the following standards:

- FCC 47 CFR Part 2 (2.1093)
- ANSI/IEEE C95.1-1992
- IEEE 1528-2013
- FCC KDB 865664 D01 SAR Measurement 100 MHz to 6 GHz v01r04
- FCC KDB 865664 D02 SAR Reporting v01r02
- FCC KDB 447498 D01 General RF Exposure Guidance v06
- FCC KDB 648474 D04 SAR Evaluation Considerations for Wireless Handsets v01r03
- FCC KDB 248227 D01 802.11 Wi-Fi SAR v02r02
- FCC KDB 616217 D04 SAR for laptop and tablets v01r02
- FCC KDB 941225 D01 3G SAR Procedures v03r01
- FCC KDB 941225 D05 SAR for LTE Devices v02r05
- FCC KDB 941225 D05A Rel.10 LTE SAR Test Guidance v01r02
- FCC KDB 941225 D06 Hotspot Mode SAR v02r01



## 4. Equipment Under Test (EUT) Information

### 4.1 General Information

Product Feature & Specification	
Equipment Name	Mobile Cellular Phone
Brand Name	Motorola
Model Name	XT2167-1
FCC ID	IHDT56ZV5
IMEI Code	Sample 1: SIM 1: 350077380011415 SIM 2: 350077380011423 Sample 2: SIM 1: 350077380023014 SIM 2: 350077380023022
Wireless Technology and Frequency Range	GSM850: 824 MHz ~ 849 MHz GSM1900: 1850 MHz ~ 1910 MHz WCDMA Band II: 1850 MHz ~ 1910 MHz WCDMA Band IV: 1710 MHz ~ 1755 MHz WCDMA Band V: 824 MHz ~ 849 MHz LTE Band 2: 1850 MHz ~ 1910 MHz LTE Band 4: 1710 MHz ~ 1755 MHz LTE Band 5: 824 MHz ~ 849 MHz LTE Band 7: 2500 MHz ~ 2570 MHz LTE Band 12: 699 MHz ~ 716 MHz LTE Band 13: 777 MHz ~ 787 MHz LTE Band 26: 814 MHz ~ 849 MHz LTE Band 66: 1710 MHz ~ 1780 MHz WLAN 2.4GHz Band: 2412 MHz ~ 2462 MHz WLAN 5.2GHz Band: 5180 MHz ~ 5240 MHz WLAN 5.3GHz Band: 5260 MHz ~ 5320 MHz WLAN 5.5GHz Band: 5500 MHz ~ 5720 MHz WLAN 5.8GHz Band: 5745 MHz ~ 5825 MHz Bluetooth: 2402 MHz ~ 2480 MHz NFC : 13.56 MHz
Mode	GSM/GPRS/EGPRS RMC/AMR 12.2Kbps HSDPA/HSUPA DC-HSDPA HSPA+ (16QAM uplink is supported) LTE: QPSK, 16QAM, 64QAM WLAN 2.4GHz 802.11b/g/n HT20 WLAN 5GHz 802.11a/n HT20/HT40 WLAN 5GHz 802.11ac VHT20/VHT40/VHT80 Bluetooth BR/EDR/LE NFC:ASK
HW Version	DVT2
SW Version	RRW31.Q3-26
GSM / (E)GPRS Transfer mode	Class B – EUT cannot support Packet Switched and Circuit Switched Network simultaneously but can automatically switch between Packet and Circuit Switched Network.
EUT Stage	Identical Prototype
Remark:	<ol style="list-style-type: none"> <li>802.11n-HT40 is not supported in 2.4GHz WLAN.</li> <li>This device supports VoIP in GPRS, EGPRS, WCDMA and LTE (e.g. for 3rd-party VoIP), LTE supports VoLTE operation.</li> <li>This device 2.4GHz WLAN support hotspot operation and Bluetooth support tethering applications.</li> <li>This device 5.2GHz WLAN/5.8GHz WLAN support hotspot operation, and 5.2GHz WLAN/5.8GHz WLAN supports WiFi Direct (GC/GO), and 5.3GHz / 5.5GHz supports WiFi Direct (GC only).</li> <li>This device does not support DTM operation and supports GPRS/EGPRS mode up to multi-slot class 12.</li> <li>The device implements the power management and proximity sensor detection/hotspot mode for SAR compliance at</li> </ol>



- different exposure conditions (body-worn, hotspot, extremity) and the details about the power management decision and sensor detection are provided in the operational description. And the device will invoke corresponding work scenarios power level base on frequency bands/antennas, which can refer to power table at appendix E.
7. For some WWAN bands, sensor on reduced power level is higher than hotspot reduced power level, so front/back sensor on SAR can represent hotspot conservatively.
  8. There are two different types of EUT. They are single SIM card mobile and dual SIM card mobile. The others are the same including circuit design, PCB board, structure and all components. It is special to declare. For dual SIM card mobile has two SIM slots and supports dual SIM dual standby. The WWAN radio transmission will be enabled by either one SIM at a time (single active).
  9. There are four samples. Please refer to the XT2167-1\_Operational Description of Product Equality Declaration exhibit submitted. According to the difference, we chose sample 1 to perform full SAR testing and sample 2 verified the worst case of sample 1. For sample 3/4, the differences do not affect the test, so sample 3/4 are not tested.
  10. There are four headsets, only supplier different, we chose headset 1/2/3/4 to perform full SAR testing.



4.2 General LTE SAR Test and Reporting Considerations

Summarized necessary items addressed in KDB 941225 D05 v02r05																																																															
FCC ID	IHDT56ZV5																																																														
Equipment Name	Mobile Cellular Phone																																																														
Operating Frequency Range of each LTE transmission band	LTE Band 2: 1850 MHz ~ 1910 MHz LTE Band 4: 1710 MHz ~ 1755 MHz LTE Band 5: 824 MHz ~ 849 MHz LTE Band 7: 2500 MHz ~ 2570 MHz LTE Band 12: 699 MHz ~ 716 MHz LTE Band 13: 777 MHz ~ 787 MHz LTE Band 26: 814 MHz ~ 849 MHz LTE Band 66: 1710 MHz ~ 1780 MHz																																																														
Channel Bandwidth	LTE Band 2: 1.4MHz, 3MHz, 5MHz, 10MHz, 15MHz, 20MHz LTE Band 4: 1.4MHz, 3MHz, 5MHz, 10MHz, 15MHz, 20MHz LTE Band 5: 1.4MHz, 3MHz, 5MHz, 10MHz LTE Band 7: 5MHz, 10MHz, 15MHz, 20MHz LTE Band 12: 1.4MHz, 3MHz, 5MHz, 10MHz LTE Band 13: 5MHz, 10MHz LTE Band 26: 1.4MHz, 3MHz, 5MHz, 10MHz, 15MHz LTE Band 66: 1.4MHz, 3MHz, 5MHz, 10MHz, 15MHz, 20MHz																																																														
uplink modulations used	QPSK / 16QAM / 64QAM																																																														
LTE Voice / Data requirements	Voice and Data																																																														
LTE Release Version	R11, Cat6																																																														
CA Support	Yes, Downlink only																																																														
LTE MPR permanently built-in by design	<p><b>Table 6.2.3-1: Maximum Power Reduction (MPR) for Power Class 1, 2 and 3</b></p> <table border="1"> <thead> <tr> <th rowspan="2">Modulation</th> <th colspan="6">Channel bandwidth / Transmission bandwidth (N<sub>RB</sub>)</th> <th rowspan="2">MPR (dB)</th> </tr> <tr> <th>1.4 MHz</th> <th>3.0 MHz</th> <th>5 MHz</th> <th>10 MHz</th> <th>15 MHz</th> <th>20 MHz</th> </tr> </thead> <tbody> <tr> <td>QPSK</td> <td>&gt; 5</td> <td>&gt; 4</td> <td>&gt; 8</td> <td>&gt; 12</td> <td>&gt; 16</td> <td>&gt; 18</td> <td>≤ 1</td> </tr> <tr> <td>16 QAM</td> <td>≤ 5</td> <td>≤ 4</td> <td>≤ 8</td> <td>≤ 12</td> <td>≤ 16</td> <td>≤ 18</td> <td>≤ 1</td> </tr> <tr> <td>16 QAM</td> <td>&gt; 5</td> <td>&gt; 4</td> <td>&gt; 8</td> <td>&gt; 12</td> <td>&gt; 16</td> <td>&gt; 18</td> <td>≤ 2</td> </tr> <tr> <td>64 QAM</td> <td>≤ 5</td> <td>≤ 4</td> <td>≤ 8</td> <td>≤ 12</td> <td>≤ 16</td> <td>≤ 18</td> <td>≤ 2</td> </tr> <tr> <td>64 QAM</td> <td>&gt; 5</td> <td>&gt; 4</td> <td>&gt; 8</td> <td>&gt; 12</td> <td>&gt; 16</td> <td>&gt; 18</td> <td>≤ 3</td> </tr> <tr> <td>256 QAM</td> <td colspan="6">≥ 1</td> <td>≤ 5</td> </tr> </tbody> </table>	Modulation	Channel bandwidth / Transmission bandwidth (N <sub>RB</sub> )						MPR (dB)	1.4 MHz	3.0 MHz	5 MHz	10 MHz	15 MHz	20 MHz	QPSK	> 5	> 4	> 8	> 12	> 16	> 18	≤ 1	16 QAM	≤ 5	≤ 4	≤ 8	≤ 12	≤ 16	≤ 18	≤ 1	16 QAM	> 5	> 4	> 8	> 12	> 16	> 18	≤ 2	64 QAM	≤ 5	≤ 4	≤ 8	≤ 12	≤ 16	≤ 18	≤ 2	64 QAM	> 5	> 4	> 8	> 12	> 16	> 18	≤ 3	256 QAM	≥ 1						≤ 5
Modulation	Channel bandwidth / Transmission bandwidth (N <sub>RB</sub> )						MPR (dB)																																																								
	1.4 MHz	3.0 MHz	5 MHz	10 MHz	15 MHz	20 MHz																																																									
QPSK	> 5	> 4	> 8	> 12	> 16	> 18	≤ 1																																																								
16 QAM	≤ 5	≤ 4	≤ 8	≤ 12	≤ 16	≤ 18	≤ 1																																																								
16 QAM	> 5	> 4	> 8	> 12	> 16	> 18	≤ 2																																																								
64 QAM	≤ 5	≤ 4	≤ 8	≤ 12	≤ 16	≤ 18	≤ 2																																																								
64 QAM	> 5	> 4	> 8	> 12	> 16	> 18	≤ 3																																																								
256 QAM	≥ 1						≤ 5																																																								
LTE A-MPR	In the base station simulator configuration, Network Setting value is set to NS_01 to disable A-MPR during SAR testing and the LTE SAR tests was transmitting on all TTI frames (Maximum TTI)																																																														
Spectrum plots for RB configuration	A properly configured base station simulator was used for the SAR and power measurement; therefore, spectrum plots for each RB allocation and offset configuration are not included in the SAR report.																																																														
Power reduction applied to satisfy SAR compliance	Yes, head/body-worn/ hotspot/extremity will trigger reduced power for some LTE bands, the detail please referred to section 13.																																																														
LTE Carrier Aggregation Combinations	Intra-Band and Inter-Band possible combinations and the detail power verification please referred to section 13.																																																														
LTE Carrier Aggregation Additional Information	This device supports maximum of 2 carriers in the downlink. Additional following LTE Release features are not supported: Relay, HetNet, Enhanced MIMO, eICI, WiFi Offloading, MDH, eMBMA, Cross-Carrier Scheduling, Enhanced SC-FDMA.																																																														



Transmission (H, M, L) channel numbers and frequencies in each LTE band																
LTE Band 2																
	Bandwidth 1.4 MHz		Bandwidth 3 MHz		Bandwidth 5 MHz		Bandwidth 10 MHz		Bandwidth 15 MHz		Bandwidth 20 MHz					
	Ch. #	Freq. (MHz)	Ch. #	Freq. (MHz)	Ch. #	Freq. (MHz)	Ch. #	Freq. (MHz)	Ch. #	Freq. (MHz)	Ch. #	Freq. (MHz)				
L	18607	1850.7	18615	1851.5	18625	1852.5	18650	1855	18675	1857.5	18700	1860				
M	18900	1880	18900	1880	18900	1880	18900	1880	18900	1880	18900	1880				
H	19193	1909.3	19185	1908.5	19175	1907.5	19150	1905	19125	1902.5	19100	1900				
LTE Band 4																
	Bandwidth 1.4 MHz		Bandwidth 3 MHz		Bandwidth 5 MHz		Bandwidth 10 MHz		Bandwidth 15 MHz		Bandwidth 20 MHz					
	Ch. #	Freq. (MHz)	Ch. #	Freq. (MHz)	Ch. #	Freq. (MHz)	Ch. #	Freq. (MHz)	Ch. #	Freq. (MHz)	Ch. #	Freq. (MHz)				
L	19957	1710.7	19965	1711.5	19975	1712.5	20000	1715	20025	1717.5	20050	1720				
M	20175	1732.5	20175	1732.5	20175	1732.5	20175	1732.5	20175	1732.5	20175	1732.5				
H	20393	1754.3	20385	1753.5	20375	1752.5	20350	1750	20325	1747.5	20300	1745				
LTE Band 5																
	Bandwidth 1.4 MHz		Bandwidth 3 MHz		Bandwidth 5 MHz		Bandwidth 10 MHz		Bandwidth 15 MHz		Bandwidth 20 MHz					
	Ch. #	Freq. (MHz)	Ch. #	Freq. (MHz)	Ch. #	Freq. (MHz)	Ch. #	Freq. (MHz)	Ch. #	Freq. (MHz)	Ch. #	Freq. (MHz)				
L	20407	824.7	20415	825.5	20425	826.5	20450	829	20450	829	20450	829				
M	20525	836.5	20525	836.5	20525	836.5	20525	836.5	20525	836.5	20525	836.5				
H	20643	848.3	20635	847.5	20625	846.5	20600	844	20600	844	20600	844				
LTE Band 7																
	Bandwidth 5 MHz		Bandwidth 10 MHz		Bandwidth 15 MHz		Bandwidth 20 MHz		Bandwidth 15 MHz		Bandwidth 20 MHz					
	Ch. #	Freq. (MHz)	Ch. #	Freq. (MHz)	Ch. #	Freq. (MHz)	Ch. #	Freq. (MHz)	Ch. #	Freq. (MHz)	Ch. #	Freq. (MHz)				
L	20775	2502.5	20800	2505	20825	2507.5	20850	2510	20850	2510	20850	2510				
M	21100	2535	21100	2535	21100	2535	21100	2535	21100	2535	21100	2535				
H	21425	2567.5	21400	2565	21375	2562.5	21350	2560	21350	2560	21350	2560				
LTE Band 12																
	Bandwidth 1.4 MHz		Bandwidth 3 MHz		Bandwidth 5 MHz		Bandwidth 10 MHz		Bandwidth 15 MHz		Bandwidth 20 MHz					
	Ch. #	Freq. (MHz)	Ch. #	Freq. (MHz)	Ch. #	Freq. (MHz)	Ch. #	Freq. (MHz)	Ch. #	Freq. (MHz)	Ch. #	Freq. (MHz)				
L	23017	699.7	23025	700.5	23035	701.5	23060	704	23060	704	23060	704				
M	23095	707.5	23095	707.5	23095	707.5	23095	707.5	23095	707.5	23095	707.5				
H	23173	715.3	23165	714.5	23155	713.5	23130	711	23130	711	23130	711				
LTE Band 13																
	Bandwidth 5 MHz				Bandwidth 10 MHz				Bandwidth 15 MHz				Bandwidth 20 MHz			
	Channel #		Freq.(MHz)		Channel #		Freq.(MHz)		Channel #		Freq.(MHz)		Channel #		Freq.(MHz)	
L	23205		779.5		23230		782		23255		784.5		23280		787	
M	23230		782		23255		784.5		23280		787		23305		789.5	
H	23255		784.5		23280		787		23305		789.5		23330		792	
LTE Band 26																
	Bandwidth 1.4 MHz		Bandwidth 3 MHz		Bandwidth 5 MHz		Bandwidth 10 MHz		Bandwidth 15 MHz		Bandwidth 20 MHz					
	Ch. #	Freq. (MHz)	Ch. #	Freq. (MHz)	Ch. #	Freq. (MHz)	Ch. #	Freq. (MHz)	Ch. #	Freq. (MHz)	Ch. #	Freq. (MHz)				
L	26697	814.7	26705	815.5	26715	816.5	26740	819	26765	821.5	26790	824				
M	26865	831.5	26865	831.5	26865	831.5	26865	831.5	26865	831.5	26865	831.5				
H	27033	848.3	27025	847.5	27015	846.5	26990	844	26965	841.5	26940	839				
LTE Band 66																
	Bandwidth 1.4 MHz		Bandwidth 3 MHz		Bandwidth 5 MHz		Bandwidth 10 MHz		Bandwidth 15 MHz		Bandwidth 20 MHz					
	Ch. #	Freq. (MHz)	Ch. #	Freq. (MHz)	Ch. #	Freq. (MHz)	Ch. #	Freq. (MHz)	Ch. #	Freq. (MHz)	Ch. #	Freq. (MHz)				
L	131979	1710.7	131987	1711.5	131997	1712.5	132022	1715	132047	1717.5	132072	1720				
M	132322	1745	132322	1745	132322	1745	132322	1745	132322	1745	132322	1745				
H	132665	1779.3	132657	1778.5	132647	1777.5	132622	1775	132597	1772.5	132572	1770				

## 5. Proximity Sensor Triggering Test

### <Proximity Sensor Triggering Distance>:

1. Proximity sensor triggering distance testing was performed according to the procedures outlined in KDB 616217 D04 section 6.2, and EUT moving further away from the flat phantom and EUT moving toward the flat phantom were both assessed and the tissue-equivalent medium for highest frequency (2600MHz) and lowest (1750MHz) frequency was used for proximity sensor triggering testing.
2. Capacitive proximity sensors placed coincident with antenna elements at the top and bottom ends of the phone are utilized to determine when the device comes in proximity of the user's body at the front or back of the device. The output power will reduce to body worn power level when top and bottom sensor pad be detected.
3. The sensors used to detect the proximity of the user's body at the front or back surface of the device use a detection threshold distance. The data shown in the sections below shows the distance(s). When front or back body worn condition is detected reduced power will be active.
4. The device employs proximity sensors also can detect the presence of the user's a finger or hand when handheld state at the front/back/right/bottom sides of the device. When front/back/right/bottom sides of handheld condition is detected reduced power will be active.
5. For verification of compliance of power reduction scheme, additional SAR testing with EUT transmitting at full RF power at a conservative trigger distance -1mm was performed:

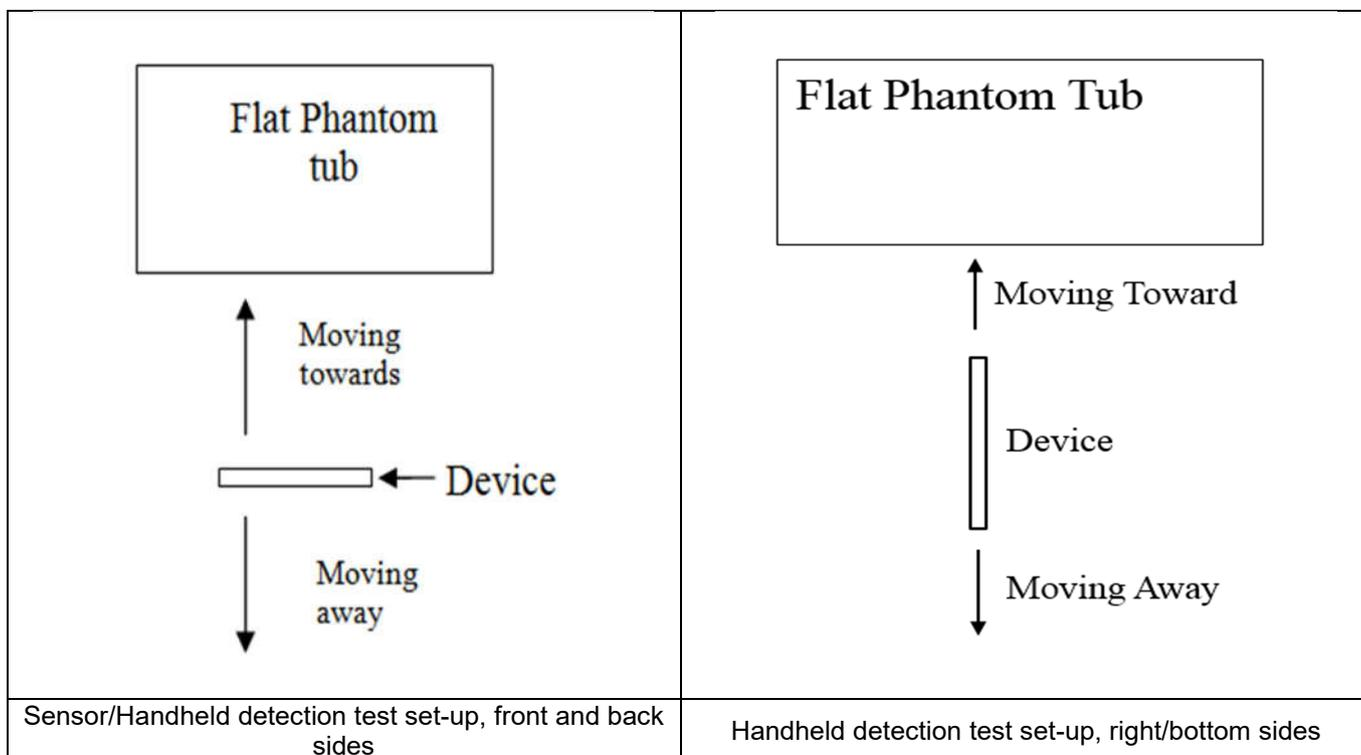

**<P-Sensor>**

Proximity Sensor Triggering Distance (mm)				
Position	Front		Back	
	Moving towards	Moving away	Moving towards	Moving away
Minimum	15	24	20	23

**<Handheld for ANT1>**

Proximity Sensor Triggering Distance (mm)								
Position	Front		Back		Bottom Side		Right Side	
	Moving towards	Moving away	Moving towards	Moving away	Moving towards	Moving away	Moving towards	Moving away
Minimum	14	18	18	23	18	22	4	10

**<Handheld for ANT2>**

Proximity Sensor Triggering Distance (mm)						
Position	Front		Back		Bottom Side	
	Moving towards	Moving away	Moving towards	Moving away	Moving towards	Moving away
Minimum	7	9	10	14	10	10

## **6. RF Exposure Limits**

### **6.1 Uncontrolled Environment**

Uncontrolled Environments are defined as locations where there is the exposure of individuals who have no knowledge or control of their exposure. The general population/uncontrolled exposure limits are applicable to situations in which the general public may be exposed or in which persons who are exposed as a consequence of their employment may not be made fully aware of the potential for exposure or cannot exercise control over their exposure. Members of the general public would come under this category when exposure is not employment-related; for example, in the case of a wireless transmitter that exposes persons in its vicinity.

### **6.2 Controlled Environment**

Controlled Environments are defined as locations where there is exposure that may be incurred by persons who are aware of the potential for exposure, (i.e. as a result of employment or occupation). In general, occupational/controlled exposure limits are applicable to situations in which persons are exposed as a consequence of their employment, who have been made fully aware of the potential for exposure and can exercise control over their exposure. The exposure category is also applicable when the exposure is of a transient nature due to incidental passage through a location where the exposure levels may be higher than the general population/uncontrolled limits, but the exposed person is fully aware of the potential for exposure and can exercise control over his or her exposure by leaving the area or by some other appropriate means.

**Limits for Occupational/Controlled Exposure (W/kg)**

Whole-Body	Partial-Body	Hands, Wrists, Feet and Ankles
0.4	8.0	20.0

**Limits for General Population/Uncontrolled Exposure (W/kg)**

Whole-Body	Partial-Body	Hands, Wrists, Feet and Ankles
0.08	1.6	4.0

Whole-Body SAR is averaged over the entire body, partial-body SAR is averaged over any 1gram of tissue defined as a tissue volume in the shape of a cube. SAR for hands, wrists, feet and ankles is averaged over any 10 grams of tissue defined as a tissue volume in the shape of a cube.

## 7. Specific Absorption Rate (SAR)

### 7.1 Introduction

SAR is related to the rate at which energy is absorbed per unit mass in an object exposed to a radio field. The SAR distribution in a biological body is complicated and is usually carried out by experimental techniques or numerical modeling. The standard recommends limits for two tiers of groups, occupational/controlled and general population/uncontrolled, based on a person's awareness and ability to exercise control over his or her exposure. In general, occupational/controlled exposure limits are higher than the limits for general population/uncontrolled.

### 7.2 SAR Definition

The SAR definition is the time derivative (rate) of the incremental energy (dW) absorbed by (dissipated in) an incremental mass (dm) contained in a volume element (dv) of a given density ( $\rho$ ). The equation description is as below:

$$\text{SAR} = \frac{d}{dt} \left( \frac{dW}{dm} \right) = \frac{d}{dt} \left( \frac{dW}{\rho dv} \right)$$

SAR is expressed in units of Watts per kilogram (W/kg)

$$\text{SAR} = \frac{\sigma |E|^2}{\rho}$$

Where:  $\sigma$  is the conductivity of the tissue,  $\rho$  is the mass density of the tissue and E is the RMS electrical field strength.

## **8. System Description and Setup**

The DASY system used for performing compliance tests consists of the following items:

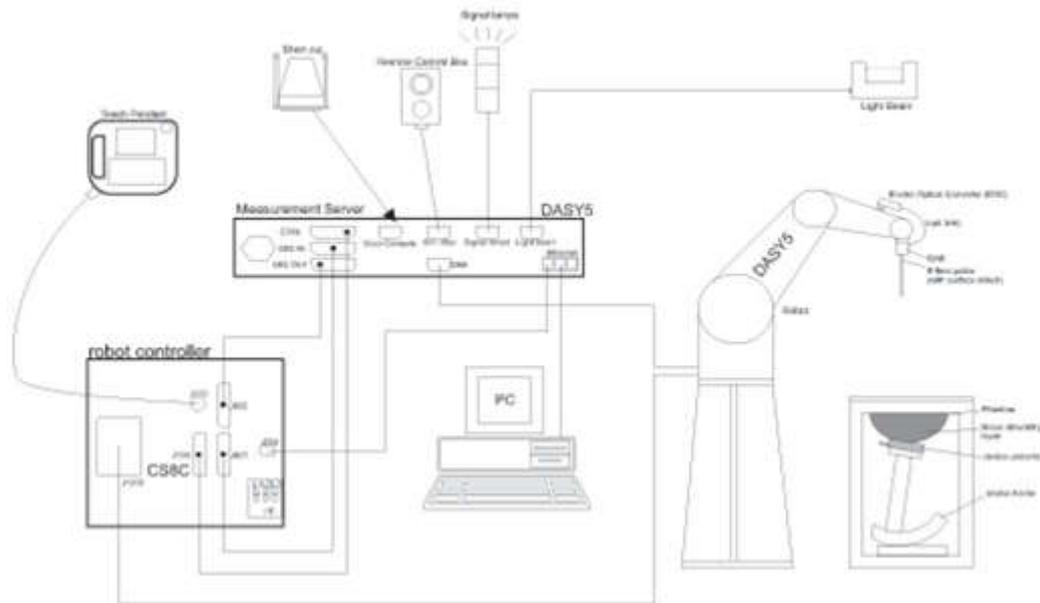

- A standard high precision 6-axis robot with controller, teach pendant and software. An arm extension for accommodating the data acquisition electronics (DAE).
- An isotropic Field probe optimized and calibrated for the targeted measurement.
- A data acquisition electronics (DAE) which performs the signal amplification, signal multiplexing, AD-conversion, offset measurements, mechanical surface detection, collision detection, etc. The unit is battery powered with standard or rechargeable batteries. The signal is optically transmitted to the EOC.
- The Electro-optical converter (EOC) performs the conversion from optical to electrical signals for the digital communication to the DAE. To use optical surface detection, a special version of the EOC is required. The EOC signal is transmitted to the measurement server.
- The function of the measurement server is to perform the time critical tasks such as signal filtering, control of the robot operation and fast movement interrupts.
- The Light Beam used is for probe alignment. This improves the (absolute) accuracy of the probe positioning.
- A computer running WinXP or Win7 and the DASY5 software.
- Remote control and teach pendant as well as additional circuitry for robot safety such as warning lamps, etc.
- The phantom, the device holder and other accessories according to the targeted measurement.

**8.1 E-Field Probe**

The SAR measurement is conducted with the dosimetric probe (manufactured by SPEAG).The probe is specially designed and calibrated for use in liquid with high permittivity. The dosimetric probe has special calibration in liquid at different frequency. This probe has a built in optical surface detection system to prevent from collision with phantom.

**<EX3DV4 Probe>**

<b>Construction</b>	Symmetric design with triangular core Built-in shielding against static charges PEEK enclosure material (resistant to organic solvents, e.g., DGBE)	
<b>Frequency</b>	10 MHz – >6 GHz Linearity: ±0.2 dB (30 MHz – 6 GHz)	
<b>Directivity</b>	±0.3 dB in TSL (rotation around probe axis) ±0.5 dB in TSL (rotation normal to probe axis)	
<b>Dynamic Range</b>	10 µW/g – >100 mW/g Linearity: ±0.2 dB (noise: typically <1 µW/g)	
<b>Dimensions</b>	Overall length: 337 mm (tip: 20 mm) Tip diameter: 2.5 mm (body: 12 mm) Typical distance from probe tip to dipole centers: 1 mm	

**8.2 Data Acquisition Electronics (DAE)**

The data acquisition electronics (DAE) consists of a highly sensitive electrometer-grade preamplifier with auto-zeroing, a channel and gain-switching multiplexer, a fast 16 bit AD-converter and a command decoder and control logic unit. Transmission to the measurement server is accomplished through an optical downlink for data and status information as well as an optical uplink for commands and the clock.

The input impedance of the DAE is 200 MOhm; the inputs are symmetrical and floating. Common mode rejection is above 80 dB.



**Photo of DAE**

**8.3 Phantom**

**<SAM Twin Phantom>**

<b>Shell Thickness</b>	2 ± 0.2 mm; Center ear point: 6 ± 0.2 mm	
<b>Filling Volume</b>	Approx. 25 liters	
<b>Dimensions</b>	Length: 1000 mm; Width: 500 mm; Height: adjustable feet	
<b>Measurement Areas</b>	Left Hand, Right Hand, Flat Phantom	

The bottom plate contains three pair of bolts for locking the device holder. The device holder positions are adjusted to the standard measurement positions in the three sections. A white cover is provided to tap the phantom during off-periods to prevent water evaporation and changes in the liquid parameters. On the phantom top, three reference markers are provided to identify the phantom position with respect to the robot.

**<ELI Phantom>**

<b>Shell Thickness</b>	2 ± 0.2 mm (sagging: <1%)	
<b>Filling Volume</b>	Approx. 30 liters	
<b>Dimensions</b>	Major ellipse axis: 600 mm Minor axis: 400 mm	

The ELI phantom is intended for compliance testing of handheld and body-mounted wireless devices in the frequency range of 30 MHz to 6 GHz. ELI4 is fully compatible with standard and all known tissue simulating liquids.

## 8.4 Device Holder

### <Mounting Device for Hand-Held Transmitter>

In combination with the Twin SAM V5.0/V5.0c or ELI phantoms, the Mounting Device for Hand-Held Transmitters enables rotation of the mounted transmitter device to specified spherical coordinates. At the heads, the rotation axis is at the ear opening. Transmitter devices can be easily and accurately positioned according to IEC 62209-1, IEEE 1528, FCC, or other specifications. The device holder can be locked for positioning at different phantom sections (left head, right head, flat). And upgrade kit to Mounting Device to enable easy mounting of wider devices like big smart-phones, e-books, small tablets, etc. It holds devices with width up to 140 mm.



Mounting Device for Hand-Held Transmitters



Mounting Device Adaptor for Wide-Phones

### <Mounting Device for Laptops and other Body-Worn Transmitters>

The extension is lightweight and made of POM, acrylic glass and foam. It fits easily on the upper part of the mounting device in place of the phone positioned. The extension is fully compatible with the SAM Twin and ELI phantoms.



Mounting Device for Laptops

## 9. Measurement Procedures

The measurement procedures are as follows:

### <Conducted power measurement>

- (a) For WWAN power measurement, use base station simulator to configure EUT WWAN transmission in conducted connection with RF cable, at maximum power in each supported wireless interface and frequency band.
- (b) Read the WWAN RF power level from the base station simulator.
- (c) For WLAN/BT power measurement, use engineering software to configure EUT WLAN/BT continuously transmission, at maximum RF power in each supported wireless interface and frequency band
- (d) Connect EUT RF port through RF cable to the power meter, and measure WLAN/BT output power

### <SAR measurement>

- (a) Use base station simulator to configure EUT WWAN transmission in radiated connection, and engineering software to configure EUT WLAN/BT continuously transmission, at maximum RF power, in the highest power channel.
- (b) Place the EUT in the positions as Appendix D demonstrates.
- (c) Set scan area, grid size and other setting on the DASY software.
- (d) Measure SAR results for the highest power channel on each testing position.
- (e) Find out the largest SAR result on these testing positions of each band
- (f) Measure SAR results for other channels in worst SAR testing position if the reported SAR of highest power channel is larger than 0.8 W/kg

According to the test standard, the recommended procedure for assessing the peak spatial-average SAR value consists of the following steps:

- (a) Power reference measurement
- (b) Area scan
- (c) Zoom scan
- (d) Power drift measurement

### 9.1 Spatial Peak SAR Evaluation

The procedure for spatial peak SAR evaluation has been implemented according to the test standard. It can be conducted for 1g and 10g, as well as for user-specific masses. The DASY software includes all numerical procedures necessary to evaluate the spatial peak SAR value.

The base for the evaluation is a "cube" measurement. The measured volume must include the 1g and 10g cubes with the highest averaged SAR values. For that purpose, the center of the measured volume is aligned to the interpolated peak SAR value of a previously performed area scan.

The entire evaluation of the spatial peak values is performed within the post-processing engine (SEMCAD). The system always gives the maximum values for the 1g and 10g cubes. The algorithm to find the cube with highest averaged SAR is divided into the following stages:

- (a) Extraction of the measured data (grid and values) from the Zoom Scan
- (b) Calculation of the SAR value at every measurement point based on all stored data (A/D values and measurement parameters)
- (c) Generation of a high-resolution mesh within the measured volume
- (d) Interpolation of all measured values from the measurement grid to the high-resolution grid
- (e) Extrapolation of the entire 3-D field distribution to the phantom surface over the distance from sensor to surface
- (f) Calculation of the averaged SAR within masses of 1g and 10g

**9.2 Power Reference Measurement**

The Power Reference Measurement and Power Drift Measurements are for monitoring the power drift of the device under test in the batch process. The minimum distance of probe sensors to surface determines the closest measurement point to phantom surface. This distance cannot be smaller than the distance of sensor calibration points to probe tip as defined in the probe properties.

**9.3 Area Scan**

The area scan is used as a fast scan in two dimensions to find the area of high field values, before doing a fine measurement around the hot spot. The sophisticated interpolation routines implemented in DASY software can find the maximum found in the scanned area, within a range of the global maximum. The range (in dB0 is specified in the standards for compliance testing. For example, a 2 dB range is required in IEEE standard 1528 and IEC 62209 standards, whereby 3 dB is a requirement when compliance is assessed in accordance with the ARIB standard (Japan), if only one zoom scan follows the area scan, then only the absolute maximum will be taken as reference. For cases where multiple maximums are detected, the number of zoom scans has to be increased accordingly.

Area scan parameters extracted from FCC KDB 865664 D01v01r04 SAR measurement 100 MHz to 6 GHz.

	$\leq 3$ GHz	$> 3$ GHz
Maximum distance from closest measurement point (geometric center of probe sensors) to phantom surface	$5 \pm 1$ mm	$\frac{1}{2} \cdot \delta \cdot \ln(2) \pm 0.5$ mm
Maximum probe angle from probe axis to phantom surface normal at the measurement location	$30^\circ \pm 1^\circ$	$20^\circ \pm 1^\circ$
Maximum area scan spatial resolution: $\Delta x_{Area}, \Delta y_{Area}$	$\leq 2$ GHz: $\leq 15$ mm $2 - 3$ GHz: $\leq 12$ mm	$3 - 4$ GHz: $\leq 12$ mm $4 - 6$ GHz: $\leq 10$ mm
	When the x or y dimension of the test device, in the measurement plane orientation, is smaller than the above, the measurement resolution must be $\leq$ the corresponding x or y dimension of the test device with at least one measurement point on the test device.	

### 9.4 Zoom Scan

Zoom scans are used to assess the peak spatial SAR values within a cubic averaging volume containing 1 gram and 10 gram of simulated tissue. The zoom scan measures points (refer to table below) within a cube whose base faces are centered on the maxima found in a preceding area scan job within the same procedure. When the measurement is done, the zoom scan evaluates the averaged SAR for 1 gram and 10 gram and displays these values next to the job's label.

Zoom scan parameters extracted from FCC KDB 865664 D01v01r04 SAR measurement 100 MHz to 6 GHz.

		≤ 3 GHz	> 3 GHz	
Maximum zoom scan spatial resolution: $\Delta x_{Zoom}$ , $\Delta y_{Zoom}$		$\leq 2$ GHz: $\leq 8$ mm 2 – 3 GHz: $\leq 5$ mm*	3 – 4 GHz: $\leq 5$ mm* 4 – 6 GHz: $\leq 4$ mm*	
Maximum zoom scan spatial resolution, normal to phantom surface	uniform grid: $\Delta z_{Zoom}(n)$	$\leq 5$ mm	3 – 4 GHz: $\leq 4$ mm 4 – 5 GHz: $\leq 3$ mm 5 – 6 GHz: $\leq 2$ mm	
	graded grid	$\Delta z_{Zoom}(1)$ : between 1 <sup>st</sup> two points closest to phantom surface	$\leq 4$ mm	3 – 4 GHz: $\leq 3$ mm 4 – 5 GHz: $\leq 2.5$ mm 5 – 6 GHz: $\leq 2$ mm
		$\Delta z_{Zoom}(n>1)$ : between subsequent points	$\leq 1.5 \cdot \Delta z_{Zoom}(n-1)$	
Minimum zoom scan volume	x, y, z	$\geq 30$ mm	3 – 4 GHz: $\geq 28$ mm 4 – 5 GHz: $\geq 25$ mm 5 – 6 GHz: $\geq 22$ mm	
Note: $\delta$ is the penetration depth of a plane-wave at normal incidence to the tissue medium; see draft standard IEEE P1528-2011 for details. * When zoom scan is required and the <i>reported</i> SAR from the <i>area scan based 1-g SAR estimation</i> procedures of KDB 447498 is $\leq 1.4$ W/kg, $\leq 8$ mm, $\leq 7$ mm and $\leq 5$ mm zoom scan resolution may be applied, respectively, for 2 GHz to 3 GHz, 3 GHz to 4 GHz and 4 GHz to 6 GHz.				

### 9.5 Volume Scan Procedures

The volume scan is used to assess overlapping SAR distributions for antennas transmitting in different frequency bands. It is equivalent to an oversized zoom scan used in standalone measurements. The measurement volume will be used to enclose all the simultaneous transmitting antennas. For antennas transmitting simultaneously in different frequency bands, the volume scan is measured separately in each frequency band. In order to sum correctly to compute the 1g aggregate SAR, the EUT remain in the same test position for all measurements and all volume scan use the same spatial resolution and grid spacing. When all volume scan were completed, the software, SEMCAD postprocessor can combine and subsequently superpose these measurement data to calculating the multiband SAR.

### 9.6 Power Drift Monitoring

All SAR testing is under the EUT install full charged battery and transmit maximum output power. In DASy measurement software, the power reference measurement and power drift measurement procedures are used for monitoring the power drift of EUT during SAR test. Both these procedures measure the field at a specified reference position before and after the SAR testing. The software will calculate the field difference in dB. If the power drifts more than 5%, the SAR will be retested.



### 10. Test Equipment List

Manufacturer	Name of Equipment	Type/Model	Serial Number	Calibration	
				Last Cal.	Due Date
SPEAG	750MHz System Validation Kit	D750V3	1087	2019/3/27	2022/3/24
SPEAG	835MHz System Validation Kit	D835V2	4d258	2020/5/7	2023/5/6
SPEAG	1750MHz System Validation Kit	D1750V2	1090	2019/3/27	2022/3/25
SPEAG	1900MHz System Validation Kit	D1900V2	5d170	2019/3/26	2022/3/24
SPEAG	2450MHz System Validation Kit	D2450V2	908	2019/3/25	2022/3/23
SPEAG	2600MHz System Validation Kit	D2600V2	1061	2020/11/26	2021/11/25
SPEAG	5000MHz System Validation Kit	D5GH2V2	1113	2019/9/24	2022/9/23
SPEAG	Data Acquisition Electronics	DAE4	1649	2021/2/3	2022/2/2
SPEAG	Dosimetric E-Field Probe	EX3DV4	7627	2021/2/10	2022/2/9
SPEAG	SAM Twin Phantom	SAM Twin	TP-2024	NCR	NCR
SPEAG	Phone Positioner	N/A	N/A	NCR	NCR
Anritsu	Radio Communication Analyzer	MT8821C	6201432831	2021/4/13	2022/4/12
Agilent	ENA Series Network Analyzer	E5071C	MY46106933	2021/7/31	2022/7/30
SPEAG	Dielectric Probe Kit	DAK-3.5	1144	2020/12/2	2021/12/1
Anritsu	Vector Signal Generator	MG3710A	6201682672	2021/1/7	2022/1/6
Rohde & Schwarz	Power Meter	NRVD	102081	2020/8/13	2021/8/12
Rohde & Schwarz	Power Sensor	NRV-Z5	100538	2020/8/13	2021/8/12
Rohde & Schwarz	Power Sensor	NRV-Z5	100539	2020/8/13	2021/8/12
Rohde & Schwarz	Power Meter	NRVD	102081	2021/8/12	2022/8/11
Rohde & Schwarz	Power Sensor	NRV-Z5	100538	2021/8/12	2022/8/11
Rohde & Schwarz	Power Sensor	NRV-Z5	100539	2021/8/12	2022/8/11
R&S	CBT BLUETOOTH TESTER	CBT	101246	2021/4/12	2022/4/11
EXA	Spectrum Analyzer	FSV7	101632	2021/1/7	2022/1/6
FLUKE	DIGITAC THERMOMETER	51II	97240029	2020/8/14	2021/8/13
FLUKE	DIGITAC THERMOMETER	51II	97240029	2021/8/13	2022/8/12
Testo	Hygrometer	608-H1	1241332102	2021/1/7	2022/1/6
ARRA	Power Divider	A3200-2	N/A	Note 1	
MCL	Attenuation1	BW-S10W5+	N/A	Note 1	
MCL	Attenuation2	BW-S10W5+	N/A	Note 1	
MCL	Attenuation3	BW-S10W5+	N/A	Note 1	
BONN	POWER AMPLIFIER	BLMA 0830-3	087193A	Note 1	
BONN	POWER AMPLIFIER	BLMA 2060-2	087193B	Note 1	
Agilent	Dual Directional Coupler	778D	20500	Note 1	
Agilent	Dual Directional Coupler	11691D	MY48151020	Note 1	

**Note:**

1. Prior to system verification and validation, the path loss from the signal generator to the system check source and the power meter, which includes the amplifier, cable, attenuator and directional coupler, was measured by the network analyzer. The reading of the power meter was offset by the path loss difference between the path to the power meter and the path to the system check source to monitor the actual power level fed to the system check
2. Referring to KDB 865664 D01v01r04, the dipole calibration interval can be extended to 3 years with justification. The dipoles are also not physically damaged, or repaired during the interval.
3. The justification data of dipole can be found in appendix C. The return loss is < -20dB, within 20% of prior calibration, the impedance is within 5 ohm of prior calibration.

## 11. System Verification

### 11.1 Tissue Simulating Liquids

For the measurement of the field distribution inside the SAM phantom with DASY, the phantom must be filled with around 25 liters of homogeneous body tissue simulating liquid. For head SAR testing, the liquid height from the ear reference point (ERP) of the phantom to the liquid top surface is larger than 15 cm, which is shown in Fig. 11.1. For body SAR testing, the liquid height from the center of the flat phantom to the liquid top surface is larger than 15 cm, which is shown in Fig. 11.2.

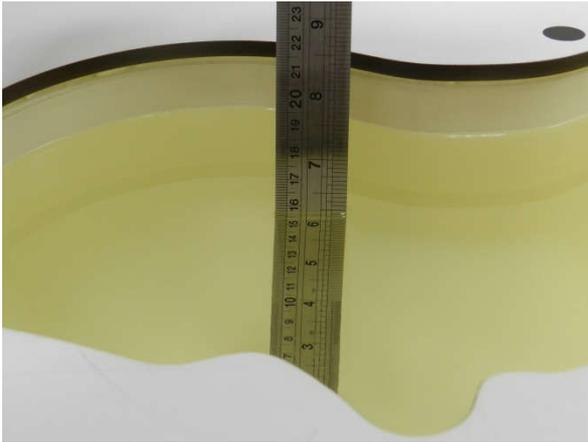

Fig 11.1 Photo of Liquid Height for Head SAR



Fig 11.2 Photo of Liquid Height for Body SAR

### 11.2 Tissue Verification

The following tissue formulations are provided for reference only as some of the parameters have not been thoroughly verified. The composition of ingredients may be modified accordingly to achieve the desired target tissue parameters required for routine SAR evaluation.

Frequency (MHz)	Water (%)	Sugar (%)	Cellulose (%)	Salt (%)	Preventol (%)	DGBE (%)	Conductivity ( $\sigma$ )	Permittivity ( $\epsilon_r$ )
For Head								
750	41.1	57.0	0.2	1.4	0.2	0	0.89	41.9
835	40.3	57.9	0.2	1.4	0.2	0	0.90	41.5
1800, 1900	55.2	0	0	0.3	0	44.5	1.40	40.0
2450	55.0	0	0	0	0	45.0	1.80	39.2
2600	54.8	0	0	0.1	0	45.1	1.96	39.0

#### Simulating Liquid for 5GHz, Manufactured by SPEAG

Ingredients	(% by weight)
Water	64~78%
Mineral oil	11~18%
Emulsifiers	9~15%
Additives and Salt	2~3%

#### <Tissue Dielectric Parameter Check Results>

Frequency (MHz)	Tissue Type	Liquid Temp. (°C)	Conductivity ( $\sigma$ )	Permittivity ( $\epsilon_r$ )	Conductivity Target ( $\sigma$ )	Permittivity Target ( $\epsilon_r$ )	Delta ( $\sigma$ ) (%)	Delta ( $\epsilon_r$ ) (%)	Limit (%)	Date
750	Head	22.6	0.910	43.704	0.89	41.90	2.25	4.31	±5	2021/8/3
835	Head	22.8	0.934	41.804	0.90	41.50	3.78	0.73	±5	2021/8/5
1750	Head	22.7	1.342	40.449	1.37	40.10	-2.04	0.87	±5	2021/8/7
1900	Head	22.9	1.439	40.202	1.40	40.00	2.79	0.50	±5	2021/8/10
2450	Head	22.6	1.824	39.246	1.80	39.20	1.33	0.12	±5	2021/8/14
2600	Head	22.8	1.931	39.054	1.96	39.00	-1.48	0.14	±5	2021/8/13
5250	Head	22.7	4.587	36.312	4.71	35.90	-2.61	1.15	±5	2021/8/16
5600	Head	22.8	4.955	35.752	5.07	35.50	-2.27	0.71	±5	2021/8/18
5750	Head	22.6	5.137	35.564	5.22	35.40	-1.59	0.46	±5	2021/8/20

### 11.3 System Performance Check Results

Comparing to the original SAR value provided by SPEAG, the verification data should be within its specification of 10 %. Below table shows the target SAR and measured SAR after normalized to 1W input power. The table below indicates the system performance check can meet the variation criterion and the plots can be referred to Appendix A of this report.

**<1g SAR>**

Date	Frequency (MHz)	Tissue Type	Input Power (mW)	Dipole S/N	Probe S/N	DAE S/N	Measured 1g SAR (W/kg)	Targeted 1g SAR (W/kg)	Normalized 1g SAR (W/kg)	Deviation (%)
2021/8/3	750	Head	50	1087	7627	1649	0.417	8.36	8.34	-0.24
2021/8/5	835	Head	50	4d258	7627	1649	0.501	9.44	10.02	6.14
2021/8/7	1750	Head	50	1090	7627	1649	1.850	36.40	37	1.65
2021/8/10	1900	Head	50	5d170	7627	1649	2.050	39.00	41	5.13
2021/8/14	2450	Head	50	908	7627	1649	2.430	52.80	48.6	-7.95
2021/8/13	2600	Head	50	1061	7627	1649	2.700	56.60	54	-4.59
2021/8/16	5250	Head	50	1113	7627	1649	3.740	80.50	74.8	-7.08
2021/8/18	5600	Head	50	1113	7627	1649	3.890	83.40	77.8	-6.71
2021/8/20	5750	Head	50	1113	7627	1649	3.770	80.00	75.4	-5.75

**<10g SAR>**

Date	Frequency (MHz)	Tissue Type	Input Power (mW)	Dipole S/N	Probe S/N	DAE S/N	Measured 10g SAR (W/kg)	Targeted 10g SAR (W/kg)	Normalized 10g SAR (W/kg)	Deviation (%)
2021/8/3	750	Head	50	1087	7627	1649	0.273	5.65	5.46	-3.36
2021/8/5	835	Head	50	4d258	7627	1649	0.326	6.13	6.52	6.36
2021/8/7	1750	Head	50	1090	7627	1649	0.982	19.20	19.64	2.29
2021/8/10	1900	Head	50	5d170	7627	1649	1.060	20.30	21.2	4.43
2021/8/14	2450	Head	50	908	7627	1649	1.130	24.20	22.6	-6.61
2021/8/13	2600	Head	50	1061	7627	1649	1.230	25.10	24.6	-1.99
2021/8/16	5250	Head	50	1113	7627	1649	1.130	23.10	22.6	-2.16
2021/8/18	5600	Head	50	1113	7627	1649	1.110	23.80	22.2	-6.72
2021/8/20	5750	Head	50	1113	7627	1649	1.230	22.80	24.6	7.89

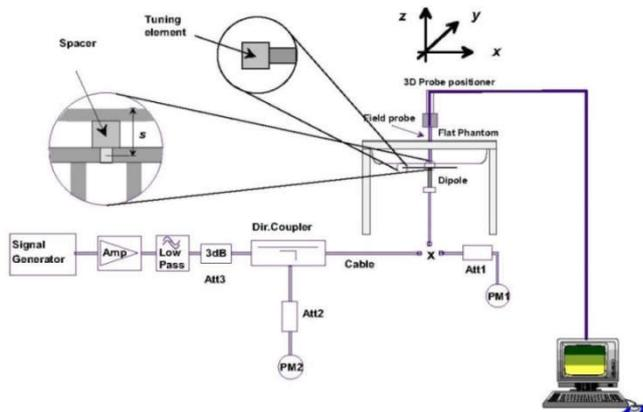

**Fig 11.3.1 System Performance Check Setup**



**Fig 11.3.2 Setup Photo**

## 12. RF Exposure Positions

### 12.1 Ear and handset reference point

Figure 12.1.1 shows the front, back, and side views of the SAM phantom. The center-of-mouth reference point is labeled “M,” the left ear reference point (ERP) is marked “LE,” and the right ERP is marked “RE.” Each ERP is 15 mm along the B-M (back-mouth) line behind the entrance-to-ear-canal (EEC) point, as shown in Figure 12.1.2 The Reference Plane is defined as passing through the two ear reference points and point M. The line N-F (neck-front), also called the reference pivoting line, is normal to the Reference Plane and perpendicular to both a line passing through RE and LE and the B-M line (see Figure 12.1.3). Both N-F and B-M lines should be marked on the exterior of the phantom shell to facilitate handset positioning. Posterior to the N-F line the ear shape is a flat surface with 6 mm thickness at each ERP, and forward of the N-F line the ear is truncated, as illustrated in Figure 12.1.2. The ear truncation is introduced to preclude the ear lobe from interfering with handset tilt, which could lead to unstable positioning at the cheek.

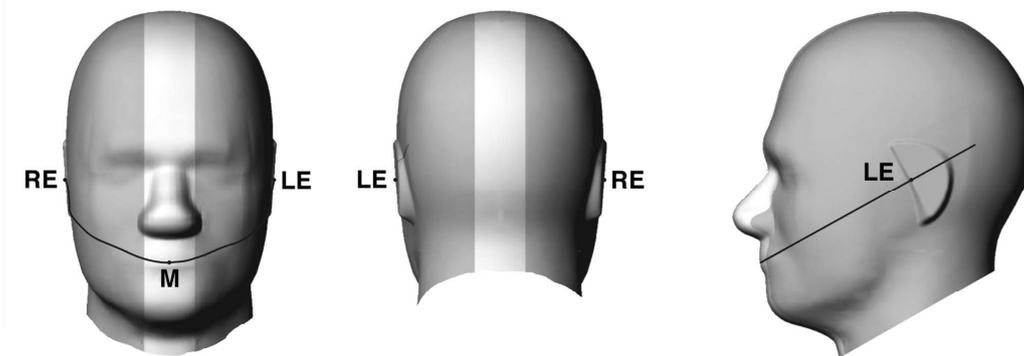

Fig 12.1.1 Front, back, and side views of SAM twin phantom

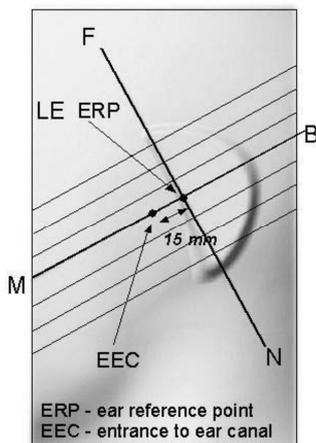

Fig 12.1.2 Close-up side view of phantom showing the ear region.

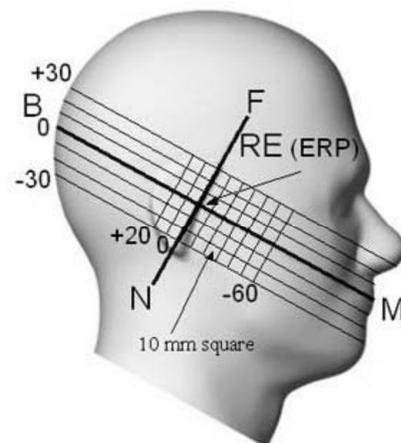
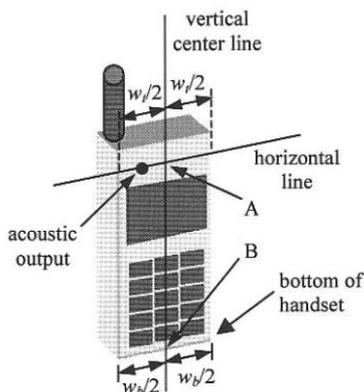

Fig 12.1.3 Side view of the phantom showing relevant markings and seven cross-sectional plane locations

## 12.2 Definition of the cheek position

1. Ready the handset for talk operation, if necessary. For example, for handsets with a cover piece (flip cover), open the cover. If the handset can transmit with the cover closed, both configurations must be tested.
2. Define two imaginary lines on the handset—the vertical centerline and the horizontal line. The vertical centerline passes through two points on the front side of the handset—the midpoint of the width  $w_t$  of the handset at the level of the acoustic output (point A in Figure 12.2.1 and Figure 12.2.2), and the midpoint of the width  $w_b$  of the bottom of the handset (point B). The horizontal line is perpendicular to the vertical centerline and passes through the center of the acoustic output (see Figure 12.2.1). The two lines intersect at point A. Note that for many handsets, point A coincides with the center of the acoustic output; however, the acoustic output may be located elsewhere on the horizontal line. Also note that the vertical centerline is not necessarily parallel to the front face of the handset (see Figure 12.2.2), especially for clamshell handsets, handsets with flip covers, and other irregularly-shaped handsets.
3. Position the handset close to the surface of the phantom such that point A is on the (virtual) extension of the line passing through points RE and LE on the phantom (see Figure 12.2.3), such that the plane defined by the vertical centerline and the horizontal line of the handset is approximately parallel to the sagittal plane of the phantom.
4. Translate the handset towards the phantom along the line passing through RE and LE until handset point A touches the pinna at the ERP.
5. While maintaining the handset in this plane, rotate it around the LE-RE line until the vertical centerline is in the plane normal to the plane containing B-M and N-F lines, i.e., the Reference Plane.
6. Rotate the handset around the vertical centerline until the handset (horizontal line) is parallel to the N-F line.
7. While maintaining the vertical centerline in the Reference Plane, keeping point A on the line passing through RE and LE, and maintaining the handset contact with the pinna, rotate the handset about the N-F line until any point on the handset is in contact with a phantom point below the pinna on the cheek. See Figure 12.2.3. The actual rotation angles should be documented in the test report.



**Fig 12.2.1 Handset vertical and horizontal reference lines—“fixed case”**

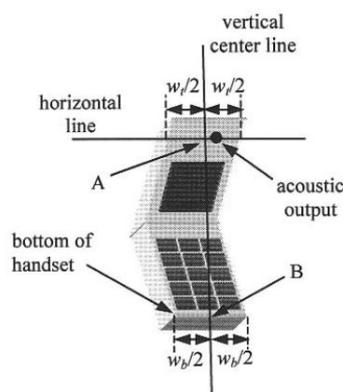

**Fig 12.2.2 Handset vertical and horizontal reference lines—“clam-shell case”**

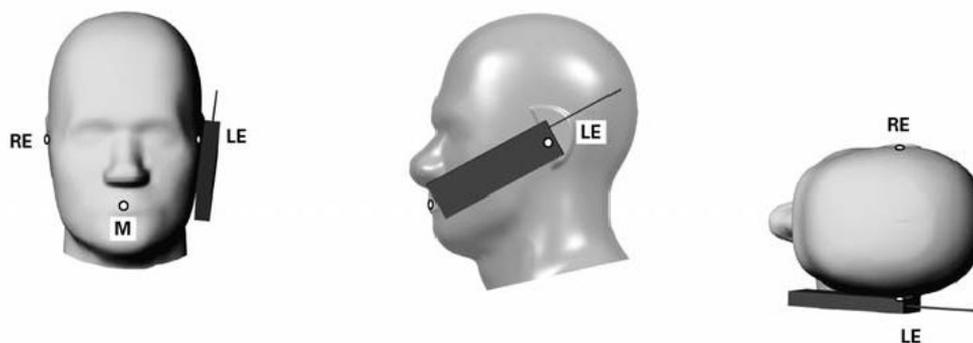

**Fig 12.2.3 cheek or touch position. The reference points for the right ear (RE), left ear (LE), and mouth (M), which establish the Reference Plane for handset positioning, are indicated.**

**12.3 Definition of the tilt position**

1. Ready the handset for talk operation, if necessary. For example, for handsets with a cover piece (flip cover), open the cover. If the handset can transmit with the cover closed, both configurations must be tested.
2. While maintaining the orientation of the handset, move the handset away from the pinna along the line passing through RE and LE far enough to allow a rotation of the handset away from the cheek by 15°.
3. Rotate the handset around the horizontal line by 15°.
4. While maintaining the orientation of the handset, move the handset towards the phantom on the line passing through RE and LE until any part of the handset touches the ear. The tilt position is obtained when the contact point is on the pinna. See Figure 12.3.1. If contact occurs at any location other than the pinna, e.g., the antenna at the back of the phantom head, the angle of the handset should be reduced. In this case, the tilt position is obtained if any point on the handset is in contact with the pinna and a second point

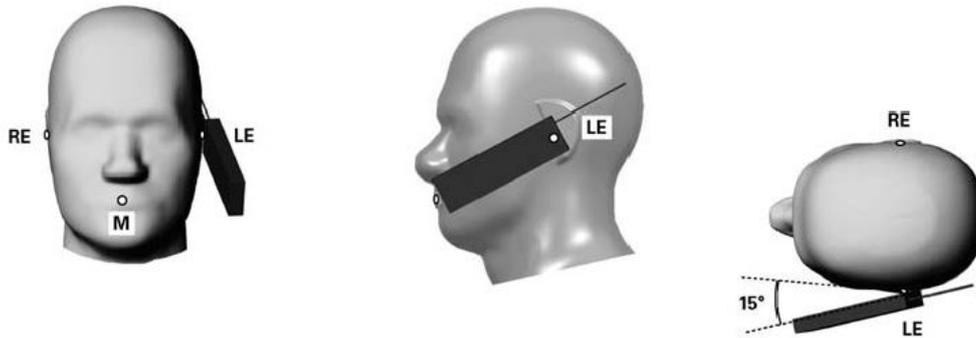

**Fig 12.3.1 Tilt position. The reference points for the right ear (RE), left ear (LE), and mouth (M), which define the Reference Plane for handset positioning, are indicated.**

## 12.4 Body Worn Accessory

Body-worn operating configurations are tested with the belt-clips and holsters attached to the device and positioned against a flat phantom in a normal use configuration (see Figure 12.4). Per KDB648474 D04v01r03, body-worn accessory exposure is typically related to voice mode operations when handsets are carried in body-worn accessories. The body-worn accessory procedures in FCC KDB 447498 D01v06 should be used to test for body-worn accessory SAR compliance, without a headset connected to it. This enables the test results for such configuration to be compatible with that required for hotspot mode when the body-worn accessory test separation distance is greater than or equal to that required for hotspot mode, when applicable. When the reported SAR for body-worn accessory, measured without a headset connected to the handset is  $> 1.2$  W/kg, the highest reported SAR configuration for that wireless mode and frequency band should be repeated for that body-worn accessory with a headset attached to the handset.

Accessories for body-worn operation configurations are divided into two categories: those that do not contain metallic components and those that do contain metallic components. When multiple accessories that do not contain metallic components are supplied with the device, the device is tested with only the accessory that dictates the closest spacing to the body. Then multiple accessories that contain metallic components are tested with the device with each accessory. If multiple accessories share an identical metallic component (i.e. the same metallic belt-clip used with different holsters with no other metallic components) only the accessory that dictates the closest spacing to the body is tested.

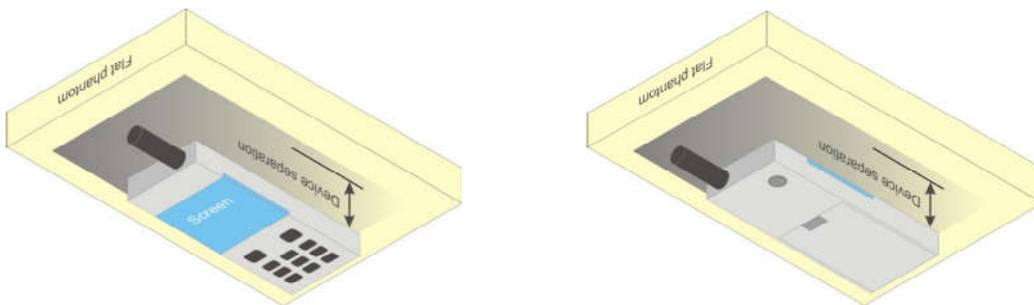

Fig 12.4 Body Worn Position

## 12.5 Product Specific 10g SAR Exposure

For smart phones with a display diagonal dimension > 15.0 cm or an overall diagonal dimension > 16.0 cm that provide similar mobile web access and multimedia support found in mini-tablets or UMPC mini-tablets that support voice calls next to the ear, According to KDB648474 D04v01r03, the following phablet procedures should be applied to evaluate SAR compliance for each applicable wireless modes and frequency band. Devices marketed as phablets, regardless of form factors and operating characteristics must be tested as a phablet to determine SAR compliance

1. The normally required head and body-worn accessory SAR test procedures for handsets, including hotspot mode, must be applied.
2. The UMPC mini-tablet procedures must also be applied to test the SAR of all surfaces and edges with an antenna located at  $\leq 25$  mm from that surface or edge, in direct contact with a flat phantom, for 10-g extremity SAR according to the body-equivalent tissue dielectric parameters in KDB 865664 to address interactive hand use exposure conditions.6 The UMPC mini-tablet 1-g SAR at 5 mm is not required. When hotspot mode applies, 10-g extremity SAR is required only for the surfaces and edges with hotspot mode 1-g reported SAR > 1.2 W/kg.

## 12.6 Wireless Router

Some battery-operated handsets have the capability to transmit and receive user through simultaneous transmission of WIFI simultaneously with a separate licensed transmitter. The FCC has provided guidance in FCC KDB Publication 941225 D06 v02r01 where SAR test considerations for handsets ( $L \times W \geq 9$  cm x 5 cm) are based on a composite test separation distance of 10mm from the front, back and edges of the device containing transmitting antennas within 2.5cm of their edges, determined from general mixed use conditions for this type of devices. Since the hotspot SAR results may overlap with the body-worn accessory SAR requirements, the more conservative configurations can be considered, thus excluding some body-worn accessory SAR tests.

When the user enables the personal wireless router functions for the handset, actual operations include simultaneous transmission of both the WIFI transmitter and another licensed transmitter. Both transmitters often do not transmit at the same transmitting frequency and thus cannot be evaluated for SAR under actual use conditions due to the limitations of the SAR assessment probes. Therefore, SAR must be evaluated for each frequency transmission and mode separately and spatially summed with the WIFI transmitter according to FCC KDB Publication 447498 D01v06 publication procedures. The "Portable Hotspot" feature on the handset was NOT activated during SAR assessments, to ensure the SAR measurements were evaluated for a single transmission frequency RF signal at a time.

### **13. Conducted RF Output Power (Unit: dBm)**

The detailed conducted power table can refer to Appendix E.

#### **<GSM Conducted Power>**

1. Per KDB 447498 D01v06, the maximum output power channel is used for SAR testing and for further SAR test reduction.
2. Per KDB 941225 D01v03r01, for SAR test reduction for GSM / GPRS / EDGE modes is determined by the source-based time-averaged output power including tune-up tolerance. The mode with highest specified time-averaged output power should be tested for SAR compliance in the applicable exposure conditions. For modes with the same specified maximum output power and tolerance, the higher number time-slot configuration should be tested. Therefore, the GPRS 2Tx slots for GSM850 and GSM1900 are considered as the primary mode.
3. Other configurations of GSM / GPRS / EDGE are considered as secondary modes. The 3G SAR test reduction procedure is applied, when the maximum output power and tune-up tolerance specified for production units in a secondary mode is  $\leq 1/4$  dB higher than the primary mode, SAR measurement is not required for the secondary mode.

#### **<WCDMA Conducted Power>**

1. The following tests were conducted according to the test requirements outlines in 3GPP TS 34.121 specification.
2. The procedures in KDB 941225 D01v03r01 are applied for 3GPP Rel. 6 HSPA to configure the device in the required sub-test mode(s) to determine SAR test exclusion.
3. For DC-HSDPA, the device was configured according to the H-Set 12, Fixed Reference Channel (FRC) configuration in Table C.8.1.12 of 3GPP TS 34.121-1, with the primary and the secondary serving HS-DSCH Cell enabled during the power measurement.

A summary of these settings are illustrated below:

#### **HSDPA Setup Configuration:**

- a. The EUT was connected to Base Station Agilent E5515C referred to the Setup Configuration.
- b. The RF path losses were compensated into the measurements.
- c. A call was established between EUT and Base Station with following setting:
  - i. Set Gain Factors ( $\beta_c$  and  $\beta_d$ ) and parameters were set according to each
  - ii. Specific sub-test in the following table, C10.1.4, quoted from the TS 34.121
  - iii. Set RMC 12.2Kbps + HSDPA mode.
  - iv. Set Cell Power = -86 dBm
  - v. Set HS-DSCH Configuration Type to FRC (H-set 1, QPSK)
  - vi. Select HSDPA Uplink Parameters
  - vii. Set Delta ACK, Delta NACK and Delta CQI = 8
  - viii. Set Ack-Nack Repetition Factor to 3
  - ix. Set CQI Feedback Cycle (k) to 4 ms
  - x. Set CQI Repetition Factor to 2
  - xi. Power Ctrl Mode = All Up bits
- d. The transmitted maximum output power was recorded.

**Table C.10.1.4:  $\beta$  values for transmitter characteristics tests with HS-DPCCH**

Sub-test	$\beta_c$	$\beta_d$	$\beta_d$ (SF)	$\beta_c/\beta_d$	$\beta_{HS}$ (Note 1, Note 2)	CM (dB) (Note 3)	MPR (dB) (Note 3)
1	2/15	15/15	64	2/15	4/15	0.0	0.0
2	12/15 (Note 4)	15/15 (Note 4)	64	12/15 (Note 4)	24/15	1.0	0.0
3	15/15	8/15	64	15/8	30/15	1.5	0.5
4	15/15	4/15	64	15/4	30/15	1.5	0.5

Note 1:  $\Delta_{ACK}$ ,  $\Delta_{NACK}$  and  $\Delta_{CQI} = 30/15$  with  $\beta_{HS} = 30/15 * \beta_c$ .

Note 2: For the HS-DPCCH power mask requirement test in clause 5.2C, 5.7A, and the Error Vector Magnitude (EVM) with HS-DPCCH test in clause 5.13.1A, and HSDPA EVM with phase discontinuity in clause 5.13.1AA,  $\Delta_{ACK}$  and  $\Delta_{NACK} = 30/15$  with  $\beta_{HS} = 30/15 * \beta_c$ , and  $\Delta_{CQI} = 24/15$  with  $\beta_{HS} = 24/15 * \beta_c$ .

Note 3: CM = 1 for  $\beta_c/\beta_d = 12/15$ ,  $\beta_{HS}/\beta_c = 24/15$ . For all other combinations of DPDCH, DPCCH and HS-DPCCH the MPR is based on the relative CM difference. This is applicable for only UEs that support HSDPA in release 6 and later releases.

Note 4: For subtest 2 the  $\beta_c/\beta_d$  ratio of 12/15 for the TFC during the measurement period (TF1, TF0) is achieved by setting the signalled gain factors for the reference TFC (TF1, TF1) to  $\beta_c = 11/15$  and  $\beta_d = 15/15$ .

**Setup Configuration**

**HSUPA Setup Configuration:**

- a. The EUT was connected to Base Station Agilent E5515C referred to the Setup Configuration.
- b. The RF path losses were compensated into the measurements.
- c. A call was established between EUT and Base Station with following setting \* :
  - i. Call Configs = 5.2B, 5.9B, 5.10B, and 5.13.2B with QPSK
  - ii. Set the Gain Factors ( $\beta_c$  and  $\beta_d$ ) and parameters (AG Index) were set according to each specific sub-test in the following table, C11.1.3, quoted from the TS 34.121
  - iii. Set Cell Power = -86 dBm
  - iv. Set Channel Type = 12.2k + HSPA
  - v. Set UE Target Power
  - vi. Power Ctrl Mode= Alternating bits
  - vii. Set and observe the E-TFCI
  - viii. Confirm that E-TFCI is equal to the target E-TFCI of 75 for sub-test 1, and other subtest's E-TFCI
- d. The transmitted maximum output power was recorded.

**Table C.11.1.3:  $\beta$  values for transmitter characteristics tests with HS-DPCCH and E-DCH**

Sub-test	$\beta_c$	$\beta_d$	$\beta_d$ (SF)	$\beta_c/\beta_d$	$\beta_{HS}$ (Note1)	$\beta_{ec}$	$\beta_{ed}$ (Note 4) (Note 5)	$\beta_{ed}$ (SF)	$\beta_{ed}$ (Codes)	CM (dB) (Note 2)	MPR (dB) (Note 2) (Note 6)	AG Index (Note 5)	E-TFCI
1	11/15 (Note 3)	15/15 (Note 3)	64	11/15 (Note 3)	22/15	209/25	1309/225	4	1	1.0	0.0	20	75
2	6/15	15/15	64	6/15	12/15	12/15	94/75	4	1	3.0	2.0	12	67
3	15/15	9/15	64	15/9	30/15	30/15	$\beta_{ed1}$ : 47/15 $\beta_{ed2}$ : 47/15	4 4	2	2.0	1.0	15	92
4	2/15	15/15	64	2/15	4/15	2/15	56/75	4	1	3.0	2.0	17	71
5	15/15	0	-	-	5/15	5/15	47/15	4	1	1.0	0.0	12	67

Note 1: For sub-test 1 to 4,  $\Delta_{ACK}$ ,  $\Delta_{NACK}$  and  $\Delta_{CQI} = 30/15$  with  $\beta_{hs} = 30/15 * \beta_c$ . For sub-test 5,  $\Delta_{ACK}$ ,  $\Delta_{NACK}$  and  $\Delta_{CQI} = 5/15$  with  $\beta_{hs} = 5/15 * \beta_c$ .

Note 2: CM = 1 for  $\beta_c/\beta_d = 12/15$ ,  $\beta_{hs}/\beta_c = 24/15$ . For all other combinations of DPDCH, DPCCH, HS- DPCCH, E-DPDCH and E-DPCCH the MPR is based on the relative CM difference.

Note 3: For subtest 1 the  $\beta_c/\beta_d$  ratio of 11/15 for the TFC during the measurement period (TF1, TF0) is achieved by setting the signalled gain factors for the reference TFC (TF1, TF1) to  $\beta_c = 10/15$  and  $\beta_d = 15/15$ .

Note 4: In case of testing by UE using E-DPDCH Physical Layer category 1, Sub-test 3 is omitted according to TS25.306 Table 5.1g.

Note 5:  $\beta_{ed}$  can not be set directly; it is set by Absolute Grant Value.

Note 6: For subtests 2, 3 and 4, UE may perform E-DPDCH power scaling at max power which could results in slightly smaller MPR values.

**Setup Configuration**

**DC-HSDPA 3GPP release 8 Setup Configuration:**

- a. The EUT was connected to Base Station referred to the Setup Configuration below
- b. The RF path losses were compensated into the measurements.
- c. A call was established between EUT and Base Station with following setting:
  - i. Set RMC 12.2Kbps + HSDPA mode.
  - ii. Set Cell Power = -25 dBm
  - iii. Set HS-DSCH Configuration Type to FRC (H-set 12, QPSK)
  - iv. Select HSDPA Uplink Parameters
  - v. Set Gain Factors ( $\beta_c$  and  $\beta_d$ ) and parameters were set according to each Specific sub-test in the following table, C10.1.4, quoted from the TS 34.121
    - a). Subtest 1:  $\beta_c/\beta_d=2/15$
    - b). Subtest 2:  $\beta_c/\beta_d=12/15$
    - c). Subtest 3:  $\beta_c/\beta_d=15/8$
    - d). Subtest 4:  $\beta_c/\beta_d=15/4$
  - vi. Set Delta ACK, Delta NACK and Delta CQI = 8
  - vii. Set Ack-Nack Repetition Factor to 3
  - viii. Set CQI Feedback Cycle (k) to 4 ms
  - ix. Set CQI Repetition Factor to 2
  - x. Power Ctrl Mode = All Up bits
- d. The transmitted maximum output power was recorded.

The following tests were conducted according to the test requirements outlines in 3GPP TS 34.121 specification. A summary of these settings are illustrated below:

**C.8.1.12 Fixed Reference Channel Definition H-Set 12**

**Table C.8.1.12: Fixed Reference Channel H-Set 12**

Parameter	Unit	Value
Nominal Avg. Inf. Bit Rate	kbps	60
Inter-TTI Distance	TTI's	1
Number of HARQ Processes	Processes	6
Information Bit Payload ( $N_{INF}$ )	Bits	120
Number Code Blocks	Blocks	1
Binary Channel Bits Per TTI	Bits	960
Total Available SML's in UE	SML's	19200
Number of SML's per HARQ Proc.	SML's	3200
Coding Rate		0.15
Number of Physical Channel Codes	Codes	1
Modulation		QPSK
Note 1: The RMC is intended to be used for DC-HSDPA mode and both cells shall transmit with identical parameters as listed in the table. Note 2: Maximum number of transmission is limited to 1, i.e., retransmission is not allowed. The redundancy and constellation version 0 shall be used.		

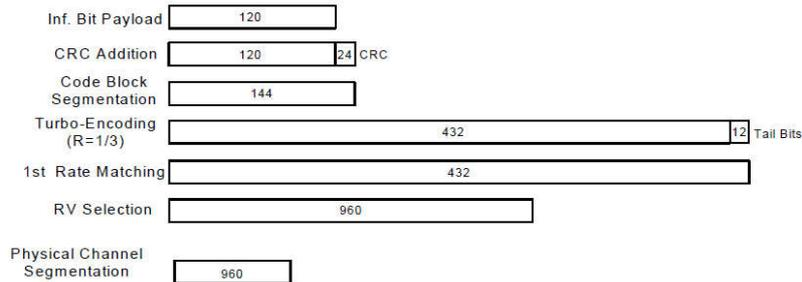

**Figure C.8.19: Coding rate for Fixed reference Channel H-Set 12 (QPSK)**

**Setup Configuration**

**HSPA+ 3GPP release 7 (uplink category 7) 16QAM, Setup Configuration:**

- a. The EUT was connected to Base Station Agilent E5515C referred to the Setup Configuration.
- b. The RF path losses were compensated into the measurements.
- c. A call was established between EUT and Base Station with following setting \* :
  - i. Call Configs = 5.2E:HSPA+:UL with 16QAM
  - ii. Set the Gain Factors ( $\beta_c$  and  $\beta_d$ ) and parameters (AG Index) were set according to each specific sub-test in the following table, C11.1.4, quoted from the TS 34.121-1 s5.2E
  - iii. Set Channel Parm
  - iv. Set Cell Power = -86 dBm
  - v. Set Channel Type = HSPA
  - vi. Set UE Target Power =21 dBm
  - vii. Power Ctrl Mode= All Up Bits
  - viii. Set Manual Uplink DPCH Bc/Bd = Manual
  - ix. Set Manual Uplink DPCH Bc and Bd=15,15(for 34.121-1 v8.10.0 table C11.1.4 sub-test 1)
  - x. Set HSPA Conn DL Channel Levels
  - xi. Set HS-SCCH Configs
  - xii. Set RB Test Mode Setup
  - xiii. Set Common HSUPA Parameters
  - xiv. Set Serving Grant
  - xv. Confirm that E-TFCI is equal to the target E-TFCI of 105 for sub-test 1, and other subtest's E-TFCI
- d. The transmitted maximum output power was recorded.

**Table C.11.1.4:  $\beta$  values for transmitter characteristics tests with HS-DPCCH and E-DCH with 16QAM**

Sub-test	$\beta_c$ (Note3)	$\beta_d$	$\beta_{HS}$ (Note1)	$\beta_{ec}$	$\beta_{ed}$ (2xSF2) (Note 4)	$\beta_{ed}$ (2xSF4) (Note 4)	CM (dB) (Note 2)	MPR (dB) (Note 2)	AG Index (Note 4)	E-TFCI (Note 5)	E-TFCI (boost)
1	1	0	30/15	30/15	$\beta_{ed1}$ : 30/15 $\beta_{ed2}$ : 30/15	$\beta_{ed3}$ : 24/15 $\beta_{ed4}$ : 24/15	3.5	2.5	14	105	105

Note 1:  $\Delta_{ACK}, \Delta_{NACK}$  and  $\Delta_{CQI} = 30/15$  with  $\beta_{fs} = 30/15 * \beta_c$ .

Note 2: CM = 3.5 and the MPR is based on the relative CM difference, MPR = MAX(CM-1,0).

Note 3: DPDCH is not configured, therefore the  $\beta_c$  is set to 1 and  $\beta_d = 0$  by default.

Note 4:  $\beta_{ed}$  can not be set directly; it is set by Absolute Grant Value.

Note 5: All the sub-tests require the UE to transmit 2SF2+2SF4 16QAM EDCH and they apply for UE using E-DPDCH category 7. E-DCH TTI is set to 2ms TTI and E-DCH table index = 2. To support these E-DCH configurations DPDCH is not allocated. The UE is signaled to use the extrapolation algorithm.

**Setup Configuration**



**<WCDMA Conducted Power>**

**General Note:**

1. Per KDB 941225 D01v03r01, for SAR testing is measured using a 12.2 kbps RMC with TPC bits configured to all "1's".
2. Per KDB 941225 D01v03r01, RMC 12.2kbps setting is used to evaluate SAR. The maximum output power and tune-up tolerance specified for production units in HSDPA / HSUPA / DC-HSDPA/ HSPA+ is  $\leq \frac{1}{4}$  dB higher than RMC 12.2Kbps or when the highest reported SAR of the RMC12.2Kbps is scaled by the ratio of specified maximum output power and tune-up tolerance of HSDPA / HSUPA / DC-HSDPA/ HSPA+ to RMC12.2Kbps and the adjusted SAR is  $\leq 1.2$  W/kg, SAR measurement is not required for HSDPA / HSUPA / DC-HSDPA/ HSPA+, and according to the following RF output power, the output power results of the secondary modes (HSDPA / HSUPA / DC-HSDPA/ HSPA+) are less than  $\frac{1}{4}$  dB higher than the primary modes; therefore, SAR measurement is not required for HSDPA / HSUPA / DC-HSDPA/ HSPA+

**<LTE Conducted Power>**

**General Note:**

1. Anritsu MT8820C base station simulator was used to setup the connection with EUT; the frequency band, channel bandwidth, RB allocation configuration, modulation type are set in the base station simulator to configure EUT transmitting at maximum power and at different configurations which are requested to be reported to FCC, for conducted power measurement and SAR testing.
2. Per KDB 941225 D05v02r05, when a properly configured base station simulator is used for the SAR and power measurements, spectrum plots for each RB allocation and offset configuration is not required.
3. Per KDB 941225 D05v02r05, start with the largest channel bandwidth and measure SAR for QPSK with 1 RB allocation, using the RB offset and required test channel combination with the highest maximum output power for RB offsets at the upper edge, middle and lower edge of each required test channel.
4. Per KDB 941225 D05v02r05, 50% RB allocation for QPSK SAR testing follows 1RB QPSK allocation procedure.
5. Per KDB 941225 D05v02r05, for QPSK with 100% RB allocation, SAR is not required when the highest maximum output power for 100 % RB allocation is less than the highest maximum output power in 50% and 1 RB allocations and the highest reported SAR for 1 RB and 50% RB allocation are  $\leq 0.8$  W/kg. Otherwise, SAR is measured for the highest output power channel; and if the reported SAR is  $> 1.45$  W/kg, the remaining required test channels must also be tested.
6. Per KDB 941225 D05v02r05, 16QAM/64QAM output power for each RB allocation configuration is  $>$  not  $\frac{1}{2}$  dB higher than the same configuration in QPSK and the reported SAR for the QPSK configuration is  $\leq 1.45$  W/kg; Per KDB 941225 D05v02r05, 16QAM/64QAM SAR testing is not required.
7. Per KDB 941225 D05v02r05, smaller bandwidth output power for each RB allocation configuration is  $>$  not  $\frac{1}{2}$  dB higher than the same configuration in the largest supported bandwidth, and the reported SAR for the largest supported bandwidth is  $\leq 1.45$  W/kg; Per KDB 941225 D05v02r05, smaller bandwidth SAR testing is not required.
8. For LTE B4 / B5 / B12 / B26 the maximum bandwidth does not support three non-overlapping channels, per KDB 941225 D05v02r05, when a device supports overlapping channel assignment in a channel bandwidth configuration, the middle channel of the group of overlapping channels should be selected for testing.
9. LTE B4 / B5 SAR test was covered by B66 / B26; according to April 2015 TCB workshop, SAR test for overlapping LTE bands can be reduced if
  - a. the maximum output power, including tolerance, for the smaller band is  $\leq$  the larger band to qualify for the SAR test exclusion
  - b. the channel bandwidth and other operating parameters for the smaller band are fully supported by the larger band
10. According to 2017 TCB workshop, for 64 QAM and 16 QAM should be verified by checking the signal constellation with a call box to avoid incorrect maximum power levels due to MPR and other requirements associated with signal modulation, and the following figure is taken from the "Fundamental Measurement >> Modulation Analysis >> constellation" mode of the device connect to the MT8821C base station, therefore, the device 64QAM and 16QAM signal modulation are correct.

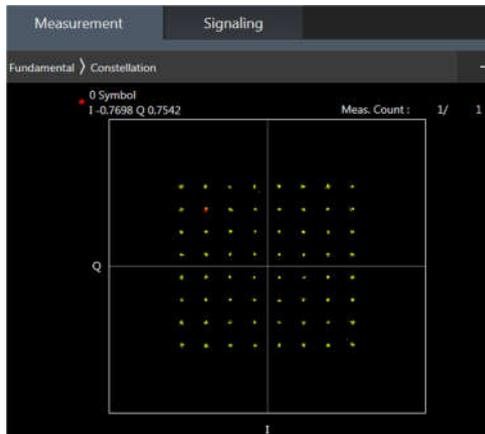

**64QAM**



**16QAM**



**<LTE Carrier Aggregation>**

**General Note:**

- 1. This device supports Carrier Aggregation on downlink for inter and intra band. For the device supports bands and bandwidths and configurations are provided as follow table was according to 3GPP.
- 2. In applying the existing power measurement procedures of KDB 941225 D05A for DL CA SAR test exclusion, only the subset with the largest number of combinations of frequency bands and CCs in each row need combination, and for this device that all the configurations were choose to power measurement.
- 3. All permutations exist. No restrictions on Pcell & Scell combinations.

Index	2CC
2CC #1	CA_2A-4A
2CC #2	CA_2A-5A
2CC #3	CA_2A-7A
2CC #4	CA_4A-4A
2CC #5	CA_4A-5A
2CC #6	CA_4A-7A
2CC #7	CA_4A-12A
2CC #8	CA_5A-7A
2CC #9	CA_5A-66A
2CC #10	CA_7B
2CC #11	CA_7C
2CC #12	CA_7A-7A
2CC #13	CA_12A-66A
2CC #14	CA_66B
2CC #15	CA_66C
2CC #16	CA_66A-66A

**LTE Carrier Aggregation Conducted Power (Downlink)**

- i. According to KDB941225 D05A v01r02, Uplink maximum output power measurement with downlink carrier aggregation active should be measured, using the highest output channel measured without downlink carrier aggregation, to confirm that uplink maximum output power with downlink carrier aggregation active remains within the specified tune-up tolerance limits and not more than ¼ dB higher than the maximum output measured without downlink carrier aggregation active.
- ii. Uplink maximum output power with downlink carrier aggregation active does not show more than ¼ dB higher than the maximum output power without downlink carrier aggregation active, therefore SAR evaluation with downlink carrier aggregation active can be excluded.
- iii. The device supports downlink two carrier aggregation. For power measurement were control and acknowledge data is sent on uplink channels that operate identical to specifications when downlink carrier aggregation is inactive.
- iv. Selected highest measured power when downlink carrier aggregation is inactive for conducted power comparison with downlink carrier aggregation is active, to confirm that when downlink carrier aggregation is active uplink maximum output power remains within the specified tune-up tolerance limits and not more than ¼ dB higher than the maximum output power measured when downlink carrier aggregation inactive.
- v. For inter-band CA, the SCC selected highest bandwidth and near the middle of its transmission band. For SCC DL RB size and offset will base on the PCC corresponding RB allocation.
- vi. For non-contiguous intra-band CA, the SCC selected to provide maximum separation from the PCC and must remain fully within the downlink transmission band.
- vii. For Intra-band, contiguous CA, the downlink channels selected to perform the uplink power measurement must satisfy 3GPP channel spacing (5.4.1A of 3GPP TS 36.521 or equivalent) and channel bandwidth (5.4.2A) requirements.

$$\text{Nominal channel spacing} = \left\lceil \frac{BW_{\text{Channel}(1)} + BW_{\text{Channel}(2)} - 0.1|BW_{\text{Channel}(1)} - BW_{\text{Channel}(2)}|}{0.6} \right\rceil 0.3 \text{ [MHz]}$$



**<WLAN Conducted Power>**

**General Note:**

1. Per KDB 248227 D01v02r02, SAR test reduction is determined according to 802.11 transmission mode configurations and certain exposure conditions with multiple test positions. In the 2.4 GHz band, separate SAR procedures are applied to DSSS and OFDM configurations to simplify DSSS test requirements. For OFDM, in both 2.4 and 5 GHz bands, an initial test configuration must be determined for each standalone and aggregated frequency band, according to the transmission mode configuration with the highest maximum output power specified for production units to perform SAR measurements. If the same highest maximum output power applies to different combinations of channel bandwidths, modulations and data rates, additional procedures are applied to determine which test configurations require SAR measurement. When applicable, an initial test position may be applied to reduce the number of SAR measurements required for next to the ear, UMPC mini-tablet or hotspot mode configurations with multiple test positions.
2. For 2.4 GHz 802.11b DSSS, either the initial test position procedure for multiple exposure test positions or the DSSS procedure for fixed exposure position is applied; these are mutually exclusive. For 2.4 GHz and 5 GHz OFDM configurations, the initial test configuration is applied to measure SAR using either the initial test position procedure for multiple exposure test position configurations or the initial test configuration procedures for fixed exposure test conditions. Based on the reported SAR of the measured configurations and maximum output power of the transmission mode configurations that are not included in the initial test configuration, the subsequent test configuration and initial test position procedures are applied to determine if SAR measurements are required for the remaining OFDM transmission configurations. In general, the number of test channels that require SAR measurement is minimized based on maximum output power measured for the test sample(s).
3. For OFDM transmission configurations in the 2.4 GHz and 5 GHz bands, When the same maximum power is specified for multiple transmission modes in a frequency band, the largest channel bandwidth, lowest order modulation, lowest data rate and lowest order 802.11a/g/n/ac mode is used for SAR measurement, on the highest measured output power channel for each frequency band.
4. DSSS and OFDM configurations are considered separately according to the required SAR procedures. SAR is measured in the initial test position using the 802.11 transmission mode configuration required by the DSSS procedure or initial test configuration and subsequent test configuration(s) according to the OFDM procedures.18 The initial test position procedure is described in the following:
  - a. When the reported SAR of the initial test position is  $\leq 0.4$  W/kg, further SAR measurement is not required for the other test positions in that exposure configuration and 802.11 transmission mode combinations within the frequency band or aggregated band.
  - b. When the reported SAR of the test position is  $> 0.4$  W/kg, SAR is repeated for the 802.11 transmission mode configuration tested in the initial test position to measure the subsequent next closet/smallest test separation distance and maximum coupling test position on the highest maximum output power channel, until the report SAR is  $\leq 0.8$  W/kg or all required test position are tested.
  - c. For all positions/configurations, when the reported SAR is  $> 0.8$  W/kg, SAR is measured for these test positions/configurations on the subsequent next highest measured output power channel(s) until the reported SAR is  $\leq 1.2$  W/kg or all required channels are tested.



<2.4GHz Bluetooth>

General Note:

1. For 2.4GHz Bluetooth SAR testing was selected 1Mbps, due to its highest average power.
2. The Bluetooth duty cycle is 76.91 % as following figure, according to 2016 Oct. TCB workshop for Bluetooth SAR scaling need further consideration and the maximum duty cycle is 100%, therefore the actual duty cycle will be scaled up to100% for Bluetooth reported SAR calculation

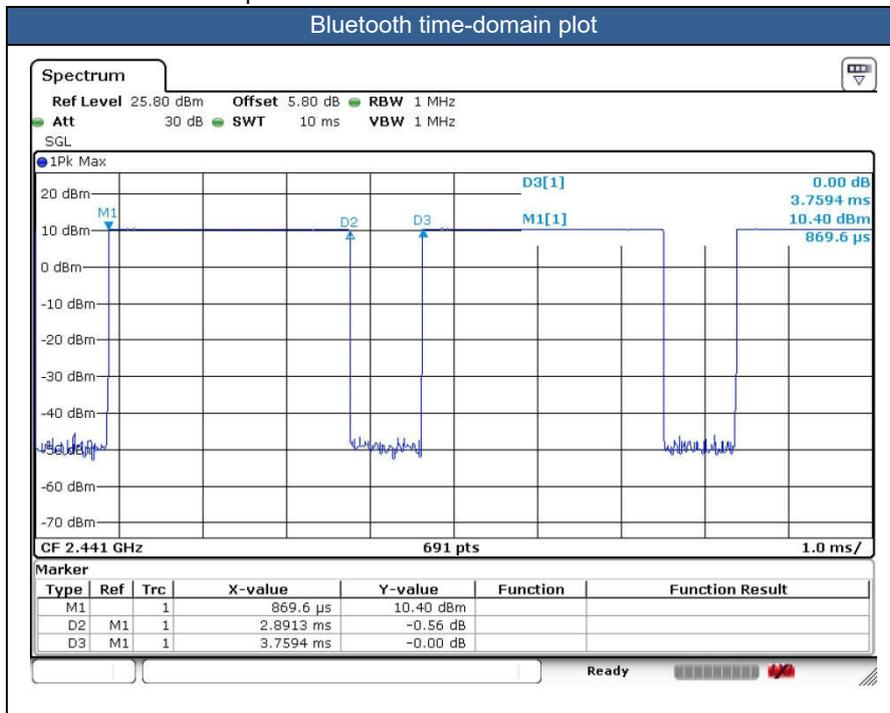



## **14. Antenna Location**

The detailed antenna location information can refer to SAR Test Setup Photos.

## 15. SAR Test Results

### General Note:

1. Per KDB 447498 D01v06, the reported SAR is the measured SAR value adjusted for maximum tune-up tolerance.
  - a. Tune-up scaling Factor = tune-up limit power (mW) / EUT RF power (mW), where tune-up limit is the maximum rated power among all production units.
  - b. For SAR testing of BT/WLAN signal with non-100% duty cycle, the measured SAR is scaled-up by the duty cycle scaling factor which is equal to "1/(duty cycle)"
  - c. For WWAN: Reported SAR(W/kg)= Measured SAR(W/kg)\*Tune-up Scaling Factor
  - d. For BT/WLAN: Reported SAR(W/kg)= Measured SAR(W/kg)\* Duty Cycle scaling factor \* Tune-up scaling factor
2. Per KDB 447498 D01v06, for each exposure position, testing of other required channels within the operating mode of a frequency band is not required when the *reported* 1-g or 10-g SAR for the mid-band or highest output power channel is:
  - $\leq 0.8$  W/kg or 2.0 W/kg, for 1-g or 10-g respectively, when the transmission band is  $\leq 100$  MHz
  - $\leq 0.6$  W/kg or 1.5 W/kg, for 1-g or 10-g respectively, when the transmission band is between 100 MHz and 200 MHz
  - $\leq 0.4$  W/kg or 1.0 W/kg, for 1-g or 10-g respectively, when the transmission band is  $\geq 200$  MHz
3. Per KDB 865664 D01v01r04, for each frequency band, repeated SAR measurement is required when the measured SAR is  $\geq 0.8$ W/kg. Per KDB 865664 D01v01r04, if the extremity repeated SAR is necessary, the same procedures should be adapted for measurements according to extremity and occupational exposure limits by applying a factor of 2.5 for extremity exposure and a factor of 5 for occupational exposure to the corresponding SAR thresholds.
4. The device implements the power management and proximity sensor detection/hotspot mode for SAR compliance at different exposure conditions (body-worn, hotspot, extremity) and the details about the power management decision and sensor detection are provided in the operational description. And the device will invoke corresponding work scenarios power level base on frequency bands/antennas, which can refer to power table at appendix E.
5. For some WWAN bands, sensor on reduced power level is higher than hotspot reduced power level, so front/back sensor on SAR can represent hotspot conservatively.
6. There are two different types of EUT. They are single SIM card mobile and dual SIM card mobile. The others are the same including circuit design, PCB board, structure and all components. It is special to declare. For dual SIM card mobile has two SIM slots and supports dual SIM dual standby. The WWAN radio transmission will be enabled by either one SIM at a time (single active).
7. There are four samples. Please refer to the XT2167-1\_Operational Description of Product Equality Declaration exhibit submitted. According to the difference, we chose sample 1 to perform full SAR testing and sample 2 verified the worst case of sample 1. For sample 3/4, the differences do not affect the test, so sample 3/4 are not tested.
8. There are four headsets, only supplier different, we chose headset 1/2/3/4 to perform full SAR testing.
9. Per KDB648474 D04v01r03, for smart phones with a display diagonal dimension  $> 15.0$  cm or an overall diagonal dimension  $> 16.0$  cm, when hotspot mode applies, 10-g extremity SAR is required only for the surfaces and edges with hotspot mode 1-g reported SAR  $> 1.2$  W/kg, however, when power reduction applies to hotspot mode the measured SAR must be scaled to the maximum output power, including tolerance, allowed for phablet modes to compare with the 1.2 W/kg SAR test reduction threshold.
  - a. For this device SAR for WWAN transmitter scaled to maximum output power mode for product specific 10g SAR is higher than 1.2W/kg of GSM1900, WCDMA Band II/IV, LTE Band2/4/7/66, therefore product specific 10g SAR is necessary.
  - b. WLAN 5.3/5.5GHz tested the product specific 10g SAR since it has no hotspot mode.
  - c. When 10-g product specific 10g SAR is considered, SAR thresholds is specified in the procedures for SAR test reduction and exclusion should be multiplied by 2.5.
10. For WLAN distance SAR test at Front 14mm and Back 19mm is only for simultaneous transmission analysis with WWAN.

**GSM Note:**

1. Per KDB 941225 D01v03r01, for SAR test reduction for GSM / GPRS / EDGE modes is determined by the source-based time-averaged output power including tune-up tolerance. The mode with highest specified time-averaged output power should be tested for SAR compliance in the applicable exposure conditions. For modes with the same specified maximum output power and tolerance, the higher number time-slot configuration should be tested. Therefore, the GPRS 2Tx slots for GSM850 and GSM1900 are considered as the primary mode.
2. Other configurations of GSM / GPRS / EDGE are considered as secondary modes. The 3G SAR test reduction procedure is applied, when the maximum output power and tune-up tolerance specified for production units in a secondary mode is  $\leq \frac{1}{4}$  dB higher than the primary mode, SAR measurement is not required for the secondary mode.

**WCDMA Note:**

1. Per KDB 941225 D01v03r01, for SAR testing is measured using a 12.2 kbps RMC with TPC bits configured to all "1's".
2. Per KDB 941225 D01v03r01, RMC 12.2kbps setting is used to evaluate SAR. The maximum output power and tune-up tolerance specified for production units in HSDPA / HSUPA / DC-HSDPA / HSPA+ is  $\leq \frac{1}{4}$  dB higher than RMC 12.2Kbps or when the highest reported SAR of the RMC12.2Kbps is scaled by the ratio of specified maximum output power and tune-up tolerance of HSDPA / HSUPA / DC-HSDPA / HSPA+ to RMC12.2Kbps and the adjusted SAR is  $\leq 1.2$  W/kg, SAR measurement is not required for HSDPA / HSUPA / DC-HSDPA / HSPA+, and according to the following RF output power, the output power results of the secondary modes (HSDPA / HSUPA / DC-HSDPA / HSPA+) are less than  $\frac{1}{4}$  dB higher than the primary modes; therefore, SAR measurement is not required for HSDPA / HSUPA / DC-HSDPA / HSPA+.

**LTE Note:**

1. Per KDB 941225 D05v02r05, start with the largest channel bandwidth and measure SAR for QPSK with 1 RB allocation, using the RB offset and required test channel combination with the highest maximum output power for RB offsets at the upper edge, middle and lower edge of each required test channel.
2. Per KDB 941225 D05v02r05, 50% RB allocation for QPSK SAR testing follows 1RB QPSK allocation procedure.
3. Per KDB 941225 D05v02r05, for QPSK with 100% RB allocation, SAR is not required when the highest maximum output power for 100 % RB allocation is less than the highest maximum output power in 50% and 1 RB allocations and the highest reported SAR for 1 RB and 50% RB allocation are  $\leq 0.8$  W/kg. Otherwise, SAR is measured for the highest output power channel; and if the reported SAR is  $> 1.45$  W/kg, the remaining required test channels must also be tested.
4. Per KDB 941225 D05v02r05, 16QAM/64QAM output power for each RB allocation configuration is  $>$  not  $\frac{1}{2}$  dB higher than the same configuration in QPSK and the reported SAR for the QPSK configuration is  $\leq 1.45$  W/kg; Per KDB 941225 D05v02r05, 16QAM/64QAM SAR testing is not required.
5. Per KDB 941225 D05v02r05, smaller bandwidth output power for each RB allocation configuration is  $>$  not  $\frac{1}{2}$  dB higher than the same configuration in the largest supported bandwidth, and the reported SAR for the largest supported bandwidth is  $\leq 1.45$  W/kg; Per KDB 941225 D05v02r05, smaller bandwidth SAR testing is not required.
6. For LTE B4 / B5 / B12 / B26 the maximum bandwidth does not support three non-overlapping channels, per KDB 941225 D05v02r05, when a device supports overlapping channel assignment in a channel bandwidth configuration, the middle channel of the group of overlapping channels should be selected for testing.
7. LTE B4 / B5 SAR test was covered by B66 / B26; according to April 2015 TCB workshop, SAR test for overlapping LTE bands can be reduced if
  - a. the maximum output power, including tolerance, for the smaller band is  $\leq$  the larger band to qualify for the SAR test exclusion
  - b. the channel bandwidth and other operating parameters for the smaller band are fully supported by the larger band



**WLAN Note:**

1. Per KDB 248227 D01v02r02, for 2.4GHz 802.11g/n SAR testing is not required when the highest reported SAR for DSSS is adjusted by the ratio of OFDM to DSSS specified maximum output power and the adjusted SAR is  $\leq 1.2$  W/kg.
2. Per KDB 248227 D01v02r02, U-NII-1 SAR testing is not required when the U-NII-2A band highest reported SAR for a test configuration is  $\leq 1.2$  W/kg, SAR is not required for U-NII-1 band.
3. When the reported SAR of the test position is  $> 0.4$  W/kg, SAR is repeated for the 802.11 transmission mode configuration tested in the initial test position to measure the subsequent next closet/smallest test separation distance and maximum coupling test position on the highest maximum output power channel, until the report SAR is  $\leq 0.8$  W/kg or all required test position are tested.
4. For all positions / configurations, when the reported SAR is  $> 0.8$  W/kg, SAR is measured for these test positions / configurations on the subsequent next highest measured output power channel(s) until the reported SAR is  $\leq 1.2$  W/kg or all required channels are tested.
5. During SAR testing the WLAN transmission was verified using a spectrum analyzer.



15.1 Head SAR

<GSM SAR>

Plot No.	Band	Mode	Test Position	Gap (mm)	Sample	Power Reduction	Ch.	Freq. (MHz)	Average Power (dBm)	Tune-Up Limit (dBm)	Tune-up Scaling Factor	Power Drift (dB)	Measured 1g SAR (W/kg)	Reported 1g SAR (W/kg)
01	GSM850	GPRS (2 Tx slots)	Right Cheek	0mm	1	Full	189	836.4	30.15	31.00	1.216	-0.02	0.364	0.443
	GSM850	GPRS (2 Tx slots)	Right Tilted	0mm	1	Full	189	836.4	30.15	31.00	1.216	0.03	0.260	0.316
	GSM850	GPRS (2 Tx slots)	Left Cheek	0mm	1	Full	189	836.4	30.15	31.00	1.216	0.01	0.353	0.429
	GSM850	GPRS (2 Tx slots)	Left Tilted	0mm	1	Full	189	836.4	30.15	31.00	1.216	0.07	0.211	0.257
02	GSM1900	GPRS (2 Tx slots)	Right Cheek	0mm	1	Full	661	1880	26.30	27.50	1.318	-0.02	0.073	0.096
	GSM1900	GPRS (2 Tx slots)	Right Tilted	0mm	1	Full	661	1880	26.30	27.50	1.318	0.03	0.058	0.076
	GSM1900	GPRS (2 Tx slots)	Left Cheek	0mm	1	Full	661	1880	26.30	27.50	1.318	0.01	0.070	0.092
	GSM1900	GPRS (2 Tx slots)	Left Tilted	0mm	1	Full	661	1880	26.30	27.50	1.318	0.05	0.067	0.088

<WCDMA SAR>

Plot No.	Band	Mode	Test Position	Gap (mm)	Sample	Power Reduction	Ch.	Freq. (MHz)	Average Power (dBm)	Tune-Up Limit (dBm)	Tune-up Scaling Factor	Power Drift (dB)	Measured 1g SAR (W/kg)	Reported 1g SAR (W/kg)
	WCDMA II	RMC 12.2Kbps	Right Cheek	0mm	1	Full	9400	1880	22.75	24.00	1.334	0.03	0.104	0.139
	WCDMA II	RMC 12.2Kbps	Right Tilted	0mm	1	Full	9400	1880	22.75	24.00	1.334	0.04	0.077	0.103
03	WCDMA II	RMC 12.2Kbps	Left Cheek	0mm	1	Full	9400	1880	22.75	24.00	1.334	0.07	0.108	0.144
	WCDMA II	RMC 12.2Kbps	Left Tilted	0mm	1	Full	9400	1880	22.75	24.00	1.334	0.01	0.106	0.141
04	WCDMA IV	RMC 12.2Kbps	Right Cheek	0mm	1	Full	1413	1732.6	22.65	24.00	1.365	-0.06	0.244	0.333
	WCDMA IV	RMC 12.2Kbps	Right Tilted	0mm	1	Full	1413	1732.6	22.65	24.00	1.365	0.03	0.160	0.218
	WCDMA IV	RMC 12.2Kbps	Left Cheek	0mm	1	Full	1413	1732.6	22.65	24.00	1.365	0.02	0.204	0.278
	WCDMA IV	RMC 12.2Kbps	Left Tilted	0mm	1	Full	1413	1732.6	22.65	24.00	1.365	0.04	0.158	0.216
05	WCDMA V	RMC 12.2Kbps	Right Cheek	0mm	1	Full	4182	836.4	22.63	24.00	1.371	0.02	0.374	0.513
	WCDMA V	RMC 12.2Kbps	Right Tilted	0mm	1	Full	4182	836.4	22.63	24.00	1.371	0.06	0.270	0.370
	WCDMA V	RMC 12.2Kbps	Left Cheek	0mm	1	Full	4182	836.4	22.63	24.00	1.371	0.07	0.367	0.503
	WCDMA V	RMC 12.2Kbps	Left Tilted	0mm	1	Full	4182	836.4	22.63	24.00	1.371	0.02	0.227	0.311

<FDD LTE SAR>

Plot No.	Band	BW (MHz)	Modulation	RB Size	RB offset	Test Position	Gap (mm)	Sample	Power Reduction	Ch.	Freq. (MHz)	Average Power (dBm)	Tune-Up Limit (dBm)	Tune-up Scaling Factor	Power Drift (dB)	Measured 1g SAR (W/kg)	Reported 1g SAR (W/kg)
	LTE Band 2	20M	QPSK	1	0	Right Cheek	0mm	1	Full	18900	1880	23.19	24.00	1.205	-0.03	0.122	0.147
	LTE Band 2	20M	QPSK	50	0	Right Cheek	0mm	1	Full	18900	1880	22.07	23.00	1.239	0.01	0.114	0.141
	LTE Band 2	20M	QPSK	1	0	Right Tilted	0mm	1	Full	18900	1880	23.19	24.00	1.205	0.05	0.106	0.128
	LTE Band 2	20M	QPSK	50	0	Right Tilted	0mm	1	Full	18900	1880	22.07	23.00	1.239	0.03	0.087	0.108
	LTE Band 2	20M	QPSK	1	0	Left Cheek	0mm	1	Full	18900	1880	23.19	24.00	1.205	0.04	0.122	0.147
	LTE Band 2	20M	QPSK	50	0	Left Cheek	0mm	1	Full	18900	1880	22.07	23.00	1.239	0.03	0.105	0.130
06	LTE Band 2	20M	QPSK	1	0	Left Tilted	0mm	1	Full	18900	1880	23.19	24.00	1.205	0.02	0.132	0.159
	LTE Band 2	20M	QPSK	50	0	Left Tilted	0mm	1	Full	18900	1880	22.07	23.00	1.239	-0.02	0.104	0.129
	LTE Band 7	20M	QPSK	1	0	Right Cheek	0mm	1	Full	21100	2535	22.98	24.00	1.265	0.03	0.378	0.478
	LTE Band 7	20M	QPSK	50	0	Right Cheek	0mm	1	Full	21100	2535	21.86	23.00	1.300	0.04	0.326	0.424
	LTE Band 7	20M	QPSK	1	0	Right Tilted	0mm	1	Full	21100	2535	22.98	24.00	1.265	0.09	0.292	0.369
	LTE Band 7	20M	QPSK	50	0	Right Tilted	0mm	1	Full	21100	2535	21.86	23.00	1.300	0.04	0.257	0.334
	LTE Band 7	20M	QPSK	1	0	Left Cheek	0mm	1	Full	21100	2535	22.98	24.00	1.265	-0.09	0.638	0.807
	LTE Band 7	20M	QPSK	1	0	Left Cheek	0mm	1	Full	20850	2510	22.87	24.00	1.297	0.05	0.633	0.821
07	LTE Band 7	20M	QPSK	1	0	Left Cheek	0mm	1	Full	21350	2560	22.80	24.00	1.318	0.07	0.625	0.824
	LTE Band 7	20M	QPSK	50	0	Left Cheek	0mm	1	Full	21100	2535	21.86	23.00	1.300	0.02	0.530	0.689
	LTE Band 7	20M	QPSK	100	0	Left Cheek	0mm	1	Full	21100	2535	21.87	23.00	1.297	0.03	0.452	0.586
	LTE Band 7	20M	QPSK	1	0	Left Tilted	0mm	1	Full	21100	2535	22.98	24.00	1.265	0.04	0.274	0.347
	LTE Band 7	20M	QPSK	50	0	Left Tilted	0mm	1	Full	21100	2535	21.86	23.00	1.300	0.09	0.210	0.273



08	LTE Band 12	10M	QPSK	1	0	Right Cheek	0mm	1	Full	23095	707.5	22.88	24.00	1.294	-0.07	0.395	<b>0.511</b>
	LTE Band 12	10M	QPSK	25	0	Right Cheek	0mm	1	Full	23095	707.5	21.81	23.00	1.315	0.03	0.318	0.418
	LTE Band 12	10M	QPSK	1	0	Right Tilted	0mm	1	Full	23095	707.5	22.88	24.00	1.294	0.02	0.257	0.333
	LTE Band 12	10M	QPSK	25	0	Right Tilted	0mm	1	Full	23095	707.5	21.81	23.00	1.315	0.01	0.208	0.274
	LTE Band 12	10M	QPSK	1	0	Left Cheek	0mm	1	Full	23095	707.5	22.88	24.00	1.294	0.06	0.359	0.465
	LTE Band 12	10M	QPSK	25	0	Left Cheek	0mm	1	Full	23095	707.5	21.81	23.00	1.315	0.07	0.285	0.375
	LTE Band 12	10M	QPSK	1	0	Left Tilted	0mm	1	Full	23095	707.5	22.88	24.00	1.294	0.09	0.206	0.267
	LTE Band 12	10M	QPSK	25	0	Left Tilted	0mm	1	Full	23095	707.5	21.81	23.00	1.315	0.05	0.163	0.214
09	LTE Band 13	10M	QPSK	1	0	Right Cheek	0mm	1	Full	23230	782	22.89	24.00	1.291	0.03	0.299	<b>0.386</b>
	LTE Band 13	10M	QPSK	25	0	Right Cheek	0mm	1	Full	23230	782	21.74	23.00	1.337	0.06	0.236	0.315
	LTE Band 13	10M	QPSK	1	0	Right Tilted	0mm	1	Full	23230	782	22.89	24.00	1.291	0.01	0.235	0.303
	LTE Band 13	10M	QPSK	25	0	Right Tilted	0mm	1	Full	23230	782	21.74	23.00	1.337	0.07	0.186	0.249
	LTE Band 13	10M	QPSK	1	0	Left Cheek	0mm	1	Full	23230	782	22.89	24.00	1.291	-0.06	0.274	0.354
	LTE Band 13	10M	QPSK	25	0	Left Cheek	0mm	1	Full	23230	782	21.74	23.00	1.337	0.07	0.219	0.293
	LTE Band 13	10M	QPSK	1	0	Left Tilted	0mm	1	Full	23230	782	22.89	24.00	1.291	0.05	0.189	0.244
	LTE Band 13	10M	QPSK	25	0	Left Tilted	0mm	1	Full	23230	782	21.74	23.00	1.337	0.01	0.150	0.200
10	LTE Band 26	15M	QPSK	1	0	Right Cheek	0mm	1	Full	26865	831.5	23.05	24.00	1.245	0.06	0.392	<b>0.488</b>
	LTE Band 26	15M	QPSK	36	0	Right Cheek	0mm	1	Full	26865	831.5	21.92	23.00	1.282	-0.02	0.315	0.404
	LTE Band 26	15M	QPSK	1	0	Right Tilted	0mm	1	Full	26865	831.5	23.05	24.00	1.245	0.01	0.286	0.356
	LTE Band 26	15M	QPSK	36	0	Right Tilted	0mm	1	Full	26865	831.5	21.92	23.00	1.282	0.06	0.229	0.294
	LTE Band 26	15M	QPSK	1	0	Left Cheek	0mm	1	Full	26865	831.5	23.05	24.00	1.245	0.07	0.382	0.475
	LTE Band 26	15M	QPSK	36	0	Left Cheek	0mm	1	Full	26865	831.5	21.92	23.00	1.282	0.09	0.305	0.391
	LTE Band 26	15M	QPSK	1	0	Left Tilted	0mm	1	Full	26865	831.5	23.05	24.00	1.245	0.02	0.229	0.285
	LTE Band 26	15M	QPSK	36	0	Left Tilted	0mm	1	Full	26865	831.5	21.92	23.00	1.282	0.04	0.182	0.233
11	LTE Band 66	20M	QPSK	1	0	Right Cheek	0mm	1	Full	132322	1745	22.85	24.00	1.303	0.01	0.250	<b>0.326</b>
	LTE Band 66	20M	QPSK	50	0	Right Cheek	0mm	1	Full	132322	1745	21.68	23.00	1.355	-0.03	0.221	0.299
	LTE Band 66	20M	QPSK	1	0	Right Tilted	0mm	1	Full	132322	1745	22.85	24.00	1.303	0.02	0.160	0.209
	LTE Band 66	20M	QPSK	50	0	Right Tilted	0mm	1	Full	132322	1745	21.68	23.00	1.355	0.08	0.139	0.188
	LTE Band 66	20M	QPSK	1	0	Left Cheek	0mm	1	Full	132322	1745	22.85	24.00	1.303	0.09	0.212	0.276
	LTE Band 66	20M	QPSK	50	0	Left Cheek	0mm	1	Full	132322	1745	21.68	23.00	1.355	0.04	0.187	0.253
	LTE Band 66	20M	QPSK	1	0	Left Tilted	0mm	1	Full	132322	1745	22.85	24.00	1.303	0.06	0.175	0.228
	LTE Band 66	20M	QPSK	50	0	Left Tilted	0mm	1	Full	132322	1745	21.68	23.00	1.355	0.02	0.157	0.213

<WLAN2.4G SAR>

Plot No.	Band	Mode	Test Position	Gap (mm)	Sample	Power Reduction	Ch.	Freq. (MHz)	Average Power (dBm)	Tune-Up Limit (dBm)	Tune-up Scaling Factor	Duty Cycle %	Duty Cycle Scaling Factor	Power Drift (dB)	Measured 1g SAR (W/kg)	Reported 1g SAR (W/kg)
	WLAN2.4GHz	802.11b 1Mbps	Right Cheek	0mm	1	Full	11	2462	18.43	19.50	1.279	99.31	1.007	0.03	0.250	0.322
	WLAN2.4GHz	802.11b 1Mbps	Right Tilted	0mm	1	Full	11	2462	18.43	19.50	1.279	99.31	1.007	0.01	0.280	0.361
	WLAN2.4GHz	802.11b 1Mbps	Left Cheek	0mm	1	Full	11	2462	18.43	19.50	1.279	99.31	1.007	-0.02	0.429	0.553
12	WLAN2.4GHz	802.11b 1Mbps	Left Tilted	0mm	1	Full	11	2462	18.43	19.50	1.279	99.31	1.007	-0.01	0.630	<b>0.812</b>
	WLAN2.4GHz	802.11b 1Mbps	Left Tilted	0mm	1	Full	1	2412	16.75	18.00	1.334	99.31	1.007	0.09	0.560	0.752

<WLAN5G SAR>

Plot No.	Band	Mode	Test Position	Gap (mm)	Sample	Power Reduction	Ch.	Freq. (MHz)	Average Power (dBm)	Tune-Up Limit (dBm)	Tune-up Scaling Factor	Duty Cycle %	Duty Cycle Scaling Factor	Power Drift (dB)	Measured 1g SAR (W/kg)	Reported 1g SAR (W/kg)
	WLAN5.3GHz	802.11n-HT40 MCS0	Right Cheek	0mm	1	Full	54	5270	17.90	19.00	1.288	93.73	1.067	-0.01	0.519	0.713
	WLAN5.3GHz	802.11n-HT40 MCS0	Right Tilted	0mm	1	Full	54	5270	17.90	19.00	1.288	93.73	1.067	0.03	0.738	1.014
	WLAN5.3GHz	802.11n-HT40 MCS0	Right Tilted	0mm	1	Full	62	5310	13.48	14.50	1.264	93.73	1.067	0.02	0.347	0.468
	WLAN5.3GHz	802.11n-HT40 MCS0	Left Cheek	0mm	1	Full	54	5270	17.90	19.00	1.288	93.73	1.067	0.04	0.495	0.680
13	WLAN5.3GHz	802.11n-HT40 MCS0	Left Tilted	0mm	1	Full	54	5270	17.90	19.00	1.288	93.73	1.067	0.01	0.840	<b>1.154</b>
	WLAN5.3GHz	802.11n-HT40 MCS0	Left Tilted	0mm	1	Full	62	5310	13.48	14.50	1.264	93.73	1.067	0.03	0.376	0.507
	WLAN5.3GHz	802.11n-HT40 MCS0	Left Tilted	0mm	2	Full	54	5270	17.90	19.00	1.288	93.73	1.067	0.01	0.763	1.048
	WLAN5.5GHz	802.11ac-VHT80 MCS0	Right Cheek	0mm	1	Full	138	5690	17.53	19.00	1.404	88.19	1.134	0.04	0.308	0.490
	WLAN5.5GHz	802.11ac-VHT80 MCS0	Right Tilted	0mm	1	Full	138	5690	17.53	19.00	1.404	88.19	1.134	0.09	0.432	0.688



**FCC SAR Test Report**

**Report No. : FA170131**

	WLAN5.5GHz	802.11ac-VHT80 MCS0	Left Cheek	0mm	1	Full	138	5690	17.53	19.00	1.404	88.19	1.134	0.02	0.453	0.721
14	WLAN5.5GHz	802.11ac-VHT80 MCS0	Left Tilted	0mm	1	Full	138	5690	17.53	19.00	1.404	88.19	1.134	-0.04	0.598	<b>0.952</b>
	WLAN5.5GHz	802.11ac-VHT80 MCS0	Left Tilted	0mm	1	Full	122	5610	16.38	17.50	1.295	88.19	1.134	0.01	0.548	0.805
	WLAN5.8GHz	802.11ac-VHT80 MCS0	Right Cheek	0mm	1	Full	155	5775	17.66	19.00	1.363	88.19	1.134	0.03	0.346	0.535
	WLAN5.8GHz	802.11ac-VHT80 MCS0	Right Tilted	0mm	1	Full	155	5775	17.66	19.00	1.363	88.19	1.134	0.01	0.396	0.612
	WLAN5.8GHz	802.11ac-VHT80 MCS0	Left Cheek	0mm	1	Full	155	5775	17.66	19.00	1.363	88.19	1.134	-0.02	0.392	0.606
15	WLAN5.8GHz	802.11ac-VHT80 MCS0	Left Tilted	0mm	1	Full	155	5775	17.66	19.00	1.363	88.19	1.134	-0.04	0.647	<b>1.000</b>

**<Bluetooth SAR>**

Plot No.	Band	Mode	Test Position	Gap (mm)	Sample	Power Reduction	Ch.	Freq. (MHz)	Average Power (dBm)	Tune-Up Limit (dBm)	Tune-up Scaling Factor	Duty Cycle %	Duty Cycle Scaling Factor	Power Drift (dB)	Measured 1g SAR (W/kg)	Reported 1g SAR (W/kg)
	Bluetooth	1Mbps	Right Cheek	0mm	1	Full	39	2441	10.21	11.00	1.199	76.91	1.300	0.04	0.032	0.050
	Bluetooth	1Mbps	Right Tilted	0mm	1	Full	39	2441	10.21	11.00	1.199	76.91	1.300	0.01	0.028	0.044
	Bluetooth	1Mbps	Left Cheek	0mm	1	Full	39	2441	10.21	11.00	1.199	76.91	1.300	0.09	0.067	0.104
	Bluetooth	1Mbps	Left Tilted	0mm	1	Full	39	2441	10.21	11.00	1.199	76.91	1.300	0.04	0.065	0.101
	Bluetooth	1Mbps	Left Cheek	0mm	1	Full	0	2402	10.10	11.00	1.230	76.91	1.300	-0.09	0.073	0.117
16	Bluetooth	1Mbps	Left Cheek	0mm	1	Full	78	2480	9.32	11.00	1.472	76.91	1.300	0.11	0.076	<b>0.145</b>



15.2 Hotspot SAR

<GSM SAR>

Plot No.	Band	Mode	Test Position	Gap (mm)	Sample	Power Reduction	Ch.	Freq. (MHz)	Average Power (dBm)	Tune-Up Limit (dBm)	Tune-up Scaling Factor	Power Drift (dB)	Measured 1g SAR (W/kg)	Reported 1g SAR (W/kg)
	GSM850	GPRS (2 Tx slots)	Front	5mm	1	Full	189	836.4	30.15	31.00	1.216	0.03	0.673	0.818
	GSM850	GPRS (2 Tx slots)	Front	5mm	1	Full	128	824.2	30.05	31.00	1.245	0.04	0.672	0.836
	GSM850	GPRS (2 Tx slots)	Front	5mm	1	Full	251	848.8	30.05	31.00	1.245	0.06	0.573	0.713
17	GSM850	GPRS (2 Tx slots)	Back	5mm	1	Full	189	836.4	30.15	31.00	1.216	0.02	0.900	1.095
	GSM850	GPRS (2 Tx slots)	Back	5mm	1	Full	128	824.2	30.05	31.00	1.245	0.06	0.816	1.016
	GSM850	GPRS (2 Tx slots)	Back	5mm	1	Full	251	848.8	30.05	31.00	1.245	0.01	0.704	0.876
	GSM850	GPRS (2 Tx slots)	Left Side	5mm	1	Full	189	836.4	30.15	31.00	1.216	0.03	0.361	0.439
	GSM850	GPRS (2 Tx slots)	Right Side	5mm	1	Full	189	836.4	30.15	31.00	1.216	0.04	0.496	0.603
	GSM850	GPRS (2 Tx slots)	Bottom Side	5mm	1	Full	189	836.4	30.15	31.00	1.216	0.03	0.755	0.918
	GSM850	GPRS (2 Tx slots)	Bottom Side	5mm	1	Full	128	824.2	30.05	31.00	1.245	0.04	0.699	0.870
	GSM850	GPRS (2 Tx slots)	Bottom Side	5mm	1	Full	251	848.8	30.05	31.00	1.245	-0.09	0.578	0.719
	GSM1900	GPRS (2 Tx slots)	Front	5mm	1	Reduced	661	1880	20.55	21.50	1.245	0.02	0.469	0.584
	GSM1900	GPRS (2 Tx slots)	Back	5mm	1	Reduced	661	1880	20.55	21.50	1.245	0.03	0.855	1.064
18	GSM1900	GPRS (2 Tx slots)	Back	5mm	1	Reduced	512	1850.2	20.44	21.50	1.276	0.04	1.090	1.391
	GSM1900	GPRS (2 Tx slots)	Back	5mm	2	Reduced	512	1850.2	20.44	21.50	1.276	0.02	1.050	1.340
	GSM1900	GPRS (2 Tx slots)	Back	5mm	1	Reduced	810	1909.8	20.45	21.50	1.274	0.04	0.699	0.890
	GSM1900	GPRS (2 Tx slots)	Left Side	5mm	1	Reduced	661	1880	19.64	20.50	1.219	0.02	0.037	0.045
	GSM1900	GPRS (2 Tx slots)	Right Side	5mm	1	Reduced	661	1880	19.64	20.50	1.219	0.03	0.043	0.052
	GSM1900	GPRS (2 Tx slots)	Bottom Side	5mm	1	Reduced	661	1880	19.64	20.50	1.219	0.06	0.985	1.201
	GSM1900	GPRS (2 Tx slots)	Bottom Side	5mm	1	Reduced	512	1850.2	19.58	20.50	1.236	-0.01	1.080	1.335
	GSM1900	GPRS (2 Tx slots)	Bottom Side	5mm	2	Reduced	512	1850.2	19.58	20.50	1.236	0.02	1.060	1.310
	GSM1900	GPRS (2 Tx slots)	Bottom Side	5mm	1	Reduced	810	1909.8	19.63	20.50	1.222	0.01	0.907	1.108



<WCDMA SAR>

Plot No.	Band	Mode	Test Position	Gap (mm)	Sample	Power Reduction	Ch.	Freq. (MHz)	Average Power (dBm)	Tune-Up Limit (dBm)	Tune-up Scaling Factor	Power Drift (dB)	Measured 1g SAR (W/kg)	Reported 1g SAR (W/kg)
	WCDMA II	RMC 12.2Kbps	Front	5mm	1	Reduced	9400	1880	13.88	15.00	1.294	0.06	0.453	0.586
	WCDMA II	RMC 12.2Kbps	Back	5mm	1	Reduced	9400	1880	13.88	15.00	1.294	0.02	0.882	1.141
19	WCDMA II	RMC 12.2Kbps	Back	5mm	1	Reduced	9262	1852.4	13.82	15.00	1.312	0.03	1.010	1.325
	WCDMA II	RMC 12.2Kbps	Back	5mm	1	Reduced	9538	1907.6	13.84	15.00	1.306	-0.06	0.688	0.899
	WCDMA II	RMC 12.2Kbps	Left Side	5mm	1	Reduced	9400	1880	12.94	14.00	1.276	0.03	0.030	0.038
	WCDMA II	RMC 12.2Kbps	Right Side	5mm	1	Reduced	9400	1880	12.94	14.00	1.276	0.05	0.032	0.041
	WCDMA II	RMC 12.2Kbps	Bottom Side	5mm	1	Reduced	9400	1880	12.94	14.00	1.276	0.01	0.761	0.971
	WCDMA II	RMC 12.2Kbps	Bottom Side	5mm	1	Reduced	9262	1852.4	12.88	14.00	1.294	0.02	0.944	1.222
	WCDMA II	RMC 12.2Kbps	Bottom Side	5mm	1	Reduced	9538	1907.6	12.90	14.00	1.288	0.03	0.644	0.830
	WCDMA IV	RMC 12.2Kbps	Front	5mm	1	Reduced	1413	1732.6	14.23	15.50	1.340	0.01	0.590	0.790
	WCDMA IV	RMC 12.2Kbps	Back	5mm	1	Reduced	1413	1732.6	14.23	15.50	1.340	0.02	0.987	1.322
20	WCDMA IV	RMC 12.2Kbps	Back	5mm	1	Reduced	1312	1712.4	14.16	15.50	1.361	0.03	1.060	1.443
	WCDMA IV	RMC 12.2Kbps	Back	5mm	2	Reduced	1312	1712.4	14.16	15.50	1.361	0.01	1.040	1.416
	WCDMA IV	RMC 12.2Kbps	Back	5mm	1	Reduced	1513	1752.6	14.20	15.50	1.349	-0.06	0.996	1.344
	WCDMA IV	RMC 12.2Kbps	Left Side	5mm	1	Reduced	1413	1732.6	13.40	14.50	1.288	0.03	0.030	0.039
	WCDMA IV	RMC 12.2Kbps	Right Side	5mm	1	Reduced	1413	1732.6	13.40	14.50	1.288	0.05	0.093	0.120
	WCDMA IV	RMC 12.2Kbps	Bottom Side	5mm	1	Reduced	1413	1732.6	13.40	14.50	1.288	-0.04	1.110	1.430
	WCDMA IV	RMC 12.2Kbps	Bottom Side	5mm	2	Reduced	1413	1732.6	13.40	14.50	1.288	0.03	1.080	1.391
	WCDMA IV	RMC 12.2Kbps	Bottom Side	5mm	1	Reduced	1312	1712.4	13.23	14.50	1.340	0.03	1.052	1.409
	WCDMA IV	RMC 12.2Kbps	Bottom Side	5mm	1	Reduced	1513	1752.6	13.35	14.50	1.303	0.04	1.023	1.333
	WCDMA V	RMC 12.2Kbps	Front	5mm	1	Full	4182	836.4	22.63	24.00	1.371	0.01	0.600	0.823
	WCDMA V	RMC 12.2Kbps	Front	5mm	1	Full	4132	826.4	22.58	24.00	1.387	0.03	0.684	0.949
	WCDMA V	RMC 12.2Kbps	Front	5mm	1	Full	4233	846.6	22.44	24.00	1.432	-0.04	0.704	1.008
	WCDMA V	RMC 12.2Kbps	Back	5mm	1	Full	4182	836.4	22.63	24.00	1.371	0.03	0.798	1.094
21	WCDMA V	RMC 12.2Kbps	Back	5mm	1	Full	4132	826.4	22.58	24.00	1.387	0.02	0.848	1.176
	WCDMA V	RMC 12.2Kbps	Back	5mm	1	Full	4233	846.6	22.44	24.00	1.432	-0.09	0.770	1.103
	WCDMA V	RMC 12.2Kbps	Left Side	5mm	1	Full	4182	836.4	22.63	24.00	1.371	0.01	0.348	0.477
	WCDMA V	RMC 12.2Kbps	Right Side	5mm	1	Full	4182	836.4	22.63	24.00	1.371	-0.05	0.490	0.672
	WCDMA V	RMC 12.2Kbps	Bottom Side	5mm	1	Full	4182	836.4	22.63	24.00	1.371	0.04	0.646	0.886
	WCDMA V	RMC 12.2Kbps	Bottom Side	5mm	1	Full	4182	836.4	22.63	24.00	1.371	0.03	0.676	0.927
	WCDMA V	RMC 12.2Kbps	Bottom Side	5mm	1	Full	4182	836.4	22.63	24.00	1.371	0.05	0.701	0.961
	WCDMA V	RMC 12.2Kbps	Back	5mm	2	Full	4132	826.4	22.58	24.00	1.387	0.02	0.765	1.061



<FDD LTE SAR>

Plot No.	Band	BW (MHz)	Modulation	RB Size	RB offset	Test Position	Gap (mm)	Sample	Power Reduction	Ch.	Freq. (MHz)	Average Power (dBm)	Tune-Up Limit (dBm)	Tune-up Scaling Factor	Power Drift (dB)	Measured 1g SAR (W/kg)	Reported 1g SAR (W/kg)
	LTE Band 2	20M	QPSK	1	0	Front	5mm	1	Reduced	18900	1880	14.78	15.50	1.180	0.05	0.457	0.539
	LTE Band 2	20M	QPSK	50	0	Front	5mm	1	Reduced	18900	1880	13.69	14.50	1.205	-0.05	0.373	0.449
	LTE Band 2	20M	QPSK	1	0	Back	5mm	1	Reduced	18900	1880	14.78	15.50	1.180	0.02	0.897	1.059
22	LTE Band 2	20M	QPSK	1	0	Back	5mm	1	Reduced	18700	1860	14.50	15.50	1.259	0.03	1.130	1.423
	LTE Band 2	20M	QPSK	1	0	Back	5mm	1	Reduced	19100	1900	14.52	15.50	1.253	-0.06	0.725	0.909
	LTE Band 2	20M	QPSK	50	0	Back	5mm	1	Reduced	18900	1880	13.69	14.50	1.205	0.03	0.618	0.745
	LTE Band 2	20M	QPSK	100	0	Back	5mm	1	Reduced	18900	1880	13.64	14.50	1.219	0.01	0.704	0.858
	LTE Band 2	20M	QPSK	1	0	Left Side	5mm	1	Reduced	18900	1880	13.79	14.50	1.178	0.02	0.033	0.039
	LTE Band 2	20M	QPSK	50	0	Left Side	5mm	1	Reduced	18900	1880	12.70	13.50	1.202	0.06	0.026	0.031
	LTE Band 2	20M	QPSK	1	0	Right Side	5mm	1	Reduced	18900	1880	13.79	14.50	1.178	-0.01	0.037	0.044
	LTE Band 2	20M	QPSK	50	0	Right Side	5mm	1	Reduced	18900	1880	12.70	13.50	1.202	0.01	0.032	0.038
	LTE Band 2	20M	QPSK	1	0	Bottom Side	5mm	1	Reduced	18900	1880	13.79	14.50	1.178	0.02	0.879	1.035
	LTE Band 2	20M	QPSK	1	0	Bottom Side	5mm	1	Reduced	18700	1860	13.48	14.50	1.265	0.03	0.996	1.260
	LTE Band 2	20M	QPSK	1	0	Bottom Side	5mm	1	Reduced	19100	1900	13.52	14.50	1.253	-0.06	0.789	0.989
	LTE Band 2	20M	QPSK	50	0	Bottom Side	5mm	1	Reduced	18900	1880	12.70	13.50	1.202	0.03	0.691	0.831
	LTE Band 2	20M	QPSK	50	0	Bottom Side	5mm	1	Reduced	18700	1860	12.53	13.50	1.250	0.05	0.811	1.014
	LTE Band 2	20M	QPSK	50	0	Bottom Side	5mm	1	Reduced	19100	1900	12.58	13.50	1.236	0.03	0.595	0.735
	LTE Band 2	20M	QPSK	100	0	Bottom Side	5mm	1	Reduced	18900	1880	12.63	13.50	1.222	0.01	0.666	0.814
	LTE Band 7	20M	QPSK	1	0	Front	5mm	1	Reduced	21100	2535	16.79	18.00	1.321	0.01	0.677	0.895
	LTE Band 7	20M	QPSK	1	0	Front	5mm	1	Reduced	20850	2510	16.34	18.00	1.466	-0.05	0.644	0.944
	LTE Band 7	20M	QPSK	1	0	Front	5mm	1	Reduced	21350	2560	16.49	18.00	1.416	0.06	0.725	1.026
	LTE Band 7	20M	QPSK	50	0	Front	5mm	1	Reduced	21100	2535	15.54	17.00	1.400	0.03	0.567	0.794
	LTE Band 7	20M	QPSK	100	0	Front	5mm	1	Reduced	21100	2535	15.56	17.00	1.393	0.03	0.566	0.789
	LTE Band 7	20M	QPSK	1	0	Back	5mm	1	Reduced	21100	2535	16.79	18.00	1.321	-0.06	0.925	1.222
	LTE Band 7	20M	QPSK	1	0	Back	5mm	1	Reduced	20850	2510	16.34	18.00	1.466	-0.06	0.869	1.274
23	LTE Band 7	20M	QPSK	1	0	Back	5mm	1	Reduced	21350	2560	16.49	18.00	1.416	0.03	0.986	1.396
	LTE Band 7	20M	QPSK	50	0	Back	5mm	1	Reduced	21100	2535	15.54	17.00	1.400	0.05	0.705	0.987
	LTE Band 7	20M	QPSK	50	0	Back	5mm	1	Reduced	20850	2510	15.42	17.00	1.439	0.03	0.647	0.931
	LTE Band 7	20M	QPSK	50	0	Back	5mm	1	Reduced	21350	2560	15.48	17.00	1.419	0.01	0.749	1.063
	LTE Band 7	20M	QPSK	100	0	Back	5mm	1	Reduced	21100	2535	15.56	17.00	1.393	-0.05	0.728	1.014
	LTE Band 7	20M	QPSK	1	0	Left Side	5mm	1	Reduced	21100	2535	16.79	18.00	1.321	0.06	0.371	0.490
	LTE Band 7	20M	QPSK	50	0	Left Side	5mm	1	Reduced	21100	2535	15.54	17.00	1.400	-0.01	0.302	0.423
	LTE Band 7	20M	QPSK	1	0	Right Side	5mm	1	Reduced	21100	2535	16.79	18.00	1.321	0.05	0.077	0.102
	LTE Band 7	20M	QPSK	50	0	Right Side	5mm	1	Reduced	21100	2535	15.54	17.00	1.400	0.06	0.058	0.081
	LTE Band 7	20M	QPSK	1	0	Bottom Side	5mm	1	Reduced	21100	2535	16.79	18.00	1.321	-0.01	0.636	0.840
	LTE Band 7	20M	QPSK	1	0	Bottom Side	5mm	1	Reduced	20850	2510	16.34	18.00	1.466	0.01	0.607	0.890
	LTE Band 7	20M	QPSK	1	0	Bottom Side	5mm	1	Reduced	21350	2560	16.49	18.00	1.416	-0.06	0.668	0.946
	LTE Band 7	20M	QPSK	50	0	Bottom Side	5mm	1	Reduced	21100	2535	15.54	17.00	1.400	0.01	0.486	0.680
	LTE Band 7	20M	QPSK	100	0	Bottom Side	5mm	1	Reduced	21100	2535	15.56	17.00	1.393	-0.06	0.477	0.665
	LTE Band 7	20M	QPSK	1	0	Back	5mm	2	Reduced	21350	2560	16.49	18.00	1.416	0.04	0.962	1.362
	LTE Band 7	20M	QPSK	1	0	Bottom Side	5mm	2	Reduced	21350	2560	16.49	18.00	1.416	0.03	0.626	0.886
	LTE Band 12	10M	QPSK	1	0	Front	5mm	1	Full	23095	707.5	22.88	24.00	1.294	0.03	0.266	0.344
	LTE Band 12	10M	QPSK	25	0	Front	5mm	1	Full	23095	707.5	21.71	23.00	1.346	0.01	0.210	0.283
24	LTE Band 12	10M	QPSK	1	0	Back	5mm	1	Full	23095	707.5	22.88	24.00	1.294	0.02	0.485	0.628
	LTE Band 12	10M	QPSK	25	0	Back	5mm	1	Full	23095	707.5	21.71	23.00	1.346	-0.05	0.395	0.532
	LTE Band 12	10M	QPSK	1	0	Left Side	5mm	1	Full	23095	707.5	22.88	24.00	1.294	0.06	0.208	0.269
	LTE Band 12	10M	QPSK	25	0	Left Side	5mm	1	Full	23095	707.5	21.71	23.00	1.346	0.04	0.169	0.227
	LTE Band 12	10M	QPSK	1	0	Right Side	5mm	1	Full	23095	707.5	22.88	24.00	1.294	0.09	0.338	0.437
	LTE Band 12	10M	QPSK	25	0	Right Side	5mm	1	Full	23095	707.5	21.71	23.00	1.346	0.08	0.274	0.369
	LTE Band 12	10M	QPSK	1	0	Bottom Side	5mm	1	Full	23095	707.5	22.88	24.00	1.294	0.03	0.338	0.437
	LTE Band 12	10M	QPSK	25	0	Bottom Side	5mm	1	Full	23095	707.5	21.71	23.00	1.346	0.01	0.274	0.369
	LTE Band 12	10M	QPSK	1	0	Back	5mm	2	Full	23095	707.5	22.88	24.00	1.294	0.03	0.455	0.589



	LTE Band 13	10M	QPSK	1	0	Front	5mm	1	Full	23230	782	22.89	24.00	1.291	0.02	0.281	0.363
	LTE Band 13	10M	QPSK	25	0	Front	5mm	1	Full	23230	782	21.74	23.00	1.337	0.06	0.226	0.302
25	LTE Band 13	10M	QPSK	1	0	Back	5mm	1	Full	23230	782	22.89	24.00	1.291	0.02	0.470	<b>0.607</b>
	LTE Band 13	10M	QPSK	25	0	Back	5mm	1	Full	23230	782	21.74	23.00	1.337	-0.01	0.377	0.504
	LTE Band 13	10M	QPSK	1	0	Left Side	5mm	1	Full	23230	782	22.89	24.00	1.291	0.06	0.192	0.248
	LTE Band 13	10M	QPSK	25	0	Left Side	5mm	1	Full	23230	782	21.74	23.00	1.337	0.01	0.154	0.206
	LTE Band 13	10M	QPSK	1	0	Right Side	5mm	1	Full	23230	782	22.89	24.00	1.291	0.08	0.326	0.421
	LTE Band 13	10M	QPSK	25	0	Right Side	5mm	1	Full	23230	782	21.74	23.00	1.337	0.04	0.260	0.348
	LTE Band 13	10M	QPSK	1	0	Bottom Side	5mm	1	Full	23230	782	22.89	24.00	1.291	0.06	0.377	0.487
	LTE Band 13	10M	QPSK	25	0	Bottom Side	5mm	1	Full	23230	782	21.74	23.00	1.337	0.01	0.302	0.404
	LTE Band 26	15M	QPSK	1	0	Front	5mm	1	Full	26865	831.5	23.05	24.00	1.245	0.03	0.503	0.626
	LTE Band 26	15M	QPSK	36	0	Front	5mm	1	Full	26865	831.5	21.92	23.00	1.282	-0.04	0.405	0.519
26	LTE Band 26	15M	QPSK	1	0	Back	5mm	1	Full	26865	831.5	23.05	24.00	1.245	-0.03	0.782	<b>0.973</b>
	LTE Band 26	15M	QPSK	36	0	Back	5mm	1	Full	26865	831.5	21.92	23.00	1.282	0.04	0.617	0.791
	LTE Band 26	15M	QPSK	75	0	Back	5mm	1	Full	26865	831.5	21.92	23.00	1.282	0.02	0.605	0.776
	LTE Band 26	15M	QPSK	1	0	Left Side	5mm	1	Full	26865	831.5	23.05	24.00	1.245	-0.05	0.277	0.345
	LTE Band 26	15M	QPSK	36	0	Left Side	5mm	1	Full	26865	831.5	21.92	23.00	1.282	0.06	0.224	0.287
	LTE Band 26	15M	QPSK	1	0	Right Side	5mm	1	Full	26865	831.5	23.05	24.00	1.245	0.02	0.401	0.499
	LTE Band 26	15M	QPSK	36	0	Right Side	5mm	1	Full	26865	831.5	21.92	23.00	1.282	0.04	0.322	0.413
	LTE Band 26	15M	QPSK	1	0	Bottom Side	5mm	1	Full	26865	831.5	23.05	24.00	1.245	-0.03	0.525	0.653
	LTE Band 26	15M	QPSK	36	0	Bottom Side	5mm	1	Full	26865	831.5	21.92	23.00	1.282	0.09	0.417	0.535
	LTE Band 66	20M	QPSK	1	0	Front	5mm	1	Reduced	132322	1745	14.99	16.00	1.262	0.04	0.754	0.951
	LTE Band 66	20M	QPSK	1	0	Front	5mm	1	Reduced	132072	1720	14.98	16.00	1.265	0.02	0.759	0.960
	LTE Band 66	20M	QPSK	1	0	Front	5mm	1	Reduced	132572	1770	14.67	16.00	1.358	0.03	0.541	0.735
	LTE Band 66	20M	QPSK	50	0	Front	5mm	1	Reduced	132322	1745	14.03	15.00	1.250	0.01	0.610	0.763
	LTE Band 66	20M	QPSK	100	0	Front	5mm	1	Reduced	132322	1745	14.01	15.00	1.256	0.02	0.609	0.765
	LTE Band 66	20M	QPSK	1	0	Back	5mm	1	Reduced	132322	1745	14.99	16.00	1.262	0.06	1.090	1.375
27	LTE Band 66	20M	QPSK	1	0	Back	5mm	1	Reduced	132072	1720	14.98	16.00	1.265	-0.01	1.110	<b>1.404</b>
	LTE Band 66	20M	QPSK	1	0	Back	5mm	1	Reduced	132572	1770	14.67	16.00	1.358	0.01	1.030	1.399
	LTE Band 66	20M	QPSK	50	0	Back	5mm	1	Reduced	132322	1745	14.03	15.00	1.250	-0.05	0.880	1.100
	LTE Band 66	20M	QPSK	50	0	Back	5mm	1	Reduced	132072	1720	13.96	15.00	1.271	0.01	0.879	1.117
	LTE Band 66	20M	QPSK	50	0	Back	5mm	1	Reduced	132572	1770	13.87	15.00	1.297	0.02	0.726	0.942
	LTE Band 66	20M	QPSK	100	0	Back	5mm	1	Reduced	132322	1745	14.01	15.00	1.256	0.03	0.838	1.053
	LTE Band 66	20M	QPSK	1	0	Left Side	5mm	1	Reduced	132322	1745	13.29	14.00	1.178	-0.06	0.022	0.026
	LTE Band 66	20M	QPSK	50	0	Left Side	5mm	1	Reduced	132322	1745	12.21	13.00	1.199	0.03	0.019	0.023
	LTE Band 66	20M	QPSK	1	0	Right Side	5mm	1	Reduced	132322	1745	13.29	14.00	1.178	0.05	0.071	0.084
	LTE Band 66	20M	QPSK	50	0	Right Side	5mm	1	Reduced	132322	1745	12.21	13.00	1.199	0.03	0.061	0.073
	LTE Band 66	20M	QPSK	1	0	Bottom Side	5mm	1	Reduced	132322	1745	13.29	14.00	1.178	0.06	1.050	1.236
	LTE Band 66	20M	QPSK	1	0	Bottom Side	5mm	1	Reduced	132072	1720	13.01	14.00	1.256	0.03	0.813	1.021
	LTE Band 66	20M	QPSK	1	0	Bottom Side	5mm	1	Reduced	132572	1770	13.12	14.00	1.225	0.06	0.794	0.972
	LTE Band 66	20M	QPSK	50	0	Bottom Side	5mm	1	Reduced	132322	1745	12.21	13.00	1.199	0.02	0.756	0.907
	LTE Band 66	20M	QPSK	50	0	Bottom Side	5mm	1	Reduced	132072	1720	12.15	13.00	1.216	0.03	0.742	0.902
	LTE Band 66	20M	QPSK	50	0	Bottom Side	5mm	1	Reduced	132572	1770	12.20	13.00	1.202	-0.06	0.765	0.920
	LTE Band 66	20M	QPSK	100	0	Bottom Side	5mm	1	Reduced	132322	1745	12.15	13.00	1.216	0.03	0.772	0.939



<WLAN2.4G SAR>

Plot No.	Band	Mode	Test Position	Gap (mm)	Sample	Power Reduction	Ch.	Freq. (MHz)	Average Power (dBm)	Tune-Up Limit (dBm)	Tune-up Scaling Factor	Duty Cycle %	Duty Cycle Scaling Factor	Power Drift (dB)	Measured 1g SAR (W/kg)	Reported 1g SAR (W/kg)
	WLAN2.4GHz	802.11b 1Mbps	Front	5mm	1	Full	11	2462	18.43	19.50	1.279	99.31	1.007	0.03	0.298	0.384
28	WLAN2.4GHz	802.11b 1Mbps	Back	5mm	1	Full	11	2462	18.43	19.50	1.279	99.31	1.007	0.01	0.512	0.660
	WLAN2.4GHz	802.11b 1Mbps	Left Side	5mm	1	Full	11	2462	18.43	19.50	1.279	99.31	1.007	-0.05	0.038	0.049
	WLAN2.4GHz	802.11b 1Mbps	Right Side	5mm	1	Full	11	2462	18.43	19.50	1.279	99.31	1.007	0.06	0.342	0.441
	WLAN2.4GHz	802.11b 1Mbps	Top Side	5mm	1	Full	11	2462	18.43	19.50	1.279	99.31	1.007	0.03	0.488	0.629
	WLAN2.4GHz	802.11b 1Mbps	Back	5mm	2	Full	11	2462	18.43	19.50	1.279	99.31	1.007	0.01	0.498	0.642

<WLAN5G SAR>

Plot No.	Band	Mode	Test Position	Gap (mm)	Sample	Power Reduction	Ch.	Freq. (MHz)	Average Power (dBm)	Tune-Up Limit (dBm)	Tune-up Scaling Factor	Duty Cycle %	Duty Cycle Scaling Factor	Power Drift (dB)	Measured 1g SAR (W/kg)	Reported 1g SAR (W/kg)
	WLAN5.2GHz	802.11n-HT40 MCS0	Front	5mm	1	Reduced	46	5230	15.40	16.50	1.288	93.73	1.067	0.03	0.234	0.322
	WLAN5.2GHz	802.11n-HT40 MCS0	Back	5mm	1	Reduced	46	5230	15.40	16.50	1.288	93.73	1.067	0.01	0.431	0.592
	WLAN5.2GHz	802.11n-HT40 MCS0	Left Side	5mm	1	Reduced	46	5230	15.40	16.50	1.288	93.73	1.067	-0.05	0.056	0.077
	WLAN5.2GHz	802.11n-HT40 MCS0	Right Side	5mm	1	Reduced	46	5230	15.40	16.50	1.288	93.73	1.067	0.03	0.395	0.543
29	WLAN5.2GHz	802.11n-HT40 MCS0	Top Side	5mm	1	Reduced	46	5230	15.40	16.50	1.288	93.73	1.067	0.01	0.827	1.137
	WLAN5.2GHz	802.11n-HT40 MCS0	Top Side	5mm	1	Reduced	38	5190	12.93	14.00	1.279	93.73	1.067	0.06	0.334	0.456
	WLAN5.2GHz	802.11n-HT40 MCS0	Top Side	5mm	2	Reduced	46	5230	15.40	16.50	1.288	93.73	1.067	0.01	0.807	1.109
	WLAN5.8GHz	802.11ac-VHT80 MCS0	Front	5mm	1	Reduced	155	5775	16.75	18.00	1.334	88.19	1.134	0.02	0.210	0.318
	WLAN5.8GHz	802.11ac-VHT80 MCS0	Back	5mm	1	Reduced	155	5775	16.75	18.00	1.334	88.19	1.134	0.06	0.599	0.906
	WLAN5.8GHz	802.11ac-VHT80 MCS0	Left Side	5mm	1	Reduced	155	5775	16.75	18.00	1.334	88.19	1.134	0.01	0.091	0.138
	WLAN5.8GHz	802.11ac-VHT80 MCS0	Right Side	5mm	1	Reduced	155	5775	16.75	18.00	1.334	88.19	1.134	-0.06	0.352	0.532
30	WLAN5.8GHz	802.11ac-VHT80 MCS0	Top Side	5mm	1	Reduced	155	5775	16.75	18.00	1.334	88.19	1.134	0.01	0.741	1.121
	WLAN5.8GHz	802.11ac-VHT80 MCS0	Top Side	5mm	2	Reduced	155	5775	16.75	18.00	1.334	88.19	1.134	0.01	0.692	1.046

<Bluetooth SAR>

Plot No.	Band	Mode	Test Position	Gap (mm)	Sample	Power Reduction	Ch.	Freq. (MHz)	Average Power (dBm)	Tune-Up Limit (dBm)	Tune-up Scaling Factor	Duty Cycle %	Duty Cycle Scaling Factor	Power Drift (dB)	Measured 1g SAR (W/kg)	Reported 1g SAR (W/kg)
	Bluetooth	1Mbps	Front	5mm	1	Full	39	2441	10.21	11.00	1.199	76.91	1.300	0.01	0.038	0.059
31	Bluetooth	1Mbps	Back	5mm	1	Full	39	2441	10.21	11.00	1.199	76.91	1.300	-0.06	0.070	0.109
	Bluetooth	1Mbps	Left Side	5mm	1	Full	39	2441	10.21	11.00	1.199	76.91	1.300	0.03	0.006	0.009
	Bluetooth	1Mbps	Right Side	5mm	1	Full	39	2441	10.21	11.00	1.199	76.91	1.300	0.05	0.046	0.072
	Bluetooth	1Mbps	Top Side	5mm	1	Full	39	2441	10.21	11.00	1.199	76.91	1.300	0.03	0.059	0.092
	Bluetooth	1Mbps	Back	5mm	2	Full	39	2441	10.21	11.00	1.199	76.91	1.300	0.04	0.051	0.080



15.3 Body Worn Accessory SAR

<GSM SAR>

Plot No.	Band	Mode	Test Position	Gap (mm)	Sample	Headset	Power Reduction	Ch.	Freq. (MHz)	Average Power (dBm)	Tune-Up Limit (dBm)	Tune-up Scaling Factor	Power Drift (dB)	Measured 1g SAR (W/kg)	Reported 1g SAR (W/kg)
	GSM850	GPRS (2 Tx slots)	Front	5mm	1	-	Full	189	836.4	30.15	31.00	1.216	0.03	0.673	0.818
	GSM850	GPRS (2 Tx slots)	Front	5mm	1	-	Full	128	824.2	30.05	31.00	1.245	0.04	0.672	0.836
	GSM850	GPRS (2 Tx slots)	Front	5mm	1	-	Full	251	848.8	30.05	31.00	1.245	0.06	0.573	0.713
32	GSM850	GPRS (2 Tx slots)	Back	5mm	1	-	Full	189	836.4	30.15	31.00	1.216	0.02	0.900	1.095
	GSM850	GPRS (2 Tx slots)	Back	5mm	1	-	Full	128	824.2	30.05	31.00	1.245	0.06	0.816	1.016
	GSM850	GPRS (2 Tx slots)	Back	5mm	1	-	Full	251	848.8	30.05	31.00	1.245	0.01	0.704	0.876
	GSM1900	GPRS (2 Tx slots)	Front	5mm	1	-	Reduced	661	1880	20.55	21.50	1.245	0.02	0.469	0.584
	GSM1900	GPRS (2 Tx slots)	Back	5mm	1	-	Reduced	661	1880	20.55	21.50	1.245	0.03	0.855	1.064
33	GSM1900	GPRS (2 Tx slots)	Back	5mm	1	-	Reduced	512	1850.2	20.44	21.50	1.276	0.04	1.090	1.391
	GSM1900	GPRS (2 Tx slots)	Back	5mm	2	-	Reduced	512	1850.2	20.44	21.50	1.276	0.02	1.050	1.340
	GSM1900	GPRS (2 Tx slots)	Back	5mm	1	-	Reduced	810	1909.8	20.45	21.50	1.274	0.04	0.699	0.890
	GSM1900	GPRS (2 Tx slots)	Back	5mm	1	Headset1	Reduced	512	1850.2	20.44	21.50	1.276	-0.05	0.876	1.118
	GSM1900	GPRS (2 Tx slots)	Back	5mm	1	Headset2	Reduced	512	1850.2	20.44	21.50	1.276	0.06	0.854	1.090
	GSM1900	GPRS (2 Tx slots)	Back	5mm	1	Headset3	Reduced	512	1850.2	20.44	21.50	1.276	0.03	0.874	1.116
	GSM1900	GPRS (2 Tx slots)	Back	5mm	1	Headset4	Reduced	512	1850.2	20.44	21.50	1.276	0.05	0.821	1.048
	GSM1900	GPRS (2 Tx slots)	Front	14mm	1	-	Full	661	1880	26.30	27.50	1.318	0.06	0.318	0.419
	GSM1900	GPRS (2 Tx slots)	Back	19mm	1	-	Full	661	1880	26.30	27.50	1.318	0.04	0.290	0.382

<WCDMA SAR>

Plot No.	Band	Mode	Test Position	Gap (mm)	Sample	Headset	Power Reduction	Ch.	Freq. (MHz)	Average Power (dBm)	Tune-Up Limit (dBm)	Tune-up Scaling Factor	Power Drift (dB)	Measured 1g SAR (W/kg)	Reported 1g SAR (W/kg)
	WCDMA II	RMC 12.2Kbps	Front	5mm	1	-	Reduced	9400	1880	13.88	15.00	1.294	0.06	0.453	0.586
	WCDMA II	RMC 12.2Kbps	Back	5mm	1	-	Reduced	9400	1880	13.88	15.00	1.294	0.02	0.882	1.141
34	WCDMA II	RMC 12.2Kbps	Back	5mm	1	-	Reduced	9262	1852.4	13.82	15.00	1.312	0.03	1.010	1.325
	WCDMA II	RMC 12.2Kbps	Back	5mm	1	Headset1	Reduced	9262	1852.4	13.82	15.00	1.312	0.01	0.609	0.799
	WCDMA II	RMC 12.2Kbps	Back	5mm	1	Headset2	Reduced	9262	1852.4	13.82	15.00	1.312	-0.05	0.668	0.877
	WCDMA II	RMC 12.2Kbps	Back	5mm	1	Headset3	Reduced	9262	1852.4	13.82	15.00	1.312	-0.05	0.657	0.862
	WCDMA II	RMC 12.2Kbps	Back	5mm	1	Headset4	Reduced	9262	1852.4	13.82	15.00	1.312	0.02	0.636	0.835
	WCDMA II	RMC 12.2Kbps	Back	5mm	1	-	Reduced	9538	1907.6	13.84	15.00	1.306	-0.06	0.688	0.899
	WCDMA II	RMC 12.2Kbps	Front	14mm	1	-	Full	9400	1880	22.75	24.00	1.334	0.06	0.361	0.481
	WCDMA II	RMC 12.2Kbps	Back	19mm	1	-	Full	9400	1880	22.75	24.00	1.334	0.01	0.616	0.821
	WCDMA IV	RMC 12.2Kbps	Front	5mm	1	-	Reduced	1413	1732.6	14.23	15.50	1.340	0.01	0.590	0.790
	WCDMA IV	RMC 12.2Kbps	Back	5mm	1	-	Reduced	1413	1732.6	14.23	15.50	1.340	0.02	0.987	1.322
35	WCDMA IV	RMC 12.2Kbps	Back	5mm	1	-	Reduced	1312	1712.4	14.16	15.50	1.361	0.03	1.060	1.443
	WCDMA IV	RMC 12.2Kbps	Back	5mm	2	-	Reduced	1312	1712.4	14.16	15.50	1.361	0.01	1.040	1.416
	WCDMA IV	RMC 12.2Kbps	Back	5mm	1	Headset1	Reduced	1312	1712.4	14.16	15.50	1.361	0.03	0.975	1.327
	WCDMA IV	RMC 12.2Kbps	Back	5mm	1	Headset2	Reduced	1312	1712.4	14.16	15.50	1.361	0.04	0.963	1.311
	WCDMA IV	RMC 12.2Kbps	Back	5mm	1	Headset3	Reduced	1312	1712.4	14.16	15.50	1.361	0.09	0.986	1.342
	WCDMA IV	RMC 12.2Kbps	Back	5mm	1	Headset4	Reduced	1312	1712.4	14.16	15.50	1.361	-0.02	0.941	1.281
	WCDMA IV	RMC 12.2Kbps	Back	5mm	1	-	Reduced	1513	1752.6	14.20	15.50	1.349	-0.06	0.996	1.344
	WCDMA IV	RMC 12.2Kbps	Front	14mm	1	-	Full	1413	1732.6	22.65	24.00	1.365	0.01	1.050	1.433
	WCDMA IV	RMC 12.2Kbps	Front	14mm	1	-	Full	1312	1712.4	22.48	24.00	1.419	-0.05	0.992	1.408
	WCDMA IV	RMC 12.2Kbps	Front	14mm	1	-	Full	1513	1752.6	22.62	24.00	1.374	0.06	0.980	1.347
	WCDMA IV	RMC 12.2Kbps	Back	19mm	1	-	Full	1413	1732.6	22.65	24.00	1.365	0.02	0.941	1.284
	WCDMA V	RMC 12.2Kbps	Front	5mm	1	-	Full	4182	836.4	22.63	24.00	1.371	0.01	0.600	0.823
	WCDMA V	RMC 12.2Kbps	Front	5mm	1	-	Full	4132	826.4	22.58	24.00	1.387	0.03	0.600	0.832
	WCDMA V	RMC 12.2Kbps	Front	5mm	1	-	Full	4233	846.6	22.44	24.00	1.432	-0.04	0.600	0.859
	WCDMA V	RMC 12.2Kbps	Back	5mm	1	-	Full	4182	836.4	22.63	24.00	1.371	0.03	0.798	1.094
36	WCDMA V	RMC 12.2Kbps	Back	5mm	1	-	Full	4132	826.4	22.58	24.00	1.387	0.02	0.848	1.176
	WCDMA V	RMC 12.2Kbps	Back	5mm	1	-	Full	4233	846.6	22.44	24.00	1.432	-0.09	0.770	1.103
	WCDMA V	RMC 12.2Kbps	Back	5mm	2	-	Full	4132	826.4	22.58	24.00	1.387	0.02	0.765	1.061



<FDD LTE SAR>

Plot No.	Band	BW (MHz)	Modulation	RB Size	RB offset	Test Position	Gap (mm)	Sample	Headset	Power Reduction	Ch.	Freq. (MHz)	Average Power (dBm)	Tune-Up Limit (dBm)	Tune-up Scaling Factor	Power Drift (dB)	Measured 1g SAR (W/kg)	Reported 1g SAR (W/kg)
	LTE Band 2	20M	QPSK	1	0	Front	5mm	1	-	Reduced	18900	1880	14.78	15.50	1.180	0.05	0.457	0.539
	LTE Band 2	20M	QPSK	50	0	Front	5mm	1	-	Reduced	18900	1880	13.69	14.50	1.205	-0.05	0.373	0.449
	LTE Band 2	20M	QPSK	1	0	Back	5mm	1	-	Reduced	18900	1880	14.78	15.50	1.180	0.02	0.897	1.059
37	LTE Band 2	20M	QPSK	1	0	Back	5mm	1	-	Reduced	18700	1860	14.50	15.50	1.259	0.03	1.130	1.423
	LTE Band 2	20M	QPSK	1	0	Back	5mm	1	Headset1	Reduced	18700	1860	14.50	15.50	1.259	-0.05	0.756	0.952
	LTE Band 2	20M	QPSK	1	0	Back	5mm	1	Headset2	Reduced	18700	1860	14.50	15.50	1.259	0.01	0.741	0.933
	LTE Band 2	20M	QPSK	1	0	Back	5mm	1	Headset3	Reduced	18700	1860	14.50	15.50	1.259	0.02	0.735	0.925
	LTE Band 2	20M	QPSK	1	0	Back	5mm	1	Headset4	Reduced	18700	1860	14.50	15.50	1.259	0.01	0.814	1.025
	LTE Band 2	20M	QPSK	1	0	Back	5mm	1	-	Reduced	19100	1900	14.52	15.50	1.253	-0.06	0.725	0.909
	LTE Band 2	20M	QPSK	50	0	Back	5mm	1	-	Reduced	18900	1880	13.69	14.50	1.205	0.03	0.618	0.745
	LTE Band 2	20M	QPSK	100	0	Back	5mm	1	-	Reduced	18900	1880	13.64	14.50	1.219	0.01	0.704	0.858
	LTE Band 2	20M	QPSK	1	0	Front	14mm	1	-	Full	18900	1880	23.19	24.00	1.205	0.02	0.381	0.459
	LTE Band 2	20M	QPSK	1	0	Back	19mm	1	-	Full	18900	1880	23.19	24.00	1.205	0.01	0.704	0.848
	LTE Band 7	20M	QPSK	1	0	Front	5mm	1	-	Reduced	21100	2535	16.79	18.00	1.321	0.01	0.677	0.895
	LTE Band 7	20M	QPSK	1	0	Front	5mm	1	-	Reduced	20850	2510	16.34	18.00	1.466	-0.05	0.644	0.944
	LTE Band 7	20M	QPSK	1	0	Front	5mm	1	-	Reduced	21350	2560	16.49	18.00	1.416	0.06	0.725	1.026
	LTE Band 7	20M	QPSK	50	0	Front	5mm	1	-	Reduced	21100	2535	15.54	17.00	1.400	0.03	0.567	0.794
	LTE Band 7	20M	QPSK	100	0	Front	5mm	1	-	Reduced	21100	2535	15.56	17.00	1.393	0.03	0.566	0.789
	LTE Band 7	20M	QPSK	1	0	Back	5mm	1	-	Reduced	21100	2535	16.79	18.00	1.321	-0.06	0.925	1.222
	LTE Band 7	20M	QPSK	1	0	Back	5mm	1	-	Reduced	20850	2510	16.34	18.00	1.466	-0.06	0.869	1.274
38	LTE Band 7	20M	QPSK	1	0	Back	5mm	1	-	Reduced	21350	2560	16.49	18.00	1.416	0.03	0.986	1.396
	LTE Band 7	20M	QPSK	1	0	Back	5mm	1	Headset1	Reduced	21350	2560	16.49	18.00	1.416	0.06	0.741	1.049
	LTE Band 7	20M	QPSK	1	0	Back	5mm	1	Headset2	Reduced	21350	2560	16.49	18.00	1.416	-0.01	0.752	1.065
	LTE Band 7	20M	QPSK	1	0	Back	5mm	1	Headset3	Reduced	21350	2560	16.49	18.00	1.416	0.06	0.748	1.059
	LTE Band 7	20M	QPSK	1	0	Back	5mm	1	Headset4	Reduced	21350	2560	16.49	18.00	1.416	0.03	0.794	1.124
	LTE Band 7	20M	QPSK	50	0	Back	5mm	1	-	Reduced	21100	2535	15.54	17.00	1.400	0.05	0.705	0.987
	LTE Band 7	20M	QPSK	50	0	Back	5mm	1	-	Reduced	20850	2510	15.42	17.00	1.439	0.03	0.647	0.931
	LTE Band 7	20M	QPSK	50	0	Back	5mm	1	-	Reduced	21350	2560	15.48	17.00	1.419	0.01	0.749	1.063
	LTE Band 7	20M	QPSK	100	0	Back	5mm	1	-	Reduced	21100	2535	15.56	17.00	1.393	-0.05	0.728	1.014
	LTE Band 7	20M	QPSK	1	0	Front	14mm	1	-	Full	21100	2535	22.98	24.00	1.265	0.03	0.651	0.823
	LTE Band 7	20M	QPSK	1	0	Back	19mm	1	-	Full	21100	2535	22.98	24.00	1.265	-0.06	0.448	0.567
	LTE Band 7	20M	QPSK	1	0	Back	5mm	2	-	Reduced	21350	2560	16.49	18.00	1.416	0.04	0.962	1.362
	LTE Band 12	10M	QPSK	1	0	Front	5mm	1	-	Full	23095	707.5	22.88	24.00	1.294	0.03	0.266	0.344
	LTE Band 12	10M	QPSK	25	0	Front	5mm	1	-	Full	23095	707.5	21.81	23.00	1.315	0.01	0.210	0.276
39	LTE Band 12	10M	QPSK	1	0	Back	5mm	1	-	Full	23095	707.5	22.88	24.00	1.294	0.02	0.485	0.628
	LTE Band 12	10M	QPSK	25	0	Back	5mm	1	-	Full	23095	707.5	21.81	23.00	1.315	-0.05	0.395	0.520
	LTE Band 12	10M	QPSK	1	0	Back	5mm	2	-	Full	23095	707.5	22.88	24.00	1.294	0.03	0.455	0.589
	LTE Band 13	10M	QPSK	1	0	Front	5mm	1	-	Full	23230	782	22.89	24.00	1.291	0.02	0.281	0.363
	LTE Band 13	10M	QPSK	25	0	Front	5mm	1	-	Full	23230	782	21.74	23.00	1.337	0.06	0.226	0.302
40	LTE Band 13	10M	QPSK	1	0	Back	5mm	1	-	Full	23230	782	22.89	24.00	1.291	0.02	0.470	0.607
	LTE Band 13	10M	QPSK	25	0	Back	5mm	1	-	Full	23230	782	21.74	23.00	1.337	-0.01	0.377	0.504
	LTE Band 26	15M	QPSK	1	0	Front	5mm	1	-	Full	26865	831.5	23.05	24.00	1.245	0.03	0.503	0.626
	LTE Band 26	15M	QPSK	36	0	Front	5mm	1	-	Full	26865	831.5	21.92	23.00	1.282	-0.04	0.405	0.519
41	LTE Band 26	15M	QPSK	1	0	Back	5mm	1	-	Full	26865	831.5	23.05	24.00	1.245	-0.03	0.782	0.973
	LTE Band 26	15M	QPSK	36	0	Back	5mm	1	-	Full	26865	831.5	21.92	23.00	1.282	0.04	0.617	0.791
	LTE Band 66	20M	QPSK	1	0	Front	5mm	1	-	Reduced	132322	1745	14.99	16.00	1.262	0.04	0.754	0.951
	LTE Band 66	20M	QPSK	1	0	Front	5mm	1	-	Reduced	132072	1720	14.98	16.00	1.265	0.02	0.759	0.960
	LTE Band 66	20M	QPSK	1	0	Front	5mm	1	-	Reduced	132572	1770	14.67	16.00	1.358	0.03	0.541	0.735
	LTE Band 66	20M	QPSK	50	0	Front	5mm	1	-	Reduced	132322	1745	14.03	15.00	1.250	0.01	0.610	0.763
	LTE Band 66	20M	QPSK	100	0	Front	5mm	1	-	Reduced	132322	1745	14.01	15.00	1.256	0.02	0.609	0.765
	LTE Band 66	20M	QPSK	1	0	Back	5mm	1	-	Reduced	132322	1745	14.99	16.00	1.262	0.06	1.090	1.375
	LTE Band 66	20M	QPSK	1	0	Back	5mm	1	-	Reduced	132072	1720	14.98	16.00	1.265	-0.01	1.110	1.404



**FCC SAR Test Report**

**Report No. : FA170131**

	LTE Band 66	20M	QPSK	1	0	Back	5mm	1	Headset1	Reduced	132072	1720	14.98	16.00	1.265	0.06	0.740	0.936
	LTE Band 66	20M	QPSK	1	0	Back	5mm	1	Headset2	Reduced	132072	1720	14.98	16.00	1.265	0.02	0.731	0.925
	LTE Band 66	20M	QPSK	1	0	Back	5mm	1	Headset3	Reduced	132072	1720	14.98	16.00	1.265	0.03	0.741	0.937
	LTE Band 66	20M	QPSK	1	0	Back	5mm	1	Headset4	Reduced	132072	1720	14.98	16.00	1.265	-0.06	0.724	0.916
	LTE Band 66	20M	QPSK	1	0	Back	5mm	1	-	Reduced	132572	1770	14.67	16.00	1.358	0.01	1.030	1.399
	LTE Band 66	20M	QPSK	50	0	Back	5mm	1	-	Reduced	132322	1745	14.03	15.00	1.250	-0.05	0.880	1.100
	LTE Band 66	20M	QPSK	50	0	Back	5mm	1	-	Reduced	132072	1720	13.96	15.00	1.271	0.01	0.879	1.117
	LTE Band 66	20M	QPSK	50	0	Back	5mm	1	-	Reduced	132572	1770	13.87	15.00	1.297	0.02	0.726	0.942
	LTE Band 66	20M	QPSK	100	0	Back	5mm	1	-	Reduced	132322	1745	14.01	15.00	1.256	0.03	0.838	1.053
42	LTE Band 66	20M	QPSK	1	0	Front	14mm	1	-	Full	132322	1745	22.85	24.00	1.303	0.06	1.080	<b>1.407</b>
	LTE Band 66	20M	QPSK	1	0	Front	14mm	1	-	Full	132072	1720	22.74	24.00	1.337	0.01	1.030	1.377
	LTE Band 66	20M	QPSK	1	0	Front	14mm	1	-	Full	132572	1770	22.72	24.00	1.343	-0.02	0.988	1.327
	LTE Band 66	20M	QPSK	1	0	Back	19mm	1	-	Full	132322	1745	22.85	24.00	1.303	0.03	0.954	1.243
	LTE Band 66	20M	QPSK	1	0	Front	14mm	1	Headset1	Full	132322	1745	22.85	24.00	1.303	0.06	0.855	1.114
	LTE Band 66	20M	QPSK	1	0	Front	14mm	1	Headset2	Full	132322	1745	22.85	24.00	1.303	0.01	0.873	1.138
	LTE Band 66	20M	QPSK	1	0	Front	14mm	1	Headset3	Full	132322	1745	22.85	24.00	1.303	0.05	0.825	1.075
	LTE Band 66	20M	QPSK	1	0	Front	14mm	1	Headset4	Full	132322	1745	22.85	24.00	1.303	-0.07	0.833	1.086



<WLAN2.4G SAR>

Plot No.	Band	Mode	Test Position	Gap (mm)	Sample	Headset	Power Reduction	Ch.	Freq. (MHz)	Average Power (dBm)	Tune-Up Limit (dBm)	Tune-up Scaling Factor	Duty Cycle %	Duty Cycle Scaling Factor	Power Drift (dB)	Measured 1g SAR (W/kg)	Reported 1g SAR (W/kg)
	WLAN2.4GHz	802.11b 1Mbps	Front	5mm	1	-	Full	11	2462	18.43	19.50	1.279	99.31	1.007	0.03	0.298	0.384
43	WLAN2.4GHz	802.11b 1Mbps	Back	5mm	1	-	Full	11	2462	18.43	19.50	1.279	99.31	1.007	0.01	0.512	0.660
	WLAN2.4GHz	802.11b 1Mbps	Back	5mm	2	-	Full	11	2462	18.43	19.50	1.279	99.31	1.007	0.01	0.498	0.642
	WLAN2.4GHz	802.11b 1Mbps	Front	14mm	1	-	Full	11	2462	18.43	19.50	1.279	99.31	1.007	0.02	0.087	0.112
	WLAN2.4GHz	802.11b 1Mbps	Back	19mm	1	-	Full	11	2462	18.43	19.50	1.279	99.31	1.007	0.03	0.102	0.131

<WLAN5G SAR>

Plot No.	Band	Mode	Test Position	Gap (mm)	Sample	Headset	Power Reduction	Ch.	Freq. (MHz)	Average Power (dBm)	Tune-Up Limit (dBm)	Tune-up Scaling Factor	Duty Cycle %	Duty Cycle Scaling Factor	Power Drift (dB)	Measured 1g SAR (W/kg)	Reported 1g SAR (W/kg)
	WLAN5.2GHz	802.11n-HT40 MCS0	Front	5mm	1	-	Full	46	5230	17.81	19.00	1.315	93.73	1.067	0.03	0.387	0.543
44	WLAN5.2GHz	802.11n-HT40 MCS0	Back	5mm	1	-	Full	46	5230	17.81	19.00	1.315	93.73	1.067	0.05	0.810	1.136
	WLAN5.2GHz	802.11n-HT40 MCS0	Back	5mm	1	-	Full	38	5190	12.93	14.00	1.279	93.73	1.067	0.01	0.194	0.265
	WLAN5.2GHz	802.11n-HT40 MCS0	Back	5mm	2	-	Full	46	5230	17.81	19.00	1.315	93.73	1.067	0.05	0.802	1.125
	WLAN5.2GHz	802.11n-HT40 MCS0	Front	14mm	1	-	Full	46	5230	17.81	19.00	1.315	93.73	1.067	0.01	0.064	0.090
	WLAN5.2GHz	802.11n-HT40 MCS0	Back	19mm	1	-	Full	46	5230	17.81	19.00	1.315	93.73	1.067	0.03	0.089	0.125
	WLAN5.3GHz	802.11n-HT40 MCS0	Front	5mm	1	-	Full	54	5270	17.90	19.00	1.288	93.73	1.067	0.03	0.404	0.555
45	WLAN5.3GHz	802.11n-HT40 MCS0	Back	5mm	1	-	Full	54	5270	17.90	19.00	1.288	93.73	1.067	-0.02	0.675	0.928
	WLAN5.3GHz	802.11n-HT40 MCS0	Back	5mm	1	-	Full	62	5310	13.48	14.50	1.264	93.73	1.067	0.09	0.339	0.457
	WLAN5.3GHz	802.11n-HT40 MCS0	Back	5mm	2	-	Full	54	5270	17.90	19.00	1.288	93.73	1.067	-0.02	0.506	0.695
	WLAN5.3GHz	802.11n-HT40 MCS0	Front	14mm	1	-	Full	54	5270	17.90	19.00	1.288	93.73	1.067	0.01	0.074	0.102
	WLAN5.3GHz	802.11n-HT40 MCS0	Back	19mm	1	-	Full	54	5270	17.90	19.00	1.288	93.73	1.067	-0.08	0.099	0.136
	WLAN5.5GHz	802.11ac-VHT80 MCS0	Front	5mm	1	-	Full	138	5690	17.53	19.00	1.404	88.19	1.134	-0.01	0.216	0.344
46	WLAN5.5GHz	802.11ac-VHT80 MCS0	Back	5mm	1	-	Full	138	5690	17.53	19.00	1.404	88.19	1.134	0.05	0.726	1.156
	WLAN5.5GHz	802.11ac-VHT80 MCS0	Back	5mm	1	-	Full	122	5610	16.38	17.50	1.295	88.19	1.134	0.06	0.559	0.821
	WLAN5.5GHz	802.11ac-VHT80 MCS0	Back	5mm	2	-	Full	138	5690	17.53	19.00	1.404	88.19	1.134	0.05	0.637	1.014
	WLAN5.5GHz	802.11ac-VHT80 MCS0	Front	14mm	1	-	Full	138	5690	17.53	19.00	1.404	88.19	1.134	0.06	0.065	0.104
	WLAN5.5GHz	802.11ac-VHT80 MCS0	Back	19mm	1	-	Full	138	5690	17.53	19.00	1.404	88.19	1.134	0.03	0.095	0.151
	WLAN5.8GHz	802.11ac-VHT80 MCS0	Front	5mm	1	-	Full	155	5775	17.66	19.00	1.363	88.19	1.134	0.02	0.244	0.377
47	WLAN5.8GHz	802.11ac-VHT80 MCS0	Back	5mm	1	-	Full	155	5775	17.66	19.00	1.363	88.19	1.134	-0.06	0.743	1.148
	WLAN5.8GHz	802.11ac-VHT80 MCS0	Back	5mm	2	-	Full	155	5775	17.66	19.00	1.363	88.19	1.134	-0.06	0.662	1.023
	WLAN5.8GHz	802.11ac-VHT80 MCS0	Front	14mm	1	-	Full	155	5775	17.66	19.00	1.363	88.19	1.134	0.02	0.031	0.048
	WLAN5.8GHz	802.11ac-VHT80 MCS0	Back	19mm	1	-	Full	155	5775	17.66	19.00	1.363	88.19	1.134	-0.06	0.065	0.100

<Bluetooth SAR>

Plot No.	Band	Mode	Test Position	Gap (mm)	Sample	Headset	Power Reduction	Ch.	Freq. (MHz)	Average Power (dBm)	Tune-Up Limit (dBm)	Tune-up Scaling Factor	Duty Cycle %	Duty Cycle Scaling Factor	Power Drift (dB)	Measured 1g SAR (W/kg)	Reported 1g SAR (W/kg)
	Bluetooth	1Mbps	Front	5mm	1	-	Full	39	2441	10.21	11.00	1.199	76.91	1.300	0.01	0.038	0.059
48	Bluetooth	1Mbps	Back	5mm	1	-	Full	39	2441	10.21	11.00	1.199	76.91	1.300	-0.06	0.070	0.109
	Bluetooth	1Mbps	Back	5mm	2	-	Full	39	2441	10.21	11.00	1.199	76.91	1.300	0.04	0.051	0.080



15.4 Product specific 10g SAR

<GSM SAR>

Plot No.	Band	Mode	Test Position	Gap (mm)	Sample	Power Reduction	Ch.	Freq. (MHz)	Average Power (dBm)	Tune-Up Limit (dBm)	Tune-up Scaling Factor	Power Drift (dB)	Measured 10g SAR (W/kg)	Reported 10g SAR (W/kg)
	GSM1900	GPRS (2 Tx slots)	Front	0mm	1	Reduced	661	1880	24.56	25.50	1.242	-0.05	0.856	1.063
	GSM1900	GPRS (2 Tx slots)	Back	0mm	1	Reduced	661	1880	24.56	25.50	1.242	0.03	1.325	1.645
	GSM1900	GPRS (2 Tx slots)	Bottom Side	0mm	1	Reduced	661	1880	24.56	25.50	1.242	0.05	2.091	2.596
49	GSM1900	GPRS (2 Tx slots)	Bottom Side	0mm	1	Reduced	512	1850.2	24.50	25.50	1.259	0.03	2.330	2.933
	GSM1900	GPRS (2 Tx slots)	Bottom Side	0mm	1	Reduced	810	1909.8	24.53	25.50	1.250	0.01	2.011	2.514
	GSM1900	GPRS (2 Tx slots)	Front	9mm	1	Full	661	1880	26.30	27.50	1.318	0.04	0.348	0.459
	GSM1900	GPRS (2 Tx slots)	Back	17mm	1	Full	661	1880	26.30	27.50	1.318	0.02	0.199	0.262
	GSM1900	GPRS (2 Tx slots)	Bottom Side	17mm	1	Full	661	1880	26.30	27.50	1.318	0.03	0.289	0.381

<WCDMA SAR>

Plot No.	Band	Mode	Test Position	Gap (mm)	Sample	Power Reduction	Ch.	Freq. (MHz)	Average Power (dBm)	Tune-Up Limit (dBm)	Tune-up Scaling Factor	Power Drift (dB)	Measured 10g SAR (W/kg)	Reported 10g SAR (W/kg)
	WCDMA II	RMC 12.2Kbps	Front	0mm	1	Reduced	9400	1880	17.98	19.00	1.265	0.02	1.073	1.357
	WCDMA II	RMC 12.2Kbps	Back	0mm	1	Reduced	9400	1880	17.98	19.00	1.265	0.01	1.590	2.011
	WCDMA II	RMC 12.2Kbps	Back	0mm	1	Reduced	9262	1852.4	17.92	19.00	1.282	-0.05	1.981	2.540
	WCDMA II	RMC 12.2Kbps	Back	0mm	1	Reduced	9538	1907.6	17.94	19.00	1.276	0.01	1.340	1.710
	WCDMA II	RMC 12.2Kbps	Bottom Side	0mm	1	Reduced	9400	1880	17.98	19.00	1.265	0.02	2.332	2.949
50	WCDMA II	RMC 12.2Kbps	Bottom Side	0mm	1	Reduced	9262	1852.4	17.92	19.00	1.282	0.03	2.610	3.347
	WCDMA II	RMC 12.2Kbps	Bottom Side	0mm	1	Reduced	9538	1907.6	17.94	19.00	1.276	-0.06	2.066	2.637
	WCDMA II	RMC 12.2Kbps	Front	9mm	1	Full	9400	1880	22.75	24.00	1.334	0.01	0.721	0.961
	WCDMA II	RMC 12.2Kbps	Back	17mm	1	Full	9262	1852.4	22.69	24.00	1.352	0.02	0.408	0.552
	WCDMA II	RMC 12.2Kbps	Bottom Side	17mm	1	Full	9262	1852.4	22.69	24.00	1.352	0.02	0.616	0.833
	WCDMA IV	RMC 12.2Kbps	Front	0mm	1	Reduced	1413	1732.6	17.21	18.50	1.346	0.04	1.737	2.338
	WCDMA IV	RMC 12.2Kbps	Front	0mm	1	Reduced	1312	1712.4	17.20	18.50	1.349	0.02	1.766	2.382
	WCDMA IV	RMC 12.2Kbps	Front	0mm	1	Reduced	1513	1752.6	17.18	18.50	1.355	0.03	1.541	2.088
	WCDMA IV	RMC 12.2Kbps	Back	0mm	1	Reduced	1413	1732.6	17.21	18.50	1.346	0.01	1.789	2.408
	WCDMA IV	RMC 12.2Kbps	Back	0mm	1	Reduced	1312	1712.4	17.20	18.50	1.349	-0.05	1.870	2.523
	WCDMA IV	RMC 12.2Kbps	Back	0mm	1	Reduced	1513	1752.6	17.18	18.50	1.355	0.01	1.627	2.205
	WCDMA IV	RMC 12.2Kbps	Bottom Side	0mm	1	Reduced	1413	1732.6	17.21	18.50	1.346	-0.03	2.523	3.396
51	WCDMA IV	RMC 12.2Kbps	Bottom Side	0mm	1	Reduced	1312	1712.4	17.20	18.50	1.349	-0.05	2.640	3.561
	WCDMA IV	RMC 12.2Kbps	Bottom Side	0mm	2	Reduced	1312	1712.4	17.20	18.50	1.349	0.02	2.530	3.413
	WCDMA IV	RMC 12.2Kbps	Bottom Side	0mm	1	Reduced	1513	1752.6	17.18	18.50	1.355	0.03	2.460	3.334
	WCDMA IV	RMC 12.2Kbps	Front	9mm	1	Full	1312	1712.4	22.48	24.00	1.419	0.02	1.380	1.958
	WCDMA IV	RMC 12.2Kbps	Back	17mm	1	Full	1312	1712.4	22.48	24.00	1.419	0.04	0.716	1.016
	WCDMA IV	RMC 12.2Kbps	Bottom Side	17mm	1	Full	1312	1712.4	22.48	24.00	1.419	0.01	0.893	1.267



<FDD LTE SAR>

Plot No.	Band	BW (MHz)	Modulation	RB Size	RB offset	Test Position	Gap (mm)	Sample	Power Reduction	Ch.	Freq. (MHz)	Average Power (dBm)	Tune-Up Limit (dBm)	Tune-up Scaling Factor	Power Drift (dB)	Measured 10g SAR (W/kg)	Reported 10g SAR (W/kg)
	LTE Band 2	20M	QPSK	1	0	Front	0mm	1	Reduced	18900	1880	17.88	19.00	1.294	-0.05	1.106	1.431
	LTE Band 2	20M	QPSK	50	0	Front	0mm	1	Reduced	18900	1880	16.84	18.00	1.306	0.06	0.908	1.186
	LTE Band 2	20M	QPSK	1	0	Back	0mm	1	Reduced	18900	1880	17.88	19.00	1.294	0.03	1.769	2.289
	LTE Band 2	20M	QPSK	1	0	Back	0mm	1	Reduced	18700	1860	17.64	19.00	1.368	0.05	1.852	2.533
	LTE Band 2	20M	QPSK	1	0	Back	0mm	1	Reduced	19100	1900	17.60	19.00	1.380	0.06	1.555	2.146
	LTE Band 2	20M	QPSK	50	0	Back	0mm	1	Reduced	18900	1880	16.84	18.00	1.306	0.01	1.426	1.863
	LTE Band 2	20M	QPSK	100	0	Back	0mm	1	Reduced	18900	1880	16.81	18.00	1.315	0.01	1.449	1.906
	LTE Band 2	20M	QPSK	1	0	Bottom Side	0mm	1	Reduced	18900	1880	17.88	19.00	1.294	-0.05	2.528	3.272
52	LTE Band 2	20M	QPSK	1	0	Bottom Side	0mm	1	Reduced	18700	1860	17.64	19.00	1.368	0.01	2.490	3.406
	LTE Band 2	20M	QPSK	1	0	Bottom Side	0mm	1	Reduced	19100	1900	17.60	19.00	1.380	0.02	2.320	3.202
	LTE Band 2	20M	QPSK	50	0	Bottom Side	0mm	1	Reduced	18900	1880	16.84	18.00	1.306	0.03	2.024	2.644
	LTE Band 2	20M	QPSK	50	0	Bottom Side	0mm	1	Reduced	18700	1860	16.81	18.00	1.315	-0.06	2.229	2.932
	LTE Band 2	20M	QPSK	50	0	Bottom Side	0mm	1	Reduced	19100	1900	16.78	18.00	1.324	0.03	1.820	2.410
	LTE Band 2	20M	QPSK	100	0	Bottom Side	0mm	1	Reduced	18900	1880	16.81	18.00	1.315	0.05	2.024	2.662
	LTE Band 2	20M	QPSK	1	0	Front	9mm	1	Full	18900	1880	23.19	24.00	1.205	-0.05	0.834	1.005
	LTE Band 2	20M	QPSK	1	0	Back	17mm	1	Full	18900	1880	23.19	24.00	1.205	0.05	0.499	0.601
	LTE Band 2	20M	QPSK	1	0	Bottom Side	17mm	1	Full	18900	1880	23.19	24.00	1.205	0.04	0.680	0.819
	LTE Band 2	20M	QPSK	1	0	Bottom Side	0mm	2	Reduced	18700	1860	17.64	19.00	1.368	0.01	2.380	3.255
	LTE Band 7	20M	QPSK	1	0	Front	0mm	1	Reduced	21100	2535	17.46	18.50	1.271	0.03	1.888	2.399
	LTE Band 7	20M	QPSK	1	0	Front	0mm	1	Reduced	20850	2510	17.22	18.50	1.343	0.05	1.820	2.444
	LTE Band 7	20M	QPSK	1	0	Front	0mm	1	Reduced	21350	2560	17.42	18.50	1.282	0.03	1.976	2.534
	LTE Band 7	20M	QPSK	50	0	Front	0mm	1	Reduced	21100	2535	16.33	17.50	1.309	0.01	1.526	1.998
	LTE Band 7	20M	QPSK	100	0	Front	0mm	1	Reduced	21100	2535	16.12	17.50	1.374	0.03	1.513	2.079
	LTE Band 7	20M	QPSK	1	0	Back	0mm	1	Reduced	21100	2535	17.46	18.50	1.271	0.06	2.265	2.878
	LTE Band 7	20M	QPSK	1	0	Back	0mm	1	Reduced	20850	2510	17.22	18.50	1.343	0.02	2.214	2.973
53	LTE Band 7	20M	QPSK	1	0	Back	0mm	1	Reduced	21350	2560	17.42	18.50	1.282	-0.06	2.330	2.988
	LTE Band 7	20M	QPSK	50	0	Back	0mm	1	Reduced	21100	2535	16.33	17.50	1.309	0.06	1.825	2.389
	LTE Band 7	20M	QPSK	50	0	Back	0mm	1	Reduced	20850	2510	16.28	17.50	1.324	-0.01	1.742	2.307
	LTE Band 7	20M	QPSK	50	0	Back	0mm	1	Reduced	21350	2560	16.09	17.50	1.384	0.01	1.847	2.555
	LTE Band 7	20M	QPSK	100	0	Back	0mm	1	Reduced	21100	2535	16.12	17.50	1.374	-0.05	1.787	2.455
	LTE Band 7	20M	QPSK	1	0	Bottom Side	0mm	1	Reduced	21100	2535	17.46	18.50	1.271	0.01	1.194	1.517
	LTE Band 7	20M	QPSK	50	0	Bottom Side	0mm	1	Reduced	21100	2535	16.33	17.50	1.309	0.03	0.968	1.267
	LTE Band 7	20M	QPSK	1	0	Front	6mm	1	Full	21100	2535	22.98	24.00	1.265	0.01	1.660	2.099
	LTE Band 7	20M	QPSK	1	0	Back	9mm	1	Full	21100	2535	22.98	24.00	1.265	0.03	1.100	1.391
	LTE Band 7	20M	QPSK	1	0	Bottom Side	9mm	1	Full	21100	2535	22.98	24.00	1.265	-0.01	0.854	1.080
	LTE Band 7	20M	QPSK	1	0	Back	0mm	2	Reduced	21350	2560	17.42	18.50	1.282	-0.06	2.160	2.770
	LTE Band 66	20M	QPSK	1	0	Front	0mm	1	Reduced	132322	1745	16.98	18.00	1.265	0.05	1.486	1.879
	LTE Band 66	20M	QPSK	50	0	Front	0mm	1	Reduced	132322	1745	15.82	17.00	1.312	0.08	1.184	1.554
	LTE Band 66	20M	QPSK	1	0	Back	0mm	1	Reduced	132322	1745	16.98	18.00	1.265	0.01	1.568	1.983
	LTE Band 66	20M	QPSK	50	0	Back	0mm	1	Reduced	132322	1745	15.82	17.00	1.312	0.02	1.269	1.665
	LTE Band 66	20M	QPSK	1	0	Bottom Side	0mm	1	Reduced	132322	1745	16.98	18.00	1.265	0.02	2.360	2.985
54	LTE Band 66	20M	QPSK	1	0	Bottom Side	0mm	1	Reduced	132072	1720	16.76	18.00	1.330	0.01	2.420	3.220
	LTE Band 66	20M	QPSK	1	0	Bottom Side	0mm	1	Reduced	132572	1770	16.90	18.00	1.288	-0.04	2.205	2.841
	LTE Band 66	20M	QPSK	50	0	Bottom Side	0mm	1	Reduced	132322	1745	15.82	17.00	1.312	0.03	1.871	2.455
	LTE Band 66	20M	QPSK	50	0	Bottom Side	0mm	1	Reduced	132072	1720	15.73	17.00	1.340	0.04	1.913	2.563
	LTE Band 66	20M	QPSK	50	0	Bottom Side	0mm	1	Reduced	132572	1770	15.85	17.00	1.303	0.04	1.771	2.308
	LTE Band 66	20M	QPSK	100	0	Bottom Side	0mm	1	Reduced	132322	1745	15.71	17.00	1.346	0.02	1.831	2.464
	LTE Band 66	20M	QPSK	1	0	Front	9mm	1	Full	132322	1745	22.85	24.00	1.303	0.06	1.470	1.916
	LTE Band 66	20M	QPSK	1	0	Back	17mm	1	Full	132322	1745	22.85	24.00	1.303	-0.05	0.773	1.007
	LTE Band 66	20M	QPSK	1	0	Bottom Side	17mm	1	Full	132072	1720	22.74	24.00	1.337	-0.06	0.916	1.224



<WLAN5G SAR>

Plot No.	Band	Mode	Test Position	Gap (mm)	Sample	Power Reduction	Ch.	Freq. (MHz)	Average Power (dBm)	Tune-Up Limit (dBm)	Tune-up Scaling Factor	Duty Cycle %	Duty Cycle Scaling Factor	Power Drift (dB)	Measured 10g SAR (W/kg)	Reported 10g SAR (W/kg)
55	WLAN5.2GHz	802.11n-HT40 MCS0	Top Side	0mm	1	Full	46	5230	17.81	19.00	1.315	93.73	1.067	-0.02	1.370	1.922
	WLAN5.2GHz	802.11n-HT40 MCS0	Top Side	0mm	2	Full	46	5230	17.81	19.00	1.315	93.73	1.067	0.09	1.210	1.697
	WLAN5.3GHz	802.11n-HT40 MCS0	Front	0mm	1	Full	54	5270	17.90	19.00	1.288	93.73	1.067	0.01	0.417	0.573
	WLAN5.3GHz	802.11n-HT40 MCS0	Back	0mm	1	Full	54	5270	17.90	19.00	1.288	93.73	1.067	-0.05	0.452	0.621
	WLAN5.3GHz	802.11n-HT40 MCS0	Left Side	0mm	1	Full	54	5270	17.90	19.00	1.288	93.73	1.067	0.06	0.186	0.256
	WLAN5.3GHz	802.11n-HT40 MCS0	Right Side	0mm	1	Full	54	5270	17.90	19.00	1.288	93.73	1.067	0.01	0.822	1.130
56	WLAN5.3GHz	802.11n-HT40 MCS0	Top Side	0mm	1	Full	54	5270	17.90	19.00	1.288	93.73	1.067	0.06	1.410	1.937
	WLAN5.3GHz	802.11n-HT40 MCS0	Top Side	0mm	2	Full	54	5270	17.90	19.00	1.288	93.73	1.067	0.06	1.190	1.635
	WLAN5.5GHz	802.11ac-VHT80 MCS0	Front	0mm	1	Full	138	5690	17.53	19.00	1.404	88.19	1.134	-0.01	0.227	0.361
	WLAN5.5GHz	802.11ac-VHT80 MCS0	Back	0mm	1	Full	138	5690	17.53	19.00	1.404	88.19	1.134	0.01	0.429	0.683
	WLAN5.5GHz	802.11ac-VHT80 MCS0	Left Side	0mm	1	Full	138	5690	17.53	19.00	1.404	88.19	1.134	-0.06	0.050	0.080
	WLAN5.5GHz	802.11ac-VHT80 MCS0	Right Side	0mm	1	Full	138	5690	17.53	19.00	1.404	88.19	1.134	0.03	0.273	0.435
57	WLAN5.5GHz	802.11ac-VHT80 MCS0	Top Side	0mm	1	Full	138	5690	17.53	19.00	1.404	88.19	1.134	0.04	1.000	1.592
	WLAN5.5GHz	802.11ac-VHT80 MCS0	Top Side	0mm	2	Full	138	5690	17.53	19.00	1.404	88.19	1.134	0.04	0.991	1.578
58	WLAN5.8GHz	802.11ac-VHT80 MCS0	Top Side	0mm	1	Full	155	5775	17.66	19.00	1.363	88.19	1.134	-0.05	0.706	1.091
	WLAN5.8GHz	802.11ac-VHT80 MCS0	Top Side	0mm	2	Full	155	5775	17.66	19.00	1.363	88.19	1.134	0.02	0.688	1.063



15.5 Repeated SAR Measurement

<1g>

Plot No.	Band	BW (MHz)	Modulation	RB Size	RB offset	Mode	Test Position	Gap (mm)	Sample	Headset	Power Reduction	Ch.	Freq. (MHz)	Average Power (dBm)	Tune-Up Limit (dBm)	Tune-up Scaling Factor	Duty Cycle %	Duty Cycle Scaling Factor	Power Drift (dB)	Measured 1g SAR (W/kg)	Ratio	Reported 1g SAR (W/kg)
1st	GSM850	-	-	-	-	GPRS (2 Tx slots)	Back	5mm	1	-	Full	189	836.4	30.15	31.00	1.216		1.000	0.02	0.900	1	1.095
2nd	GSM850	-	-	-	-	GPRS (2 Tx slots)	Back	5mm	1	-	Full	189	836.4	30.15	31.00	1.216		1.000	0.03	0.875	1.029	1.064
1st	LTE Band 2	20M	QPSK	1	0	-	Back	5mm	1	-	Reduced	18700	1860	14.50	15.50	1.259		1.000	0.03	1.130	1	1.423
2nd	LTE Band 2	20M	QPSK	1	0	-	Back	5mm	1	-	Reduced	18700	1860	14.50	15.50	1.259		1.000	0.02	1.060	1.066	1.334
1st	LTE Band 7	20M	QPSK	1	0	-	Back	5mm	1	-	Reduced	21350	2560	16.49	18.00	1.416		1.000	0.03	0.986	1	1.396
2nd	LTE Band 7	20M	QPSK	1	0	-	Back	5mm	1	-	Reduced	21350	2560	16.49	18.00	1.416		1.000	0.02	0.921	1.071	1.304
1st	WLAN5.2GHz	-	-	-	-	802.11n-HT40 MCS0	Top Side	5mm	1	-	hotspot	46	5230	15.40	16.50	1.288	93.73	1.067	0.01	0.827	1	1.137
2nd	WLAN5.2GHz	-	-	-	-	802.11n-HT40 MCS0	Top Side	5mm	1	-	hotspot	46	5230	15.40	16.50	1.288	93.73	1.067	0.02	0.814	1.016	1.119
1st	LTE Band 66	20M	QPSK	1	0	-	Back	5mm	1	-	Reduced	132072	1720	14.98	16.00	1.265		1.000	-0.01	1.110	1	1.404
2nd	LTE Band 66	20M	QPSK	1	0	-	Back	5mm	1	-	Reduced	132072	1720	14.98	16.00	1.265		1.000	0.02	1.080	1.027	1.366

<10g>

Plot No.	Band	BW (MHz)	Modulation	RB Size	RB offset	Mode	Test Position	Gap (mm)	Sample	Power Reduction	Ch.	Freq. (MHz)	Average Power (dBm)	Tune-Up Limit (dBm)	Tune-up Scaling Factor	Power Drift (dB)	Measured 10g SAR (W/kg)	Ratio	Reported 10g SAR (W/kg)
1st	WCDMA IV	-	-	-	-	RMC 12.2Kbps	Bottom Side	0mm	1	Reduced	1312	1712.4	17.20	18.50	1.349	-0.05	2.640	1	3.561
2nd	WCDMA IV	-	-	-	-	RMC 12.2Kbps	Bottom Side	0mm	1	Reduced	1312	1712.4	17.20	18.50	1.349	0.03	2.540	1.039	3.426
1st	WCDMA II	-	-	-	-	RMC 12.2Kbps	Bottom Side	0mm	1	Reduced	9262	1852.4	17.92	19.00	1.282	0.03	2.610	1	3.347
2nd	WCDMA II	-	-	-	-	RMC 12.2Kbps	Bottom Side	0mm	1	Reduced	9262	1852.4	17.92	19.00	1.282	0.01	2.540	1.028	3.257
1st	LTE Band 7	20M	QPSK	1	0	-	Back	0mm	1	Reduced	21350	2560	17.42	18.50	1.282	-0.06	2.330	1	2.988
2nd	LTE Band 7	20M	QPSK	1	0	-	Back	0mm	1	Reduced	21350	2560	17.42	18.50	1.282	0.02	2.070	1.126	2.654

General Note:

- Per KDB 865664 D01v01r04, for each frequency band, repeated SAR measurement is required only when the measured SAR is  $\geq 0.8W/kg$ .
- Per KDB 865664 D01v01r04, if the ratio among the repeated measurement is  $\leq 1.2$  and the measured SAR  $< 1.45W/kg$ , only one repeated measurement is required.
- Per KDB 865664 D01v01r04, if the extremity repeated SAR is necessary, the same procedures should be adapted for measurements according to extremity and occupational exposure limits by applying a factor of 2.5 for extremity exposure and a factor of 5 for occupational exposure to the corresponding SAR thresholds.
- The ratio is the difference in percentage between original and repeated *measured SAR*.
- All measurement SAR result is scaled-up to account for tune-up tolerance and is compliant.

## 16. Simultaneous Transmission Analysis

No.	Simultaneous Transmission Configurations	Portable Handset			
		Head	Body-worn	Hotspot	Product specific 10g SAR
1.	WWAN + WLAN2.4GHz	Yes	Yes	Yes	Yes
2.	WWAN + WLAN5GHz	Yes	Yes	Yes	Yes
3.	WWAN + Bluetooth	Yes	Yes	Yes	Yes

**General Note:**

1. This device supports VoIP in GPRS, EGPRS, WCDMA and LTE (e.g. for 3rd-party VoIP), LTE supports VoLTE operation.
2. EUT will choose each GSM, WCDMA and LTE according to the network signal condition; therefore, they will not operate simultaneously at any moment.
3. This device 2.4GHz WLAN support hotspot operation and Bluetooth support tethering applications.
4. This device 5.2GHz WLAN/5.8GHz WLAN support hotspot operation, and 5.2GHz WLAN/5.8GHz WLAN supports WLAN Direct (GC/GO), and 5.3GHz / 5.5GHz supports WLAN Direct (GC only).
5. WIFI 5.3/5.3GHz has no hotspot function.
6. The worst case 5 GHz WLAN SAR for each configuration was used for SAR summation.
7. WLAN 2.4GHz and Bluetooth share the same antenna so can't transmit simultaneously.
8. According to the EUT characteristic, WLAN 5GHz and Bluetooth can't transmit simultaneously.
9. According to the EUT characteristic, WLAN 5GHz and WLAN 2.4GHz can't transmit simultaneously.
10. The maximum SAR summation is calculated based on the same configuration and test position.
11. For body, WLAN front 14mm, back 19mm distance SAR performed to do co-located with WWAN analysis.
12. Per KDB 447498 D01v06, simultaneous transmission SAR is compliant if,
  - ii) 1g Scalar SAR summation < 1.6W/kg and 10g Scalar SAR summation < 4.0W/kg.
  - iii)  $SPLSR = (SAR1 + SAR2)^{1.5} / (\min. \text{ separation distance, mm})$ , and the peak separation distance is determined from the square root of  $[(x1-x2)^2 + (y1-y2)^2 + (z1-z2)^2]$ , where (x1, y1, z1) and (x2, y2, z2) are the coordinates of the extrapolated peak SAR locations in the zoom scan.
  - iv) If  $SPLSR \leq 0.04$  for 1g SAR and  $SPLSR \leq 0.10$  for 10g SAR, simultaneously transmission SAR measurement is not necessary.
  - v) Simultaneously transmission SAR measurement, and the reported multi-band 1g SAR < 1.6W/kg and 10g SAR < 4.0W/kg.
  - vi) The SPLSR calculated results please refer to section 16.5.



16.1 Head Exposure Conditions

WWAN Band		Exposure Position	1	2	3	4	1+2	1+3	1+4
			WWAN 1g SAR (W/kg)	2.4GHz WLAN 1g SAR (W/kg)	5GHz WLAN 1g SAR (W/kg)	Bluetooth 1g SAR (W/kg)	Summed 1g SAR (W/kg)	Summed 1g SAR (W/kg)	Summed 1g SAR (W/kg)
GSM	GSM850	Right Cheek	0.443	0.322	0.713	0.050	0.77	1.16	0.49
		Right Tilted	0.316	0.361	1.014	0.044	0.68	1.33	0.36
		Left Cheek	0.429	0.553	0.721	0.145	0.98	1.15	0.57
		Left Tilted	0.257	0.812	1.154	0.101	1.07	1.41	0.36
	GSM1900	Right Cheek	0.096	0.322	0.713	0.050	0.42	0.81	0.15
		Right Tilted	0.076	0.361	1.014	0.044	0.44	1.09	0.12
		Left Cheek	0.092	0.553	0.680	0.145	0.65	0.77	0.24
		Left Tilted	0.088	0.812	1.154	0.101	0.90	1.24	0.19
WCDMA	WCDMA II	Right Cheek	0.139	0.322	0.713	0.050	0.46	0.85	0.19
		Right Tilted	0.103	0.361	1.014	0.044	0.46	1.12	0.15
		Left Cheek	0.144	0.553	0.680	0.145	0.70	0.82	0.29
		Left Tilted	0.141	0.812	1.154	0.101	0.95	1.30	0.24
	WCDMA IV	Right Cheek	0.333	0.322	0.713	0.050	0.66	1.05	0.38
		Right Tilted	0.218	0.361	1.014	0.044	0.58	1.23	0.26
		Left Cheek	0.278	0.553	0.680	0.145	0.83	0.96	0.42
		Left Tilted	0.216	0.812	1.154	0.101	1.03	1.37	0.32
	WCDMA V	Right Cheek	0.513	0.322	0.713	0.050	0.84	1.23	0.56
		Right Tilted	0.370	0.361	1.014	0.044	0.73	1.38	0.41
		Left Cheek	0.503	0.553	0.680	0.145	1.06	1.18	0.65
		Left Tilted	0.311	0.812	1.154	0.101	1.12	1.47	0.41
LTE	LTE Band 2	Right Cheek	0.147	0.322	0.713	0.050	0.47	0.86	0.20
		Right Tilted	0.128	0.361	1.014	0.044	0.49	1.14	0.17
		Left Cheek	0.147	0.553	0.680	0.145	0.70	0.83	0.29
		Left Tilted	0.159	0.812	1.154	0.101	0.97	1.31	0.26
	LTE Band 7	Right Cheek	0.478	0.322	0.713	0.050	0.80	1.19	0.53
		Right Tilted	0.369	0.361	1.014	0.044	0.73	1.38	0.41
		Left Cheek	0.824	0.553	0.680	0.145	1.38	1.50	0.97
		Left Tilted	0.347	0.812	1.154	0.101	1.16	1.50	0.45
	LTE Band 12	Right Cheek	0.511	0.322	0.713	0.050	0.83	1.22	0.56
		Right Tilted	0.333	0.361	1.014	0.044	0.69	1.35	0.38
		Left Cheek	0.465	0.553	0.680	0.145	1.02	1.15	0.61
		Left Tilted	0.267	0.812	1.154	0.101	1.08	1.42	0.37
	LTE Band 13	Right Cheek	0.386	0.322	0.713	0.050	0.71	1.10	0.44
		Right Tilted	0.303	0.361	1.014	0.044	0.66	1.32	0.35
		Left Cheek	0.354	0.553	0.680	0.145	0.91	1.03	0.50
		Left Tilted	0.244	0.812	1.154	0.101	1.06	1.40	0.35
	LTE Band 26	Right Cheek	0.488	0.322	0.713	0.050	0.81	1.20	0.54
		Right Tilted	0.356	0.361	1.014	0.044	0.72	1.37	0.40
		Left Cheek	0.475	0.553	0.680	0.145	1.03	1.16	0.62
		Left Tilted	0.285	0.812	1.154	0.101	1.10	1.44	0.39
	LTE Band 66	Right Cheek	0.326	0.322	0.713	0.050	0.65	1.04	0.38
		Right Tilted	0.209	0.361	1.014	0.044	0.57	1.22	0.25
		Left Cheek	0.276	0.553	0.680	0.145	0.83	0.96	0.42
		Left Tilted	0.228	0.812	1.154	0.101	1.04	1.38	0.33



16.2 Hotspot Exposure Conditions

WWAN Band		Exposure Position	1	2	3	4	1+2	1+3	1+4	Case No
			WWAN 1g SAR (W/kg)	2.4GHz WLAN 1g SAR (W/kg)	5GHz WLAN 1g SAR (W/kg)	Bluetooth 1g SAR (W/kg)	Summed 1g SAR (W/kg)	Summed 1g SAR (W/kg)	Summed 1g SAR (W/kg)	
GSM	GSM850	Front	0.836	0.384	0.322	0.059	1.22	1.16	0.90	
		Back	1.095	0.660	0.906	0.109	1.76	2.00	1.20	1/2
		Left side	0.439	0.049	0.138	0.009	0.49	0.58	0.45	
		Right side	0.603	0.441	0.543	0.072	1.04	1.15	0.68	
		Top side		0.629	1.137	0.092	0.63	1.14	0.09	
		Bottom side	0.918				0.92	0.92	0.92	
	GSM1900	Front	0.584	0.384	0.322	0.059	0.97	0.91	0.64	
		Back	1.391	0.660	0.906	0.109	2.05	2.30	1.50	3/4
		Left side	0.045	0.049	0.138	0.009	0.09	0.18	0.05	
		Right side	0.052	0.441	0.543	0.072	0.49	0.60	0.12	
		Top side		0.629	1.137	0.092	0.63	1.14	0.09	
		Bottom side	1.335				1.34	1.34	1.34	
WCDMA	WCDMA II	Front	0.586	0.384	0.322	0.059	0.97	0.91	0.65	
		Back	1.325	0.660	0.906	0.097	1.99	2.23	1.42	5/6
		Left side	0.038	0.049	0.138	0.009	0.09	0.18	0.05	
		Right side	0.041	0.441	0.543	0.072	0.48	0.58	0.11	
		Top side		0.629	1.137	0.092	0.63	1.14	0.09	
		Bottom side	1.222				1.22	1.22	1.22	
	WCDMA IV	Front	0.790	0.384	0.322	0.059	1.17	1.11	0.85	
		Back	1.443	0.660	0.906	0.097	2.10	2.35	1.54	7/8
		Left side	0.039	0.049	0.138	0.009	0.09	0.18	0.05	
		Right side	0.120	0.441	0.543	0.072	0.56	0.66	0.19	
		Top side		0.629	1.137	0.092	0.63	1.14	0.09	
		Bottom side	1.430				1.43	1.43	1.43	
	WCDMA V	Front	1.008	0.384	0.322	0.059	1.39	1.33	1.07	
		Back	1.176	0.660	0.906	0.097	1.84	2.08	1.27	9/10
		Left side	0.477	0.049	0.138	0.009	0.53	0.62	0.49	
		Right side	0.672	0.441	0.543	0.072	1.11	1.22	0.74	
		Top side		0.629	1.137	0.092	0.63	1.14	0.09	
		Bottom side	0.961				0.96	0.96	0.96	
LTE	LTE Band 2	Front	0.539	0.384	0.322	0.059	0.92	0.86	0.60	
		Back	1.423	0.660	0.906	0.097	2.08	2.33	1.52	11/12
		Left side	0.039	0.049	0.138	0.009	0.09	0.18	0.05	
		Right side	0.044	0.441	0.543	0.072	0.49	0.59	0.12	
		Top side		0.629	1.137	0.092	0.63	1.14	0.09	
		Bottom side	1.260				1.26	1.26	1.26	
	LTE Band 7	Front	1.026	0.384	0.322	0.059	1.41	1.35	1.09	
		Back	1.396	0.660	0.906	0.097	2.06	2.30	1.49	13/14
		Left side	0.490	0.049	0.138	0.009	0.54	0.63	0.50	
		Right side	0.102	0.441	0.543	0.072	0.54	0.65	0.17	
		Top side		0.629	1.137	0.092	0.63	1.14	0.09	
		Bottom side	0.946				0.95	0.95	0.95	
	LTE Band 12	Front	0.344	0.384	0.322	0.059	0.73	0.67	0.40	
		Back	0.628	0.660	0.906	0.097	1.29	1.53	0.73	
		Left side	0.269	0.049	0.138	0.009	0.32	0.41	0.28	
		Right side	0.437	0.441	0.543	0.072	0.88	0.98	0.51	
		Top side		0.629	1.137	0.092	0.63	1.14	0.09	
		Bottom side	0.437				0.44	0.44	0.44	
	LTE Band 13	Front	0.363	0.384	0.322	0.059	0.75	0.69	0.42	
		Back	0.607	0.660	0.906	0.097	1.27	1.51	0.70	
		Left side	0.248	0.049	0.138	0.009	0.30	0.39	0.26	



		Right side	0.421	0.441	0.543	0.072	0.86	0.96	0.49	
		Top side		0.629	1.137	0.092	0.63	1.14	0.09	
		Bottom side	0.487				0.49	0.49	0.49	
	LTE Band 26	Front	0.626	0.384	0.322	0.059	1.01	0.95	0.69	
		Back	0.973	0.660	0.906	0.097	<b>1.63</b>	<b>1.88</b>	1.07	<b>15/16</b>
		Left side	0.345	0.049	0.138	0.009	0.39	0.48	0.35	
		Right side	0.499	0.441	0.543	0.072	0.94	1.04	0.57	
		Top side		0.629	1.137	0.092	0.63	1.14	0.09	
		Bottom side	0.653				0.65	0.65	0.65	
		Bottom side	0.653				0.65	0.65	0.65	
	LTE Band 66	Front	0.960	0.384	0.322	0.059	1.34	1.28	1.02	
		Back	1.404	0.660	0.906	0.097	<b>2.06</b>	<b>2.31</b>	1.50	<b>17/18</b>
		Left side	0.026	0.049	0.138	0.009	0.08	0.16	0.04	
		Right side	0.084	0.441	0.543	0.072	0.53	0.63	0.16	
		Top side		0.629	1.137	0.092	0.63	1.14	0.09	
		Bottom side	1.236				1.24	1.24	1.24	



16.3 Body-Worn Accessory Exposure Conditions

WWAN Band		Exposure Position	1	2	3	4	1+2	1+3	1+4	Case No
			WWAN 1g SAR (W/kg)	2.4GHz WLAN 1g SAR (W/kg)	5GHz WLAN 1g SAR (W/kg)	Bluetooth 1g SAR (W/kg)	Summed 1g SAR (W/kg)	Summed 1g SAR (W/kg)	Summed 1g SAR (W/kg)	
GSM	GSM850	Front	0.836	0.384	0.555	0.059	1.22	1.39	0.90	
		Back	1.095	0.660	1.156	0.109	1.76	2.25	1.20	1/2
	GSM1900	Front	0.584	0.384	0.555	0.059	0.97	1.14	0.64	
		Back	1.391	0.660	1.156	0.109	2.05	2.55	1.50	3/4
WCDMA	WCDMA II	Front	0.586	0.384	0.555	0.059	0.97	1.14	0.65	
		Back	1.325	0.660	1.156	0.109	1.99	2.48	1.43	5/6
	WCDMA IV	Front	0.790	0.384	0.555	0.059	1.17	1.35	0.85	
		Back	1.443	0.660	1.156	0.109	2.10	2.60	1.55	7/8
	WCDMA V	Front	0.859	0.384	0.555	0.059	1.24	1.41	0.92	
		Back	1.176	0.660	1.156	0.109	1.84	2.33	1.29	9/10
LTE Band	LTE Band 2	Front	0.539	0.384	0.555	0.059	0.92	1.09	0.60	
		Back	1.423	0.660	1.156	0.109	2.08	2.58	1.53	11/12
	LTE Band 7	Front	1.026	0.384	0.555	0.059	1.41	1.58	1.09	
		Back	1.396	0.660	1.156	0.109	2.06	2.55	1.51	13/14
	LTE Band 12	Front	0.344	0.384	0.555	0.059	0.73	0.90	0.40	
		Back	0.628	0.660	1.156	0.109	1.29	1.78	0.74	15
	LTE Band 13	Front	0.363	0.384	0.555	0.059	0.75	0.92	0.42	
		Back	0.607	0.660	1.156	0.109	1.27	1.76	0.72	16
	LTE Band 26	Front	0.626	0.384	0.555	0.059	1.01	1.18	0.69	
		Back	0.973	0.660	1.156	0.109	1.63	2.13	1.08	17/18
	LTE Band 66	Front	0.960	0.384	0.555	0.059	1.34	1.52	1.02	
		Back	1.404	0.660	1.156	0.109	2.06	2.56	1.51	19/20

Sensor Off

WWAN Band		Exposure Position	1	2	3	4	1+2	1+3	1+4
			WWAN 1g SAR (W/kg)	2.4GHz WLAN 1g SAR (W/kg)	5GHz WLAN 1g SAR (W/kg)	Bluetooth 1g SAR (W/kg)	Summed 1g SAR (W/kg)	Summed 1g SAR (W/kg)	Summed 1g SAR (W/kg)
GSM	GSM1900	Front at 14mm	0.419	0.112	0.104	0.059	0.53	0.52	0.48
		Back at 19mm	0.382	0.131	0.151	0.109	0.51	0.53	0.49
WCDMA	WCDMA II	Front at 14mm	0.481	0.112	0.104	0.059	0.59	0.59	0.54
		Back at 19mm	0.821	0.131	0.151	0.109	0.95	0.97	0.93
	WCDMA IV	Front at 14mm	1.433	0.112	0.104	0.059	1.55	1.54	1.49
		Back at 19mm	1.284	0.131	0.151	0.109	1.42	1.44	1.39
LTE	LTE Band 2	Front at 14mm	0.459	0.112	0.104	0.059	0.57	0.56	0.52
		Back at 19mm	0.848	0.131	0.151	0.109	0.98	1.00	0.96
	LTE Band 7	Front at 14mm	0.823	0.112	0.104	0.059	0.94	0.93	0.88
		Back at 19mm	0.567	0.131	0.151	0.109	0.70	0.72	0.68
	LTE Band 66	Front at 14mm	1.407	0.112	0.104	0.059	1.52	1.51	1.47
		Back at 19mm	1.243	0.131	0.151	0.109	1.37	1.39	1.35

16.4 Product Specific 10g SAR Exposure Conditions

WWAN Band		Exposure Position	1	2	1+2
			WWAN	5GHz WLAN	Summed
			10g SAR (W/kg)	10g SAR (W/kg)	10g SAR (W/kg)
GSM	GSM1900	Front	1.063	0.573	1.64
		Back	1.645	0.621	2.27
		Left side		0.256	0.26
		Right side		1.130	1.13
		Top side		1.937	1.94
		Bottom side	2.933		2.93
WCDMA	WCDMA II	Front	1.357	0.573	1.93
		Back	2.540	0.621	3.16
		Left side		0.256	0.26
		Right side		1.130	1.13
		Top side		1.937	1.94
		Bottom side	3.347		3.35
	WCDMA IV	Front	2.382	0.573	2.96
		Back	2.523	0.621	3.14
		Left side		0.256	0.26
		Right side		1.130	1.13
		Top side		1.937	1.94
		Bottom side	3.561		3.56
LTE	LTE Band 2	Front	1.431	0.573	2.00
		Back	2.533	0.621	3.15
		Left side		0.256	0.26
		Right side		1.130	1.13
		Top side		1.937	1.94
		Bottom side	3.406		3.41
	LTE Band 7	Front	2.534	0.573	3.11
		Back	2.988	0.621	3.61
		Left side		0.256	0.26
		Right side		1.130	1.13
		Top side		1.937	1.94
		Bottom side	1.517		1.52
	LTE Band 66	Front	1.879	0.573	2.45
		Back	1.983	0.621	2.60
		Left side		0.256	0.26
		Right side		1.130	1.13
		Top side		1.937	1.94
		Bottom side	3.220		3.22

Remark:

1. For Bluetooth Product specific 10g stand-alone SAR is not required for a transmitter or antenna, due to 1g hotspot SAR is <1.2W/kg.



Sensor Off

WWAN Band		Exposure Position	1	2	1+2
			WWAN	5GHz WLAN	Summed
			10g SAR (W/kg)	10g SAR (W/kg)	10g SAR (W/kg)
GSM	GSM1900	Front at 9mm	0.459	0.573	1.03
		Back at 17mm	0.262	0.621	0.88
		Bottom side at 17mm	0.381		0.38
WCDMA	WCDMA II	Front at 9mm	0.961	0.573	1.53
		Back at 17mm	0.552	0.621	1.17
		Bottom side at 17mm	0.833		0.83
	WCDMA IV	Front at 9mm	1.958	0.573	2.53
		Back at 17mm	1.016	0.621	1.64
		Bottom side at 17mm	1.267		1.27
LTE	LTE Band 2	Front at 9mm	1.005	0.573	1.58
		Back at 17mm	0.601	0.621	1.22
		Bottom side at 17mm	0.819		0.82
	LTE Band 7	Front at 6mm	2.099	0.573	2.67
		Back at 9mm	1.391	0.621	2.01
		Left side at 1mm	1.996	0.256	2.25
		Bottom side at 9mm	1.080		1.08
	LTE Band 66	Front at 9mm	1.916	0.573	2.49
		Back at 17mm	1.007	0.621	1.63
		Bottom side at 17mm	1.224		1.22

**16.5 SPLSR Evaluation and Analysis**

**General Note:**

1. When standalone SAR is measured for both antennas in the pair, the peak location separation distance is computed by the square root of  $[(x1-x2)^2 + (y1-y2)^2 + (z1-z2)^2]$ , where (x1, y1, z1) and (x2, y2, z2) are the coordinates in the area scans or extrapolated peak SAR locations in the zoom scans, as appropriate.
2.  $SPLSR = (SAR1 + SAR2)1.5 / (\text{min. separation distance, mm})$ . If  $SPLSR \leq 0.04$  for 1g SAR, simultaneously transmission SAR measurement is not necessary.

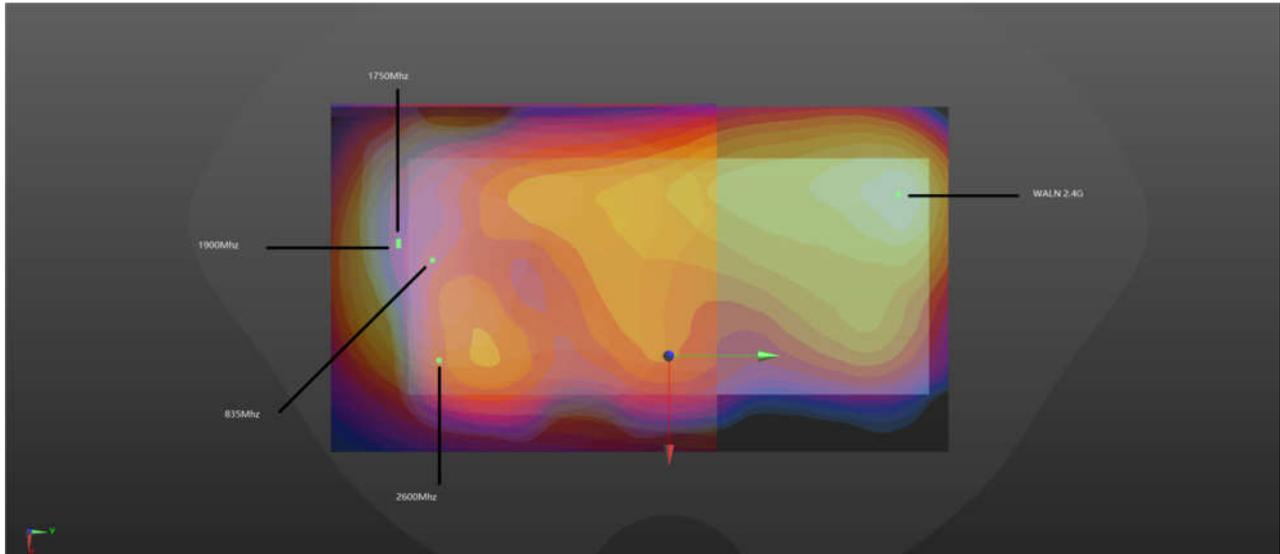

**WWAN+WLAN2.4GHz\_5mm**

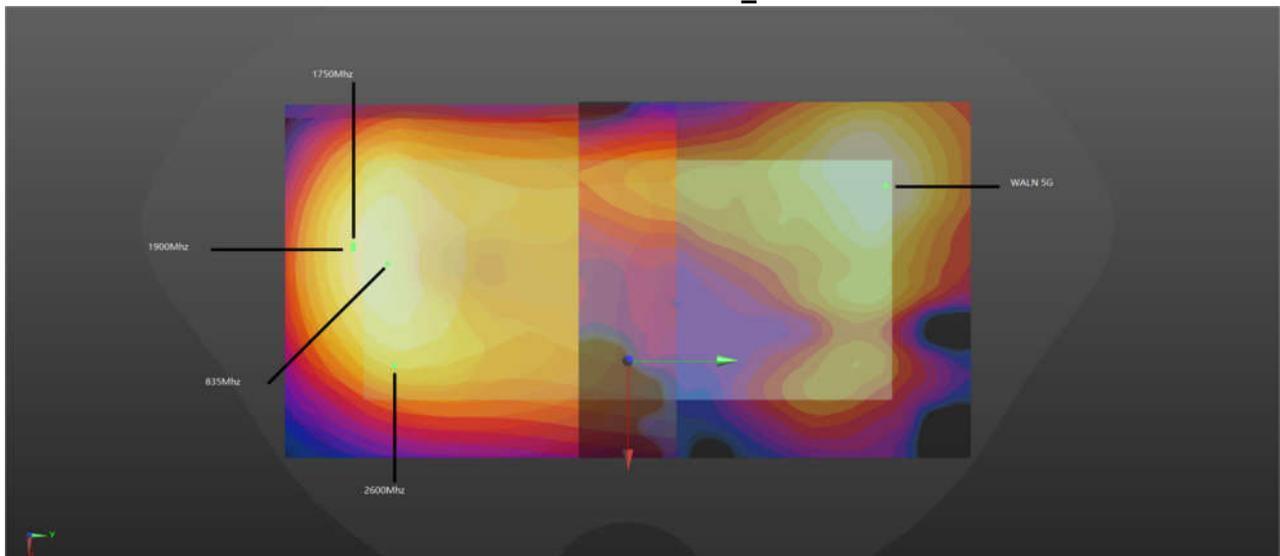

**WWAN+WLAN5GHz\_5mm**



For Hotspot											
Case	Band	Position	SAR (W/kg)	Gap (mm)	SAR peak location (mm)			3D distance (mm)	Summed SAR (W/kg)	SPLSR Results	Simultaneous SAR
					X	Y	Z				
Case 1	GSM850	Back	1.095	5	-6.6	-78.3	-1.22	152.7	1.76	0.02	Not required
	WLAN2.4GHz		0.66	5	-24.4	73.4	-1.53				
Case 2	GSM850	Back	1.095	5	-6.6	-78.3	-1.22	160.0	2.00	0.02	Not required
	WLAN5GHz		0.906	5	-23.6	80.8	-1.48				
Case 3	GSM1900	Back	1.391	5	-11.1	-82.4	-1.56	156.4	2.05	0.02	Not required
	WLAN2.4GHz		0.66	5	-24.4	73.4	-1.53				
Case 4	GSM1900	Back	1.391	5	-11.1	-82.4	-1.56	163.7	2.30	0.02	Not required
	WLAN5GHz		0.906	5	-23.6	80.8	-1.48				
Case 5	WCDMA II	Back	1.325	5	-12.7	-84	-1.57	157.8	1.99	0.02	Not required
	WLAN2.4GHz		0.66	5	-24.4	73.4	-1.53				
Case 6	WCDMA II	Back	1.325	5	-12.7	-84	-1.57	165.2	2.23	0.02	Not required
	WLAN5GHz		0.906	5	-23.6	80.8	-1.48				
Case 7	WCDMA IV	Back	1.443	5	-12.7	-84	-1.53	157.8	2.10	0.02	Not required
	WLAN2.4GHz		0.66	5	-24.4	73.4	-1.53				
Case 8	WCDMA IV	Back	1.443	5	-12.7	-84	-1.53	165.2	2.35	0.02	Not required
	WLAN5GHz		0.906	5	-23.6	80.8	-1.48				
Case 9	WCDMA V	Back	1.176	5	-11.4	-79.9	-1.27	153.9	1.84	0.02	Not required
	WLAN2.4GHz		0.66	5	-24.4	73.4	-1.53				
Case 10	WCDMA V	Back	1.176	5	-11.4	-79.9	-1.27	161.2	2.08	0.02	Not required
	WLAN5GHz		0.906	5	-23.6	80.8	-1.48				
Case 11	LTE Band 2	Back	1.423	5	-13.5	-81	-1.53	154.8	2.08	0.02	Not required
	WLAN2.4GHz		0.66	5	-24.4	73.4	-1.53				
Case 12	LTE Band 2	Back	1.423	5	-13.5	-81	-1.53	162.1	2.33	0.02	Not required
	WLAN5GHz		0.906	5	-23.6	80.8	-1.48				
Case 13	LTE Band 7	Back	1.396	5	26.4	-73	-1.4	155.0	2.06	0.02	Not required
	WLAN2.4GHz		0.66	5	-24.4	73.4	-1.53				
Case 14	Band	Position	SAR (W/kg)	Gap (mm)	SAR peak location (mm)			3D distance (mm)	Summed SAR (W/kg)	SPLSR Results	Simultaneous SAR



Case	Band	Position	SAR (W/kg)	Gap (mm)	SAR peak location (mm)			3D distance (mm)	Summed SAR (W/kg)	SPLSR Results	Simultaneous SAR
			X	Y	Z						
	LTE Band 7	Back	1.396	5	26.4	-73	-1.4	161.7	2.30	0.02	Not required
	WLAN5GHz		0.906	5	-23.6	80.8	-1.48				
Case 15	Band	Back	SAR (W/kg)	Gap (mm)	SAR peak location (mm)			3D distance (mm)	Summed SAR (W/kg)	SPLSR Results	Simultaneous SAR
			X	Y	Z						
	LTE Band 26	Back	0.973	5	-9.5	-79.9	-1.23	154.0	1.63	0.01	Not required
	WLAN2.4GHz		0.66	5	-24.4	73.4	-1.53				
Case 16	Band	Back	SAR (W/kg)	Gap (mm)	SAR peak location (mm)			3D distance (mm)	Summed SAR (W/kg)	SPLSR Results	Simultaneous SAR
			X	Y	Z						
	LTE Band 26	Back	0.973	5	-9.5	-79.9	-1.23	161.3	1.88	0.02	Not required
	WLAN5GHz		0.906	5	-23.6	80.8	-1.48				
Case 17	Band	Back	SAR (W/kg)	Gap (mm)	SAR peak location (mm)			3D distance (mm)	Summed SAR (W/kg)	SPLSR Results	Simultaneous SAR
			X	Y	Z						
	LTE Band 66	Back	1.404	5	-9	-82.4	-1.55	156.6	2.06	0.02	Not required
	WLAN2.4GHz		0.66	5	-24.4	73.4	-1.53				
Case 18	Band	Back	SAR (W/kg)	Gap (mm)	SAR peak location (mm)			3D distance (mm)	Summed SAR (W/kg)	SPLSR Results	Simultaneous SAR
			X	Y	Z						
	LTE Band 66	Back	1.404	5	-9	-82.4	-1.55	163.9	2.31	0.02	Not required
	WLAN5GHz		0.906	5	-23.6	80.8	-1.48				

**For Body-Worn**

Case	Band	Position	SAR (W/kg)	Gap (mm)	SAR peak location (mm)			3D distance (mm)	Summed SAR (W/kg)	SPLSR Results	Simultaneous SAR
			X	Y	Z						
Case 1	GSM850	Back	1.095	5	-6.6	-78.3	-1.22	152.7	1.76	0.02	Not required
	WLAN2.4GHz		0.66	5	-24.4	73.4	-1.53				
Case 2	Band	Back	SAR (W/kg)	Gap (mm)	SAR peak location (mm)			3D distance (mm)	Summed SAR (W/kg)	SPLSR Results	Simultaneous SAR
			X	Y	Z						
	GSM850	Back	1.095	5	-6.6	-78.3	-1.22	160.0	2.25	0.02	Not required
	WLAN5GHz		1.156	5	-23.6	80.8	-1.48				
Case 3	Band	Back	SAR (W/kg)	Gap (mm)	SAR peak location (mm)			3D distance (mm)	Summed SAR (W/kg)	SPLSR Results	Simultaneous SAR
			X	Y	Z						
	GSM1900	Back	1.391	5	-11.1	-82.4	-1.56	156.4	2.05	0.02	Not required
	WLAN2.4GHz		0.66	5	-24.4	73.4	-1.53				
Case 4	Band	Back	SAR (W/kg)	Gap (mm)	SAR peak location (mm)			3D distance (mm)	Summed SAR (W/kg)	SPLSR Results	Simultaneous SAR
			X	Y	Z						
	GSM1900	Back	1.391	5	-11.1	-82.4	-1.56	163.7	2.55	0.02	Not required
	WLAN5GHz		1.156	5	-23.6	80.8	-1.48				
Case 5	Band	Back	SAR (W/kg)	Gap (mm)	SAR peak location (mm)			3D distance (mm)	Summed SAR (W/kg)	SPLSR Results	Simultaneous SAR
			X	Y	Z						
	WCDMA II	Back	1.325	5	-12.7	-84	-1.57	157.8	1.99	0.02	Not required
	WLAN2.4GHz		0.66	5	-24.4	73.4	-1.53				
Case 6	Band	Back	SAR (W/kg)	Gap (mm)	SAR peak location (mm)			3D distance (mm)	Summed SAR (W/kg)	SPLSR Results	Simultaneous SAR
			X	Y	Z						
	WCDMA II	Back	1.325	5	-12.7	-84	-1.57	165.2	2.48	0.02	Not required
	WLAN5GHz		1.156	5	-23.6	80.8	-1.48				
Case 7	Band	Back	SAR (W/kg)	Gap (mm)	SAR peak location (mm)			3D distance (mm)	Summed SAR (W/kg)	SPLSR Results	Simultaneous SAR
			X	Y	Z						
	WCDMA IV	Back	1.443	5	-12.7	-84	-1.53	157.8	2.10	0.02	Not required
	WLAN2.4GHz		0.66	5	-24.4	73.4	-1.53				
Case 8	Band	Back	SAR (W/kg)	Gap (mm)	SAR peak location (mm)			3D distance (mm)	Summed SAR (W/kg)	SPLSR Results	Simultaneous SAR
			X	Y	Z						
	WCDMA IV	Back	1.443	5	-12.7	-84	-1.53	165.2	2.60	0.03	Not required
	WLAN5GHz		1.156	5	-23.6	80.8	-1.48				
Case 9	Band	Back	SAR (W/kg)	Gap (mm)	SAR peak location (mm)			3D distance (mm)	Summed SAR (W/kg)	SPLSR Results	Simultaneous SAR
			X	Y	Z						
	WCDMA V	Back	1.176	5	-11.4	-79.9	-1.27	153.9	1.84	0.02	Not required
	WLAN2.4GHz		0.66	5	-24.4	73.4	-1.53				



Case	Band	Position	SAR (W/kg)	Gap (mm)	SAR peak location (mm)			3D distance (mm)	Summed SAR (W/kg)	SPLSR Results	Simultaneous SAR
					X	Y	Z				
Case 10	WCDMA V	Back	1.176	5	-11.4	-79.9	-1.27	161.2	2.33	0.02	Not required
	WLAN5GHz		1.156	5	-23.6	80.8	-1.48				
Case 11	LTE Band 2	Back	1.423	5	-13.5	-81	-1.53	154.8	2.08	0.02	Not required
	WLAN2.4GHz		0.66	5	-24.4	73.4	-1.53				
Case 12	LTE Band 2	Back	1.423	5	-13.5	-81	-1.53	162.1	2.58	0.03	Not required
	WLAN5GHz		1.156	5	-23.6	80.8	-1.48				
Case 13	LTE Band 7	Back	1.396	5	26.4	-73	-1.4	155.0	2.06	0.02	Not required
	WLAN2.4GHz		0.66	5	-24.4	73.4	-1.53				
Case 14	LTE Band 7	Back	1.396	5	26.4	-73	-1.4	161.7	2.55	0.03	Not required
	WLAN5GHz		1.156	5	-23.6	80.8	-1.48				
Case 15	LTE Band 12	Back	0.628	5	-11	-79.9	-1.25	161.2	1.78	0.01	Not required
	WLAN5GHz		1.156	5	-23.6	80.8	-1.48				
Case 16	LTE Band 13	Back	0.607	5	-9.5	-81.4	-1.22	162.8	1.76	0.01	Not required
	WLAN5GHz		1.156	5	-23.6	80.8	-1.48				
Case 17	LTE Band 26	Back	0.973	5	-9.5	-79.9	-1.23	154.0	1.63	0.01	Not required
	WLAN2.4GHz		0.66	5	-24.4	73.4	-1.53				
Case 18	LTE Band 26	Back	0.973	5	-9.5	-79.9	-1.23	161.3	2.13	0.02	Not required
	WLAN5GHz		1.156	5	-23.6	80.8	-1.48				
Case 19	LTE Band 66	Back	1.404	5	-9	-82.4	-1.55	156.6	2.06	0.02	Not required
	WLAN2.4GHz		0.66	5	-24.4	73.4	-1.53				
Case 20	LTE Band 66	Back	1.404	5	-9	-82.4	-1.55	163.9	2.56	0.02	Not required
	WLAN5GHz		1.156	5	-23.6	80.8	-1.48				

Test Engineer : Nick Hu, Seven Xu, Bruce Li



## **17. Uncertainty Assessment**

Per KDB 865664 D01 SAR measurement 100MHz to 6GHz, when the highest measured 1-g SAR within a frequency band is < 1.5 W/kg and the measured 10-g SAR within a frequency band is < 3.75 W/kg. The expanded SAR measurement uncertainty must be  $\leq 30\%$ , for a confidence interval of  $k = 2$ . If these conditions are met, extensive SAR measurement uncertainty analysis described in IEEE Std 1528-2013 is not required in SAR reports submitted for equipment approval. For this device, the highest measured 1-g SAR is less 1.5W/kg and highest measured 10-g SAR is less 3.75W/kg. Therefore, the measurement uncertainty table is not required in this report.

## **18. References**

- [1] FCC 47 CFR Part 2 “Frequency Allocations and Radio Treaty Matters; General Rules and Regulations”
- [2] ANSI/IEEE Std. C95.1-1992, “IEEE Standard for Safety Levels with Respect to Human Exposure to Radio Frequency Electromagnetic Fields, 3 kHz to 300 GHz”, September 1992
- [3] IEEE Std. 1528-2013, “IEEE Recommended Practice for Determining the Peak Spatial-Average Specific Absorption Rate (SAR) in the Human Head from Wireless Communications Devices: Measurement Techniques”, Sep 2013
- [4] SPEAG DASY System Handbook
- [5] FCC KDB 865664 D01 v01r04, "SAR Measurement Requirements for 100 MHz to 6 GHz", Aug 2015.
- [6] FCC KDB 865664 D02 v01r02, “RF Exposure Compliance Reporting and Documentation Considerations” Oct 2015.
- [7] FCC KDB 447498 D01 v06, “Mobile and Portable Device RF Exposure Procedures and Equipment Authorization Policies”, Oct 2015
- [8] FCC KDB 648474 D04 v01r03, “SAR Evaluation Considerations for Wireless Handsets”, Oct 2015.
- [9] FCC KDB 248227 D01 v02r02, “SAR Guidance for IEEE 802.11 (WiFi) Transmitters”, Oct 2015.
- [10] FCC KDB 616217 D04 v01r02, “SAR Evaluation Considerations for Laptop, Notebook, Netbook and Tablet Computers”, Oct 2015
- [11] FCC KDB 941225 D01 v03r01, “3G SAR MEAUREMENT PROCEDURES”, Oct 2015
- [12] FCC KDB 941225 D05 v02r05, “SAR Evaluation Considerations for LTE Devices”, Dec 2015
- [13] FCC KDB 941225 D05A v01r02, “Rel. 10 LTE SAR Test Guidance and KDB Inquiries”, Oct 2015
- [14] FCC KDB 941225 D06 v02r01, "SAR Evaluation Procedures for Portable Devices with Wireless Router Capabilities", Oct 2015.

-----THE END-----



## **Appendix A. Plots of System Performance Check**

The plots are shown as follows.

### System Check\_Head\_750MHz

**DUT: D750V3 - SN:1087**

Communication System: UID 0, CW (0); Frequency: 750 MHz; Duty Cycle: 1:1  
Medium: HSL\_750 Medium parameters used:  $f = 750$  MHz;  $\sigma = 0.91$  S/m;  $\epsilon_r = 43.704$ ;  $\rho = 1000$  kg/m<sup>3</sup>

Ambient Temperature : 23.2 °C; Liquid Temperature : 22.6 °C

#### DASY5 Configuration:

- Probe: EX3DV4 - SN7627; ConvF(10.47, 10.47, 10.47) @ 750 MHz; Calibrated: 2021.2.10
- Sensor-Surface: 1.4mm (Mechanical Surface Detection)
- Electronics: DAE4 Sn1649; Calibrated: 2021.2.3
- Phantom: SAM Twin Phantom; Type: SAM Twin; Serial: TP-2024
- Measurement SW: DASY52, Version 52.10 (4); SEMCAD X Version 14.6.14 (7483)

**Pin=50mW/Area Scan (61x61x1):** Interpolated grid: dx=1.500 mm, dy=1.500 mm  
Maximum value of SAR (interpolated) = 0.563 W/kg

**Pin=50mW/Zoom Scan (5x5x7)/Cube 0:** Measurement grid: dx=8mm, dy=8mm, dz=5mm  
Reference Value = 25.89 V/m; Power Drift = -0.01 dB  
Peak SAR (extrapolated) = 0.649 W/kg  
**SAR(1 g) = 0.417 W/kg; SAR(10 g) = 0.273 W/kg**  
Maximum value of SAR (measured) = 0.568 W/kg

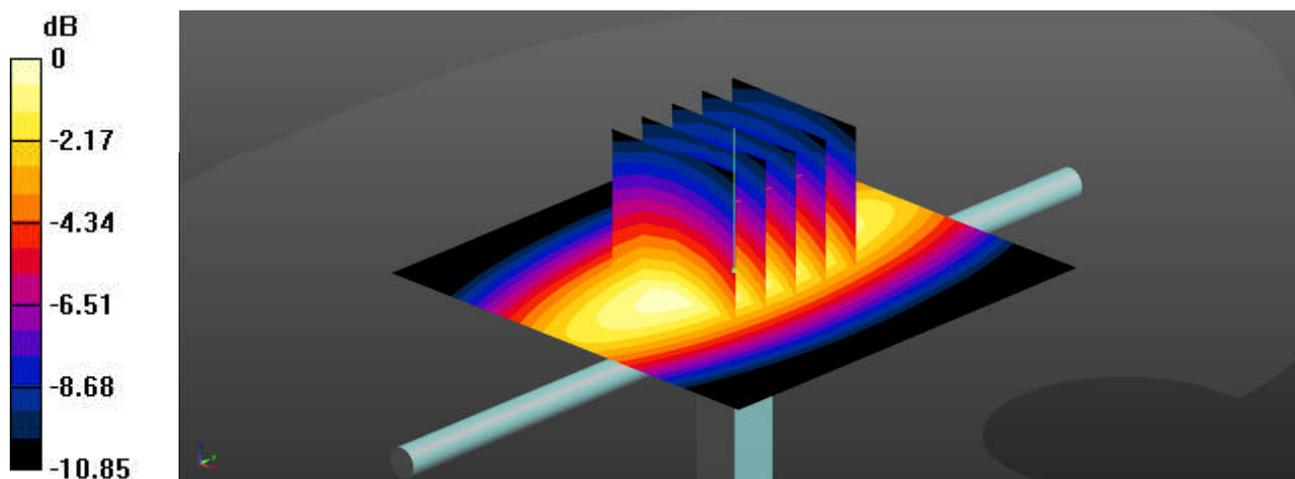

0 dB = 0.568 W/kg = -2.46 dBW/kg

### System Check\_Head\_835MHz

**DUT: D835V2 - SN:4d258**

Communication System: UID 0, CW (0); Frequency: 835 MHz; Duty Cycle: 1:1  
Medium: HSL\_835 Medium parameters used:  $f = 835 \text{ MHz}$ ;  $\sigma = 0.934 \text{ S/m}$ ;  $\epsilon_r = 41.804$ ;  $\rho = 1000 \text{ kg/m}^3$   
Ambient Temperature : 23.3 °C; Liquid Temperature : 22.8 °C

#### DASY5 Configuration:

- Probe: EX3DV4 - SN7627; ConvF(10.21, 10.21, 10.21) @ 835 MHz; Calibrated: 2021.2.10
- Sensor-Surface: 1.4mm (Mechanical Surface Detection)
- Electronics: DAE4 Sn1649; Calibrated: 2021.2.3
- Phantom: SAM Twin Phantom; Type: SAM Twin; Serial: TP-2024
- Measurement SW: DASY52, Version 52.10 (4); SEMCAD X Version 14.6.14 (7483)

**Pin=50mW/Area Scan (61x61x1):** Interpolated grid:  $dx=1.500 \text{ mm}$ ,  $dy=1.500 \text{ mm}$   
Maximum value of SAR (interpolated) = 0.705 W/kg

**Pin=50mW/Zoom Scan (5x5x7)/Cube 0:** Measurement grid:  $dx=8\text{mm}$ ,  $dy=8\text{mm}$ ,  $dz=5\text{mm}$   
Reference Value = 28.10 V/m; Power Drift = 0.05 dB  
Peak SAR (extrapolated) = 0.812 W/kg  
**SAR(1 g) = 0.501 W/kg; SAR(10 g) = 0.326 W/kg**  
Maximum value of SAR (measured) = 0.712 W/kg

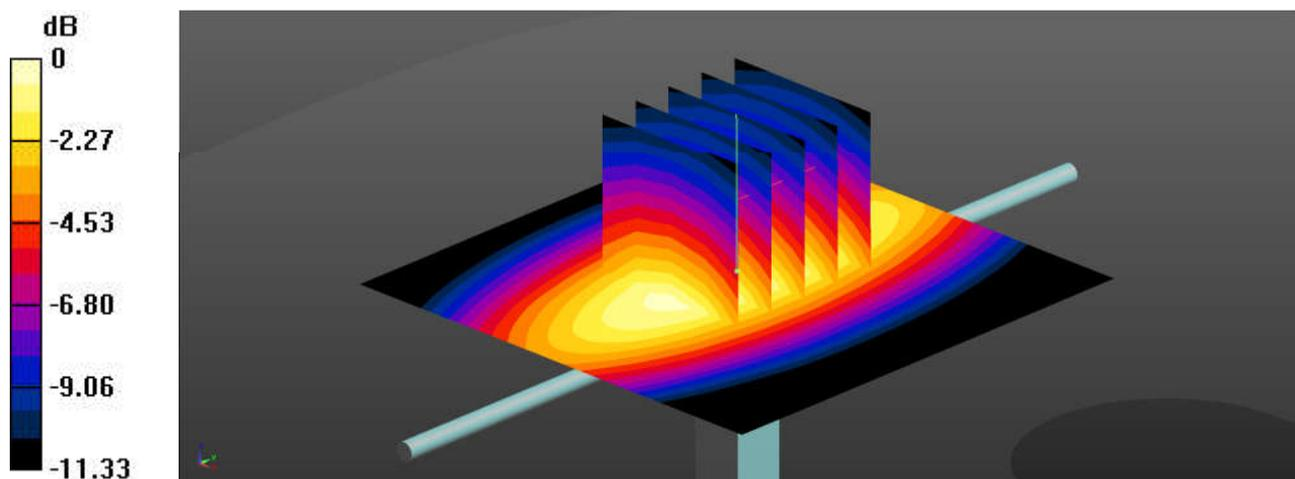

0 dB = 0.712 W/kg = -1.48 dBW/kg

### System Check\_Head\_1750MHz

**DUT: D1750V2 - SN:1090**

Communication System: UID 0, CW (0); Frequency: 1750 MHz; Duty Cycle: 1:1  
Medium: HSL\_1750 Medium parameters used:  $f = 1750$  MHz;  $\sigma = 1.342$  S/m;  $\epsilon_r = 40.449$ ;  $\rho = 1000$  kg/m<sup>3</sup>

Ambient Temperature : 23.3 °C; Liquid Temperature : 22.7 °C

#### DASY5 Configuration:

- Probe: EX3DV4 - SN7627; ConvF(8.73, 8.73, 8.73) @ 1750 MHz; Calibrated: 2021.2.10
- Sensor-Surface: 1.4mm (Mechanical Surface Detection)
- Electronics: DAE4 Sn1649; Calibrated: 2021.2.3
- Phantom: SAM Twin Phantom; Type: SAM Twin; Serial: TP-2024
- Measurement SW: DASY52, Version 52.10 (4); SEMCAD X Version 14.6.14 (7483)

**Pin=50mW/Area Scan (61x61x1):** Interpolated grid: dx=1.500 mm, dy=1.500 mm  
Maximum value of SAR (interpolated) = 2.85 W/kg

**Pin=50mW/Zoom Scan (5x5x7)/Cube 0:** Measurement grid: dx=8mm, dy=8mm, dz=5mm  
Reference Value = 47.53 V/m; Power Drift = 0.02 dB  
Peak SAR (extrapolated) = 3.42 W/kg  
**SAR(1 g) = 1.85 W/kg; SAR(10 g) = 0.982 W/kg**  
Maximum value of SAR (measured) = 2.87 W/kg

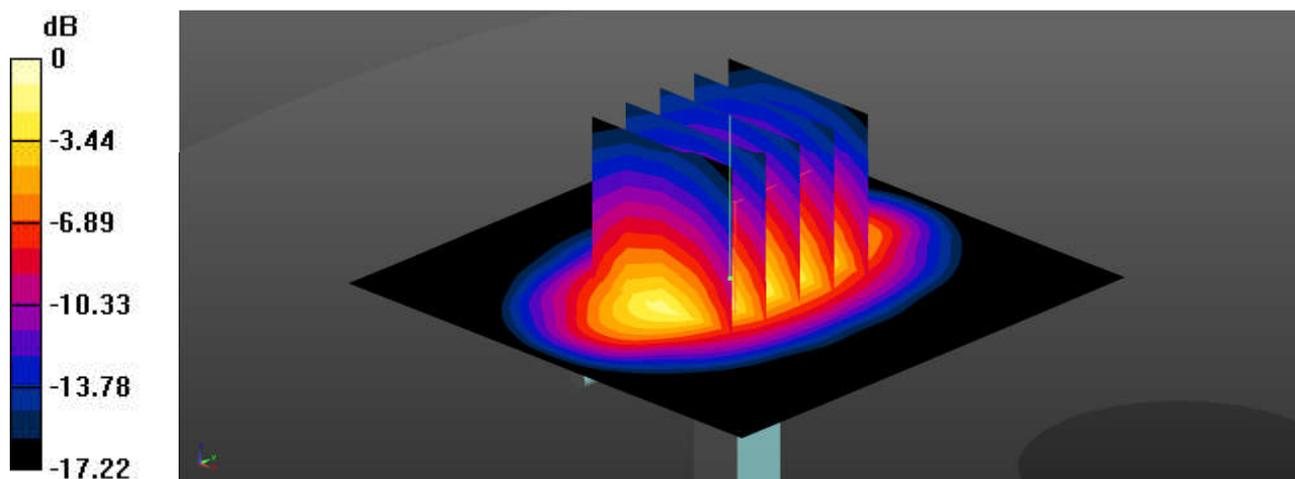

0 dB = 2.87 W/kg = 4.58 dBW/kg

### System Check\_Head\_1900MHz

**DUT: D1900V2 - SN:5d170**

Communication System: UID 0, CW (0); Frequency: 1900 MHz; Duty Cycle: 1:1

Medium: HSL\_1900 Medium parameters used:  $f = 1900$  MHz;  $\sigma = 1.439$  S/m;  $\epsilon_r = 40.202$ ;  $\rho = 1000$  kg/m<sup>3</sup>

Ambient Temperature : 23.3 °C; Liquid Temperature : 22.9 °C

DASY5 Configuration:

- Probe: EX3DV4 - SN7627; ConvF(8.46, 8.46, 8.46) @ 1900 MHz; Calibrated: 2021.2.10
- Sensor-Surface: 1.4mm (Mechanical Surface Detection)
- Electronics: DAE4 Sn1649; Calibrated: 2021.2.3
- Phantom: SAM Twin Phantom; Type: SAM Twin; Serial: TP-2024
- Measurement SW: DASY52, Version 52.10 (4); SEMCAD X Version 14.6.14 (7483)

**Pin=50mW/Area Scan (61x61x1):** Interpolated grid: dx=1.500 mm, dy=1.500 mm  
Maximum value of SAR (interpolated) = 3.25 W/kg

**Pin=50mW/Zoom Scan (5x5x7)/Cube 0:** Measurement grid: dx=8mm, dy=8mm, dz=5mm  
Reference Value = 48.78 V/m; Power Drift = 0.01 dB  
Peak SAR (extrapolated) = 3.97 W/kg  
**SAR(1 g) = 2.05 W/kg; SAR(10 g) = 1.06 W/kg**  
Maximum value of SAR (measured) = 3.27 W/kg

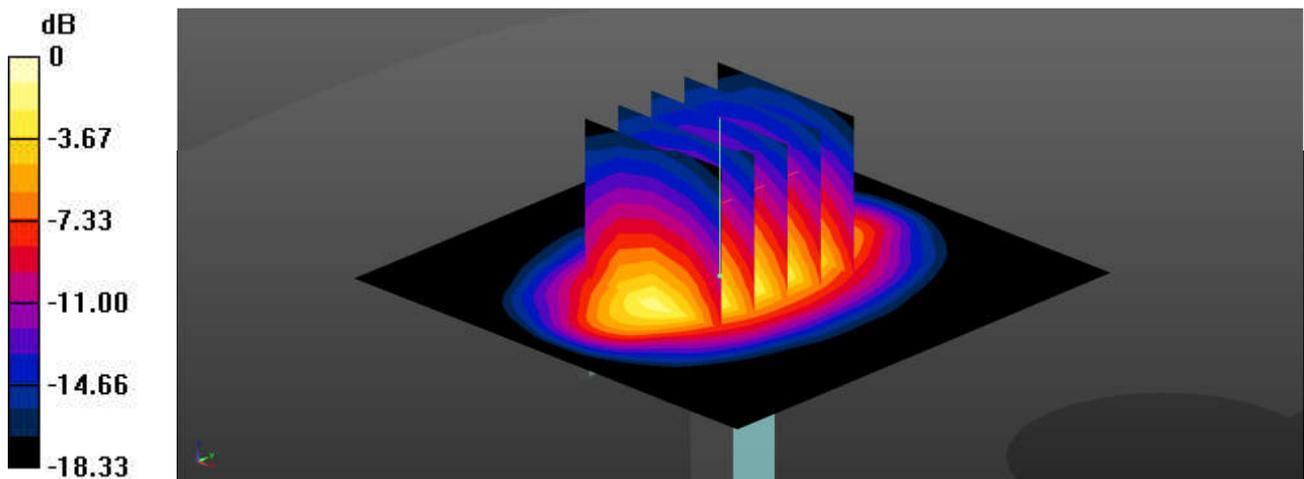

0 dB = 3.27 W/kg = 5.15 dBW/kg

### System Check\_Head\_2450MHz

**DUT: D2450V2 - SN:908**

Communication System: UID 0, CW (0); Frequency: 2450 MHz; Duty Cycle: 1:1  
Medium: HSL\_2450 Medium parameters used:  $f = 2450$  MHz;  $\sigma = 1.824$  S/m;  $\epsilon_r = 39.246$ ;  $\rho = 1000$  kg/m<sup>3</sup>

Ambient Temperature : 23.2 °C; Liquid Temperature : 22.6 °C

#### DASY5 Configuration:

- Probe: EX3DV4 - SN7627; ConvF(8, 8, 8) @ 2450 MHz; Calibrated: 2021.2.10
- Sensor-Surface: 1.4mm (Mechanical Surface Detection)
- Electronics: DAE4 Sn1649; Calibrated: 2021.2.3
- Phantom: SAM Twin Phantom; Type: SAM Twin; Serial: TP-2024
- Measurement SW: DASY52, Version 52.10 (4); SEMCAD X Version 14.6.14 (7483)

**Pin=50mW/Area Scan (71x71x1):** Interpolated grid: dx=1.200 mm, dy=1.200 mm  
Maximum value of SAR (interpolated) = 3.91 W/kg

**Pin=50mW/Zoom Scan (7x7x7)/Cube 0:** Measurement grid: dx=5mm, dy=5mm, dz=5mm  
Reference Value = 48.35 V/m; Power Drift = 0.07 dB  
Peak SAR (extrapolated) = 4.86 W/kg  
**SAR(1 g) = 2.43 W/kg; SAR(10 g) = 1.13 W/kg**  
Maximum value of SAR (measured) = 3.98 W/kg

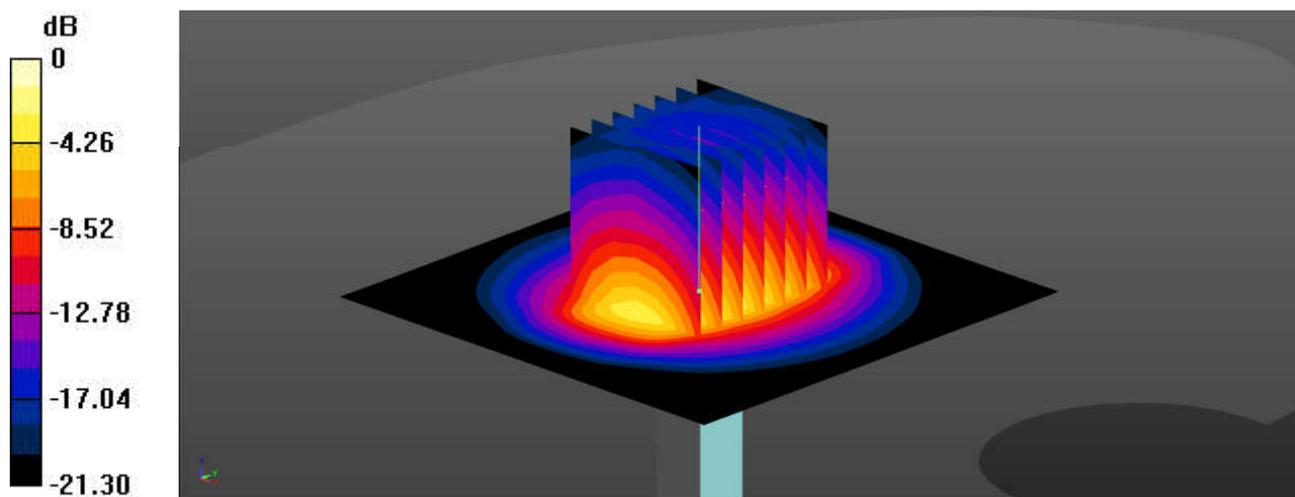

0 dB = 3.98 W/kg = 6.00 dBW/kg

### System Check\_Head\_2600MHz

**DUT: D2600V2 - SN:1061**

Communication System: UID 0, CW (0); Frequency: 2600 MHz; Duty Cycle: 1:1  
Medium: HSL\_2600 Medium parameters used:  $f = 2600$  MHz;  $\sigma = 1.931$  S/m;  $\epsilon_r = 39.054$ ;  $\rho = 1000$  kg/m<sup>3</sup>

Ambient Temperature : 23.1 °C; Liquid Temperature : 22.8 °C

DASY5 Configuration:

- Probe: EX3DV4 - SN7627; ConvF(7.71, 7.71, 7.71) @ 2600 MHz; Calibrated: 2021.2.10
- Sensor-Surface: 1.4mm (Mechanical Surface Detection)
- Electronics: DAE4 Sn1649; Calibrated: 2021.2.3
- Phantom: SAM Twin Phantom; Type: SAM Twin; Serial: TP-2024
- Measurement SW: DASY52, Version 52.10 (4); SEMCAD X Version 14.6.14 (7483)

**Pin=50mW/Area Scan (71x71x1):** Interpolated grid: dx=1.200 mm, dy=1.200 mm  
Maximum value of SAR (interpolated) = 4.30 W/kg

**Pin=50mW/Zoom Scan (7x7x7)/Cube 0:** Measurement grid: dx=5mm, dy=5mm, dz=5mm  
Reference Value = 48.88 V/m; Power Drift = 0.02 dB  
Peak SAR (extrapolated) = 5.33 W/kg  
**SAR(1 g) = 2.7 W/kg; SAR(10 g) = 1.23 W/kg**  
Maximum value of SAR (measured) = 4.28 W/kg

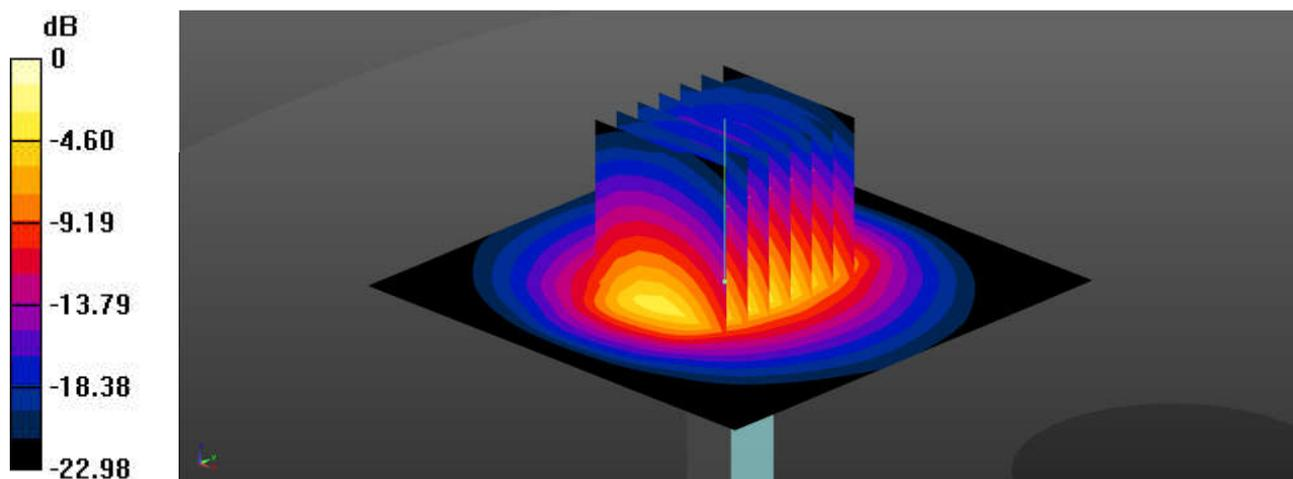

0 dB = 4.28 W/kg = 6.31 dBW/kg

### System Check\_Head\_5250MHz

**DUT: D5GHzV2 - SN:1113**

Communication System: UID 0, CW (0); Frequency: 5250 MHz; Duty Cycle: 1:1  
Medium: HSL\_5000 Medium parameters used:  $f = 5250$  MHz;  $\sigma = 4.587$  S/m;  $\epsilon_r = 36.312$ ;  $\rho = 1000$  kg/m<sup>3</sup>

Ambient Temperature : 23.1 °C; Liquid Temperature : 22.7 °C

DASY5 Configuration:

- Probe: EX3DV4 - SN7627; ConvF(5.69, 5.69, 5.69) @ 5250 MHz; Calibrated: 2021.2.10
- Sensor-Surface: 1.4mm (Mechanical Surface Detection)
- Electronics: DAE4 Sn1649; Calibrated: 2021.2.3
- Phantom: SAM Twin Phantom; Type: SAM Twin; Serial: TP-2024
- Measurement SW: DASY52, Version 52.10 (4); SEMCAD X Version 14.6.14 (7483)

**Pin=50mW/Area Scan (91x91x1):** Interpolated grid: dx=1.000 mm, dy=1.000 mm  
Maximum value of SAR (interpolated) = 7.47 W/kg

**Pin=50mW/Zoom Scan (7x7x7)/Cube 0:** Measurement grid: dx=4mm, dy=4mm, dz=1.4mm  
Reference Value = 45.76 V/m; Power Drift = 0.06 dB  
Peak SAR (extrapolated) = 13.2 W/kg  
**SAR(1 g) = 3.74 W/kg; SAR(10 g) = 1.13 W/kg**  
Maximum value of SAR (measured) = 8.19 W/kg

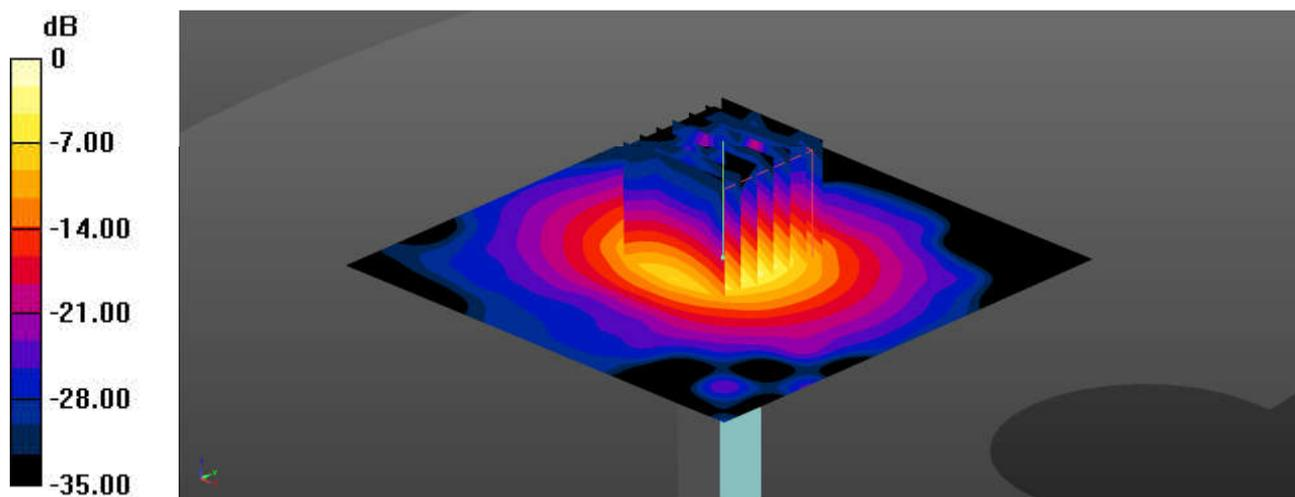

0 dB = 8.19 W/kg = 9.13 dBW/kg

### System Check\_Head\_5600MHz

#### DUT: D5GHzV2 - SN:1113

Communication System: UID 0, CW (0); Frequency: 5600 MHz; Duty Cycle: 1:1  
Medium: HSL\_5000 Medium parameters used:  $f = 5600$  MHz;  $\sigma = 4.955$  S/m;  $\epsilon_r = 35.752$ ;  $\rho = 1000$  kg/m<sup>3</sup>

Ambient Temperature : 23.4 °C; Liquid Temperature : 22.8 °C

#### DASY5 Configuration:

- Probe: EX3DV4 - SN7627; ConvF(4.89, 4.89, 4.89) @ 5600 MHz; Calibrated: 2021.2.10
- Sensor-Surface: 1.4mm (Mechanical Surface Detection)
- Electronics: DAE4 Sn1649; Calibrated: 2021.2.3
- Phantom: SAM Twin Phantom; Type: SAM Twin; Serial: TP-2024
- Measurement SW: DASY52, Version 52.10 (4); SEMCAD X Version 14.6.14 (7483)

**Pin=50mW/Area Scan (91x91x1):** Interpolated grid: dx=1.000 mm, dy=1.000 mm  
Maximum value of SAR (interpolated) = 8.62 W/kg

**Pin=50mW/Zoom Scan (7x7x7)/Cube 0:** Measurement grid: dx=4mm, dy=4mm, dz=1.4mm  
Reference Value = 46.68 V/m; Power Drift = 0.06 dB  
Peak SAR (extrapolated) = 16.1 W/kg  
**SAR(1 g) = 3.89 W/kg; SAR(10 g) = 1.11 W/kg**  
Maximum value of SAR (measured) = 9.40 W/kg

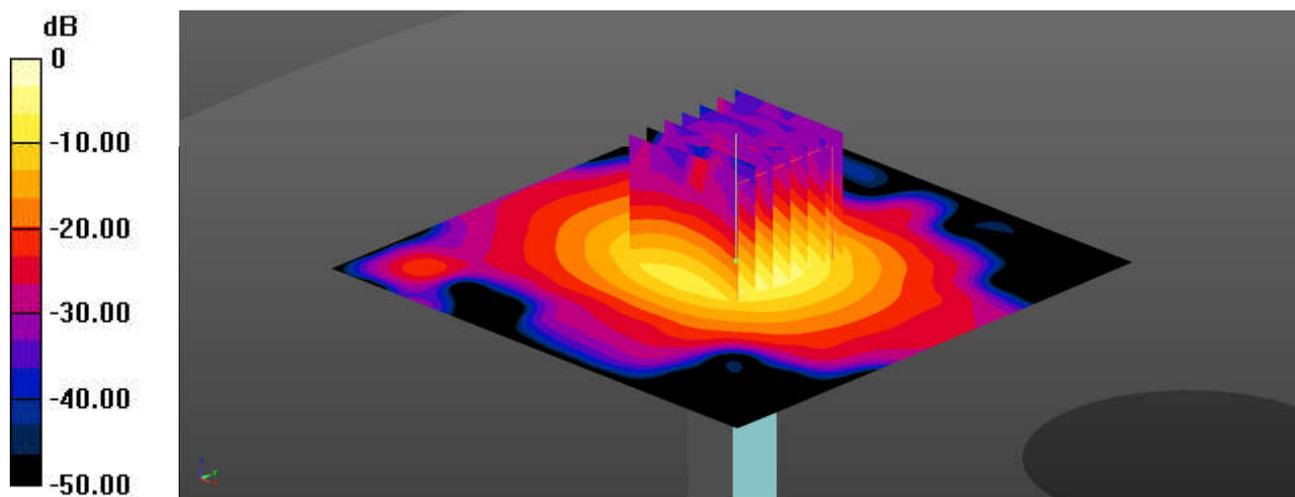

0 dB = 9.40 W/kg = 9.73 dBW/kg