



FCC RF Test Report

APPLICANT : Motorola Mobility LLC
EQUIPMENT : Mobile Cellular Phone
BRAND NAME : Motorola
MODEL NAME : XT2173-2
FCC ID : IHDT56ZV4
STANDARD : 47 CFR Part 2, 22(H), 24(E), 27(M)
CLASSIFICATION : PCS Licensed Transmitter Held to Ear (PCE)
TEST DATE(S) : Aug. 05, 2021 ~ Aug. 10, 2021

We, Sporton International (Shenzhen) Inc., would like to declare that the tested sample has been evaluated in accordance with the procedures given in ANSI C63.26-2015 and shown compliance with the applicable technical standards.

The test results in this report apply exclusively to the tested model / sample. Without written approval of Sporton International (Shenzhen) Inc., the test report shall not be reproduced except in full.

Reviewed by: Derreck Chen / Supervisor

Approved by: Eric Shih / Manager



Sporton International (ShenZhen) Inc.

1/F, 2/F, Bldg 5, Shiling Industrial Zone, Xinwei Village, Xili, Nanshan, Shenzhen, 518055

People's Republic of China



TABLE OF CONTENTS

REVISION HISTORY... 3
SUMMARY OF TEST RESULT ... 4
1 GENERAL DESCRIPTION ... 5
1.1 Applicant ... 5
1.2 Manufacturer ... 5
1.3 Product Feature of Equipment Under Test ... 5
1.4 Product Specification of Equipment Under Test ... 6
1.5 Modification of EUT ... 6
1.6 Specification of Accessory ... 7
1.7 Re-use of Measured Data ... 8
1.8 Maximum ERP/EIRP Power and Emission Designator ... 10
1.9 Testing Location ... 11
1.10 Test Software ... 11
1.11 Applicable Standards ... 11
2 TEST CONFIGURATION OF EQUIPMENT UNDER TEST ... 12
2.1 Test Mode ... 12
2.2 Connection Diagram of Test System ... 14
2.3 Support Unit used in test configuration and system ... 14
2.4 Measurement Results Explanation Example ... 14
2.5 Frequency List of Low/Middle/High Channels ... 15
3 CONDUCTED TEST ITEMS ... 18
3.1 Measuring Instruments ... 18
3.2 Test Setup ... 18
3.3 Test Result of Conducted Test ... 19
3.4 Conducted Output Power and ERP/EIRP ... 19
3.5 Peak-to-Average Ratio ... 20
3.6 Occupied Bandwidth ... 21
3.7 Conducted Band Edge ... 22
3.8 Conducted Spurious Emission ... 24
3.9 Frequency Stability ... 25
4 RADIATED TEST ITEMS ... 26
4.1 Measuring Instruments ... 26
4.2 Test Setup ... 26
4.3 Test Result of Radiated Test ... 27
4.4 Radiated Spurious Emission ... 28
5 LIST OF MEASURING EQUIPMENT ... 29
6 UNCERTAINTY OF EVALUATION ... 30
APPENDIX A. TEST RESULTS OF CONDUCTED TEST
APPENDIX B. TEST RESULTS OF RADIATED TEST
APPENDIX C. TEST SETUP PHOTOGRAPHS



SUMMARY OF TEST RESULT

Report Section	FCC Rule	Description	Limit	Result	Remark
3.4	§2.1046	Conducted Output Power	-	Report Only	-
	§22.913(a)(5)	Effective Radiated Power (Band 5) (Band 26)	ERP < 7 Watt	PASS	-
	§24.232(c) §27.50(h)(2)	Equivalent Isotropic Radiated Power (Band 2) (Band 7) (Band 38) (Band 41)	EIRP < 2Watt	PASS	-
3.5	N/A	Peak-to-Average Ratio	<13 dB	PASS	-
3.6	§2.1049	Occupied Bandwidth	-	Report Only	-
3.7	§2.1051 §22.917(a)	Conducted Band Edge Measurement (Band 5) (Band 26)	< 43+10log ₁₀ (P[Watts])	PASS	-
	§27.53(m)(4)	Conducted Band Edge Measurement (Band 38) (Band 41)	§27.53(m)(4)		
3.8	§2.1051 §22.917(a)	Conducted Spurious Emission (Band 5) (Band 26)	< 43+10log ₁₀ (P[Watts])	PASS	-
	§2.1051 §27.53(m)(4)	Conducted Spurious Emission (Band 38) (Band 41)	< 55+10log ₁₀ (P[Watts])		
3.9	§2.1055 §22.355	Frequency Stability Temperature & Voltage	< 2.5 ppm for Part 22	PASS	-
	§2.1055 §27.54		Within Authorized Band		
4.4	§2.1053 §22.917(a)	Radiated Spurious Emission (Band 5) (Band 26)	< 43+10log ₁₀ (P[Watts])	PASS	Under limit 9.30 dB at 7758.00 MHz
	§2.1053 §27.53(m)(4)	Radiated Spurious Emission (Band 38) (Band 41)	< 55+10log ₁₀ (P[Watts])		

Declaration of Conformity:

The test results with all measurement uncertainty excluded are presented in accordance with the regulation limits or requirements declared by manufacturers.

Comments and Explanations:

The declared of product specification for EUT presented in the report are provided by the manufacturer, and the manufacturer takes all the responsibilities for the accuracy of product specification.



1 General Description

1.1 Applicant

Motorola Mobility LLC
222 W, Merchandise Mart Plaza, Chicago, IL60654 USA

1.2 Manufacturer

Motorola Mobility LLC
222 W, Merchandise Mart Plaza, Chicago, IL60654 USA

1.3 Product Feature of Equipment Under Test

Product Feature	
Equipment	Mobile Cellular Phone
Brand Name	Motorola
Model Name	XT2173-2
FCC ID	IHDT56ZV4
IMEI Code	Conducted: 354943970039213/354943970039221 Radiation: 354943970023910/354943970023928
HW Version	DVT2
SW Version	RRWB31.Q3-25
EUT Stage	Identical Prototype



1.4 Product Specification of Equipment Under Test

Standards-related Product Specification	
Tx Frequency	LTE Band 2 : 1850 MHz ~ 1910 MHz LTE Band 5 : 824 MHz ~ 849 MHz LTE Band 7 : 2500 MHz ~ 2570 MHz LTE Band 26 : 824 MHz ~ 849 MHz LTE Band 38 : 2570 MHz ~ 2620 MHz LTE Band 41 : 2496 MHz ~ 2690 MHz
Rx Frequency	LTE Band 2 : 1930 MHz ~ 1990 MHz LTE Band 5 : 869 MHz ~ 894 MHz LTE Band 7 : 2620 MHz ~ 2690 MHz LTE Band 26 : 869 MHz ~ 894 MHz LTE Band 38 : 2570 MHz ~ 2620 MHz LTE Band 41 : 2496 MHz ~ 2690 MHz
Bandwidth	LTE Band 2 : 1.4MHz / 3MHz / 5MHz / 10MHz / 15MHz / 20MHz LTE Band 5 : 1.4MHz / 3MHz / 5MHz / 10MHz LTE Band 7 : 5MHz / 10MHz / 15MHz / 20MHz LTE Band 26 : 1.4MHz / 3MHz / 5MHz / 10MHz / 15MHz LTE Band 38 : 5MHz / 10MHz / 15MHz / 20MHz LTE Band 41 : 5MHz / 10MHz / 15MHz / 20MHz
Maximum Output Power to Antenna	LTE Band 2 : 22.89 dBm LTE Band 5 : 23.05 dBm LTE Band 7 : 22.31 dBm LTE Band 26 : 23.07 dBm LTE Band 38 : 22.17 dBm LTE Band 41 : 22.31 dBm
Antenna Gain	LTE Band 2 : -3.7 dBi LTE Band 5 : -4.2 dBi LTE Band 7 : -2.2 dBi LTE Band 26 : -4.2 dBi LTE Band 38 : -3.5 dBi LTE Band 41 : -2.2 dBi
Type of Modulation	QPSK / 16QAM / 64QAM

1.5 Modification of EUT

No modifications are made to the EUT during all test items.

1.6 Specification of Accessory

Specification of Accessory				
AC Adapter 1(US)	Brand Name	Motorola(Salcomp)	Model Name	MC-101
AC Adapter 1(EU)	Brand Name	Motorola(Salcomp)	Model Name	MC-102
AC Adapter 1(UK)	Brand Name	Motorola(Salcomp)	Model Name	MC-103
AC Adapter 1(AR)	Brand Name	Motorola(Salcomp)	Model Name	MC-106
AC Adapter 1(CHILE)	Brand Name	Motorola(Salcomp)	Model Name	MC-109
AC Adapter 2(BR)	Brand Name	Motorola(Chenyang)	Model Name	MC-107
AC Adapter 3(US)	Brand Name	Motorola(Aohai)	Model Name	MC-101
AC Adapter 3(EU)	Brand Name	Motorola(Aohai)	Model Name	MC-102
AC Adapter 3(UK)	Brand Name	Motorola(Aohai)	Model Name	MC-103
AC Adapter 3(AR)	Brand Name	Motorola(Aohai)	Model Name	MC-106
AC Adapter 4(BR)	Brand Name	Motorola(Flex)	Model Name	MC-107
AC Adapter 5(BR)	Brand Name	Motorola(Salcomp)	Model Name	MC-107
AC Adapter 6(IN)	Brand Name	Motorola(Aohai)	Model Name	MC-204
AC Adapter 7(IN)	Brand Name	Motorola(Chenyang)	Model Name	MC-204
Battery 1	Brand Name	Motorola(Sunwoda)	Model Name	JK50
Battery 2	Brand Name	Motorola (SCUD)	Model Name	JK50
Battery 3	Brand Name	Motorola(ATL)	Model Name	JK50
Earphone 1	Brand Name	Motorola(NEWLEADER)	Model Name	MH202(S928D09678)
Earphone 2	Brand Name	Motorola(Lyand)	Model Name	MH191(SH38C81577)
Earphone 3	Brand Name	Motorola(LCHSE)	Model Name	MH191(SH38C81576)
USB Cable 1	Brand Name	Motorola(Saibao)	Model Name	SLQ-A167A
USB Cable 2	Brand Name	Motorola (Jieye)	Model Name	JY-C03-272



1.7 Re-use of Measured Data

1.7.1 Introduction Section

This application re-uses data collected on a similar device. The subject device of this application (Model: XT2173-2, FCC ID: IHDT56ZV4) is electrically identical to the reference device (Model: XT2173-1, FCC ID: IHDT56ZV3) for the portions of the circuitry corresponding to the data being re-used. Based on their similarity, FCC Part 22, 24, 27, (equipment class: PCE) reuse the original model's result and do spot-check, following the FCC KDB 484596 D01 v01.

The applicant takes full responsibility that the test data as referenced in this report represent compliance for this FCC ID: IHDT56ZV4 .

1.7.2 Difference Section

The **main** difference between FCC ID: IHDT56ZV4 and FCC ID: IHDT56ZV3 is that the two models support different WCDMA and LTE bands for different markets, the BT/WLAN portion are the same. Other differences and all the details of similarity and difference can be found in the XT2173-2_Operational Description of Product Equality Declaration which is exhibited separately.

1.7.3 Reference detail Section:

Rule Part	Equipment Class	Frequency Band (MHz)	Reference FCC ID(Parent)	Type Grant/ Permissive Change	Reference Title	FCC ID Filling (Variant)	Report Title/Section
Part 24 Part 27	PCE (LTE)	Band 2 Band 7	IHDT56ZV3	Original Grant	FG162325B	IHDT56ZV4	All sections applicable for LTE Band 2/7 except Power and EIRP



1.7.4 Spot Check Verification Data Section

Radiated spurious emission test against the variant model based on the worst-case condition from the original model was performed in this filing to demonstrate the test data from original model remains representative for the variant model

Summary for RSE spot check for each rule entry and technology is listed as below:

Test Item	Mode	IHDT56ZV3 Worst Result	IHDT56ZV4 Worst Result	Difference (dB)
Radiated Spurious Emission (dBm)	LTE Band 2	-34.35	-32.30	2.05
	LTE Band 7	-27.88	-25.21	2.67



1.8 Maximum ERP/EIRP Power and Emission Designator

LTE Band 2		QPSK		16QAM/64QAM	
BW (MHz)	Frequency Range (MHz)	Maximum ERP(W)	Emission Designator (99%OBW)	Maximum ERP(W)	Emission Designator (99%OBW)
20	1860.0 ~ 1900.0	0.0830	Refer IHDT56ZV3	0.0811	Refer IHDT56ZV3
LTE Band 5		QPSK		16QAM/64QAM	
BW (MHz)	Frequency Range (MHz)	Maximum ERP(W)	Emission Designator (99%OBW)	Maximum ERP(W)	Emission Designator (99%OBW)
10	829.0 ~ 844.0	0.0468	9M07G7D	0.0467	9M05W7D
LTE Band 7		QPSK		16QAM/64QAM	
BW (MHz)	Frequency Range (MHz)	Maximum EIRP(W)	Emission Designator (99%OBW)	Maximum EIRP(W)	Emission Designator (99%OBW)
20	2510.0 ~ 2560.0	0.1026	Refer IHDT56ZV3	0.1021	Refer IHDT56ZV3
LTE Band 26		QPSK		16QAM/64QAM	
BW (MHz)	Frequency Range (MHz)	Maximum ERP(W)	Emission Designator (99%OBW)	Maximum ERP(W)	Emission Designator (99%OBW)
15	831.5 ~ 841.5	0.0470	13M4G7D	0.0468	13M5W7D
CH26765	821.5	0.0463	13M4G7D	0.0369	13M5W7D
LTE Band 38		QPSK		16QAM/64QAM	
BW (MHz)	Frequency Range (MHz)	Maximum EIRP(W)	Emission Designator (99%OBW)	Maximum EIRP(W)	Emission Designator (99%OBW)
20	2580.0 ~ 2610.0	0.0736	17M9G7D	0.0735	17M9W7D
LTE Band 41		QPSK		16QAM/64QAM	
BW (MHz)	Frequency Range (MHz)	Maximum EIRP(W)	Emission Designator (99%OBW)	Maximum EIRP(W)	Emission Designator (99%OBW)
20	2506.0 ~ 2680.0	0.1026	17M9G7D	0.1021	17M9W7D



1.9 Testing Location

Sporton International (Shenzhen) Inc. is accredited to ISO/IEC 17025:2017 by American Association for Laboratory Accreditation with Certificate Number 5145.01.

Test Firm	Sporton International (Shenzhen) Inc.		
Test Site Location	1/F, 2/F, Bldg 5, Shiling Industrial Zone, Xinwei Village, Xili, Nanshan, Shenzhen, 518055 People's Republic of China TEL: +86-755-86379589 FAX: +86-755-86379595		
Test Site No.	Sporton Site No.	FCC Designation No.	FCC Test Firm Registration No.
	TH01-SZ	CN1256	421272

Test Firm	Sporton International (Shenzhen) Inc.		
Test Site Location	101, 1st Floor, Block B, Building 1, No. 2, Tengfeng 4th Road, Fenghuang Community, Fuyong Street, Baoan District, Shenzhen City Guangdong Province China 518103 TEL: +86-755-33202398		
Test Site No.	Sporton Site No.	FCC Designation No.	FCC Test Firm Registration No.
	03CH02-SZ	CN1256	421272

1.10 Test Software

Item	Site	Manufacturer	Name	Version
1.	03CH02-SZ	AUDIX	E3	6.2009-8-24a

1.11 Applicable Standards

According to the specifications of the manufacturer, the EUT must comply with the requirements of the following standards:

- ♦ 47 CFR Part 2, 22(H), 24(E), 27(M),
- ♦ ANSI C63.26-2015
- ♦ FCC KDB 971168 D01 Power Meas License Digital Systems v03r01
- ♦ FCC KDB 412172 D01 Determining ERP and EIRP v01r01

Remark:

1. All test items were verified and recorded according to the standards and without any deviation during the test.
2. This EUT has also been tested and complied with the requirements of FCC Part 15, Subpart B, recorded in a separate test report.



2 Test Configuration of Equipment Under Test

2.1 Test Mode

Antenna port conducted and radiated test items listed below are performed according to KDB 971168 D01 Power Meas License Digital Systems v03r01 with maximum output power.

Radiated measurements are performed by rotating the EUT in three different orthogonal test planes to find the maximum emission.

Test Items	Band	Bandwidth (MHz)						Modulation			RB #			Test Channel		
		1.4	3	5	10	15	20	QPSK	16QAM	64QAM	1	Half	Full	L	M	H
Max. Output Power	2	v	v	v	v	v	v	v	v	v	v	v	v	v	v	v
	5	v	v	v	v	-	-	v	v	v	v	v	v	v	v	v
	7	-	-	v	v	v	v	v	v	v	v	v	v	v	v	v
	26	v	v	v	v	v	-	v	v	v	v	v	v	v	v	v
	38	-	-	v	v	v	v	v	v	v	v	v	v	v	v	v
	41	-	-	v	v	v	v	v	v	v	v	v	v	v	v	v
Peak-to-Average Ratio	5				v	-	-	v	v	v	v		v	v	v	v
	26				v		-	v	v	v	v		v	v	v	v
	38	-	-				v	v	v	v	v		v	v	v	v
	41	-	-				v	v	v	v	v		v	v	v	v
26dB and 99% Bandwidth	5	v	v	v	v	-	-	v	v	v			v	v	v	v
	26	v	v	v	v	v	-	v	v	v			v	v	v	v
	38	-	-	v	v	v	v	v	v	v			v	v	v	v
	41	-	-	v	v	v	v	v	v	v			v	v	v	v
Conducted Band Edge	5	v	v	v	v	-	-	v	v	v	v		v	v		v
	26	v	v	v	v	v	-	v	v	v	v		v	v		v
	38	-	-	v	v	v	v	v	v	v	v		v	v		v
	41	-	-	v	v	v	v	v	v	v	v		v	v		v
Conducted Spurious Emission	5	v	v	v	v	-	-	v	v	v	v			v	v	v
	26	v	v	v	v	v	-	v	v	v	v			v	v	v
	38	-	-	v	v	v	v	v	v	v	v			v	v	v
	41	-	-	v	v	v	v	v	v	v	v			v	v	v



Test Items	Band	Bandwidth (MHz)						Modulation			RB #			Test Channel			
		1.4	3	5	10	15	20	QPSK	16QAM	64QAM	1	Half	Full	L	M	H	
Frequency Stability	5				v	-	-	v						v		v	
	26				v		-	v						v		v	
	38	-	-		v			v						v		v	
	41	-	-		v			v						v		v	
E.R.P / E.I.R.P	2	v	v	v	v	v	v	v	v	v	v	v	v	v	v	v	v
	5	v	v	v	v	-	-	v	v	v	v	v	v	v	v	v	v
	7	-	-	v	v	v	v	v	v	v	v	v	v	v	v	v	v
	26	v	v	v	v	v	-	v	v	v	v	v	v	v	v	v	v
	38	-	-	v	v	v	v	v	v	v	v	v	v	v	v	v	v
	41	-	-	v	v	v	v	v	v	v	v	v	v	v	v	v	v
Radiated Spurious Emission	5	Worst Case													v		
	26	Worst Case													v		
	38	Worst Case													v		
	41	Worst Case													v		
Note	<ol style="list-style-type: none"> The mark "v" means that this configuration is chosen for testing The mark "-" means that this bandwidth is not supported. The device is investigated from 30MHz to 10 times of fundamental signal for radiated spurious emission test under different RB size/offset and modulations in exploratory test. Subsequently, only the worst case emissions are reported. 																

2.2 Connection Diagram of Test System

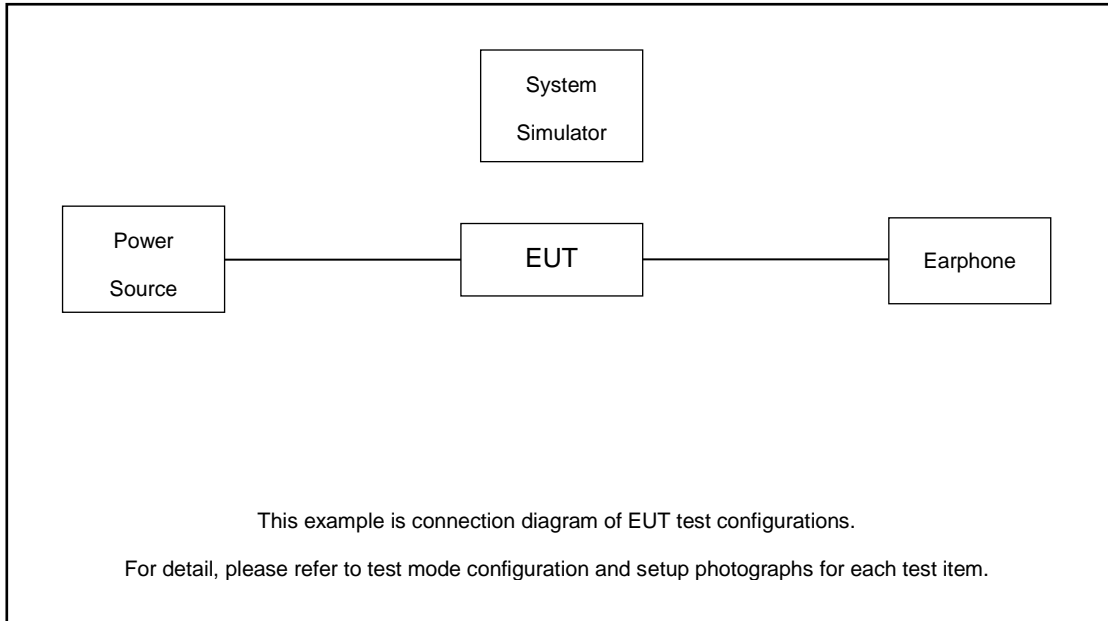

2.3 Support Unit used in test configuration and system

Item	Equipment	Trade Name	Model No.	FCC ID	Data Cable	Power Cord
1.	System Simulator	Anritsu	MT8820C	N/A	N/A	Unshielded, 1.8 m
2.	Power Supply	GWINSTEK	PSS-2002	N/A	N/A	Unshielded, 1.8 m

2.4 Measurement Results Explanation Example

For all conducted test items:

The offset level is set in the spectrum analyzer to compensate the RF cable loss between EUT conducted output port and spectrum analyzer. With the offset compensation, the spectrum analyzer reading level is exactly the EUT RF output level.

The spectrum analyzer offset is derived from RF cable loss.

Offset = RF cable loss.

Following shows an offset computation example with cable loss 4.0 dB.

Example :

$$\begin{aligned} \text{Offset(dB)} &= \text{RF cable loss(dB)}. \\ &= 4.0 \text{ (dB)} \end{aligned}$$



2.5 Frequency List of Low/Middle/High Channels

LTE Band 2 Channel and Frequency List				
BW [MHz]	Channel/Frequency(MHz)	Lowest	Middle	Highest
20	Channel	18700	18900	19100
	Frequency	1860	1880	1900
15	Channel	18675	18900	19125
	Frequency	1857.5	1880	1902.5
10	Channel	18650	18900	19150
	Frequency	1855	1880	1905
5	Channel	18625	18900	19175
	Frequency	1852.5	1880	1907.5
3	Channel	18615	18900	19185
	Frequency	1851.5	1880	1908.5
1.4	Channel	18607	18900	19193
	Frequency	1850.7	1880	1909.3

LTE Band 5 Channel and Frequency List				
BW [MHz]	Channel/Frequency(MHz)	Lowest	Middle	Highest
10	Channel	20450	20525	20600
	Frequency	829	836.5	844
5	Channel	20425	20525	20625
	Frequency	826.5	836.5	846.5
3	Channel	20415	20525	20635
	Frequency	825.5	836.5	847.5
1.4	Channel	20407	20525	20643
	Frequency	824.7	836.5	848.3



LTE Band 7 Channel and Frequency List				
BW [MHz]	Channel/Frequency(MHz)	Lowest	Middle	Highest
20	Channel	20850	21100	21350
	Frequency	2510	2535	2560
15	Channel	20825	21100	21375
	Frequency	2507.5	2535	2562.5
10	Channel	20800	21100	21400
	Frequency	2505	2535	2565
5	Channel	20775	21100	21425
	Frequency	2502.5	2535	2567.5

LTE Band 26 Channel and Frequency List				
BW [MHz]	Channel/Frequency(MHz)	Lowest	Middle	Highest
15	Channel	26865	26915	26965
	Frequency	831.5	836.5	841.5
10	Channel	26840	26915	26990
	Frequency	829	836.5	844
5	Channel	26815	26915	27015
	Frequency	826.5	836.5	846.5
3	Channel	26805	26915	27025
	Frequency	825.5	836.5	847.5
1.4	Channel	26797	26915	27033
	Frequency	824.7	836.5	848.3



LTE Band 38 Channel and Frequency List				
BW [MHz]	Channel/Frequency(MHz)	Lowest	Middle	Highest
20	Channel	37850	38000	38150
	Frequency	2580	2595	2610
15	Channel	37825	38000	38175
	Frequency	2577.5	2595	2612.5
10	Channel	37800	38000	38200
	Frequency	2575	2595	2615
5	Channel	37775	38000	38225
	Frequency	2572.5	2595	2617.5

LTE Band 41 Channel and Frequency List				
BW [MHz]	Channel/Frequency(MHz)	Lowest	Middle	Highest
20	Channel	39750	40620	41490
	Frequency	2506	2593	2680
15	Channel	39725	40620	41515
	Frequency	2503.5	2593	2682.5
10	Channel	39700	40620	41540
	Frequency	2501	2593	2685
5	Channel	39675	40620	41565
	Frequency	2498.5	2593	2687.5

3 Conducted Test Items

3.1 Measuring Instruments

See list of measuring instruments of this test report.

3.2 Test Setup

3.2.1 Conducted Output Power

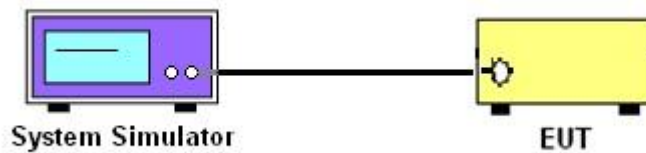

3.2.2 Peak-to-Average Ratio, Occupied Bandwidth ,Conducted Band-Edge and Conducted Spurious Emission

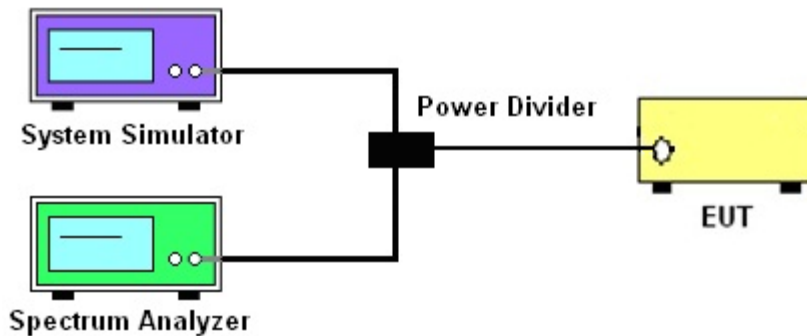

3.2.3 Frequency Stability

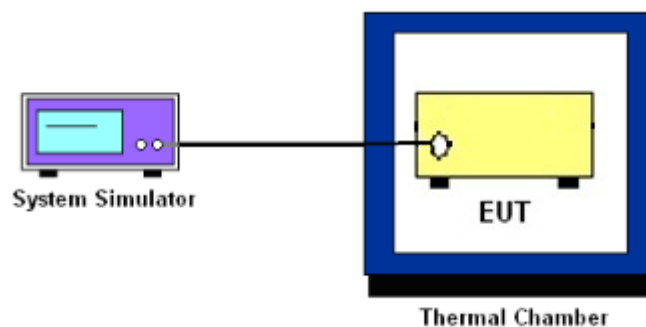



3.3 Test Result of Conducted Test

Please refer to Appendix A.

3.4 Conducted Output Power and ERP/EIRP

3.4.1 Description of the Conducted Output Power Measurement and ERP/EIRP Measurement

A system simulator was used to establish communication with the EUT. Its parameters were set to force the EUT transmitting at maximum output power. The measured power in the radio frequency on the transmitter output terminals shall be reported.

The ERP of mobile transmitters must not exceed 7 Watts for LTE Band 5 and Band 26.

The EIRP of mobile transmitters must not exceed 2 Watts for LTE Band 2 and Band 7 and Band 38 and Band 41.

According to KDB 412172 D01 Power Approach,

$EIRP = P_T + G_T - L_C$, $ERP = EIRP - 2.15$, where

P_T = transmitter output power in dBm

G_T = gain of the transmitting antenna in dBi

L_C = signal attenuation in the connecting cable between the transmitter and antenna in dB

3.4.2 Test Procedures

1. The testing follows ANSI C63.26 Section 5.2
2. The transmitter output port was connected to the system simulator.
3. Set EUT at maximum power through the system simulator.
4. Select lowest, middle, and highest channels for each band and different modulation.
5. Measure and record the power level from the system simulator.



3.5 Peak-to-Average Ratio

3.5.1 Description of the PAR Measurement

Power Complementary Cumulative Distribution Function (CCDF) curves provide a means for characterizing the power peaks of a digitally modulated signal on a statistical basis. A CCDF curve depicts the probability of the peak signal amplitude exceeding the average power level. Most contemporary measurement instrumentation include the capability to produce CCDF curves for an input signal provided that the instrument's resolution bandwidth can be set wide enough to accommodate the entire input signal bandwidth. In measuring transmissions in this band using an average power technique, the peak-to-average ratio (PAR) of the transmission may not exceed 13 dB.

3.5.2 Test Procedures

1. The testing follows ANSI C63.26 Section 5.2.3.4 (CCDF).
2. The EUT was connected to spectrum and system simulator via a power divider.
3. Set the CCDF (Complementary Cumulative Distribution Function) option in spectrum analyzer.
4. The highest RF powers were measured and recorded the maximum PAPR level associated with a probability of 0.1 %.
5. Record the deviation as Peak to Average Ratio.



3.6 Occupied Bandwidth

3.6.1 Description of Occupied Bandwidth Measurement

The occupied bandwidth is the width of a frequency band such that, below the lower and above the upper frequency limits, the mean powers emitted are each equal to a specified percentage 0.5% of the total mean transmitted power.

The 26 dB emission bandwidth is defined as the frequency range between two points, one above and one below the carrier frequency, at which the spectral density of the emission is attenuated 26 dB below the maximum in-band spectral density of the modulated signal. Spectral density (power per unit bandwidth) is to be measured with a detector of resolution bandwidth equal to approximately 1.0% of the emission bandwidth.

3.6.2 Test Procedures

1. The testing follows ANSI C63.26 Section 5.4
2. The EUT was connected to spectrum analyzer and system simulator via a power divider.
3. The spectrum analyzer center frequency is set to the nominal EUT channel center frequency. The span range for the spectrum analyzer shall be between two and five times the anticipated OBW.
4. The nominal resolution bandwidth (RBW) shall be in the range of 1 to 5 % of the anticipated OBW, and the VBW shall be at least 3 times the RBW.
5. Set the detection mode to peak, and the trace mode to max hold.
6. Determine the reference value: Set the EUT to transmit a modulated signal. Allow the trace to stabilize. Set the spectrum analyzer marker to the highest level of the displayed trace.
(this is the reference value)
7. Determine the “-26 dB down amplitude” as equal to (Reference Value – X).
8. Place two markers, one at the lowest and the other at the highest frequency of the envelope of the spectral display such that each marker is at or slightly below the “-X dB down amplitude” determined in step 6. If a marker is below this “-X dB down amplitude” value it shall be placed as close as possible to this value. The OBW is the positive frequency difference between the two markers.
9. Use the 99 % power bandwidth function of the spectrum analyzer and report the measured bandwidth.



3.7 Conducted Band Edge

3.7.1 Description of Conducted Band Edge Measurement

22.917(a)

For operations in the 824 – 849 MHz band, the FCC limit is $43 + 10\log_{10}(P[\text{Watts}])$ dB below the transmitter power $P(\text{Watts})$ in a 100kHz bandwidth. However, in the 1MHz bands immediately outside and adjacent to the licensee's frequency block, a resolution bandwidth of at least one percent of the emission bandwidth of the fundamental emission of the transmitter may be employed.

24.238 (a)

For operations in the 1850-1910 and 1930-1990 MHz band, the FCC limit is $43 + 10\log_{10}(P[\text{Watts}])$ dB below the transmitter power $P(\text{Watts})$ in a 1MHz bandwidth. However, in the 1 MHz bands immediately outside and adjacent to the frequency block a resolution bandwidth of at least one percent of the emission bandwidth of the fundamental emission of the transmitter may be employed.

27.53(m)(4)

For mobile digital stations, the attenuation factor shall be not less than $40 + 10 \log (P)$ dB on all frequencies between the channel edge and 5 megahertz from the channel edge, $43 + 10 \log (P)$ dB on all frequencies between 5 megahertz and X megahertz from the channel edge, and $55 + 10 \log (P)$ dB on all frequencies more than X megahertz from the channel edge, where X is the greater of 6 megahertz or the actual emission bandwidth as defined in paragraph (m)(6) of this section. In addition, the attenuation factor shall not be less that $43 + 10 \log (P)$ dB on all frequencies between 2490.5 MHz and 2496 MHz and $55 + 10 \log (P)$ dB at or below 2490.5 MHz. Mobile Satellite Service licensees operating on frequencies below 2495 MHz may also submit a documented interference complaint against BRS licensees operating on channel BRS Channel 1 on the same terms and conditions as adjacent channel BRS or EBS licensees.



3.7.2 Test Procedures

1. The testing follows ANSI C63.26 section 5.7
2. The EUT was connected to spectrum analyzer and system simulator via a power divider.
3. The band edges of low and high channels for the highest RF powers were measured.
4. Set RBW \geq 1% EBW in the 1MHz band immediately outside and adjacent to the band edge.
5. Beyond the 1 MHz band from the band edge, RBW=1MHz was used.
6. Set spectrum analyzer with RMS detector.
7. The RF fundamental frequency should be excluded against the limit line in the operating frequency band.
8. Checked that all the results comply with the emission limit line.

Example:

The limit line is derived from $43 + 10\log(P)$ dB below the transmitter power P(Watts)

$$= P(W) - [43 + 10\log(P)] \text{ (dB)}$$

$$= [30 + 10\log(P)] \text{ (dBm)} - [43 + 10\log(P)] \text{ (dB)} = -13\text{dBm.}$$

9. For LTE Band 7, 38, 41, the other 40 dB, and 55 dB have additionally applied same calculation above.



3.8 Conducted Spurious Emission

3.8.1 Description of Conducted Spurious Emission Measurement

The power of any emission outside of the authorized operating frequency ranges must be lower than the transmitter power (P) by a factor of at least $43 + 10 \log (P)$ dB.

For Band 7,38,41:

The power of any emission outside of the authorized operating frequency ranges must be lower than the transmitter power (P) by a factor of at least $55 + 10 \log (P)$ dB.

It is measured by means of a calibrated spectrum analyzer and scanned from 30 MHz up to a frequency including its 10th harmonic.

3.8.2 Test Procedures

1. The testing follows ANSI C63.26 section 5.7
2. The EUT was connected to spectrum analyzer and system simulator via a power divider.
3. The RF output of EUT was connected to the spectrum analyzer by RF cable and attenuator. The path loss was compensated to the results for each measurement.
4. The middle channel for the highest RF power within the transmitting frequency was measured.
5. The conducted spurious emission for the whole frequency range was taken.
6. Make the measurement with the spectrum analyzer's RBW = 1MHz, VBW = 3MHz.
7. Set spectrum analyzer with RMS detector.
8. Taking the record of maximum spurious emission.
9. The RF fundamental frequency should be excluded against the limit line in the operating frequency band.
10. The limit line is derived from $43 + 10\log(P)$ dB below the transmitter power P(Watts)
= $P(W) - [43 + 10\log(P)]$ (dB)
= $[30 + 10\log(P)]$ (dBm) - $[43 + 10\log(P)]$ (dB)
= -13dBm.
11. For Band 7, 38, 41
The limit line is derived from $55 + 10\log(P)$ dB below the transmitter power P(Watts)
= $P(W) - [55 + 10\log(P)]$ (dB)
= $[30 + 10\log(P)]$ (dBm) - $[55 + 10\log(P)]$ (dB)
= -25dBm.



3.9 Frequency Stability

3.9.1 Description of Frequency Stability Measurement

The frequency stability shall be measured by variation of ambient temperature and variation of primary supply voltage to ensure that the fundamental emission stays within the authorized frequency block. The frequency stability of the transmitter shall be maintained within $\pm 0.00025\%$ ($\pm 2.5\text{ppm}$) of the center frequency.

3.9.2 Test Procedures for Temperature Variation

1. The testing follows ANSI C63.26 section 5.6.4
2. The EUT was set up in the thermal chamber and connected with the system simulator.
3. With power OFF, the temperature was decreased to -30°C and the EUT was stabilized before testing. Power was applied and the maximum change in frequency was recorded within one minute.
4. With power OFF, the temperature was raised in 10°C step up to 50°C . The EUT was stabilized at each step for at least half an hour. Power was applied and the maximum frequency change was recorded within one minute.

3.9.3 Test Procedures for Voltage Variation

1. The testing follows ANSI C63.26 section 5.6.5
2. The EUT was placed in a temperature chamber at $20\pm 5^{\circ}\text{C}$ and connected with the system simulator.
3. The power supply voltage to the EUT was varied from 85% to 115% of the nominal value for other than hand carried battery equipment.
4. For hand carried, battery powered equipment, reduce the primary ac or dc supply voltage to the battery operating end point, which shall be specified by the manufacturer.
5. The variation in frequency was measured for the worst case.

4 Radiated Test Items

4.1 Measuring Instruments

See list of measuring instruments of this test report.

4.2 Test Setup

4.2.1 For radiated test below 30MHz

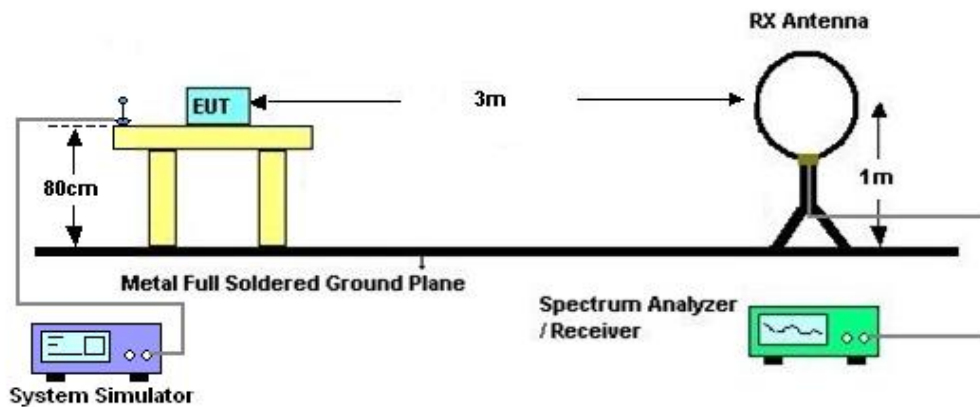

4.2.2 For radiated test from 30MHz to 1GHz

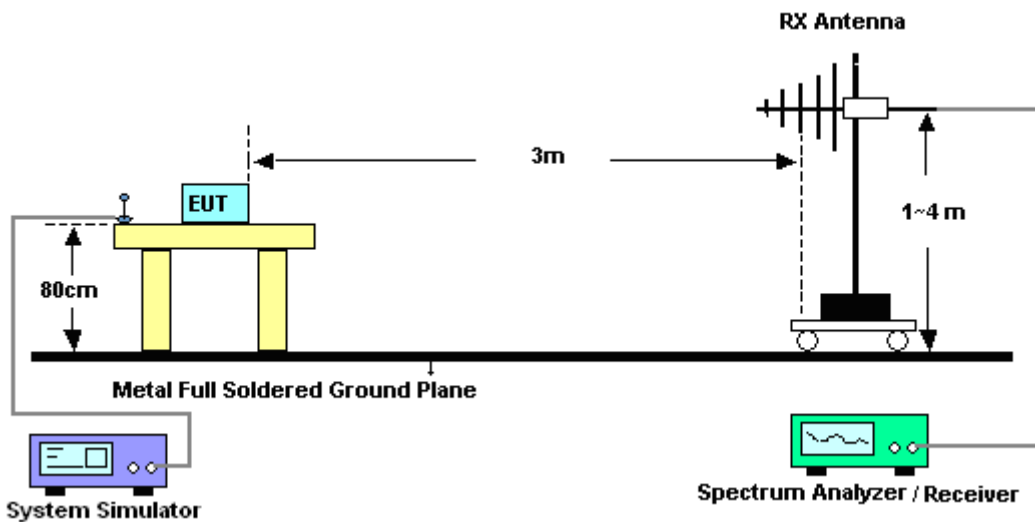

4.2.3 For radiated test above 1GHz

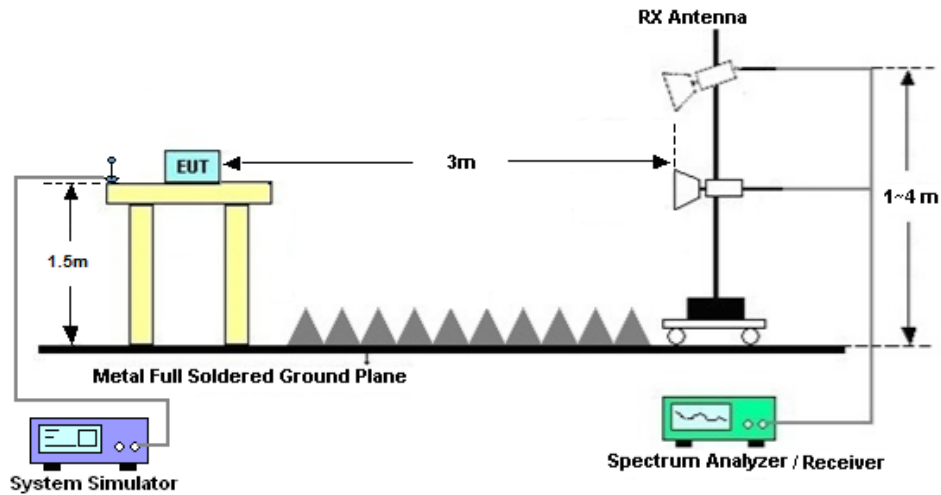

4.3 Test Result of Radiated Test

The low frequency, which started from 9 kHz to 30MHz, was pre-scanned and the result which was 20dB lower than the limit line was not reported.

Please refer to Appendix B.



4.4 Radiated Spurious Emission

4.4.1 Description of Radiated Spurious Emission

The radiated spurious emission was measured by substitution method according to ANSI C63.26. The power of any emission outside of the authorized operating frequency ranges must be attenuated below the transmitter power (P) by a factor of at least $43 + 10 \log (P)$ dB.

For Band 7, 38, 41

The power of any emission outside of the authorized operating frequency ranges must be attenuated below the transmitter power (P) by a factor of at least $55 + 10 \log (P)$ dB.

The spectrum is scanned from 30 MHz up to a frequency including its 10th harmonic.

4.4.2 Test Procedures

1. The testing follows ANSI C63.26 Section 5.5
2. The EUT was placed on a turntable with 0.8 meter height for frequency below 1GHz and 1.5 meter height for frequency above 1GHz respectively above ground.
3. The EUT was set 3 meters from the receiving antenna mounted on the antenna tower.
4. The table was rotated 360 degrees to determine the position of the highest spurious emission.
5. The height of the receiving antenna is varied between 1m to 4m to search the maximum spurious emission for both horizontal and vertical polarizations.
6. During the measurement, the system simulator parameters were set to force the EUT transmitting at maximum output power.
7. Make the measurement with the spectrum analyzer's RBW = 1MHz, VBW = 3MHz, taking the record of maximum spurious emission.
8. A horn antenna was substituted in place of the EUT and was driven by a signal generator.
9. Tune the output power of signal generator to the same emission level with EUT maximum spurious emission.
10. $EIRP (dBm) = S.G. Power - Tx Cable Loss + Tx Antenna Gain$
11. $ERP (dBm) = EIRP - 2.15$
12. The RF fundamental frequency should be excluded against the limit line in the operating frequency band.

The limit line is derived from $43 + 10\log(P)$ dB below the transmitter power P(Watts)
 $= P(W) - [43 + 10\log(P)] (dB)$
 $= [30 + 10\log(P)] (dBm) - [43 + 10\log(P)] (dB)$
 $= -13dBm.$

13. For Band 7, 38, 41:

The limit line is derived from $55 + 10\log(P)$ dB below the transmitter power P(Watts)



5 List of Measuring Equipment

Instrument	Manufacturer	Model No.	Serial No.	Characteristics	Calibration Date	Test Date	Due Date	Remark
Spectrum Analyzer	R&S	FSV40	101078	10Hz~40GHz	Apr. 08, 2021	Aug. 06, 2021~ Aug. 10, 2021	Apr. 07, 2022	Conducted (TH01-SZ)
DC Power Supply	TTI	PL330P	290070	Max 32V, 3A	Oct. 15, 2020	Aug. 06, 2021~ Aug. 10, 2021	Oct. 14, 2021	Conducted (TH01-SZ)
Power Divider	TOJOIN	PS-2SM-04 265	60.06.020.007 7	0.4GHz~26.5GHz	Dec. 26, 2020	Aug. 06, 2021~ Aug. 10, 2021	Dec. 25, 2021	Conducted (TH01-SZ)
Thermal Chamber	Ten Billion Hongzhangroup	LP-150U	H2014081803	-40~+150°C	Jul. 14, 2021	Aug. 06, 2021~ Aug. 10, 2021	Jul. 13, 2022	Conducted (TH01-SZ)
EXA Spectrum Analyzer	KEYSIGHT	N9010A	MY55150213	10Hz~44GHz	Jul. 13, 2021	Aug. 05, 2021	Jul. 12, 2022	Radiation (03CH02-SZ)
Loop Antenna	R&S	HFH2-Z2	100354	9kHz~30MHz	Jun. 22, 2020	Aug. 05, 2021	Jun. 21, 2022	Radiation (03CH02-SZ)
Bilog Antenna	TeseQ	CBL6112D	35408	30MHz-2GHz	Jul. 14, 2021	Aug. 05, 2021	Jul. 13, 2022	Radiation (03CH02-SZ)
Double Ridge Horn Antenna	ETS-Lindgren	3117	00119436	1GHz~18GHz	Jul. 25, 2021	Aug. 05, 2021	Jul. 24, 2022	Radiation (03CH02-SZ)
SHF-EHF Horn	com-power	AH-840	101071	18GHz-40GHz	Apr. 11, 2021	Aug. 05, 2021	Apr. 10, 2022	Radiation (03CH02-SZ)
LF Amplifier	Bur35407geon	BPA-530	102211	0.01~3000Mhz	Jul. 13, 2021	Aug. 05, 2021	Jul. 13, 2022	Radiation (03CH02-SZ)
HF Amplifier	KEYSIGHT	83017A	MY53270105	0.5GHz~26.5Ghz	Oct. 16, 2020	Aug. 05, 2021	Oct. 15, 2021	Radiation (03CH02-SZ)
HF Amplifier	MITEQ	TTA1840-35 -HG	1871923	18GHz~40GHz	Jul. 13, 2021	Aug. 05, 2021	Jul. 13, 2022	Radiation (03CH02-SZ)
AC Power Source	Chroma	61601	616010002470	N/A	NCR	Aug. 05, 2021	NCR	Radiation (03CH02-SZ)
Turn Table	Chaintek	T-200	N/A	0~360 degree	NCR	Aug. 05, 2021	NCR	Radiation (03CH02-SZ)
Antenna Mast	Chaintek	MBS-400	N/A	1 m~4 m	NCR	Aug. 05, 2021	NCR	Radiation (03CH02-SZ)

NCR: No Calibration Required



6 Uncertainty of Evaluation

The measurement uncertainties shown below were calculated in accordance with the requirements of ANSI 63.26-2015. All the measurement uncertainty value were shown with a coverage K=2 to indicate 95% level of confidence. The measurement data show herein meets or exceeds the CISPR measurement uncertainty values specified in CISPR 16-4-2 and can be compared directly to specified limit to determine compliance.

Uncertainty of Radiated Emission Measurement (30 MHz ~ 1000 MHz)

Measuring Uncertainty for a Level of Confidence of 95% (U = 2Uc(y))	2.47dB
---	--------

Uncertainty of Radiated Emission Measurement (1 GHz ~ 18 GHz)

Measuring Uncertainty for a Level of Confidence of 95% (U = 2Uc(y))	3.31dB
---	--------

Uncertainty of Radiated Emission Measurement (18 GHz ~ 40 GHz)

Measuring Uncertainty for a Level of Confidence of 95% (U = 2Uc(y))	3.72dB
---	--------



Appendix A. Test Results of Conducted Test

Conducted Output Power(Average power)and ERP/EIRP

LTE Band 2									
BW [MHz]	Modulation	RB Size	RB Offset	Power Low Ch. / Freq.	Power Middle Ch. / Freq.	Power High Ch. / Freq.	EIRP(W)		
Channel				18700	18900	19100			
Frequency (MHz)				1860	1880	1900	L	M	H
20	QPSK	1	0	22.68	22.89	22.57	0.0791	0.0830	0.0771
20	QPSK	1	99	22.44	22.47	22.51	0.0748	0.0753	0.0760
20	QPSK	100	0	21.70	21.78	21.67	0.0631	0.0643	0.0627
20	16QAM	1	0	22.79	21.89	21.84	0.0811	0.0659	0.0652
20	64QAM	1	0	20.86	20.78	20.87	0.0520	0.0511	0.0521
Channel				18675	18900	19125	EIRP(W)		
Frequency (MHz)				1857.5	1880	1902.5	L	M	H
15	QPSK	1	0	22.79	22.79	22.67	0.0811	0.0811	0.0789
15	16QAM	1	0	21.89	21.72	21.73	0.0659	0.0634	0.0635
Channel				18650	18900	19150	EIRP(W)		
Frequency (MHz)				1855	1880	1905	L	M	H
10	QPSK	1	0	22.78	22.70	22.58	0.0809	0.0794	0.0773
10	16QAM	1	0	21.59	21.87	21.93	0.0615	0.0656	0.0665
Channel				18625	18900	19175	EIRP(W)		
Frequency (MHz)				1852.5	1880	1907.5	L	M	H
5	QPSK	1	0	22.47	22.71	22.53	0.0753	0.0796	0.0764
5	16QAM	1	0	21.91	21.86	22.07	0.0662	0.0655	0.0687
Channel				18615	18900	19185	EIRP(W)		
Frequency (MHz)				1851.5	1880	1908.5	L	M	H
3	QPSK	1	0	22.67	22.61	22.59	0.0789	0.0778	0.0774
3	16QAM	1	0	21.97	21.89	22.14	0.0671	0.0659	0.0698
Channel				18607	18900	19193	EIRP(W)		
Frequency (MHz)				1850.7	1880	1909.3	L	M	H
1.4	QPSK	1	0	21.85	21.85	21.75	0.0653	0.0653	0.0638
1.4	16QAM	1	0	21.89	22.01	21.90	0.0659	0.0678	0.0661



LTE Band 5									
BW [MHz]	Modulation	RB Size	RB Offset	Power Low Ch. / Freq.	Power Middle Ch. / Freq.	Power High Ch. / Freq.	ERP(W)		
Channel				20450	20525	20600			
Frequency (MHz)				829	836.5	844	L	M	H
10	QPSK	1	0	22.98	23.05	22.85	0.0460	0.0468	0.0447
10	QPSK	1	49	22.88	22.81	22.93	0.0450	0.0443	0.0455
10	QPSK	50	0	22.01	22.11	22.08	0.0368	0.0377	0.0374
10	16QAM	1	0	22.05	22.03	23.04	0.0372	0.0370	0.0467
10	64QAM	1	0	21.04	20.91	21.02	0.0294	0.0286	0.0293
Channel				20425	20525	20625	ERP(W)		
Frequency (MHz)				826.5	836.5	846.5	L	M	H
5	QPSK	1	0	22.93	22.98	21.96	0.0455	0.0460	0.0364
5	16QAM	1	0	22.15	21.91	21.99	0.0380	0.0360	0.0366
Channel				20415	20525	20635	ERP(W)		
Frequency (MHz)				825.5	836.5	847.5	L	M	H
3	QPSK	1	0	22.86	22.98	22.93	0.0448	0.0460	0.0455
3	16QAM	1	0	22.26	21.91	22.00	0.0390	0.0360	0.0367
Channel				20407	20525	20643	ERP(W)		
Frequency (MHz)				824.7	836.5	848.3	L	M	H
1.4	QPSK	1	0	22.73	23.04	23.00	0.0435	0.0467	0.0462
1.4	16QAM	1	0	21.75	21.82	22.03	0.0347	0.0352	0.0370



LTE Band 7									
BW [MHz]	Modulation	RB Size	RB Offset	Power Low Ch. / Freq.	Power Middle Ch. / Freq.	Power High Ch. / Freq.	EIRP(W)		
Channel				20850	20850	21350			
Frequency (MHz)				2510	2535	2560	L	M	H
20	QPSK	1	0	22.25	22.31	22.29	0.1012	0.1026	0.1021
20	QPSK	1	99	22.25	22.30	22.29	0.1012	0.1023	0.1021
20	QPSK	100	0	21.48	21.57	21.52	0.0847	0.0865	0.0855
20	16QAM	1	0	21.65	21.38	22.29	0.0881	0.0828	0.1021
20	64QAM	1	0	20.56	20.64	20.37	0.0685	0.0698	0.0656
Channel				20825	21100	21375	EIRP(W)		
Frequency (MHz)				2507.5	2535	2562.5	L	M	H
15	QPSK	1	0	22.29	22.24	22.29	0.1021	0.1009	0.1021
15	16QAM	1	0	21.42	21.62	21.47	0.0836	0.0875	0.0845
Channel				20800	21100	21400	EIRP(W)		
Frequency (MHz)				2505	2535	2565	L	M	H
10	QPSK	1	0	22.28	22.26	22.20	0.1019	0.1014	0.1000
10	16QAM	1	0	21.51	21.46	21.68	0.0853	0.0843	0.0887
Channel				20775	21100	21425	EIRP(W)		
Frequency (MHz)				2502.5	2535	2567.5	L	M	H
5	QPSK	1	0	22.15	22.29	22.25	0.0989	0.1021	0.1012
5	16QAM	1	0	21.66	21.54	21.67	0.0883	0.0859	0.0885



LTE Band 26											
BW [MHz]	Modulation	RB Size	RB Offset	Power Low Ch. / Freq.	Power Low Ch. / Freq.	Power Middle Ch. / Freq.	Power High Ch. / Freq.	ERP(W)			
Channel				26765	26865	26915	26965				
Frequency (MHz)				821.5	831.5	836.5	841.5	L	M	H	
15	QPSK	1	0	23.01	23.01	23.07	22.95	0.0463	0.0463	0.0470	0.0457
15	QPSK	1	74	22.90	22.90	22.81	22.85	0.0452	0.0452	0.0443	0.0447
15	QPSK	75	0	22.02	22.02	22.06	21.94	0.0369	0.0369	0.0372	0.0362
15	16QAM	1	0	22.02	22.02	21.90	23.05	0.0369	0.0369	0.0359	0.0468
15	64QAM	1	0	21.04	21.04	20.81	20.82	0.0294	0.0294	0.0279	0.0280
Channel					26840	26915	26990	ERP(W)			
Frequency (MHz)					829	836.5	844	L	M	H	
10	QPSK	1	0	22.95	22.92	23.05		0.0457	0.0454	0.0468	
10	16QAM	1	0	22.06	21.78	22.00		0.0372	0.0349	0.0367	
Channel					26815	26915	27015	ERP(W)			
Frequency (MHz)					826.5	836.5	846.5	L	M	H	
5	QPSK	1	0	23.05	22.92	22.94		0.0468	0.0454	0.0456	
5	16QAM	1	0	22.08	21.80	22.20		0.0374	0.0351	0.0385	
Channel					26815	26915	27025	ERP(W)			
Frequency (MHz)					825.5	836.5	847.5	L	M	H	
3	QPSK	1	0	22.91	23.01	22.80		0.0453	0.0463	0.0442	
3	16QAM	1	0	22.10	21.68	22.09		0.0376	0.0341	0.0375	
Channel					26797	26915	27033	ERP(W)			
Frequency (MHz)					824.7	836.5	848.3	L	M	H	
1.4	QPSK	1	0	23.05	22.99	22.98		0.0468	0.0461	0.0460	
1.4	16QAM	1	0	21.78	21.65	22.07		0.0349	0.0339	0.0373	



LTE Band 38									
BW [MHz]	Modulation	RB Size	RB Offset	Power Low Ch. / Freq.	Power Middle Ch. / Freq.	Power High Ch. / Freq.	EIRP(W)		
Channel				37850	38000	38150			
Frequency (MHz)				2580	2595	2610	L	M	H
20	QPSK	1	0	22.05	22.17	22.11	0.0716	0.0736	0.0726
20	QPSK	1	99	22.11	22.08	22.16	0.0726	0.0721	0.0735
20	QPSK	100	0	21.18	21.20	21.15	0.0586	0.0589	0.0582
20	16QAM	1	0	21.03	22.16	21.33	0.0566	0.0735	0.0607
20	64QAM	1	0	20.15	20.26	20.11	0.0462	0.0474	0.0458
Channel				37825	38000	38175	EIRP(W)		
Frequency (MHz)				2577.5	2595	2612.5	L	M	H
15	QPSK	1	0	22.01	22.16	22.05	0.0710	0.0735	0.0716
15	16QAM	1	0	21.29	21.23	21.65	0.0601	0.0593	0.0653
Channel				37800	38000	38200	EIRP(W)		
Frequency (MHz)				2575	2595	2615	L	M	H
10	QPSK	1	0	22.04	22.16	22.07	0.0714	0.0735	0.0719
10	16QAM	1	0	21.36	21.64	21.47	0.0611	0.0652	0.0627
Channel				37775	38000	38225	EIRP(W)		
Frequency (MHz)				2572.5	2595	2617.5	L	M	H
5	QPSK	1	0	22.08	22.16	22.08	0.0721	0.0735	0.0721
5	16QAM	1	0	21.32	21.68	21.43	0.0605	0.0658	0.0621



LTE Band 41									
BW [MHz]	Modulation	RB Size	RB Offset	Power Low Ch. / Freq.	Power Middle Ch. / Freq.	Power High Ch. / Freq.	EIRP(W)		
Channel				39750	40620	41490			
Frequency (MHz)				2506	2593	2680	L	M	H
20	QPSK	1	0	22.22	22.31	22.19	0.1005	0.1026	0.0998
20	QPSK	1	99	22.07	22.24	22.14	0.0971	0.1009	0.0986
20	QPSK	100	0	21.28	21.33	21.31	0.0809	0.0818	0.0815
20	16QAM	1	0	21.63	22.29	21.81	0.0877	0.1021	0.0914
20	64QAM	1	0	20.53	20.47	20.39	0.0681	0.0671	0.0659
Channel				39725	40620	41515	EIRP(W)		
Frequency (MHz)				2503.5	2593	2682.5	L	M	H
15	QPSK	1	0	22.25	22.27	22.28	0.1012	0.1016	0.1019
15	16QAM	1	0	21.43	21.77	21.51	0.0838	0.0906	0.0853
Channel				39700	40620	41540	EIRP(W)		
Frequency (MHz)				2501	2593	2685	L	M	H
10	QPSK	1	0	22.08	22.29	22.09	0.0973	0.1021	0.0975
10	16QAM	1	0	21.66	21.58	21.56	0.0883	0.0867	0.0863
Channel				39675	40620	41565	EIRP(W)		
Frequency (MHz)				2498.5	2593	2687.5	L	M	H
5	QPSK	1	0	22.21	22.25	22.26	0.1002	0.1012	0.1014
5	16QAM	1	0	21.79	21.65	21.83	0.0910	0.0881	0.0918



LTE Band 5

Peak-to-Average Ratio

Mode	LTE Band 5 / 10MHz				
Mod.	QPSK		16QAM		Limit: 13dB
RB Size	1RB	Full RB	1RB	Full RB	Result
Lowest CH	5.04	5.30	6.29	6.14	PASS
Middle CH	4.87	5.33	5.68	6.03	
Highest CH	4.84	5.36	5.83	6.35	
Mode	LTE Band 5 / 10MHz				
Mod.	64QAM				Limit: 13dB
RB Size	1RB	Full RB			Result
Lowest CH	6.87	6.43	-	-	PASS
Middle CH	6.41	6.41	-	-	
Highest CH	6.61	6.43	-	-	



LTE Band 5 / 10MHz / QPSK

Lowest Channel / 1RB

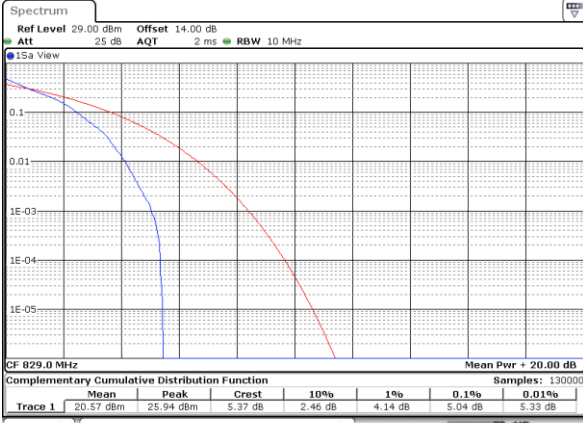

Date: 6 AUG 2021 23:00:06

Lowest Channel / Full RB

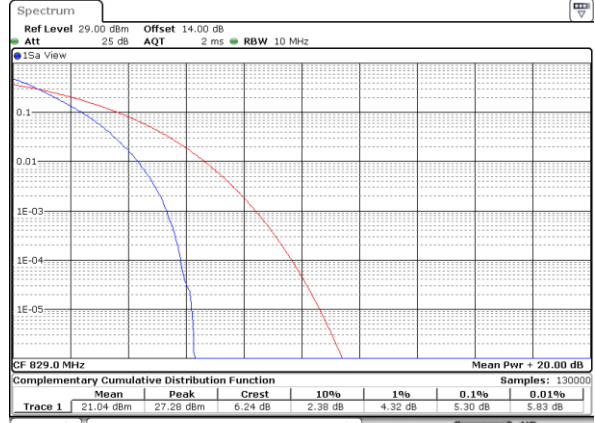

Date: 6 AUG 2021 22:59:01

Middle Channel / 1RB

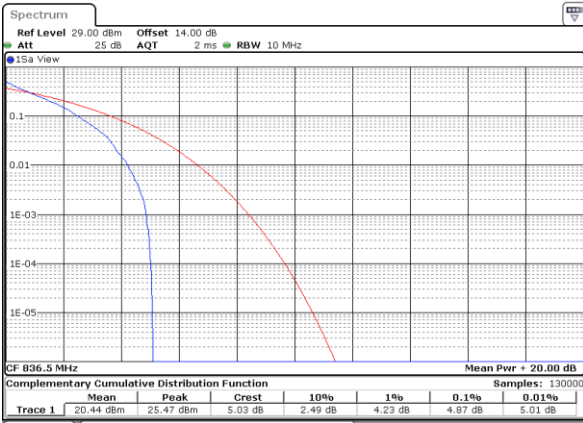

Date: 6 AUG 2021 23:00:19

Middle Channel / Full RB

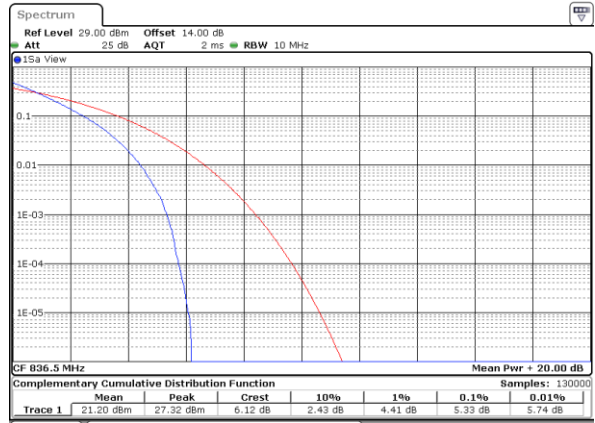

Date: 6 AUG 2021 23:01:24

Highest Channel / 1RB

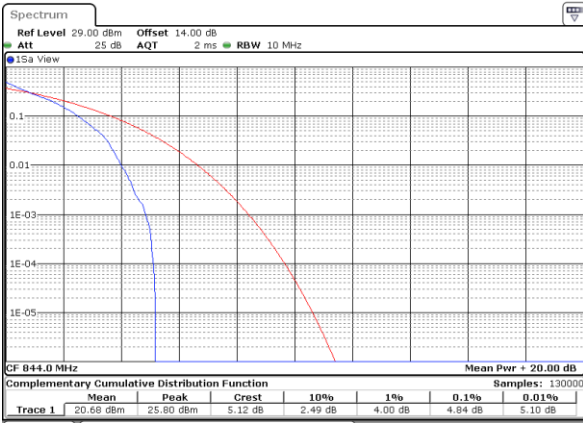

Date: 6 AUG 2021 23:02:40

Highest Channel / Full RB

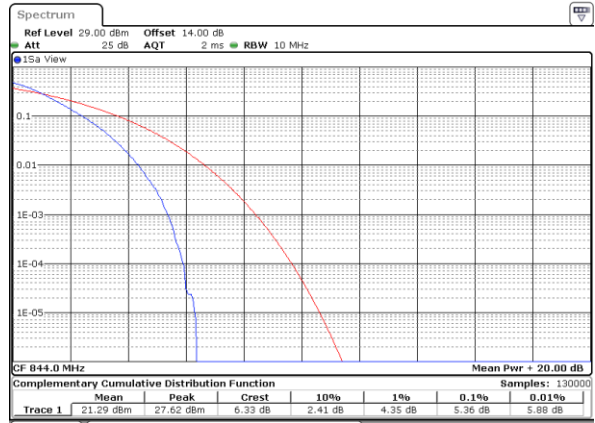

Date: 6 AUG 2021 23:01:38



LTE Band 5 / 10MHz / 16QAM

Lowest Channel / 1RB

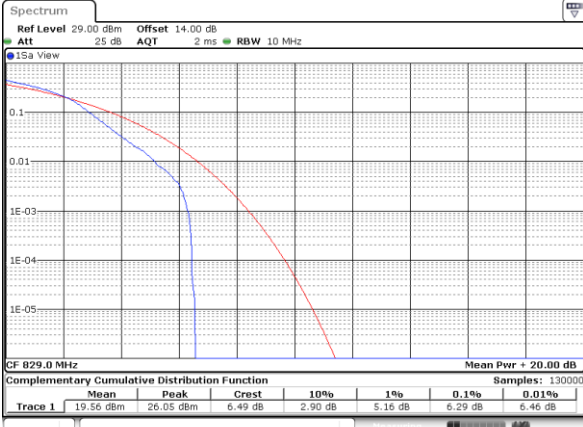

Date: 6 AUG 2021 22:59:54

Lowest Channel / Full RB

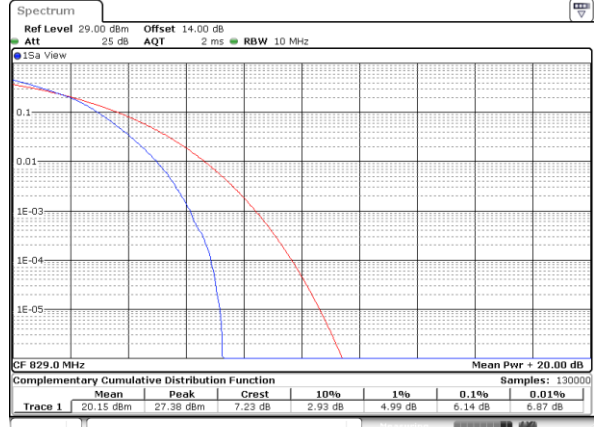

Date: 6 AUG 2021 22:59:15

Middle Channel / 1RB

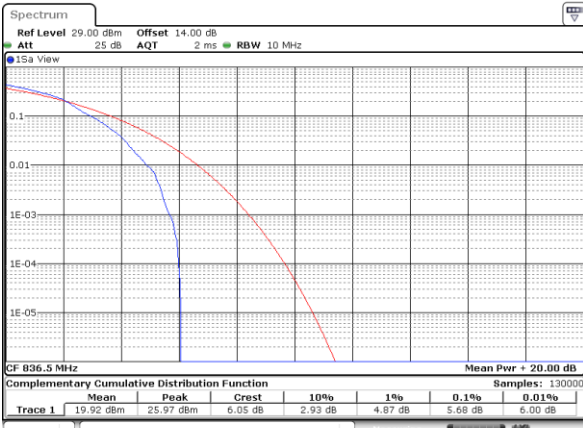

Date: 6 AUG 2021 23:00:31

Middle Channel / Full RB

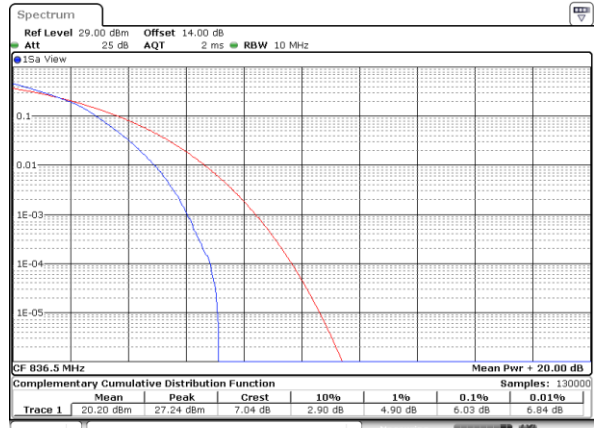

Date: 6 AUG 2021 23:01:12

Highest Channel / 1RB

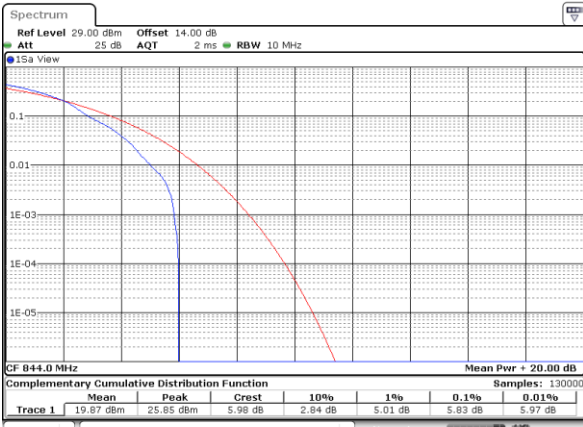

Date: 6 AUG 2021 23:02:28

Highest Channel / Full RB

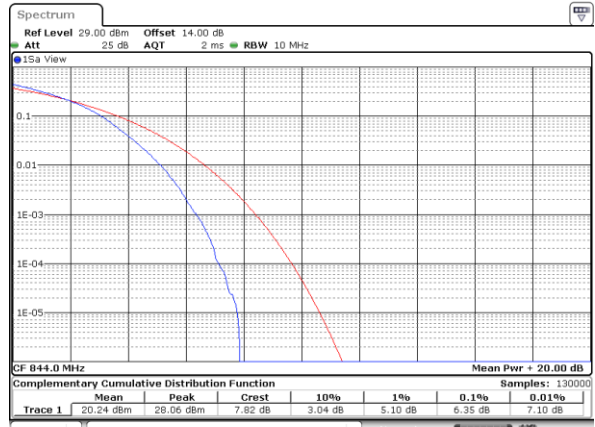

Date: 6 AUG 2021 23:01:51



LTE Band 5 / 10MHz / 64QAM

Lowest Channel / 1RB

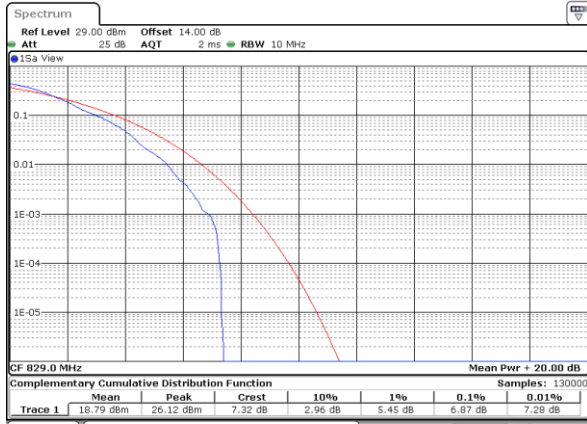

Date: 6 AUG 2021 22:59:42

Lowest Channel / Full RB

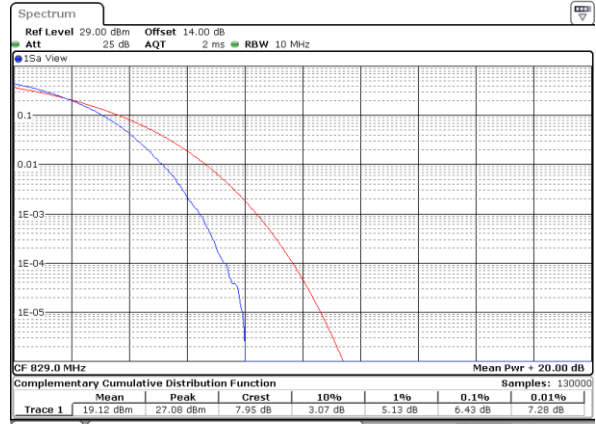

Date: 6 AUG 2021 22:59:28

Middle Channel / 1RB

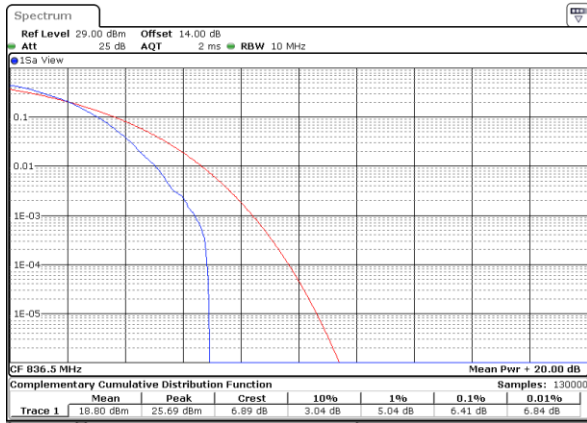

Date: 6 AUG 2021 23:00:47

Middle Channel / Full RB

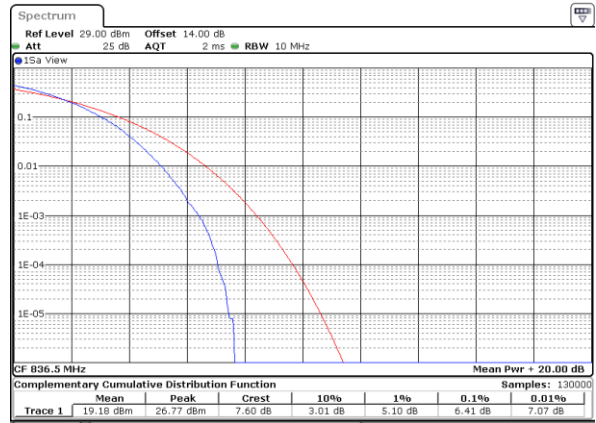

Date: 6 AUG 2021 23:01:00

Highest Channel / 1RB



Date: 6 AUG 2021 23:02:16

Highest Channel / Full RB



Date: 6 AUG 2021 23:02:03



26dB Bandwidth

Mode	LTE Band 5 : 26dB BW(MHz)											
BW	1.4MHz		3MHz		5MHz		10MHz		15MHz		20MHz	
Mod.	QPSK	16QAM	QPSK	16QAM	QPSK	16QAM	QPSK	16QAM	QPSK	16QAM	QPSK	16QAM
Lowest CH	1.27	1.29	2.97	2.92	4.91	4.84	9.69	9.65	-	-	-	-
Middle CH	1.28	1.28	2.98	2.94	4.86	4.83	9.75	9.71	-	-	-	-
Highest CH	1.26	1.26	2.97	2.98	4.80	4.84	9.65	9.61	-	-	-	-
Mode	LTE Band 5 : 26dB BW(MHz)											
BW	1.4MHz		3MHz		5MHz		10MHz		15MHz		20MHz	
Mod.	64QAM		64QAM		64QAM		64QAM		64QAM		64QAM	
Lowest CH	1.30	-	2.97	-	4.87	-	9.93	-	-	-	-	-
Middle CH	1.31	-	2.95	-	4.91	-	9.93	-	-	-	-	-
Highest CH	1.26	-	2.92	-	4.82	-	9.79	-	-	-	-	-



LTE Band 5

Lowest Channel / 1.4MHz / QPSK

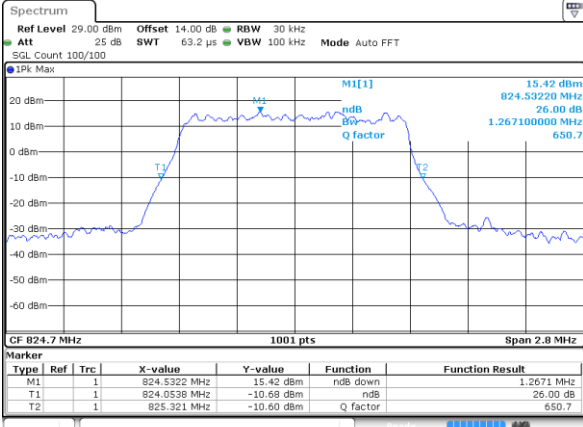

Date: 6 AUG 2021 19:41:46

Lowest Channel / 1.4MHz / 16QAM

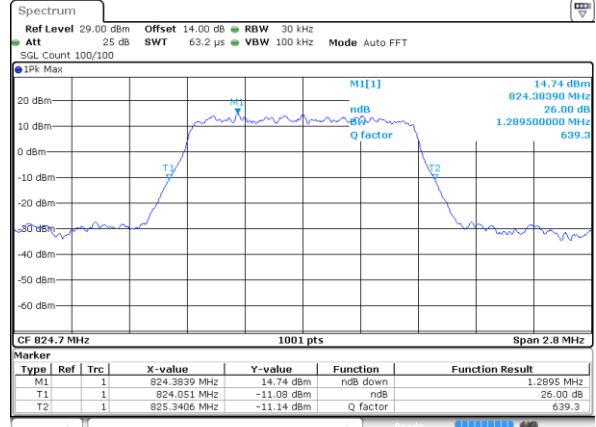

Date: 6 AUG 2021 19:41:35

Middle Channel / 1.4MHz / QPSK

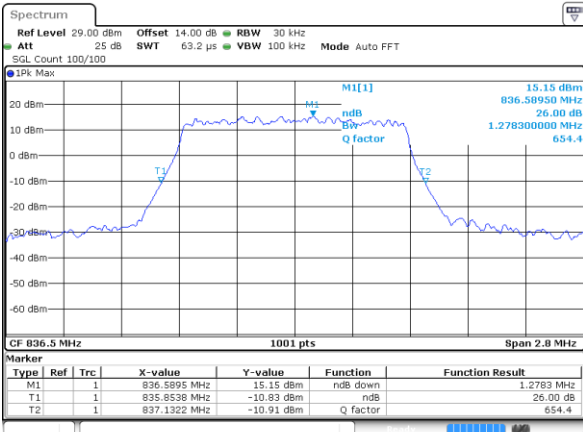

Date: 6 AUG 2021 19:52:13

Middle Channel / 1.4MHz / 16QAM

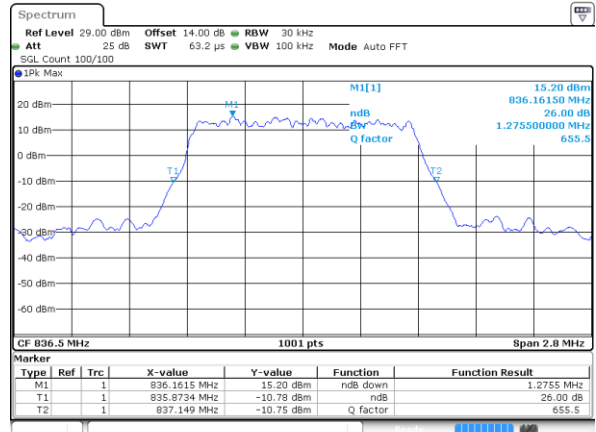

Date: 6 AUG 2021 19:52:24

Highest Channel / 1.4MHz / QPSK

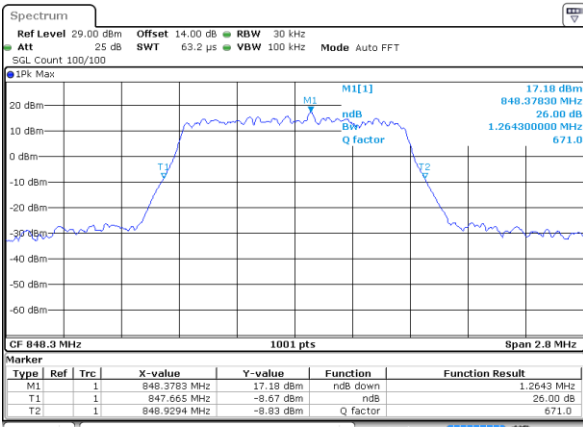

Date: 6 AUG 2021 19:56:15

Highest Channel / 1.4MHz / 16QAM

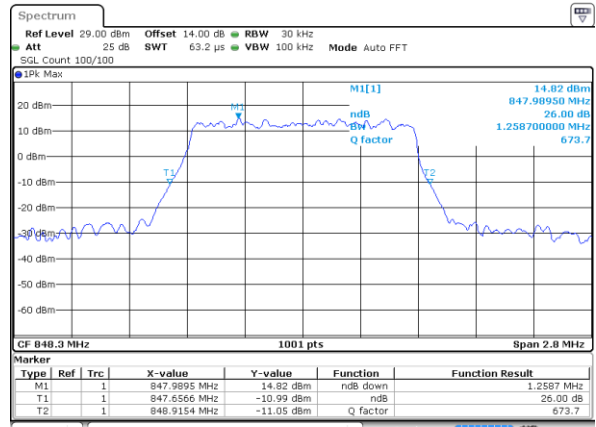

Date: 6 AUG 2021 19:56:27



LTE Band 5

Lowest Channel / 3MHz / QPSK

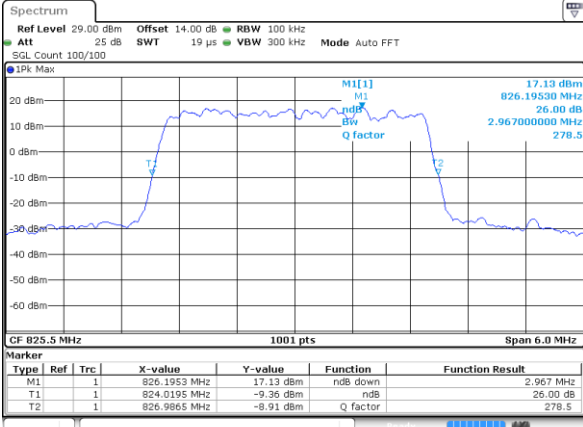

Date: 6 AUG 2021 20:19:33

Lowest Channel / 3MHz / 16QAM

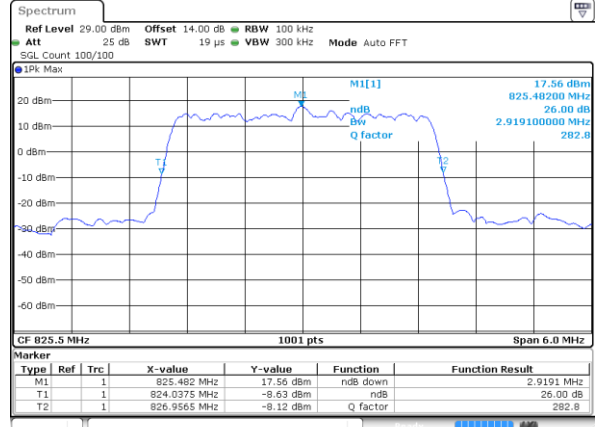

Date: 6 AUG 2021 20:19:44

Middle Channel / 3MHz / QPSK

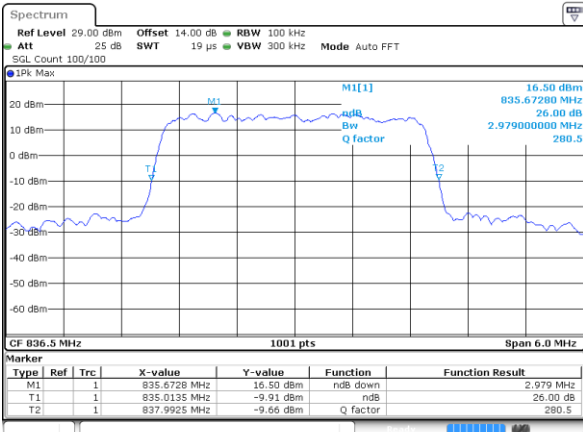

Date: 6 AUG 2021 20:30:11

Middle Channel / 3MHz / 16QAM

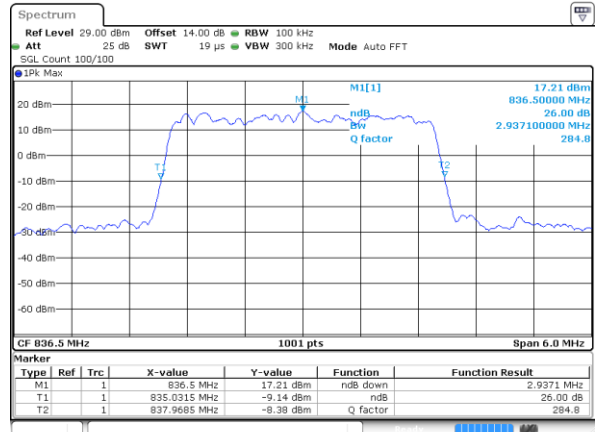

Date: 6 AUG 2021 20:30:22

Highest Channel / 3MHz / QPSK

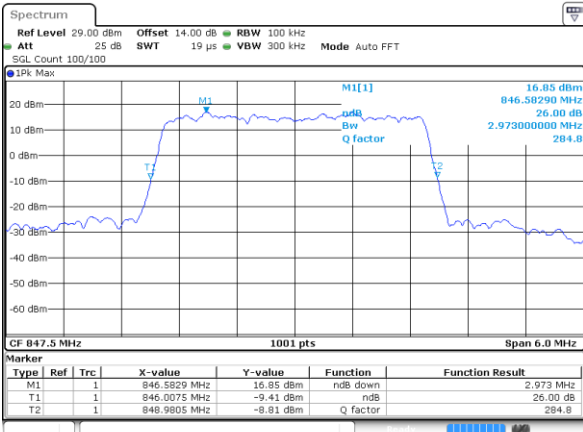

Date: 6 AUG 2021 20:34:13

Highest Channel / 3MHz / 16QAM

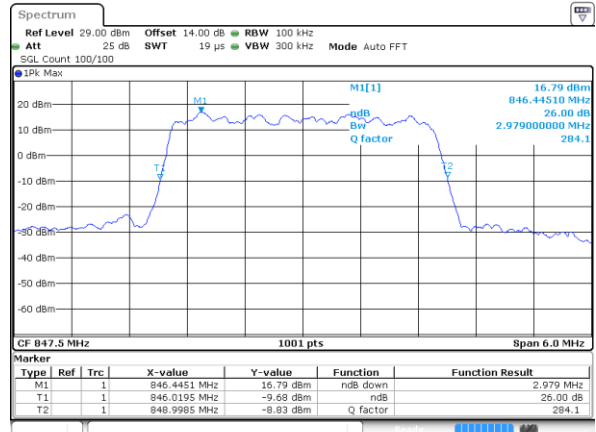

Date: 6 AUG 2021 20:34:24



LTE Band 5

Lowest Channel / 5MHz / QPSK

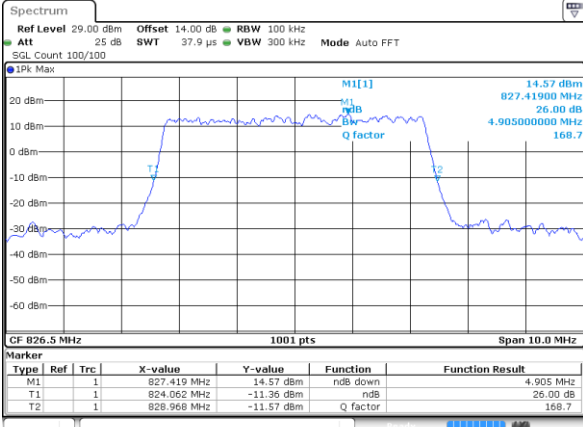

Date: 6 AUG 2021 20:57:30

Lowest Channel / 5MHz / 16QAM

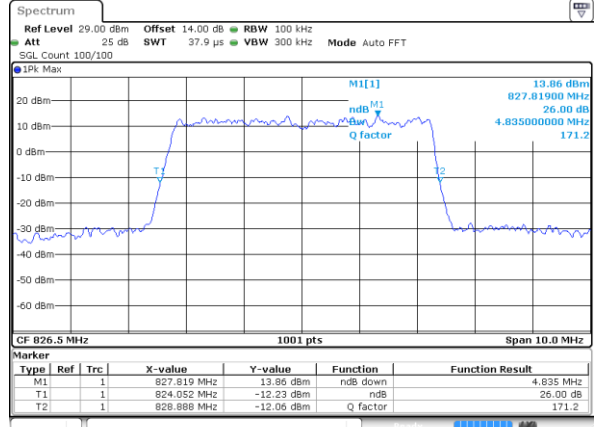

Date: 6 AUG 2021 20:57:41

Middle Channel / 5MHz / QPSK

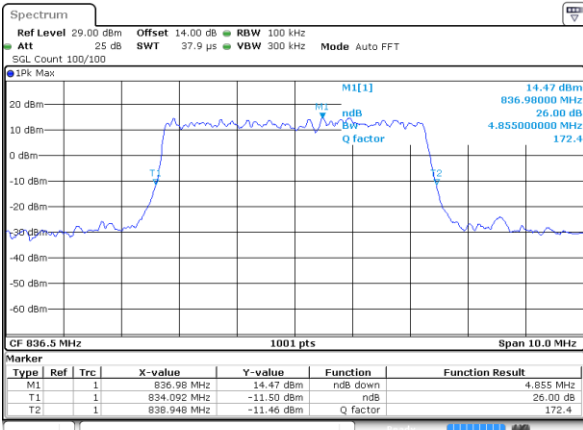

Date: 6 AUG 2021 21:08:08

Middle Channel / 5MHz / 16QAM

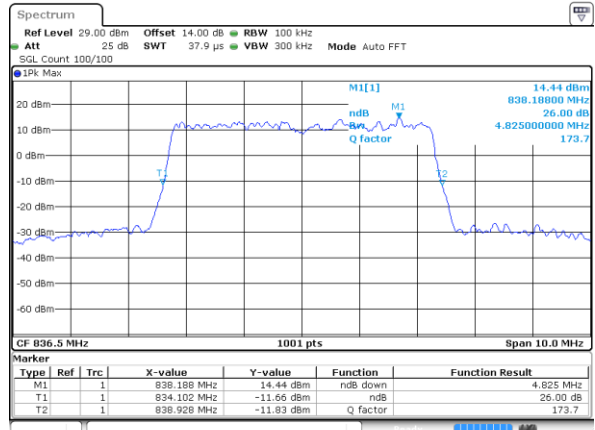

Date: 6 AUG 2021 21:08:19

Highest Channel / 5MHz / QPSK

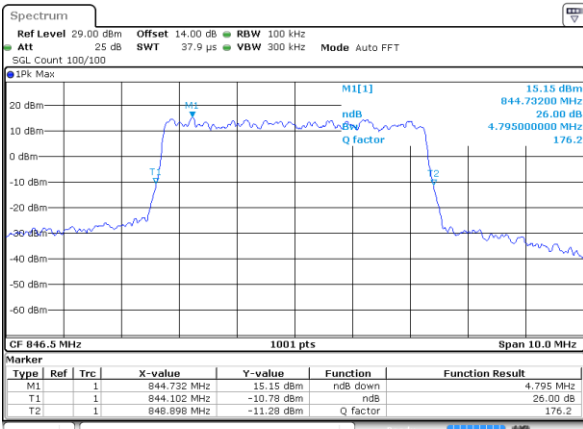

Date: 6 AUG 2021 21:12:10

Highest Channel / 5MHz / 16QAM

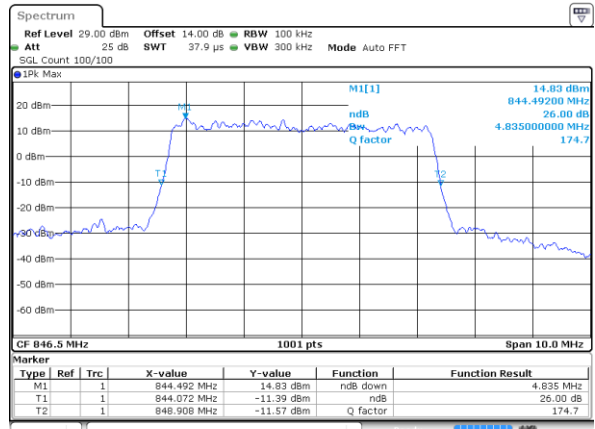

Date: 6 AUG 2021 21:12:21



LTE Band 5

Lowest Channel / 10MHz / QPSK

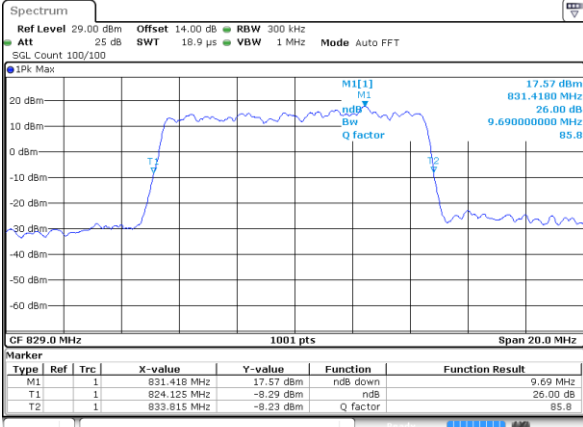

Date: 6 AUG 2021 21:33:47

Lowest Channel / 10MHz / 16QAM

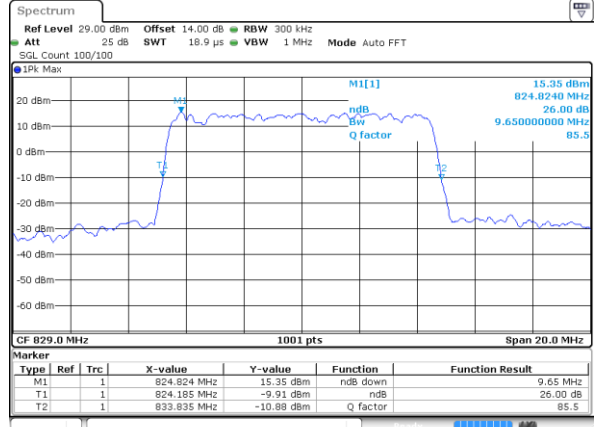

Date: 6 AUG 2021 21:33:58

Middle Channel / 10MHz / QPSK

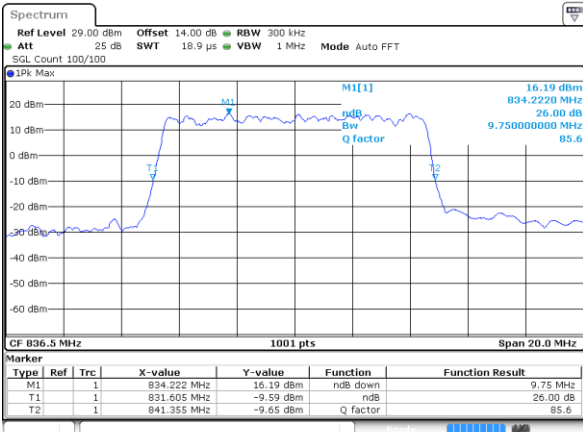

Date: 6 AUG 2021 21:44:25

Middle Channel / 10MHz / 16QAM

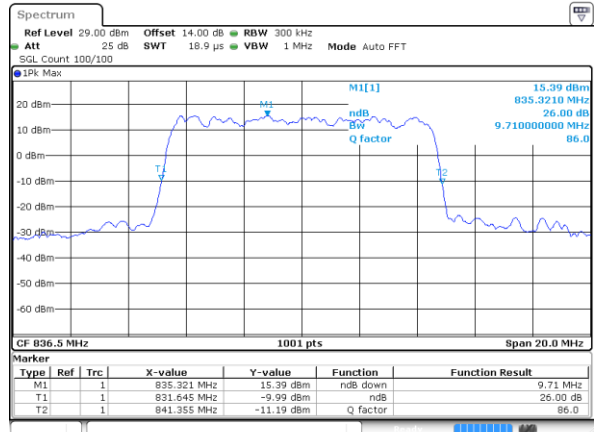

Date: 6 AUG 2021 21:44:35

Highest Channel / 10MHz / QPSK

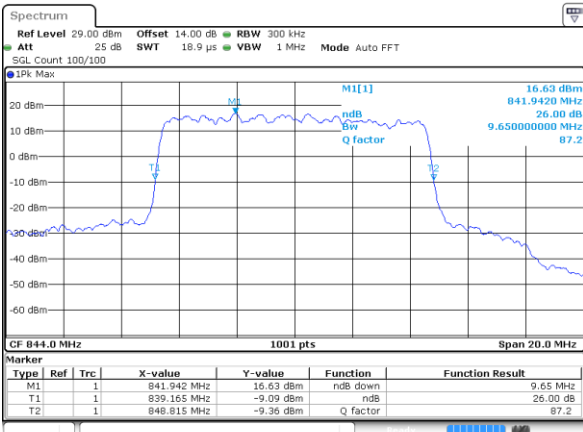

Date: 6 AUG 2021 21:48:27

Highest Channel / 10MHz / 16QAM

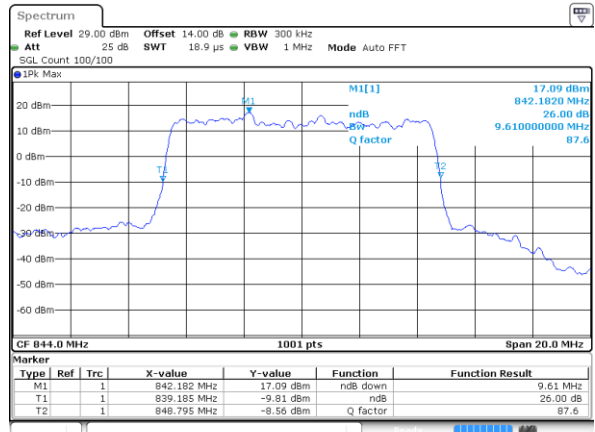

Date: 6 AUG 2021 21:48:37



LTE Band 5

Lowest Channel / 1.4MHz / 64QAM

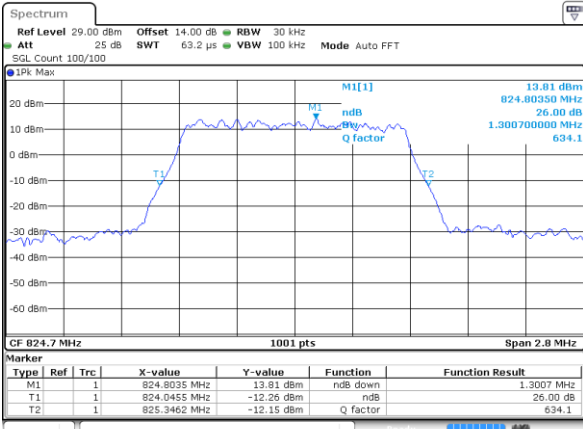

Date: 6 AUG 2021 20:06:43

Lowest Channel / 3MHz / 64QAM

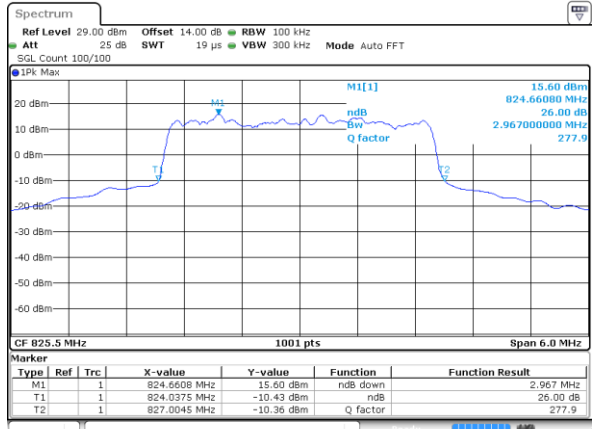

Date: 6 AUG 2021 20:44:40

Middle Channel / 1.4MHz / 64QAM

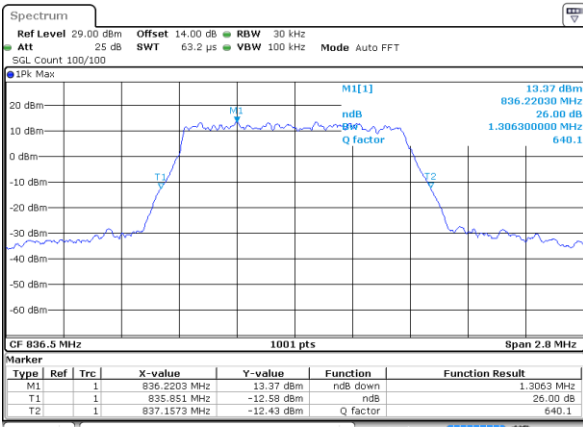

Date: 6 AUG 2021 20:12:01

Middle Channel / 3MHz / 64QAM

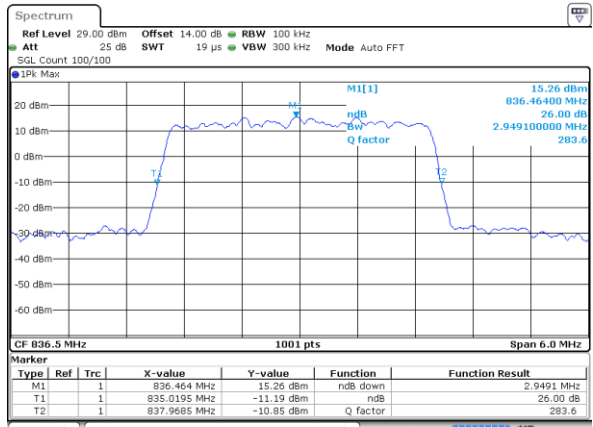

Date: 6 AUG 2021 20:49:59

Highest Channel / 1.4MHz / 64QAM

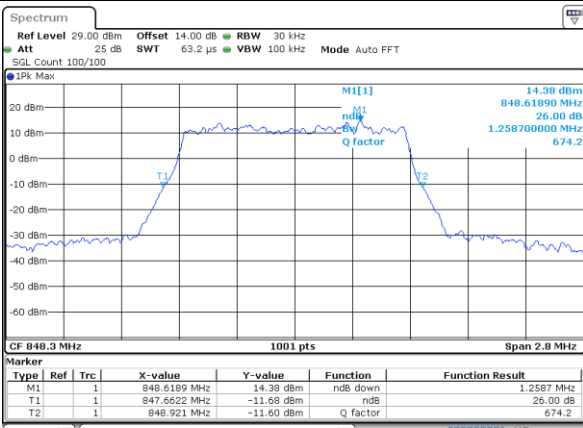

Date: 6 AUG 2021 20:14:03

Highest Channel / 3MHz / 64QAM

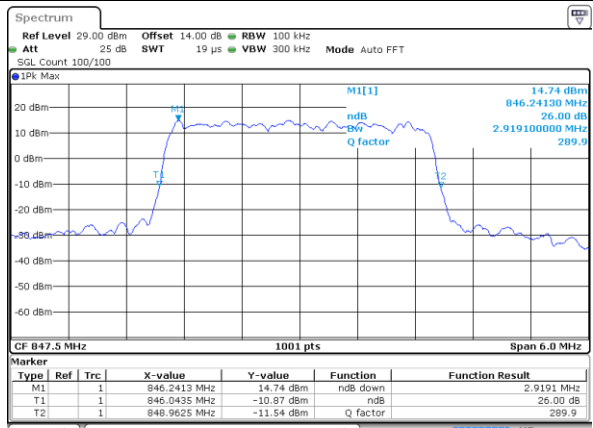

Date: 6 AUG 2021 20:52:00



LTE Band 5

Lowest Channel / 5MHz / 64QAM

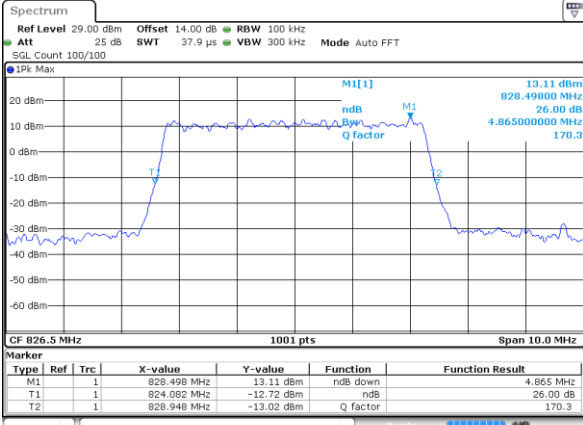

Date: 6 AUG 2021 21:22:36

Lowest Channel / 10MHz / 64QAM

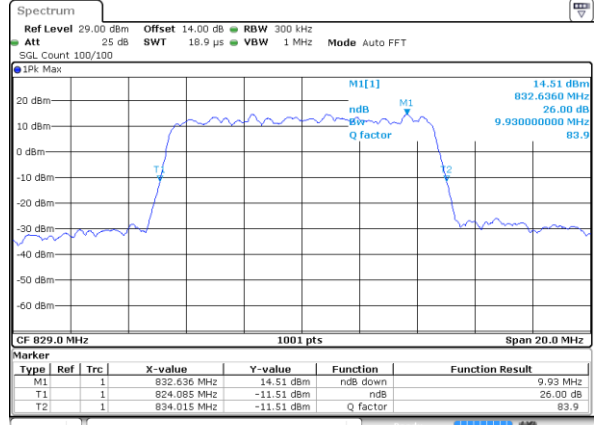

Date: 6 AUG 2021 22:00:33

Middle Channel / 5MHz / 64QAM

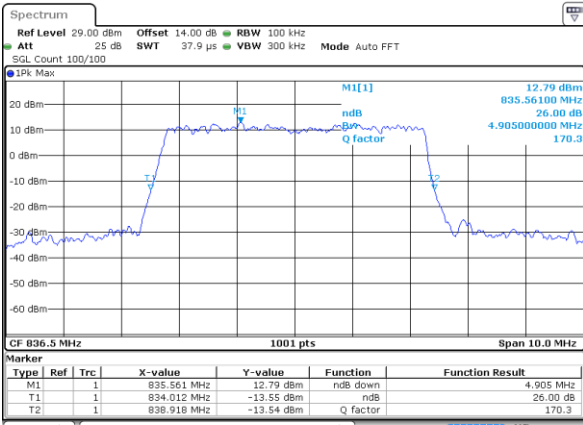

Date: 6 AUG 2021 21:27:55

Middle Channel / 10MHz / 64QAM

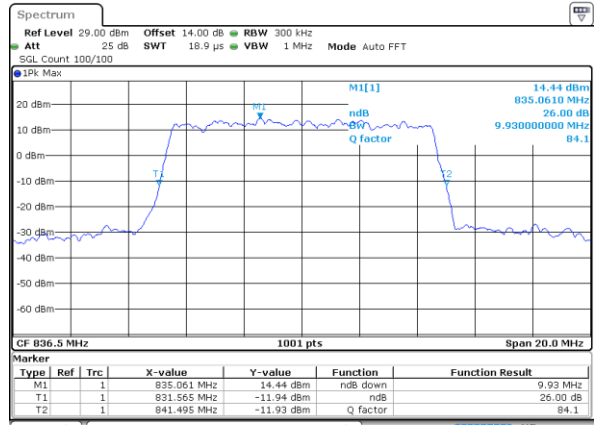

Date: 6 AUG 2021 22:05:51

Highest Channel / 5MHz / 64QAM

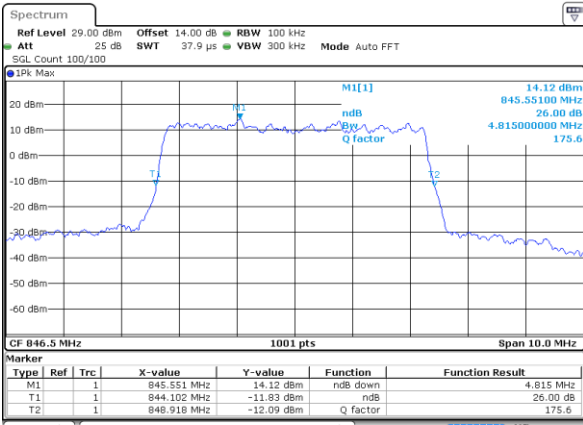

Date: 6 AUG 2021 21:29:56

Highest Channel / 10MHz / 64QAM

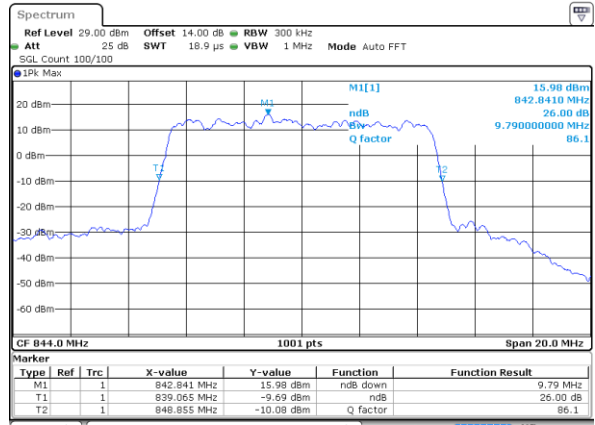

Date: 6 AUG 2021 22:07:52



Occupied Bandwidth

Mode	LTE Band 5 : 99%OBW(MHz)											
BW	1.4MHz		3MHz		5MHz		10MHz		15MHz		20MHz	
Mod.	QPSK	16QAM	QPSK	16QAM	QPSK	16QAM	QPSK	16QAM	QPSK	16QAM	QPSK	16QAM
Lowest CH	1.09	1.10	2.71	2.71	4.49	4.49	9.07	9.05	-	-	-	-
Middle CH	1.08	1.10	2.72	2.72	4.47	4.48	9.03	9.01	-	-	-	-
Highest CH	1.09	1.09	2.70	2.72	4.50	4.49	8.99	8.95	-	-	-	-
Mode	LTE Band 5 : 99%OBW(MHz)											
BW	1.4MHz		3MHz		5MHz		10MHz		15MHz		20MHz	
Mod.	64QAM		64QAM		64QAM		64QAM		64QAM		64QAM	
Lowest CH	1.09	-	2.70	-	4.52	-	9.03	-	-	-	-	-
Middle CH	1.10	-	2.72	-	4.48	-	9.01	-	-	-	-	-
Highest CH	1.09	-	2.72	-	4.49	-	9.03	-	-	-	-	-



LTE Band 5

Lowest Channel / 1.4MHz / QPSK

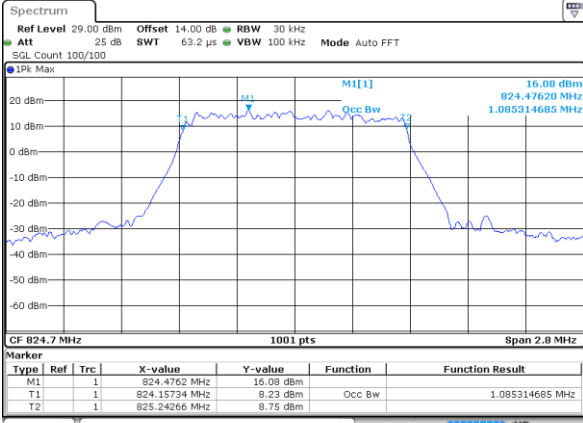

Date: 6 AUG 2021 19:41:13

Lowest Channel / 1.4MHz / 16QAM

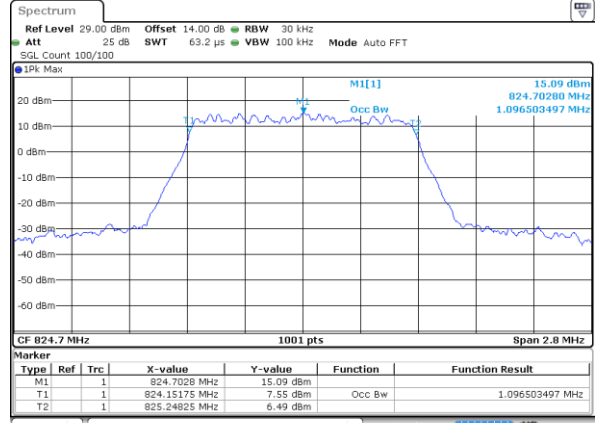

Date: 6 AUG 2021 19:41:24

Middle Channel / 1.4MHz / QPSK

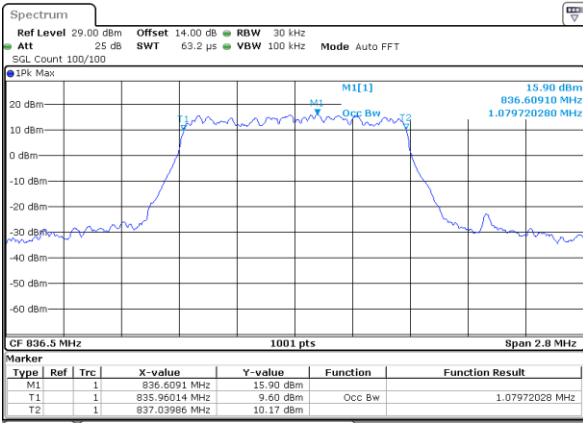

Date: 6 AUG 2021 19:51:51

Middle Channel / 1.4MHz / 16QAM

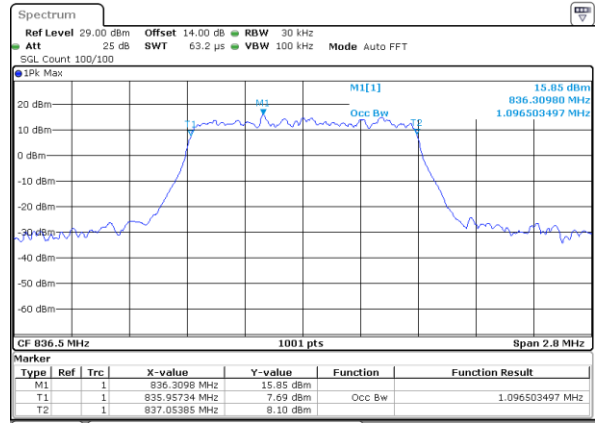

Date: 6 AUG 2021 19:52:02

Highest Channel / 1.4MHz / QPSK

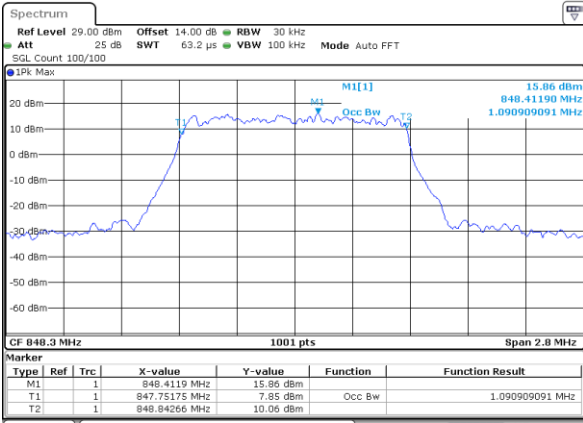

Date: 6 AUG 2021 19:55:54

Highest Channel / 1.4MHz / 16QAM

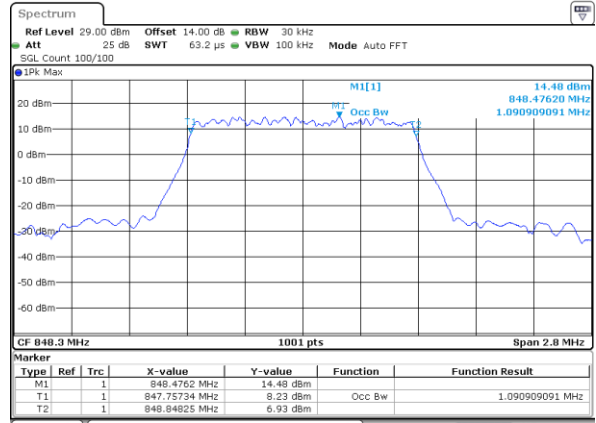

Date: 6 AUG 2021 19:56:05



LTE Band 5

Lowest Channel / 3MHz / QPSK

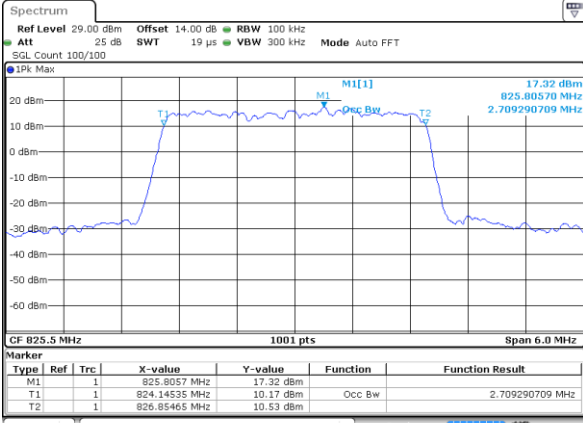

Date: 6 AUG 2021 20:19:11

Lowest Channel / 3MHz / 16QAM

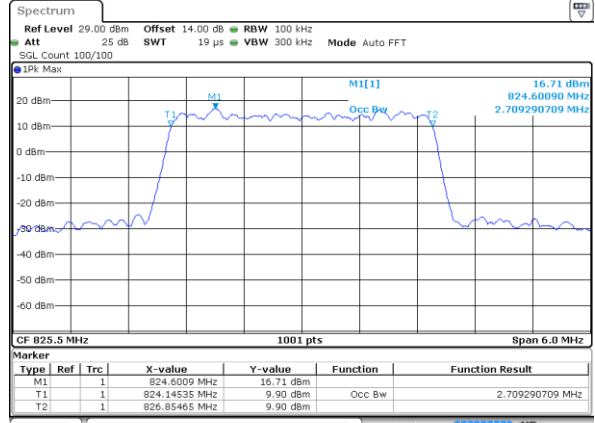

Date: 6 AUG 2021 20:19:22

Middle Channel / 3MHz / QPSK

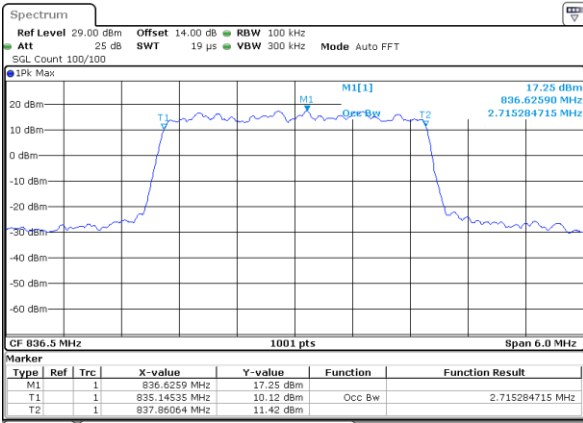

Date: 6 AUG 2021 20:29:49

Middle Channel / 3MHz / 16QAM

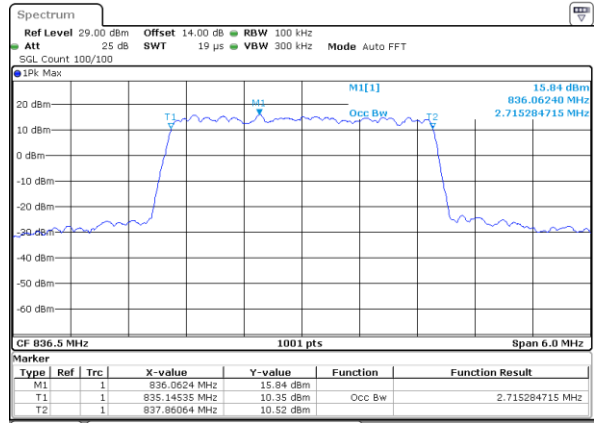

Date: 6 AUG 2021 20:30:00

Highest Channel / 3MHz / QPSK

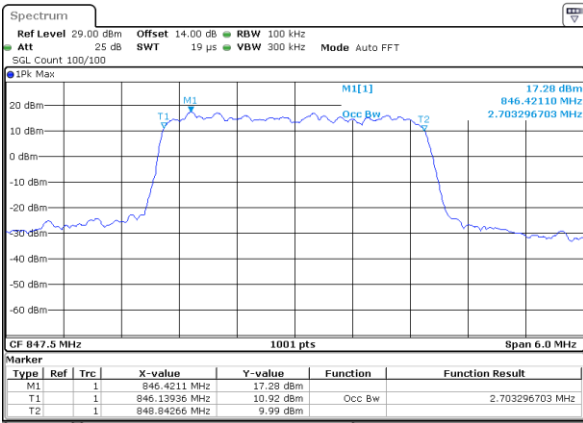

Date: 6 AUG 2021 20:33:51

Highest Channel / 3MHz / 16QAM

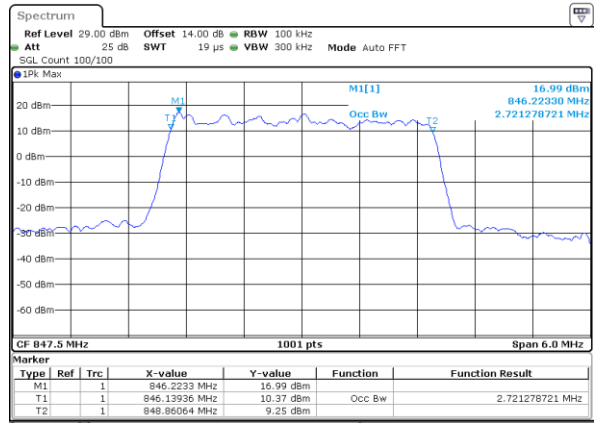

Date: 6 AUG 2021 20:34:02



LTE Band 5

Lowest Channel / 5MHz / QPSK

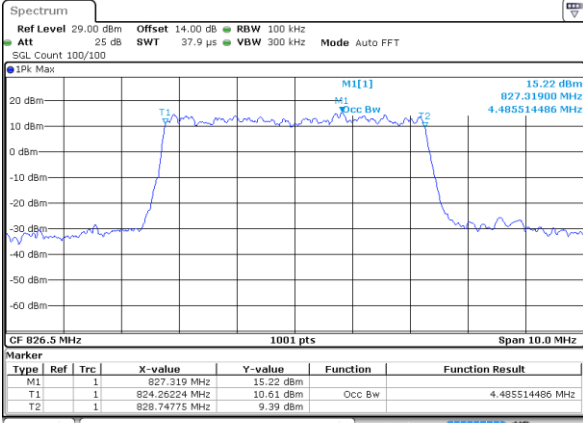

Date: 6 AUG 2021 20:57:08

Lowest Channel / 5MHz / 16QAM

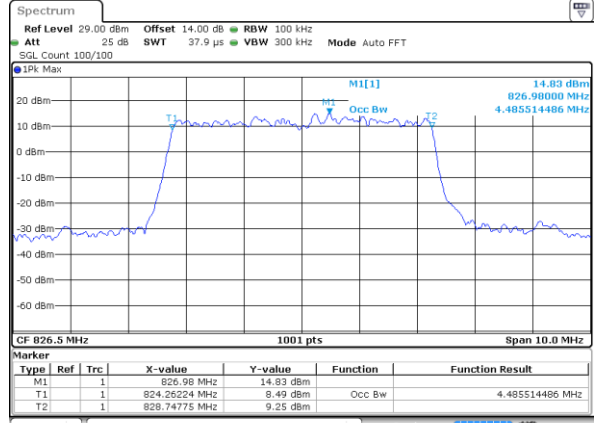

Date: 6 AUG 2021 20:57:19

Middle Channel / 5MHz / QPSK

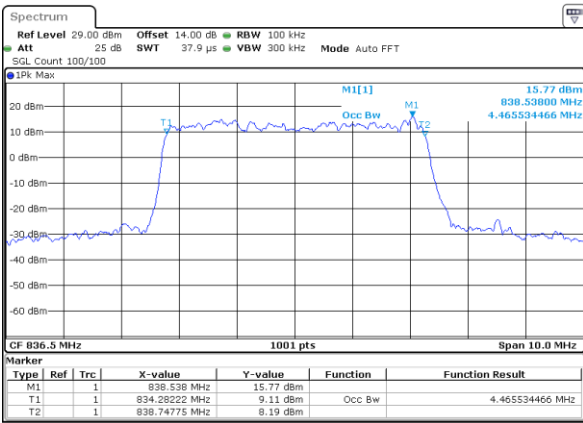

Date: 6 AUG 2021 21:07:46

Middle Channel / 5MHz / 16QAM

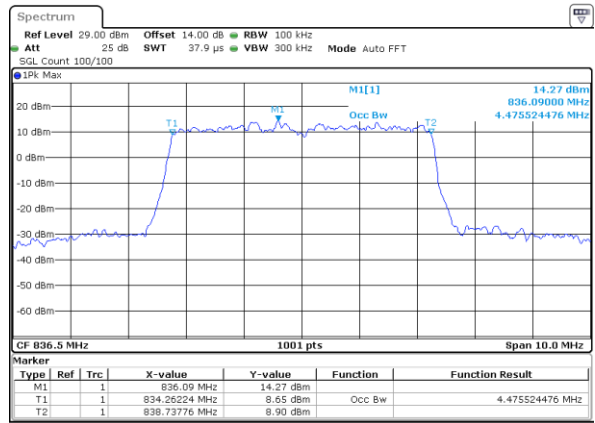

Date: 6 AUG 2021 21:07:57

Highest Channel / 5MHz / QPSK

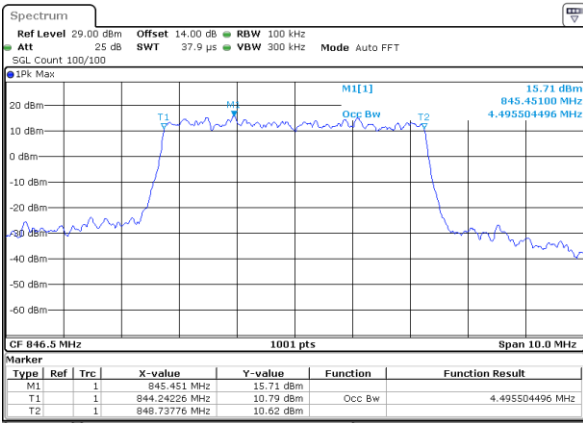

Date: 6 AUG 2021 21:11:48

Highest Channel / 5MHz / 16QAM

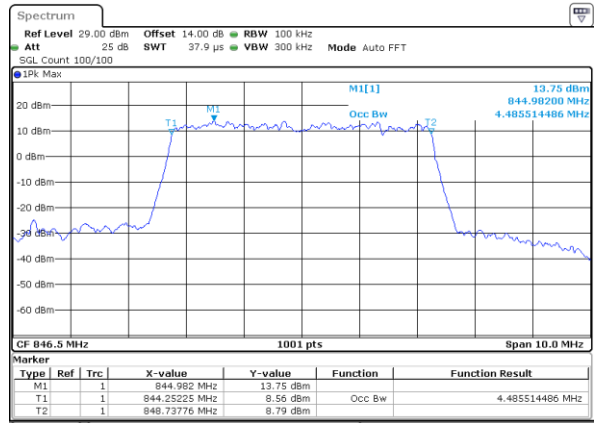

Date: 6 AUG 2021 21:11:59



LTE Band 5

Lowest Channel / 10MHz / QPSK

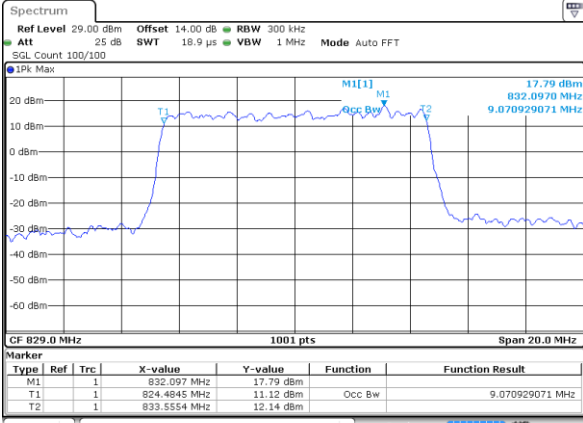

Date: 6 AUG 2021 21:33:25

Lowest Channel / 10MHz / 16QAM

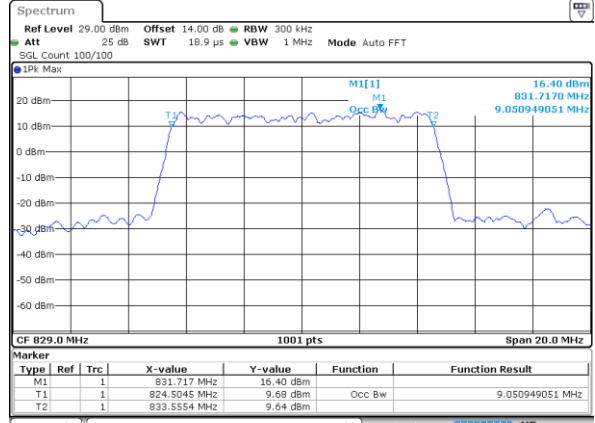

Date: 6 AUG 2021 21:33:36

Middle Channel / 10MHz / QPSK

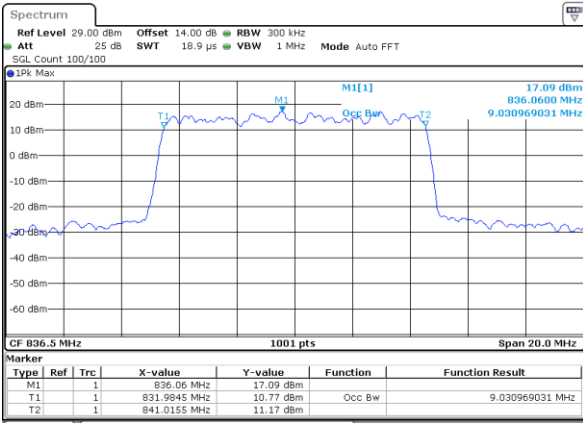

Date: 6 AUG 2021 21:44:03

Middle Channel / 10MHz / 16QAM

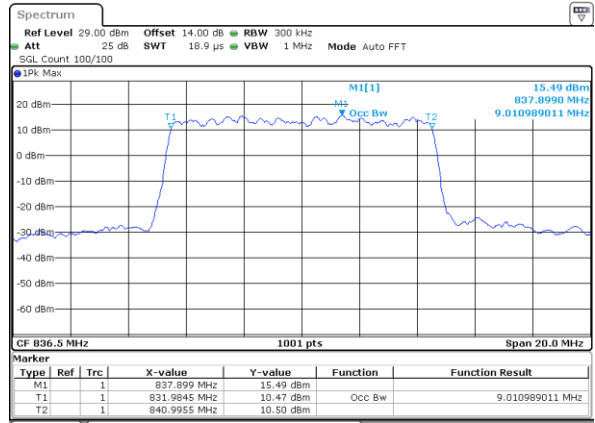

Date: 6 AUG 2021 21:44:14

Highest Channel / 10MHz / QPSK

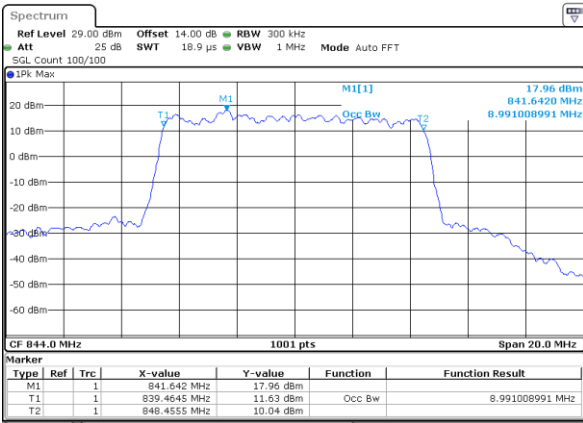

Date: 6 AUG 2021 21:48:05

Highest Channel / 10MHz / 16QAM

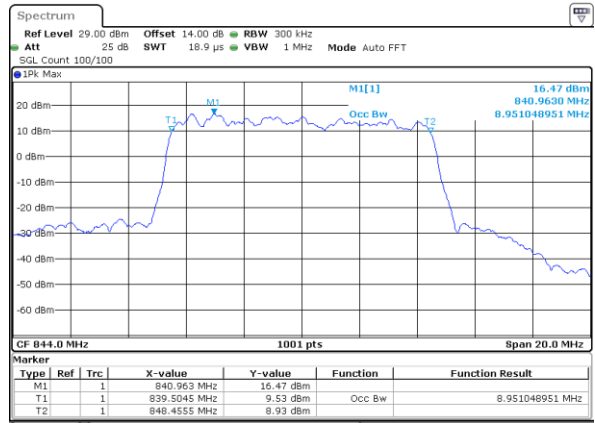

Date: 6 AUG 2021 21:48:16



LTE Band 5

Lowest Channel / 1.4MHz / 64QAM

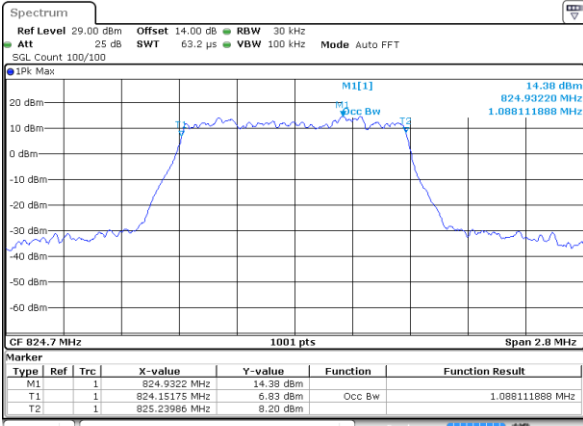

Lowest Channel / 3MHz / 64QAM

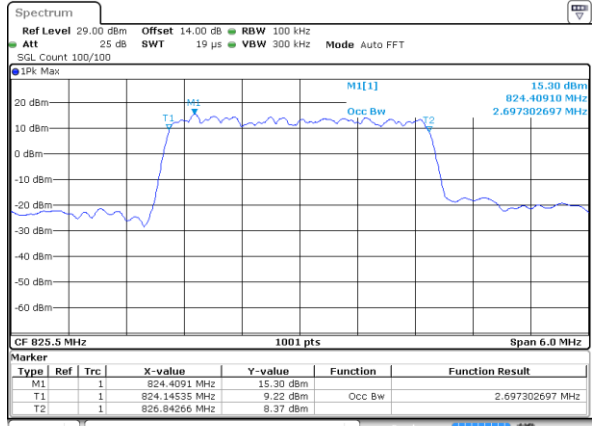

Middle Channel / 1.4MHz / 64QAM

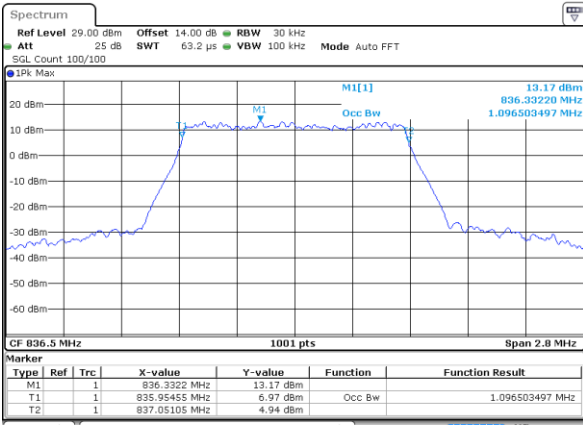

Middle Channel / 3MHz / 64QAM

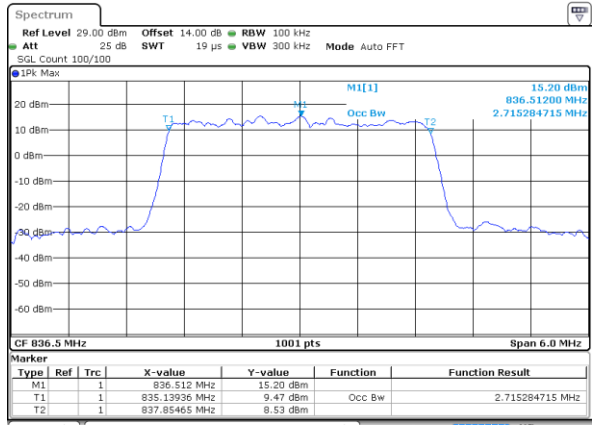

Highest Channel / 1.4MHz / 64QAM

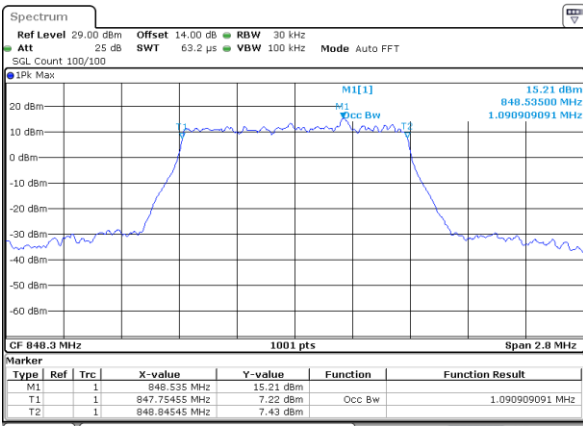

Highest Channel / 3MHz / 64QAM

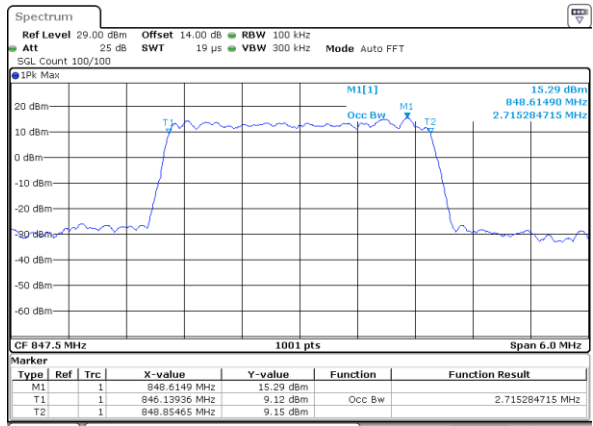



LTE Band 5

Lowest Channel / 5MHz / 64QAM

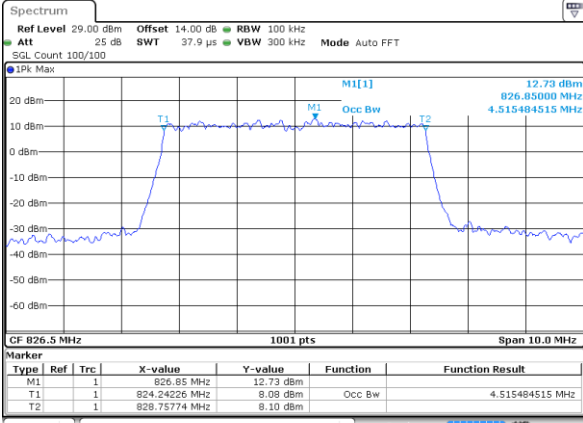

Date: 6 AUG 2021 21:22:25

Lowest Channel / 10MHz / 64QAM

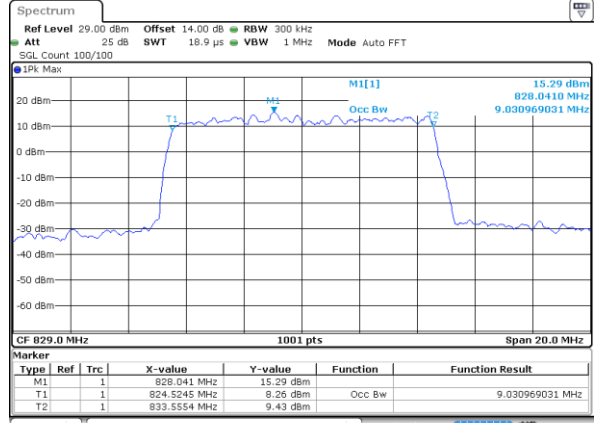

Date: 6 AUG 2021 22:00:22

Middle Channel / 5MHz / 64QAM

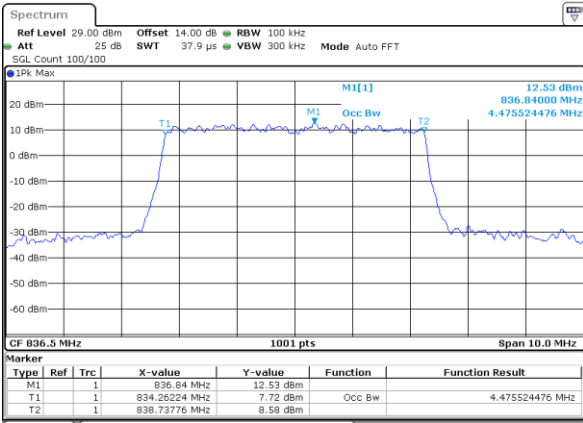

Date: 6 AUG 2021 21:27:44

Middle Channel / 10MHz / 64QAM

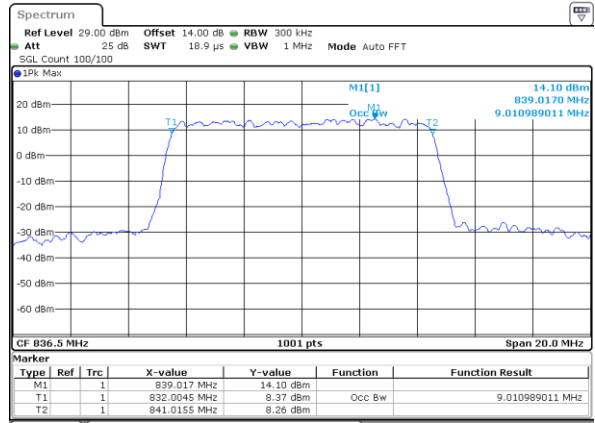

Date: 6 AUG 2021 22:05:41

Highest Channel / 5MHz / 64QAM

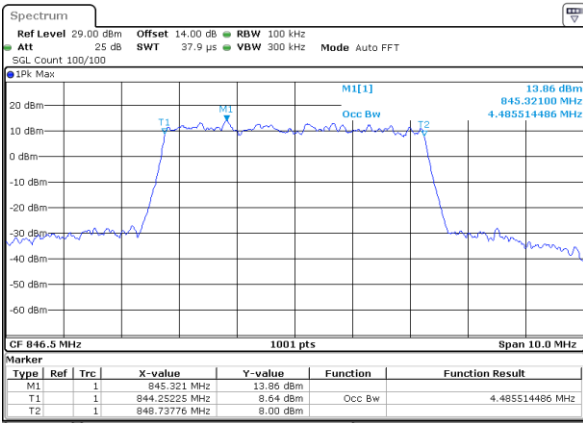

Date: 6 AUG 2021 21:29:46

Highest Channel / 10MHz / 64QAM

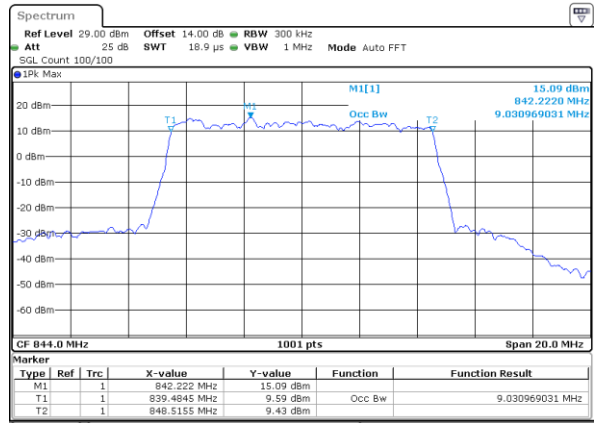

Date: 6 AUG 2021 22:07:42



Conducted Band Edge

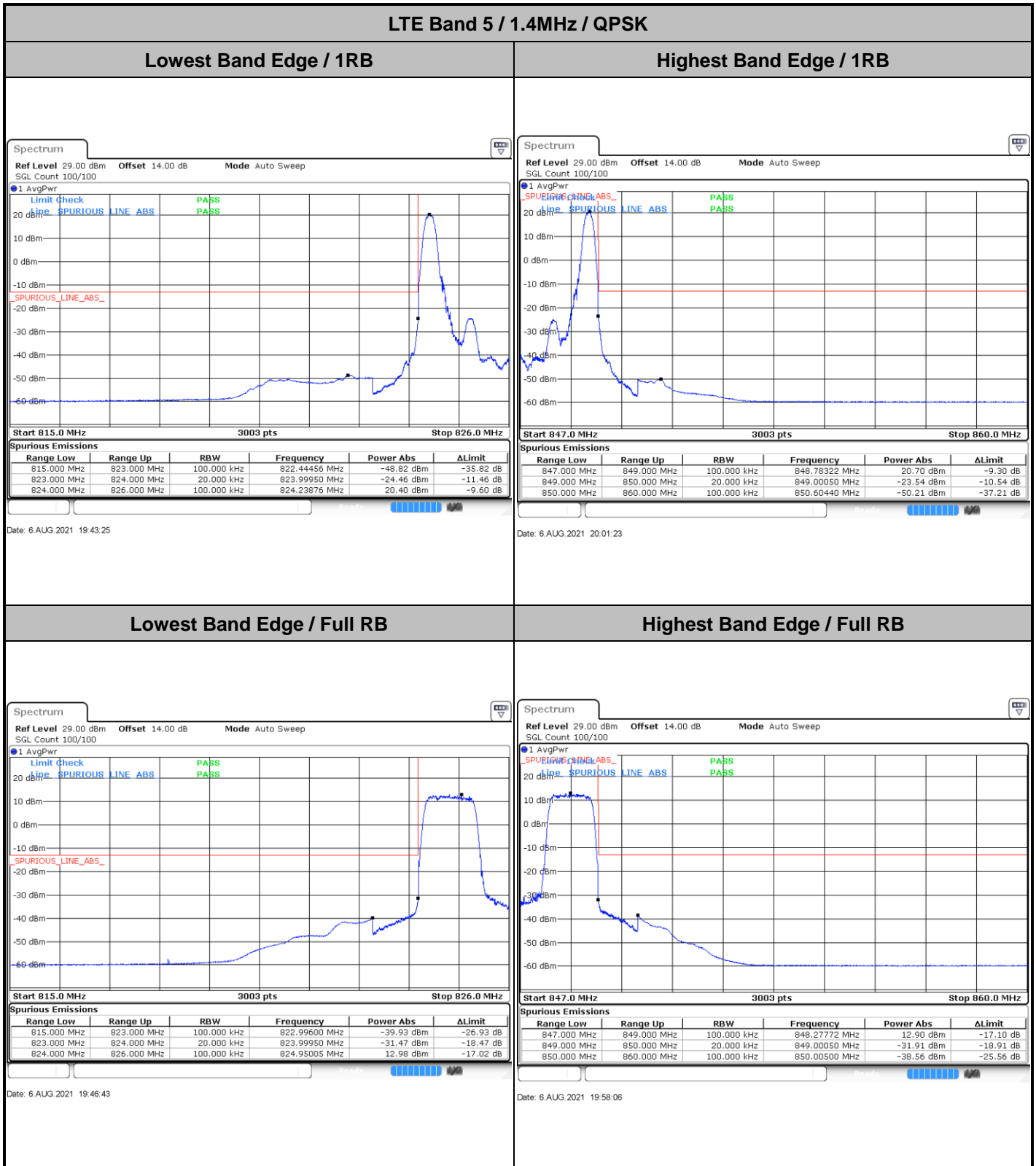



LTE Band 5 / 1.4MHz / 16QAM

Lowest Band Edge / 1 RB

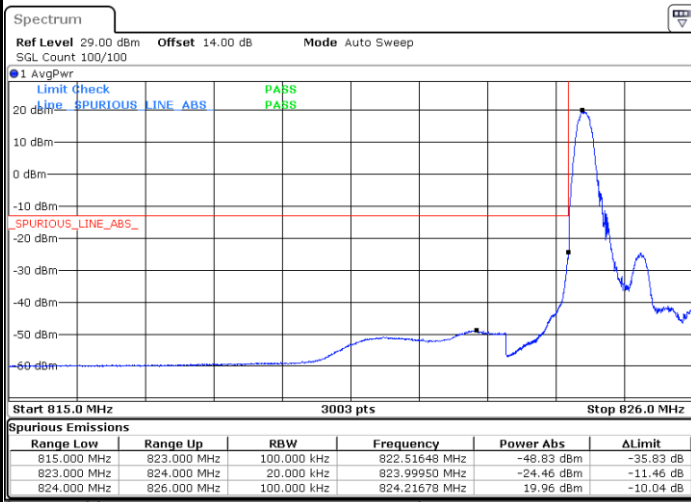

Date: 6 AUG.2021 19:45:04

Highest Band Edge / 1 RB

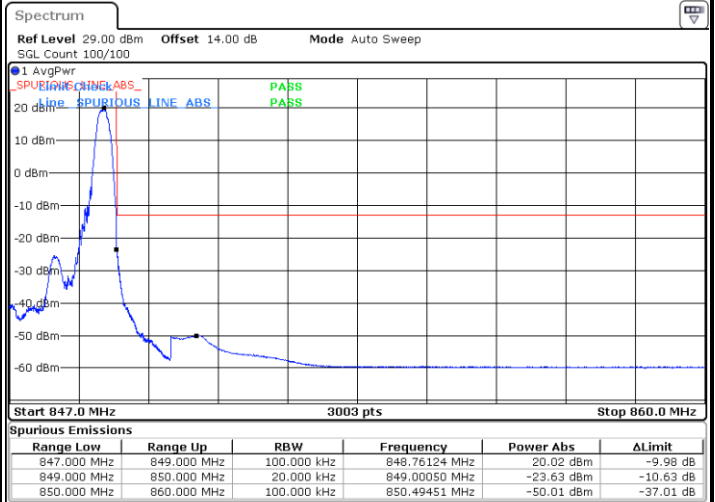

Date: 6 AUG.2021 20:03:02

Lowest Band Edge / Full RB

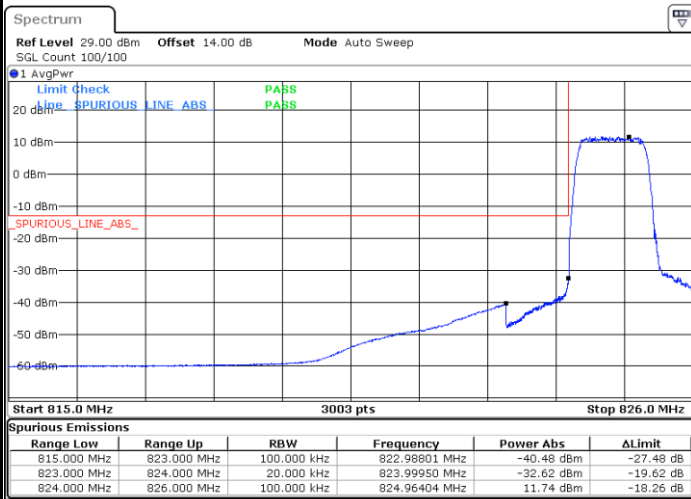

Date: 6 AUG.2021 19:48:22

Highest Band Edge / Full RB

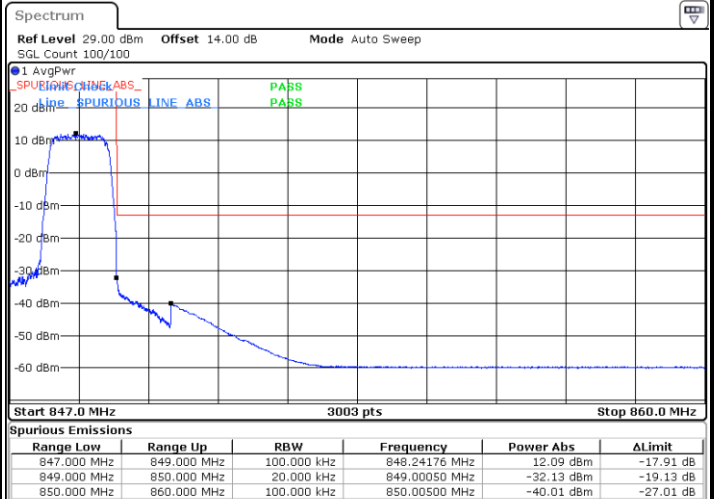

Date: 6 AUG.2021 19:59:44



LTE Band 5 / 1.4MHz / 64QAM

Lowest Band Edge / 1 RB

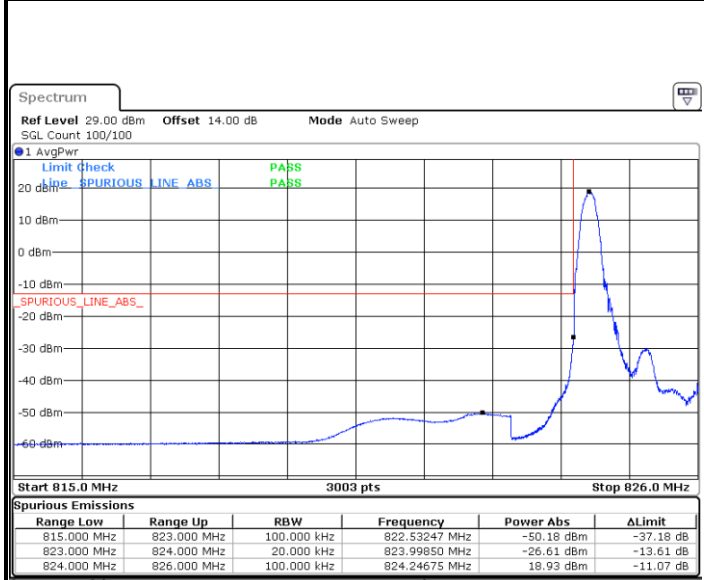

Date: 6 AUG.2021 20:08:21

Highest Band Edge / 1 RB

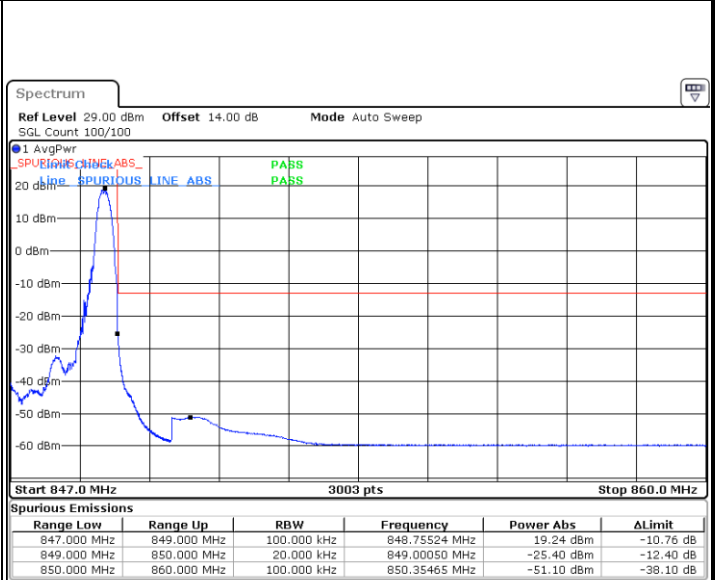

Date: 6 AUG.2021 20:17:21

Lowest Band Edge / Full RB

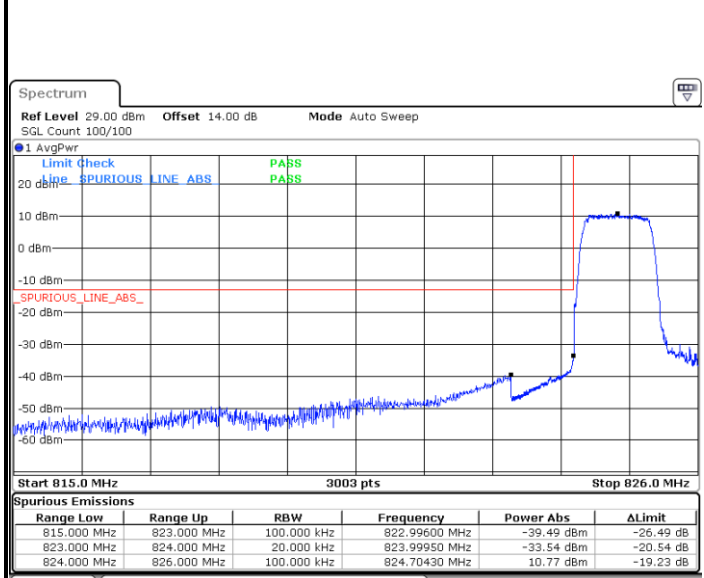

Date: 6 AUG.2021 20:10:00

Highest Band Edge / Full RB

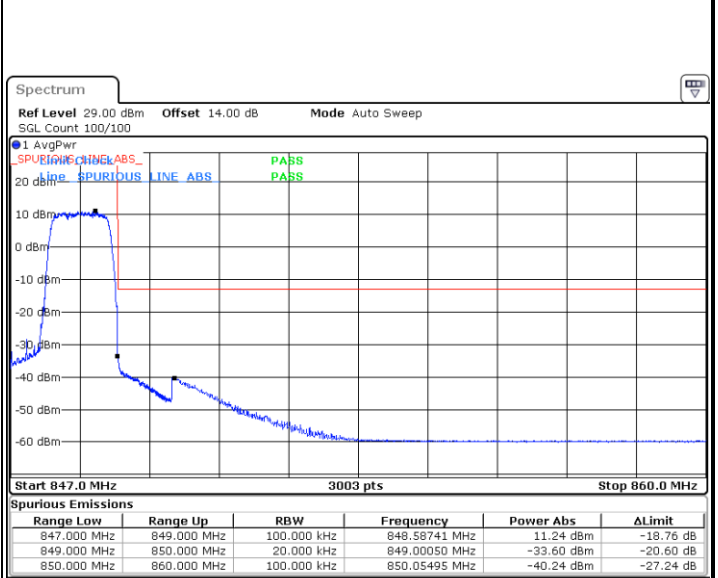

Date: 6 AUG.2021 20:15:42



LTE Band 5 / 3MHz / QPSK

Lowest Band Edge / 1RB

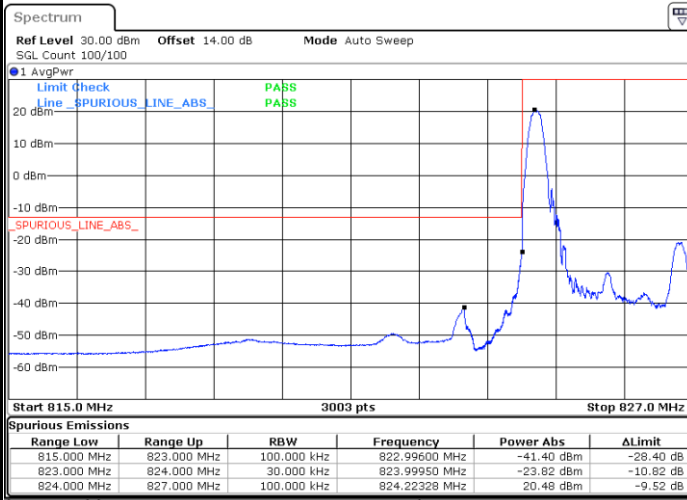

Date: 6 AUG 2021 20:21:23

Highest Band Edge / 1 RB



Date: 6 AUG 2021 20:36:03

Lowest Band Edge / Full RB

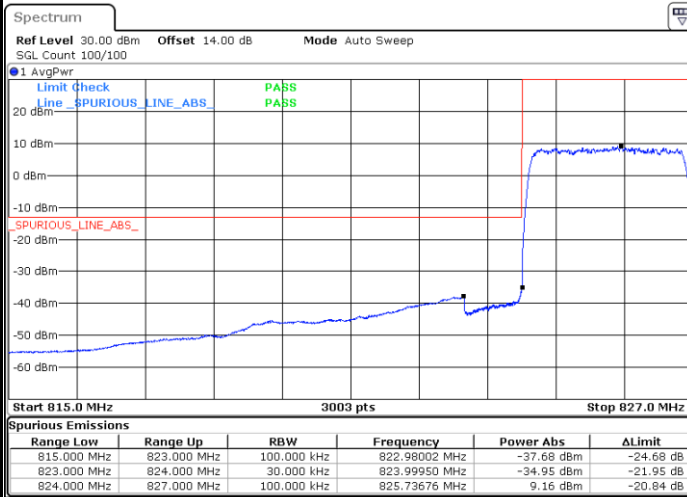

Date: 6 AUG 2021 20:24:41

Highest Band Edge / Full RB



Date: 6 AUG 2021 20:39:21