



FCC RF Test Report

APPLICANT : Motorola Mobility LLC
EQUIPMENT : Mobile Cellular Phone
BRAND NAME : Motorola
MODEL NAME : XT2137-1
FCC ID : IHDT56ZT1
STANDARD : 47 CFR Part 2, 27(M)
CLASSIFICATION : PCS Licensed Transmitter Held to Ear (PCE)

The product was received on Jan. 21, 2021 and completely tested on Feb. 19, 2021. We, Sporton International (Kunshan) Inc., would like to declare that the tested sample has been evaluated in accordance with the procedures given in ANSI C63.26-2015 and shown compliance with the applicable technical standards.

The test results in this report apply exclusively to the tested model / sample. Without written approval of Sporton International (Kunshan) Inc., the test report shall not be reproduced except in full.

Jason Jia

Reviewed by: Jason Jia / Supervisor

James Huang

Approved by: James Huang / Manager



Sporton International (Kunshan) Inc.

No. 1098, Pengxi North Road, Kunshan Economic Development Zone Jiangsu Province 215300
People's Republic of China



TABLE OF CONTENTS

REVISION HISTORY... 3
SUMMARY OF TEST RESULT ... 4
1 GENERAL DESCRIPTION ... 5
1.1 Applicant ... 5
1.2 Manufacturer ... 5
1.3 Product Feature of Equipment Under Test ... 5
1.4 Product Specification of Equipment Under Test ... 6
1.5 Modification of EUT ... 6
1.6 Maximum EIRP Power, Frequency Tolerance, and Emission Designator ... 7
1.7 Testing Location ... 8
1.8 Test Software ... 8
1.9 Applicable Standards ... 8
1.10 Specification of Accessory ... 9
2 TEST CONFIGURATION OF EQUIPMENT UNDER TEST ... 10
2.1 Test Mode ... 10
2.2 Connection Diagram of Test System ... 12
2.3 Support Unit used in test configuration and system ... 12
2.4 Measurement Results Explanation Example ... 12
2.5 Frequency List of Low/Middle/High Channels ... 13
3 CONDUCTED TEST ITEMS ... 15
3.1 Measuring Instruments ... 15
3.2 Test Setup ... 15
3.3 Test Result of Conducted Test ... 15
3.4 Conducted Output Power and EIRP ... 16
3.5 Peak-to-Average Ratio ... 17
3.6 Occupied Bandwidth ... 18
3.7 Conducted Band Edge ... 19
3.8 Conducted Spurious Emission ... 20
3.9 Frequency Stability ... 21
4 RADIATED TEST ITEMS ... 22
4.1 Measuring Instruments ... 22
4.2 Test Setup ... 22
4.3 Test Result of Radiated Test ... 22
4.4 Radiated Spurious Emission ... 23
5 LIST OF MEASURING EQUIPMENT ... 24
6 UNCERTAINTY OF EVALUATION ... 25
APPENDIX A. TEST RESULTS OF CONDUCTED TEST
APPENDIX B. TEST RESULTS OF RADIATED TEST
APPENDIX C. TEST SETUP PHOTOGRAPHS



REVISION HISTORY

REPORT NO.	VERSION	DESCRIPTION	ISSUED DATE
FG112101C	Rev. 01	Initial issue of report	Feb. 26, 2021



SUMMARY OF TEST RESULT

Report Section	FCC Rule	Description	Limit	Result	Remark
3.4	§2.1046	Conducted Output Power	Reporting Only	PASS	-
	§24.232(c) §27.50(h)(2)	Equivalent Isotropic Radiated Power (Band 7) (Band 38) (Band 41)	EIRP < 2Watt	PASS	-
3.5	N/A	Peak-to-Average Ratio	<13 dB	PASS	-
3.6	§2.1049	Occupied Bandwidth	Reporting Only	PASS	-
3.7	§27.53(m)(4)	Conducted Band Edge Measurement (Band 7) (Band 38) (Band 41)	§27.53(m)(4)	PASS	-
3.8	§2.1051 §27.53(m)(4)	Conducted Spurious Emission (Band 7) (Band 38) (Band 41)	< 55+10log ₁₀ (P[Watts])	PASS	-
3.9	§2.1055 §27.54	Frequency Stability Temperature & Voltage	Within Authorized Band	PASS	-
4.4	§2.1053 §27.53(m)(4)	Radiated Spurious Emission (Band 7) (Band 38) (Band 41)	< 55+10log ₁₀ (P[Watts])	PASS	Under limit 29.79 dB at 5172.000 MHz

Declaration of Conformity:
The test results with all measurement uncertainty excluded are presented in accordance with the regulation limits or requirements declared by manufacturers.

Comments and Explanations:
The declared of product specification for EUT presented in the report are provided by the manufacturer, and the manufacturer takes all the responsibilities for the accuracy of product specification.



1 General Description

1.1 Applicant

Motorola Mobility LLC
222 W,Merchandise Mart Plaza, Chicago IL 60654 USA

1.2 Manufacturer

Motorola Mobility LLC
222 W,Merchandise Mart Plaza, Chicago IL 60654 USA

1.3 Product Feature of Equipment Under Test

Product Feature	
Equipment	Mobile Cellular Phone
Brand Name	Motorola
Model Name	XT2137-1
FCC ID	IHDT56ZT1
EUT supports Radios application	GSM/WCDMA/LTE/5G NR WLAN 2.4GHz 802.11b/g/n HT20 WLAN 5GHz 802.11a/n HT20/HT40 WLAN 5GHz 802.11ac VHT20/VHT40/VHT80 Bluetooth BR/EDR/LE FM Receiver / GNSS / NFC
IMEI Code	Conducted: 352355710026099/352355710026107 Radiation: 352355710024631/352355710024649
HW Version	DVT2
SW Version	RRF31.Q1-37
EUT Stage	Identical Prototype

Note: There are two types of EUT, please refer to the product equality declaration exhibit submitted. According to the difference, we choose the sample 1 to full test.

1.4 Product Specification of Equipment Under Test

Standards-related Product Specification	
Tx Frequency	LTE Band 7 : 2500 MHz ~ 2570 MHz LTE Band 38 : 2570 MHz ~ 2620 MHz LTE Band 41 : 2535 MHz ~ 2655 MHz
Rx Frequency	LTE Band 7 : 2620 MHz ~ 2690 MHz LTE Band 38 : 2570 MHz ~ 2620 MHz LTE Band 41 : 2535 MHz ~ 2655 MHz
Bandwidth	LTE Band 7 : 5MHz/ 10MHz / 15MHz / 20MHz LTE Band 38 : 5MHz / 10MHz / 15MHz / 20MHz LTE Band 41 : 5MHz / 10MHz / 15MHz / 20MHz
Maximum Output Power to Antenna	LTE Band 7 : 22.85 dBm LTE Band 7C_CA : 22.63dBm LTE Band 38 : 22.77 dBm LTE Band 41 : 22.98 dBm
Antenna Gain	LTE Band 7 : -1.3 dBi LTE Band 38 : -1.3 dBi LTE Band 41 : -1.3 dBi
Type of Modulation	QPSK / 16QAM / 64QAM

1.5 Modification of EUT

No modifications are made to the EUT during all test items.



1.6 Maximum EIRP Power, Frequency Tolerance, and Emission Designator

LTE Band 7		QPSK			16QAM		
BW (MHz)	Frequency Range (MHz)	Emission Designator (99%OBW)	Frequency Tolerance (ppm)	Maximum EIRP(W)	Emission Designator (99%OBW)	Frequency Tolerance (ppm)	Maximum EIRP(W)
20	2510.0 ~ 2560.0	17M9G7D	0.0033	0.1429	17M9W7D	-	0.1285
LTE Band 38		QPSK			16QAM		
BW (MHz)	Frequency Range (MHz)	Emission Designator (99%OBW)	Frequency Tolerance (ppm)	Maximum EIRP(W)	Emission Designator (99%OBW)	Frequency Tolerance (ppm)	Maximum EIRP(W)
20	2580.0 ~ 2610.0	18M4G7D	0.0012	0.1403	18M3W7D	-	0.1300
LTE Band 41		QPSK			16QAM		
BW (MHz)	Frequency Range (MHz)	Emission Designator (99%OBW)	Frequency Tolerance (ppm)	Maximum EIRP(W)	Emission Designator (99%OBW)	Frequency Tolerance (ppm)	Maximum EIRP(W)
20	2545.0 ~ 2645.0	18M4G7D	0.0012	0.1472	18M3W7D	-	0.1247

LTE Band 7 CA		QPSK			16QAM		
BW (MHz)	Emission Designator (99%OBW)	Frequency Tolerance (ppm)	Maximum EIRP(W)	Emission Designator (99%OBW)	Frequency Tolerance (ppm)	Maximum EIRP(W)	
20MHz+20MHz	37M8G7D	-	0.1358	37M7W7D	-	0.1143	

Note:

1. LTE Band 41 overlaps the entire frequency range of LTE Band 38. Therefore, the test results provided in this report covers Band 41 as well as Band 38.
2. The maximum EIRP for CA band is calculated from max output power of 20M+20M and antenna gain, only the maximum EIRP is shown on the report.
3. Based on engineering evaluation, only the maximum bandwidth and the worst modulation test results are shown in the report.



1.7 Testing Location

Sporton International (Kunshan) Inc. is accredited to ISO/IEC 17025:2017 by American Association for Laboratory Accreditation with Certificate Number 5145.02.

Test Firm	Sporton International (Kunshan) Inc.		
Test Site Location	No. 1098, Pengxi North Road, Kunshan Economic Development Zone Jiangsu Province 215300 People's Republic of China TEL : +86-512-57900158 FAX : +86-512-57900958		
Test Site No.	Sporton Site No.	FCC Designation No.	FCC Test Firm Registration No.
	03CH06-KS TH01-KS	CN1257	314309

1.8 Test Software

Item	Site	Manufacturer	Name	Version
1.	03CH06-KS	AUDIX	E3	6.2009-8-24al

1.9 Applicable Standards

According to the specifications of the manufacturer, the EUT must comply with the requirements of the following standards:

- ♦ 47 CFR Part 2, 27(M)
- ♦ ANSI C63.26-2015
- ♦ FCC KDB 971168 D01 Power Meas License Digital Systems v03r01
- ♦ FCC KDB 412172 D01 Determining ERP and EIRP v01r01

Remark:

1. All test items were verified and recorded according to the standards and without any deviation during the test.
2. This EUT has also been tested and complied with the requirements of FCC Part 15, Subpart B, recorded in a separate test report.



1.10 Specification of Accessory

Specification of Accessory				
AC Adapter 1(US)	Brand Name	Motorola (Chenyang)	Model Name	MC-101
AC Adapter 1(EU)	Brand Name	Motorola (Chenyang)	Model Name	MC-102
AC Adapter 1(UK)	Brand Name	Motorola (Chenyang)	Model Name	MC-103
AC Adapter 1(AU)	Brand Name	Motorola (Chenyang)	Model Name	MC-105
AC Adapter 2(US)	Brand Name	Motorola (Salcomp)	Model Name	MC-101
AC Adapter 2(EU)	Brand Name	Motorola (Salcomp)	Model Name	MC-102
AC Adapter 2(UK)	Brand Name	Motorola (Salcomp)	Model Name	MC-103
AC Adapter 2(AU)	Brand Name	Motorola (Salcomp)	Model Name	MC-105
AC Adapter 2(Chile)	Brand Name	Motorola (Salcomp)	Model Name	MC-109
AC Adapter 3(US)	Brand Name	Motorola (AOHAI)	Model Name	MC-101
AC Adapter 3(EU)	Brand Name	Motorola (AOHAI)	Model Name	MC-102
Battery 1	Brand Name	Motorola (Sunwoda)	Model Name	JK50
Battery 2	Brand Name	Motorola (ATL)	Model Name	JK50
Earphone 1	Brand Name	Motorola (Lyand)	Model Name	MH191(SH38C81577)
Earphone 2	Brand Name	Motorola (LCHSE)	Model Name	MH191(SH38C81576)
USB Cable 1	Brand Name	Motorola (Sai bao)	Model Name	SC18C24367
USB Cable 2	Brand Name	Motorola (Luxshare)	Model Name	SC18C24368
USB Cable 3	Brand Name	Motorola (Cabletech)	Model Name	SC18C49697



2 Test Configuration of Equipment Under Test

2.1 Test Mode

Antenna port conducted and radiated test items listed below are performed according to KDB 971168 D01 Power Meas License Digital Systems v03r01 with maximum output power.

Radiated measurements are performed by rotating the EUT in three different orthogonal test planes to find the maximum emission.

Test Items	Band	Bandwidth (MHz)						Modulation			RB #			Test Channel			
		1.4	3	5	10	15	20	QPSK	16QAM	64QAM	1	Half	Full	L	M	H	
Max. Output Power	7	-	-	v	v	v	v	v	v	v	v	v	v	v	v	v	
	38	-	-	v	v	v	v	v	v	v	v	v	v	v	v	v	
	41	-	-	v	v	v	v	v	v	v	v	v	v	v	v	v	
Peak-to-Average Ratio	7	-	-				v	v	v	v			v		v		
	41	-	-				v	v	v	v			v		v		
26dB and 99% Bandwidth	7	-	-				v	v	v				v		v		
	41	-	-				v	v	v				v		v		
Conducted Band Edge	7	-	-	v	v	v	v	v	v	v	v		v	v		v	
	41	-	-	v	v	v	v	v	v	v	v		v	v		v	
Conducted Spurious Emission	7	-	-	v	v	v	v	v				v		v	v	v	
	41	-	-	v	v	v	v	v				v		v	v	v	
Frequency Stability	7	-	-				v	v					v		v		
	41	-	-				v	v					v		v		
E.R.P / E.I.R.P	7	-	-	v	v	v	v	v	v	v	v			v	v	v	
	38	-	-	v	v	v	v	v	v	v	v			v	v	v	
	41	-	-	v	v	v	v	v	v	v	v			v	v	v	
Radiated Spurious Emission	7	Worst Case														v	
	41	Worst Case														v	
Note	<ol style="list-style-type: none"> The mark "v" means that this configuration is chosen for testing The mark "-" means that this bandwidth is not supported. The device is investigated from 30MHz to 10 times of fundamental signal for radiated spurious emission test under different RB size/offset and modulations in exploratory test. Subsequently, only the worst case emissions are reported. LTE Band 41 overlaps the entire frequency range of LTE Band 38. Therefore, the test results provided in this report covers Band 41 as well as Band 38. All test items are based on engineering evaluation. 																



Test Items	Band	Bandwidth (MHz)										Modulation			RB #			Test Channel		
		20+20	20+15	15+20	20+10	10+20	20+5	5+20	15+15	15+10	10+15	QPSK	16QAM	64QAM	1	Half	Full	L	M	H
Max. Output Power	7C_CA	v	v	v	v	v	-	-	v	v	-	v	v	v	v	v	v	v	v	v
26dB and 99% Bandwidth	7C_CA	v					-	-			-	v	v				v		v	
Conducted Band Edge	7C_CA	v	v	v	v	v	-	-	v	v	-	v	v	v	v		v	v	v	
Conducted Spurious Emission	7C_CA	v	v	v	v	v	-	-	v	v	-	v			v			v	v	
E.I.R.P.	7C_CA	v	v	v	v	v	-	-	v	v	-	v	v	v	v			v	v	
Radiated Spurious Emission	7C_CA	Worst Case																		v
Note	<ol style="list-style-type: none"> The mark "v" means that this configuration is chosen for testing The mark "-" means that this bandwidth is not supported. The device is investigated from 30MHz to 10 times of fundamental signal for radiated spurious emission test under different RB size/offset and modulations in exploratory test. Subsequently, only the worst case emissions are reported. All test items are based on engineering evaluation. 																			

2.2 Connection Diagram of Test System

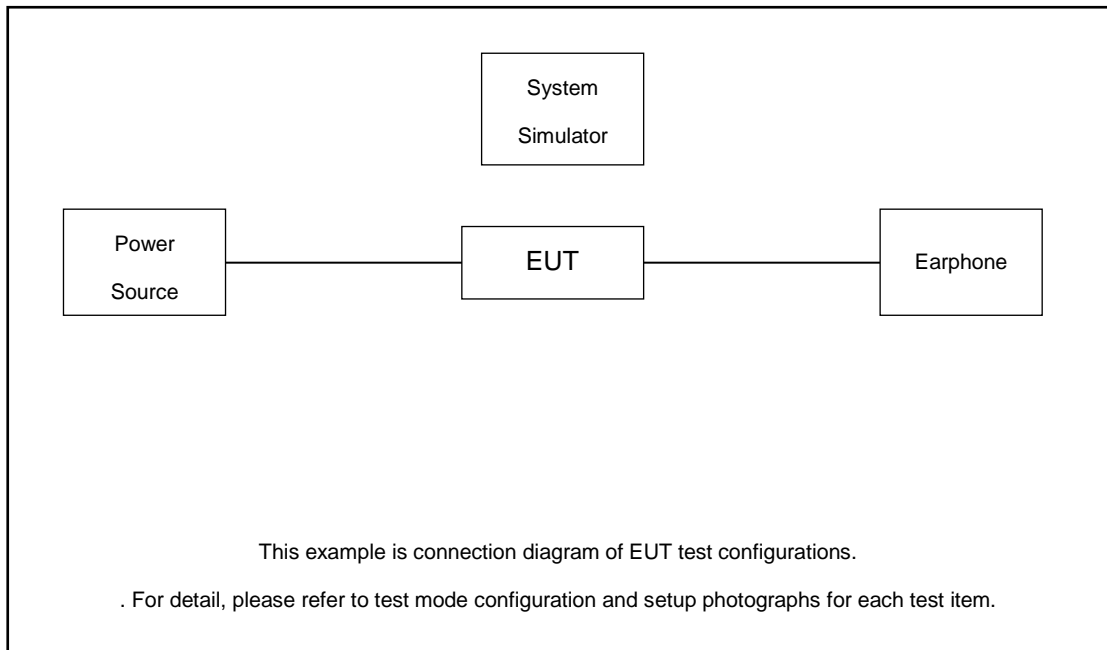

2.3 Support Unit used in test configuration and system

Item	Equipment	Trade Name	Model No.	FCC ID	Data Cable	Power Cord
1.	LTE Base Station	Anritsu	MT8820C	N/A	N/A	Unshielded, 1.8 m
2.	DC Power Supply	GWINSTEK	GPS-3030D	N/A	N/A	Unshielded, 1.8 m

2.4 Measurement Results Explanation Example

For all conducted test items:

The offset level is set in the spectrum analyzer to compensate the RF cable loss between EUT conducted output port and spectrum analyzer. With the offset compensation, the spectrum analyzer reading level is exactly the EUT RF output level.

The spectrum analyzer offset is derived from RF cable loss.

Offset = RF cable loss.

Following shows an offset computation example with cable loss 8.82 dB.

Example :

$$\begin{aligned} \text{Offset(dB)} &= \text{RF cable loss(dB)}. \\ &= 8.82 \text{ (dB)} \end{aligned}$$



2.5 Frequency List of Low/Middle/High Channels

LTE Band 7 Channel and Frequency List				
BW [MHz]	Channel/Frequency(MHz)	Lowest	Middle	Highest
20	Channel	20850	21100	21350
	Frequency	2510	2535	2560
15	Channel	20825	21100	21375
	Frequency	2507.5	2535	2562.5
10	Channel	20800	21100	21400
	Frequency	2505	2535	2565
5	Channel	20775	21100	21425
	Frequency	2502.5	2535	2567.5

LTE Band 38 Channel and Frequency List				
BW [MHz]	Channel/Frequency(MHz)	Lowest	Middle	Highest
20	Channel	37850	38000	38150
	Frequency	2580	2595	2610
15	Channel	37825	38000	38175
	Frequency	2577.5	2595	2612.5
10	Channel	37800	38000	38200
	Frequency	2575	2595	2615
5	Channel	37775	38000	38225
	Frequency	2572.5	2595	2617.5

LTE Band 41 Channel and Frequency List				
BW [MHz]	Channel/Frequency(MHz)	Lowest	Middle	Highest
20	Channel	40140	40640	41140
	Frequency	2545	2595	2645
15	Channel	40115	40640	41165
	Frequency	2542.5	2595	2647.5
10	Channel	40090	40640	41190
	Frequency	2540	2595	2650
5	Channel	40065	40640	41215
	Frequency	2537.5	2595	2652.5



LTE Band 7C_CA Channel and Frequency List					
BW [MHz]	Channel/Frequency(MHz)		Lowest	Middle	Highest
20 + 20	PCC	Channel	20850	21001	21152
		Frequency	2510.0	2525.1	2540.2
	SCC	Channel	21048	21199	21350
		Frequency	2529.8	2544.9	2560.0
20 + 15	PCC	Channel	20850	21026	21201
		Frequency	2510.0	2527.6	2545.1
	SCC	Channel	21021	21197	21372
		Frequency	2527.1	2544.7	2562.2
15 + 20	PCC	Channel	20828	21003	21179
		Frequency	2507.8	2525.3	2542.9
	SCC	Channel	20999	21174	21350
		Frequency	2524.9	2542.4	2560.0
20 + 10	PCC	Channel	20850	21051	21251
		Frequency	2510.0	2530.1	2550.1
	SCC	Channel	20994	21195	21395
		Frequency	2524.4	2544.5	2564.5
10 + 20	PCC	Channel	20805	21006	21206
		Frequency	2505.5	2525.6	2545.6
	SCC	Channel	20949	21150	21350
		Frequency	2519.9	2540.0	2560.0
15 + 15	PCC	Channel	20825	21025	21225
		Frequency	2507.5	2527.5	2547.5
	SCC	Channel	20975	21175	21375
		Frequency	2522.5	2542.5	2562.5
15 + 10	PCC	Channel	20825	21051	21277
		Frequency	2507.5	2530.1	2552.7
	SCC	Channel	20945	21171	21397
		Frequency	2519.5	2542.1	2564.7

3 Conducted Test Items

3.1 Measuring Instruments

See list of measuring instruments of this test report.

3.2 Test Setup

3.2.1 Conducted Output Power

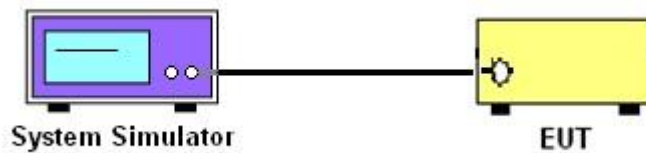

3.2.2 Peak-to-Average Ratio, Occupied Bandwidth, Conducted Band-Edge and Conducted Spurious Emission

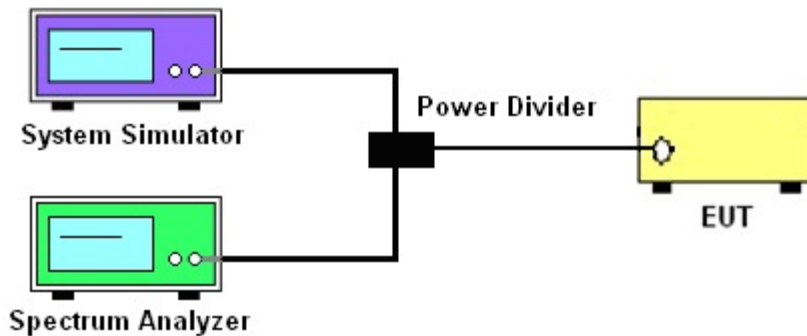

3.2.3 Frequency Stability

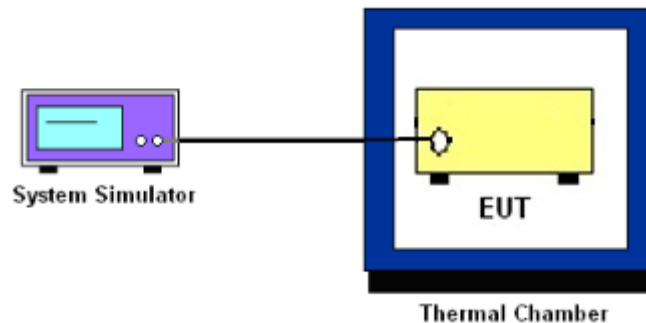

3.3 Test Result of Conducted Test

Please refer to Appendix A.



3.4 Conducted Output Power and EIRP

3.4.1 Description of the Conducted Output Power Measurement and EIRP Measurement

A system simulator was used to establish communication with the EUT. Its parameters were set to force the EUT transmitting at maximum output power. The measured power in the radio frequency on the transmitter output terminals shall be reported.

The EIRP of mobile transmitters must not exceed 2 Watts for LTE Band 7 and Band 38 and Band 41.

According to KDB 412172 D01 Power Approach,

$EIRP = P_T + G_T - L_C$, $ERP = EIRP - 2.15$, where

P_T = transmitter output power in dBm

G_T = gain of the transmitting antenna in dBi

L_C = signal attenuation in the connecting cable between the transmitter and antenna in dB

3.4.2 Test Procedures

1. The testing follows ANSI C63.26 Section 5.2
2. The transmitter output port was connected to the system simulator.
3. Set EUT at maximum power through the system simulator.
4. Select lowest, middle, and highest channels for each band and different modulation.
5. Measure and record the power level from the system simulator.



3.5 Peak-to-Average Ratio

3.5.1 Description of the PAR Measurement

Power Complementary Cumulative Distribution Function (CCDF) curves provide a means for characterizing the power peaks of a digitally modulated signal on a statistical basis. A CCDF curve depicts the probability of the peak signal amplitude exceeding the average power level. Most contemporary measurement instrumentation include the capability to produce CCDF curves for an input signal provided that the instrument's resolution bandwidth can be set wide enough to accommodate the entire input signal bandwidth. In measuring transmissions in this band using an average power technique, the peak-to-average ratio (PAR) of the transmission may not exceed 13 dB.

3.5.2 Test Procedures

1. The testing follows ANSI C63.26 Section 5.2.3.4 (CCDF).
2. The EUT was connected to spectrum and system simulator via a power divider.
3. Set the CCDF (Complementary Cumulative Distribution Function) option in spectrum analyzer.
4. The highest RF powers were measured and recorded the maximum PAPR level associated with a probability of 0.1 %.
5. Record the deviation as Peak to Average Ratio.



3.6 Occupied Bandwidth

3.6.1 Description of Occupied Bandwidth Measurement

The occupied bandwidth is the width of a frequency band such that, below the lower and above the upper frequency limits, the mean powers emitted are each equal to a specified percentage 0.5% of the total mean transmitted power.

The 26 dB emission bandwidth is defined as the frequency range between two points, one above and one below the carrier frequency, at which the spectral density of the emission is attenuated 26 dB below the maximum in-band spectral density of the modulated signal. Spectral density (power per unit bandwidth) is to be measured with a detector of resolution bandwidth equal to approximately 1.0% of the emission bandwidth.

3.6.2 Test Procedures

1. The testing follows ANSI C63.26 Section 5.4
2. The EUT was connected to spectrum analyzer and system simulator via a power divider.
3. The spectrum analyzer center frequency is set to the nominal EUT channel center frequency. The span range for the spectrum analyzer shall be between two and five times the anticipated OBW.
4. The nominal resolution bandwidth (RBW) shall be in the range of 1 to 5 % of the anticipated OBW, and the VBW shall be at least 3 times the RBW.
5. Set the detection mode to peak, and the trace mode to max hold.
6. Determine the reference value: Set the EUT to transmit a modulated signal. Allow the trace to stabilize. Set the spectrum analyzer marker to the highest level of the displayed trace.
(this is the reference value)
7. Determine the “-26 dB down amplitude” as equal to (Reference Value – X).
8. Place two markers, one at the lowest and the other at the highest frequency of the envelope of the spectral display such that each marker is at or slightly below the “-X dB down amplitude” determined in step 6. If a marker is below this “-X dB down amplitude” value it shall be placed as close as possible to this value. The OBW is the positive frequency difference between the two markers.
9. Use the 99 % power bandwidth function of the spectrum analyzer and report the measured bandwidth.



3.7 Conducted Band Edge

3.7.1 Description of Conducted Band Edge Measurement

27.53(m)(4)

For mobile digital stations, the attenuation factor shall be not less than $40 + 10 \log (P)$ dB on all frequencies between the channel edge and 5 megahertz from the channel edge, $43 + 10 \log (P)$ dB on all frequencies between 5 megahertz and X megahertz from the channel edge, and $55 + 10 \log (P)$ dB on all frequencies more than X megahertz from the channel edge, where X is the greater of 6 megahertz or the actual emission bandwidth as defined in paragraph (m)(6) of this section. In addition, the attenuation factor shall not be less that $43 + 10 \log (P)$ dB on all frequencies between 2490.5 MHz and 2496 MHz and $55 + 10 \log (P)$ dB at or below 2490.5 MHz. Mobile Satellite Service licensees operating on frequencies below 2495 MHz may also submit a documented interference complaint against BRS licensees operating on channel BRS Channel 1 on the same terms and conditions as adjacent channel BRS or EBS licensees.

3.7.2 Test Procedures

1. The testing follows ANSI C63.26 section 5.7
2. The EUT was connected to spectrum analyzer and system simulator via a power divider.
3. The band edges of low and high channels for the highest RF powers were measured.
4. Set RBW \geq 1% EBW in the 1MHz band immediately outside and adjacent to the band edge.
5. Beyond the 1 MHz band from the band edge, RBW=1MHz was used.
6. Set spectrum analyzer with RMS detector.
7. The RF fundamental frequency should be excluded against the limit line in the operating frequency band.
8. Checked that all the results comply with the emission limit line.

Example:

The limit line is derived from $43 + 10\log(P)$ dB below the transmitter power P(Watts)
= P(W)- [43 + 10log(P)] (dB)
= [30 + 10log(P)] (dBm) - [43 + 10log(P)] (dB) = -13dBm.

9. For LTE Band 7, 38, 41, the other 40 dB, and 55 dB have additionally applied same calculation above.



3.8 Conducted Spurious Emission

3.8.1 Description of Conducted Spurious Emission Measurement

For Band 7,38,41:

The power of any emission outside of the authorized operating frequency ranges must be lower than the transmitter power (P) by a factor of at least $55 + 10 \log (P)$ dB.

It is measured by means of a calibrated spectrum analyzer and scanned from 30 MHz up to a frequency including its 10th harmonic.

3.8.2 Test Procedures

1. The testing follows ANSI C63.26 section 5.7
2. The EUT was connected to spectrum analyzer and system simulator via a power divider.
3. The RF output of EUT was connected to the spectrum analyzer by RF cable and attenuator.
The path loss was compensated to the results for each measurement.
4. The middle channel for the highest RF power within the transmitting frequency was measured.
5. The conducted spurious emission for the whole frequency range was taken.
6. Make the measurement with the spectrum analyzer's RBW = 1MHz, VBW = 3MHz.
7. Set spectrum analyzer with RMS detector.
8. Taking the record of maximum spurious emission.
9. The RF fundamental frequency should be excluded against the limit line in the operating frequency band.
10. The limit line is derived from $43 + 10\log(P)$ dB below the transmitter power P(Watts)
 $= P(W) - [43 + 10\log(P)]$ (dB)
 $= [30 + 10\log(P)]$ (dBm) - $[43 + 10\log(P)]$ (dB)
 $= -13$ dBm.
11. For Band 7, 38, 41
The limit line is derived from $55 + 10\log(P)$ dB below the transmitter power P(Watts)
 $= P(W) - [55 + 10\log(P)]$ (dB)
 $= [30 + 10\log(P)]$ (dBm) - $[55 + 10\log(P)]$ (dB)
 $= -25$ dBm.



3.9 Frequency Stability

3.9.1 Description of Frequency Stability Measurement

The frequency stability shall be measured by variation of ambient temperature and variation of primary supply voltage to ensure that the fundamental emission stays within the authorized frequency block. The frequency stability of the transmitter shall be maintained within $\pm 0.00025\%$ ($\pm 2.5\text{ppm}$) of the center frequency.

3.9.2 Test Procedures for Temperature Variation

1. The testing follows ANSI C63.26 section 5.6.4
2. The EUT was set up in the thermal chamber and connected with the system simulator.
3. With power OFF, the temperature was decreased to -30°C and the EUT was stabilized before testing. Power was applied and the maximum change in frequency was recorded within one minute.
4. With power OFF, the temperature was raised in 10°C step up to 50°C . The EUT was stabilized at each step for at least half an hour. Power was applied and the maximum frequency change was recorded within one minute.

3.9.3 Test Procedures for Voltage Variation

1. The testing follows ANSI C63.26 section 5.6.5
2. The EUT was placed in a temperature chamber at $20\pm 5^{\circ}\text{C}$ and connected with the system simulator.
3. The power supply voltage to the EUT was varied from 85% to 115% of the nominal value for other than hand carried battery equipment.
4. For hand carried, battery powered equipment, reduce the primary ac or dc supply voltage to the battery operating end point, which shall be specified by the manufacturer.
5. The variation in frequency was measured for the worst case.

4 Radiated Test Items

4.1 Measuring Instruments

See list of measuring instruments of this test report.

4.2 Test Setup

4.2.1 For radiated test from 30MHz to 1GHz

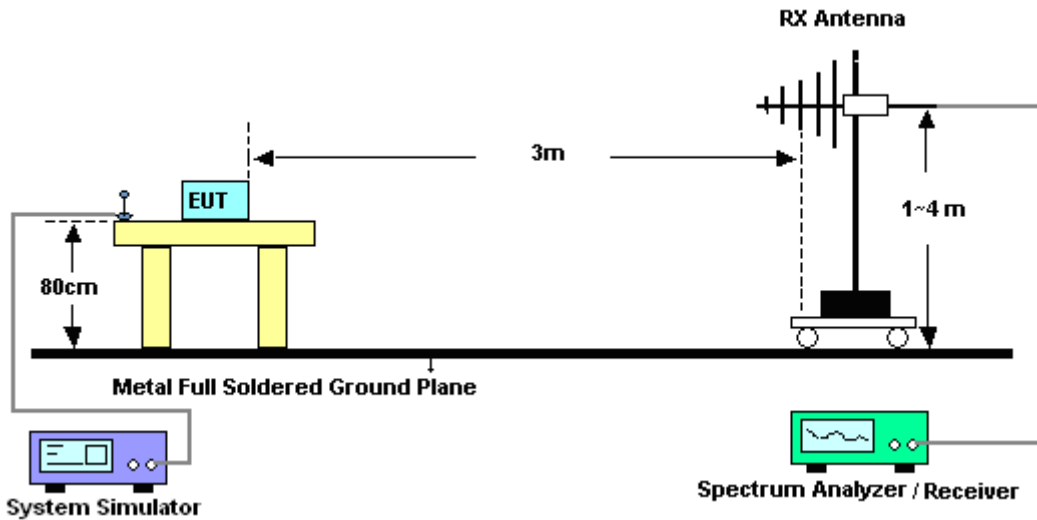

4.2.2 For radiated test above 1GHz

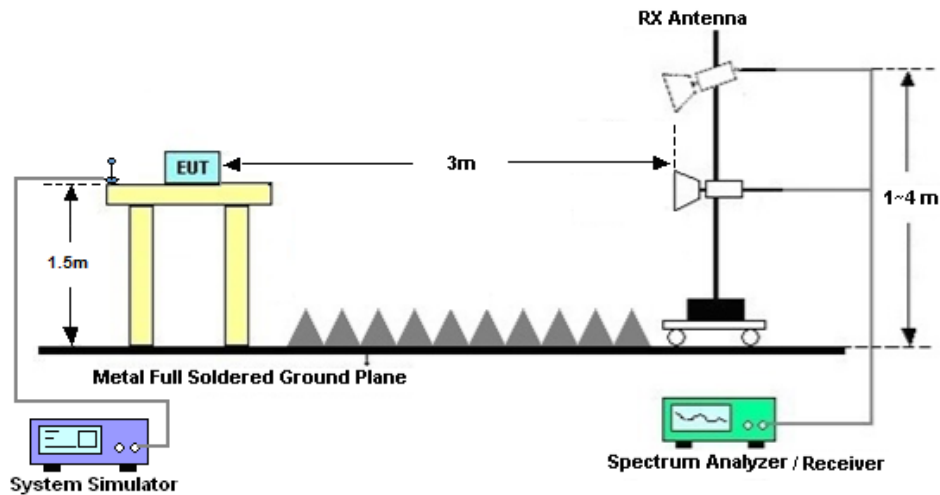

4.3 Test Result of Radiated Test

Please refer to Appendix B.



4.4 Radiated Spurious Emission

4.4.1 Description of Radiated Spurious Emission

The radiated spurious emission was measured by substitution method according to ANSI C63.26.

For Band 7, 38, 41

The power of any emission outside of the authorized operating frequency ranges must be attenuated below the transmitter power (P) by a factor of at least $55 + 10 \log (P)$ dB.

The spectrum is scanned from 30 MHz up to a frequency including its 10th harmonic.

4.4.2 Test Procedures

1. The testing follows ANSI C63.26 Section 5.5
2. The EUT was placed on a turntable with 0.8 meter height for frequency below 1GHz and 1.5 meter height for frequency above 1GHz respectively above ground.
3. The EUT was set 3 meters from the receiving antenna mounted on the antenna tower.
4. The table was rotated 360 degrees to determine the position of the highest spurious emission.
5. The height of the receiving antenna is varied between 1m to 4m to search the maximum spurious emission for both horizontal and vertical polarizations.
6. During the measurement, the system simulator parameters were set to force the EUT transmitting at maximum output power.
7. Make the measurement with the spectrum analyzer's RBW = 1MHz, VBW = 3MHz, taking the record of maximum spurious emission.
8. A horn antenna was substituted in place of the EUT and was driven by a signal generator.
9. Tune the output power of signal generator to the same emission level with EUT maximum spurious emission.
10. $EIRP \text{ (dBm)} = S.G. \text{ Power} - Tx \text{ Cable Loss} + Tx \text{ Antenna Gain}$
11. $ERP \text{ (dBm)} = EIRP - 2.15$
12. The RF fundamental frequency should be excluded against the limit line in the operating frequency band.

The limit line is derived from $43 + 10\log(P)$ dB below the transmitter power P(Watts)
 $= P(W) - [43 + 10\log(P)] \text{ (dB)}$
 $= [30 + 10\log(P)] \text{ (dBm)} - [43 + 10\log(P)] \text{ (dB)}$
 $= -13\text{dBm}.$

13. For Band 7, 38, 41:

The limit line is derived from $55 + 10\log(P)$ dB below the transmitter power P(Watts)



5 List of Measuring Equipment

Instrument	Manufacturer	Model No.	Serial No.	Characteristics	Calibration Date	Test Date	Due Date	Remark
Spectrum Analyzer	R&S	FSV40	101040	10Hz~40GHz	Nov. 01, 2020	Jan. 30, 2021~ Feb. 19, 2021	Oct. 31, 2021	Conducted (TH01-KS)
Temperature & humidity chamber	Hongzhan	LP-150U	H2014011440	-40~+150°C 20%~95%RH	Jul. 03, 2020	Jan. 30, 2021~ Feb. 19, 2021	Jul. 02, 2021	Conducted (TH01-KS)
EXA Spectrum Analyzer	Keysight	N9010A	MY55150208	10Hz-44GHz	Apr. 14, 2020	Jan. 30, 2021	Apr. 13, 2021	Radiation (03CH06-KS)
Bilog Antenna	TeseQ	CBL6111D	49921	30MHz-1GHz	May 29, 2020	Jan. 30, 2021	May 28, 2021	Radiation (03CH06-KS)
Double Ridge Horn Antenna	ETS-Lindgren	3117	00218652	1GHz~18GHz	Apr. 27, 2020	Jan. 30, 2021	Apr. 26, 2021	Radiation (03CH06-KS)
SHF-EHF Horn	Com-power	AH-840	101115	18GHz~40GHz	Nov. 06, 2020	Jan. 30, 2021	Nov. 05, 2021	Radiation (03CH06-KS)
Amplifier	SONOMA	310N	187289	9KHz ~1GHZ	Apr. 14, 2020	Jan. 30, 2021	Apr. 13, 2021	Radiation (03CH06-KS)
Amplifier	MITEQ	EM18G40G GA	060728	18~40GHz	Jan. 07, 2021	Jan. 30, 2021	Jan. 06, 2022	Radiation (03CH06-KS)
high gain Amplifier	MITEQ	AMF-7D-00 101800-30-1 QP	2025788	1Ghz-18Ghz	Jan. 06, 2021	Jan. 30, 2021	Jan. 05, 2022	Radiation (03CH06-KS)
Amplifier	Keysight	83017A	MY53270203	500MHz~26.5GHz	Apr. 15, 2020	Jan. 30, 2021	Apr. 14, 2021	Radiation (03CH06-KS)
AC Power Source	Chroma	61601	F104090004	N/A	NCR	Jan. 30, 2021	NCR	Radiation (03CH06-KS)
Turn Table	ChamPro	EM 1000-T	060762-T	0~360 degree	NCR	Jan. 30, 2021	NCR	Radiation (03CH06-KS)
Antenna Mast	ChamPro	EM 1000-A	060762-A	1 m~4 m	NCR	Jan. 30, 2021	NCR	Radiation (03CH06-KS)

NCR: No Calibration Required



6 Uncertainty of Evaluation

The measurement uncertainties shown below were calculated in accordance with the requirements of ANSI 63.26-2015. All the measurement uncertainty value were shown with a coverage K=2 to indicate 95% level of confidence. The measurement data show herein meets or exceeds the CISPR measurement uncertainty values specified in CISPR 16-4-2 and can be compared directly to specified limit to determine compliance.

Uncertainty of Radiated Emission Measurement (30 MHz ~ 1000 MHz)

Measuring Uncertainty for a Level of Confidence of 95% (U = 2Uc(y))	2.5dB
---	-------

Uncertainty of Radiated Emission Measurement (1 GHz ~ 18 GHz)

Measuring Uncertainty for a Level of Confidence of 95% (U = 2Uc(y))	2.1dB
---	-------

Uncertainty of Radiated Emission Measurement (18 GHz ~ 40 GHz)

Measuring Uncertainty for a Level of Confidence of 95% (U = 2Uc(y))	2.1dB
---	-------



Appendix A. Test Results of Conducted Test

Conducted Output Power(Average power)and EIRP

LTE Band 7:

BW [MHz]	Modulation	RB Size	RB Offset	Power	Power	Power	EIRP		
				Low Ch. / Freq.	Middle Ch. / Freq.	High Ch. / Freq.			
Channel				20850	20850	21350			
Frequency (MHz)				2510	2535	2560	L	M	H
20	QPSK	1	0	22.53	22.85	22.81	0.1327	0.1429	0.1416
20	QPSK	1	49	22.38	22.57	22.75	0.1282	0.1340	0.1396
20	QPSK	1	99	22.37	22.56	22.75	0.1279	0.1337	0.1396
20	QPSK	50	0	21.68	21.91	21.72	0.1091	0.1151	0.1102
20	QPSK	50	24	21.50	21.59	21.81	0.1047	0.1069	0.1125
20	QPSK	50	50	21.56	21.67	21.88	0.1062	0.1089	0.1143
20	QPSK	100	0	21.58	21.70	21.63	0.1067	0.1096	0.1079
20	16QAM	1	0	21.72	21.72	22.39	0.1102	0.1102	0.1285
20	64QAM	1	0	20.62	20.68	21.01	0.0855	0.0867	0.0935
Channel				20825	21100	21375	EIRP		
Frequency (MHz)				2507.5	2535	2562.5	L	M	H
15	QPSK	1	0	22.37	22.44	22.85	0.1279	0.1300	0.1429
15	16QAM	1	0	21.71	21.67	22.13	0.1099	0.1089	0.1211
Channel				20800	21100	21400	EIRP		
Frequency (MHz)				2505	2535	2565	L	M	H
10	QPSK	1	0	22.85	22.84	22.85	0.1429	0.1426	0.1429
10	16QAM	1	0	21.96	22.04	22.31	0.1164	0.1186	0.1262
Channel				20775	21100	21425	EIRP		
Frequency (MHz)				2502.5	2535	2567.5	L	M	H
5	QPSK	1	0	22.60	22.79	22.84	0.1349	0.1409	0.1426
5	16QAM	1	0	22.09	22.16	22.38	0.1199	0.1219	0.1282



LTE Band 38:

BW [MHz]	Modulation	RB Size	RB Offset	Power Low Ch. / Freq.	Power Middle Ch. / Freq.	Power High Ch. / Freq.	EIRP		
Channel				37850	38000	38150			
Frequency (MHz)				2580	2595	2610	L	M	H
20	QPSK	1	0	22.69	22.77	22.45	0.1377	0.1403	0.1303
20	QPSK	1	49	22.58	22.45	22.41	0.1343	0.1303	0.1291
20	QPSK	1	99	22.45	22.59	22.30	0.1303	0.1346	0.1259
20	QPSK	50	0	21.63	21.69	21.42	0.1079	0.1094	0.1028
20	QPSK	50	24	21.68	21.47	21.48	0.1091	0.1040	0.1042
20	QPSK	50	50	21.55	21.45	21.42	0.1059	0.1035	0.1028
20	QPSK	100	0	21.46	21.60	21.47	0.1038	0.1072	0.1040
20	16QAM	1	0	22.44	22.03	22.17	0.1300	0.1183	0.1222
20	64QAM	1	0	20.61	20.54	20.38	0.0853	0.0839	0.0809
Channel				37825	38000	38175	EIRP		
Frequency (MHz)				2577.5	2595	2612.5	L	M	H
15	QPSK	1	0	22.67	22.57	22.45	0.1371	0.1340	0.1303
15	16QAM	1	0	22.26	22.20	22.05	0.1247	0.1230	0.1189
Channel				37800	38000	38200	EIRP		
Frequency (MHz)				2575	2595	2615	L	M	H
10	QPSK	1	0	22.76	22.67	22.56	0.1400	0.1371	0.1337
10	16QAM	1	0	22.31	22.20	22.12	0.1262	0.1230	0.1208
Channel				37775	38000	38225	EIRP		
Frequency (MHz)				2572.5	2595	2617.5	L	M	H
5	QPSK	1	0	22.73	22.56	22.53	0.1390	0.1337	0.1327
5	16QAM	1	0	22.43	22.23	22.10	0.1297	0.1239	0.1202



LTE Band 41:

BW [MHz]	Modulation	RB Size	RB Offset	Power Low Ch. / Freq.	Power Middle Low Ch. / Freq.	Power High Ch. / Freq.	EIRP		
Channel				40140	40640	41140			
Frequency (MHz)				2545	2595	2645	L	M	H
20	QPSK	1	0	22.62	22.98	22.91	0.1355	0.1472	0.1449
20	QPSK	1	49	22.69	22.69	22.86	0.1377	0.1377	0.1432
20	QPSK	1	99	22.68	22.60	22.82	0.1374	0.1349	0.1419
20	QPSK	50	0	21.84	21.96	21.92	0.1132	0.1164	0.1153
20	QPSK	50	24	21.87	21.76	21.93	0.1140	0.1112	0.1156
20	QPSK	50	50	21.86	21.75	21.94	0.1138	0.1109	0.1159
20	QPSK	100	0	21.91	21.93	21.91	0.1151	0.1156	0.1151
20	16QAM	1	0	21.81	22.06	22.26	0.1125	0.1191	0.1247
20	64QAM	1	0	20.68	20.83	20.85	0.0867	0.0897	0.0902
Channel				40115	40640	41165	EIRP		
Frequency (MHz)				2542.5	2595	2647.5	L	M	H
15	QPSK	1	0	22.62	22.82	22.89	0.1355	0.1419	0.1442
15	16QAM	1	0	21.81	22.03	22.10	0.1125	0.1183	0.1202
Channel				40090	40640	41190	EIRP		
Frequency (MHz)				2540	2595	2650	L	M	H
10	QPSK	1	0	22.85	22.82	22.96	0.1429	0.1419	0.1466
10	16QAM	1	0	21.98	22.06	22.17	0.1169	0.1191	0.1222
Channel				40065	40640	41215	EIRP		
Frequency (MHz)				2537.5	2595	2652.5	L	M	H
5	QPSK	1	0	22.97	22.93	22.91	0.1469	0.1455	0.1449
5	16QAM	1	0	22.13	22.06	22.25	0.1211	0.1191	0.1245



CA

Combination 20MHz+20MHz (100RB+100RB)							
Channel	Modulation	PCC		SCC		Measured Power	EIRP
		RB Size	RB offset	RB Size	RB offset		
L	QPSK	1	Max	1	0	22.63	0.1358
M	QPSK	1	Max	1	0	22.53	0.1327
H	QPSK	1	Max	1	0	22.45	0.1303
L	16QAM	1	Max	1	0	21.88	0.1143
M	16QAM	1	Max	1	0	21.63	0.1079
H	16QAM	1	Max	1	0	21.42	0.1028
L	64QAM	1	Max	1	0	20.55	0.0841
M	64QAM	1	Max	1	0	20.61	0.0853
H	64QAM	1	Max	1	0	20.40	0.0813



LTE Band 7

Peak-to-Average Ratio

Mode	LTE Band 7 / 20MHz			
Mod.	QPSK	16QAM	64QAM	Limit: 13dB
RB Size	Full RB	Full RB	Full RB	Result
Middle CH	4.78	5.86	6.61	PASS

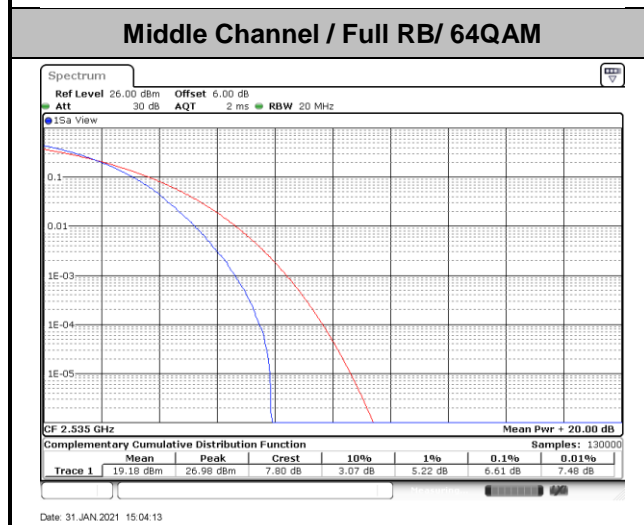
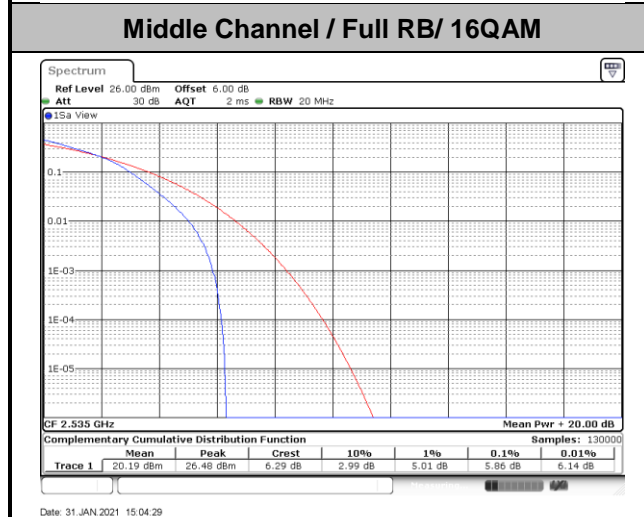
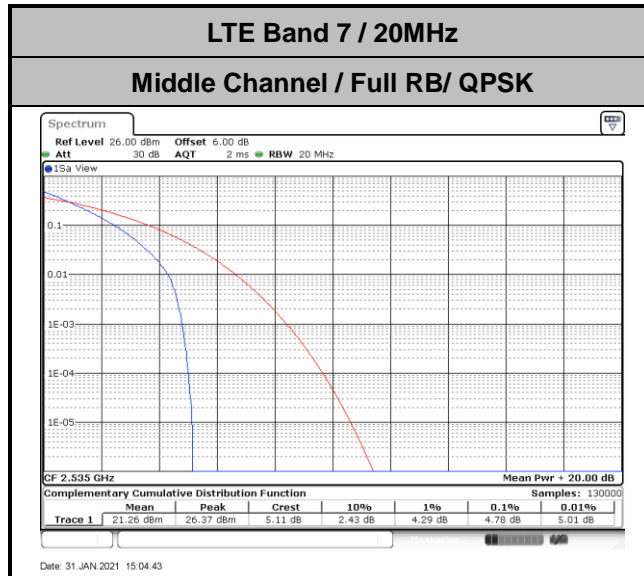



26dB Bandwidth

Mode	LTE Band 7 : 26dB BW(MHz)	
BW	20MHz	
Mod.	QPSK	16QAM
Middle CH	18.66	19.18

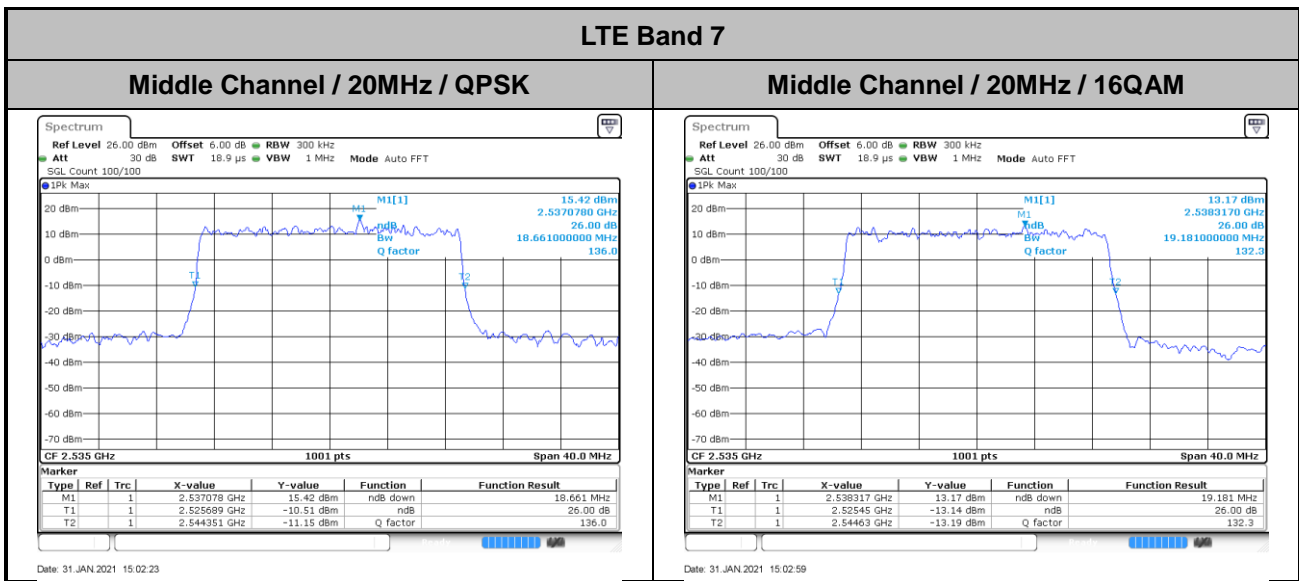



Occupied Bandwidth

Mode	LTE Band 7 : 99%OBW(MHz)	
BW	20MHz	
Mod.	QPSK	16QAM
Middle CH	17.90	17.86

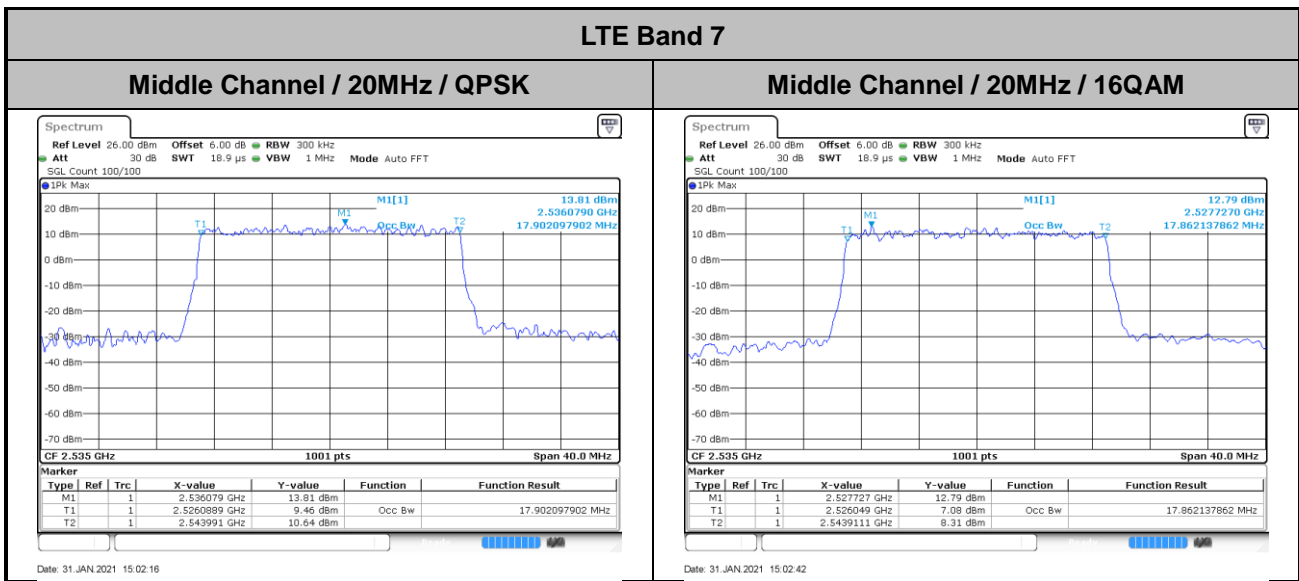



Conducted Band Edge

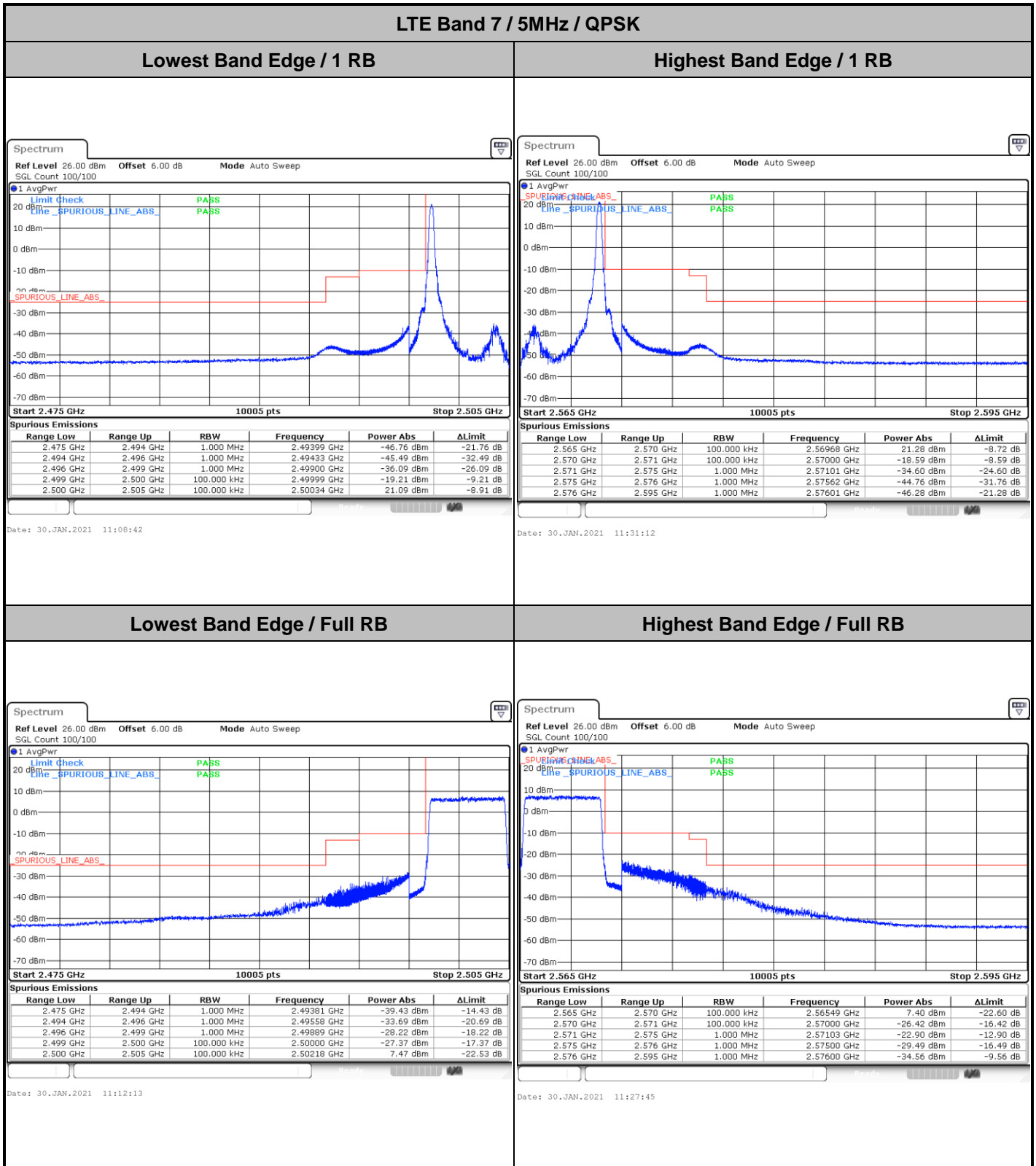



LTE Band 7 / 5MHz / 16QAM

Lowest Band Edge / 1RB

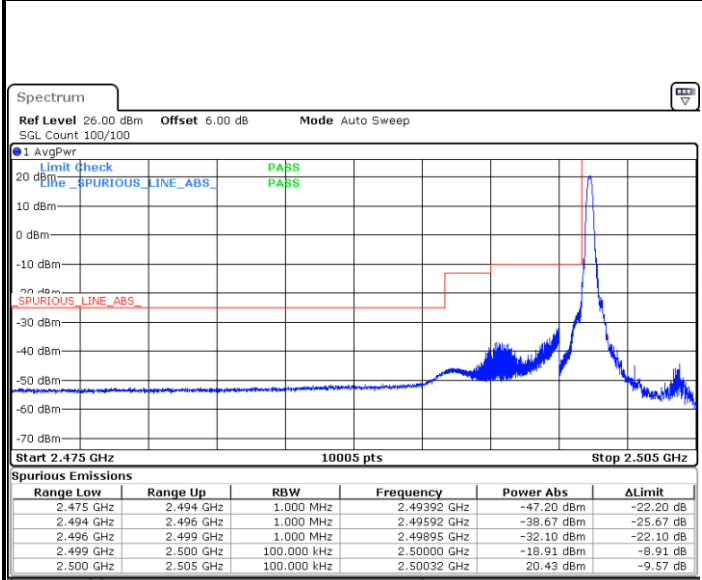

Date: 30.JAN.2021 11:09:53

Highest Band Edge / 1 RB

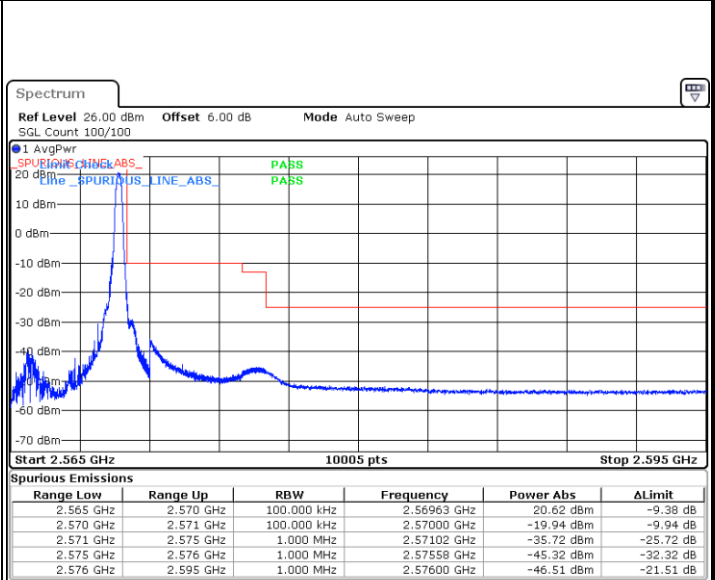

Date: 30.JAN.2021 11:30:03

Lowest Band Edge / Full RB

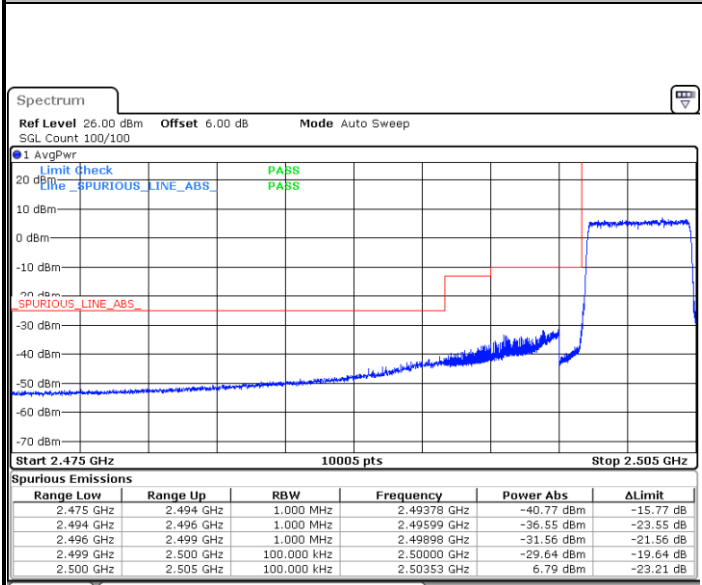

Date: 30.JAN.2021 11:11:03

Highest Band Edge / Full RB

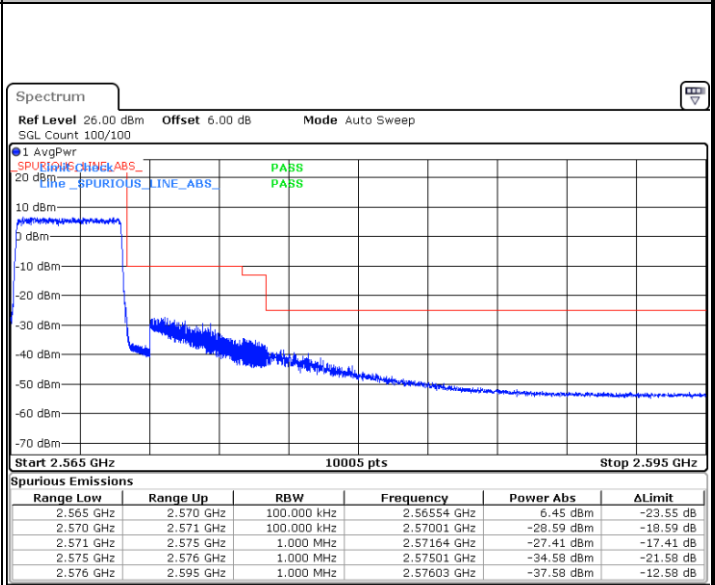

Date: 30.JAN.2021 11:28:54



LTE Band 7 / 5MHz / 64QAM

Lowest Band Edge / 1RB

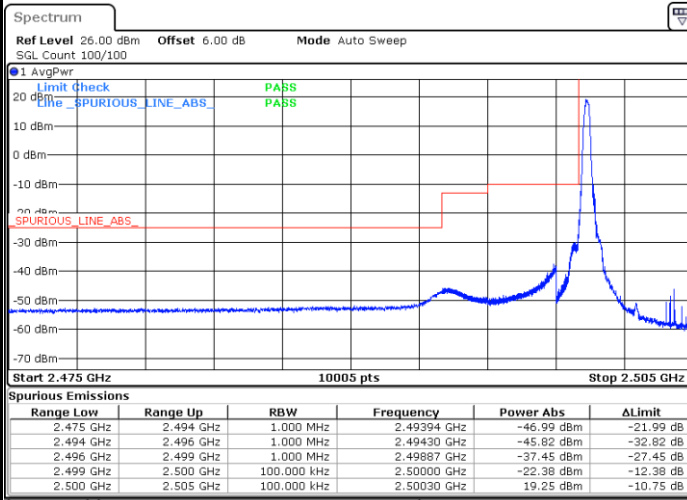

Date: 30.JAN.2021 12:04:26

Highest Band Edge / 1 RB

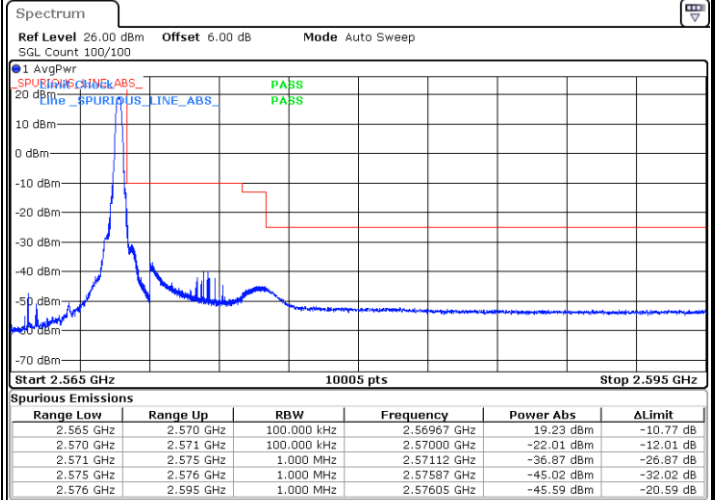

Date: 30.JAN.2021 12:06:45

Lowest Band Edge / Full RB

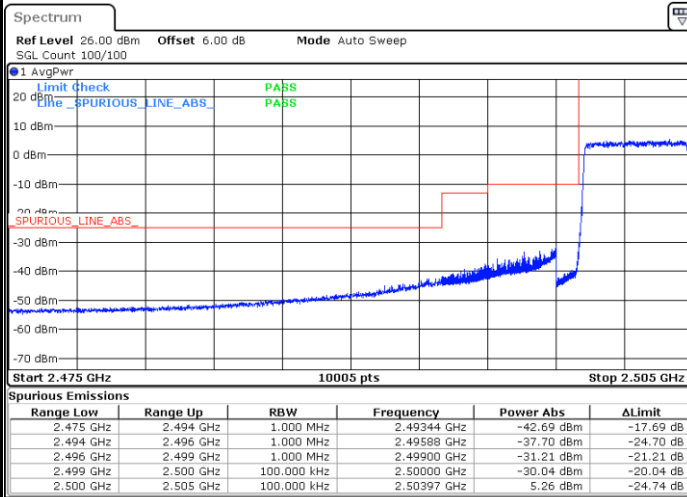

Date: 30.JAN.2021 12:05:36

Highest Band Edge / Full RB

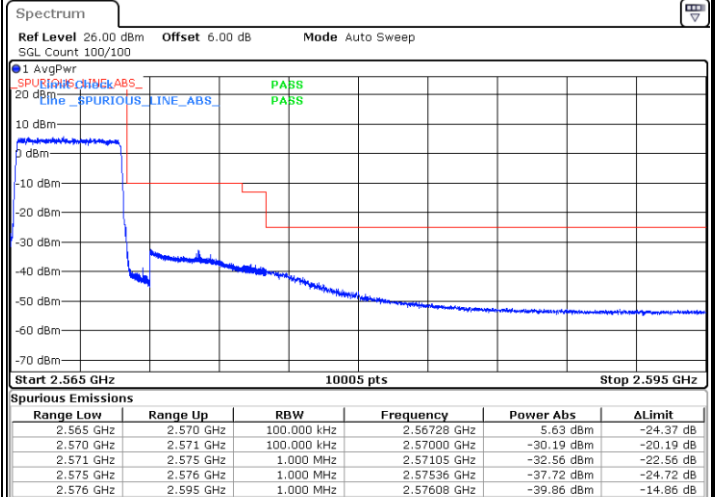

Date: 30.JAN.2021 12:07:53



LTE Band 7 / 10MHz / QPSK

Lowest Band Edge / 1 RB

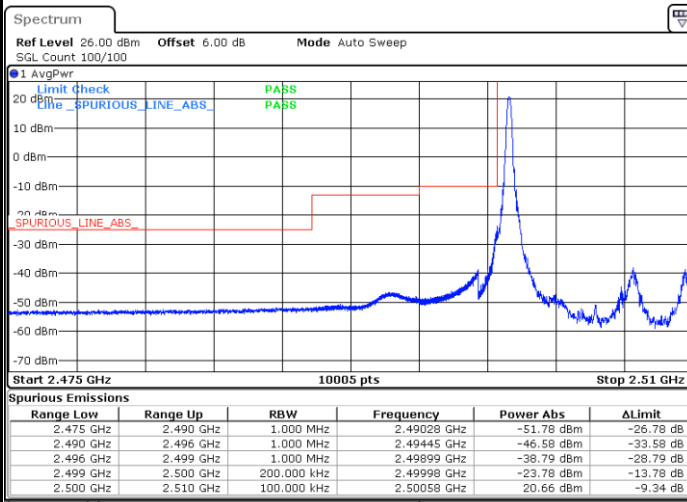

Date: 30.JAN.2021 11:32:22

Highest Band Edge / 1 RB

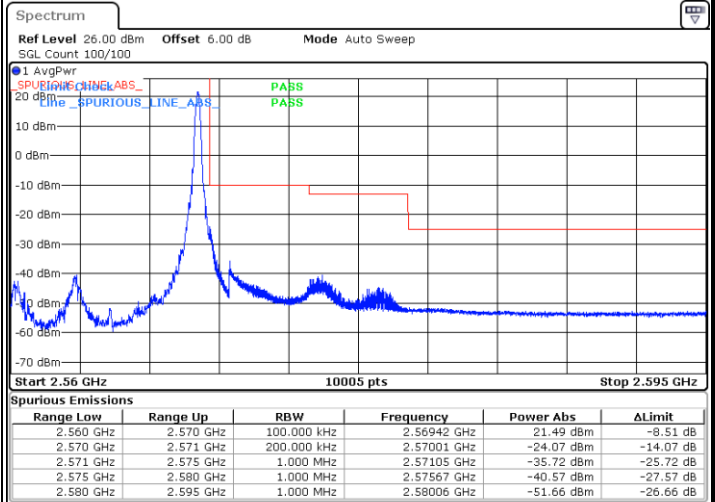

Date: 30.JAN.2021 11:42:57

Lowest Band Edge / Full RB

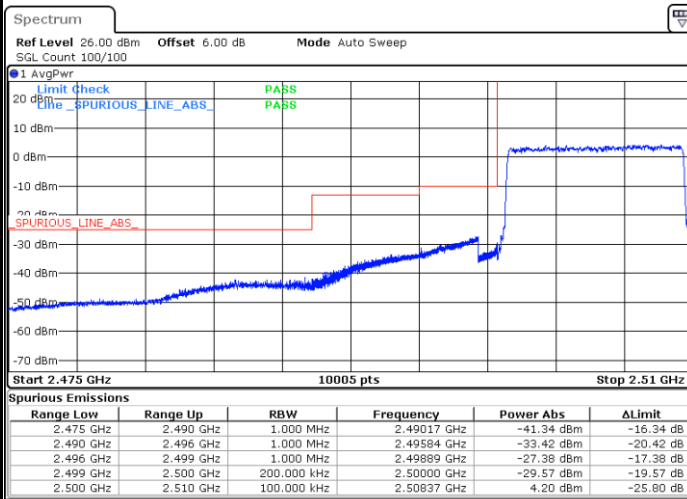

Date: 30.JAN.2021 11:35:49

Highest Band Edge / Full RB

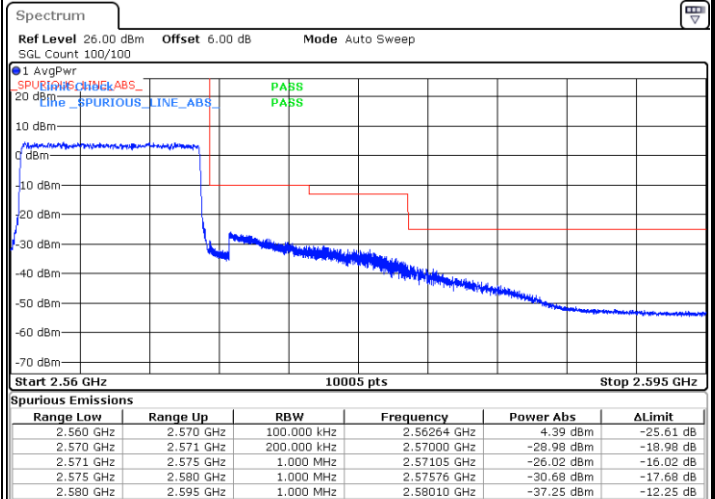

Date: 30.JAN.2021 11:36:58



LTE Band 7 / 10MHz / 16QAM

Lowest Band Edge / 1 RB

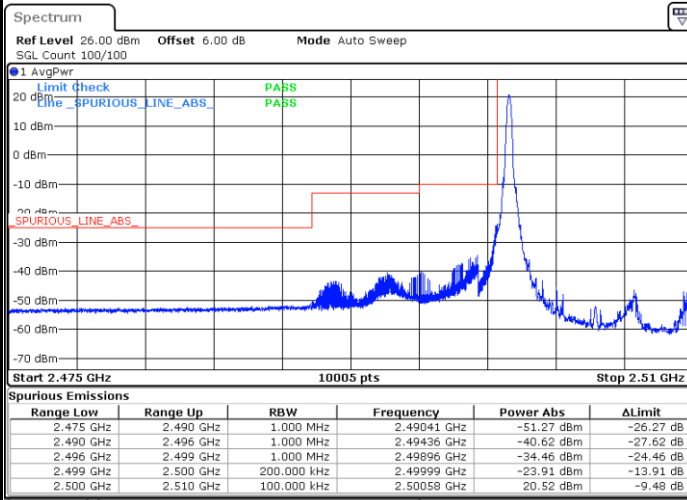

Date: 30.JAN.2021 11:33:31

Highest Band Edge / 1 RB

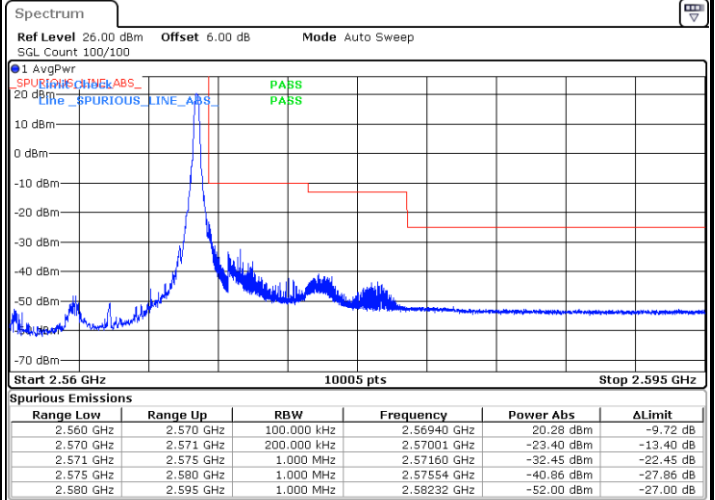

Date: 30.JAN.2021 11:41:48

Lowest Band Edge / Full RB

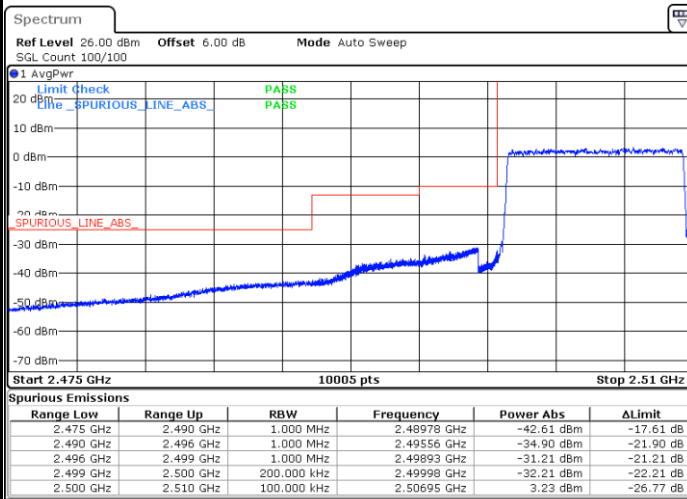

Date: 30.JAN.2021 11:34:40

Highest Band Edge / Full RB

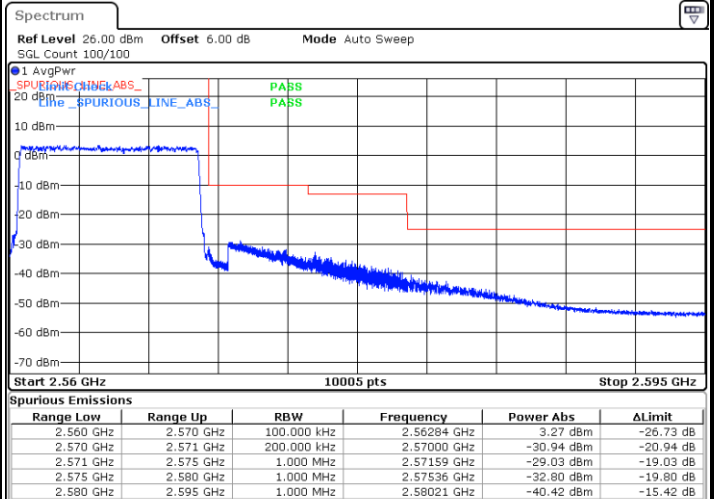

Date: 30.JAN.2021 11:38:07



LTE Band 7 / 10MHz / 64QAM

Lowest Band Edge / 1 RB

Highest Band Edge / 1 RB

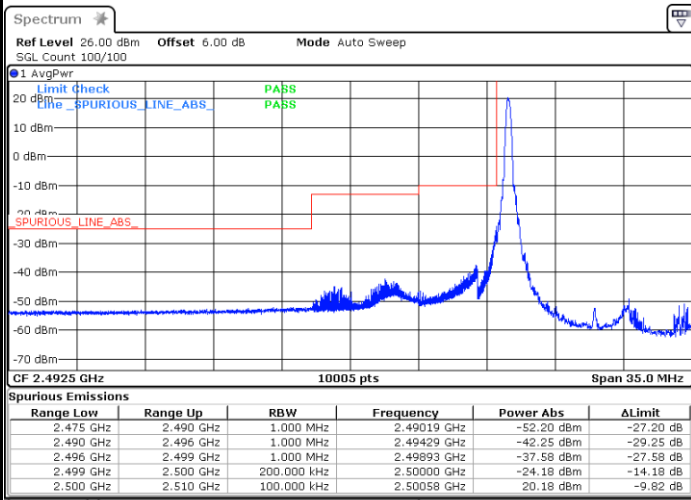

Date: 31.JAN.2021 14:57:28

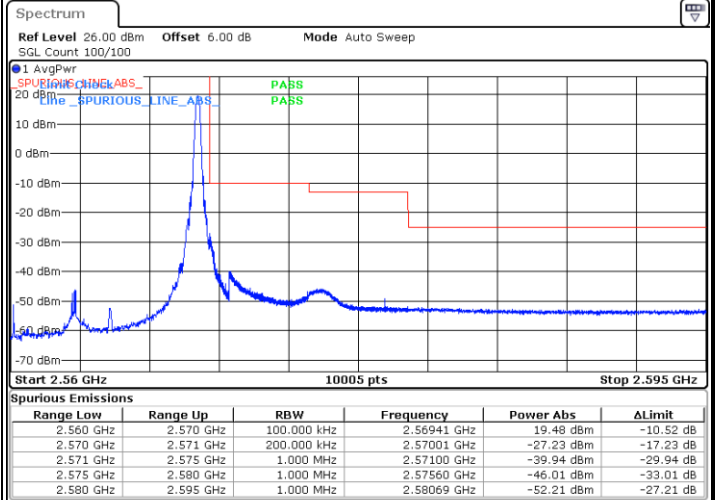

Date: 30.JAN.2021 12:11:42

Lowest Band Edge / Full RB

Highest Band Edge / Full RB

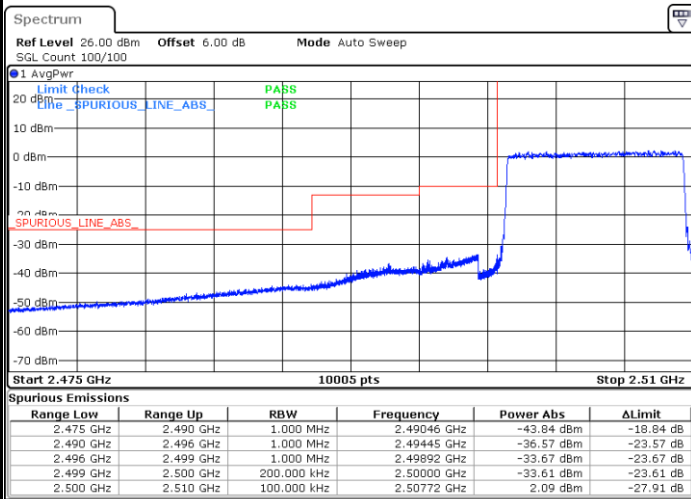

Date: 30.JAN.2021 12:10:33

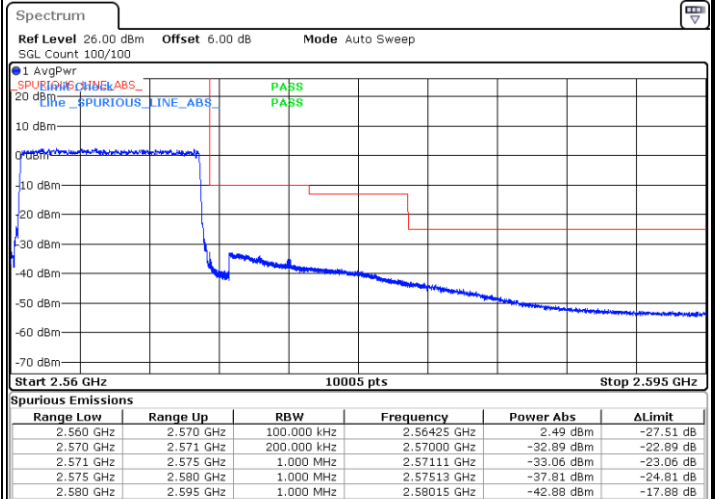

Date: 30.JAN.2021 12:12:50



LTE Band 7 / 15MHz / QPSK

Lowest Band Edge / 1 RB

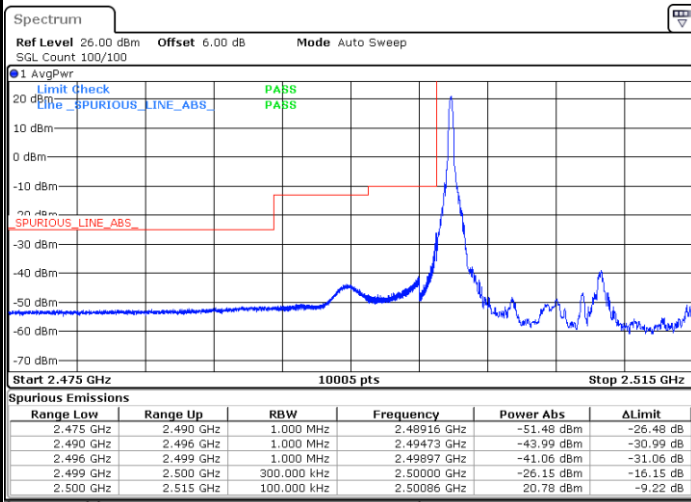

Date: 30.JAN.2021 11:44:06

Highest Band Edge / 1 RB

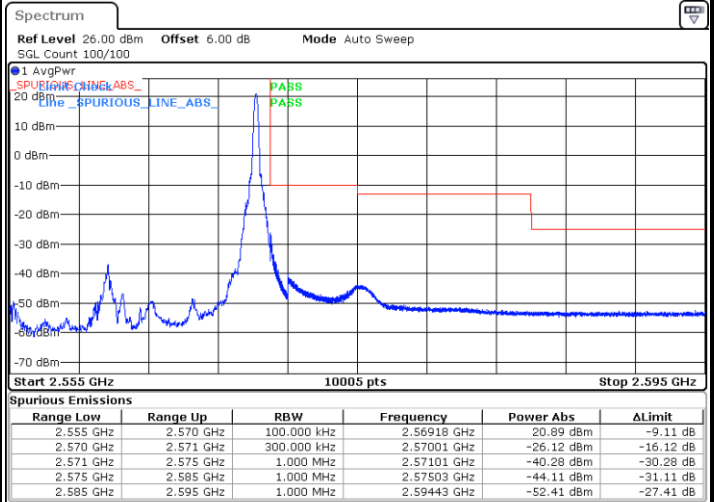

Date: 30.JAN.2021 11:52:10

Lowest Band Edge / Full RB

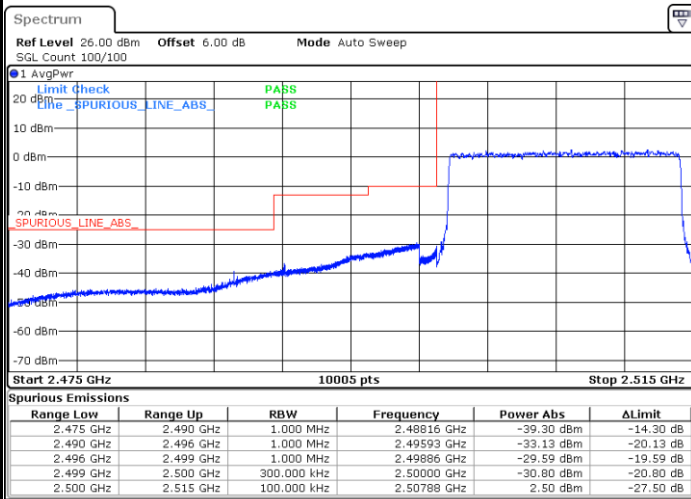

Date: 30.JAN.2021 11:47:35

Highest Band Edge / Full RB

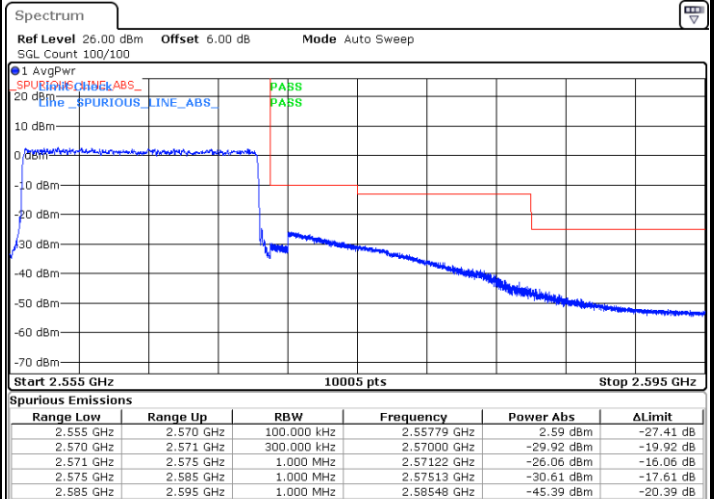

Date: 30.JAN.2021 11:48:44



LTE Band 7 / 15MHz / 16QAM

Lowest Band Edge / 1 RB

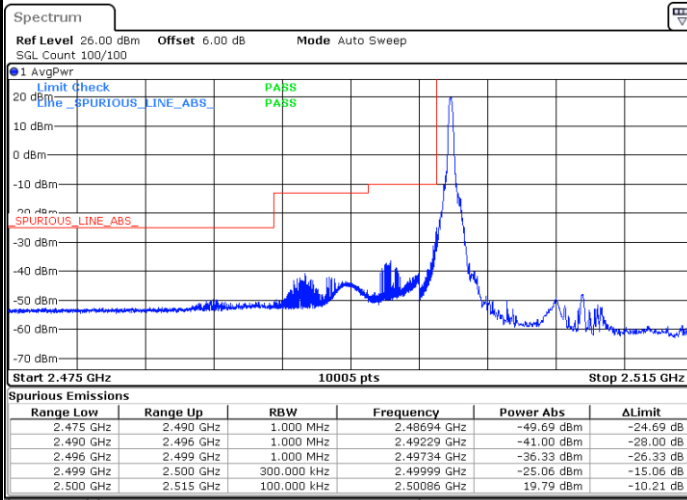

Date: 30.JAN.2021 11:45:16

Highest Band Edge / 1 RB

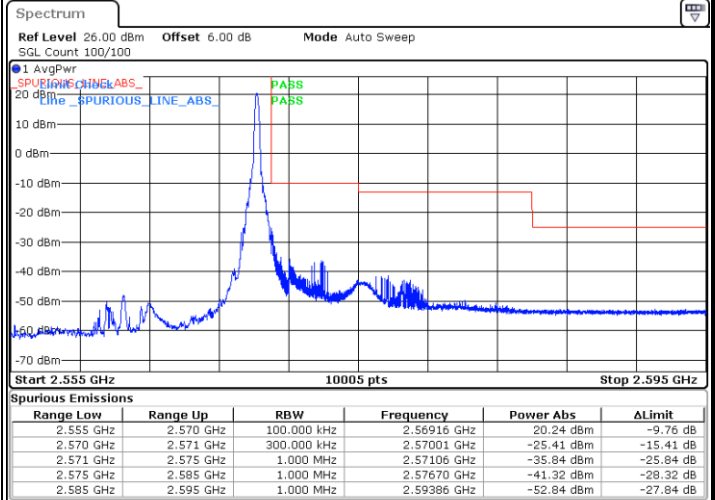

Date: 30.JAN.2021 11:51:01

Lowest Band Edge / Full RB

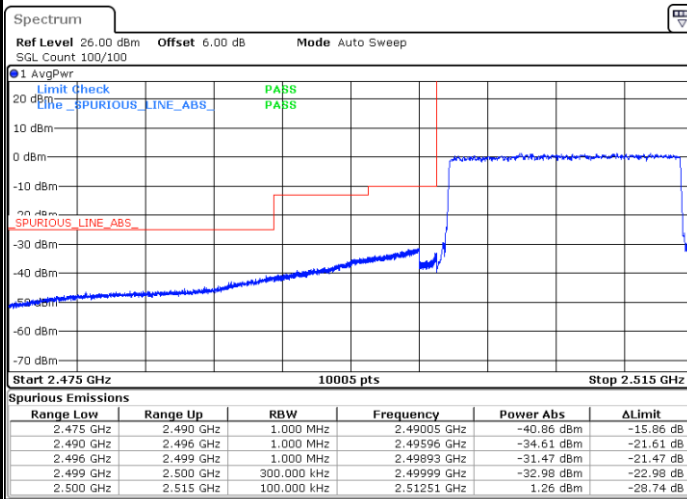

Date: 30.JAN.2021 11:46:26

Highest Band Edge / Full RB

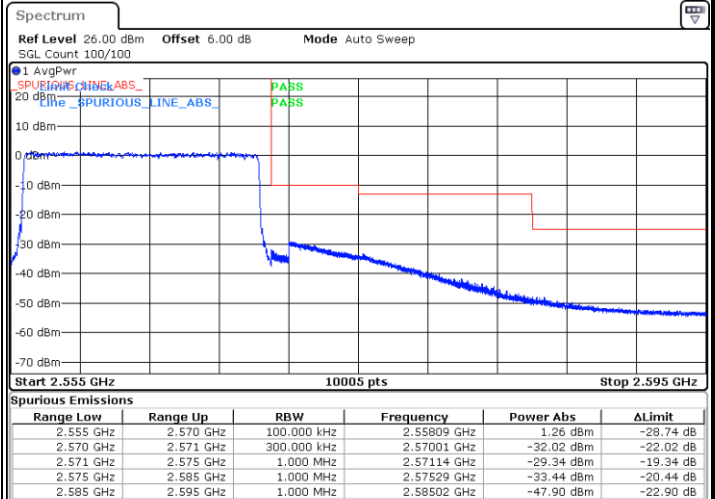

Date: 30.JAN.2021 11:49:53



LTE Band 7 / 15MHz / 64QAM

Lowest Band Edge / 1 RB

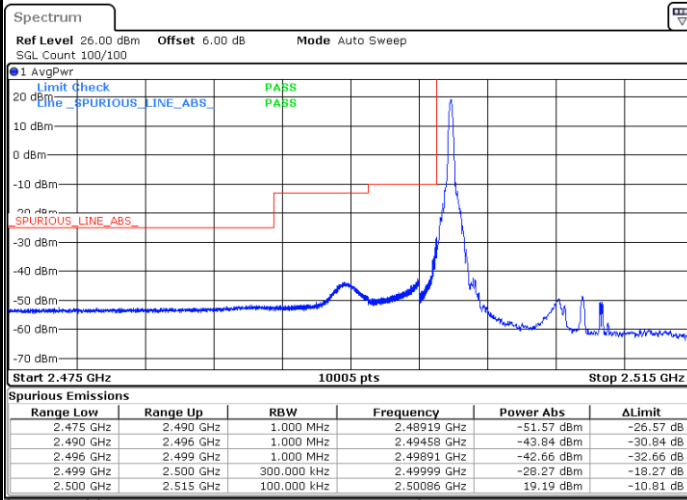

Date: 30.JAN.2021 12:15:09

Highest Band Edge / 1 RB

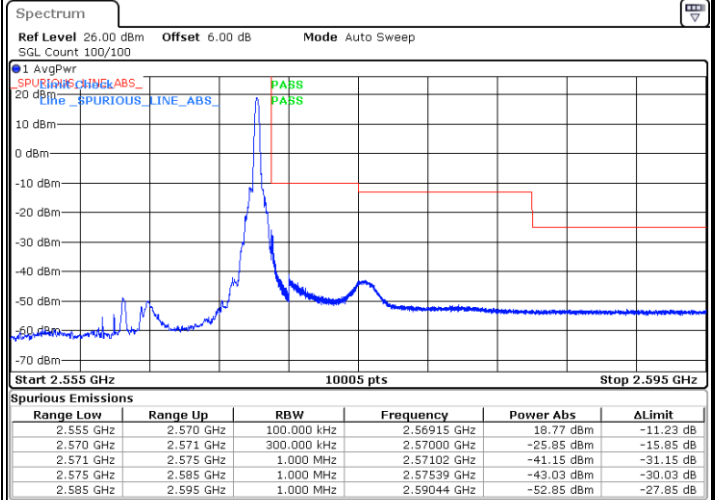

Date: 30.JAN.2021 12:17:26

Lowest Band Edge / Full RB

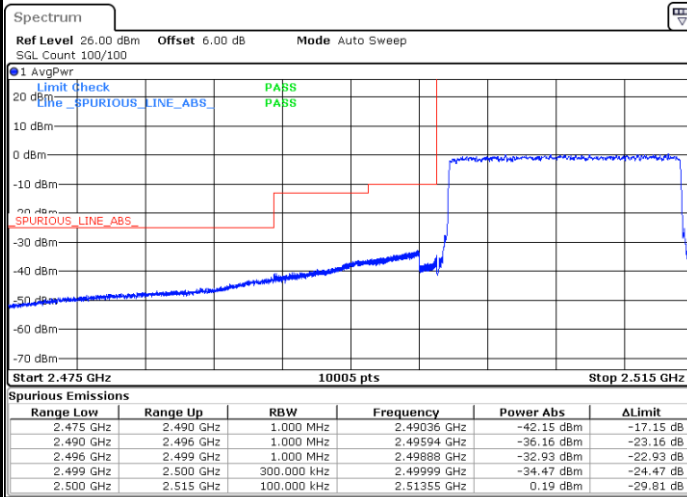

Date: 30.JAN.2021 12:14:00

Highest Band Edge / Full RB

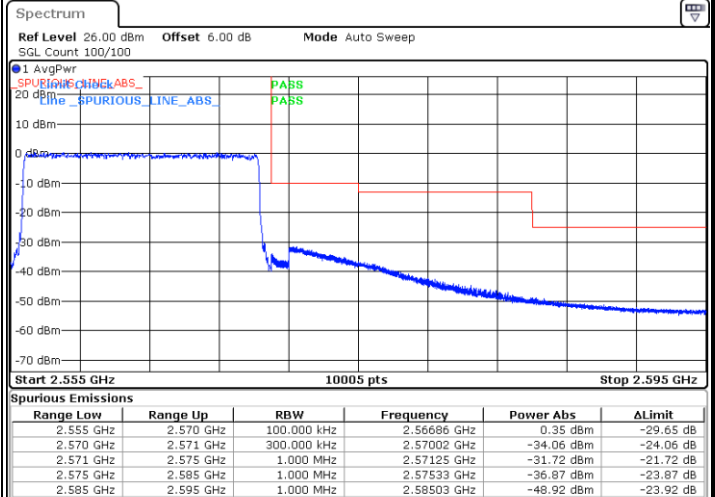

Date: 30.JAN.2021 12:16:18



LTE Band 7 / 20MHz / QPSK

Lowest Band Edge / 1 RB

Highest Band Edge / 1 RB

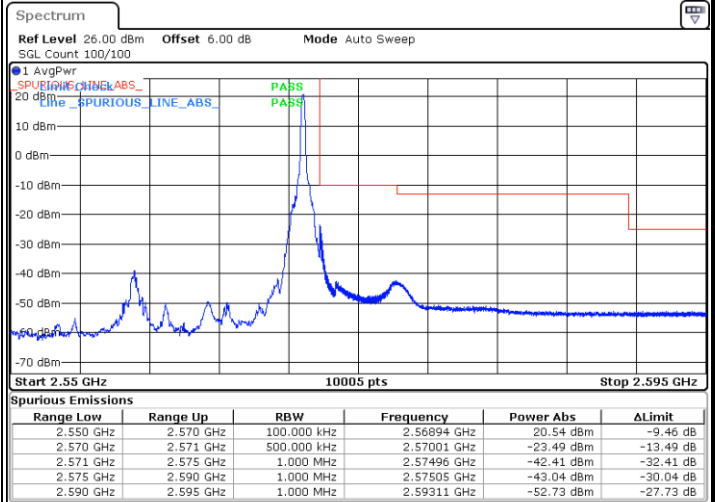
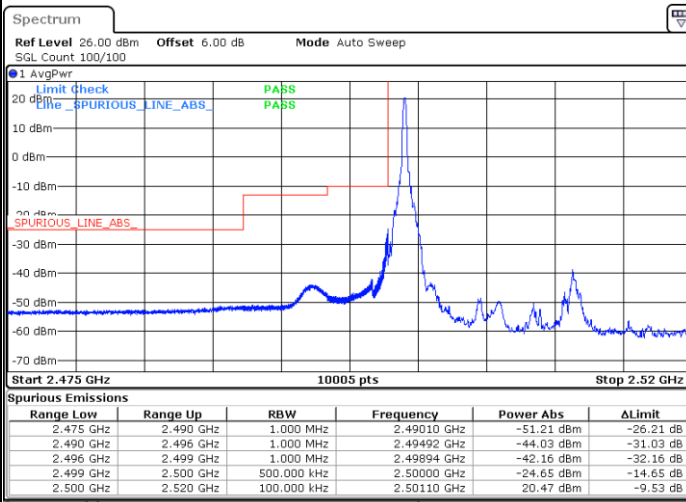

Date: 30.JAN.2021 11:53:20

Date: 30.JAN.2021 12:03:17

Lowest Band Edge / Full RB

Highest Band Edge / Full RB

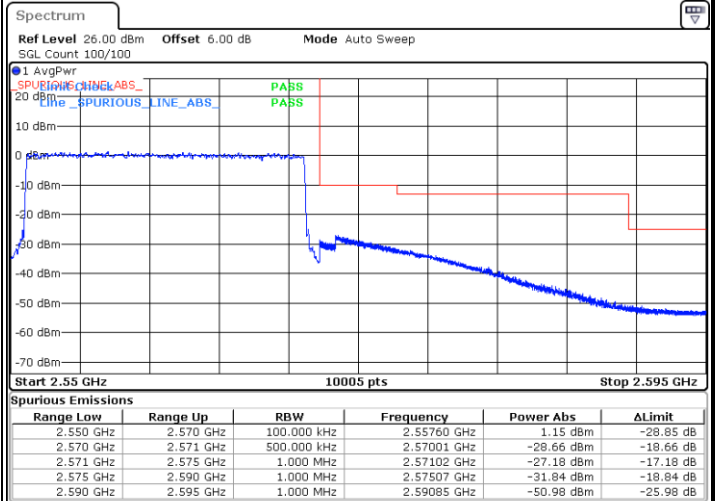
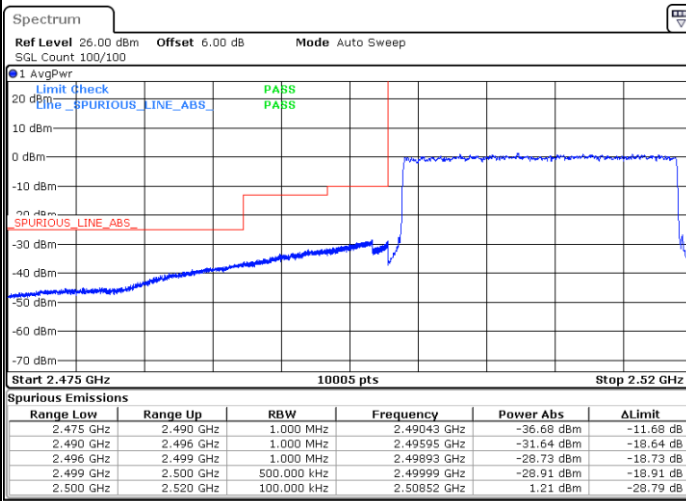

Date: 30.JAN.2021 11:58:42

Date: 30.JAN.2021 11:59:51



LTE Band 7 / 20MHz / 16QAM

Lowest Band Edge / 1 RB

Highest Band Edge / 1 RB

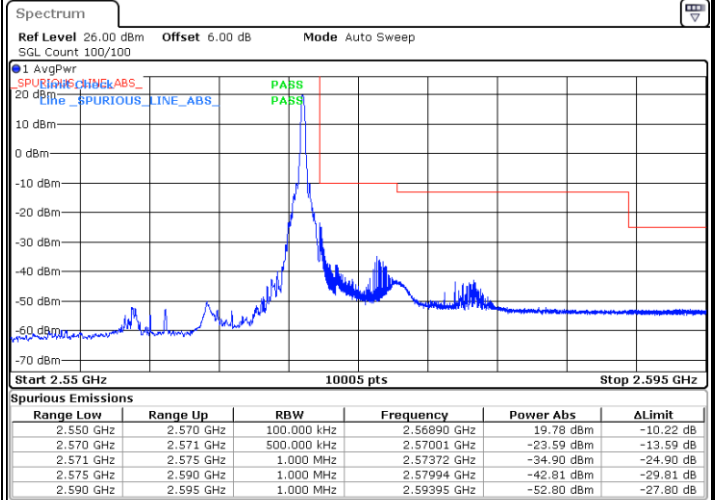
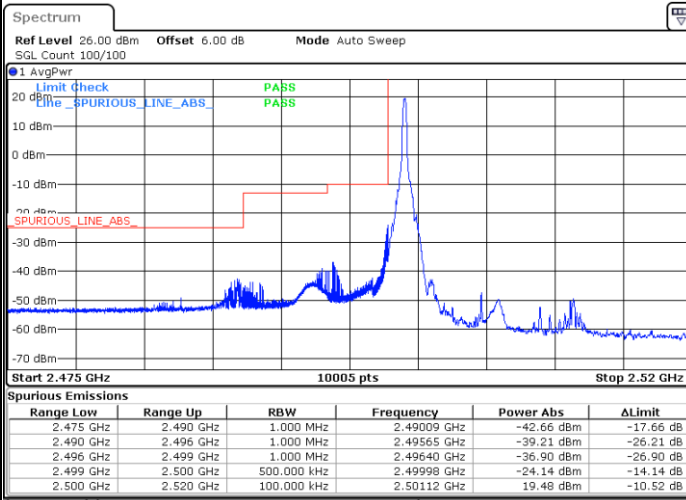

Date: 30.JAN.2021 11:54:29

Date: 30.JAN.2021 12:02:08

Lowest Band Edge / Full RB

Highest Band Edge / Full RB

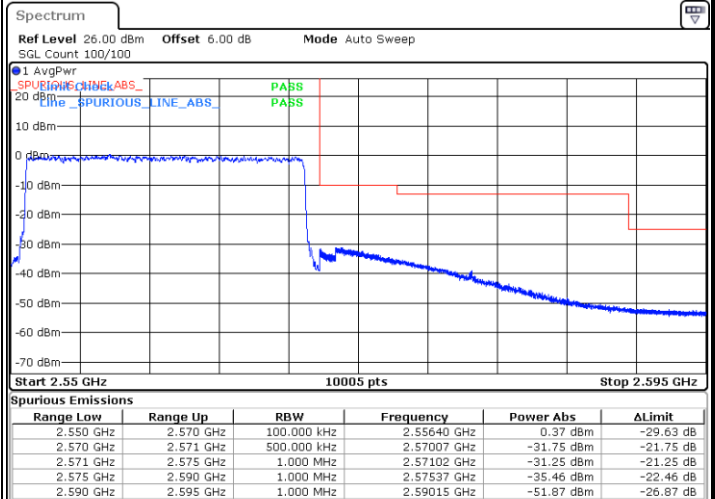
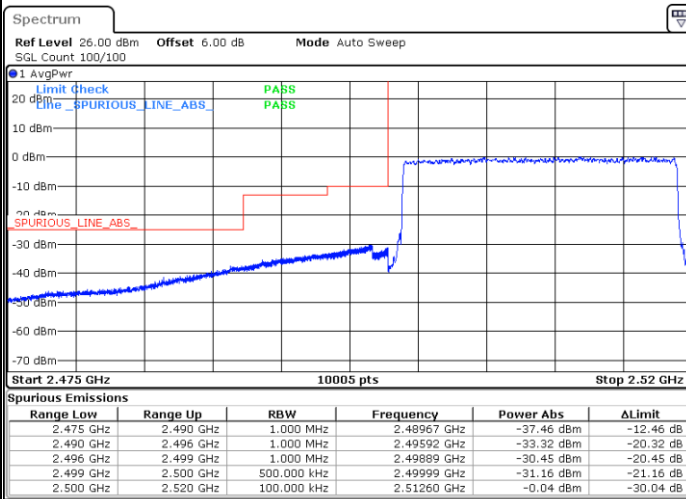

Date: 30.JAN.2021 11:55:38

Date: 30.JAN.2021 12:00:59



LTE Band 7 / 20MHz / 64QAM

Lowest Band Edge / 1 RB

Highest Band Edge / 1 RB

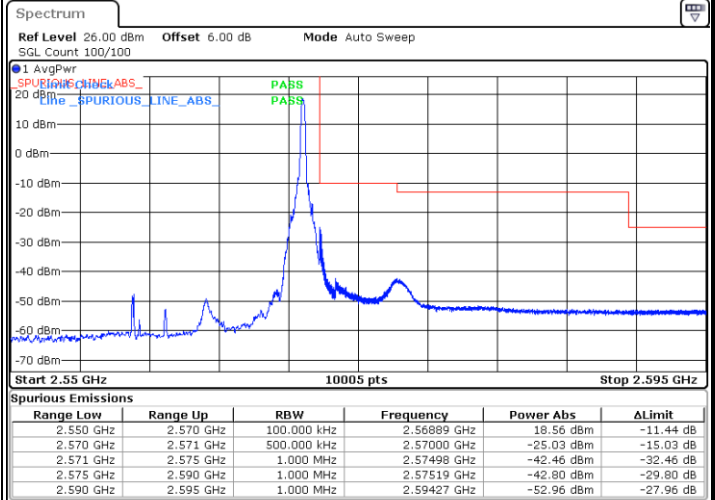
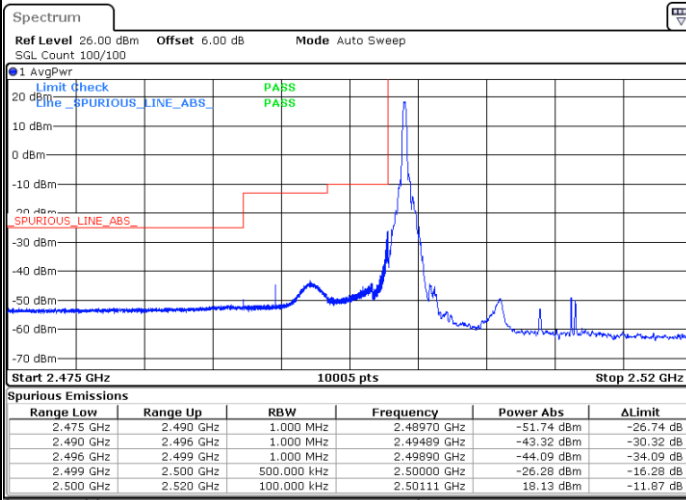

Date: 30.JAN.2021 12:19:45

Date: 30.JAN.2021 12:22:03

Lowest Band Edge / Full RB

Highest Band Edge / Full RB

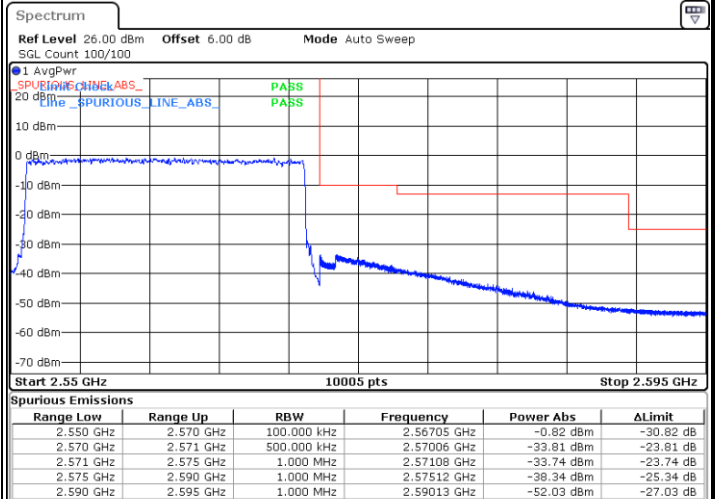
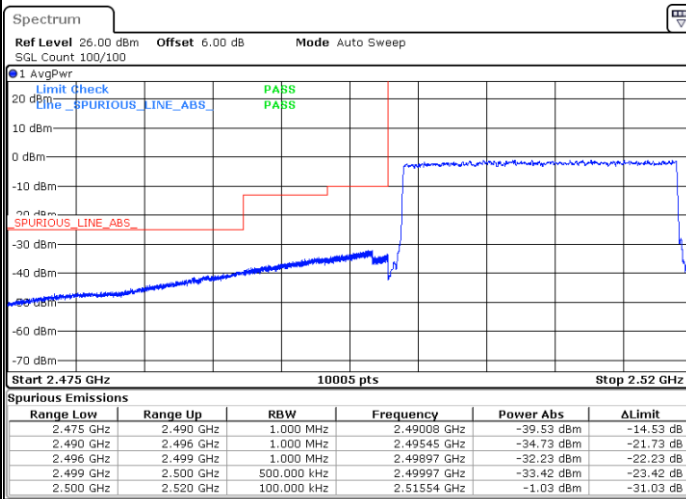

Date: 30.JAN.2021 12:18:36

Date: 30.JAN.2021 12:20:54



Conducted Spurious Emission

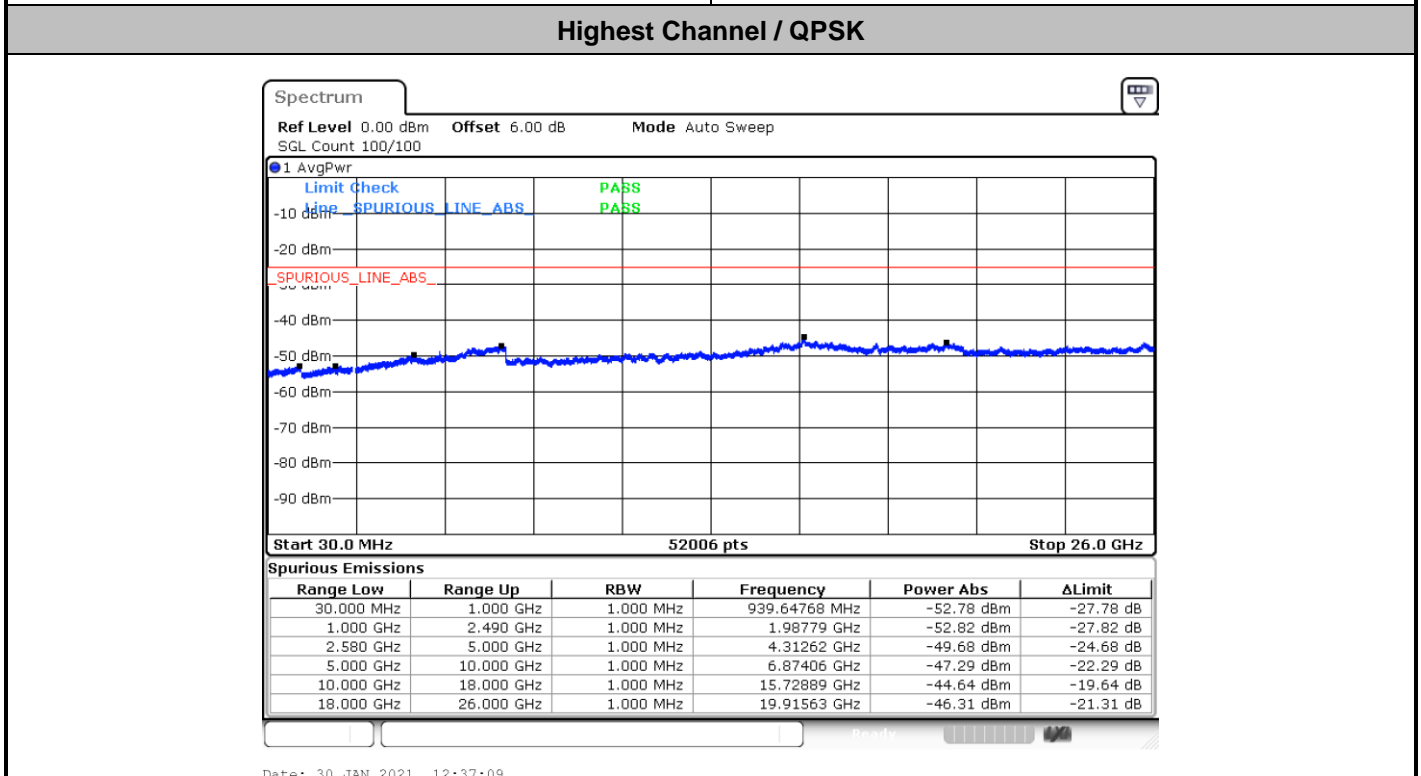
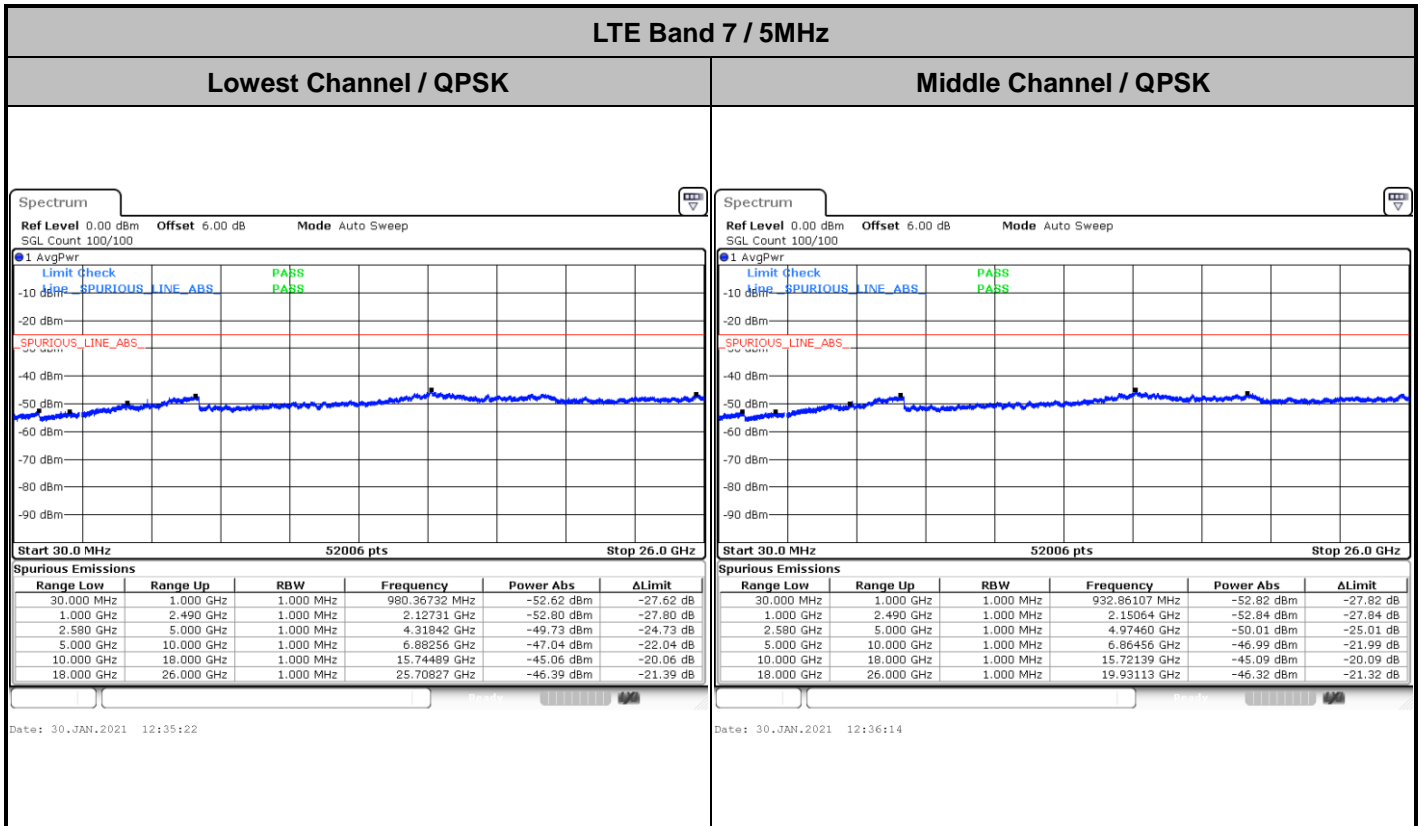



LTE Band 7 / 10MHz

Lowest Channel / QPSK

Middle Channel / QPSK

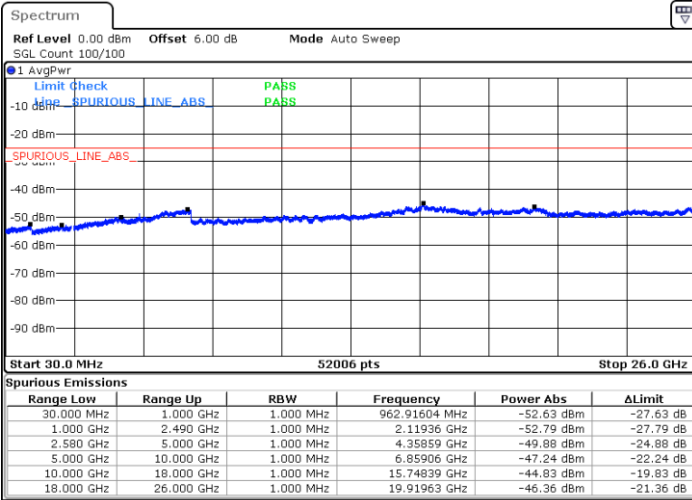

Date: 30.JAN.2021 12:29:14

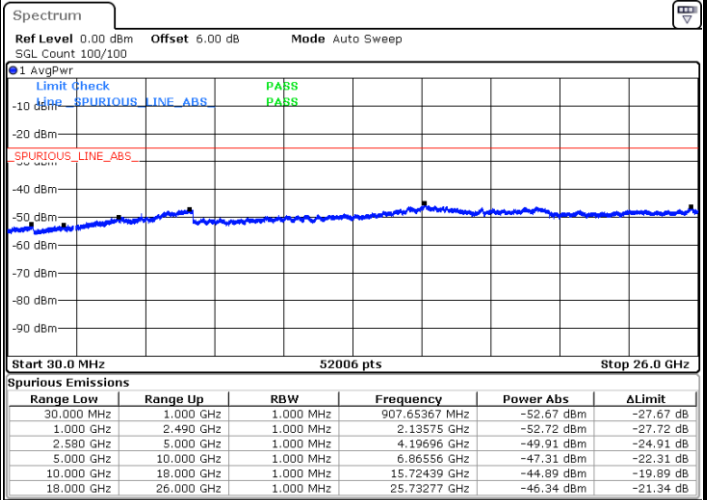

Date: 30.JAN.2021 12:33:27

Highest Channel / QPSK

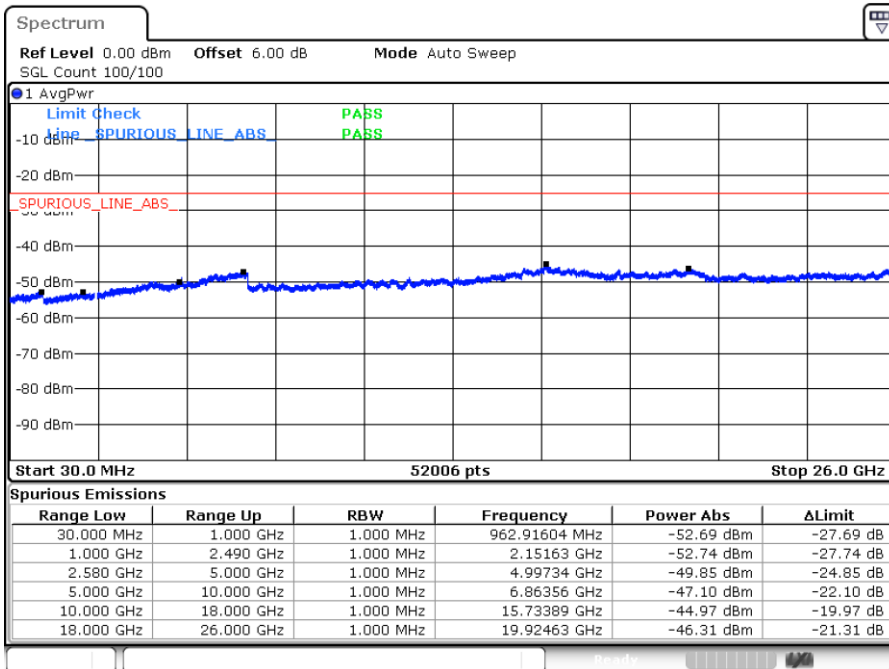

Date: 30.JAN.2021 12:34:19



LTE Band 7 / 15MHz

Lowest Channel / QPSK

Middle Channel / QPSK

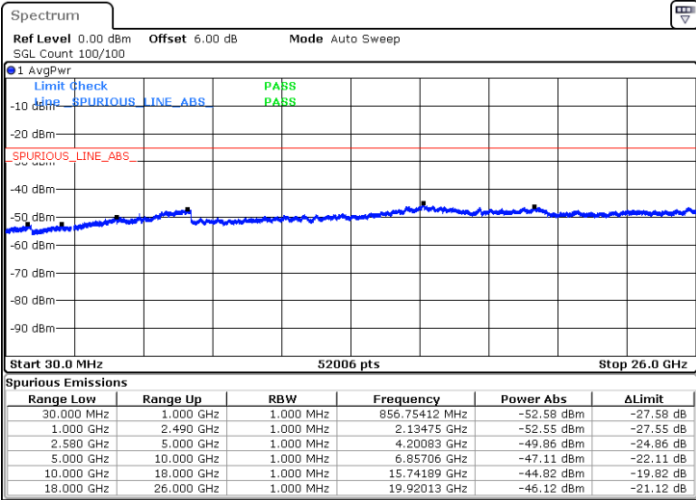

Date: 30.JAN.2021 12:26:28

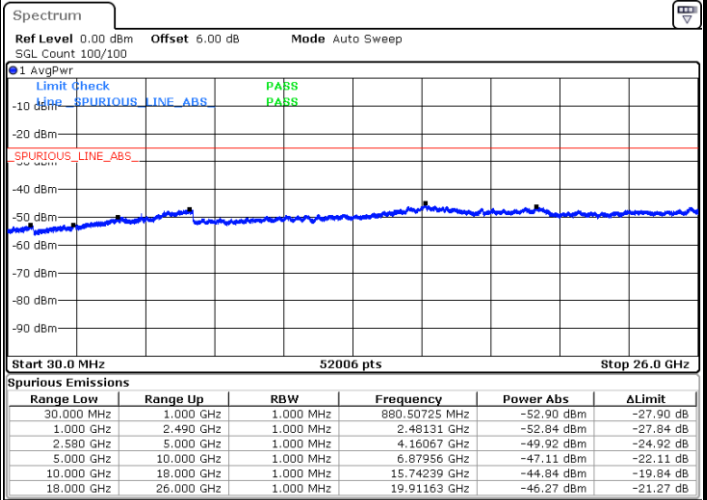

Date: 30.JAN.2021 12:27:25

Highest Channel / QPSK

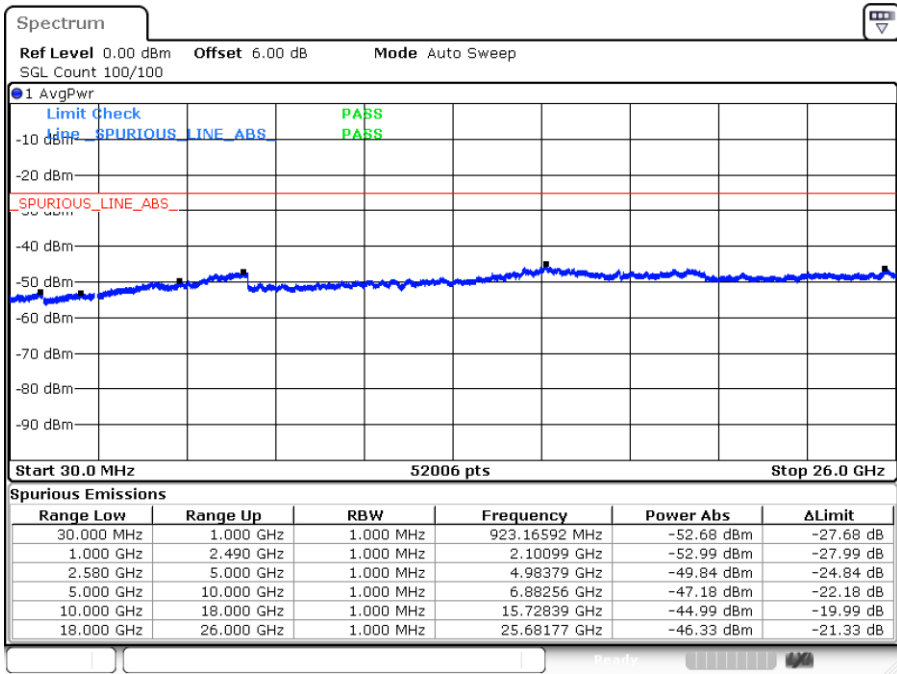

Date: 30.JAN.2021 12:28:16



LTE Band 7 / 20MHz

Lowest Channel / QPSK

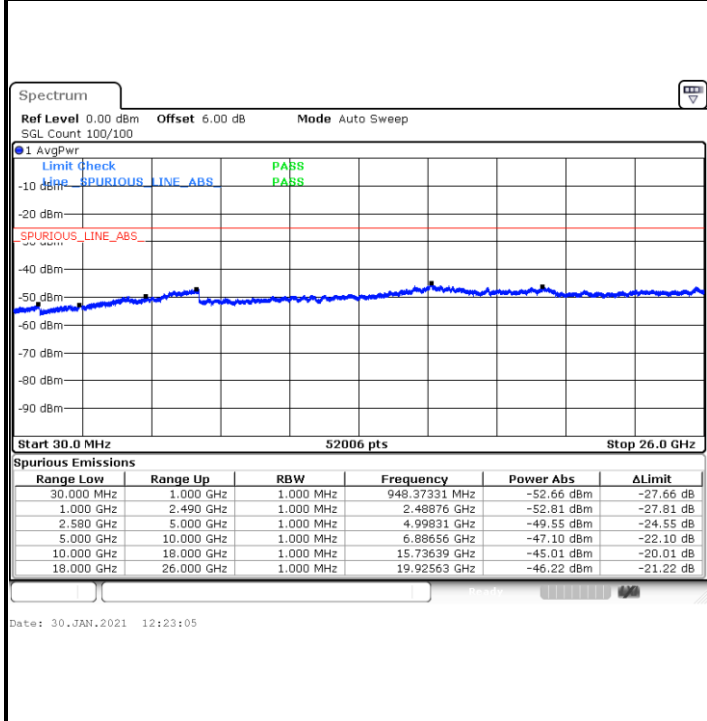

Middle Channel / QPSK

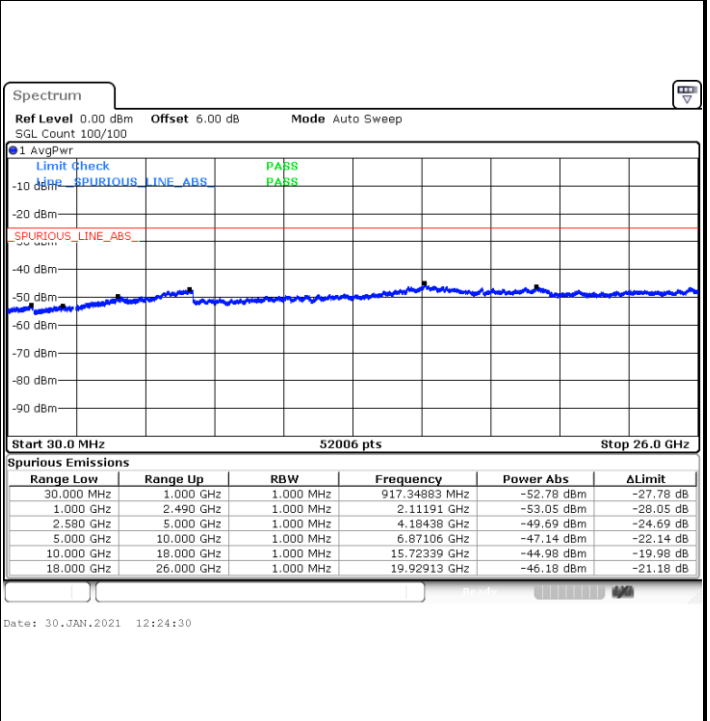

Highest Channel / QPSK

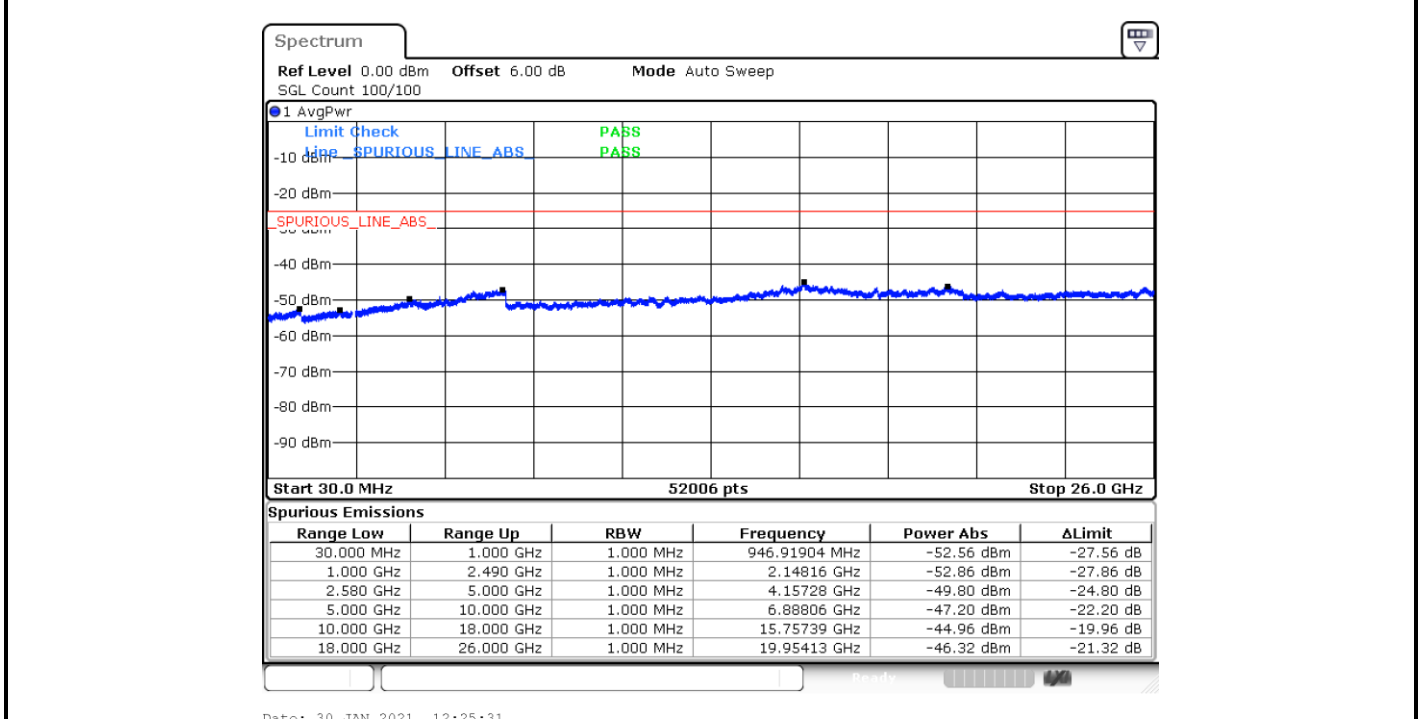



Frequency Stability

Test Conditions		LTE Band 7 (QPSK) / Middle Channel	Limit
Temperature (°C)	Voltage (Volt)	BW 20MHz	Note 2.
		Deviation (ppm)	Result
50	Normal Voltage	0.0006	PASS
40	Normal Voltage	0.0011	
30	Normal Voltage	0.0008	
20(Ref.)	Normal Voltage	0.0000	
10	Normal Voltage	0.0003	
0	Normal Voltage	0.0024	
-10	Normal Voltage	0.0007	
-20	Normal Voltage	0.0006	
-30	Normal Voltage	0.0016	
20	Maximum Voltage	0.0033	
20	Normal Voltage	0.0000	
20	Battery End Point	0.0004	

Note:

1. Normal Voltage =3.8 V. ; Battery End Point (BEP) =3.4 V. ; Maximum Voltage =4.4V.
2. Note: The frequency fundamental emissions stay within the authorized frequency block.



LTE Band 41

Peak-to-Average Ratio

Mode	LTE Band 41 / 20MHz			
Mod.	QPSK	16QAM	64QAM	Limit: 13dB
RB Size	Full RB	Full RB	Full RB	Result
Middle CH	6.23	6.14	6.12	PASS

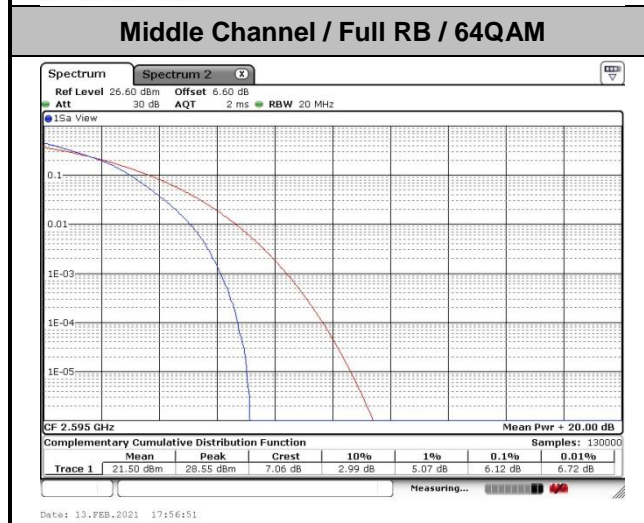
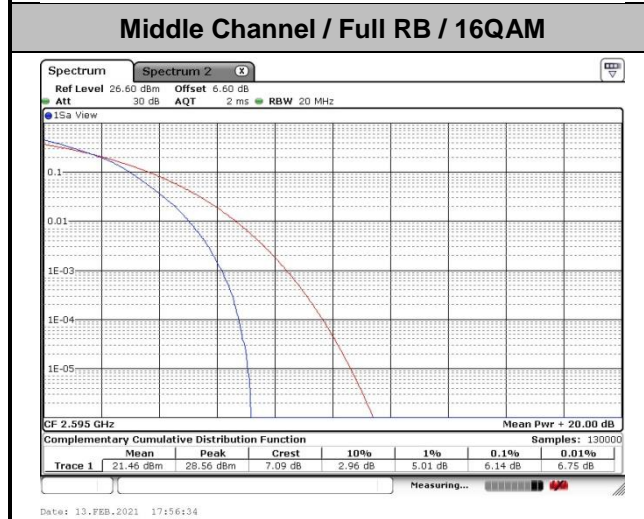
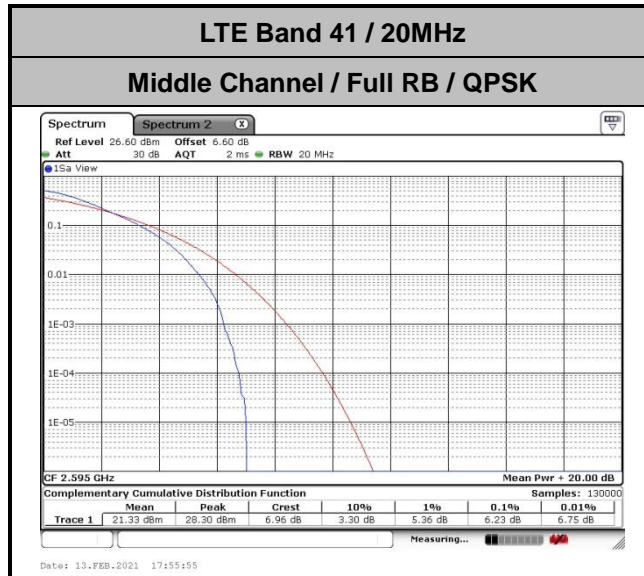



26dB Bandwidth

Mode	LTE Band 41 : 26dB BW(MHz)	
BW	20MHz	
Mod.	QPSK	16QAM
Middle CH	20.06	20.14

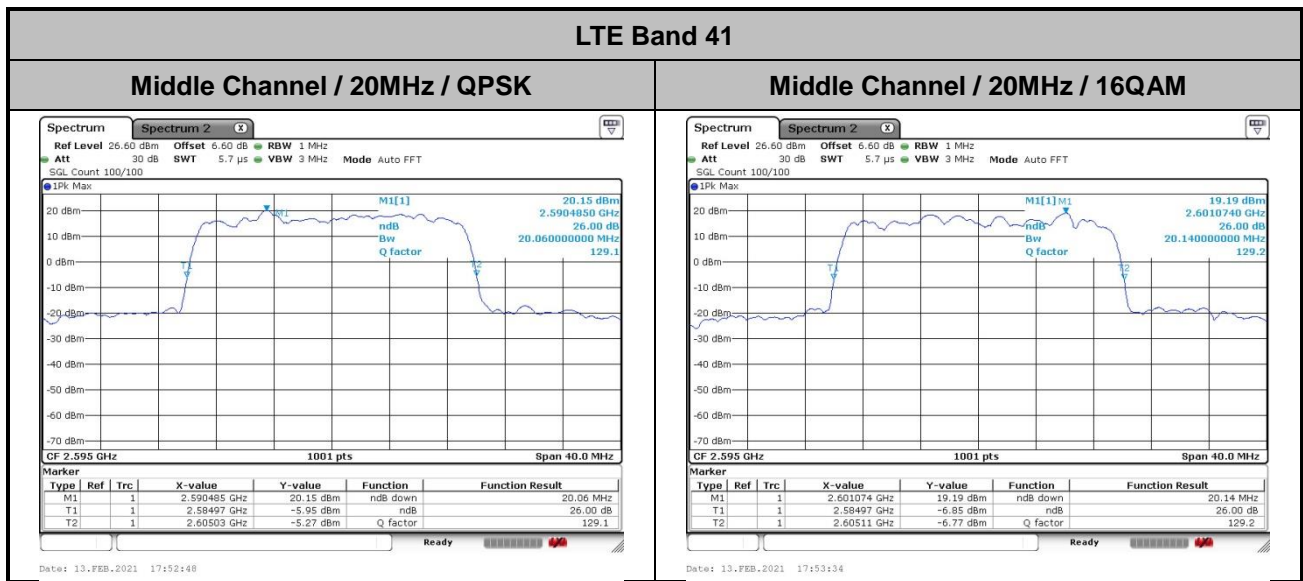



Occupied Bandwidth

Mode	LTE Band 41 : 99%OBW(MHz)	
BW	20MHz	
Mod.	QPSK	16QAM
Middle CH	18.38	18.34

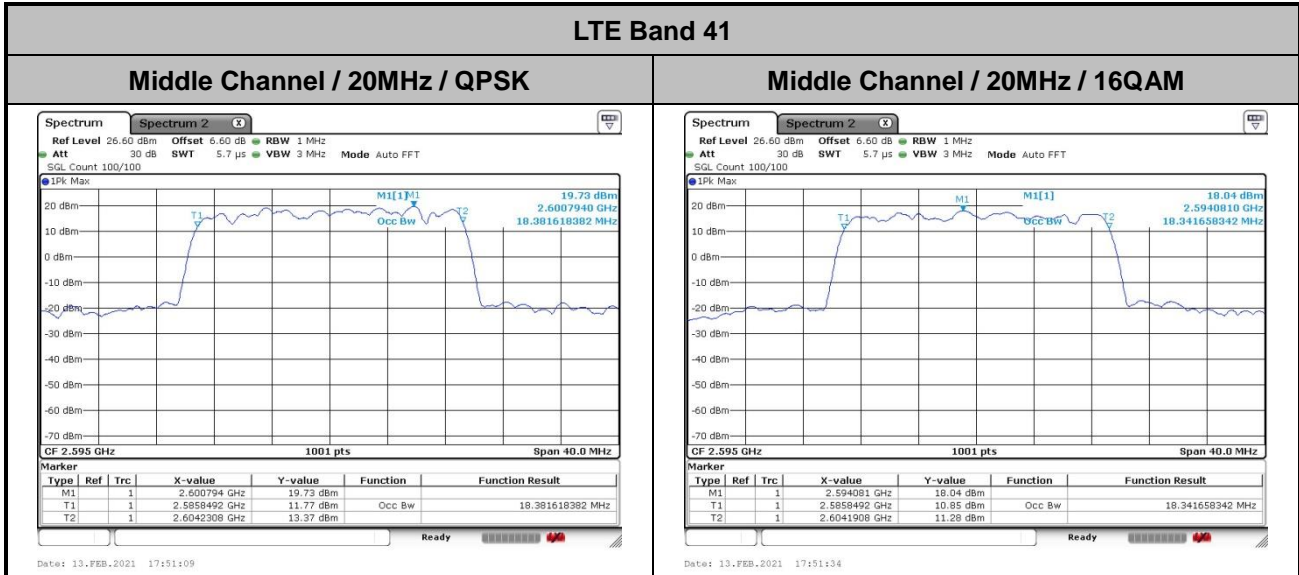



Conducted Band Edge

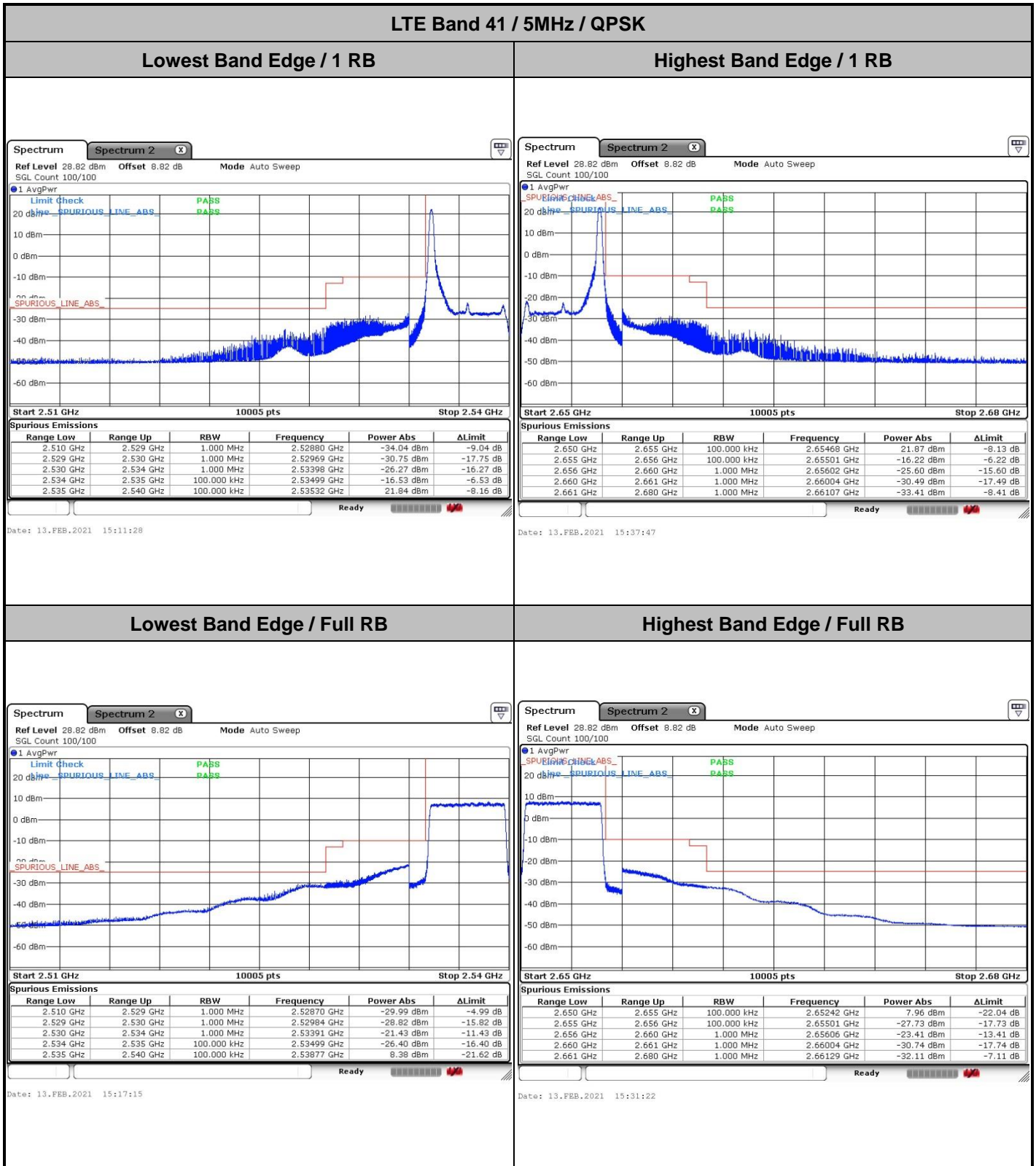



LTE Band 41 / 5MHz / 16QAM

Lowest Band Edge / 1RB

Highest Band Edge / 1 RB

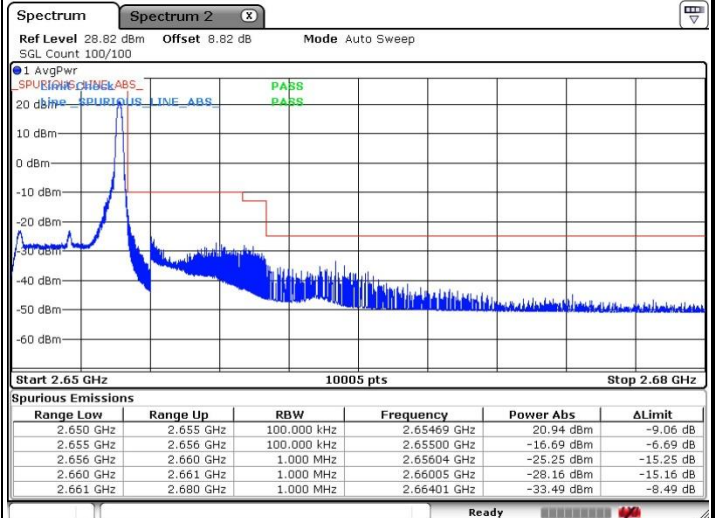
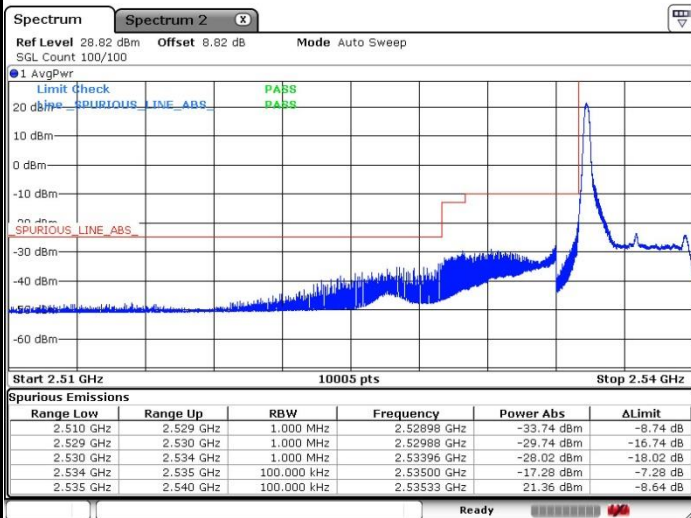

Date: 13.FEB.2021 15:12:48

Date: 13.FEB.2021 15:35:46

Lowest Band Edge / Full RB

Highest Band Edge / Full RB

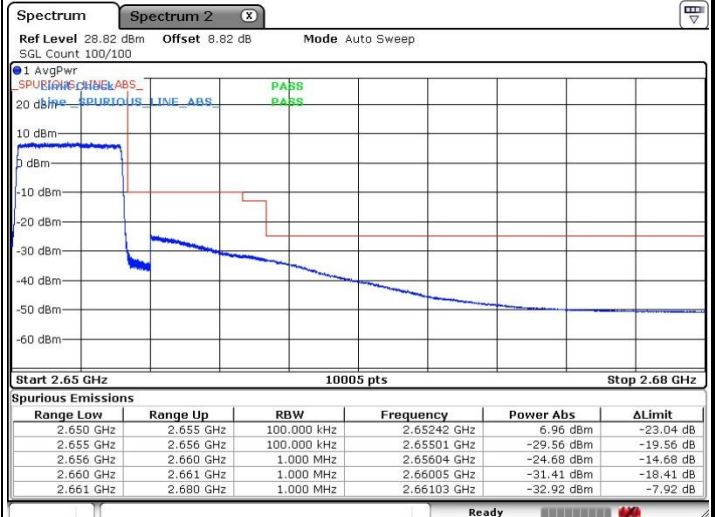
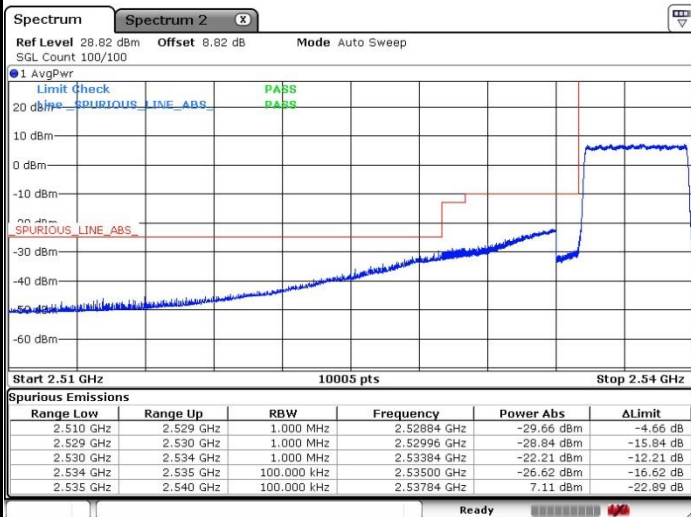

Date: 13.FEB.2021 15:16:15

Date: 13.FEB.2021 15:32:26