



FCC RF Test Report

APPLICANT : Motorola Mobility LLC
EQUIPMENT : Mobile Cellular Phone
BRAND NAME : Motorola
MODEL NAME : XT2137-1
FCC ID : IHDT56ZT1
STANDARD : 47 CFR Part 2, 22(H), 24(E), 27(L), 27(H), 27(F)
CLASSIFICATION : PCS Licensed Transmitter Held to Ear (PCE)

The product was received on Jan. 21 ,2021 and completely tested on Jan. 31, 2021. We, Sporton International (Kunshan) Inc., would like to declare that the tested sample has been evaluated in accordance with the procedures given in ANSI C63.26-2015 and shown compliance with the applicable technical standards.

The test results in this report apply exclusively to the tested model / sample. Without written approval of Sporton International (Kunshan) Inc., the test report shall not be reproduced except in full.

Jason Jia

Reviewed by: Jason Jia / Supervisor

James Huang

Approved by: James Huang / Manager



Sporton International (Kunshan) Inc.

No. 1098, Pengxi North Road, Kunshan Economic Development Zone Jiangsu Province 215300
People's Republic of China



TABLE OF CONTENTS

REVISION HISTORY... 3
SUMMARY OF TEST RESULT ... 4
1 GENERAL DESCRIPTION ... 6
1.1 Applicant ... 6
1.2 Manufacturer ... 6
1.3 Product Feature of Equipment Under Test ... 6
1.4 Product Specification of Equipment Under Test ... 7
1.5 Modification of EUT ... 7
1.6 Maximum ERP/EIRP Power, Frequency Tolerance, and Emission Designator ... 8
1.7 Testing Location ... 10
1.8 Test Software ... 10
1.9 Applicable Standards ... 10
2 TEST CONFIGURATION OF EQUIPMENT UNDER TEST ... 11
2.1 Test Mode ... 11
2.2 Connection Diagram of Test System ... 13
2.3 Support Unit used in test configuration and system ... 13
2.4 Measurement Results Explanation Example ... 13
2.5 Frequency List of Low/Middle/High Channels ... 14
3 CONDUCTED TEST ITEMS ... 17
3.1 Measuring Instruments ... 17
3.2 Test Setup ... 17
3.3 Test Result of Conducted Test ... 17
3.4 Conducted Output Power and ERP/EIRP ... 18
3.5 Peak-to-Average Ratio ... 19
3.6 Occupied Bandwidth ... 20
3.7 Conducted Band Edge ... 21
3.8 Conducted Spurious Emission ... 23
3.9 Frequency Stability ... 24
4 RADIATED TEST ITEMS ... 25
4.1 Measuring Instruments ... 25
4.2 Test Setup ... 25
4.3 Test Result of Radiated Test ... 25
4.4 Radiated Spurious Emission ... 26
5 LIST OF MEASURING EQUIPMENT ... 27
6 UNCERTAINTY OF EVALUATION ... 28
APPENDIX A. TEST RESULTS OF CONDUCTED TEST
APPENDIX B. TEST RESULTS OF RADIATED TEST
APPENDIX C. TEST SETUP PHOTOGRAPHS



REVISION HISTORY

REPORT NO.	VERSION	DESCRIPTION	ISSUED DATE
FG112101B	Rev. 01	Initial issue of report	Feb. 26, 2021



SUMMARY OF TEST RESULT

Report Section	FCC Rule	Description	Limit	Result	Remark
3.4	§2.1046	Conducted Output Power	Reporting Only	PASS	-
	§22.913(a)(5)	Effective Radiated Power (Band 5) (Band 26)	ERP < 7 Watt	PASS	-
	§27.50(b)(10) §27.50(c)(10)	Effective Radiated Power (Band 12) (Band 13) (Band 17)	ERP < 3 Watt	PASS	-
	§24.232(c)	Equivalent Isotropic Radiated Power (Band 2)	EIRP < 2Watt	PASS	-
	§27.50(d)(4)	Equivalent Isotropic Radiated Power (Band 4) (Band 66)	EIRP < 1Watt	PASS	-
3.5	§24.232(d)	Peak-to-Average Ratio	<13 dB	PASS	-
3.6	§2.1049	Occupied Bandwidth	Reporting Only	PASS	-
3.7	§2.1051 §22.917(a) §24.238(a) §27.53(c)(2)(4) §27.53(g) §27.53(h)	Conducted Band Edge Measurement (Band 2) (Band 4) (Band 5) (Band 12) (Band 13) (Band 17) (Band 26) (Band 66)	< 43+10log10(P[Watts])	PASS	-
3.8	§2.1051 §22.917(a) §24.238(a) §27.53(c)(2) §27.53(g) §27.53(h)	Conducted Spurious Emission (Band 2) (Band 4) (Band 5) (Band 12) (Band 13) (Band 17) (Band 26) (Band 66)	< 43+10log10(P[Watts])	PASS	-
3.9	§2.1055 §22.355	Frequency Stability Temperature & Voltage	< 2.5 ppm for Part 22H	PASS	-
	§2.1055 §24.235 §27.54		Within Authorized Band		



Report Section	FCC Rule	Description	Limit	Result	Remark
4.4	§2.1053 §22.917(a) §24.238(a) §27.53(c)(2) §27.53(f) §27.53(g) §27.53(h)	Radiated Spurious Emission (Band 2) (Band 4) (Band 5) (Band 12) (Band 13) (Band 17) (Band 26) (Band 66)	$< 43+10\log_{10}(P[\text{Watts}])$	PASS	Under limit 21.87 dB at 1560.000 MHz

Declaration of Conformity:

The test results with all measurement uncertainty excluded are presented in accordance with the regulation limits or requirements declared by manufacturers.

Comments and Explanations:

The declared of product specification for EUT presented in the report are provided by the manufacturer, and the manufacturer takes all the responsibilities for the accuracy of product specification.



1 General Description

1.1 Applicant

Motorola Mobility LLC
222 W, Merchandise Mart Plaza, Chicago IL 60654 USA

1.2 Manufacturer

Motorola Mobility LLC
222 W, Merchandise Mart Plaza, Chicago IL 60654 USA

1.3 Product Feature of Equipment Under Test

Product Feature	
Equipment	Mobile Cellular Phone
Brand Name	Motorola
Model Name	XT2137-1
FCC ID	IHDT56ZT1
EUT supports Radios application	GSM/WCDMA/LTE/5G NR WLAN 2.4GHz 802.11b/g/n HT20 WLAN 5GHz 802.11a/n HT20/HT40 WLAN 5GHz 802.11ac VHT20/VHT40/VHT80 Bluetooth BR/EDR/LE FM Receiver / GNSS / NFC
IMEI Code	Conducted: 352355710026099/352355710026107 Radiation: 352355710024631/352355710024649
HW Version	DVT2
SW Version	RRF31.Q1-37
EUT Stage	Identical Prototype

Note: There are two types of EUT, please refer to the product equality declaration exhibit submitted. According to the difference, we choose the sample 1 to full test.



1.4 Product Specification of Equipment Under Test

Standards-related Product Specification	
Tx Frequency	LTE Band 2 : 1850 MHz ~ 1910 MHz LTE Band 4 : 1710 MHz ~ 1755 MHz LTE Band 5 : 824 MHz ~ 849 MHz LTE Band 12 : 699 MHz ~ 716 MHz LTE Band 13 : 777 MHz ~ 787 MHz LTE Band 17 : 704 MHz ~ 716 MHz LTE Band 26 : 824 MHz ~ 849 MHz LTE Band 66 : 1710 MHz ~ 1780 MHz
Rx Frequency	LTE Band 2 : 1930 MHz ~ 1990 MHz LTE Band 4 : 2110 MHz ~ 2155 MHz LTE Band 5 : 869 MHz ~ 894 MHz LTE Band 12 : 729 MHz ~ 746 MHz LTE Band 13 : 746 MHz ~ 756 MHz LTE Band 17 : 734 MHz ~ 746 MHz LTE Band 26 : 869 MHz ~ 894 MHz LTE Band 66 : 2110 MHz~ 2200 MHz
Bandwidth	LTE Band 2 : 1.4MHz / 3MHz / 5MHz / 10MHz / 15MHz / 20MHz LTE Band 4 : 1.4MHz / 3MHz / 5MHz / 10MHz / 15MHz / 20MHz LTE Band 5 : 1.4MHz / 3MHz / 5MHz / 10MHz LTE Band 12 : 1.4MHz / 3MHz / 5MHz / 10MHz LTE Band 13 : 5MHz / 10MHz LTE Band 17 : 5MHz / 10MHz LTE Band 26 : 1.4MHz / 3MHz / 5MHz / 10MHz / 15MHz LTE Band 66 : 1.4MHz / 3MHz / 5MHz / 10MHz / 15MHz / 20MHz
Maximum Output Power to Antenna	LTE Band 2 : 22.45 dBm LTE Band 4 : 22.68 dBm LTE Band 5 : 22.55 dBm LTE Band 12 : 22.78 dBm LTE Band 13 : 22.35 dBm LTE Band 17 : 22.77 dBm LTE Band 26 : 22.57 dBm LTE Band 66 : 22.69 dBm
Antenna Gain	LTE Band 2 : -1.30 dBi LTE Band 4 : -1.60 dBi LTE Band 5 : -2.80 dBi LTE Band 12 : -3.90 dBi LTE Band 13 : -3.50 dBi LTE Band 17 : -3.90 dBi LTE Band 26 : -2.80 dBi LTE Band 66 : -1.60 dBi
Type of Modulation	QPSK / 16QAM / 64QAM

1.5 Modification of EUT

No modifications are made to the EUT during all test items.



1.6 Maximum ERP/EIRP Power, Frequency Tolerance, and Emission Designator

LTE Band 2		QPSK			16QAM		
BW (MHz)	Frequency Range (MHz)	Emission Designator (99%OBW)	Frequency Tolerance (ppm)	Maximum EIRP(W)	Emission Designator (99%OBW)	Frequency Tolerance (ppm)	Maximum EIRP(W)
20	1860.0 ~ 1900.0	17M9G7D	0.0028	0.1303	17M8W7D	-	0.1122
LTE Band 4		QPSK			16QAM		
BW (MHz)	Frequency Range (MHz)	Emission Designator (99%OBW)	Frequency Tolerance (ppm)	Maximum EIRP(W)	Emission Designator (99%OBW)	Frequency Tolerance (ppm)	Maximum EIRP(W)
20	1720.0 ~ 1745.0	17M9G7D	0.0033	0.1282	17M9W7D	-	0.1132
LTE Band 5		QPSK			16QAM		
BW (MHz)	Frequency Range (MHz)	Emission Designator (99%OBW)	Frequency Tolerance (ppm)	Maximum ERP(W)	Emission Designator (99%OBW)	Frequency Tolerance (ppm)	Maximum ERP(W)
10	829.0 ~ 844.0	9M01G7D	0.0027	0.0575	8M97W7D	-	0.0505
LTE Band 12		QPSK			16QAM		
BW (MHz)	Frequency Range (MHz)	Emission Designator (99%OBW)	Frequency Tolerance (ppm)	Maximum ERP(W)	Emission Designator (99%OBW)	Frequency Tolerance (ppm)	Maximum ERP(W)
10	704.0 ~ 711.0	8M97G7D	0.0102	0.0471	9M03W7D	-	0.0378
LTE Band 13		QPSK			16QAM		
BW (MHz)	Frequency Range (MHz)	Emission Designator (99%OBW)	Frequency Tolerance (ppm)	Maximum ERP(W)	Emission Designator (99%OBW)	Frequency Tolerance (ppm)	Maximum ERP(W)
10	782.0	9M07G7D	0.0034	0.0468	8M97W7D	-	0.0409
LTE Band 17		QPSK			16QAM		
BW (MHz)	Frequency Range (MHz)	Emission Designator (99%OBW)	Frequency Tolerance (ppm)	Maximum ERP(W)	Emission Designator (99%OBW)	Frequency Tolerance (ppm)	Maximum ERP(W)
10	709.0 ~ 711.0	8M97G7D	0.0102	0.0470	9M03W7D	-	0.0410
LTE Band 26		QPSK			16QAM		
BW (MHz)	Frequency Range (MHz)	Emission Designator (99%OBW)	Frequency Tolerance (ppm)	Maximum ERP(W)	Emission Designator (99%OBW)	Frequency Tolerance (ppm)	Maximum ERP(W)
15	831.5 ~ 841.5	13M4G7D	0.0027	0.0578	13M4W7D	-	0.0501
CH26765	821.5	13M5G7D	-	0.0546	13M4W7D	-	0.0467



LTE Band 66		QPSK			16QAM		
BW (MHz)	Frequency Range (MHz)	Emission Designator (99%OBW)	Frequency Tolerance (ppm)	Maximum EIRP(W)	Emission Designator (99%OBW)	Frequency Tolerance (ppm)	Maximum EIRP(W)
20	1720.0 ~ 1770.0	17M9G7D	0.0033	0.1285	17M9W7D	-	0.1045

Note:

1. LTE Band 26 overlaps the entire frequency range of LTE Band 5. Therefore, the test results provided in this report covers Band 26 as well as Band 5.
2. LTE Band 66 overlaps the entire frequency range of LTE Band 4. Therefore, the test results provided in this report covers Band 66 as well as Band 4.
3. LTE Band 12 overlaps the entire frequency range of LTE Band 17. Therefore, the test results provided in this report covers Band 12 as well as Band 17.



1.7 Testing Location

Sporton International (Kunshan) Inc. is accredited to ISO/IEC 17025:2017 by American Association for Laboratory Accreditation with Certificate Number 5145.02.

Test Firm	Sporton International (Kunshan) Inc.		
Test Site Location	No. 1098, Pengxi North Road, Kunshan Economic Development Zone Jiangsu Province 215300 People's Republic of China TEL : +86-512-57900158 FAX : +86-512-57900958		
Test Site No.	Sporton Site No.	FCC Designation No.	FCC Test Firm Registration No.
	03CH06-KS TH01-KS	CN1257	314309

1.8 Test Software

Item	Site	Manufacturer	Name	Version
1.	03CH06-KS	AUDIX	E3	6.2009-8-24al

1.9 Applicable Standards

According to the specifications of the manufacturer, the EUT must comply with the requirements of the following standards:

- ♦ 47 CFR Part 2, 22(H), 24(E), 27(L), 27(H), 27(F)
- ♦ ANSI C63.26-2015
- ♦ FCC KDB 971168 D01 Power Meas License Digital Systems v03r01
- ♦ FCC KDB 412172 D01 Determining ERP and EIRP v01r01

Remark:

1. All test items were verified and recorded according to the standards and without any deviation during the test.
2. This EUT has also been tested and complied with the requirements of FCC Part 15, Subpart B, recorded in a separate test report.



2 Test Configuration of Equipment Under Test

2.1 Test Mode

Antenna port conducted and radiated test items listed below are performed according to KDB 971168 D01 Power Meas License Digital Systems v03r01 with maximum output power.

Radiated measurements are performed by rotating the EUT in three different orthogonal test planes to find the maximum emission.

Test Items	Band	Bandwidth (MHz)						Modulation			RB #			Test Channel		
		1.4	3	5	10	15	20	QPSK	16QAM	64QAM	1	Half	Full	L	M	H
Max. Output Power	2	v	v	v	v	v	v	v	v	v	v	v	v	v	v	v
	4	v	v	v	v	v	v	v	v	v	v	v	v	v	v	v
	5	v	v	v	v	-	-	v	v	v	v	v	v	v	v	v
	12	v	v	v	v	-	-	v	v	v	v	v	v	v	v	v
	13	-	-	v	v	-	-	v	v	v	v	v	v	v	v	v
	17	-	-	v	v	-	-	v	v	v	v	v	v	v	v	v
	26	v	v	v	v	v	-	v	v	v	v	v	v	v	v	v
	66	v	v	v	v	v	v	v	v	v	v	v	v	v	v	v
Peak-to-Average Ratio	2						v	v	v	v			v		v	
	12				v	-	-	v	v	v			v		v	
	13	-	-		v	-	-	v	v	v			v		v	
	26					v	-	v	v	v			v		v	
	66						v	v	v	v			v		v	
26dB and 99% Bandwidth	2						v	v	v				v		v	
	12				v	-	-	v	v				v		v	
	13	-	-		v	-	-	v	v				v		v	
	26					v	-	v	v				v		v	
	66						v	v	v				v		v	
Conducted Band Edge	2	v	v	v	v	v	v	v	v	v	v		v	v		v
	12	v	v	v	v	-	-	v	v	v	v		v	v		v
	13	-	-	v		-	-	v	v	v	v		v	v		v
					v			v	v	v	v		v		v	
	26	v	v	v	v	v	-	v	v	v	v		v	v		v
	66	v	v	v	v	v	v	v	v	v	v		v	v		v



Test Items	Band	Bandwidth (MHz)						Modulation			RB #			Test Channel			
		1.4	3	5	10	15	20	QPSK	16QAM	64QAM	1	Half	Full	L	M	H	
Conducted Spurious Emission	2	v	v	v	v	v	v	v			v			v	v	v	
	12	v	v	v	v	-	-	v			v			v	v	v	
	13	-	-	v		-	-	v			v			v	v	v	
					v			v			v				v		
	26	v	v	v	v	v	-	v			v			v	v	v	
	66	v	v	v	v	v	v	v			v			v	v	v	
Frequency Stability	2						v	v					v		v		
	12				v	-	-	v					v		v		
	13	-	-		v	-	-	v					v		v		
	26					v	-	v					v		v		
	66						v	v					v		v		
E.R.P / E.I.R.P	2	v	v	v	v	v	v	v	v	v	v			v	v	v	
	12	v	v	v	v	-	-	v	v	v	v			v	v	v	
	13	-	-	v	v	-	-	v	v	v	v			v	v	v	
	26	v	v	v	v	v	-	v	v	v	v			v	v	v	
	66	v	v	v	v	v	v	v	v	v	v			v	v	v	
Radiated Spurious Emission	2	Worst Case														v	
	12	Worst Case														v	
	13	Worst Case														v	
	26	Worst Case														v	
	66	Worst Case														v	
Note	<ol style="list-style-type: none"> The mark "v" means that this configuration is chosen for testing The mark "-" means that this bandwidth is not supported. The device is investigated from 30MHz to 10 times of fundamental signal for radiated spurious emission test under different RB size/offset and modulations in exploratory test. Subsequently, only the worst case emissions are reported. LTE Band 26 overlaps the entire frequency range of LTE Band 5. Therefore, the test results provided in this report covers Band 26 as well as Band 5. LTE Band 66 overlaps the entire frequency range of LTE Band 4. Therefore, the test results provided in this report covers Band 66 as well as Band 4. LTE Band 12 overlaps the entire frequency range of LTE Band 17. Therefore, the test results provided in this report covers Band 12 as well as Band 17. 																

2.2 Connection Diagram of Test System

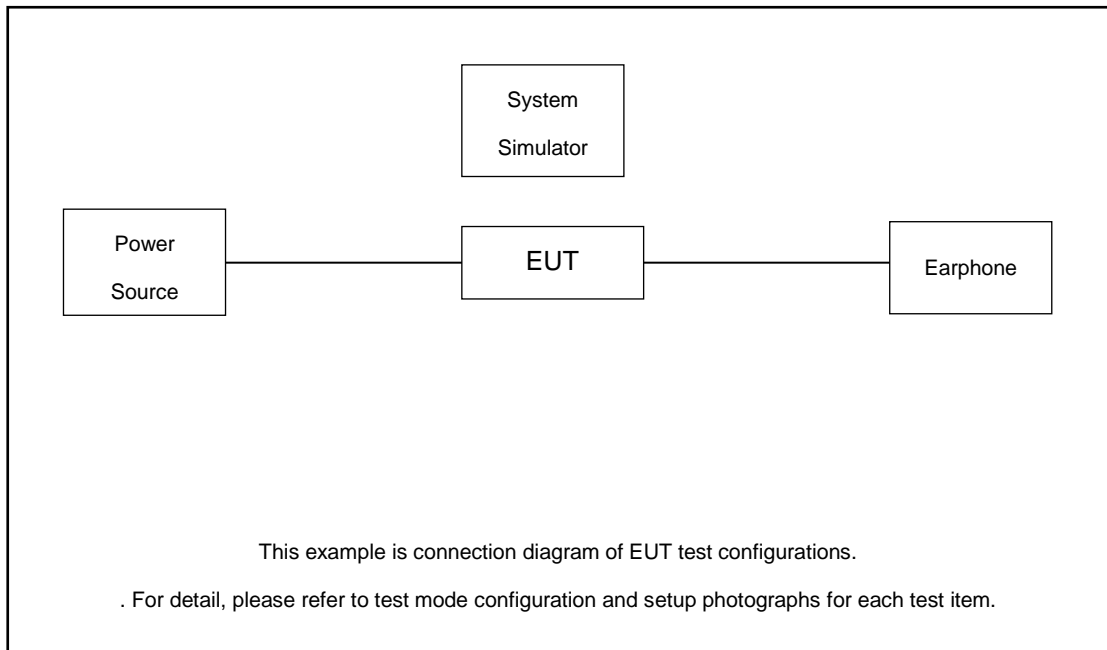

2.3 Support Unit used in test configuration and system

Item	Equipment	Trade Name	Model No.	FCC ID	Data Cable	Power Cord
1.	Power Supply	GWINSTEK	PSS-2002	N/A	N/A	Unshielded, 1.8 m
2.	LTE Base Station	Anritsu	MT8820C	N/A	N/A	Unshielded, 1.8 m

2.4 Measurement Results Explanation Example

For all conducted test items:

The offset level is set in the spectrum analyzer to compensate the RF cable loss between EUT conducted output port and spectrum analyzer. With the offset compensation, the spectrum analyzer reading level is exactly the EUT RF output level.

The spectrum analyzer offset is derived from RF cable loss.

Offset = RF cable loss.

Following shows an offset computation example with cable loss 5.4 dB.

Example :

$$\begin{aligned} \text{Offset(dB)} &= \text{RF cable loss(dB)}. \\ &= 5.4 \text{ (dB)} \end{aligned}$$



2.5 Frequency List of Low/Middle/High Channels

LTE Band 2 Channel and Frequency List				
BW [MHz]	Channel/Frequency(MHz)	Lowest	Middle	Highest
20	Channel	18700	18900	19100
	Frequency	1860	1880	1900
15	Channel	18675	18900	19125
	Frequency	1857.5	1880	1902.5
10	Channel	18650	18900	19150
	Frequency	1855	1880	1905
5	Channel	18625	18900	19175
	Frequency	1852.5	1880	1907.5
3	Channel	18615	18900	19185
	Frequency	1851.5	1880	1908.5
1.4	Channel	18607	18900	19193
	Frequency	1850.7	1880	1909.3

LTE Band 4 Channel and Frequency List				
BW [MHz]	Channel/Frequency(MHz)	Lowest	Middle	Highest
20	Channel	20050	20175	20300
	Frequency	1720	1732.5	1745
15	Channel	20025	20175	20325
	Frequency	1717.5	1732.5	1747.5
10	Channel	20000	20175	20350
	Frequency	1715	1732.5	1750
5	Channel	19975	20175	20375
	Frequency	1712.5	1732.5	1752.5
3	Channel	19965	20175	20385
	Frequency	1711.5	1732.5	1753.5
1.4	Channel	19957	20175	20393
	Frequency	1710.7	1732.5	1754.3



LTE Band 5 Channel and Frequency List				
BW [MHz]	Channel/Frequency(MHz)	Lowest	Middle	Highest
10	Channel	20450	20525	20600
	Frequency	829	836.5	844
5	Channel	20425	20525	20625
	Frequency	826.5	836.5	846.5
3	Channel	20415	20525	20635
	Frequency	825.5	836.5	847.5
1.4	Channel	20407	20525	20643
	Frequency	824.7	836.5	848.3

LTE Band 12 Channel and Frequency List				
BW [MHz]	Channel/Frequency(MHz)	Lowest	Middle	Highest
10	Channel	23060	23095	23130
	Frequency	704	707.5	711
5	Channel	23035	23095	23155
	Frequency	701.5	707.5	713.5
3	Channel	23025	23095	23165
	Frequency	700.5	707.5	714.5
1.4	Channel	23017	23095	23173
	Frequency	699.7	707.5	715.3

LTE Band 13 Channel and Frequency List				
BW [MHz]	Channel/Frequency(MHz)	Lowest	Middle	Highest
10	Channel	-	23230	-
	Frequency	-	782	-
5	Channel	23205	23230	23255
	Frequency	779.5	782	784.5



LTE Band 17 Channel and Frequency List				
BW [MHz]	Channel/Frequency(MHz)	Lowest	Middle	Highest
10	Channel	23780	23790	23800
	Frequency	709	710	711
5	Channel	23755	23790	23825
	Frequency	706.5	710	713.5

LTE Band 26 Channel and Frequency List				
BW [MHz]	Channel/Frequency(MHz)	Lowest	Middle	Highest
15	Channel	26865	26915	26965
	Frequency	831.5	836.5	841.5
10	Channel	26840	26915	26990
	Frequency	829	836.5	844
5	Channel	26815	26915	27015
	Frequency	826.5	836.5	846.5
3	Channel	26805	26915	27025
	Frequency	825.5	836.5	847.5
1.4	Channel	26797	26915	27033
	Frequency	824.7	836.5	848.3

LTE Band 66 Channel and Frequency List				
BW [MHz]	Channel/Frequency(MHz)	Lowest	Middle	Highest
20	Channel	132072	132322	132572
	Frequency	1720	1745	1770
15	Channel	132047	132322	132597
	Frequency	1717.5	1745	1772.5
10	Channel	132022	132322	132622
	Frequency	1715	1745	1775
5	Channel	131997	132322	132647
	Frequency	1712.5	1745	1777.5
3	Channel	131987	132322	132657
	Frequency	1711.5	1745	1778.5
1.4	Channel	131979	132322	132665
	Frequency	1710.7	1745	1779.3

3 Conducted Test Items

3.1 Measuring Instruments

See list of measuring instruments of this test report.

3.2 Test Setup

3.2.1 Conducted Output Power

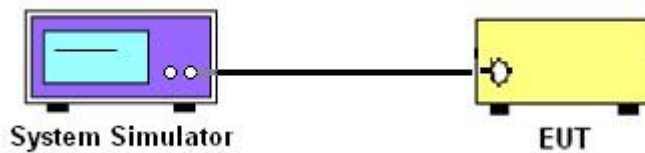

3.2.2 Peak-to-Average Ratio, Occupied Bandwidth ,Conducted Band-Edge and Conducted Spurious Emission



3.2.3 Frequency Stability

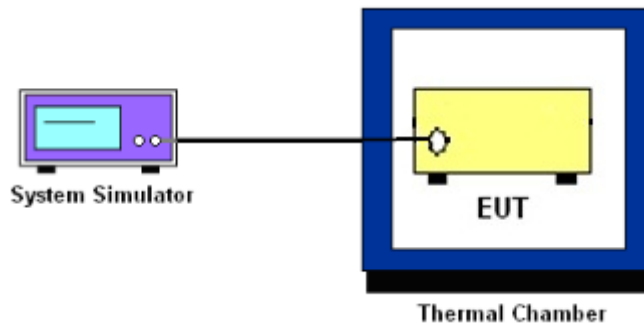

3.3 Test Result of Conducted Test

Please refer to Appendix A.



3.4 Conducted Output Power and ERP/EIRP

3.4.1 Description of the Conducted Output Power Measurement and ERP/EIRP Measurement

A system simulator was used to establish communication with the EUT. Its parameters were set to force the EUT transmitting at maximum output power. The measured power in the radio frequency on the transmitter output terminals shall be reported.

The ERP of mobile transmitters must not exceed 7 Watts for LTE Band 5 and Band 26.

The ERP of mobile transmitters must not exceed 3 Watts for LTE Band 12, Band 13 and Band 17.

The EIRP of mobile transmitters must not exceed 2 Watts for LTE Band 2.

The EIRP of mobile transmitters must not exceed 1 Watts for LTE Band 4 and Band 66.

According to KDB 412172 D01 Power Approach,

$EIRP = P_T + G_T - L_C$, $ERP = EIRP - 2.15$, where

P_T = transmitter output power in dBm

G_T = gain of the transmitting antenna in dBi

L_C = signal attenuation in the connecting cable between the transmitter and antenna in dB

3.4.2 Test Procedures

1. The testing follows ANSI C63.26 Section 5.2
2. The transmitter output port was connected to the system simulator.
3. Set EUT at maximum power through the system simulator.
4. Select lowest, middle, and highest channels for each band and different modulation.
5. Measure and record the power level from the system simulator.



3.5 Peak-to-Average Ratio

3.5.1 Description of the PAR Measurement

Power Complementary Cumulative Distribution Function (CCDF) curves provide a means for characterizing the power peaks of a digitally modulated signal on a statistical basis. A CCDF curve depicts the probability of the peak signal amplitude exceeding the average power level. Most contemporary measurement instrumentation include the capability to produce CCDF curves for an input signal provided that the instrument's resolution bandwidth can be set wide enough to accommodate the entire input signal bandwidth. In measuring transmissions in this band using an average power technique, the peak-to-average ratio (PAR) of the transmission may not exceed 13 dB.

3.5.2 Test Procedures

1. The testing follows ANSI C63.26 Section 5.2.3.4 (CCDF).
2. The EUT was connected to spectrum and system simulator via a power divider.
3. Set the CCDF (Complementary Cumulative Distribution Function) option in spectrum analyzer.
4. The highest RF powers were measured and recorded the maximum PAPR level associated with a probability of 0.1 %.
5. Record the deviation as Peak to Average Ratio.



3.6 Occupied Bandwidth

3.6.1 Description of Occupied Bandwidth Measurement

The occupied bandwidth is the width of a frequency band such that, below the lower and above the upper frequency limits, the mean powers emitted are each equal to a specified percentage 0.5% of the total mean transmitted power.

The 26 dB emission bandwidth is defined as the frequency range between two points, one above and one below the carrier frequency, at which the spectral density of the emission is attenuated 26 dB below the maximum in-band spectral density of the modulated signal. Spectral density (power per unit bandwidth) is to be measured with a detector of resolution bandwidth equal to approximately 1.0% of the emission bandwidth.

3.6.2 Test Procedures

1. The testing follows ANSI C63.26 Section 5.4
2. The EUT was connected to spectrum analyzer and system simulator via a power divider.
3. The spectrum analyzer center frequency is set to the nominal EUT channel center frequency. The span range for the spectrum analyzer shall be between two and five times the anticipated OBW.
4. The nominal resolution bandwidth (RBW) shall be in the range of 1 to 5 % of the anticipated OBW, and the VBW shall be at least 3 times the RBW.
5. Set the detection mode to peak, and the trace mode to max hold.
6. Determine the reference value: Set the EUT to transmit a modulated signal. Allow the trace to stabilize. Set the spectrum analyzer marker to the highest level of the displayed trace.
(this is the reference value)
7. Determine the “-26 dB down amplitude” as equal to (Reference Value – X).
8. Place two markers, one at the lowest and the other at the highest frequency of the envelope of the spectral display such that each marker is at or slightly below the “-X dB down amplitude” determined in step 6. If a marker is below this “-X dB down amplitude” value it shall be placed as close as possible to this value. The OBW is the positive frequency difference between the two markers.
9. Use the 99 % power bandwidth function of the spectrum analyzer and report the measured bandwidth.



3.7 Conducted Band Edge

3.7.1 Description of Conducted Band Edge Measurement

22.917(a)

For operations in the 824 – 849 MHz band, the FCC limit is $43 + 10\log_{10}(P[\text{Watts}])$ dB below the transmitter power $P(\text{Watts})$ in a 100kHz bandwidth. However, in the 1MHz bands immediately outside and adjacent to the licensee's frequency block, a resolution bandwidth of at least one percent of the emission bandwidth of the fundamental emission of the transmitter may be employed.

24.238 (a)

For operations in the 1850-1910 and 1930-1990 MHz band, the FCC limit is $43 + 10\log_{10}(P[\text{Watts}])$ dB below the transmitter power $P(\text{Watts})$ in a 1MHz bandwidth. However, in the 1 MHz bands immediately outside and adjacent to the frequency block a resolution bandwidth of at least one percent of the emission bandwidth of the fundamental emission of the transmitter may be employed.

27.53 (c)

For operations in the 776-788 MHz band, the FCC limit is $43 + 10\log_{10}(P[\text{Watts}])$ dB below the transmitter power $P(\text{Watts})$ in a 100 kHz bandwidth. However, in the 100 kHz bands immediately outside and adjacent to the frequency block, a resolution bandwidth of at least 30 kHz may be employed. In addition, the power of any unwanted emissions in any 6.25 kHz bandwidth for all frequencies between 763-775 MHz and 793-806 MHz shall be attenuated below the transmitter power, P (dBW), by at least $65 + 10 \log_{10} p(\text{watts})$, dB, for mobile and portable equipment.

27.53 (g)

For operations in the 600MHz band and 698 -746 MHz band, the FCC limit is $43 + 10\log_{10}(P[\text{Watts}])$ dB below the transmitter power $P(\text{Watts})$ in a 100 kHz bandwidth. However, in the 100 kilohertz bands immediately outside and adjacent to a licensee's frequency block, a resolution bandwidth of at least 30 kHz may be employed.

27.53 (h)

For operations in the 1710 – 1755 MHz band, the FCC limit is $43 + 10\log_{10}(P[\text{Watts}])$ dB below the transmitter power $P(\text{Watts})$ in a 1 MHz bandwidth. However, in the 1MHz bands immediately outside and adjacent to the licensee's frequency block, a resolution bandwidth of at least one percent of the emission bandwidth of the fundamental emission of the transmitter may be employed.



3.7.2 Test Procedures

1. The testing follows ANSI C63.26 section 5.7
2. The EUT was connected to spectrum analyzer and system simulator via a power divider.
3. The band edges of low and high channels for the highest RF powers were measured.
4. Set RBW \geq 1% EBW in the 1MHz band immediately outside and adjacent to the band edge.
5. Beyond the 1 MHz band from the band edge, RBW=1MHz was used.
6. Set spectrum analyzer with RMS detector.
7. The RF fundamental frequency should be excluded against the limit line in the operating frequency band.
8. Checked that all the results comply with the emission limit line.

Example:

The limit line is derived from $43 + 10\log(P)$ dB below the transmitter power P(Watts)
= P(W)- [43 + 10log(P)] (dB)
= [30 + 10log(P)] (dBm) - [43 + 10log(P)] (dB) = -13dBm.



3.8 Conducted Spurious Emission

3.8.1 Description of Conducted Spurious Emission Measurement

The power of any emission outside of the authorized operating frequency ranges must be lower than the transmitter power (P) by a factor of at least $43 + 10 \log (P)$ dB.

It is measured by means of a calibrated spectrum analyzer and scanned from 30 MHz up to a frequency including its 10th harmonic.

3.8.2 Test Procedures

1. The testing follows ANSI C63.26 section 5.7
2. The EUT was connected to spectrum analyzer and system simulator via a power divider.
3. The RF output of EUT was connected to the spectrum analyzer by RF cable and attenuator. The path loss was compensated to the results for each measurement.
4. The middle channel for the highest RF power within the transmitting frequency was measured.
5. The conducted spurious emission for the whole frequency range was taken.
6. Make the measurement with the spectrum analyzer's RBW = 1MHz, VBW = 3MHz.
7. Set spectrum analyzer with RMS detector.
8. Taking the record of maximum spurious emission.
9. The RF fundamental frequency should be excluded against the limit line in the operating frequency band.
10. The limit line is derived from $43 + 10\log(P)$ dB below the transmitter power P(Watts)
= P(W)- [43 + 10log(P)] (dB)
= [30 + 10log(P)] (dBm) - [43 + 10log(P)] (dB)
= -13dBm.



3.9 Frequency Stability

3.9.1 Description of Frequency Stability Measurement

The frequency stability shall be measured by variation of ambient temperature and variation of primary supply voltage to ensure that the fundamental emission stays within the authorized frequency block. The frequency stability of the transmitter shall be maintained within $\pm 0.00025\%$ ($\pm 2.5\text{ppm}$) of the center frequency.

3.9.2 Test Procedures for Temperature Variation

1. The testing follows ANSI C63.26 section 5.6.4
2. The EUT was set up in the thermal chamber and connected with the system simulator.
3. With power OFF, the temperature was decreased to -30°C and the EUT was stabilized before testing. Power was applied and the maximum change in frequency was recorded within one minute.
4. With power OFF, the temperature was raised in 10°C step up to 50°C . The EUT was stabilized at each step for at least half an hour. Power was applied and the maximum frequency change was recorded within one minute.

3.9.3 Test Procedures for Voltage Variation

1. The testing follows ANSI C63.26 section 5.6.5
2. The EUT was placed in a temperature chamber at $20\pm 5^{\circ}\text{C}$ and connected with the system simulator.
3. The power supply voltage to the EUT was varied from 85% to 115% of the nominal value for other than hand carried battery equipment.
4. For hand carried, battery powered equipment, reduce the primary ac or dc supply voltage to the battery operating end point, which shall be specified by the manufacturer.
5. The variation in frequency was measured for the worst case.

4 Radiated Test Items

4.1 Measuring Instruments

See list of measuring instruments of this test report.

4.2 Test Setup

4.2.1 For radiated test from 30MHz to 1GHz

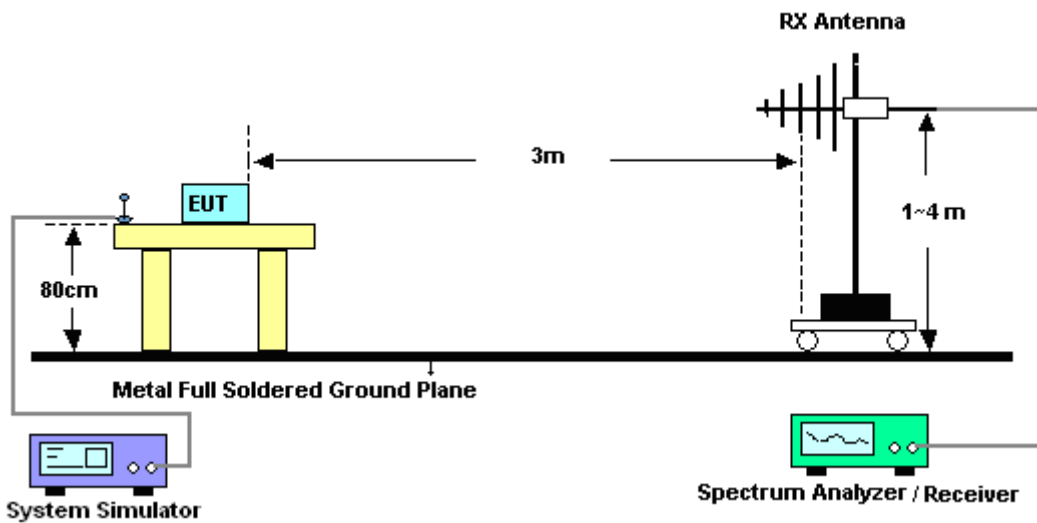

4.2.2 For radiated test above 1GHz

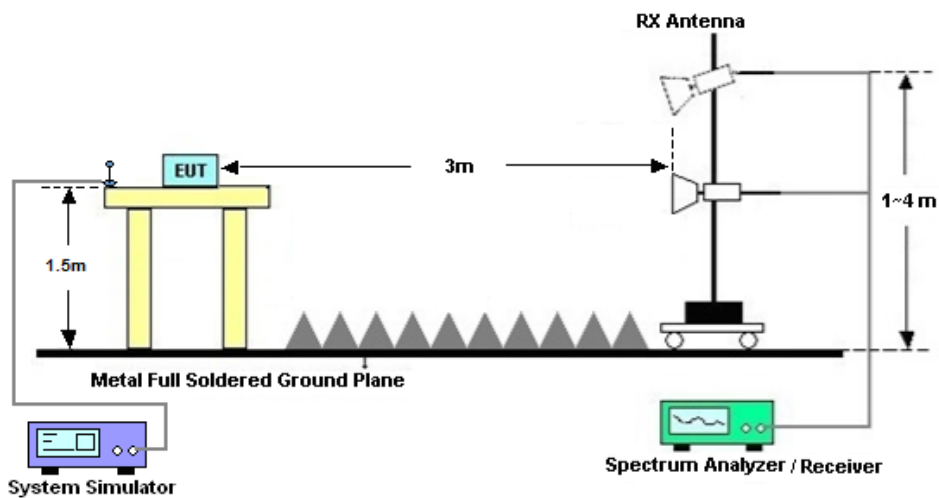

4.3 Test Result of Radiated Test

Please refer to Appendix B.



4.4 Radiated Spurious Emission

4.4.1 Description of Radiated Spurious Emission

The radiated spurious emission was measured by substitution method according to ANSI C63.26. The power of any emission outside of the authorized operating frequency ranges must be attenuated below the transmitter power (P) by a factor of at least $43 + 10 \log (P)$ dB.

For LTE Band 13

For operations in the 746-758 MHz, 775-788 MHz, and 805-806 MHz bands, emissions in the band 1559-1610 MHz shall be limited to -70 dBW/MHz equivalent isotropically radiated power (EIRP) for wideband signals, and -80 dBW EIRP for discrete emissions of less than 700 Hz bandwidth.

The spectrum is scanned from 30 MHz up to a frequency including its 10th harmonic.

4.4.2 Test Procedures

1. The testing follows ANSI C63.26 Section 5.5
2. The EUT was placed on a turntable with 0.8 meter height for frequency below 1GHz and 1.5 meter height for frequency above 1GHz respectively above ground.
3. The EUT was set 3 meters from the receiving antenna mounted on the antenna tower.
4. The table was rotated 360 degrees to determine the position of the highest spurious emission.
5. The height of the receiving antenna is varied between 1m to 4m to search the maximum spurious emission for both horizontal and vertical polarizations.
6. During the measurement, the system simulator parameters were set to force the EUT transmitting at maximum output power.
7. Make the measurement with the spectrum analyzer's RBW = 1MHz, VBW = 3MHz, taking the record of maximum spurious emission.
8. A horn antenna was substituted in place of the EUT and was driven by a signal generator.
9. Tune the output power of signal generator to the same emission level with EUT maximum spurious emission.
10. $EIRP \text{ (dBm)} = S.G. \text{ Power} - Tx \text{ Cable Loss} + Tx \text{ Antenna Gain}$
11. $ERP \text{ (dBm)} = EIRP - 2.15$
12. The RF fundamental frequency should be excluded against the limit line in the operating frequency band.

The limit line is derived from $43 + 10\log(P)$ dB below the transmitter power P(Watts)
 $= P(W) - [43 + 10\log(P)] \text{ (dB)}$
 $= [30 + 10\log(P)] \text{ (dBm)} - [43 + 10\log(P)] \text{ (dB)}$
 $= -13\text{dBm}.$



5 List of Measuring Equipment

Instrument	Manufacturer	Model No.	Serial No.	Characteristics	Calibration Date	Test Date	Due Date	Remark
Spectrum Analyzer	R&S	FSV40	101040	10Hz~40GHz	Nov. 02, 2020	Jan. 29, 2021~ Jan. 31, 2021	Nov. 01, 2021	Conducted (TH01-KS)
Thermal Chamber	Ten Billion	TTC-B3S	TBN-960502	-40~+150°C	Oct. 27, 2020	Jan. 29, 2021~ Jan. 31, 2021	Oct. 26, 2021	Conducted (TH01-KS)
EXA Spectrum Analyzer	Keysight	N9010A	MY55150208	10Hz-44GHz	Apr. 14, 2020	Jan. 30, 2021	Apr. 13, 2021	Radiation (03CH06-KS)
Bilog Antenna	TeseQ	CBL6111D	49921	30MHz-1GHz	May 29, 2020	Jan. 30, 2021	May 28, 2021	Radiation (03CH06-KS)
Double Ridge Horn Antenna	ETS-Lindgren	3117	00218652	1GHz~18GHz	Apr. 27, 2020	Jan. 30, 2021	Apr. 26, 2021	Radiation (03CH06-KS)
SHF-EHF Horn	Com-power	AH-840	101115	18GHz~40GHz	Jun. 05, 2020	Jan. 30, 2021	Jun. 04, 2021	Radiation (03CH06-KS)
Amplifier	SONOMA	310N	187289	9KHz ~1GHZ	Apr. 14, 2020	Jan. 30, 2021	Apr. 13, 2021	Radiation (03CH06-KS)
Amplifier	MITEQ	EM18G40G GA	060728	18~40GHz	Jan. 07, 2021	Jan. 30, 2021	Jan. 06, 2022	Radiation (03CH06-KS)
high gain Amplifier	MITEQ	AMF-7D-00 101800-30-1 QP	2025788	1Ghz-18Ghz	Jan. 06, 2021	Jan. 30, 2021	Jan.05, 2022	Radiation (03CH06-KS)
Amplifier	Keysight	83017A	MY53270203	500MHz~26.5GHz	Apr. 15, 2020	Jan. 30, 2021	Apr. 14, 2021	Radiation (03CH06-KS)
AC Power Source	Chroma	61601	F104090004	N/A	NCR	Jan. 30, 2021	NCR	Radiation (03CH06-KS)
Turn Table	ChamPro	EM 1000-T	060762-T	0~360 degree	NCR	Jan. 30, 2021	NCR	Radiation (03CH06-KS)
Antenna Mast	ChamPro	EM 1000-A	060762-A	1 m~4 m	NCR	Jan. 30, 2021	NCR	Radiation (03CH06-KS)

NCR: No Calibration Required



6 Uncertainty of Evaluation

The measurement uncertainties shown below were calculated in accordance with the requirements of ANSI 63.26-2015. All the measurement uncertainty value were shown with a coverage K=2 to indicate 95% level of confidence. The measurement data show herein meets or exceeds the CISPR measurement uncertainty values specified in CISPR 16-4-2 and can be compared directly to specified limit to determine compliance.

Uncertainty of Radiated Emission Measurement (30 MHz ~ 1000 MHz)

Measuring Uncertainty for a Level of Confidence of 95% (U = 2Uc(y))	2.5dB
---	-------

Uncertainty of Radiated Emission Measurement (1 GHz ~ 40 GHz)

Measuring Uncertainty for a Level of Confidence of 95% (U = 2Uc(y))	2.1dB
---	-------



Appendix A. Test Results of Conducted Test

Conducted Output Power(Average power) and ERP/EIRP

LTE Band 2:

BW [MHz]	Modulation	RB Size	RB Offset	Power Low Ch. / Freq.	Power Middle Ch. / Freq.	Power High Ch. / Freq.	EIRP		
							L	M	H
Channel				18700	18900	19100	EIRP		
Frequency (MHz)				1860	1880	1900	L	M	H
20	QPSK	1	0	22.33	22.45	22.38	0.1268	0.1303	0.1282
20	QPSK	1	49	22.34	22.31	22.22	0.1271	0.1262	0.1236
20	QPSK	1	99	22.26	22.25	22.16	0.1247	0.1245	0.1219
20	QPSK	50	0	21.31	21.33	21.20	0.1002	0.1007	0.0977
20	QPSK	50	24	21.25	21.24	21.14	0.0989	0.0986	0.0964
20	QPSK	50	50	21.20	21.30	21.16	0.0977	0.1000	0.0968
20	QPSK	100	0	21.28	21.30	21.12	0.0995	0.1000	0.0959
20	16QAM	1	0	21.80	21.46	21.44	0.1122	0.1038	0.1033
20	64QAM	1	0	20.37	20.28	20.36	0.0807	0.0791	0.0805
Channel				18675	18900	19125	EIRP		
Frequency (MHz)				1857.5	1880	1902.5	L	M	H
15	QPSK	1	0	22.29	22.14	22.13	0.1256	0.1213	0.1211
15	16QAM	1	0	21.66	21.45	21.56	0.1086	0.1035	0.1062
Channel				18650	18900	19150	EIRP		
Frequency (MHz)				1855	1880	1905	L	M	H
10	QPSK	1	0	22.41	22.30	22.22	0.1291	0.1259	0.1236
10	16QAM	1	0	21.79	21.61	21.47	0.1119	0.1074	0.1040
Channel				18625	18900	19175	EIRP		
Frequency (MHz)				1852.5	1880	1907.5	L	M	H
5	QPSK	1	0	22.35	22.33	22.24	0.1274	0.1268	0.1242
5	16QAM	1	0	21.77	21.78	21.62	0.1114	0.1117	0.1076
Channel				18615	18900	19185	EIRP		
Frequency (MHz)				1851.5	1880	1908.5	L	M	H
3	QPSK	1	0	22.43	22.34	22.26	0.1297	0.1271	0.1247
3	16QAM	1	0	21.71	21.63	21.61	0.1099	0.1079	0.1074
Channel				18607	18900	19193	EIRP		
Frequency (MHz)				1850.7	1880	1909.3	L	M	H
1.4	QPSK	1	0	22.39	22.27	22.13	0.1285	0.1250	0.1211
1.4	16QAM	1	0	21.70	21.67	21.35	0.1096	0.1089	0.1012



LTE Band 4:

BW [MHz]	Modulation	RB Size	RB Offset	Power Low Ch. / Freq.	Power Middle Ch. / Freq.	Power High Ch. / Freq.	EIRP		
Channel				20050	20175	20300	EIRP		
Frequency (MHz)				1720	1732.5	1745	L	M	H
20	QPSK	1	0	22.40	22.68	22.42	0.1202	0.1282	0.1208
20	QPSK	1	49	22.32	22.40	22.36	0.1180	0.1202	0.1191
20	QPSK	1	99	22.38	22.37	22.40	0.1197	0.1194	0.1202
20	QPSK	50	0	21.38	21.57	21.50	0.0951	0.0993	0.0977
20	QPSK	50	24	21.52	21.43	21.55	0.0982	0.0962	0.0989
20	QPSK	50	50	21.49	21.46	21.55	0.0975	0.0968	0.0989
20	QPSK	100	0	21.47	21.51	21.49	0.0971	0.0979	0.0975
20	16QAM	1	0	21.70	21.70	22.14	0.1023	0.1023	0.1132
20	64QAM	1	0	20.61	20.76	20.76	0.0796	0.0824	0.0824
Channel				20025	20175	20325	EIRP		
Frequency (MHz)				1717.5	1732.5	1747.5	L	M	H
15	QPSK	1	0	22.33	22.53	22.46	0.1183	0.1239	0.1219
15	16QAM	1	0	21.84	21.84	21.79	0.1057	0.1057	0.1045
Channel				20000	20175	20350	EIRP		
Frequency (MHz)				1715	1732.5	1750	L	M	H
10	QPSK	1	0	22.41	22.55	22.63	0.1205	0.1245	0.1268
10	16QAM	1	0	21.86	21.86	21.85	0.1062	0.1062	0.1059
Channel				19975	20175	20375	EIRP		
Frequency (MHz)				1712.5	1732.5	1752.5	L	M	H
5	QPSK	1	0	22.50	22.60	22.56	0.1230	0.1259	0.1247
5	16QAM	1	0	21.76	21.79	21.98	0.1038	0.1045	0.1091
Channel				19965	20175	20385	EIRP		
Frequency (MHz)				1711.5	1732.5	1753.5	L	M	H
3	QPSK	1	0	22.53	22.68	22.64	0.1239	0.1282	0.1271
3	16QAM	1	0	21.87	21.85	22.13	0.1064	0.1059	0.1130
Channel				19950	20175	20393	EIRP		
Frequency (MHz)				1710	1732.5	1754.3	L	M	H
1.4	QPSK	1	0	22.44	22.52	22.42	0.1213	0.1236	0.1208
1.4	16QAM	1	0	21.74	21.90	21.81	0.1033	0.1072	0.1050



LTE Band 5:

BW [MHz]	Modulation	RB Size	RB Offset	Power Low Ch. / Freq.	Power Middle Ch. / Freq.	Power High Ch. / Freq.	ERP		
Channel				20450	20525	20600	ERP		
Frequency (MHz)				829	836.5	844	L	M	H
10	QPSK	1	0	22.43	22.55	22.45	0.0560	0.0575	0.0562
10	QPSK	1	25	22.40	22.50	22.53	0.0556	0.0569	0.0573
10	QPSK	1	49	22.44	22.53	22.29	0.0561	0.0573	0.0542
10	QPSK	25	0	21.52	21.59	21.55	0.0454	0.0461	0.0457
10	QPSK	25	12	21.55	21.54	21.59	0.0457	0.0456	0.0461
10	QPSK	25	25	21.49	21.56	21.55	0.0451	0.0458	0.0457
10	QPSK	50	0	21.43	21.52	21.47	0.0445	0.0454	0.0449
10	16QAM	1	0	21.76	21.98	21.89	0.0480	0.0505	0.0494
10	64QAM	1	0	20.85	20.44	20.42	0.0389	0.0354	0.0352
Channel				20425	20525	20625	ERP		
Frequency (MHz)				826.5	836.5	846.5	L	M	H
5	QPSK	1	0	22.52	22.44	22.44	0.0571	0.0561	0.0561
5	16QAM	1	0	21.80	21.97	21.76	0.0484	0.0504	0.0480
Channel				20415	20525	20635	ERP		
Frequency (MHz)				825.5	836.5	847.5	L	M	H
3	QPSK	1	0	22.43	22.41	22.51	0.0560	0.0557	0.0570
3	16QAM	1	0	21.84	21.90	21.81	0.0489	0.0495	0.0485
Channel				20407	20525	20643	ERP		
Frequency (MHz)				824.7	836.5	848.3	L	M	H
1.4	QPSK	1	0	22.39	22.48	22.38	0.0555	0.0566	0.0553
1.4	16QAM	1	0	21.68	21.79	21.67	0.0471	0.0483	0.0470



LTE Band 12:

BW [MHz]	Modulation	RB Size	RB Offset	Power Low Ch. / Freq.	Power Middle Ch. / Freq.	Power High Ch. / Freq.	ERP		
Channel				23060	23095	23160			
Frequency (MHz)				704	707.5	714	L	M	H
10	QPSK	1	0	22.33	22.78	22.61	0.0425	0.0471	0.0453
10	QPSK	1	25	22.41	22.33	22.31	0.0433	0.0425	0.0423
10	QPSK	1	49	22.43	22.37	22.38	0.0435	0.0429	0.0430
10	QPSK	25	0	21.42	21.50	21.31	0.0344	0.0351	0.0336
10	QPSK	25	12	21.48	21.38	21.49	0.0349	0.0341	0.0350
10	QPSK	25	25	21.41	21.43	21.38	0.0344	0.0345	0.0341
10	QPSK	50	0	21.45	21.49	21.37	0.0347	0.0350	0.0340
10	16QAM	1	0	21.69	21.82	21.67	0.0366	0.0378	0.0365
10	64QAM	1	0	20.74	20.70	20.60	0.0294	0.0292	0.0285
Channel				23035	23095	23205	EIRP		
Frequency (MHz)				701.5	707.5	718.5	L	M	H
5	QPSK	1	0	22.31	22.36	22.28	0.0423	0.0428	0.0420
5	16QAM	1	0	21.81	21.72	21.60	0.0377	0.0369	0.0359
Channel				23025	23095	23195	EIRP		
Frequency (MHz)				700.5	707.5	717.5	L	M	H
3	QPSK	1	0	22.44	22.32	22.29	0.0436	0.0424	0.0421
3	16QAM	1	0	21.74	21.49	21.56	0.0371	0.0350	0.0356
Channel				23017	23095	23173	EIRP		
Frequency (MHz)				699.7	707.5	715.3	L	M	H
1.4	QPSK	1	0	22.36	22.34	22.27	0.0428	0.0426	0.0419
1.4	16QAM	1	0	21.75	21.70	21.64	0.0372	0.0367	0.0362



LTE Band 13:

BW [MHz]	Modulation	RB Size	RB Offset	Power Low Ch. / Freq.	Power Middle Ch. / Freq.	Power High Ch. / Freq.	ERP		
Channel				23230					
Frequency (MHz)				782				M	
10	QPSK	1	0		22.35			0.0468	
10	QPSK	1	25		22.13			0.0445	
10	QPSK	1	49		22.11			0.0443	
10	QPSK	25	0		21.19			0.0358	
10	QPSK	25	12		21.16			0.0356	
10	QPSK	25	25		21.13			0.0353	
10	QPSK	50	0		21.25			0.0363	
10	16QAM	1	0		21.77			0.0409	
10	64QAM	1	0		20.41			0.0299	
Channel				23205	23230	23255	EIRP		
Frequency (MHz)				779.5	782	784.5	L	M	H
5	QPSK	1	0	22.34	22.09	22.02	0.0467	0.0441	0.0434
5	16QAM	1	0	21.70	21.76	21.57	0.0403	0.0408	0.0391



LTE Band 17:

BW [MHz]	Modulation	RB Size	RB Offset	Power Low Ch. / Freq.	Power Middle Ch. / Freq.	Power High Ch. / Freq.	ERP		
Channel				23780	23790	23830			
Frequency (MHz)				709	710	714	L	M	H
10	QPSK	1	0	22.76	22.77	22.51	0.0469	0.0470	0.0443
10	QPSK	1	25	22.63	22.48	22.45	0.0455	0.0440	0.0437
10	QPSK	1	49	22.41	22.50	22.46	0.0433	0.0442	0.0438
10	QPSK	25	0	21.78	21.88	21.62	0.0374	0.0383	0.0361
10	QPSK	25	12	21.80	21.59	21.53	0.0376	0.0358	0.0353
10	QPSK	25	25	21.74	21.48	21.56	0.0371	0.0349	0.0356
10	QPSK	50	0	21.63	21.74	21.61	0.0361	0.0371	0.0360
10	16QAM	1	0	22.18	21.83	21.86	0.0410	0.0378	0.0381
10	64QAM	1	0	20.89	20.83	20.69	0.0305	0.0301	0.0291
Channel				23755	23790	23825	EIRP		
Frequency (MHz)				706.5	710	713.5	L	M	H
5	QPSK	1	0	22.76	22.61	22.60	0.0469	0.0453	0.0452
5	16QAM	1	0	22.17	21.95	21.90	0.0409	0.0389	0.0385



LTE Band 26:

BW [MHz]	Modulation	RB Size	RB Offset	Power Low Ch. / Freq.	Power Low Ch. / Freq.	Power Middle Ch. / Freq.	Power High Ch. / Freq.	ERP			
Channel				26765	26865	26915	26965				
Frequency (MHz)				821.5	831.5	836.5	841.5	L	M	H	
15	QPSK	1	0	22.32	22.32	22.57	22.34	0.0546	0.0546	0.0578	0.0548
15	QPSK	1	37	22.25	22.25	22.28	22.30	0.0537	0.0537	0.0541	0.0543
15	QPSK	1	74	22.26	22.26	22.23	22.15	0.0538	0.0538	0.0535	0.0525
15	QPSK	36	0	21.50	21.50	21.53	21.43	0.0452	0.0452	0.0455	0.0445
15	QPSK	36	20	21.52	21.52	21.49	21.43	0.0454	0.0454	0.0451	0.0445
15	QPSK	36	39	21.47	21.47	21.40	21.45	0.0449	0.0449	0.0442	0.0447
15	QPSK	75	0	21.49	21.49	21.50	21.42	0.0451	0.0451	0.0452	0.0444
15	16QAM	1	0	21.64	21.64	21.70	21.95	0.0467	0.0467	0.0473	0.0501
15	64QAM	1	0	20.78	20.78	20.50	20.39	0.0383	0.0383	0.0359	0.0350
Channel					26840	26915	26990	ERP			
Frequency (MHz)					829	836.5	844	L	M	H	
10	QPSK	1	0		22.48	22.55	22.52	0.0566	0.0575	0.0571	
10	16QAM	1	0		21.90	21.79	21.78	0.0495	0.0483	0.0482	
Channel					26815	26915	27015	ERP			
Frequency (MHz)					826.5	836.5	846.5	L	M	H	
5	QPSK	1	0		22.56	22.40	22.45	0.0577	0.0556	0.0562	
5	16QAM	1	0		21.94	21.69	21.81	0.0500	0.0472	0.0485	
Channel					26815	26915	27025	ERP			
Frequency (MHz)					825.5	836.5	847.5	L	M	H	
3	QPSK	1	0		22.53	22.53	22.40	0.0573	0.0573	0.0556	
3	16QAM	1	0		21.91	21.94	21.75	0.0497	0.0500	0.0479	
Channel					26797	26915	27033	ERP			
Frequency (MHz)					824.7	836.5	848.3	L	M	H	
1.4	QPSK	1	0	22.49	22.50	22.30	0.0568	0.0569	0.0543		
1.4	16QAM	1	0	21.88	21.68	21.68	0.0493	0.0471	0.0471		



LTE Band 66:

BW [MHz]	Modulation	RB Size	RB Offset	Power Low Ch. / Freq.	Power Middle Ch. / Freq.	Power High Ch. / Freq.	EIRP		
Channel				132072	132322	132572	EIRP		
Frequency (MHz)				1720	1745	1770	L	M	H
20	QPSK	1	0	22.35	22.69	22.55	0.1189	0.1285	0.1245
20	QPSK	1	49	22.63	22.27	22.63	0.1268	0.1167	0.1268
20	QPSK	1	99	22.42	22.43	22.52	0.1208	0.1211	0.1236
20	QPSK	50	0	21.23	21.36	21.24	0.0918	0.0946	0.0920
20	QPSK	50	24	21.27	21.29	21.25	0.0927	0.0931	0.0923
20	QPSK	50	50	21.27	21.32	21.29	0.0927	0.0938	0.0931
20	QPSK	100	0	21.27	21.31	21.19	0.0927	0.0935	0.0910
20	16QAM	1	0	21.46	21.79	21.65	0.0968	0.1045	0.1012
20	64QAM	1	0	20.39	20.38	20.59	0.0757	0.0755	0.0793
Channel				132047	132322	132597	EIRP		
Frequency (MHz)				1717.5	1745	1772.5	L	M	H
15	QPSK	1	0	22.22	22.27	22.10	0.1153	0.1167	0.1122
15	16QAM	1	0	21.51	21.62	21.72	0.0979	0.1005	0.1028
Channel				132022	132322	132622	EIRP		
Frequency (MHz)				1715	1745	1775	L	M	H
10	QPSK	1	0	22.41	22.38	22.29	0.1205	0.1197	0.1172
10	16QAM	1	0	21.66	21.66	21.76	0.1014	0.1014	0.1038
Channel				131997	132322	132647	EIRP		
Frequency (MHz)				1712.5	1745	1777.5	L	M	H
5	QPSK	1	0	21.37	21.50	21.43	0.0948	0.0977	0.0962
5	16QAM	1	0	21.63	21.78	21.75	0.1007	0.1042	0.1035
Channel				131987	132322	132657	EIRP		
Frequency (MHz)				1711.5	1745	1778.5	L	M	H
3	QPSK	1	0	22.41	22.38	22.42	0.1205	0.1197	0.1208
3	16QAM	1	0	21.65	21.78	21.70	0.1012	0.1042	0.1023
Channel				131979	132322	132665	EIRP		
Frequency (MHz)				1710.7	1745	1779.3	L	M	H
1.4	QPSK	1	0	22.22	22.39	22.30	0.1153	0.1199	0.1175
1.4	16QAM	1	0	21.63	21.68	21.63	0.1007	0.1019	0.1007



LTE Band 2

Peak-to-Average Ratio

Mode	LTE Band 2 / 20MHz			
Mod.	QPSK	16QAM	64QAM	Limit: 13dB
RB Size	Full RB	Full RB	Full RB	Result
Middle CH	4.81	5.91	6.78	PASS

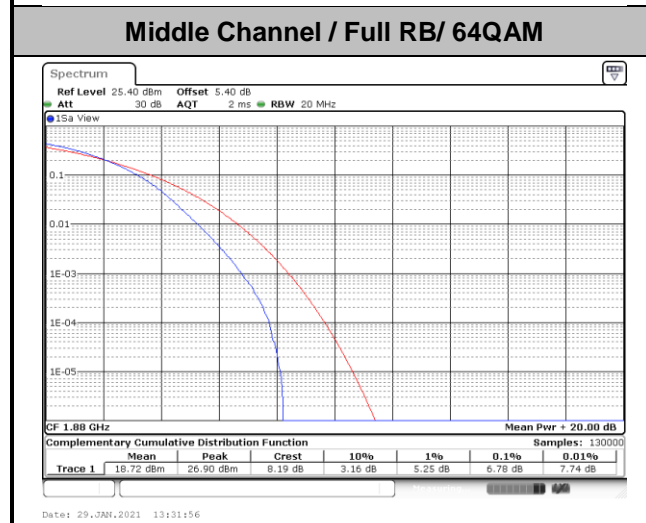
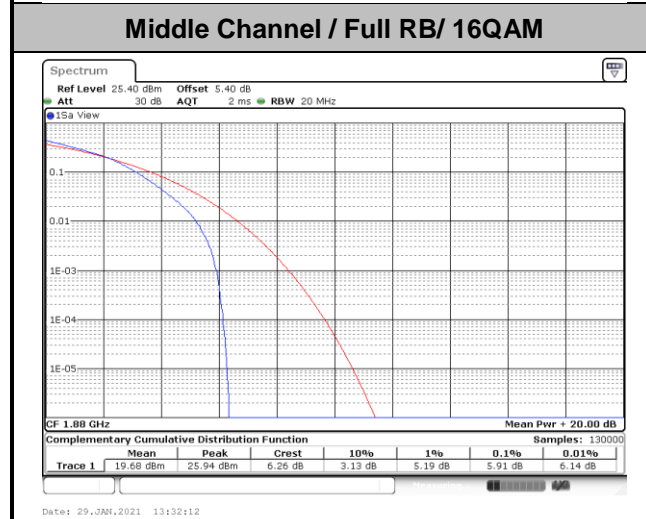
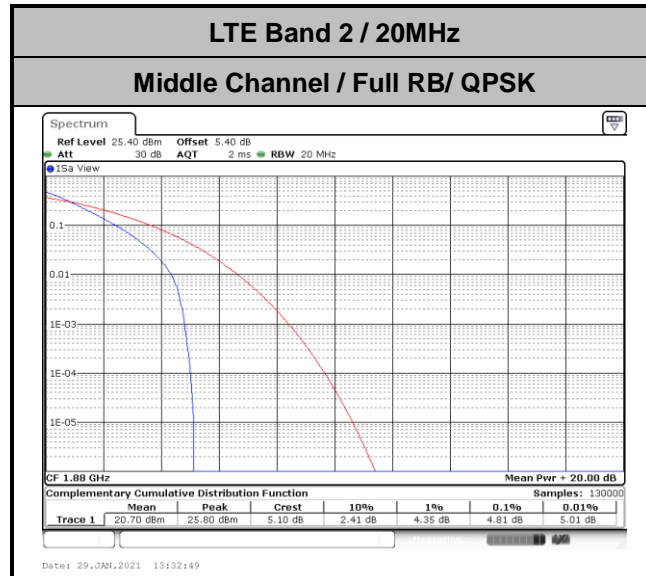



26dB Bandwidth

Mode	LTE Band 2 : 26dB BW(MHz)	
BW	20MHz	
Mod.	QPSK	16QAM
Middle CH	19.14	18.82

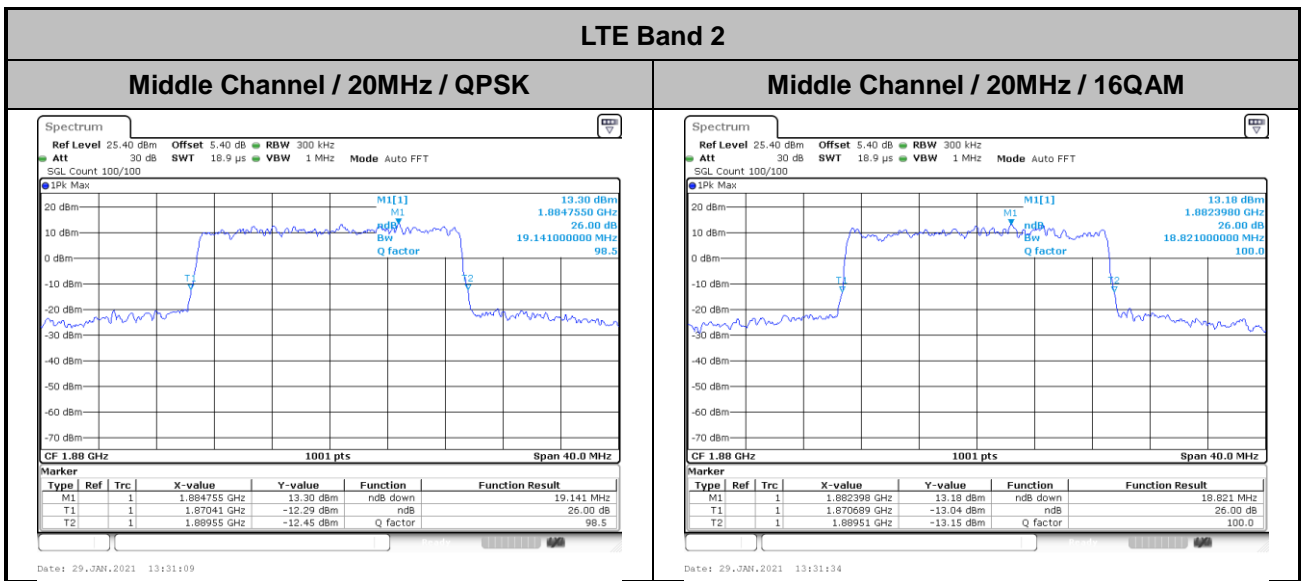



Occupied Bandwidth

Mode	LTE Band 2 : 99%OBW(MHz)	
BW	20MHz	
Mod.	QPSK	16QAM
Middle CH	17.86	17.82

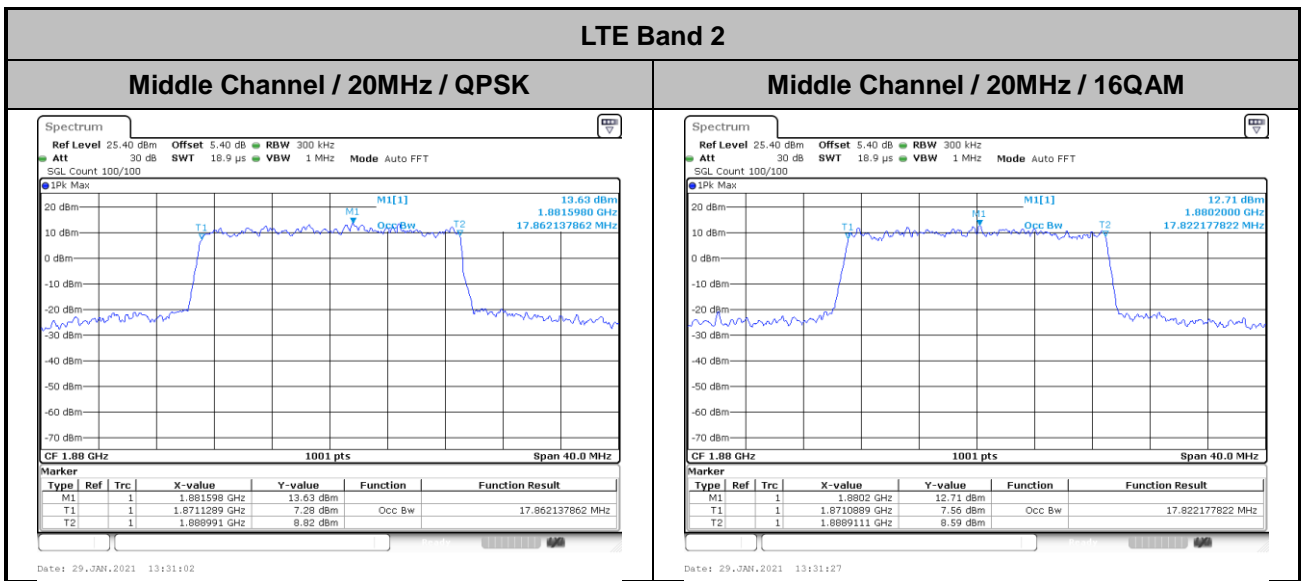



Conducted Band Edge

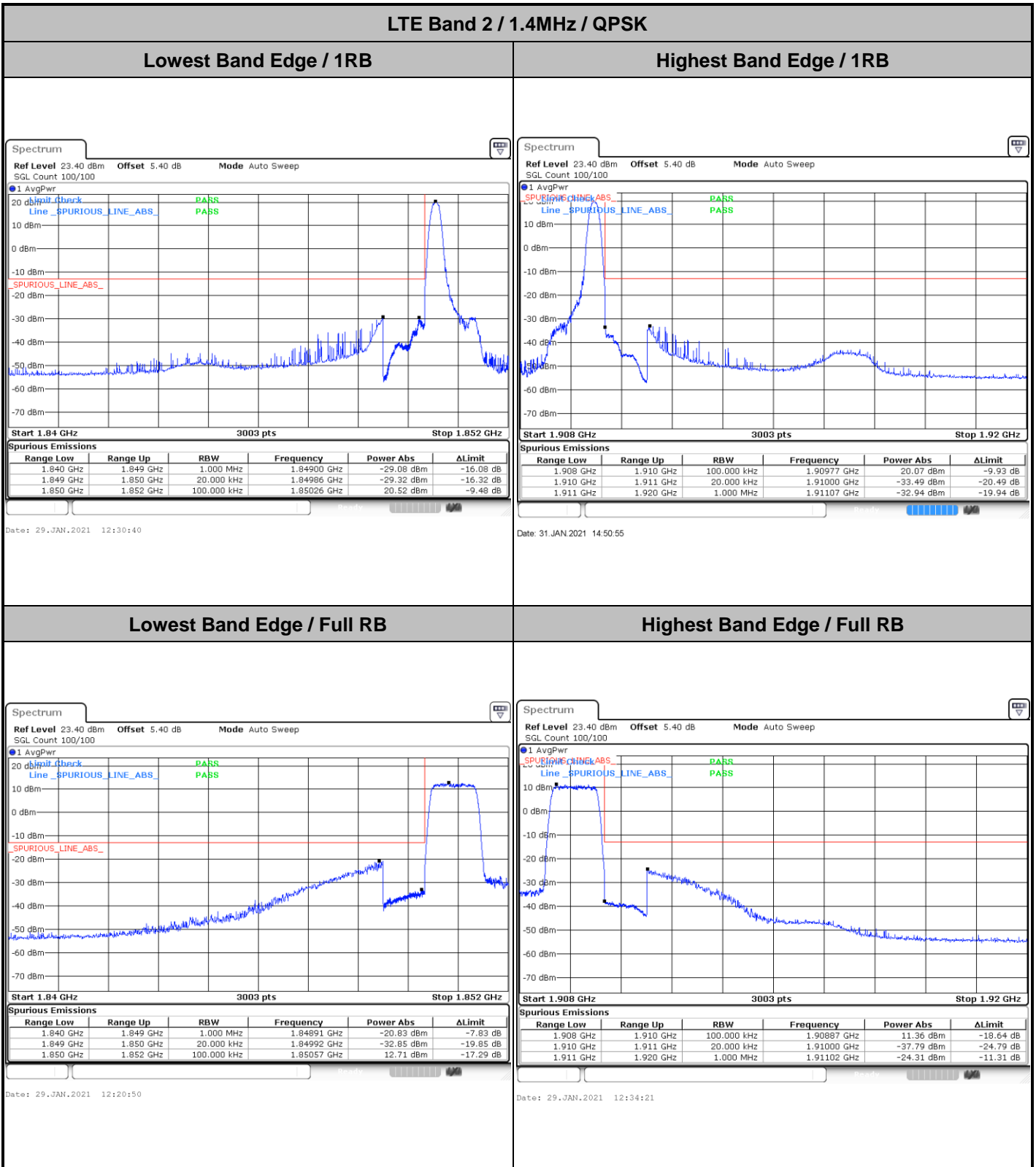



LTE Band 2 / 1.4MHz / 16QAM

Lowest Band Edge / 1 RB

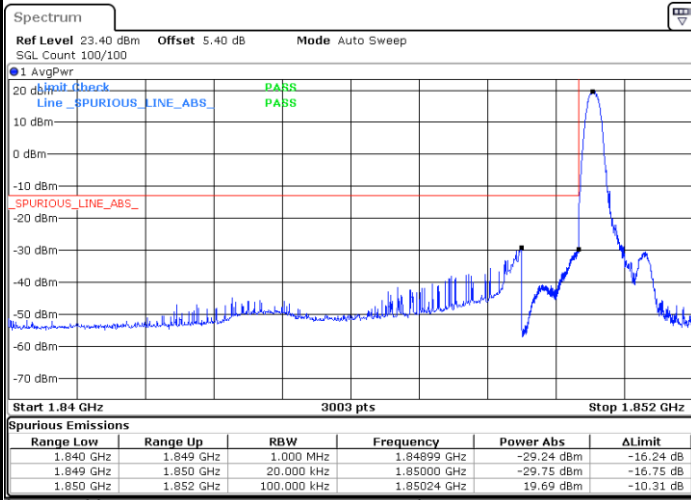

Date: 29.JAN.2021 12:26:50

Highest Band Edge / 1 RB

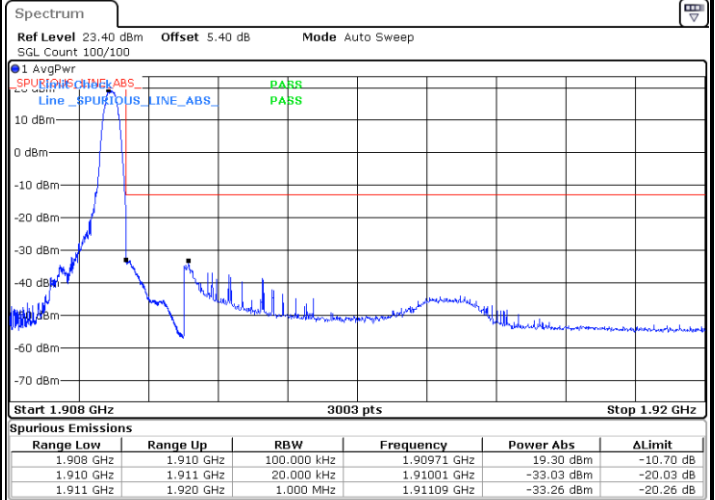

Date: 29.JAN.2021 12:40:50

Lowest Band Edge / Full RB

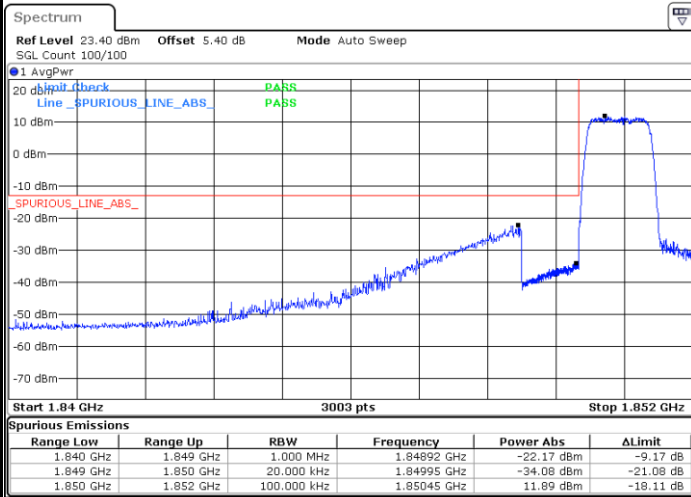

Date: 29.JAN.2021 12:22:04

Highest Band Edge / Full RB

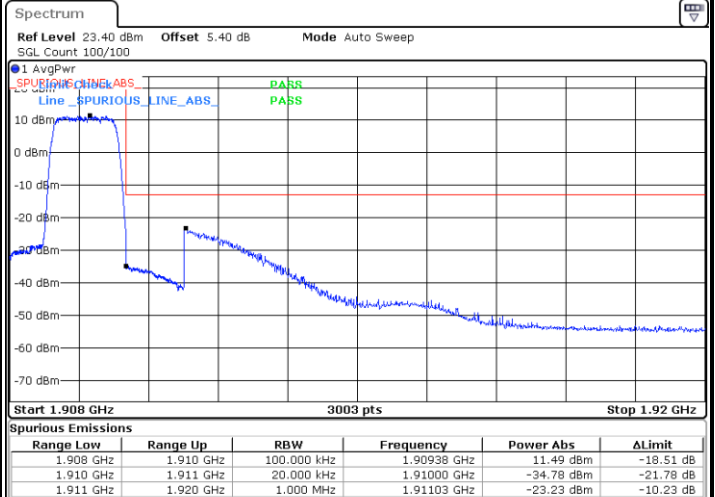

Date: 29.JAN.2021 12:35:29



LTE Band 2 / 1.4MHz / 64QAM

Lowest Band Edge / 1 RB

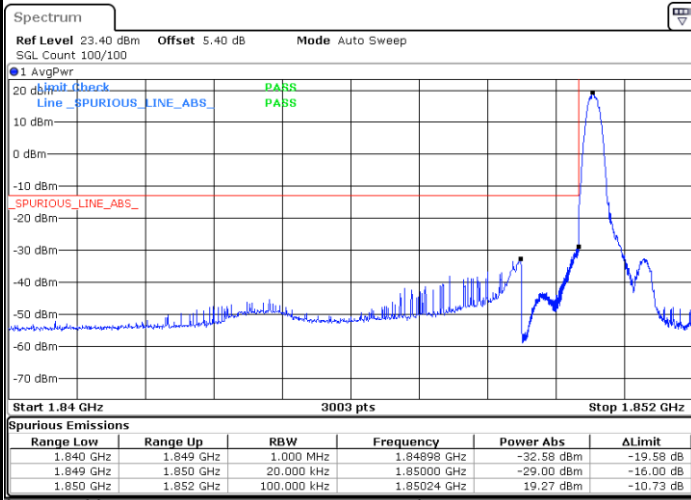

Date: 29.JAN.2021 12:25:42

Highest Band Edge / 1 RB

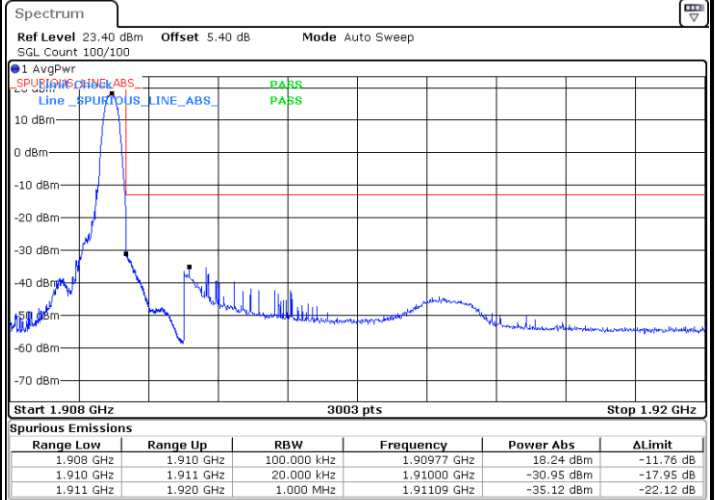

Date: 29.JAN.2021 12:39:41

Lowest Band Edge / Full RB

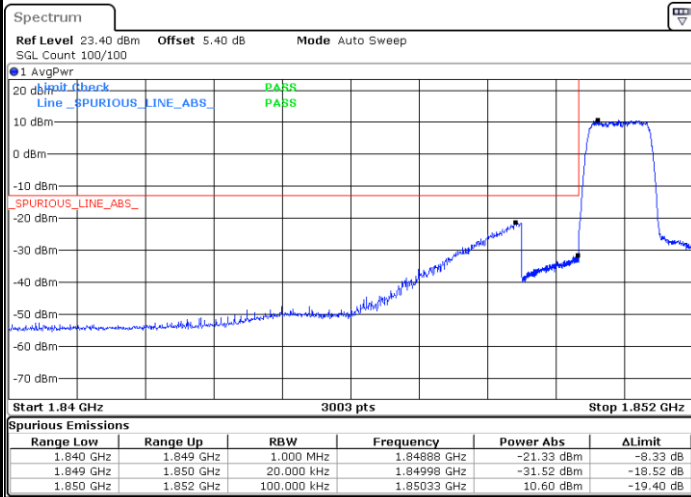

Date: 29.JAN.2021 12:24:30

Highest Band Edge / Full RB

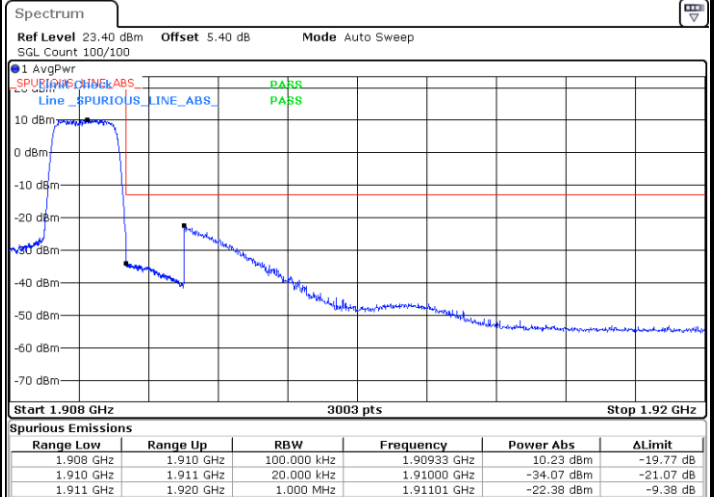

Date: 29.JAN.2021 12:36:44



LTE Band 2 / 3MHz / QPSK

Lowest Band Edge / 1RB

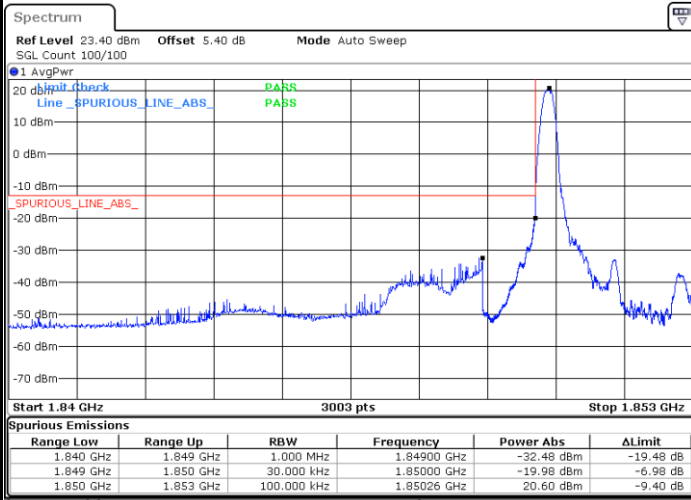

Date: 29.JAN.2021 12:47:32

Highest Band Edge / 1 RB

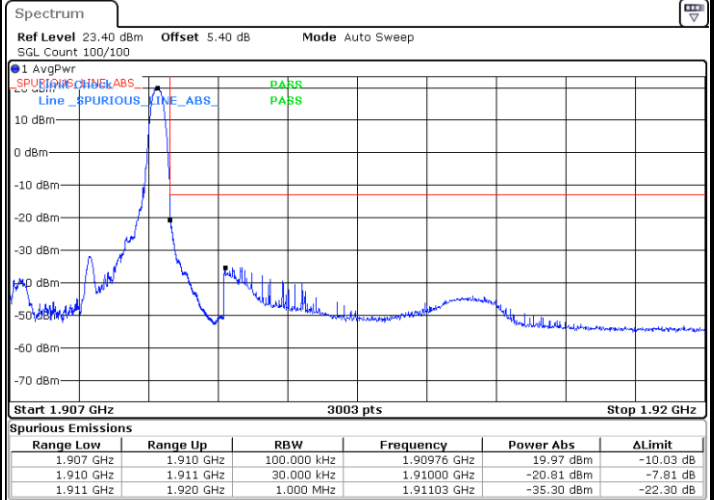

Date: 29.JAN.2021 12:50:25

Lowest Band Edge / Full RB

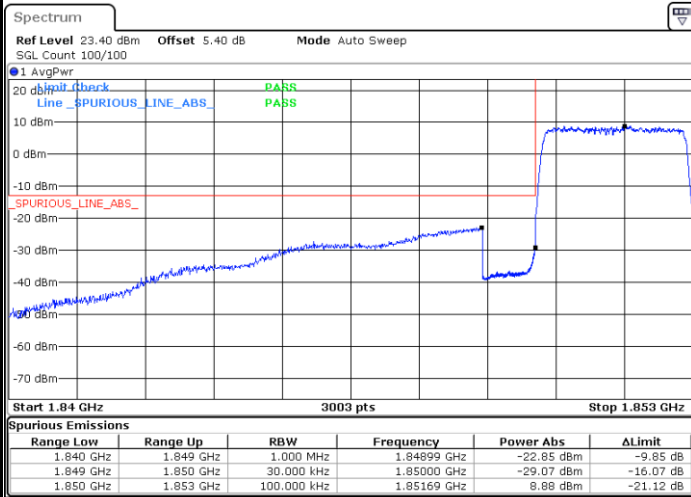

Date: 29.JAN.2021 12:43:13

Highest Band Edge / Full RB



Date: 29.JAN.2021 12:55:47



LTE Band 2 / 3MHz / 16QAM

Lowest Band Edge / 1 RB

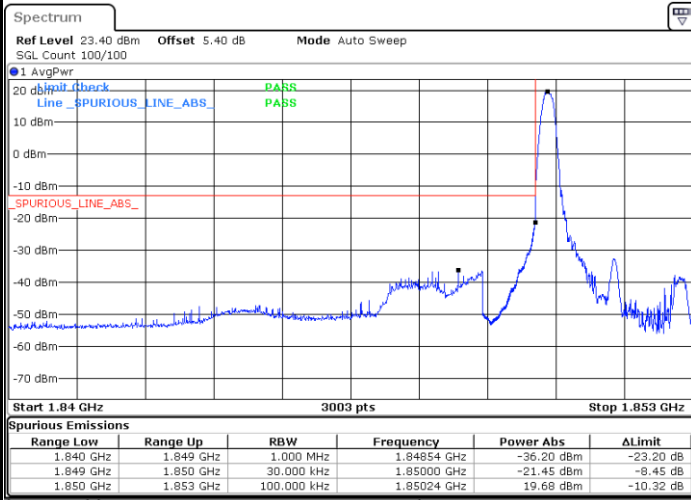

Date: 29.JAN.2021 12:46:44

Highest Band Edge / 1 RB

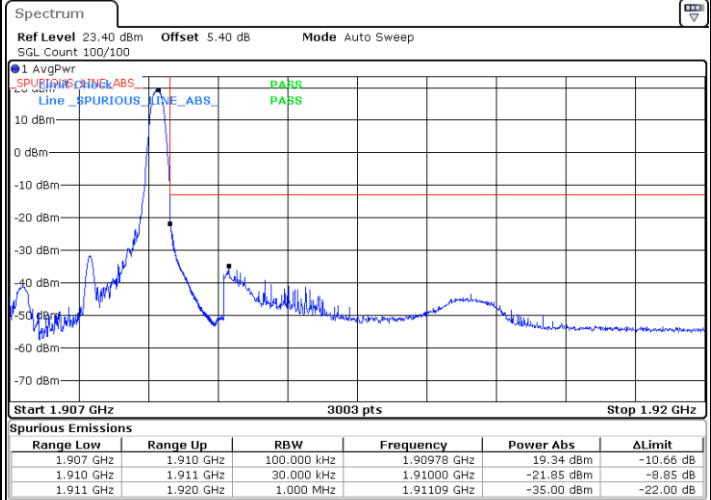

Date: 29.JAN.2021 12:51:08

Lowest Band Edge / Full RB

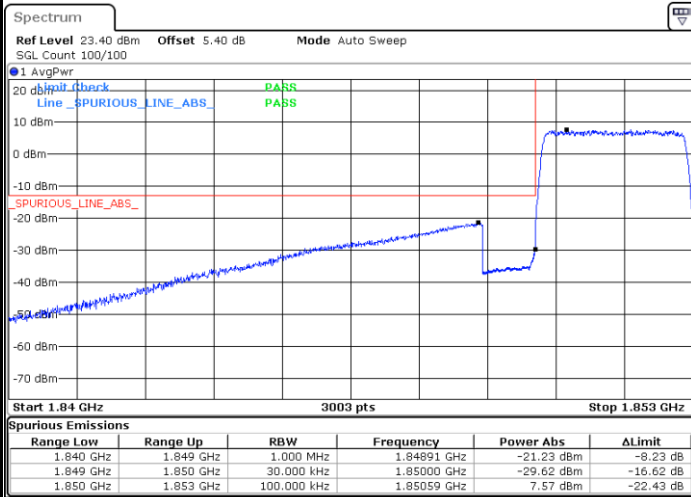

Date: 29.JAN.2021 12:44:04

Highest Band Edge / Full RB



Date: 29.JAN.2021 12:54:29



LTE Band 2 / 3MHz / 64QAM

Lowest Band Edge / 1 RB

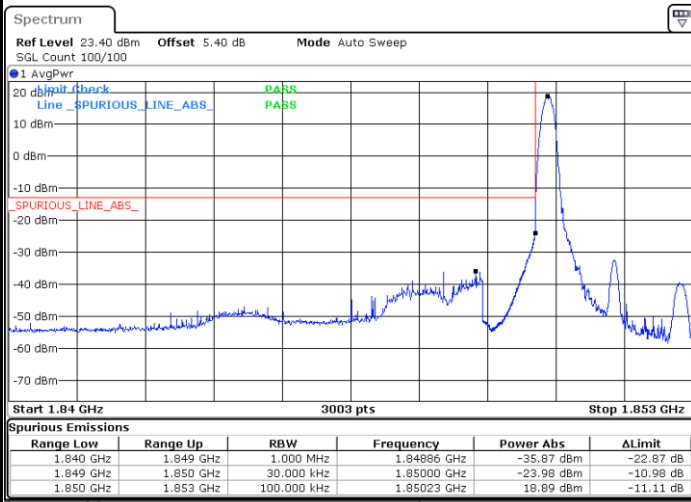

Date: 29.JAN.2021 12:45:40

Highest Band Edge / 1 RB

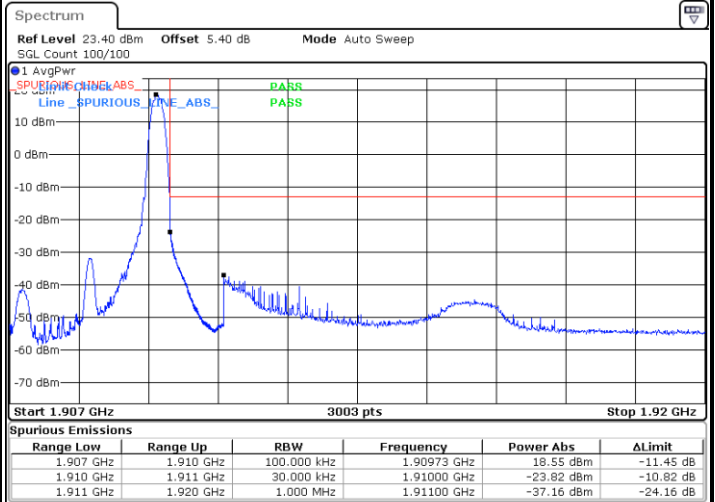

Date: 29.JAN.2021 12:51:46

Lowest Band Edge / Full RB

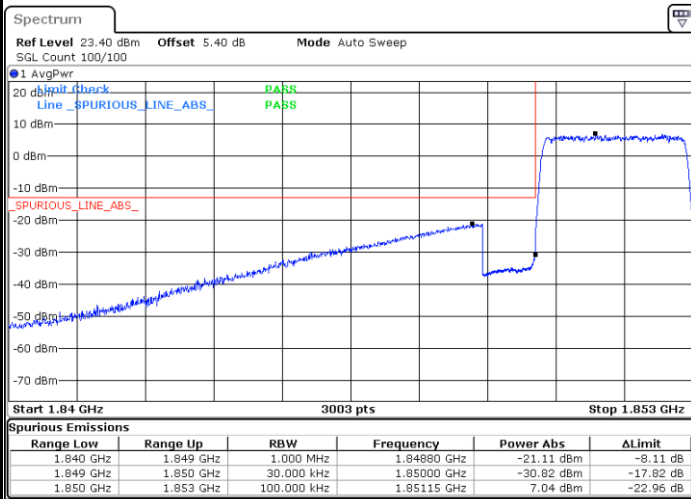

Date: 29.JAN.2021 12:44:55

Highest Band Edge / Full RB

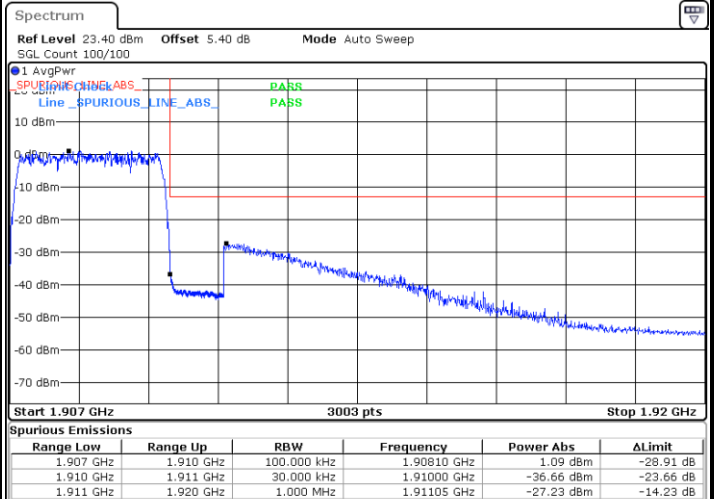

Date: 29.JAN.2021 12:52:43



LTE Band 2 / 5MHz / QPSK

Lowest Band Edge / 1 RB

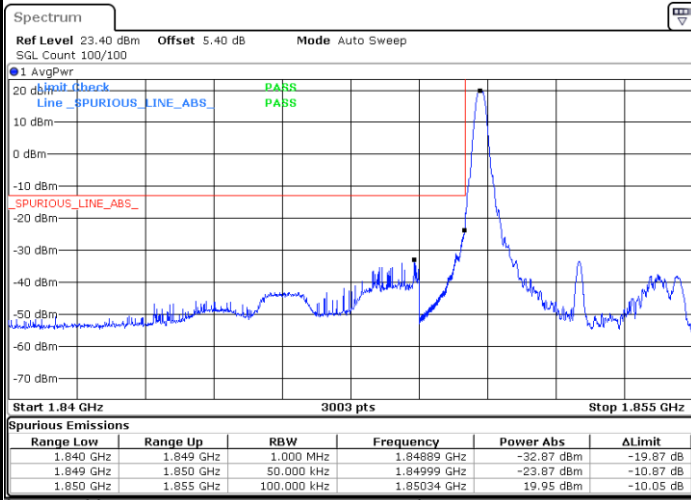

Date: 29.JAN.2021 12:59:45

Highest Band Edge / 1 RB

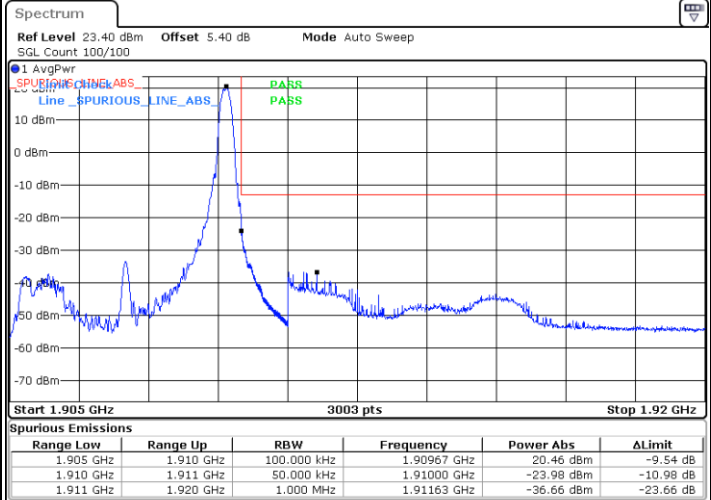

Date: 29.JAN.2021 13:05:54

Lowest Band Edge / Full RB

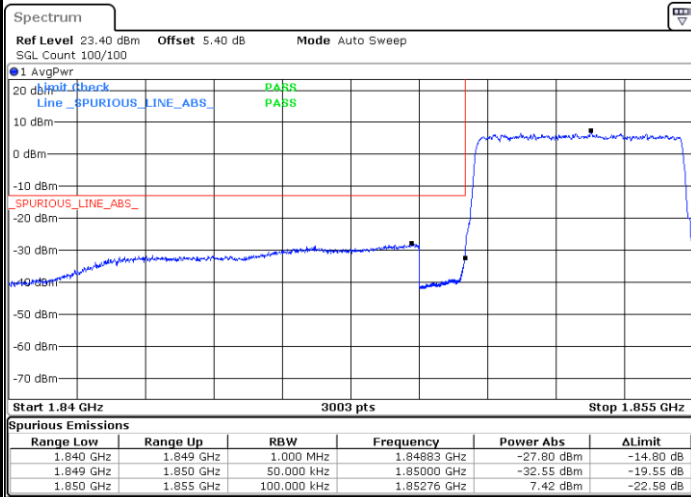

Date: 29.JAN.2021 12:57:16

Highest Band Edge / Full RB

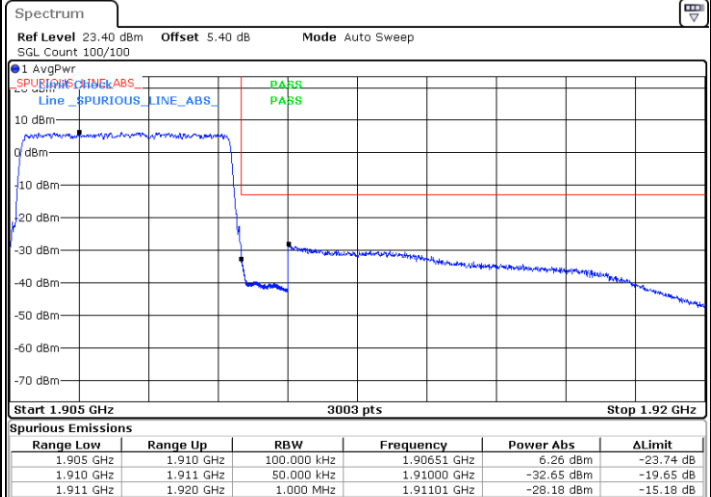

Date: 29.JAN.2021 13:02:49



LTE Band 2 / 5MHz / 16QAM

Lowest Band Edge / 1RB

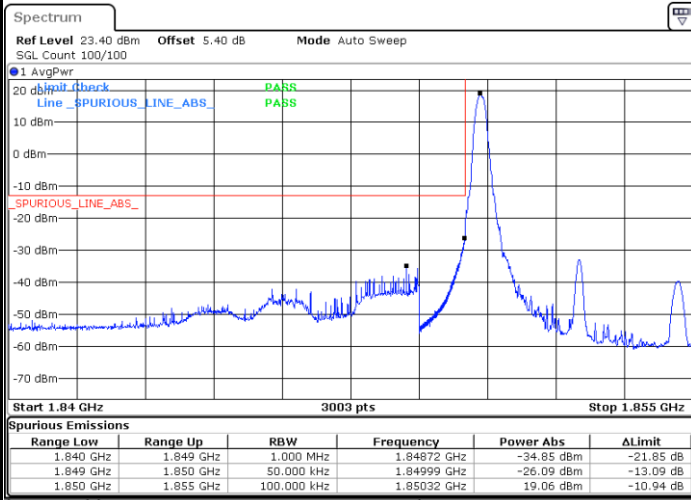

Date: 29.JAN.2021 12:59:15

Highest Band Edge / 1 RB

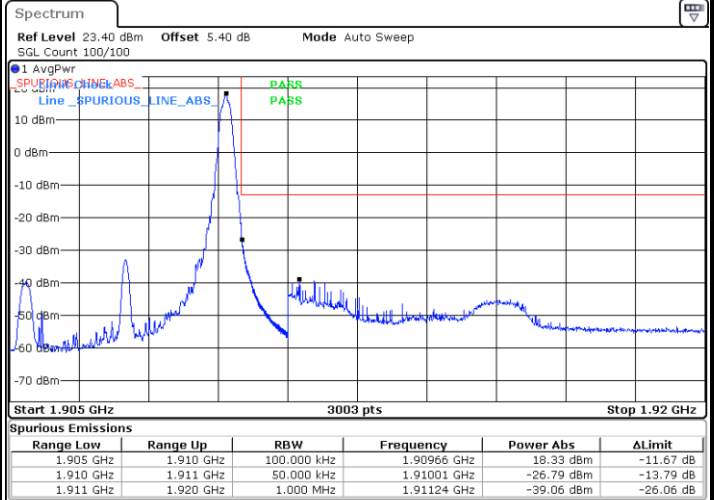

Date: 29.JAN.2021 13:05:23

Lowest Band Edge / Full RB

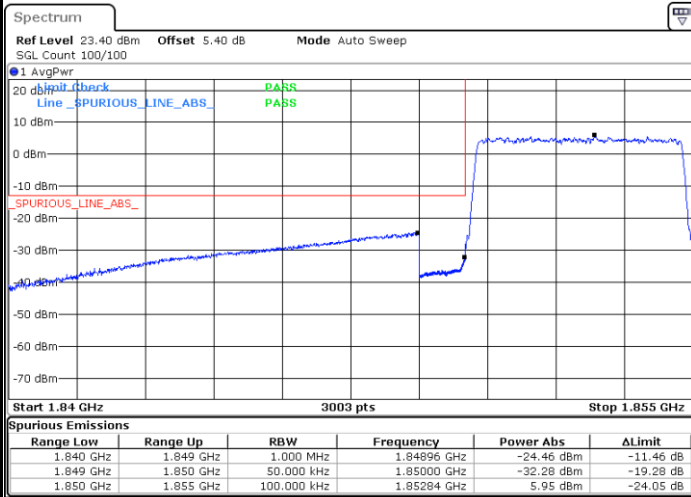

Date: 29.JAN.2021 12:57:52

Highest Band Edge / Full RB

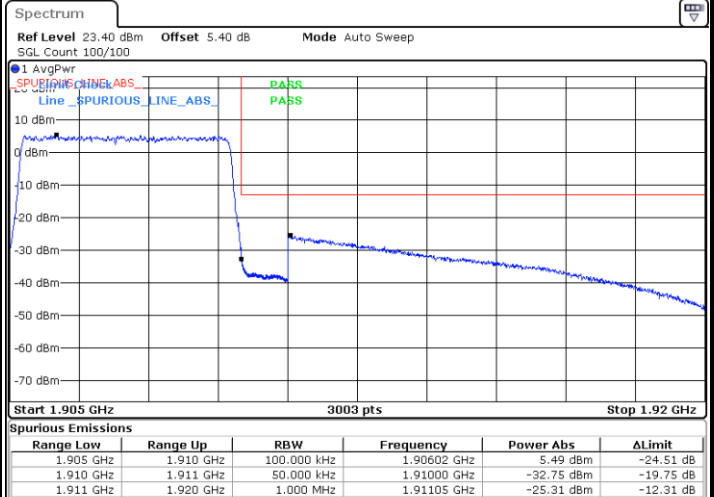

Date: 29.JAN.2021 13:03:41



LTE Band 2 / 5MHz / 64QAM

Lowest Band Edge / 1RB

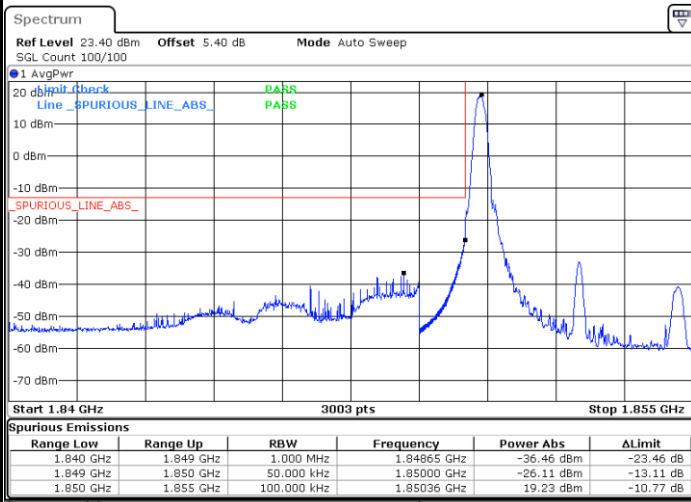

Date: 29.JAN.2021 12:58:52

Highest Band Edge / 1 RB

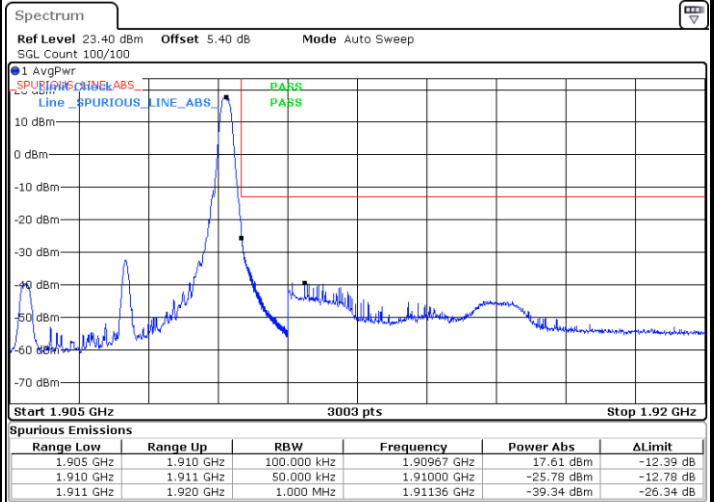

Date: 29.JAN.2021 13:04:49

Lowest Band Edge / Full RB

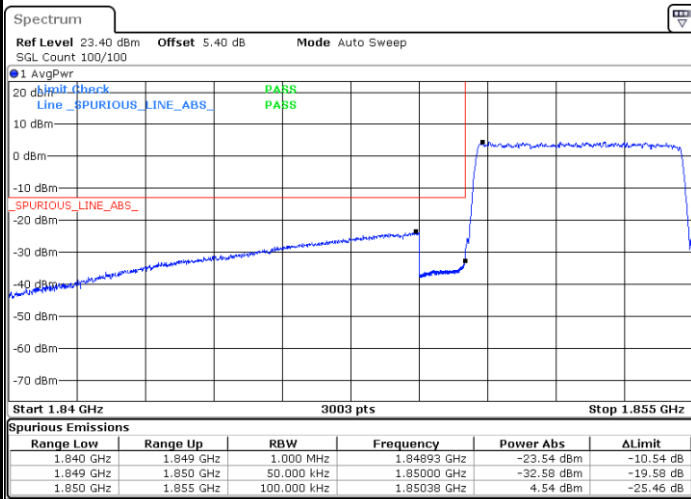

Date: 29.JAN.2021 12:58:20

Highest Band Edge / Full RB

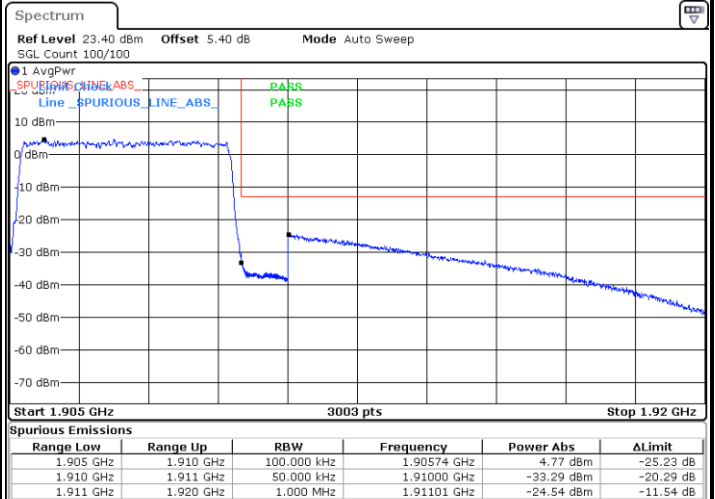

Date: 29.JAN.2021 13:04:06



LTE Band 2 / 10MHz / QPSK

Lowest Band Edge / 1 RB

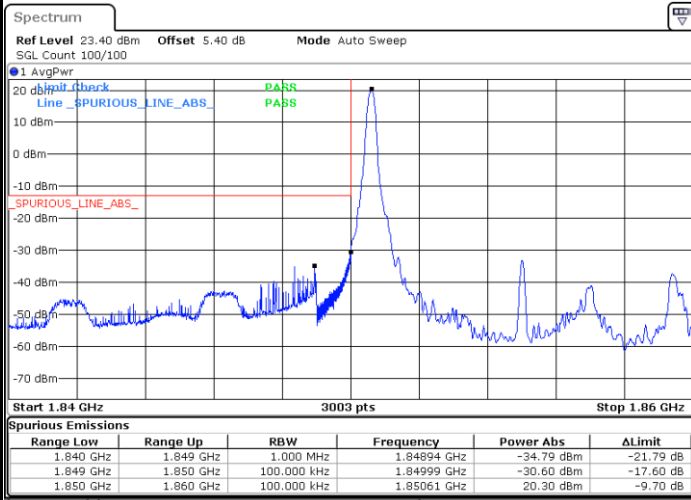

Date: 29.JAN.2021 13:08:19

Highest Band Edge / 1 RB

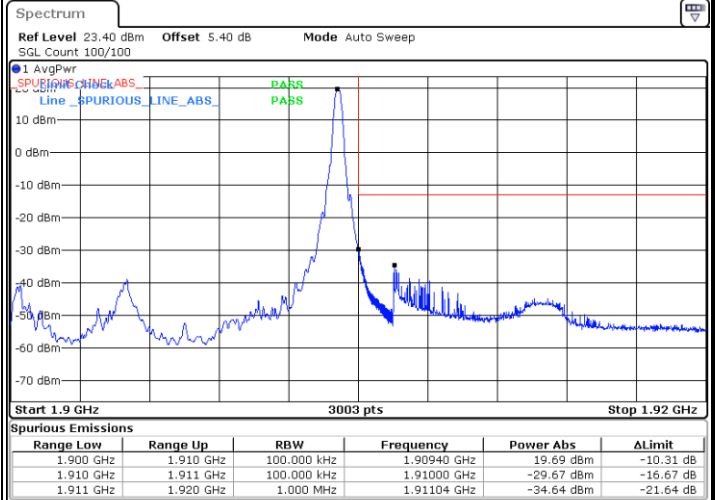

Date: 29.JAN.2021 13:14:40

Lowest Band Edge / Full RB

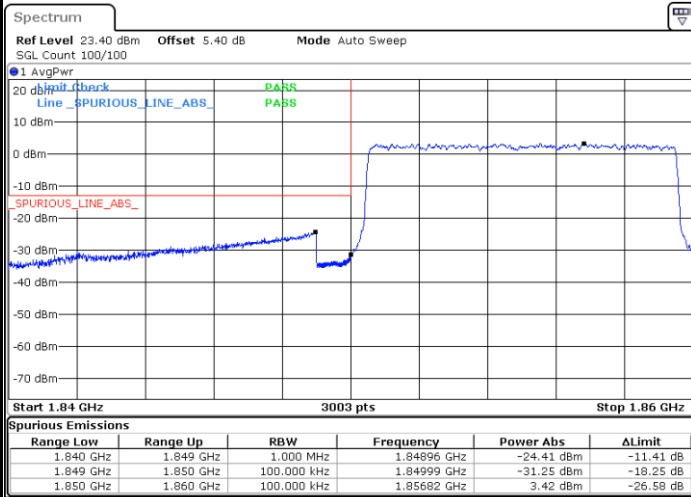

Date: 29.JAN.2021 13:06:53

Highest Band Edge / Full RB

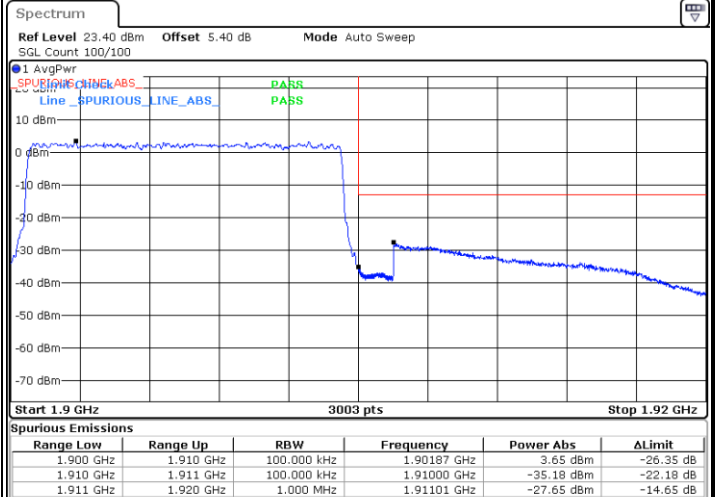

Date: 29.JAN.2021 13:12:05



LTE Band 2 / 10MHz / 16QAM

Lowest Band Edge / 1 RB

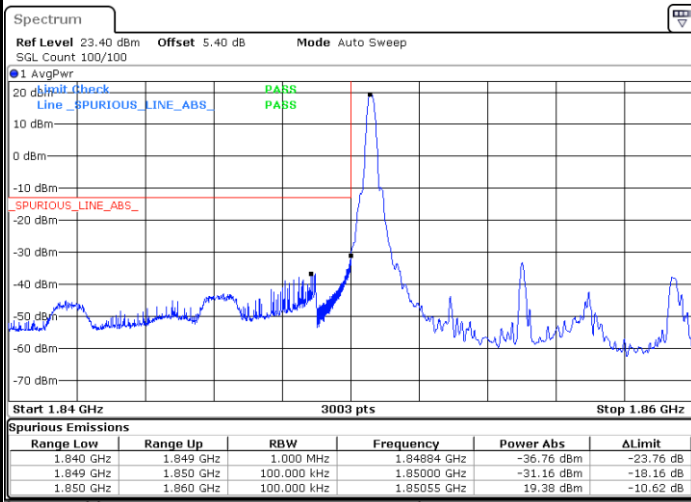

Date: 29.JAN.2021 13:08:07

Highest Band Edge / 1 RB

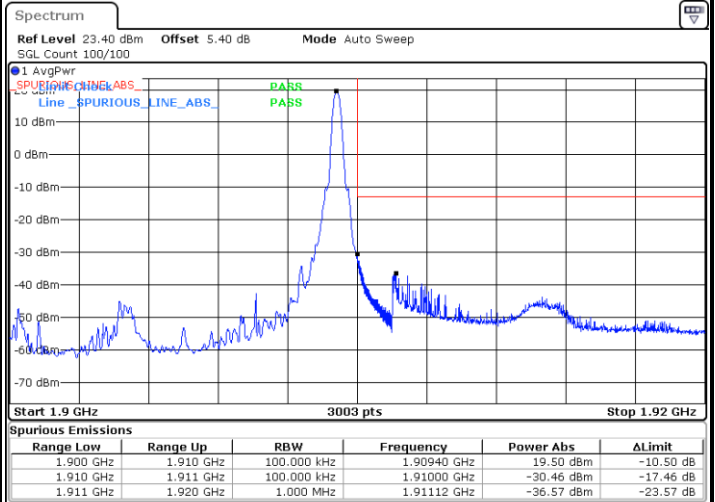

Date: 29.JAN.2021 13:13:50

Lowest Band Edge / Full RB

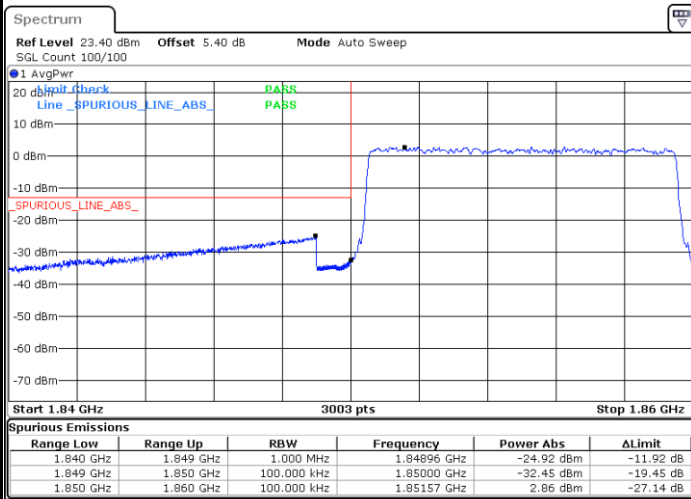

Date: 29.JAN.2021 13:07:09

Highest Band Edge / Full RB

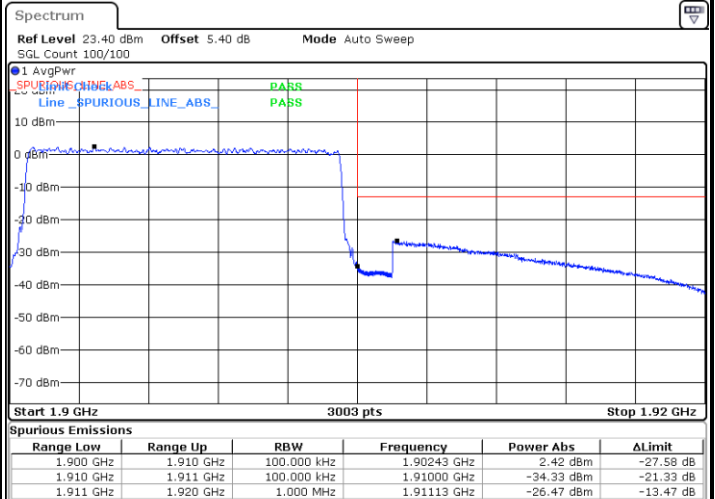

Date: 29.JAN.2021 13:12:28



LTE Band 2 / 10MHz / 64QAM

Lowest Band Edge / 1 RB

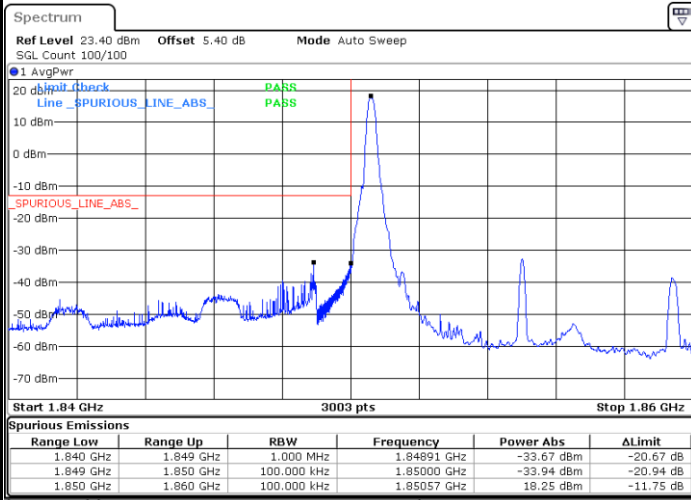

Date: 29.JAN.2021 13:07:45

Highest Band Edge / 1 RB

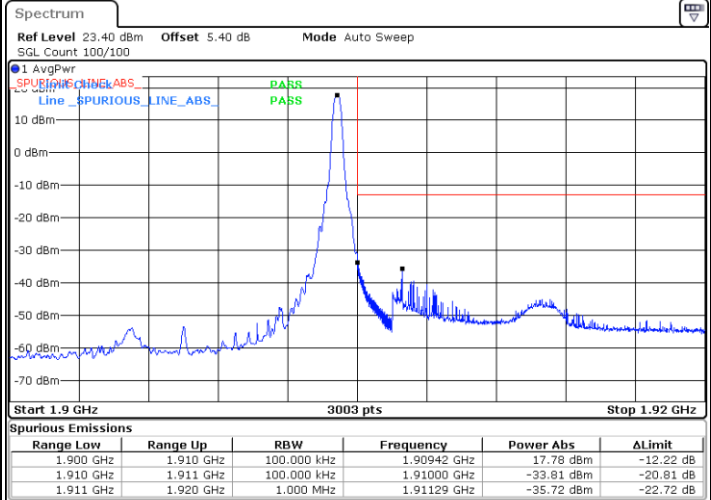

Date: 29.JAN.2021 13:13:23

Lowest Band Edge / Full RB

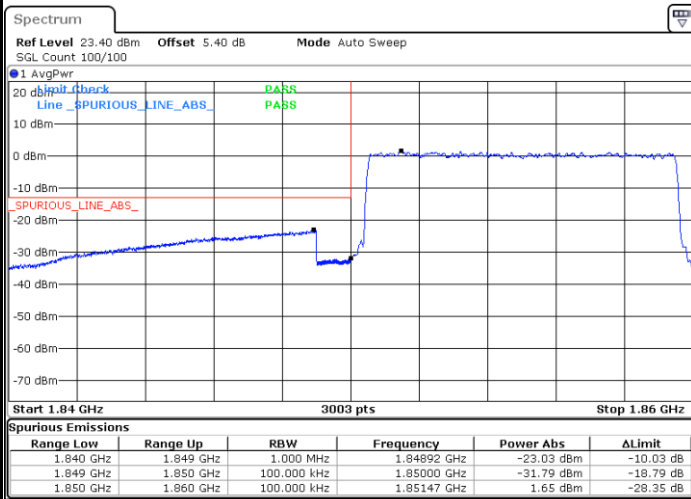

Date: 29.JAN.2021 13:07:25

Highest Band Edge / Full RB

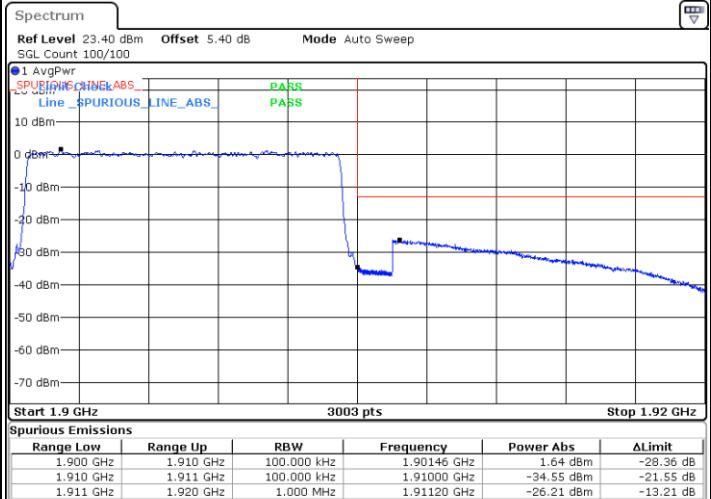

Date: 29.JAN.2021 13:12:45



LTE Band 2 / 15MHz / QPSK

Lowest Band Edge / 1 RB

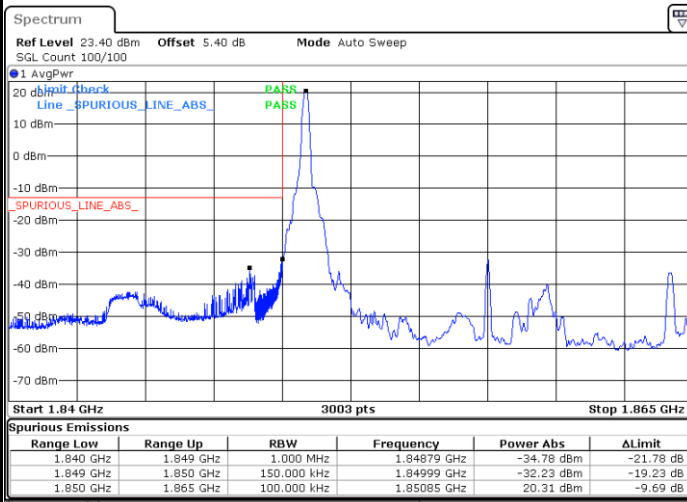

Date: 29.JAN.2021 13:17:56

Highest Band Edge / 1 RB

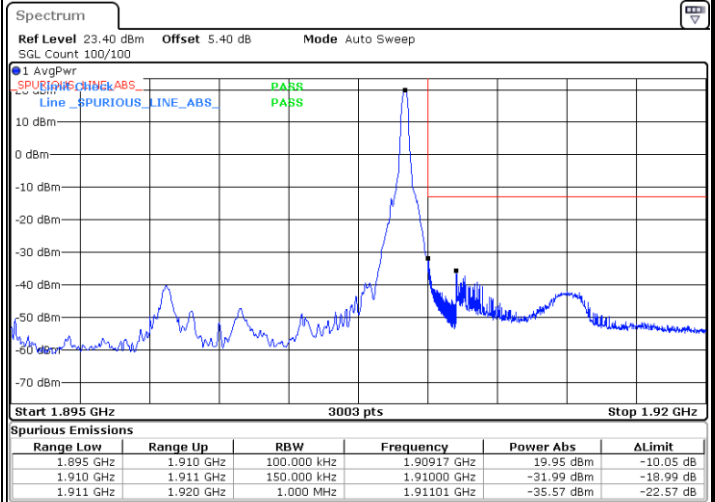

Date: 29.JAN.2021 13:23:40

Lowest Band Edge / Full RB

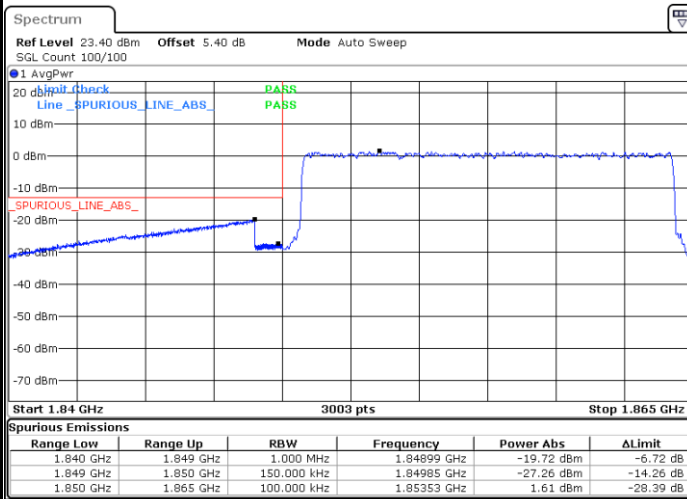

Date: 29.JAN.2021 13:15:29

Highest Band Edge / Full RB

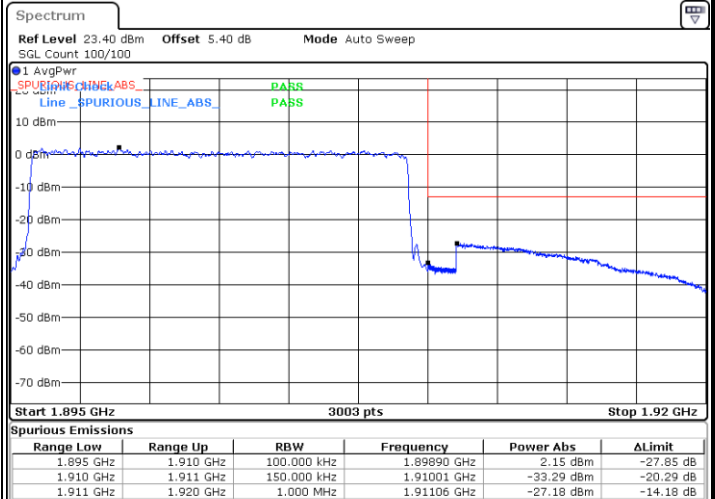

Date: 29.JAN.2021 13:21:14



LTE Band 2 / 15MHz / 16QAM

Lowest Band Edge / 1 RB

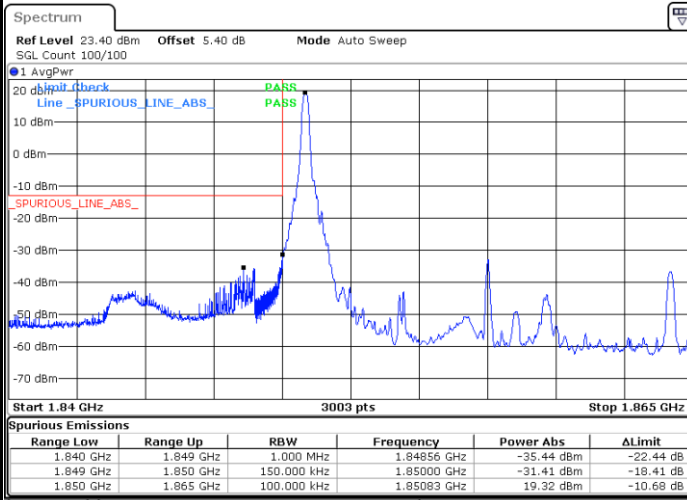

Date: 29.JAN.2021 13:17:40

Highest Band Edge / 1 RB

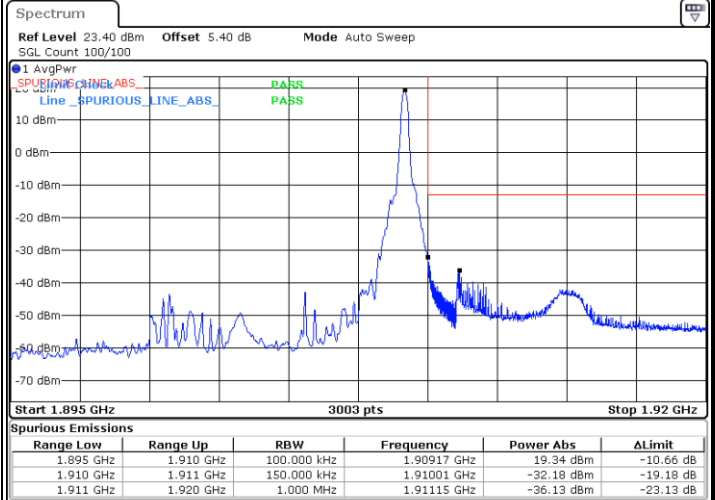

Date: 29.JAN.2021 13:23:20

Lowest Band Edge / Full RB

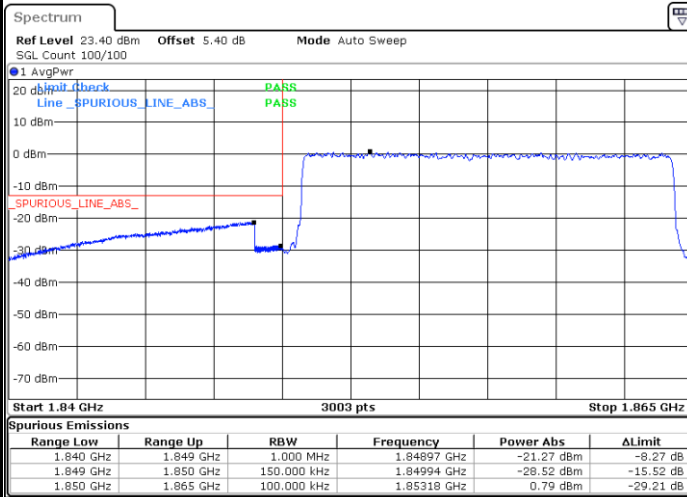

Date: 29.JAN.2021 13:16:00

Highest Band Edge / Full RB

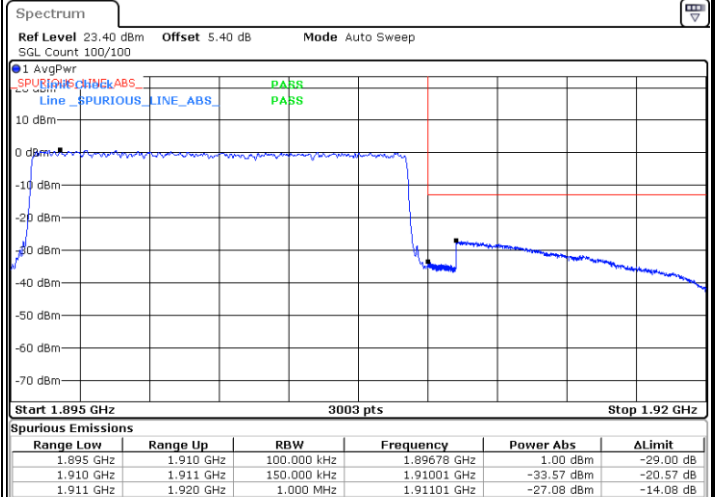

Date: 29.JAN.2021 13:21:50



LTE Band 2 / 15MHz / 64QAM

Lowest Band Edge / 1 RB

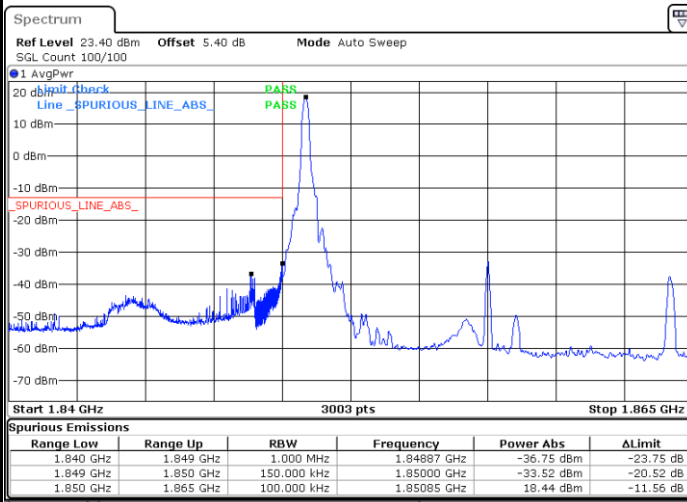

Date: 29.JAN.2021 13:16:52

Highest Band Edge / 1 RB

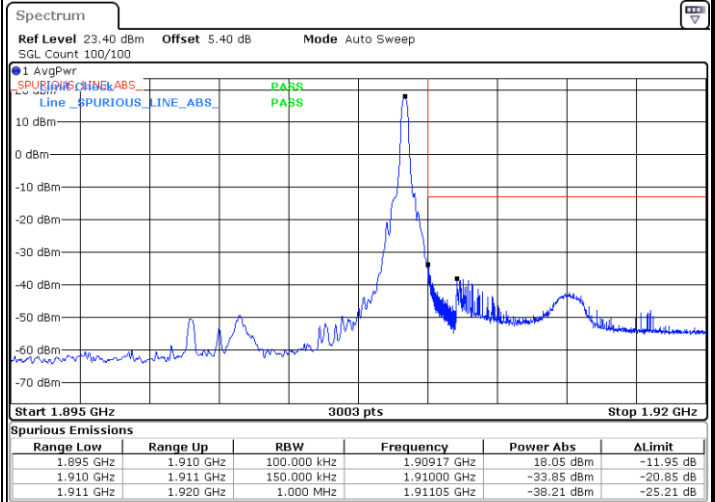

Date: 29.JAN.2021 13:22:52

Lowest Band Edge / Full RB

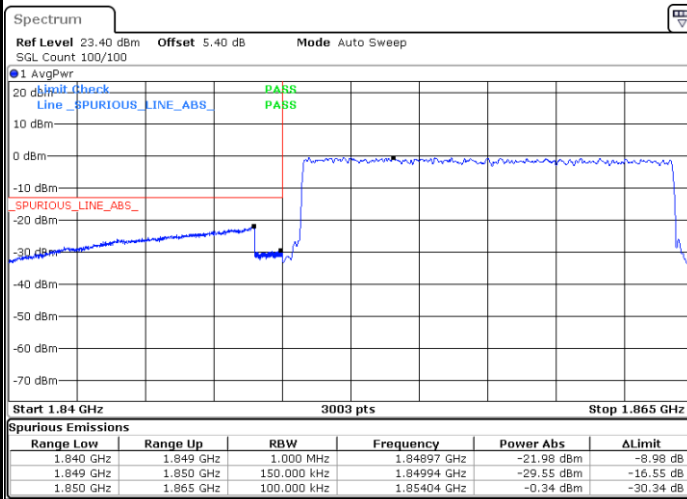

Date: 29.JAN.2021 13:16:25

Highest Band Edge / Full RB

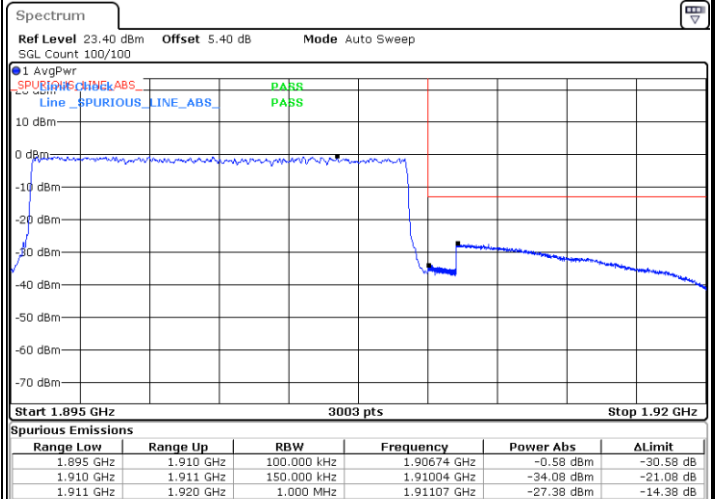

Date: 29.JAN.2021 13:22:27



LTE Band 2 / 20MHz / QPSK

Lowest Band Edge / 1 RB

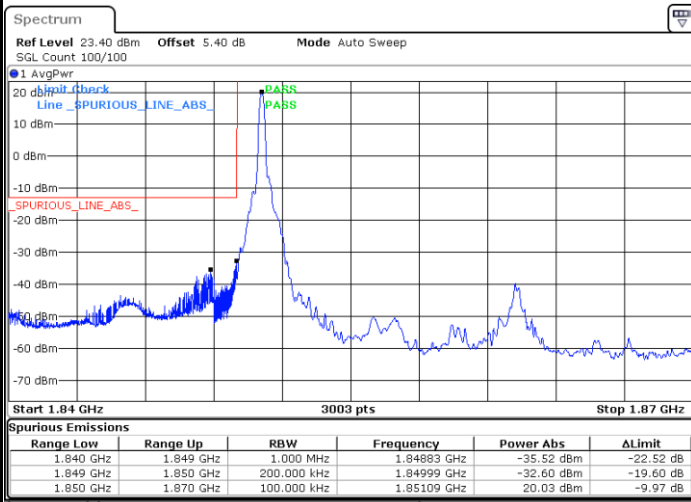

Date: 29.JAN.2021 13:26:43

Highest Band Edge / 1 RB

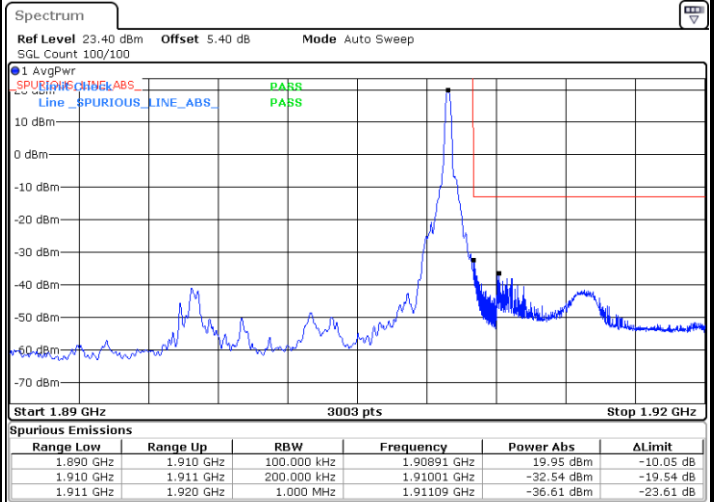

Date: 29.JAN.2021 13:35:13

Lowest Band Edge / Full RB

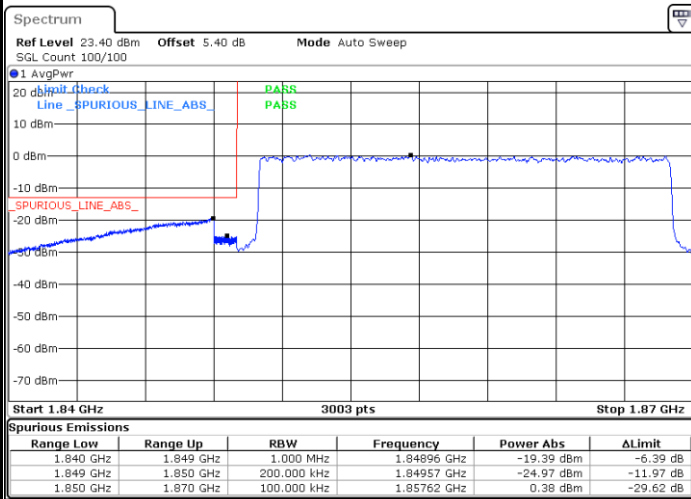

Date: 29.JAN.2021 13:24:29

Highest Band Edge / Full RB

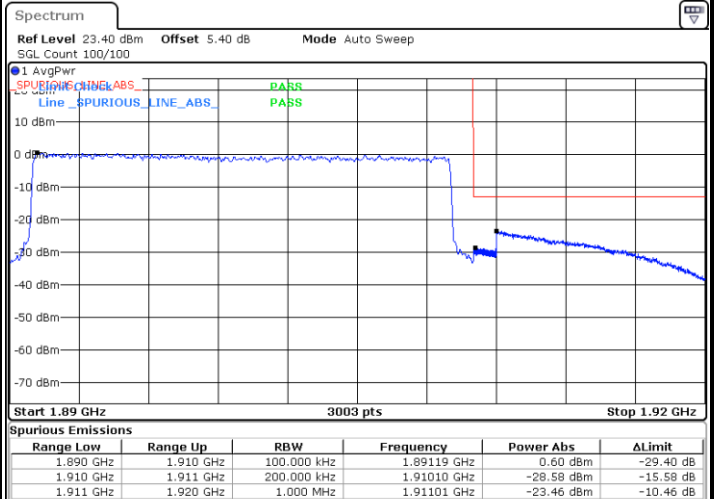

Date: 29.JAN.2021 13:33:33



LTE Band 2 / 20MHz / 16QAM

Lowest Band Edge / 1 RB

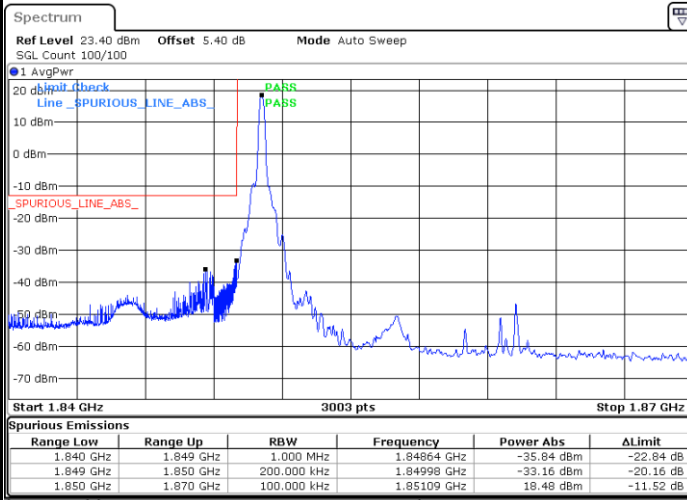

Date: 29.JAN.2021 13:26:17

Highest Band Edge / 1 RB



Date: 29.JAN.2021 13:34:58

Lowest Band Edge / Full RB

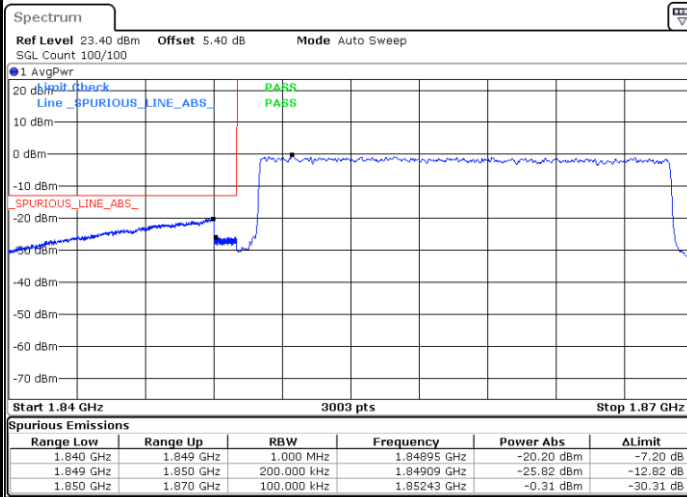

Date: 29.JAN.2021 13:25:21

Highest Band Edge / Full RB

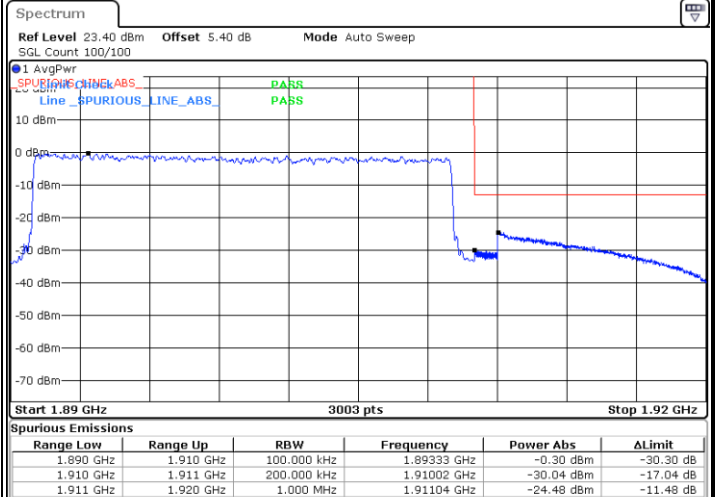

Date: 29.JAN.2021 13:33:54



LTE Band 2 / 20MHz / 64QAM

Lowest Band Edge / 1 RB

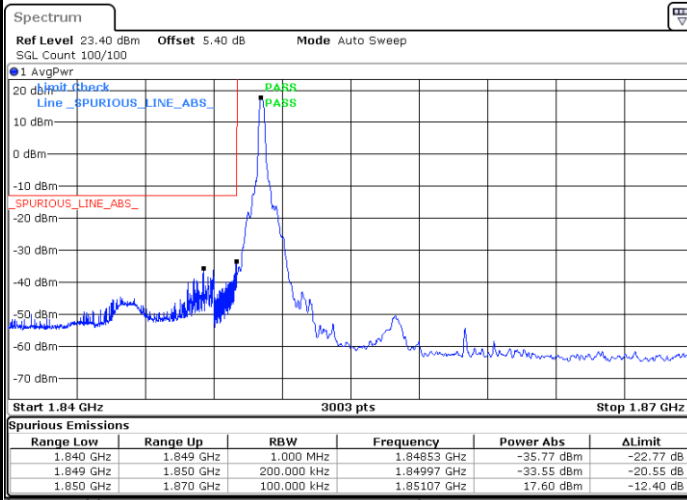

Date: 29.JAN.2021 13:26:05

Highest Band Edge / 1 RB

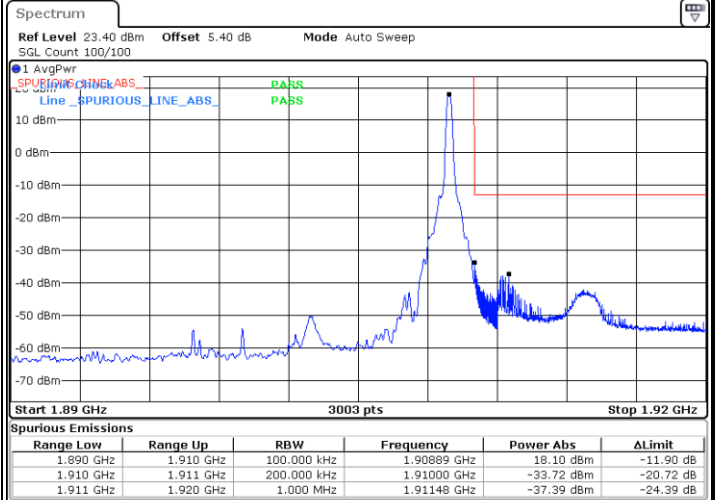

Date: 29.JAN.2021 13:34:40

Lowest Band Edge / Full RB

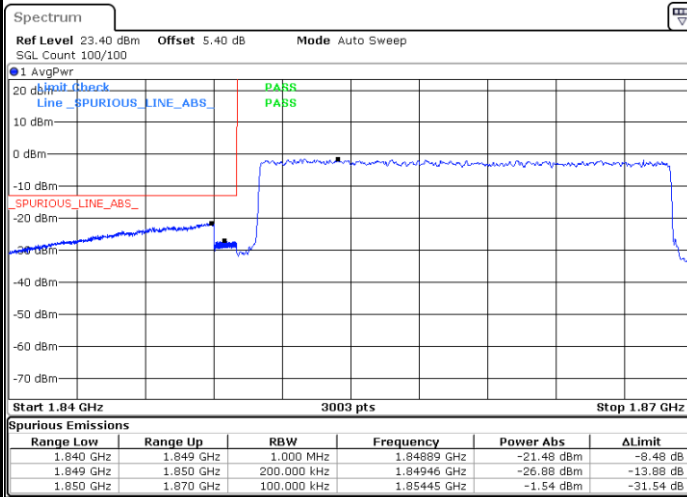

Date: 29.JAN.2021 13:25:41

Highest Band Edge / Full RB

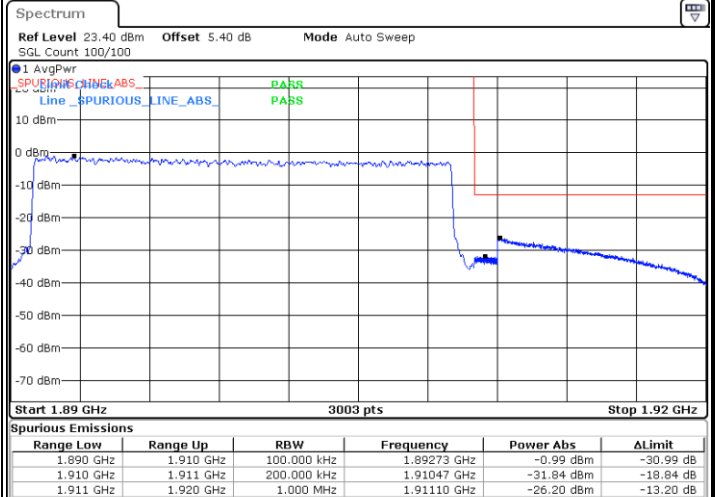

Date: 29.JAN.2021 13:34:09



Conducted Spurious Emission

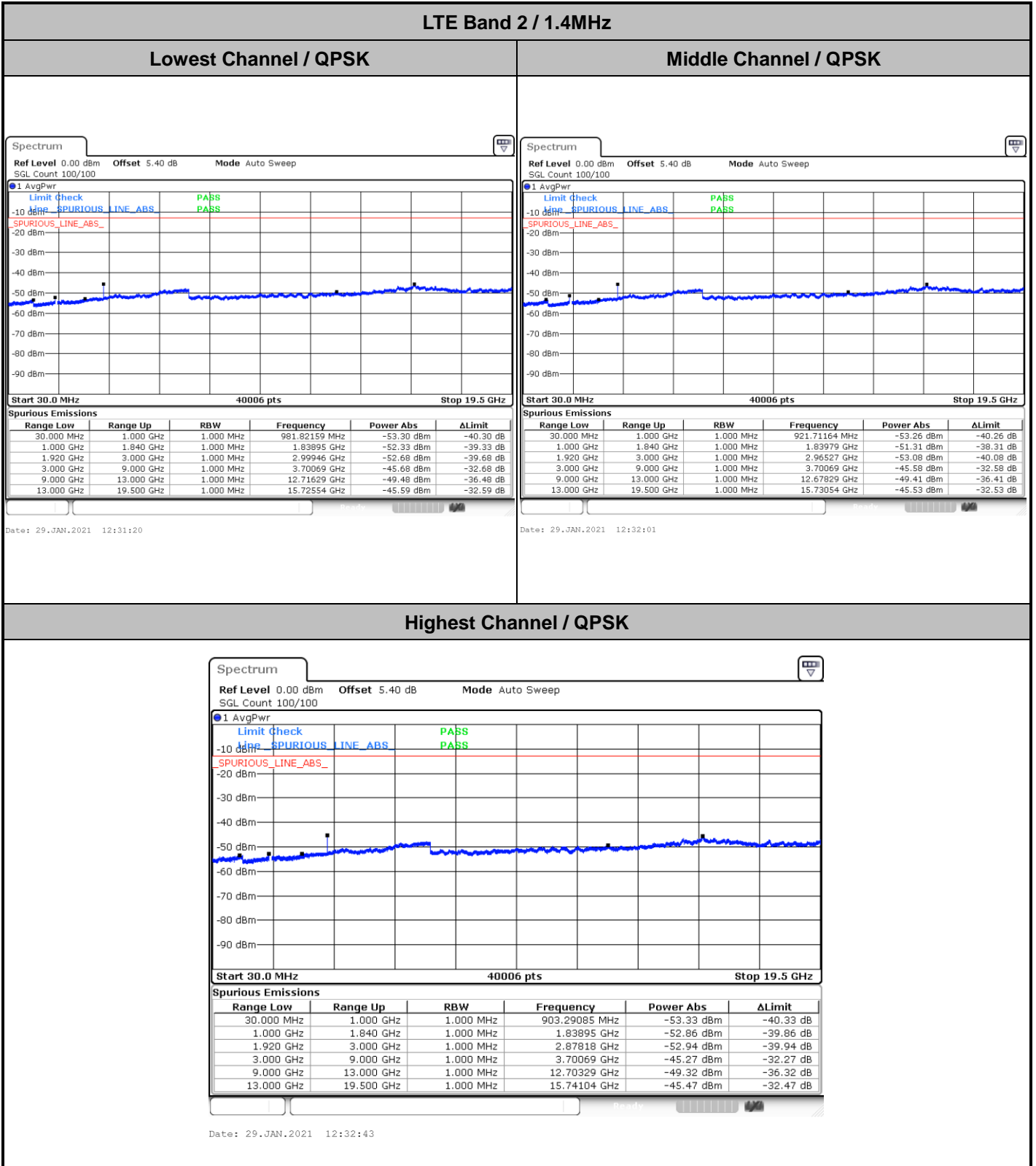



LTE Band 2 / 3MHz

Lowest Channel / QPSK

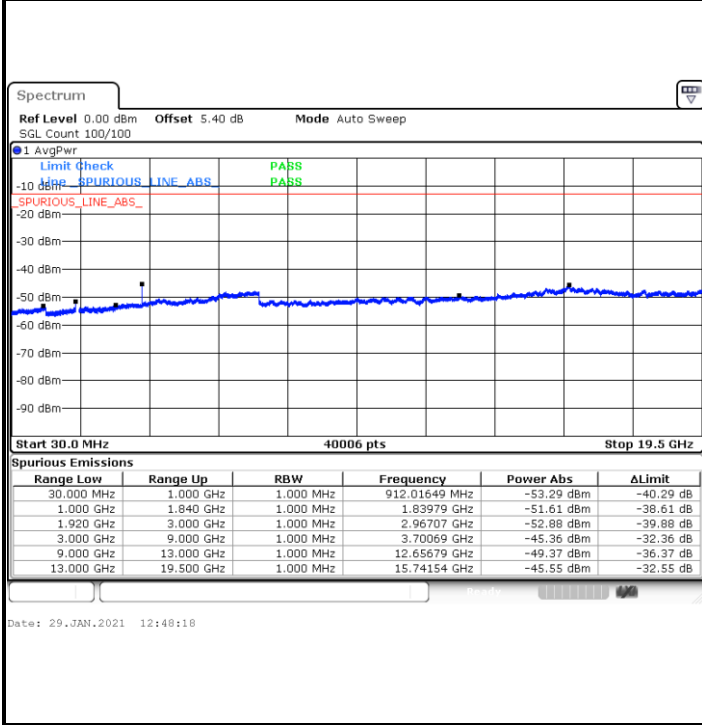

Middle Channel / QPSK

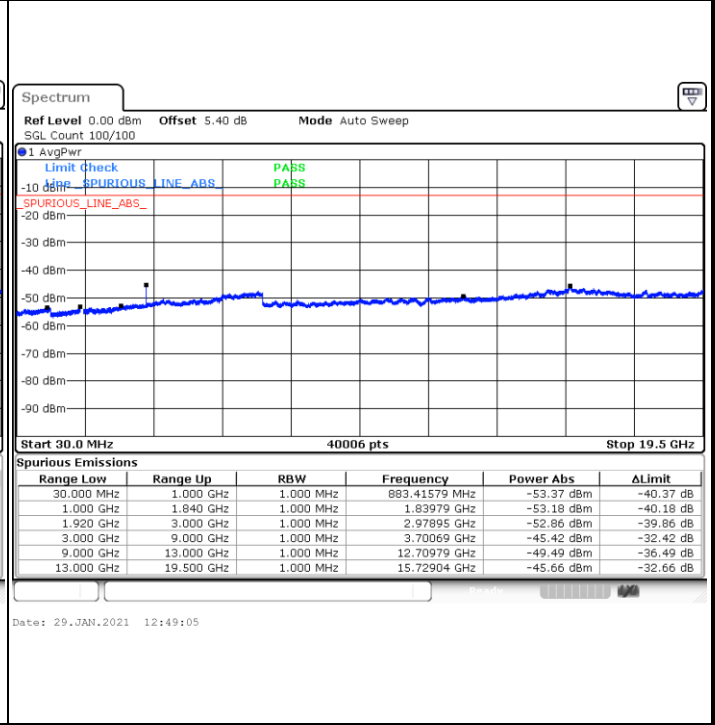

Highest Channel / QPSK

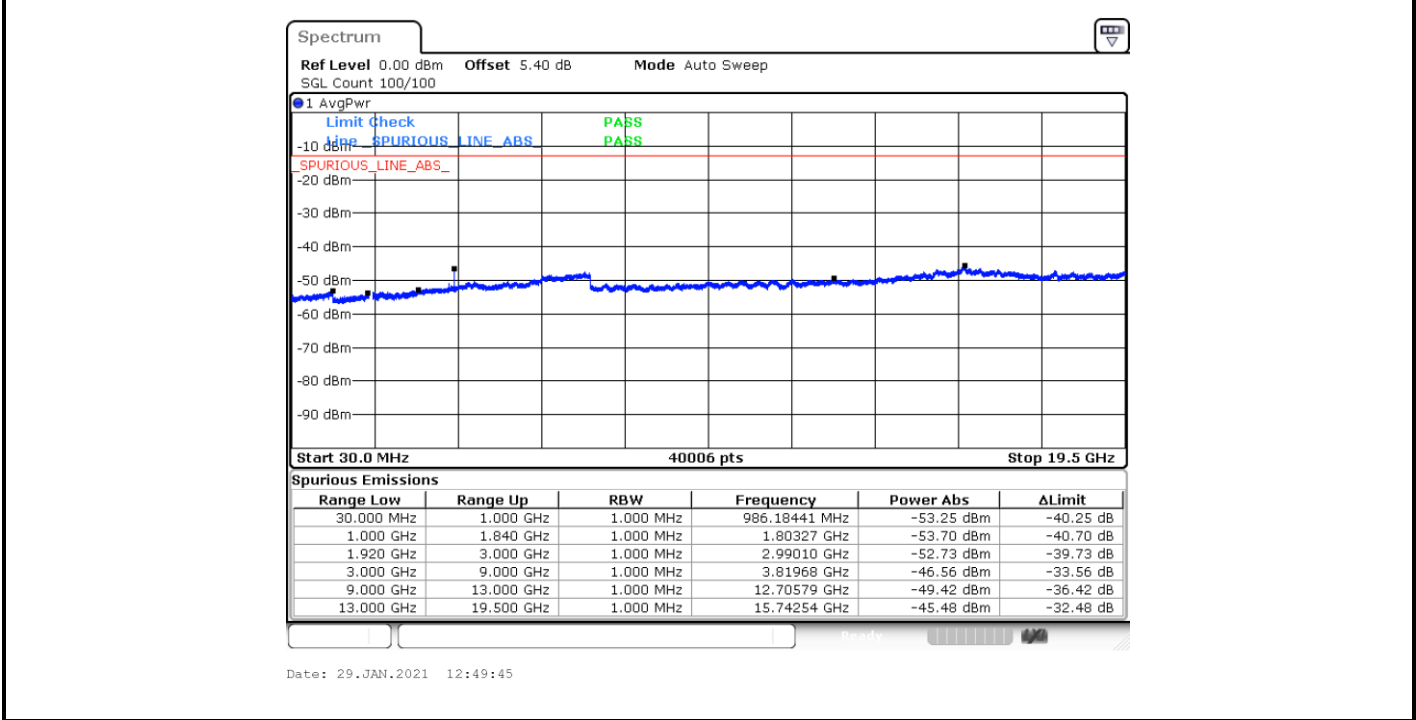



LTE Band 2 / 5MHz

Lowest Channel / QPSK

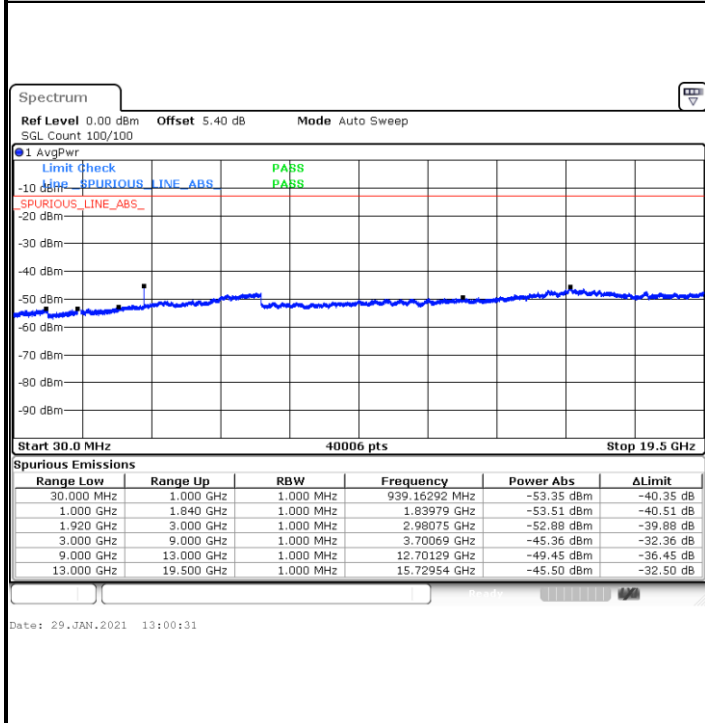

Middle Channel / QPSK

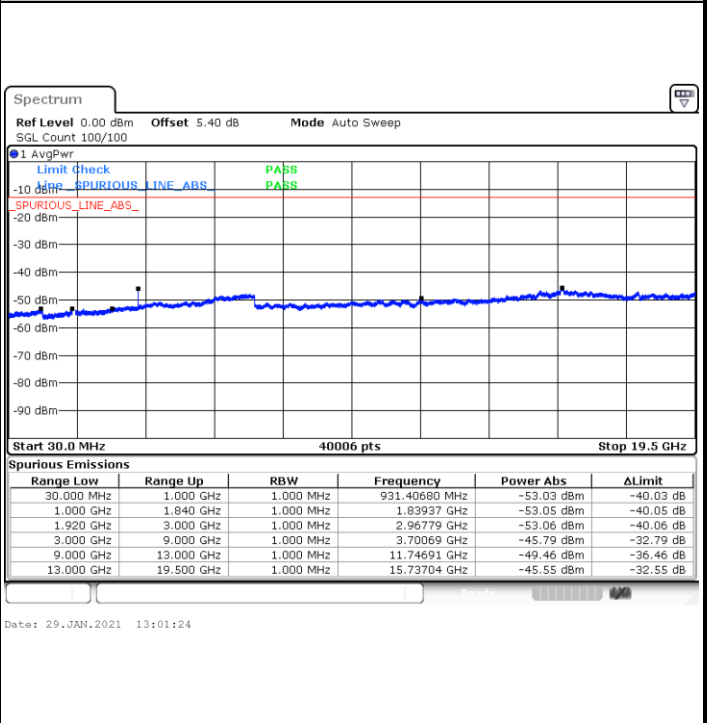

Highest Channel / QPSK

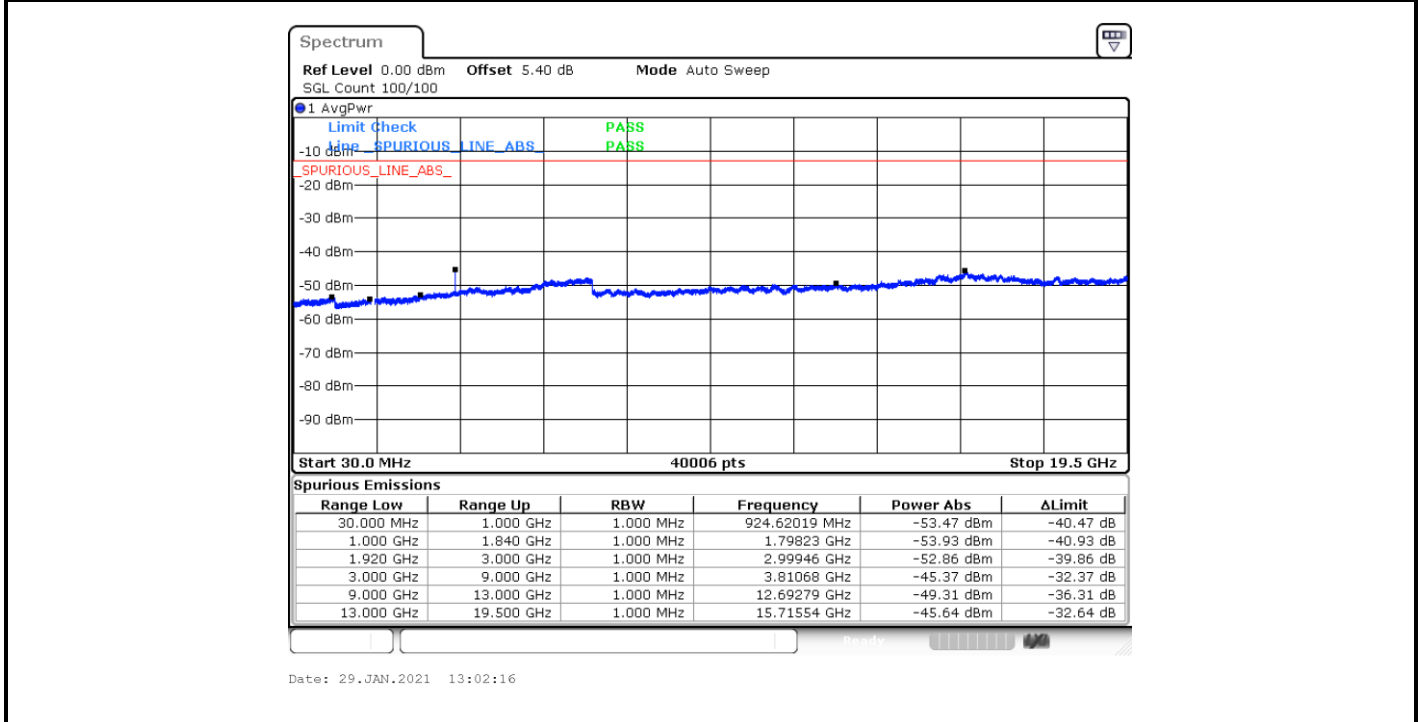



LTE Band 2 / 10MHz

Lowest Channel / QPSK

Middle Channel / QPSK

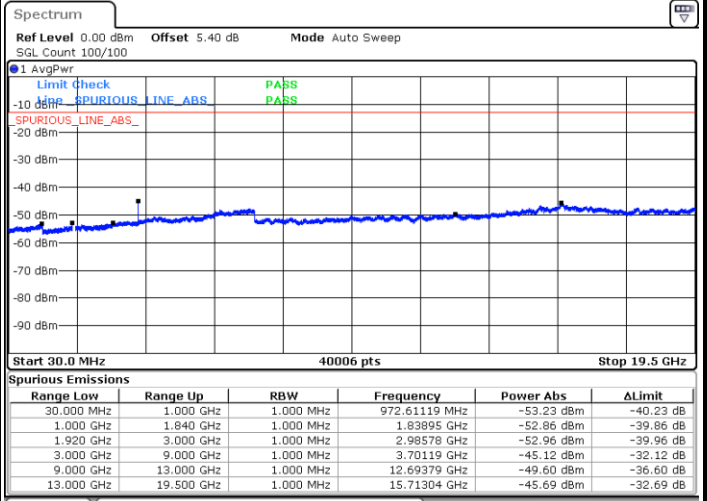
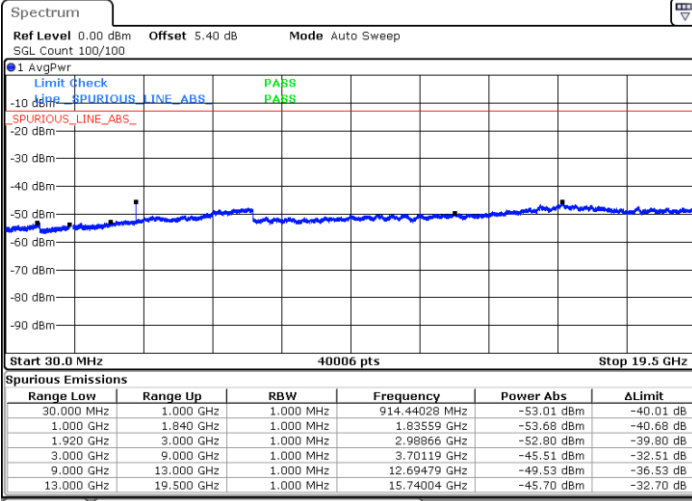

Date: 29.JAN.2021 13:09:00

Date: 29.JAN.2021 13:09:53

Highest Channel / QPSK

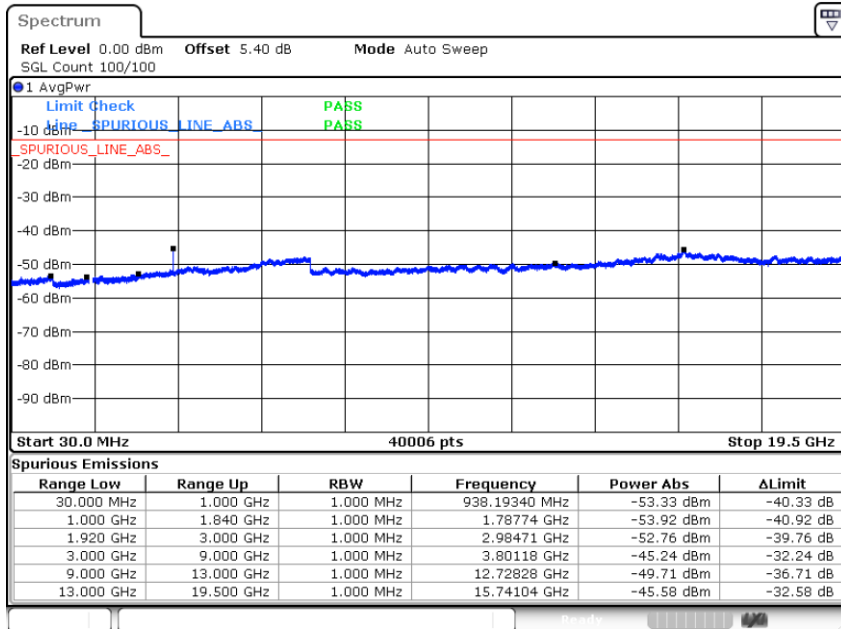

Date: 29.JAN.2021 13:11:02