



FCC RF Test Report

APPLICANT : Motorola Mobility LLC
EQUIPMENT : Mobile Cellular Phone
BRAND NAME : Motorola
MODEL NAME : XT2137-1
FCC ID : IHDT56ZT1
STANDARD : 47 CFR Part 2, 22, 27
CLASSIFICATION : PCS Licensed Transmitter Held to Ear (PCE)

The product was received on Jan. 21, 2021 and completely tested on Feb. 04, 2021. We, Sporton International (Kunshan) Inc., would like to declare that the tested sample has been evaluated in accordance with the procedures given in ANSI C63.26-2015 and shown compliance with the applicable technical standards.

The test results in this report apply exclusively to the tested model / sample. Without written approval of Sporton International (Kunshan) Inc., the test report shall not be reproduced except in full.

Jason Jia

Reviewed by: Jason Jia / Supervisor

James Huang

Approved by: James Huang / Manager



Sporton International (Kunshan) Inc.

**No. 1098, Pengxi North Road, Kunshan Economic Development Zone Jiangsu Province 215300
People's Republic of China**



TABLE OF CONTENTS

REVISION HISTORY 3
SUMMARY OF TEST RESULT 4
1 GENERAL DESCRIPTION 5
1.1 Applicant 5
1.2 Manufacturer 5
1.3 Product Feature of Equipment Under Test 5
1.4 Product Specification of Equipment Under Test 6
1.5 Specification of Accessory 7
1.6 Modification of EUT 7
1.7 Maximum ERP/EIRP Power, Frequency Tolerance, and Emission Designator 8
1.8 Testing Location 9
1.9 Test Software 9
1.10 Applicable Standards 9
2 TEST CONFIGURATION OF EQUIPMENT UNDER TEST 10
2.1 Test Mode 10
2.2 Connection Diagram of Test System 11
2.3 Support Unit used in test configuration and system 12
2.4 Measurement Results Explanation Example 12
2.5 Frequency List of Low/Middle/High Channels 13
3 CONDUCTED TEST ITEMS 16
3.1 Measuring Instruments 16
3.2 Test Setup 16
3.3 Test Result of Conducted Test 16
3.4 Conducted Output Power and ERP/EIRP 17
3.5 Peak-to-Average Ratio 18
3.6 Occupied Bandwidth 19
3.7 Conducted Band Edge 20
3.8 Conducted Spurious Emission 22
3.9 Frequency Stability 23
4 RADIATED TEST ITEMS 24
4.1 Measuring Instruments 24
4.2 Test Setup 24
4.3 Test Result of Radiated Test 24
4.4 Radiated Spurious Emission 25
5 LIST OF MEASURING EQUIPMENT 26
6 UNCERTAINTY OF EVALUATION 27
APPENDIX A. TEST RESULTS OF CONDUCTED TEST
APPENDIX B. TEST RESULTS OF RADIATED TEST
APPENDIX C. TEST SETUP PHOTOGRAPHS



REVISION HISTORY

REPORT NO.	VERSION	DESCRIPTION	ISSUED DATE
FG112101D	Rev. 01	Initial issue of report	Feb. 26, 2021



SUMMARY OF TEST RESULT

Report Section	FCC Rule	Description	Limit	Result	Remark
3.4	§2.1046	Conducted Output Power	Reporting Only	PASS	-
	§22.913(a)(5)	Effective Radiated Power (5G NR n5)	ERP < 7 Watt		
	§27.50(h)(2)	Equivalent Isotropic Radiated Power (5G NR n7)	EIRP < 2Watt		
	§27.50(j)(3)	Equivalent Isotropic Radiated Power (5G NR n77, n78)	EIRP < 1Watt		
3.5	§27.50(j)(4)	Peak-to-Average Ratio	<13 dB	PASS	-
3.6	§2.1049	Occupied Bandwidth	Reporting Only	PASS	-
3.7	§2.1051 §22.917(a) §27.53(l)(2)	Conducted Band Edge Measurement (5G NR n5) (5G NR n77, n78)	< 43+10log ₁₀ (P[Watts])	PASS	-
	§27.53(m)(4)	Conducted Band Edge Measurement (5G NR n7)	§27.53(m)(4)		
3.8	§2.1051 §22.917(a) §27.53(l)(2)	Conducted Spurious Emission (5G NR n5) (5G NR n77, n78)	< 43+10log ₁₀ (P[Watts])	PASS	-
	§2.1051 §27.53(m)(4)	Conducted Spurious Emission (5G NR n7)	< 55+10log ₁₀ (P[Watts])		
3.9	§2.1055 §22.355	Frequency Stability Temperature & Voltage	< 2.5 ppm for Part 22H	PASS	-
	§27.54		Within Authorized Band		
4.4	§2.1053 §22.917(a) §27.53(l)(2)	Radiated Spurious Emission (5G NR n5) (5G NR n77, n78)	< 43+10log ₁₀ (P[Watts])	PASS	Under limit 22.59 dB at 10100.000 MHz
	§2.1053 §27.53(m)(4)	Radiated Spurious Emission (5G NR n7)	< 55+10log ₁₀ (P[Watts])		

Declaration of Conformity:

The test results with all measurement uncertainty excluded are presented in accordance with the regulation limits or requirements declared by manufacturers.

Comments and Explanations:

The declared of product specification for EUT presented in the report are provided by the manufacturer, and the manufacturer takes all the responsibilities for the accuracy of product specification.



1 General Description

1.1 Applicant

Motorola Mobility LLC
222 W, Merchandise Mart Plaza, Chicago IL 60654 USA

1.2 Manufacturer

Motorola Mobility LLC
222 W, Merchandise Mart Plaza, Chicago IL 60654 USA

1.3 Product Feature of Equipment Under Test

Product Feature	
Equipment	Mobile Cellular Phone
Brand Name	Motorola
Model Name	XT2137-1
FCC ID	IHDT56ZT1
EUT supports Radios application	GSM/WCDMA/LTE/5G NR/NFC WLAN 2.4GHz 802.11b/g/n HT20 WLAN 5GHz 802.11a/n HT20/HT40 WLAN 5GHz 802.11ac VHT20/VHT40/VHT80 Bluetooth BR / EDR / LE FM Receiver / GNSS
IMEI Code	Conducted: 352355710026099/352355710026107 Radiation: 352355710024631/352355710024649
HW Version	DVT2
SW Version	RRF31.Q1-37
EUT Stage	Identical Prototype

Remark:

1. Only 5G NR bands are tested in this report, all the other RF bands are tested in the other reports separately.
2. There are two types of EUT, please refer to the product equality declaration exhibit submitted. According to the difference, we choose the sample 1 to full test.



1.4 Product Specification of Equipment Under Test

Standards-related Product Specification	
Tx Frequency	5G NR n5 : 824 MHz ~ 849 MHz 5G NR n7 : 2500 MHz ~ 2570 MHz 5G NR n77: 3700 MHz ~ 3980 MHz 5G NR n78: 3700 MHz ~ 3800 MHz
Rx Frequency	5G NR n5 : 869 MHz ~ 894 MHz 5G NR n7 : 2620 MHz ~ 2690 MHz 5G NR n77: 3700 MHz ~ 3980 MHz 5G NR n78: 3700 MHz ~ 3800 MHz
Bandwidth	n5, n7: 5MHz / 10MHz / 15MHz / 20MHz n77: 20MHz / 30MHz / 40MHz / 60MHz / 80MHz / 100MHz n78: 20MHz / 30MHz / 40MHz / 50MHz / 60MHz / 70MHz / 80MHz / 90MHz / 100MHz
SCS	n5, n7: 15kHz n77, n78: 30kHz
Antenna Gain	5G NR n5: -4.3 dBi 5G NR n7: -2.2 dBi 5G NR n77: -2.9 dBi 5G NR n78: -2.9 dBi
Type of Modulation	CP-OFDM: QPSK / 16QAM / 64QAM / 256QAM DFT-s-OFDM: PI/2 BPSK / QPSK / 16QAM / 64QAM / 256QAM

Remark:

5G NR only supports NSA mode (refer to the Operation Description). According to engineering evaluation, only the worst EN-DC combination mode show in the report.

1.5 Specification of Accessory

Specification of Accessory				
AC Adapter 1(US)	Brand Name	Motorola (Chenyang)	Model Name	MC-101
AC Adapter 1(EU)	Brand Name	Motorola (Chenyang)	Model Name	MC-102
AC Adapter 1(UK)	Brand Name	Motorola (Chenyang)	Model Name	MC-103
AC Adapter 1(AU)	Brand Name	Motorola (Chenyang)	Model Name	MC-105
AC Adapter 2(US)	Brand Name	Motorola (Salcomp)	Model Name	MC-101
AC Adapter 2(EU)	Brand Name	Motorola (Salcomp)	Model Name	MC-102
AC Adapter 2(UK)	Brand Name	Motorola (Salcomp)	Model Name	MC-103
AC Adapter 2(AU)	Brand Name	Motorola (Salcomp)	Model Name	MC-105
AC Adapter 2(Chile)	Brand Name	Motorola (Salcomp)	Model Name	MC-109
AC Adapter 3(US)	Brand Name	Motorola (AOHAI)	Model Name	MC-101
AC Adapter 3(EU)	Brand Name	Motorola (AOHAI)	Model Name	MC-102
Battery 1	Brand Name	Motorola (Sunwoda)	Model Name	JK50
Battery 2	Brand Name	Motorola (ATL)	Model Name	JK50
Earphone 1	Brand Name	Motorola (Lyand)	Model Name	MH191(SH38C81577)
Earphone 2	Brand Name	Motorola (LCHSE)	Model Name	MH191(SH38C81576)
USB Cable 1	Brand Name	Motorola (Saibao)	Model Name	SC18C24367
USB Cable 2	Brand Name	Motorola (Luxshare)	Model Name	SC18C24368
USB Cable 3	Brand Name	Motorola (Cabletech)	Model Name	SC18C49697

1.6 Modification of EUT

No modifications are made to the EUT during all test items.



1.7 Maximum ERP/EIRP Power, Frequency Tolerance, and Emission Designator

5G NR n5 (EN DC_7A-n5A)		PI/2 BPSK / QPSK		16QAM / 64QAM / 256QAM	
BW (MHz)	Frequency Range (MHz)	Emission Designator (99%OBW)	Maximum ERP(W)	Emission Designator (99%OBW)	Maximum ERP(W)
20	834.0 ~ 839.0	18M9G7D	0.0509	18M9W7D	0.0452
Frequency Tolerance (ppm)		0.0063			

5G NR n7 (EN DC_66A-n7A)		PI/2 BPSK / QPSK		16QAM / 64QAM / 256QAM	
BW (MHz)	Frequency Range (MHz)	Emission Designator (99%OBW)	Maximum EIRP(W)	Emission Designator (99%OBW)	Maximum EIRP(W)
20	2510.0 ~ 2560.0	18M9G7D	0.1383	18M9W7D	0.1122
Frequency Tolerance (ppm)		0.0025			

5G NR n77 (EN DC_41A-n77A)		PI/2 BPSK / QPSK		16QAM / 64QAM / 256QAM	
BW (MHz)	Frequency Range (MHz)	Emission Designator (99%OBW)	Maximum EIRP(W)	Emission Designator (99%OBW)	Maximum EIRP(W)
100	3750.0 ~ 3930.0	97M3G7D	0.1019	97M9W7D	0.0975
Frequency Tolerance (ppm)		0.0033			

5G NR n78 (EN DC_38A-n78A)		PI/2 BPSK / QPSK		16QAM / 64QAM / 256QAM	
BW (MHz)	Frequency Range (MHz)	Emission Designator (99%OBW)	Maximum EIRP(W)	Emission Designator (99%OBW)	Maximum EIRP(W)
100	3750.0	97M3G7D	0.1019	97M9W7D	0.0975
Frequency Tolerance (ppm)		0.0033			

Note:

- 5G NR Band n77 overlaps the entire frequency range of Band n78. Therefore, the test results provided in this report covers Band n77 as well as Band n78.
- Based on engineering evaluation, only the maximum bandwidth and the worst modulation test results are shown in the report.



1.8 Testing Location

Sporton International (Kunshan) Inc. is accredited to ISO/IEC 17025:2017 by American Association for Laboratory Accreditation with Certificate Number 5145.02.

Test Firm	Sporton International (Kunshan) Inc.		
Test Site Location	No. 1098, Pengxi North Road, Kunshan Economic Development Zone Jiangsu Province 215300 People's Republic of China TEL : +86-512-57900158 FAX : +86-512-57900958		
Test Site No.	Sporton Site No.	FCC Designation No.	FCC Test Firm Registration No.
	03CH04-KS TH01-KS	CN1257	314309

1.9 Test Software

Item	Site	Manufacturer	Name	Version
1.	03CH04-KS	AUDIX	E3	6.2009-8-24a

1.10 Applicable Standards

According to the specifications of the manufacturer, the EUT must comply with the requirements of the following standards:

- ♦ 47 CFR Part 2, 22, 27
- ♦ ANSI C63.26-2015
- ♦ FCC KDB 971168 D01 Power Meas License Digital Systems v03r01
- ♦ FCC KDB 412172 D01 Determining ERP and EIRP v01r01

Remark:

All test items were verified and recorded according to the standards and without any deviation during the test.

2 Test Configuration of Equipment Under Test

2.1 Test Mode

Antenna port conducted and radiated test items are performed according to KDB 971168 D01 Power Meas License Digital Systems v03r01 with maximum output power.

For radiated measurement, pre-scanned in three orthogonal panels, X, Y, Z. The worst cases (Y plane) were recorded in this report.

The device is investigated from 30MHz to 10 times of fundamental signal for radiated spurious emission test under different RB size/offset and modulations in exploratory test. Subsequently, only the worst case emissions are reported.

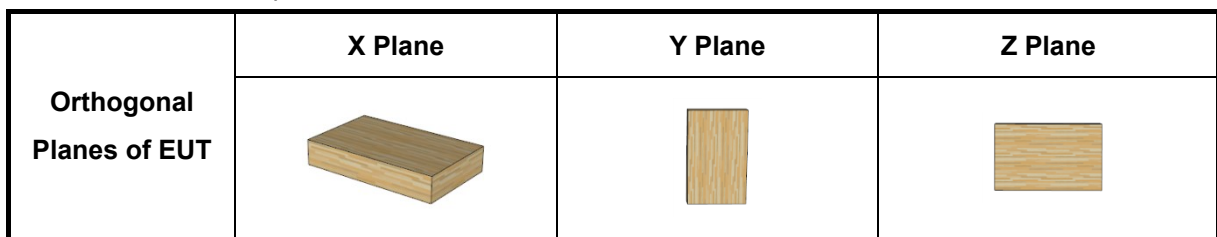

Test Items	5G NR	Bandwidth (MHz)						Modulation					RB #		Test Channel			
		5	10	15	20	30-90	100	PI/2 BPSK	QPSK	16QAM	64QAM	256 QAM	1	Full	L	M	H	
Max. Output Power	n5	v	v	v	v	-	-	v	v	v	v	v	v	v	v	v	v	v
	n7	v	v	v	v	-	-	v	v	v	v	v	v	v	v	v	v	v
	n77	-	-	-	v	v	v	v	v	v	v	v	v	v	v	v	v	v
	n78	-	-	-	v	v	v	v	v	v	v	v	v	v	v	v	v	v
Peak-to-Average Ratio	n5				v	-	-		v					v		v		
	n7				v	-	-		v					v		v		
	n77	-	-	-			v		v					v		v		
26dB and 99% Bandwidth	n5				v	-	-		v	v				v		v		
	n7				v	-	-		v	v				v		v		
	n77	-	-	-			v		v	v				v		v		
Conducted Band Edge	n5	v	v	v	v	-	-	v	v	v	v	v	v	v	v		v	
	n7	v	v	v	v	-	-	v	v	v	v	v	v	v	v		v	
	n77	-	-	-	v	v	v	v	v	v	v	v	v	v	v		v	
Conducted Spurious Emission	n5	v	v	v	v	-	-		v					v		v	v	v
	n7	v	v	v	v	-	-		v					v		v	v	v
	n77	-	-	-	v	v	v		v					v		v	v	v



Test Items	5G NR	Bandwidth (MHz)						Modulation					RB #		Test Channel			
		5	10	15	20	30-90	100	PI/2 BPSK	QPSK	16QAM	64QAM	256 QAM	1	Full	L	M	H	
Frequency Stability	n5				v	-	-		v				v			v		
	n7				v	-	-		v				v			v		
	n77	-	-	-			v		v				v			v		
E.R.P / E.I.R.P	n5	v	v	v	v	-	-	v	v	v	v	v	v	v	v	v	v	
	n7	v	v	v	v	-	-	v	v	v	v	v	v	v	v	v	v	
	n77	-	-	-	v	v	v	v	v	v	v	v	v	v	v	v	v	
Radiated Spurious Emission	n5	Worst Case															v	
	n7	Worst Case															v	
	n77	Worst Case															v	
Note	<ol style="list-style-type: none"> The mark "v" means that this configuration is chosen for testing The mark "-" means that this bandwidth is not supported. The device is investigated from 30MHz to 10 times of fundamental signal for radiated spurious emission test under different RB size/offset and modulations in exploratory test. Subsequently, only the worst case emissions are reported. All modulations (BPSK/QPSK/16QAM/64QAM/256QAM) have been tested, and only the worst test results are shown in the report . All test items are based on engineering evaluation. 																	

2.2 Connection Diagram of Test System

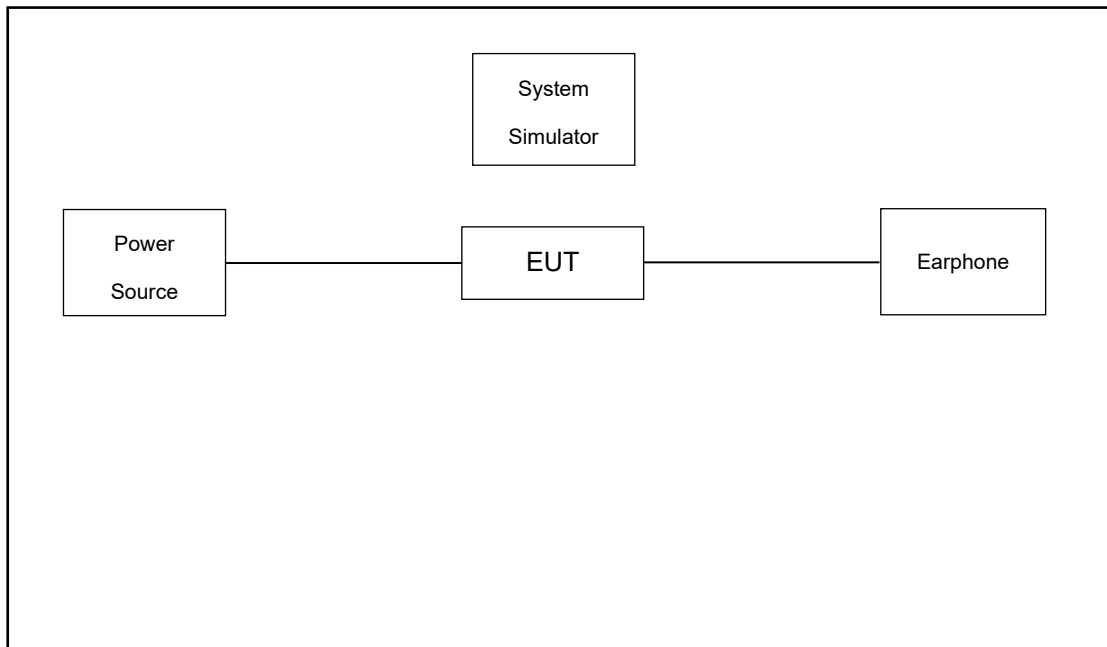



2.3 Support Unit used in test configuration and system

Item	Equipment	Trade Name	Model No.	FCC ID	Data Cable	Power Cord
1.	DC Power Supply	GW	GPS-3030D	N/A	N/A	Unshielded, 1.8 m
2.	LTE Base Station	Anritsu	MT8820C	N/A	N/A	Unshielded, 1.8 m
3.	NR Base Station	Anritsu	MT8000A	N/A	N/A	Unshielded, 1.8 m

2.4 Measurement Results Explanation Example

For all conducted test items:

The offset level is set in the spectrum analyzer to compensate the RF cable loss between EUT conducted output port and spectrum analyzer. With the offset compensation, the spectrum analyzer reading level is exactly the EUT RF output level.

The spectrum analyzer offset is derived from RF cable loss.

Offset = RF cable loss.

Following shows an offset computation example with cable loss 5.0 dB.

Example :

$$\begin{aligned} \text{Offset(dB)} &= \text{RF cable loss(dB)}. \\ &= 5.0 \text{ (dB)} \end{aligned}$$



2.5 Frequency List of Low/Middle/High Channels

5G NR n5 Channel and Frequency List				
BW [MHz]	Channel/Frequency(MHz)	Lowest	Middle	Highest
20	Channel	166800	167300	167800
	Frequency	834	836.5	839
15	Channel	166300	167300	168300
	Frequency	831.5	836.5	841.5
10	Channel	165800	167300	168800
	Frequency	829	836.5	844
5	Channel	165300	167300	169300
	Frequency	826.5	836.5	846.5

5G NR n7 Channel and Frequency List				
BW [MHz]	Channel/Frequency(MHz)	Lowest	Middle	Highest
20	Channel	502000	507000	512000
	Frequency	2510	2535	2560
15	Channel	501500	507000	512500
	Frequency	2507.5	2535	2562.5
10	Channel	501000	507000	513000
	Frequency	2505	2535	2565
5	Channel	500500	507000	513500
	Frequency	2502.5	2535	2567.5



5G NR n77 Channel and Frequency List				
BW [MHz]	Channel/Frequency(MHz)	Lowest	Middle	Highest
100	Channel	650000	656000	662000
	Frequency	3750	3840	3930
80	Channel	649334	656000	662668
	Frequency	3740.01	3840	3940.02
60	Channel	648668	656000	663334
	Frequency	3730.02	3840	3950.01
40	Channel	648000	656000	664000
	Frequency	3720	3840	3960
30	Channel	647668	656000	664334
	Frequency	3715.02	3840	3965.01
20	Channel	647334	656000	664668
	Frequency	3710.01	3840	3970.02



5G NR n78 Channel and Frequency List				
BW [MHz]	Channel/Frequency(MHz)	Lowest	Middle	Highest
100	Channel	650000		
	Frequency	3750		
90	Channel	649668	650000	650334
	Frequency	3745.02	3750	3755.01
80	Channel	649334	650000	650668
	Frequency	3740.01	3750	3760.02
70	Channel	649000	650000	651000
	Frequency	3735	3750	3765
60	Channel	648668	650000	651334
	Frequency	3730.02	3750	3770.01
50	Channel	648334	650000	651668
	Frequency	3725.01	3750	3775.02
40	Channel	648000	650000	652000
	Frequency	3720	3750	3780
30	Channel	647668	650000	652334
	Frequency	3715.02	3750	3785.01
20	Channel	647334	650000	652668
	Frequency	3710.01	3750	3790.02

3 Conducted Test Items

3.1 Measuring Instruments

See list of measuring instruments of this test report.

3.2 Test Setup

3.2.1 Conducted Output Power

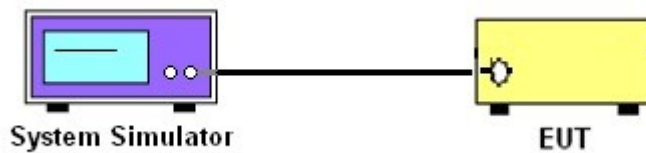

3.2.2 Peak-to-Average Ratio, Occupied Bandwidth, Conducted Band-Edge and Conducted Spurious Emission



3.2.3 Frequency Stability

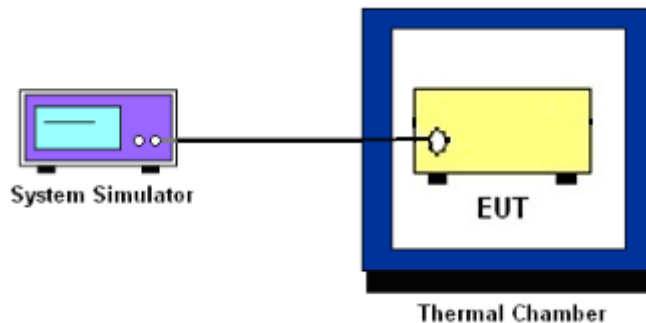

3.3 Test Result of Conducted Test

Please refer to Appendix A.



3.4 Conducted Output Power and ERP/EIRP

3.4.1 Description of the Conducted Output Power Measurement and ERP/EIRP Measurement

A system simulator was used to establish communication with the EUT. Its parameters were set to force the EUT transmitting at maximum output power. The measured power in the radio frequency on the transmitter output terminals shall be reported.

The ERP of mobile transmitters must not exceed 7 Watts for 5G NR n5.

The EIRP of mobile transmitters must not exceed 2 Watts for 5G NR n7.

The EIRP of mobile transmitters must not exceed 1 Watts for 5G NR n77 and n78.

According to KDB 412172 D01 Power Approach,

$EIRP = P_T + G_T - L_C$, $ERP = EIRP - 2.15$, where

P_T = transmitter output power in dBm

G_T = gain of the transmitting antenna in dBi

L_C = signal attenuation in the connecting cable between the transmitter and antenna in dB

3.4.2 Test Procedures

1. The testing follows ANSI C63.26 Section 5.2
2. The transmitter output port was connected to the system simulator.
3. Set EUT at maximum power through the system simulator.
4. Select lowest, middle, and highest channels for each band and different modulation.
5. Measure and record the power level from the system simulator.



3.5 Peak-to-Average Ratio

3.5.1 Description of the PAR Measurement

Power Complementary Cumulative Distribution Function (CCDF) curves provide a means for characterizing the power peaks of a digitally modulated signal on a statistical basis. A CCDF curve depicts the probability of the peak signal amplitude exceeding the average power level. Most contemporary measurement instrumentation include the capability to produce CCDF curves for an input signal provided that the instrument's resolution bandwidth can be set wide enough to accommodate the entire input signal bandwidth. In measuring transmissions in this band using an average power technique, the peak-to-average ratio (PAR) of the transmission may not exceed 13 dB.

3.5.2 Test Procedures

For Band n5/n7:

1. The testing follows ANSI C63.26 Section 5.2.3.4 (CCDF).
2. The EUT was connected to spectrum and system simulator via a power divider.
3. Set the CCDF (Complementary Cumulative Distribution Function) option in spectrum analyzer.
4. The highest RF powers were measured and recorded the maximum PAPR level associated with a probability of 0.1 %.
5. Record the deviation as Peak to Average Ratio.

For Band n77:

1. The testing follows ANSI C63.26 Section 5.2.6 (PAPR).
2. The EUT was connected to spectrum and system simulator via a power divider.
3. Set EUT in maximum power output.
4. Set the RBW = 1MHz, VBW = 3MHz, Detector = Peak, Trace mode = max hold, Set span $\geq 2 \times$ OBW in spectrum analyzer.
5. Set the RBW = 1MHz, VBW = 3MHz, Detector = power averaging, Trace mode = max hold, Set span $\geq 2 \times$ OBW in spectrum analyzer.
6. Add $[10 \log (1/\text{duty cycle})]$ to the measured maximum power level to compute the average power during continuous transmission.
7. $\text{PAPR (dB)} = P_{Pk} \text{ (dBm)} - P_{Avg} \text{ (dBm)}$

where

PAPR peak-to-average power ratio, in dB

P_{Pk} measured peak power level, in dBm

P_{Avg} measured average power level, in dBm

8. Record the deviation as Peak to Average Ratio.



3.6 Occupied Bandwidth

3.6.1 Description of Occupied Bandwidth Measurement

The occupied bandwidth is the width of a frequency band such that, below the lower and above the upper frequency limits, the mean powers emitted are each equal to a specified percentage 0.5% of the total mean transmitted power.

The 26 dB emission bandwidth is defined as the frequency range between two points, one above and one below the carrier frequency, at which the spectral density of the emission is attenuated 26 dB below the maximum in-band spectral density of the modulated signal. Spectral density (power per unit bandwidth) is to be measured with a detector of resolution bandwidth equal to approximately 1.0% of the emission bandwidth.

3.6.2 Test Procedures

1. The testing follows ANSI C63.26 Section 5.4
2. The EUT was connected to spectrum analyzer and system simulator via a power divider.
3. The spectrum analyzer center frequency is set to the nominal EUT channel center frequency. The span range for the spectrum analyzer shall be between two and five times the anticipated OBW.
4. The nominal resolution bandwidth (RBW) shall be in the range of 1 to 5 % of the anticipated OBW, and the VBW shall be at least 3 times the RBW.
5. Set the detection mode to peak, and the trace mode to max hold.
6. Determine the reference value: Set the EUT to transmit a modulated signal. Allow the trace to stabilize. Set the spectrum analyzer marker to the highest level of the displayed trace.
(this is the reference value)
7. Determine the “-26 dB down amplitude” as equal to (Reference Value – X).
8. Place two markers, one at the lowest and the other at the highest frequency of the envelope of the spectral display such that each marker is at or slightly below the “-X dB down amplitude” determined in step 6. If a marker is below this “-X dB down amplitude” value it shall be placed as close as possible to this value. The OBW is the positive frequency difference between the two markers.
9. Use the 99 % power bandwidth function of the spectrum analyzer and report the measured bandwidth.



3.7 Conducted Band Edge

3.7.1 Description of Conducted Band Edge Measurement

22.917(a)

For operations in the 824 – 849 MHz band, the FCC limit is $43 + 10\log_{10}(P[\text{Watts}])$ dB below the transmitter power P(Watts) in a 100kHz bandwidth. However, in the 1MHz bands immediately outside and adjacent to the licensee's frequency block, a resolution bandwidth of at least one percent of the emission bandwidth of the fundamental emission of the transmitter may be employed.

27.53(m)(4)

For mobile digital stations, the attenuation factor shall be not less than $40 + 10 \log (P)$ dB on all frequencies between the channel edge and 5 megahertz from the channel edge, $43 + 10 \log (P)$ dB on all frequencies between 5 megahertz and X megahertz from the channel edge, and $55 + 10 \log (P)$ dB on all frequencies more than X megahertz from the channel edge, where X is the greater of 6 megahertz or the actual emission bandwidth as defined in paragraph (m)(6) of this section. In addition, the attenuation factor shall not be less that $43 + 10 \log (P)$ dB on all frequencies between 2490.5 MHz and 2496 MHz and $55 + 10 \log (P)$ dB at or below 2490.5 MHz. Mobile Satellite Service licensees operating on frequencies below 2495 MHz may also submit a documented interference complaint against BRS licensees operating on channel BRS Channel 1 on the same terms and conditions as adjacent channel BRS or EBS licensees.

27.53(l)(2)

For mobile operations in the 3700-3980 MHz band, the conducted power of any emission outside the licensee's authorized bandwidth shall not exceed -13 dBm/MHz. Compliance with this paragraph is based on the use of measurement instrumentation employing a resolution bandwidth of 1 megahertz or greater. However, in the 1 megahertz bands immediately outside and adjacent to the licensee's frequency block, the minimum resolution bandwidth for the measurement shall be either one percent of the emission bandwidth of the fundamental emission of the transmitter or 350 kHz. In the bands between 1 and 5 MHz removed from the licensee's frequency block, the minimum resolution bandwidth for the measurement shall be 500 kHz.



3.7.2 Test Procedures

1. The testing follows ANSI C63.26 section 5.7
2. The EUT was connected to spectrum analyzer and system simulator via a power divider.
3. The band edges of low and high channels for the highest RF powers were measured.
4. Set RBW \geq 1% EBW in the 1MHz band immediately outside and adjacent to the band edge.
5. Beyond the 1 MHz band from the band edge, RBW=1MHz was used.
6. Set spectrum analyzer with RMS detector.
7. The RF fundamental frequency should be excluded against the limit line in the operating frequency band.
8. Checked that all the results comply with the emission limit line.

Example:

The limit line is derived from $43 + 10\log(P)$ dB below the transmitter power P(Watts)

$$= P(W) - [43 + 10\log(P)] \text{ (dB)}$$

$$= [30 + 10\log(P)] \text{ (dBm)} - [43 + 10\log(P)] \text{ (dB)} = -13\text{dBm}.$$

9. For 5G NR n7, the other 40 dB, and 55 dB have additionally applied same calculation above.



3.8 Conducted Spurious Emission

3.8.1 Description of Conducted Spurious Emission Measurement

The power of any emission outside of the authorized operating frequency ranges must be lower than the transmitter power (P) by a factor of at least $43 + 10 \log (P)$ dB.

For 5G NR n7:

The power of any emission outside of the authorized operating frequency ranges must be lower than the transmitter power (P) by a factor of at least $55 + 10 \log (P)$ dB.

It is measured by means of a calibrated spectrum analyzer and scanned from 30 MHz up to a frequency including its 10th harmonic.

3.8.2 Test Procedures

1. The testing follows ANSI C63.26 section 5.7
2. The EUT was connected to spectrum analyzer and system simulator via a power divider.
3. The RF output of EUT was connected to the spectrum analyzer by RF cable and attenuator. The path loss was compensated to the results for each measurement.
4. The middle channel for the highest RF power within the transmitting frequency was measured.
5. The conducted spurious emission for the whole frequency range was taken.
6. Make the measurement with the spectrum analyzer's RBW = 1MHz, VBW = 3MHz.
7. Set spectrum analyzer with RMS detector.
8. Taking the record of maximum spurious emission.
9. The RF fundamental frequency should be excluded against the limit line in the operating frequency band.
10. The limit line is derived from $43 + 10\log(P)$ dB below the transmitter power P(Watts)
= $P(W) - [43 + 10\log(P)]$ (dB)
= $[30 + 10\log(P)]$ (dBm) - $[43 + 10\log(P)]$ (dB)
= -13dBm.
11. For 5G NR n7
The limit line is derived from $55 + 10\log(P)$ dB below the transmitter power P(Watts)
= $P(W) - [55 + 10\log(P)]$ (dB)
= $[30 + 10\log(P)]$ (dBm) - $[55 + 10\log(P)]$ (dB)
= -25dBm.



3.9 Frequency Stability

3.9.1 Description of Frequency Stability Measurement

The frequency stability shall be measured by variation of ambient temperature and variation of primary supply voltage to ensure that the fundamental emission stays within the authorized frequency block. The frequency stability of the transmitter shall be maintained within $\pm 0.00025\%$ ($\pm 2.5\text{ppm}$) of the center frequency.

3.9.2 Test Procedures for Temperature Variation

1. The testing follows ANSI C63.26 section 5.6.4
2. The EUT was set up in the thermal chamber and connected with the system simulator.
3. With power OFF, the temperature was decreased to -30°C and the EUT was stabilized before testing. Power was applied and the maximum change in frequency was recorded within one minute.
4. With power OFF, the temperature was raised in 10°C step up to 50°C . The EUT was stabilized at each step for at least half an hour. Power was applied and the maximum frequency change was recorded within one minute.

3.9.3 Test Procedures for Voltage Variation

1. The testing follows ANSI C63.26 section 5.6.5
2. The EUT was placed in a temperature chamber at $20\pm 5^{\circ}\text{C}$ and connected with the system simulator.
3. The power supply voltage to the EUT was varied from 85% to 115% of the nominal value for other than hand carried battery equipment.
4. For hand carried, battery powered equipment, reduce the primary ac or dc supply voltage to the battery operating end point, which shall be specified by the manufacturer.
5. The variation in frequency was measured for the worst case.

4 Radiated Test Items

4.1 Measuring Instruments

See list of measuring instruments of this test report.

4.2 Test Setup

4.2.1 For radiated test from 30MHz to 1GHz

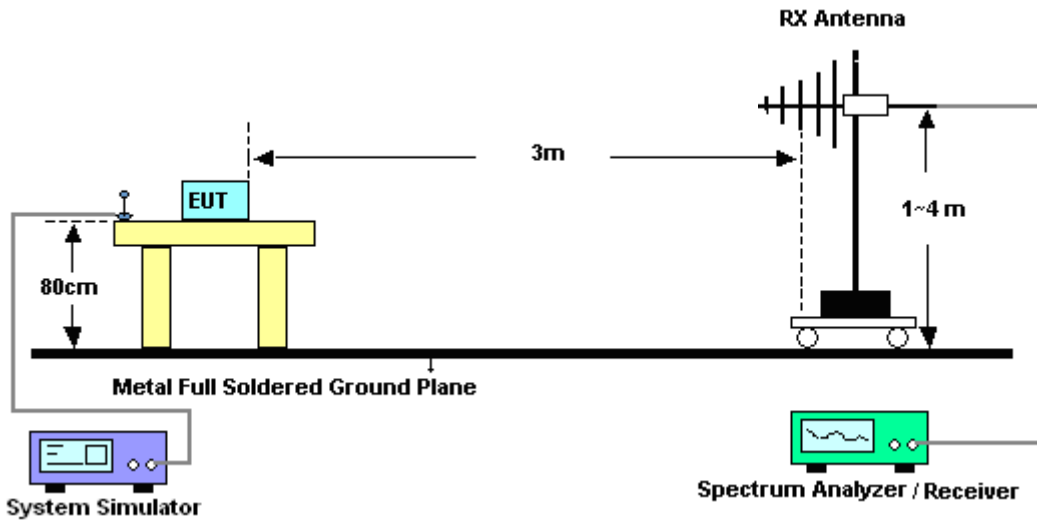

4.2.2 For radiated test above 1GHz

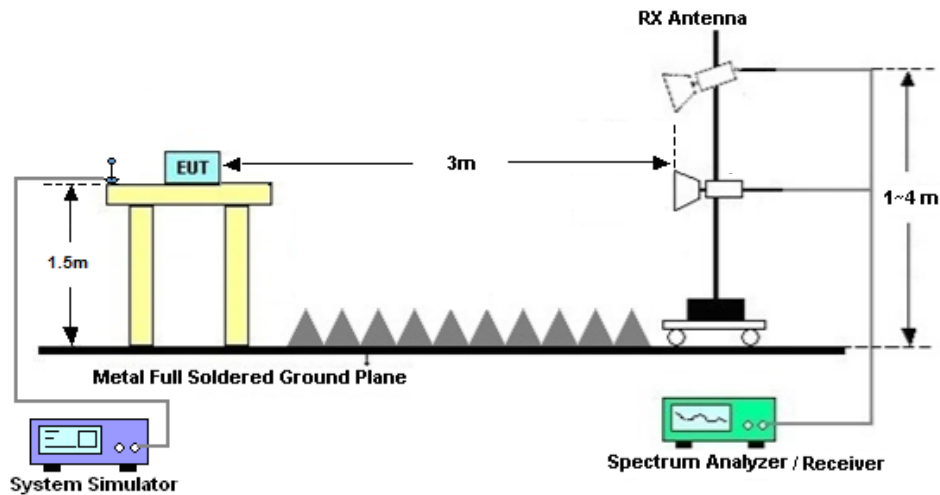

4.3 Test Result of Radiated Test

Please refer to Appendix B.



4.4 Radiated Spurious Emission

4.4.1 Description of Radiated Spurious Emission

The radiated spurious emission was measured by substitution method according to ANSI C63.26. The power of any emission outside of the authorized operating frequency ranges must be attenuated below the transmitter power (P) by a factor of at least $43 + 10 \log (P)$ dB.

For 5G NR n7

The power of any emission outside of the authorized operating frequency ranges must be attenuated below the transmitter power (P) by a factor of at least $55 + 10 \log (P)$ dB.

The spectrum is scanned from 30 MHz up to a frequency including its 10th harmonic.

4.4.2 Test Procedures

1. The testing follows ANSI C63.26 Section 5.5
2. The EUT was placed on a turntable with 0.8 meter height for frequency below 1GHz and 1.5 meter height for frequency above 1GHz respectively above ground.
3. The EUT was set 3 meters from the receiving antenna mounted on the antenna tower.
4. The table was rotated 360 degrees to determine the position of the highest spurious emission.
5. The height of the receiving antenna is varied between 1m to 4m to search the maximum spurious emission for both horizontal and vertical polarizations.
6. During the measurement, the system simulator parameters were set to force the EUT transmitting at maximum output power.
7. Make the measurement with the spectrum analyzer's RBW = 1MHz, VBW = 3MHz, taking the record of maximum spurious emission.
8. A horn antenna was substituted in place of the EUT and was driven by a signal generator.
9. Tune the output power of signal generator to the same emission level with EUT maximum spurious emission.
10. $EIRP (dBm) = S.G. Power - Tx Cable Loss + Tx Antenna Gain$
11. $ERP (dBm) = EIRP - 2.15$
12. The RF fundamental frequency should be excluded against the limit line in the operating frequency band.

The limit line is derived from $43 + 10\log(P)$ dB below the transmitter power P(Watts)
 $= P(W) - [43 + 10\log(P)] (dB)$
 $= [30 + 10\log(P)] (dBm) - [43 + 10\log(P)] (dB)$
 $= -13dBm.$

13. For 5G NR n7:

The limit line is derived from $55 + 10\log(P)$ dB below the transmitter power P(Watts)The limit line is derived from $55 + 10\log(P)$ dB below the transmitter power P(Watts)



5 List of Measuring Equipment

Instrument	Manufacturer	Model No.	Serial No.	Characteristics	Calibration Date	Test Date	Due Date	Remark
Spectrum Analyzer	R&S	FSV40	101040	10Hz~40GHz	Nov. 01, 2020	Feb. 03, 2021~ Feb. 04, 2021	Oct. 31, 2021	Conducted (TH01-KS)
Temperature & humidity chamber	Hongzhan	LP-150U	H2014011440	-40~+150°C 20%~95%RH	Jul. 03, 2020	Feb. 03, 2021~ Feb. 04, 2021	Jul. 02, 2021	Conducted (TH01-KS)
EXA Spectrum Analyzer	Keysight	N9010A	MY55150244	10Hz-44G,MAX 30dB	Apr. 15, 2020	Feb. 03, 2021	Apr. 14, 2021	Radiation (03CH04-KS)
Bilog Antenna	TeseQ	CBL6111D	49922	30MHz-1GHz	Jun. 08, 2020	Feb. 03, 2021	Jun. 07, 2021	Radiation (03CH04-KS)
Horn Antenna	Schwarzbeck	BBHA9120D	1356	1GHz~18GHz	Apr. 20, 2020	Feb. 03, 2021	Apr. 19, 2021	Radiation (03CH04-KS)
SHF-EHF Horn	Com-power	AH-840	101115	18GHz~40GHz	Jan. 06, 2021	Feb. 03, 2021	Jan. 05, 2022	Radiation (03CH04-KS)
Amplifier	SONOMA	310N	187289	9KHz-1GHz	Jan. 06, 2021	Feb. 03, 2021	Jan. 05, 2022	Radiation (03CH04-KS)
Amplifier	MITEQ	EM18G40G GA	060728	18~40GHz	Jan. 07, 2021	Feb. 03, 2021	Jan. 06, 2022	Radiation (03CH04-KS)
high gain Amplifier	MITEQ	AMF-7D-00 101800-30-1 0P	2025788	1Ghz-18Ghz	Jan. 06, 2021	Feb. 03, 2021	Jan. 05, 2022	Radiation (03CH04-KS)
Amplifier	Keysight	83017A	MY57280106	500MHz~26.5GHz	Oct. 14, 2020	Feb. 03, 2021	Oct. 13, 2021	Radiation (03CH04-KS)
AC Power Source	Chroma	61601	F104090004	N/A	NCR	Feb. 03, 2021	NCR	Radiation (03CH04-KS)
Turn Table	ChamPro	EM 1000-T	060762-T	0~360 degree	NCR	Feb. 03, 2021	NCR	Radiation (03CH04-KS)
Antenna Mast	ChamPro	EM 1000-A	060762-A	1 m~4 m	NCR	Feb. 03, 2021	NCR	Radiation (03CH04-KS)

NCR: No Calibration Required



6 Uncertainty of Evaluation

The measurement uncertainties shown below were calculated in accordance with the requirements of ANSI 63.26-2015. All the measurement uncertainty value were shown with a coverage K=2 to indicate 95% level of confidence. The measurement data show herein meets or exceeds the CISPR measurement uncertainty values specified in CISPR 16-4-2 and can be compared directly to specified limit to determine compliance.

Uncertainty of Radiated Emission Measurement (30 MHz ~ 1000 MHz)

Measuring Uncertainty for a Level of Confidence of 95% (U = 2Uc(y))	3.3dB
---	-------

Uncertainty of Radiated Emission Measurement (1 GHz ~ 18 GHz)

Measuring Uncertainty for a Level of Confidence of 95% (U = 2Uc(y))	2.8dB
---	-------

Uncertainty of Radiated Emission Measurement (18 GHz ~ 40 GHz)

Measuring Uncertainty for a Level of Confidence of 95% (U = 2Uc(y))	2.8dB
---	-------



Appendix A. Test Results of Conducted Test

Conducted Output Power(Average power and EIRP)

5G NR n5 NSA (EN DC_7A-n5A):

BW [MHz]	Modulation	RB Size	RB Offset	Power Low Ch. / Freq.	Power Middle Ch. / Freq.	Power High Ch. / Freq.	Gain	ERP	ERP	ERP
								L	M	H
Channel				166800	167300	167800				
Frequency (MHz)				834	836.5	839		L	M	H
20	PI/2 BPSK	1	1	23.23	23.34	23.26	-4.3	0.0476	0.0489	0.0480
20	QPSK	1	1	23.50	23.47	23.52	-4.3	0.0507	0.0503	0.0509
20	QPSK	1	53	23.25	23.34	23.15	-4.3	0.0479	0.0489	0.0468
20	QPSK	1	104	23.10	23.17	23.23	-4.3	0.0462	0.0470	0.0476
20	QPSK	50	0	22.67	22.65	22.50	-4.3	0.0419	0.0417	0.0403
20	QPSK	50	28	23.17	23.23	23.24	-4.3	0.0470	0.0476	0.0478
20	QPSK	50	56	22.46	22.52	22.62	-4.3	0.0399	0.0405	0.0414
20	QPSK	100	0	22.58	22.48	22.32	-4.3	0.0410	0.0401	0.0387
20	16QAM	1	1	22.99	23.00	22.79	-4.3	0.0451	0.0452	0.0431
20	64QAM	1	1	20.97	20.91	20.69	-4.3	0.0283	0.0279	0.0265
20	256QAM	1	1	18.94	18.91	18.77	-4.3	0.0177	0.0176	0.0171
Channel				166300	167300	168300	Gain	L	M	H
Frequency (MHz)				831.5	836.5	841.5				
15	QPSK	1	1	23.34	23.27	23.42	-4.3	0.0489	0.0481	0.0498
15	16QAM	1	1	22.79	22.80	22.67	-4.3	0.0431	0.0432	0.0419
Channel				165800	167300	168800	Gain	L	M	H
Frequency (MHz)				829	836.5	844				
10	QPSK	1	1	23.23	23.20	23.42	-4.3	0.0476	0.0473	0.0498
10	16QAM	1	1	22.68	22.79	22.57	-4.3	0.0420	0.0431	0.0409
Channel				165300	167300	169300	Gain	L	M	H
Frequency (MHz)				826.5	836.5	846.5				
5	QPSK	1	1	23.20	23.23	23.35	-4.3	0.0473	0.0476	0.0490
5	16QAM	1	1	22.82	22.66	22.65	-4.3	0.0434	0.0418	0.0417



5G NR n7 NSA (EN DC_66A-n7A):

BW [MHz]	Modulation	RB Size	RB Offset	Power Low Ch. / Freq.	Power Middle Ch. / Freq.	Power High Ch. / Freq.	Gain	EIRP	EIRP	EIRP
Channel				502000	507000	512000		L	M	H
Frequency (MHz)				2510	2535	2560				
20	PI/2 BPSK	1	1	23.32	23.23	23.17				
20	QPSK	1	1	23.61	23.56	23.50	-2.20	0.1383	0.1367	0.1348
20	QPSK	1	53	23.23	23.33	23.22	-2.20	0.1267	0.1297	0.1264
20	QPSK	1	104	23.42	23.28	23.32	-2.20	0.1324	0.1282	0.1294
20	QPSK	50	0	22.50	22.55	22.66	-2.20	0.1071	0.1084	0.1112
20	QPSK	50	28	23.32	23.42	23.40	-2.20	0.1294	0.1324	0.1318
20	QPSK	50	56	22.62	22.58	22.45	-2.20	0.1101	0.1091	0.1059
20	QPSK	100	0	22.40	22.53	22.42	-2.20	0.1047	0.1079	0.1052
20	16QAM	1	1	22.46	22.70	22.59	-2.20	0.1062	0.1122	0.1094
20	64QAM	1	1	20.70	20.88	20.70	-2.20	0.0709	0.0739	0.0709
20	256QAM	1	1	18.70	18.76	18.90	-2.20	0.0447	0.0453	0.0468
Channel				501500	507000	512500	Gain	L	M	H
Frequency (MHz)				2507.5	2535	2562.5				
15	QPSK	1	1	23.50	23.37	23.38				
15	16QAM	1	1	22.32	22.49	22.41	-2.20	0.1028	0.1069	0.1049
Channel				501000	507000	513000	Gain	L	M	H
Frequency (MHz)				2505	2535	2565				
10	QPSK	1	1	23.37	23.38	23.30				
10	16QAM	1	1	22.23	22.44	22.29	-2.20	0.1007	0.1057	0.1021
Channel				500500	507000	513500	Gain	L	M	H
Frequency (MHz)				2502.5	2535	2567.5				
5	QPSK	1	1	23.35	23.46	23.38				
5	16QAM	1	1	22.37	22.44	22.39	-2.20	0.1040	0.1057	0.1045



5G NR n77 NSA (EN DC_41A-n77A):

BW [MHz]	Modulation	RB Size	RB Offset	Power Low Ch. / Freq.	Power Middle Ch. / Freq.	Power High Ch. / Freq.	Gain	EIRP	EIRP	EIRP
Channel				650000	656000	662000		L	M	H
Frequency (MHz)				3750	3840	3930				
100	PI/2 BPSK	1	1	22.89	22.88	22.87	-2.9	0.0998	0.0995	0.0993
100	QPSK	1	1	22.98	22.95	22.97	-2.9	0.1019	0.1012	0.1016
100	QPSK	1	137	22.58	22.75	22.65	-2.9	0.0928	0.0965	0.0943
100	QPSK	1	271	22.50	22.70	22.52	-2.9	0.0911	0.0954	0.0916
100	QPSK	135	0	22.45	22.47	22.48	-2.9	0.0902	0.0906	0.0908
100	QPSK	135	69	22.52	22.45	22.66	-2.9	0.0916	0.0902	0.0946
100	QPSK	135	138	22.41	22.42	22.41	-2.9	0.0893	0.0895	0.0893
100	QPSK	270	0	22.46	22.43	22.43	-2.9	0.0904	0.0897	0.0897
100	16QAM	1	1	22.60	22.79	22.67	-2.9	0.0933	0.0975	0.0948
100	64QAM	1	1	21.09	21.28	21.16	-2.9	0.0660	0.0689	0.0670
100	256QAM	1	1	19.63	19.61	19.68	-2.9	0.0471	0.0469	0.0476
Channel				649334	656000	662668	Gain	L	M	H
Frequency (MHz)				3740.01	3840	3940.02				
80	QPSK	1	1	22.88	22.89	22.92	-2.9	0.0995	0.0998	0.1005
80	16QAM	1	1	22.48	22.67	22.59	-2.9	0.0908	0.0948	0.0931
Channel				648668	656000	663334	Gain	L	M	H
Frequency (MHz)				3730.02	3840	3950.01				
60	QPSK	1	1	22.90	22.86	22.89	-2.9	0.1000	0.0991	0.0998
60	16QAM	1	1	22.50	22.70	22.42	-2.9	0.0912	0.0955	0.0895
Channel				648000	656000	664000	Gain	L	M	H
Frequency (MHz)				3720	3840	3960				
40	QPSK	1	1	22.93	22.91	22.89	-2.9	0.1007	0.1002	0.0998
40	16QAM	1	1	22.41	22.61	22.52	-2.9	0.0893	0.0935	0.0916
Channel				647668	656000	664334	Gain	L	M	H
Frequency (MHz)				3715.02	3840	3965.01				
30	QPSK	1	1	22.89	22.86	22.91	-2.9	0.0998	0.0991	0.1002
30	16QAM	1	1	22.16	22.66	22.51	-2.9	0.0843	0.0946	0.0914
Channel				647334	656000	664668	Gain	L	M	H
Frequency (MHz)				3710.01	3840	3970.02				
20	QPSK	1	1	22.89	22.91	22.88	-2.9	0.0998	0.1002	0.0995
20	16QAM	1	1	22.44	22.62	22.53	-2.9	0.0899	0.0937	0.0918



FR1 n5 NSA

Peak-to-Average Ratio

Mode	FR1 n5 / 20MHz / DFT-S OFDM				
Mod.	PI/2 BPSK	QPSK	16QAM	64QAM	Limit: 13dB
RB Size	Full RB	Full RB	Full RB	Full RB	Result
Middle CH	3.71	4.93	5.91	6.03	PASS
Mode	FR1 n5 / 15MHz / DFT-S OFDM				
Mod.	256QAM				Limit: 13dB
RB Size	Full RB				Result
Middle CH	6.38				PASS



FR1 n5 / 20MHz / DFT-S OFDM

Middle Channel / Full RB

PI/2 BPSK

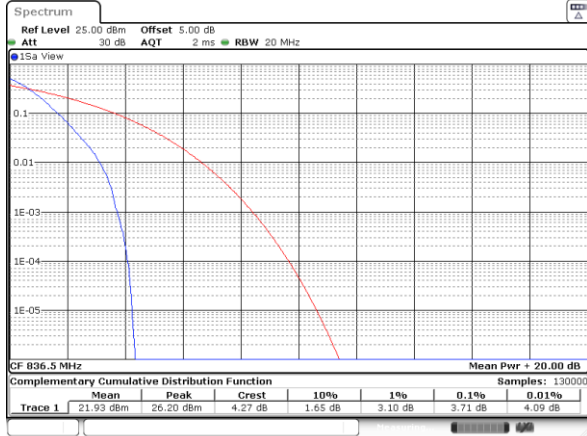

Date: 3.FEB.2021 17:53:41

Middle Channel / Full RB

QPSK

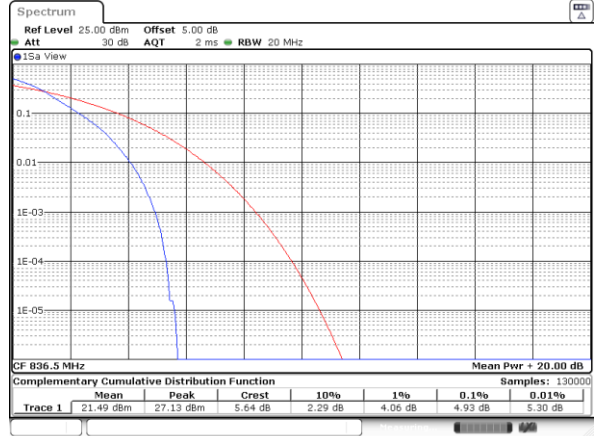

Date: 3.FEB.2021 17:53:26

16QAM

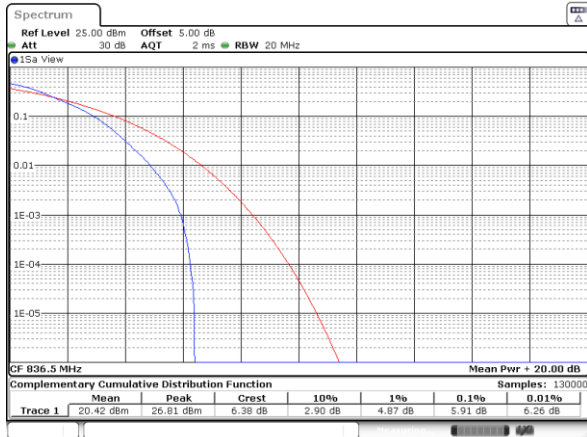

Date: 3.FEB.2021 17:53:13

64QAM

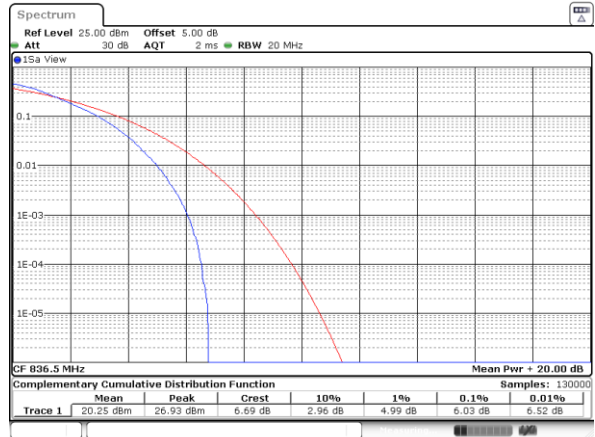

Date: 3.FEB.2021 17:53:00

256QAM

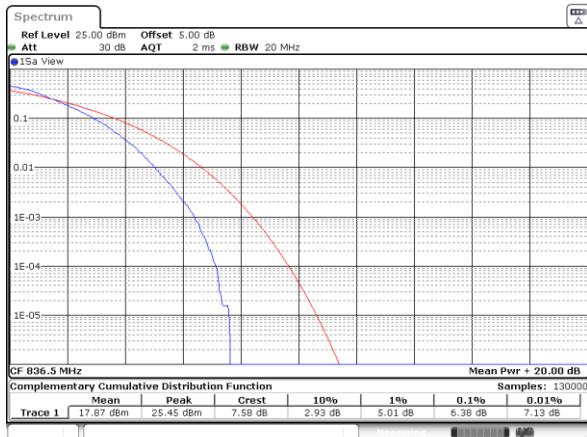

Date: 3.FEB.2021 17:52:16



26dB Bandwidth

Mode	FR1 n5: 26dB BW(MHz) / CP OFDM	
BW	20MHz	
Mod.	QPSK	16QAM
Middle CH	19.86	19.82

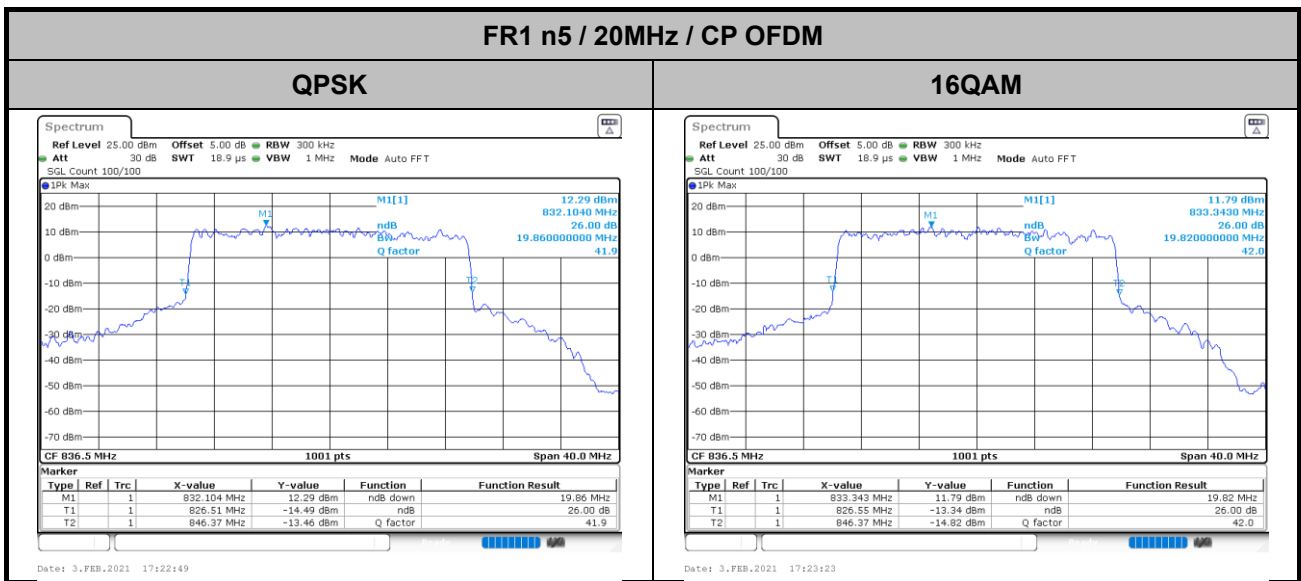



Occupied Bandwidth

Mode	FR1 n5 : 99%OBW(MHz) / CP OFDM	
BW	20MHz	
Mod.	QPSK	16QAM
Middle CH	18.94	18.86

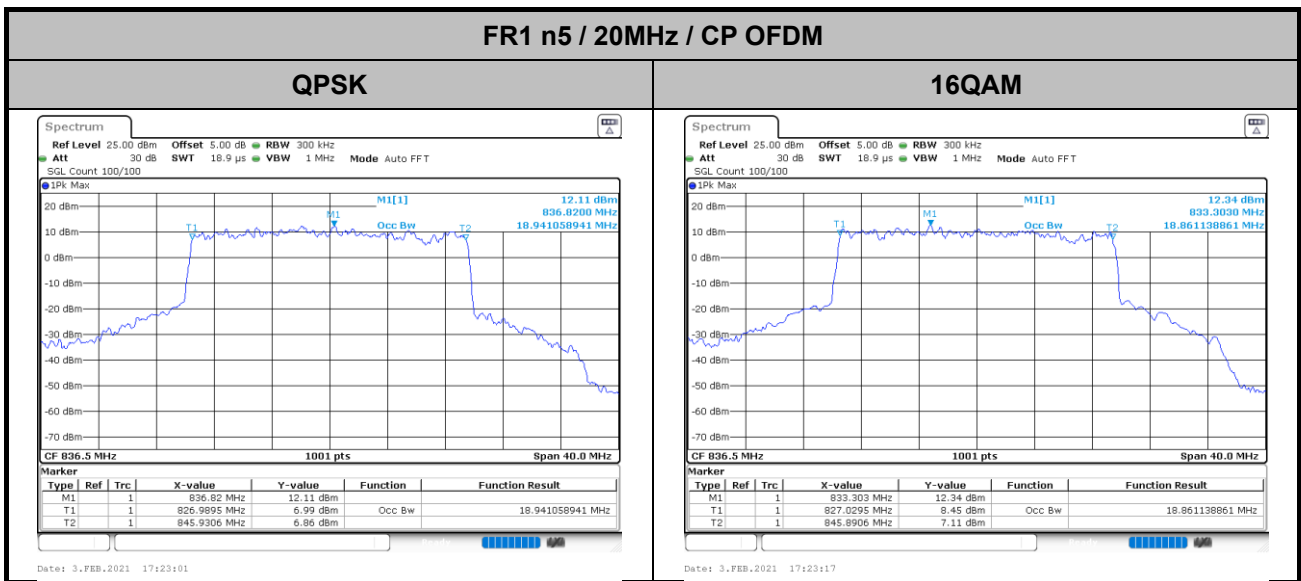



Conducted Band Edge

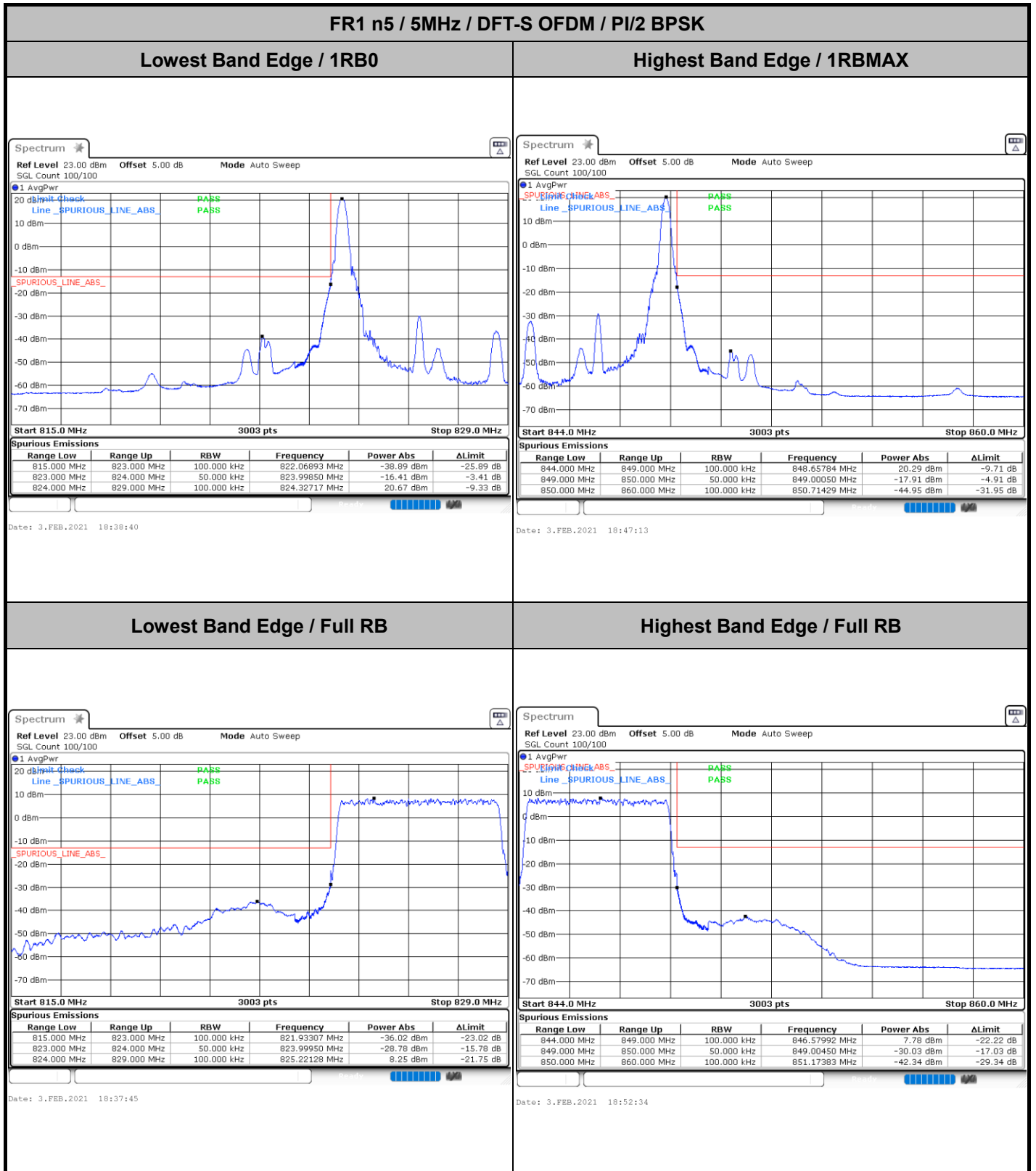



FR1 n5 / 5MHz / DFT-S OFDM / QPSK

Lowest Band Edge / 1RB0

Highest Band Edge / 1RBMAX

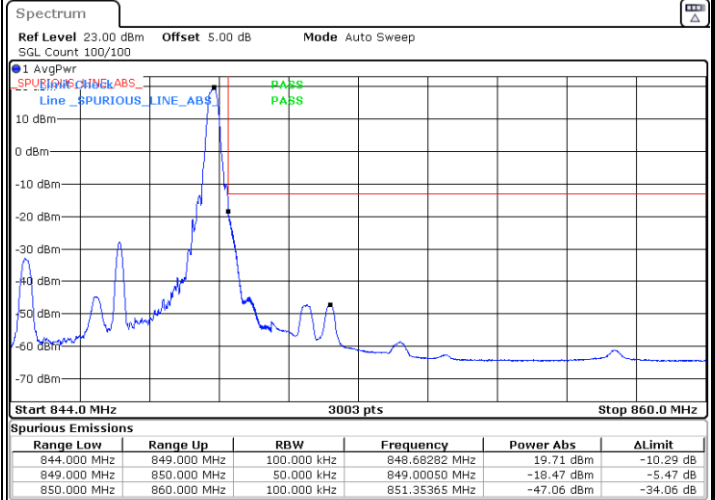
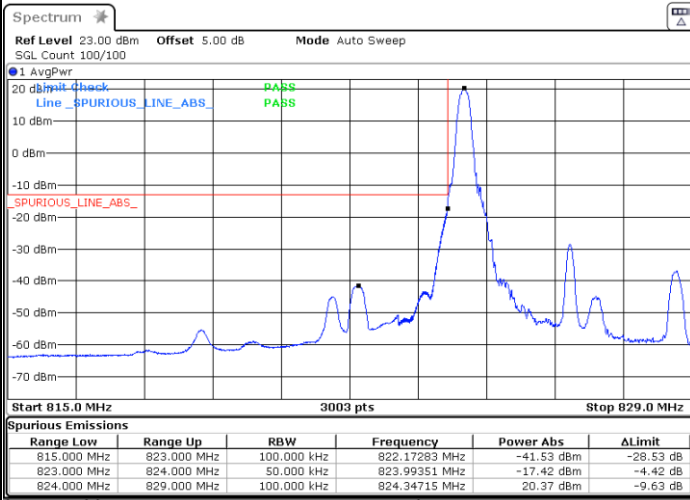

Date: 3.FEB.2021 18:39:47

Date: 3.FEB.2021 18:47:56

Lowest Band Edge / Full RB

Highest Band Edge / Full RB

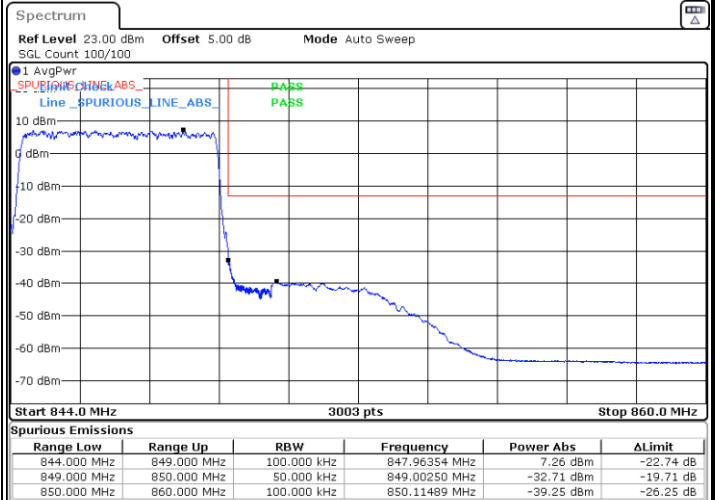
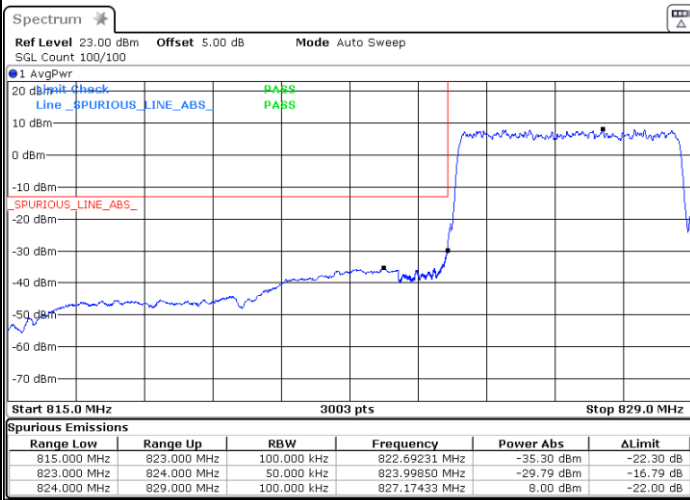

Date: 3.FEB.2021 18:36:14

Date: 3.FEB.2021 18:51:52



FR1 n5 / 5MHz / DFT-S OFDM / 16Q

Lowest Band Edge / 1RB0

Highest Band Edge / 1RBMAX

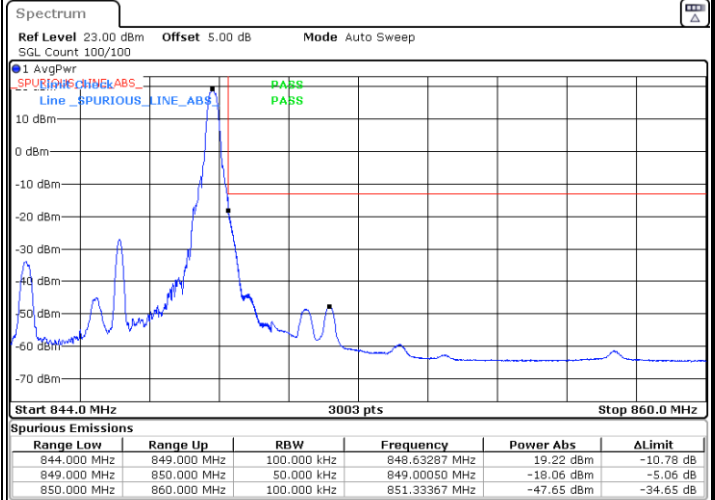
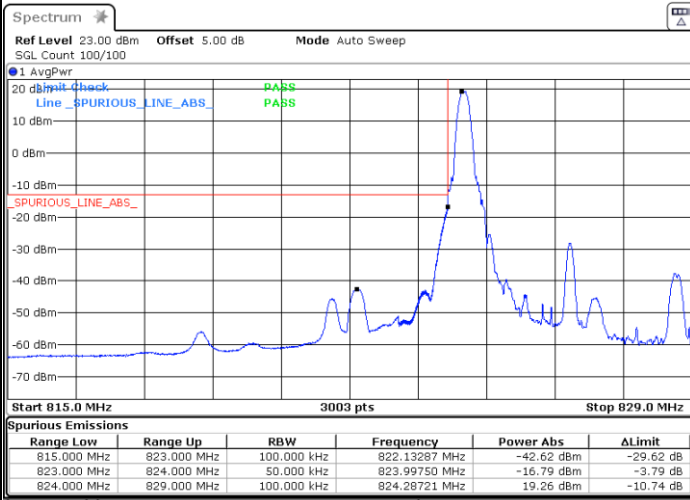

Date: 3.FEB.2021 18:43:00

Date: 3.FEB.2021 18:40:38

Lowest Band Edge / Full RB

Highest Band Edge / Full RB

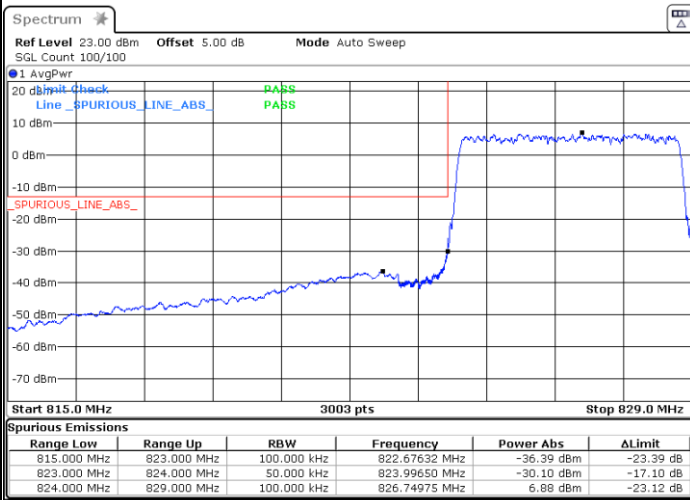

Date: 3.FEB.2021 18:34:50

Date: 3.FEB.2021 18:51:07



FR1 n5/ 5MHz / DFT-S OFDM / 64Q

Lowest Band Edge / 1RB0

Highest Band Edge / 1RBMAX

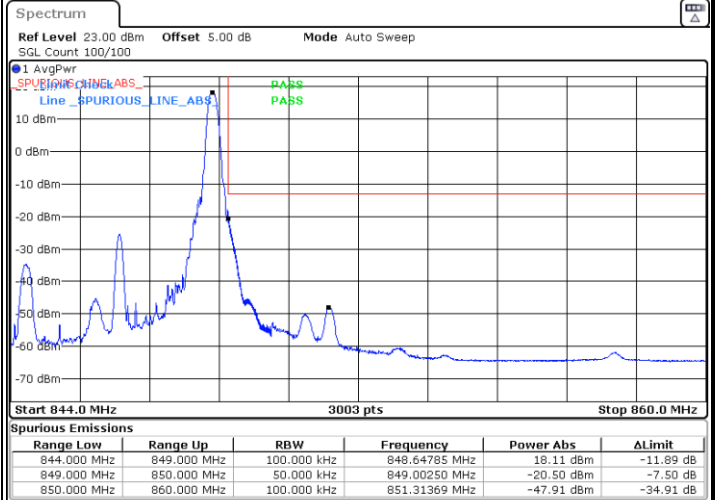
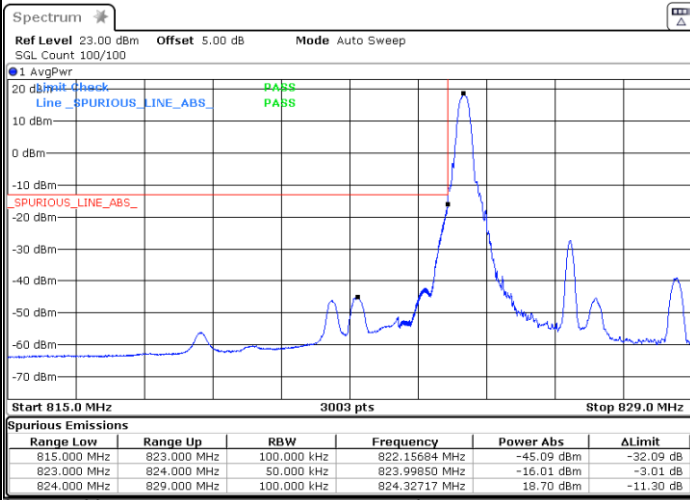

Date: 3.FEB.2021 18:44:22

Date: 3.FEB.2021 18:49:23

Lowest Band Edge / Full RB

Highest Band Edge / Full RB

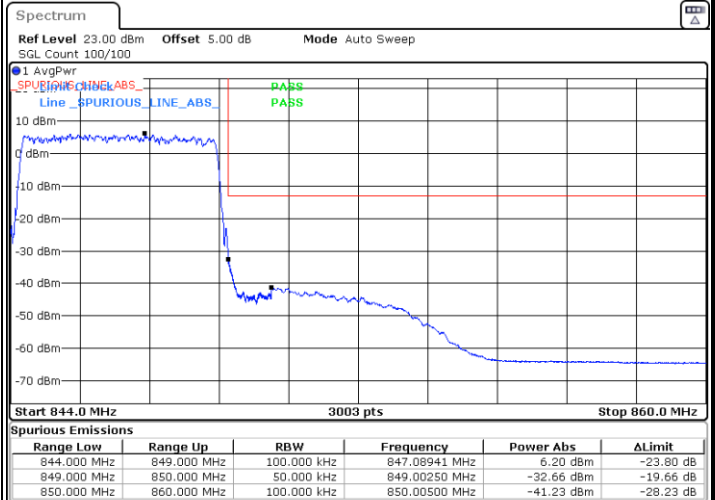
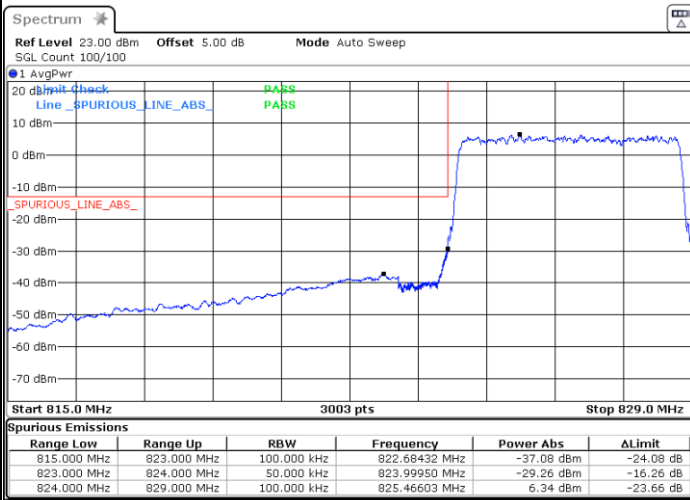

Date: 3.FEB.2021 18:33:51

Date: 3.FEB.2021 18:50:23



FR1 n5 / 5MHz / DFT-S OFDM / 256Q

Lowest Band Edge / 1RB0

Highest Band Edge / 1RBMAX

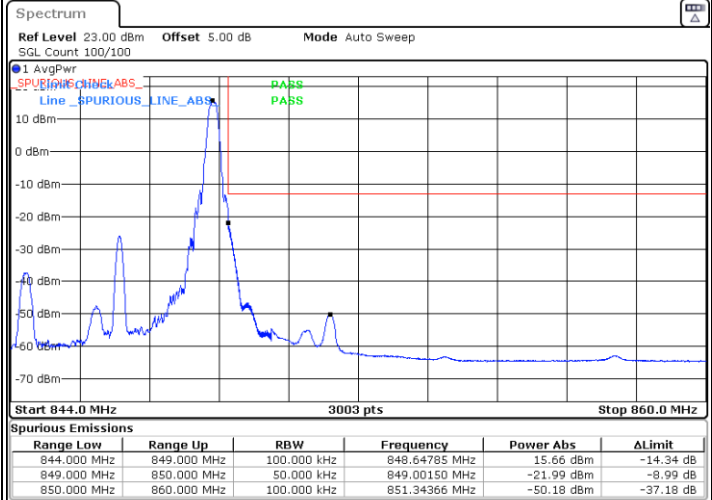
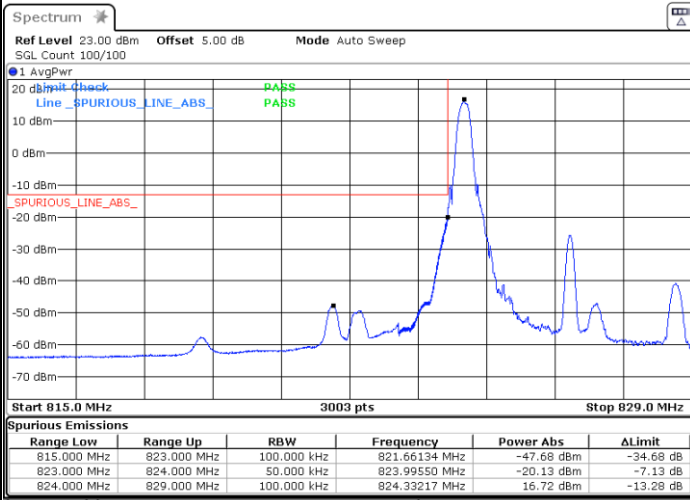

Date: 3.FEB.2021 18:55:26

Date: 3.FEB.2021 18:54:22

Lowest Band Edge / Full RB

Highest Band Edge / Full RB

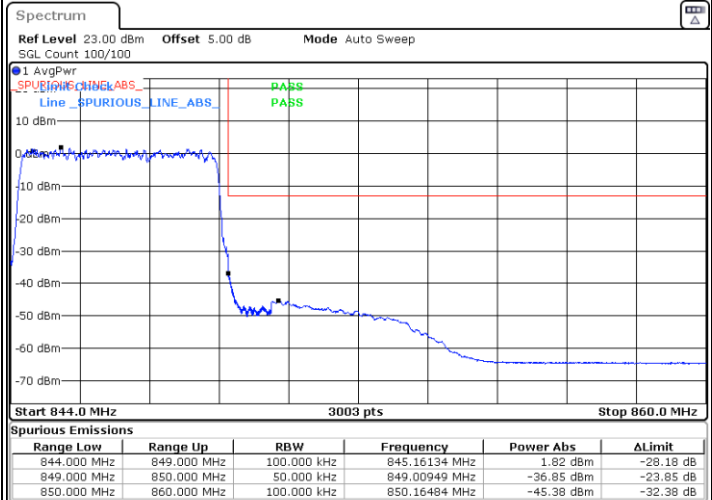
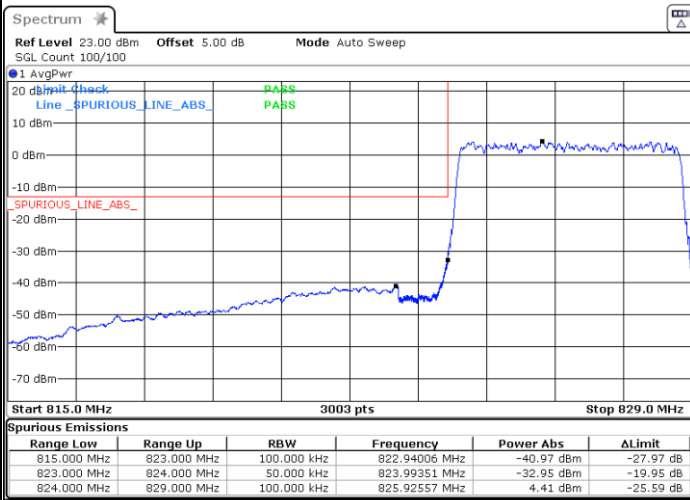

Date: 3.FEB.2021 18:56:51

Date: 3.FEB.2021 18:53:29



FR1 n5 / 10MHz / DFT-s-OFDM / PI/2 BPSK

Lowest Band Edge / 1RB0

Highest Band Edge / 1RBMAX

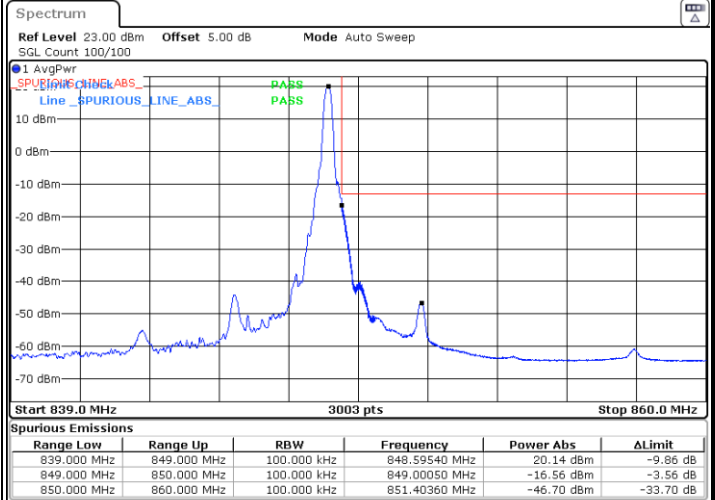
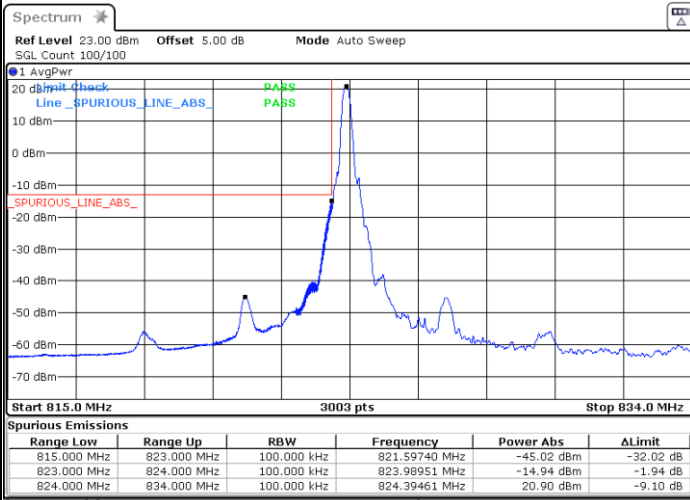

Date: 3.FEB.2021 18:28:31

Date: 3.FEB.2021 18:19:59

Lowest Band Edge / Full RB

Highest Band Edge / Full RB

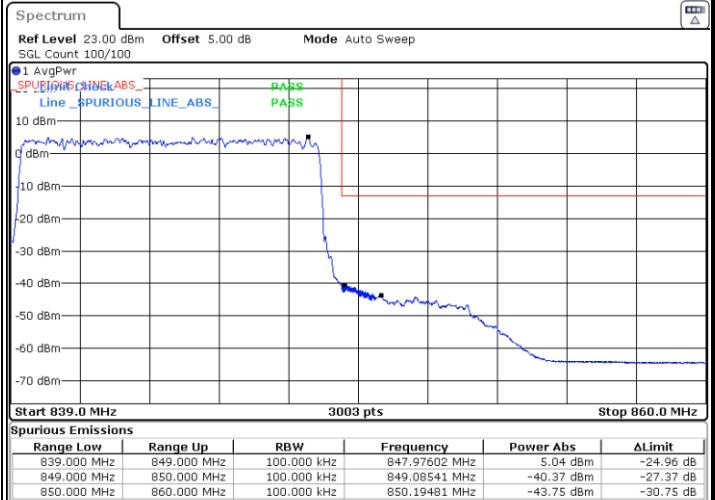
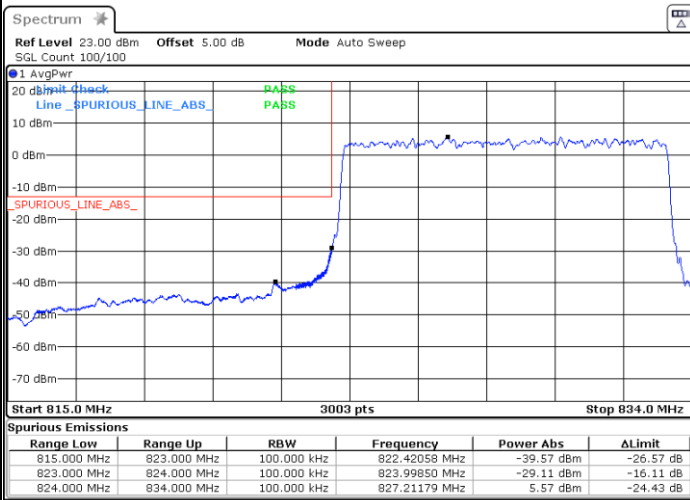

Date: 3.FEB.2021 18:27:23

Date: 3.FEB.2021 18:21:57



FR1 n5 / 10MHz / DFT-s-OFDM / QPSK

Lowest Band Edge / 1RB0

Highest Band Edge / 1RBMAX

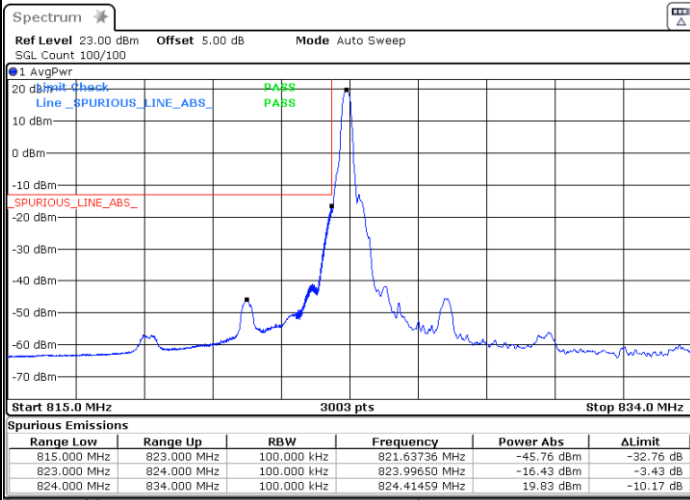

Date: 3.FEB.2021 18:29:46

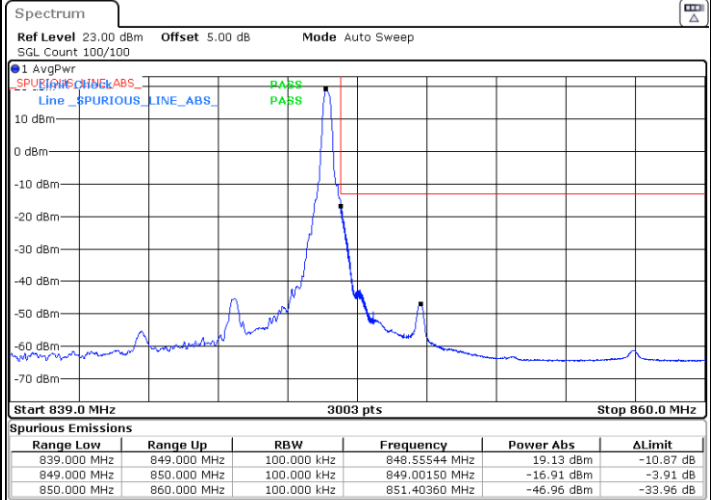

Date: 3.FEB.2021 18:19:16

Lowest Band Edge / Full RB

Highest Band Edge / Full RB

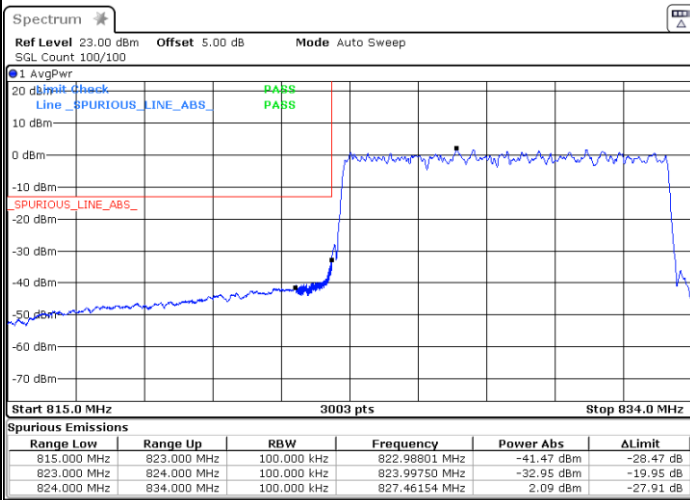

Date: 3.FEB.2021 18:26:25

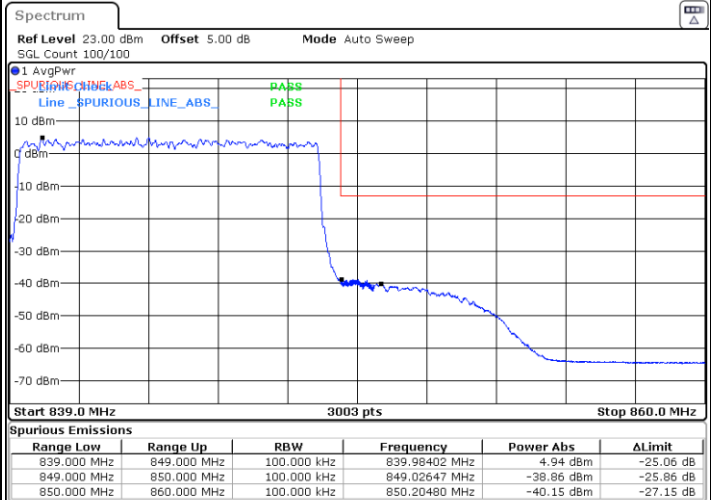

Date: 3.FEB.2021 18:21:20



FR1 n5/ 10MHz / DFT-s-OFDM / 16QAM

Lowest Band Edge / 1RB0

Highest Band Edge / 1RBMAX

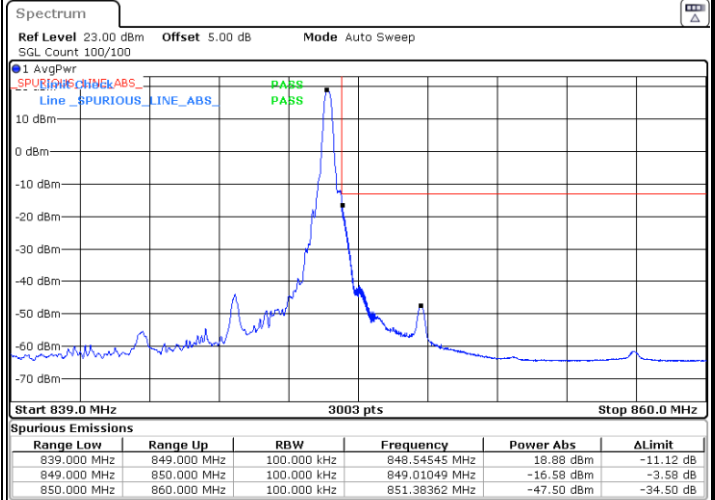
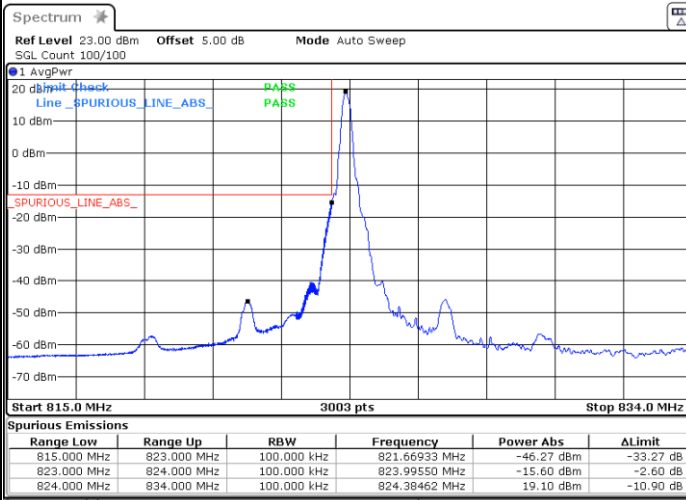

Date: 3.FEB.2021 18:30:59

Date: 3.FEB.2021 18:18:35

Lowest Band Edge / Full RB

Highest Band Edge / Full RB

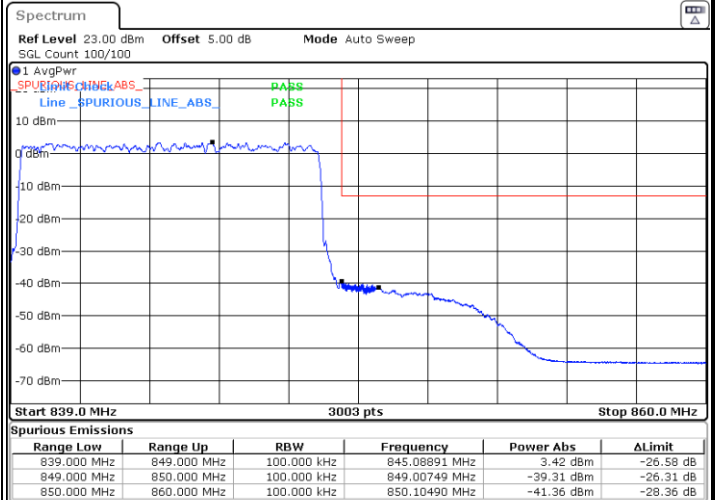
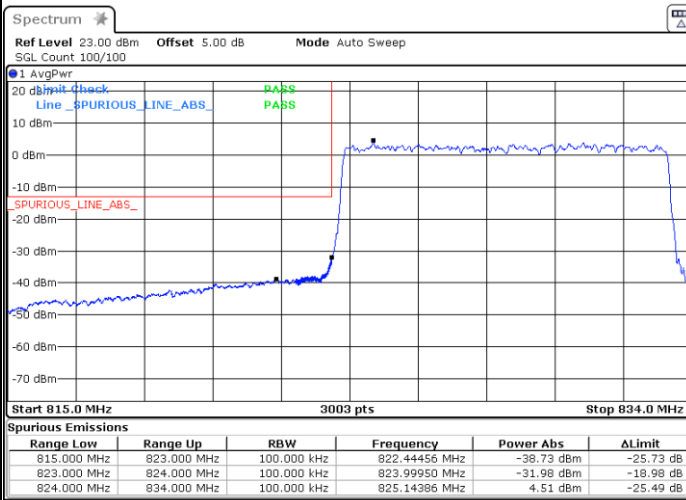

Date: 3.FEB.2021 18:25:42

Date: 3.FEB.2021 18:23:16



FR1 n5 / 10MHz / DFT-s-OFDM / 64QAM

Lowest Band Edge / 1RB0

Highest Band Edge / 1RBMAX

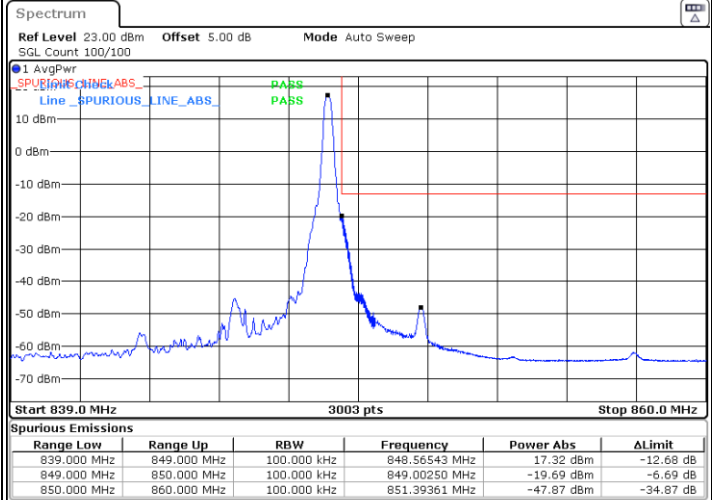
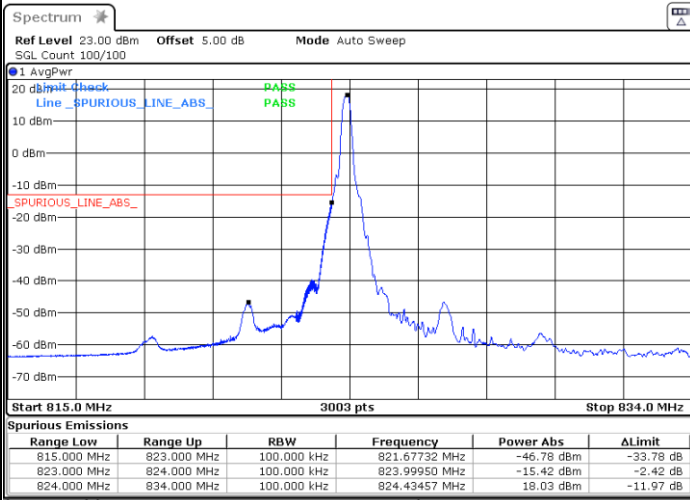

Date: 3.FEB.2021 18:32:12

Date: 3.FEB.2021 18:18:01

Lowest Band Edge / Full RB

Highest Band Edge / Full RB

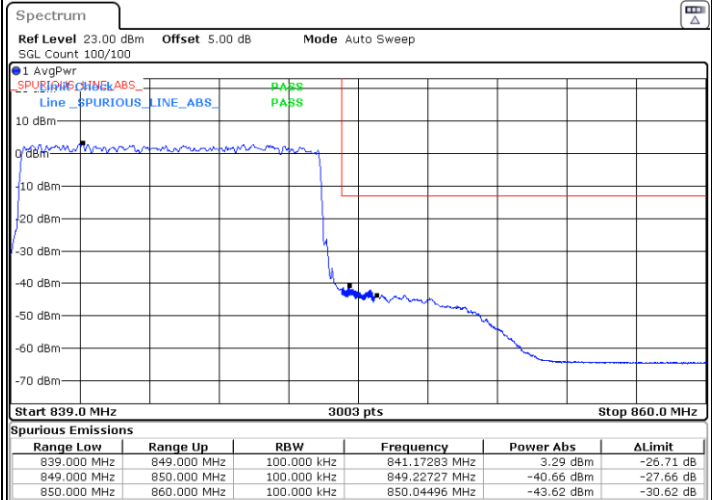
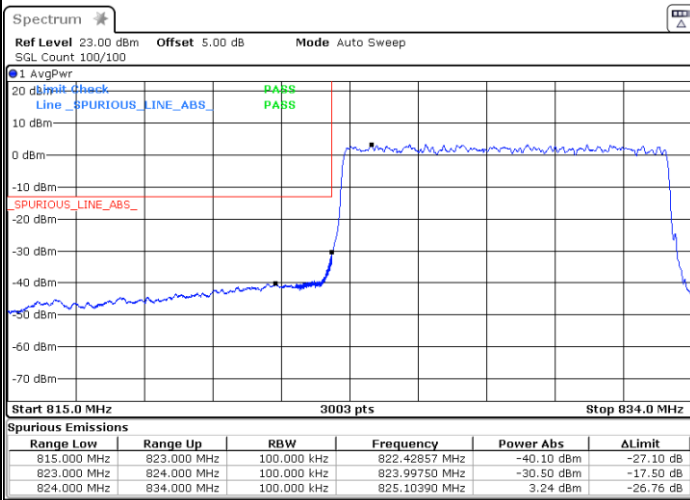

Date: 3.FEB.2021 18:25:02

Date: 3.FEB.2021 18:23:54



FR1 n5 / 10MHz / DFT-s-OFDM / 256QAM

Lowest Band Edge / 1RB0

Highest Band Edge / 1RBMAX

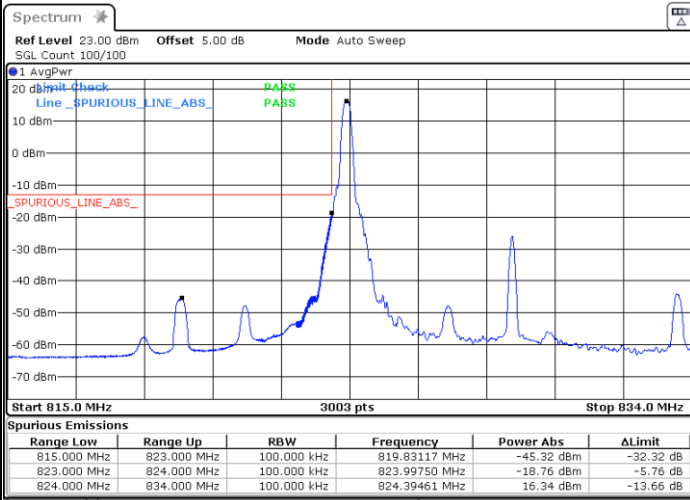

Date: 3.FEB.2021 18:14:00

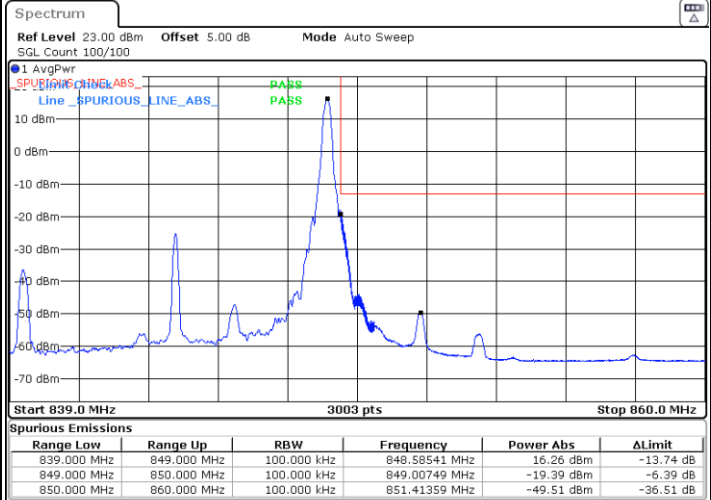

Date: 3.FEB.2021 18:17:14

Lowest Band Edge / Full RB

Highest Band Edge / Full RB

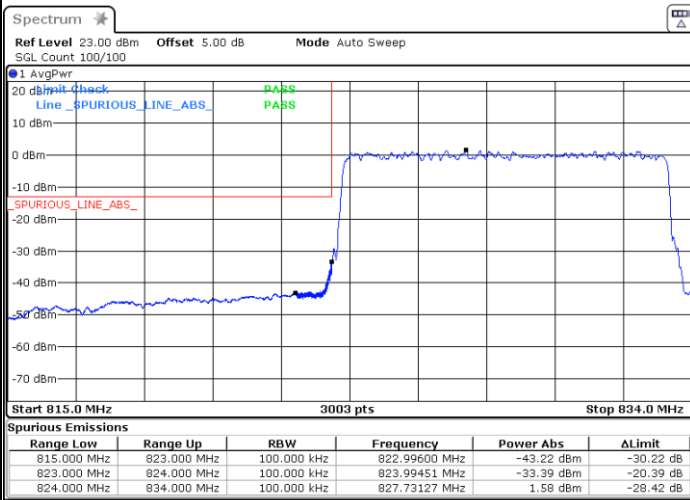

Date: 3.FEB.2021 18:15:15

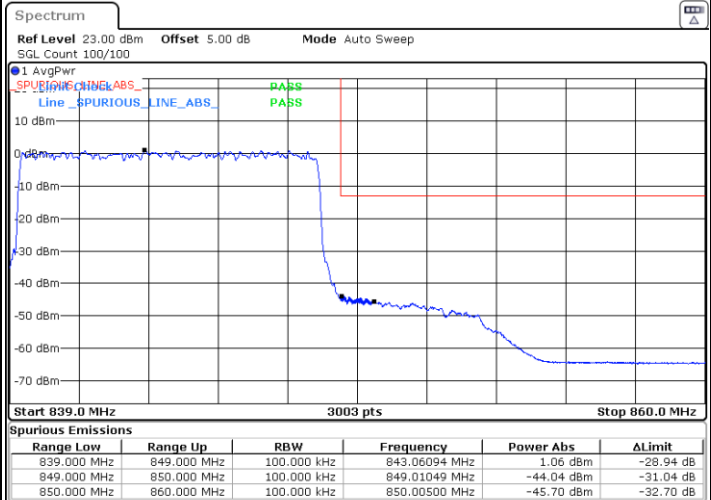

Date: 3.FEB.2021 18:16:21



FR1 n5 / 15MHz / DFT-s-OFDM / PI/2 BPSK

Lowest Band Edge / 1RB0

Highest Band Edge / 1RBMAX

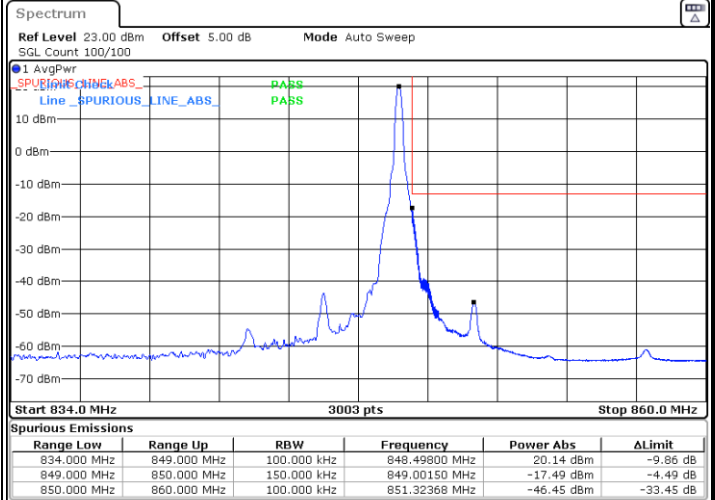
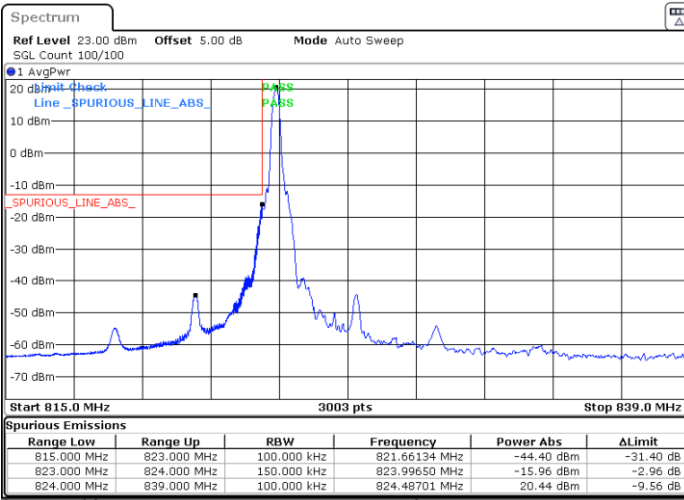

Date: 3.FEB.2021 17:55:42

Date: 3.FEB.2021 18:07:12

Lowest Band Edge / Full RB

Highest Band Edge / Full RB

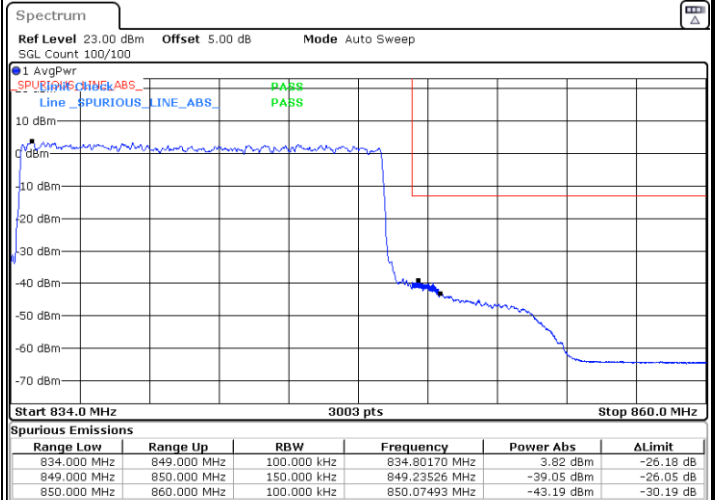
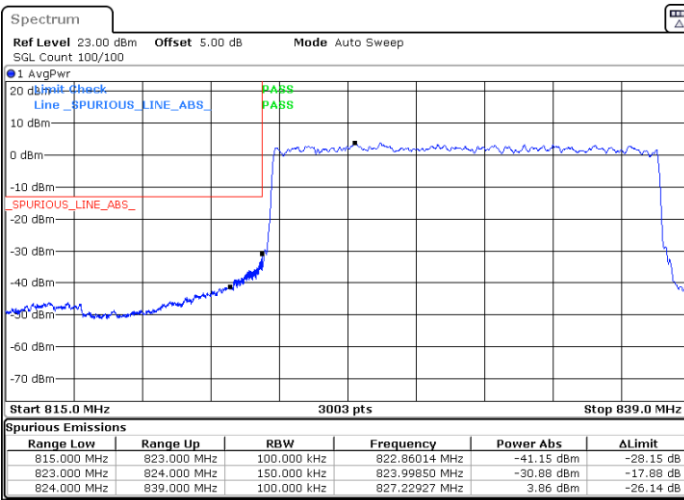

Date: 3.FEB.2021 18:01:32

Date: 3.FEB.2021 18:02:23



FR1 n5/ 15MHz / DFT-s-OFDM / QPSK

Lowest Band Edge / 1RB0

Highest Band Edge / 1RBMAX

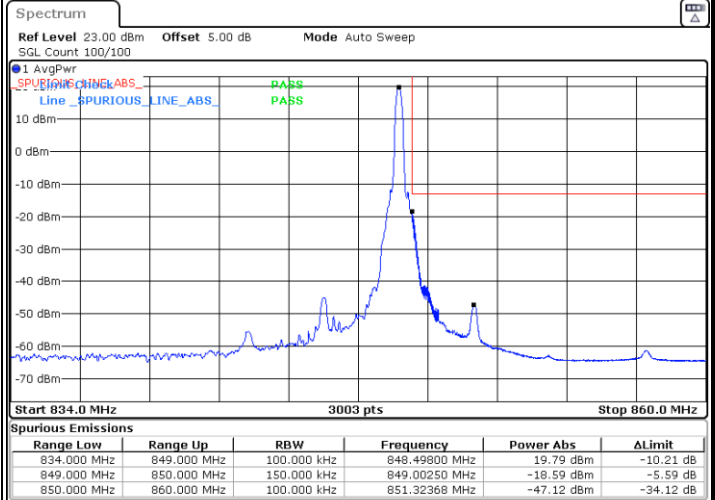
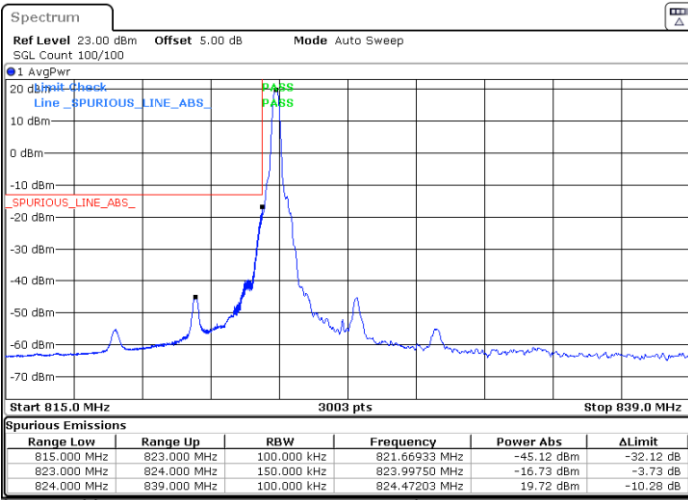

Date: 3.FEB.2021 17:56:12

Date: 3.FEB.2021 18:06:10

Lowest Band Edge / Full RB

Highest Band Edge / Full RB

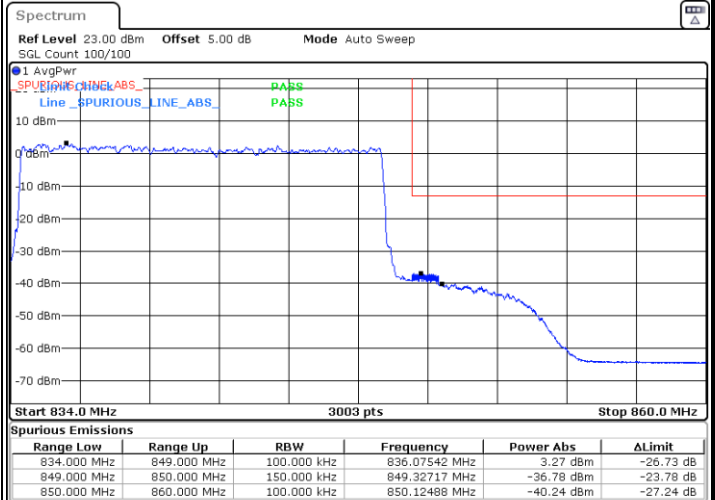
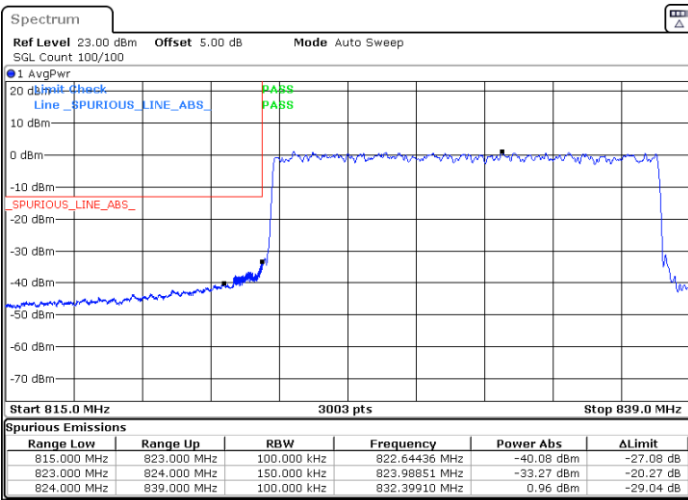

Date: 3.FEB.2021 18:00:44

Date: 3.FEB.2021 18:02:59



FR1 n5 / 15MHz / DFT-s-OFDM / 16QAM

Lowest Band Edge / 1RB0

Highest Band Edge / 1RBMAX

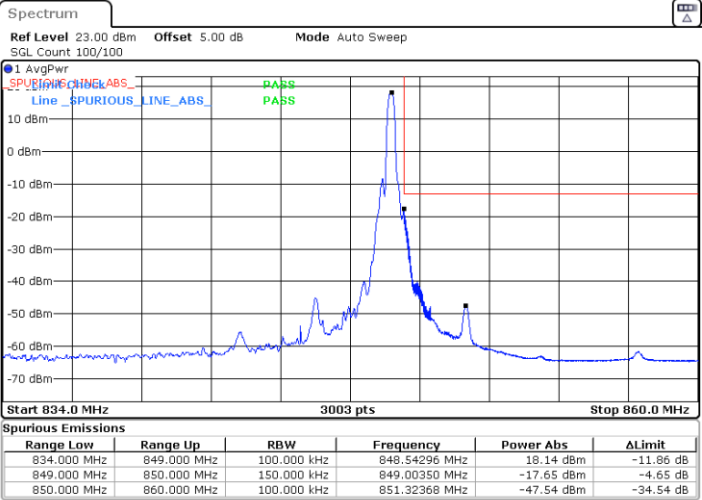
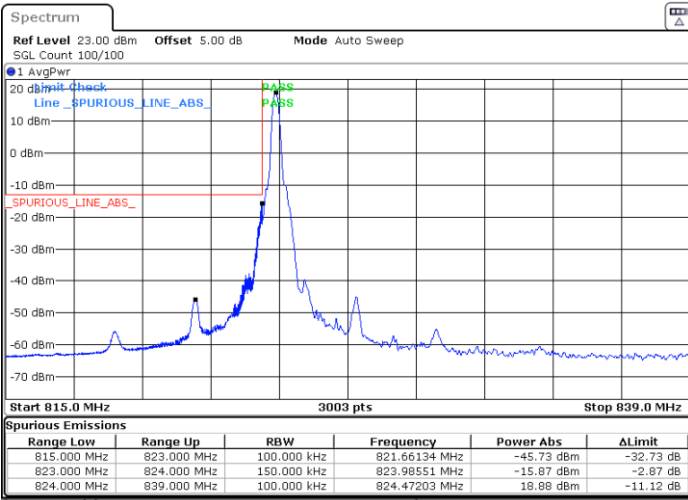

Date: 3.FEB.2021 17:57:11

Date: 3.FEB.2021 18:05:33

Lowest Band Edge / Full RB

Highest Band Edge / Full RB

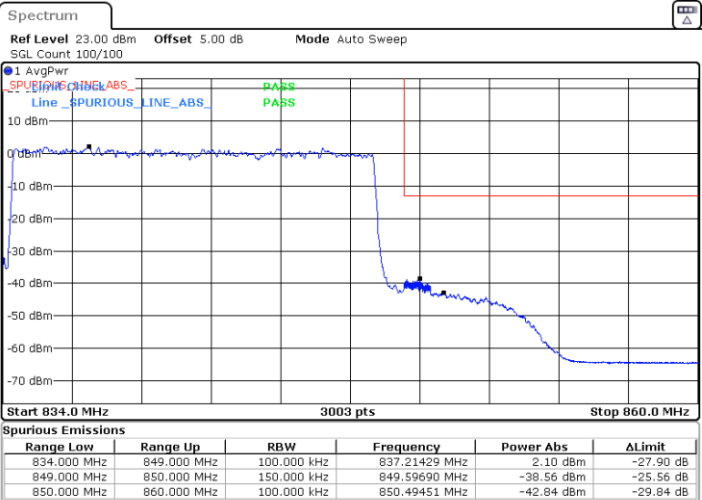
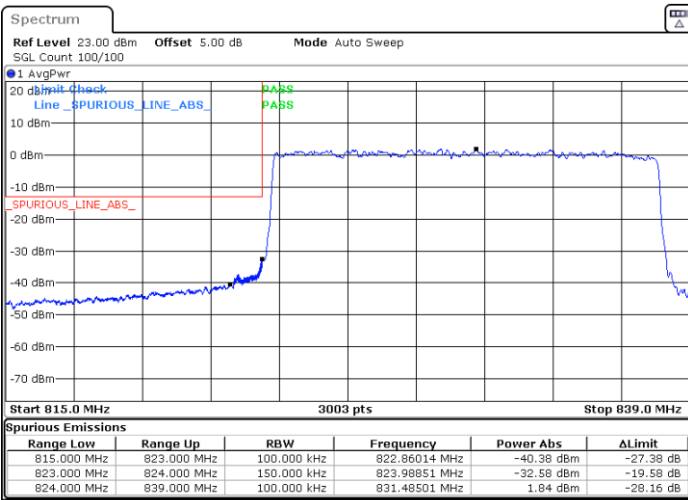

Date: 3.FEB.2021 18:00:04

Date: 3.FEB.2021 18:03:33



FR1 n5 / 15MHz / DFT-s-OFDM / 64QAM

Lowest Band Edge / 1RB0

Highest Band Edge / 1RBMAX

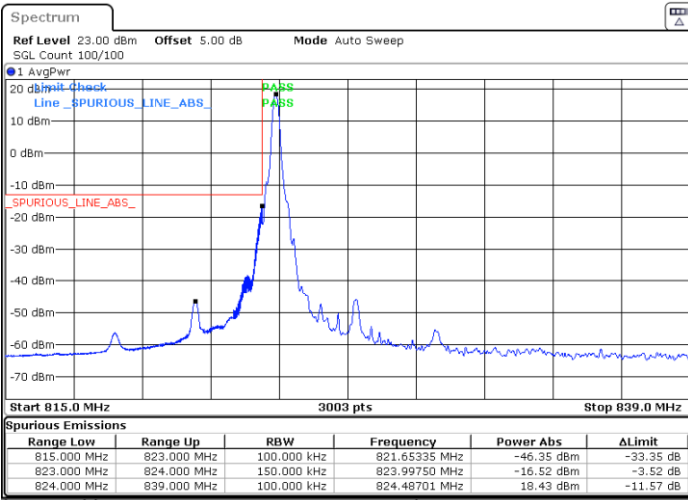

Date: 3.FEB.2021 17:57:46

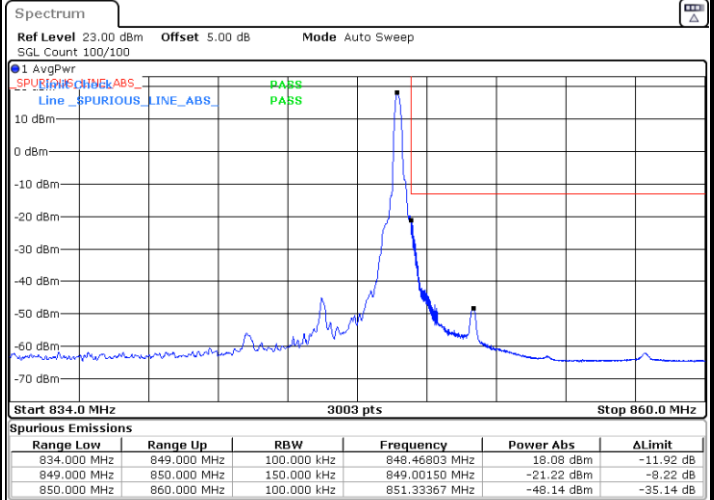

Date: 3.FEB.2021 18:04:58

Lowest Band Edge / Full RB

Highest Band Edge / Full RB

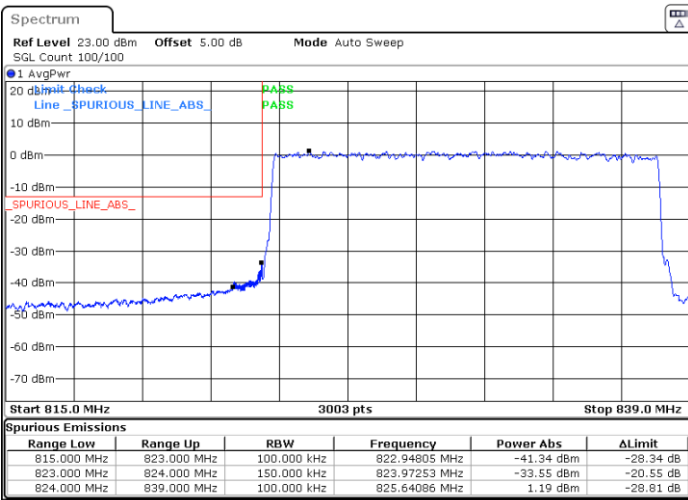

Date: 3.FEB.2021 17:58:24

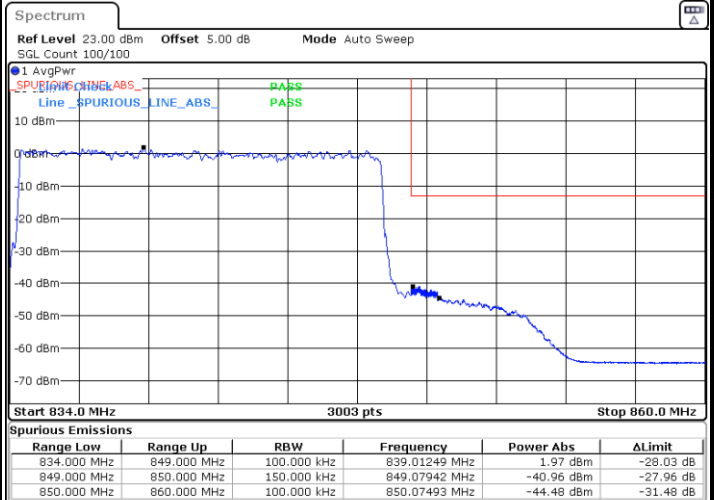

Date: 3.FEB.2021 18:04:09



FR1 n5/ 15MHz / DFT-s-OFDM / 256QAM

Lowest Band Edge / 1RB0

Highest Band Edge / 1RBMAX

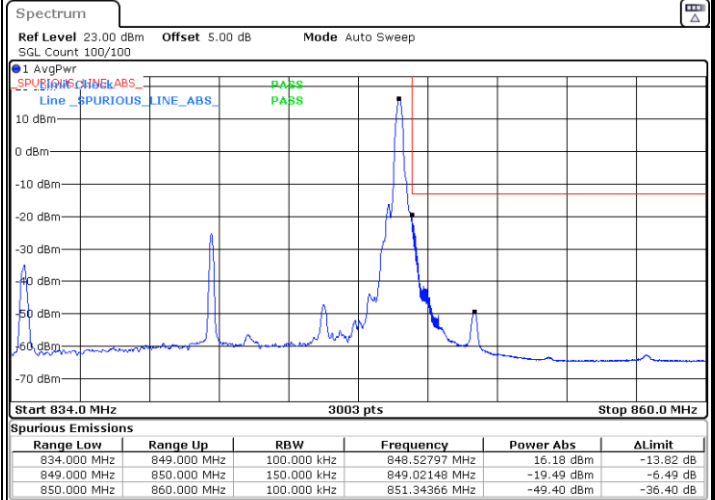
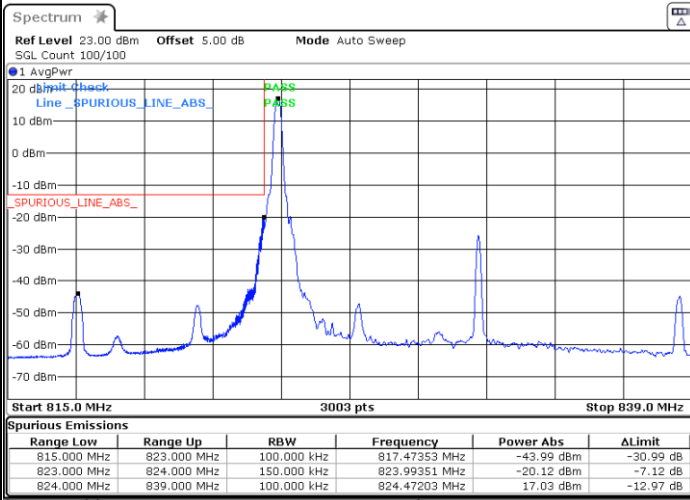

Date: 3.FEB.2021 18:12:07

Date: 3.FEB.2021 18:08:13

Lowest Band Edge / Full RB

Highest Band Edge / Full RB

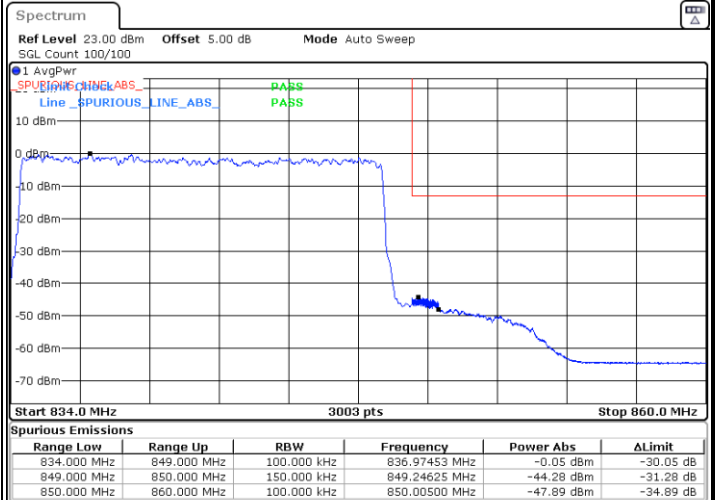
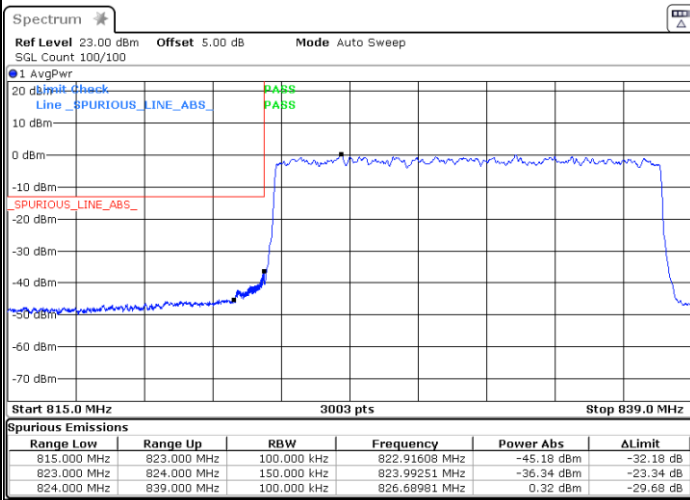

Date: 3.FEB.2021 18:10:52

Date: 3.FEB.2021 18:09:30



FR1 n5 / 20MHz / DFT-s-OFDM / PI/2 BPSK

Lowest Band Edge / 1RB0

Highest Band Edge / 1RBMAX

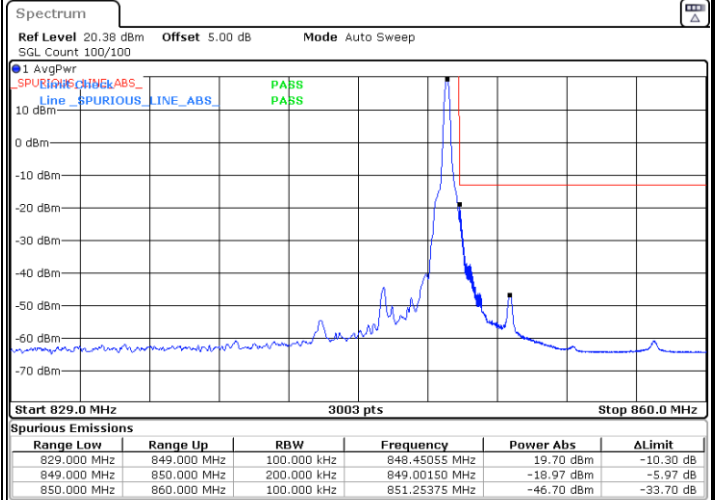
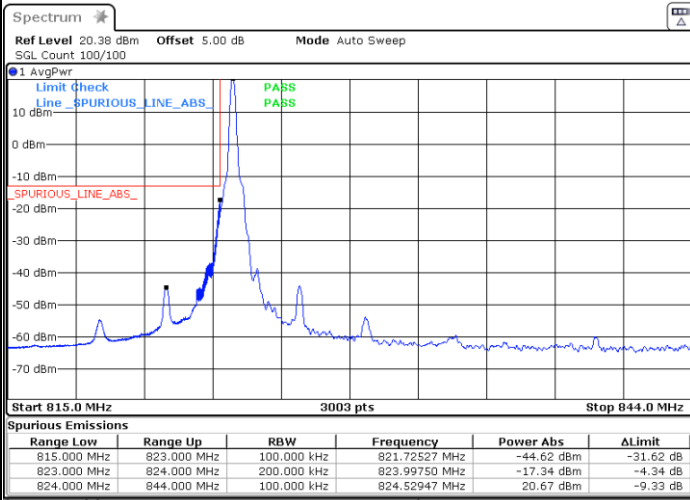

Date: 3.FEB.2021 17:47:29

Date: 3.FEB.2021 17:32:01

Lowest Band Edge / Full RB

Highest Band Edge / Full RB

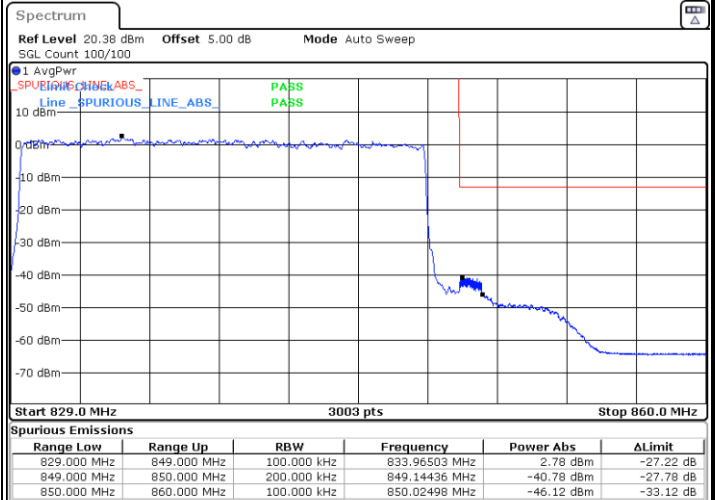
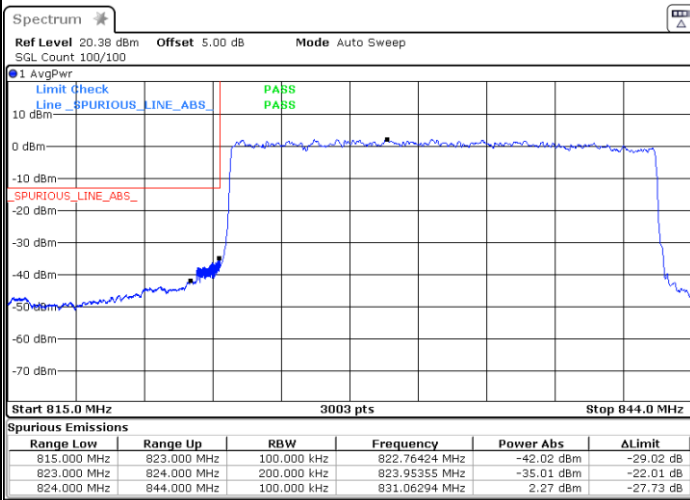

Date: 3.FEB.2021 17:40:41

Date: 3.FEB.2021 17:37:13



FR1 n5/ 20MHz / DFT-s-OFDM / QPSK

Lowest Band Edge / 1RB0

Highest Band Edge / 1RBMAX

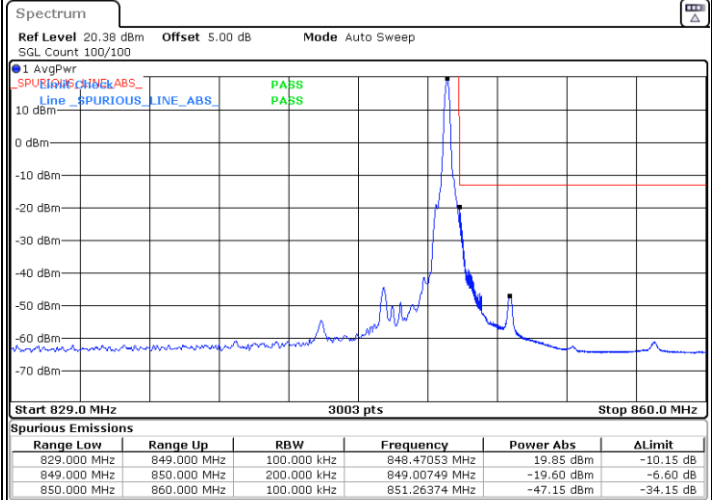
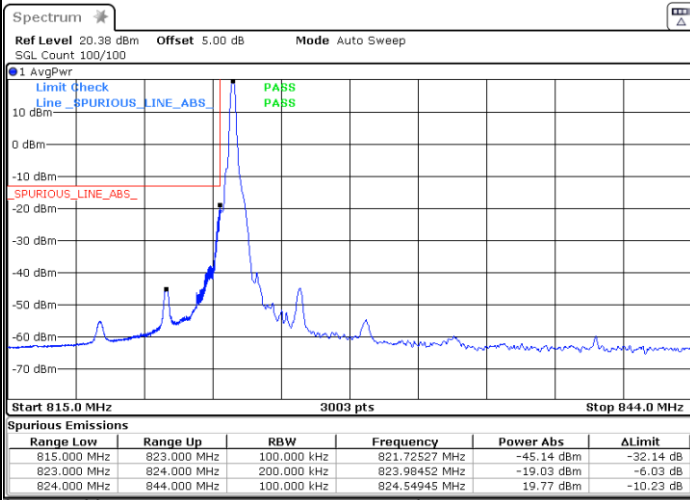

Date: 3.FEB.2021 17:46:26

Date: 3.FEB.2021 17:32:44

Lowest Band Edge / Full RB

Highest Band Edge / Full RB

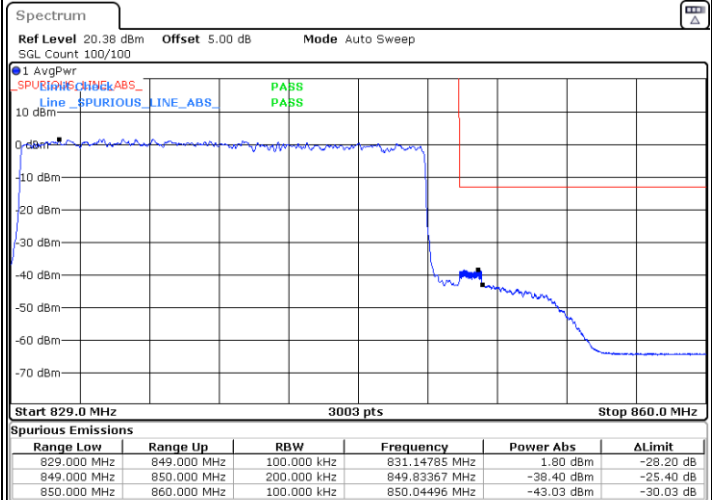
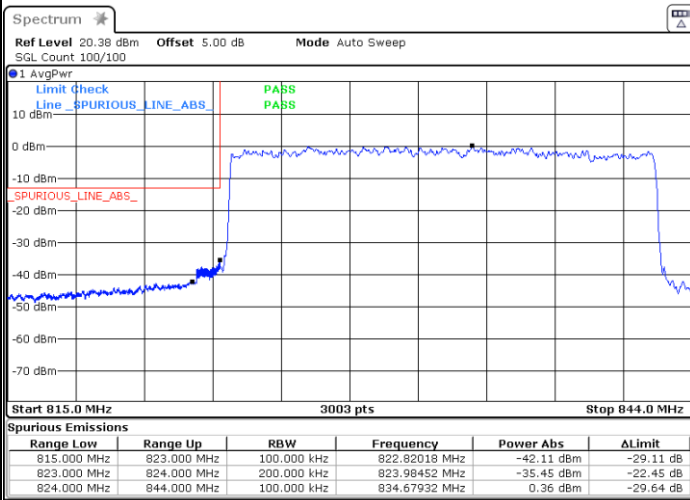

Date: 3.FEB.2021 17:41:52

Date: 3.FEB.2021 17:36:36



FR1 n5 / 20MHz / DFT-s-OFDM / 16QAM

Lowest Band Edge / 1RB0

Highest Band Edge / 1RBMAX

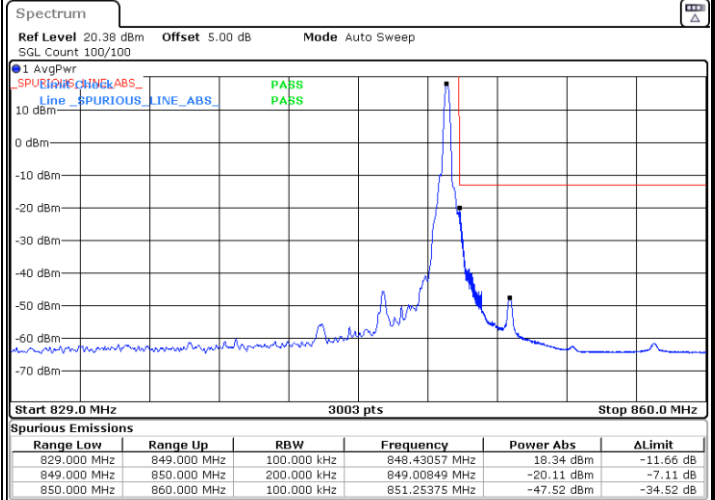
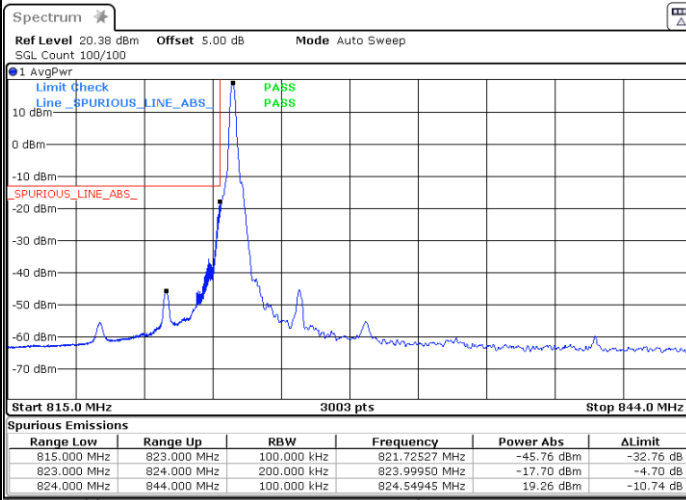

Date: 3.FEB.2021 17:45:14

Date: 3.FEB.2021 17:33:21

Lowest Band Edge / Full RB

Highest Band Edge / Full RB

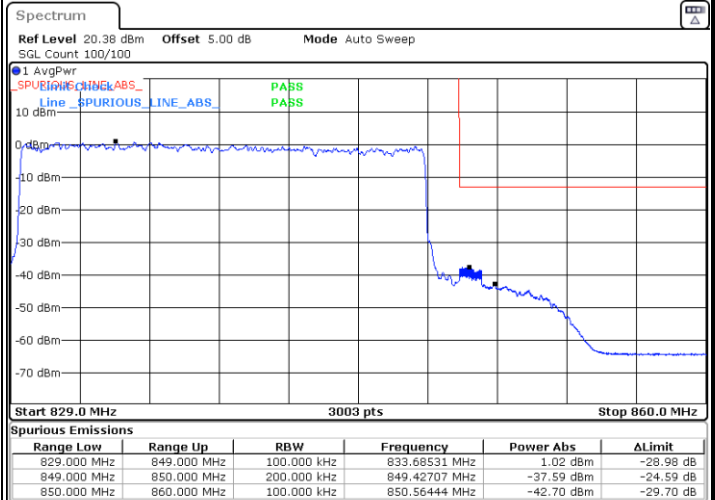
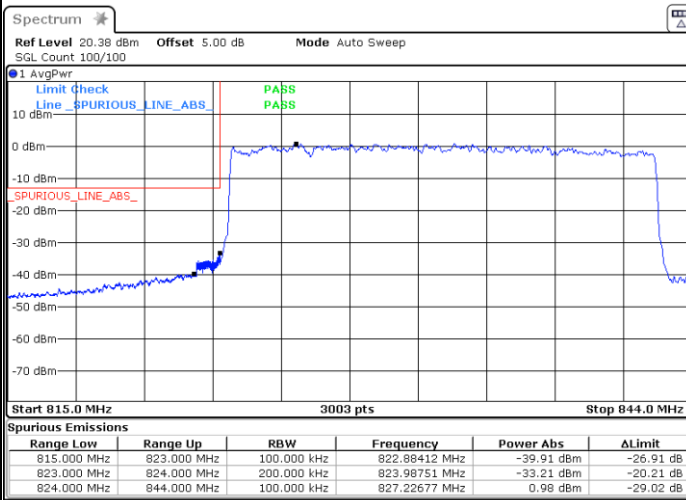

Date: 3.FEB.2021 17:42:47

Date: 3.FEB.2021 17:35:57



FR1 n5 / 20MHz / DFT-s-OFDM / 64QAM

Lowest Band Edge / 1RB0

Highest Band Edge / 1RBMAX

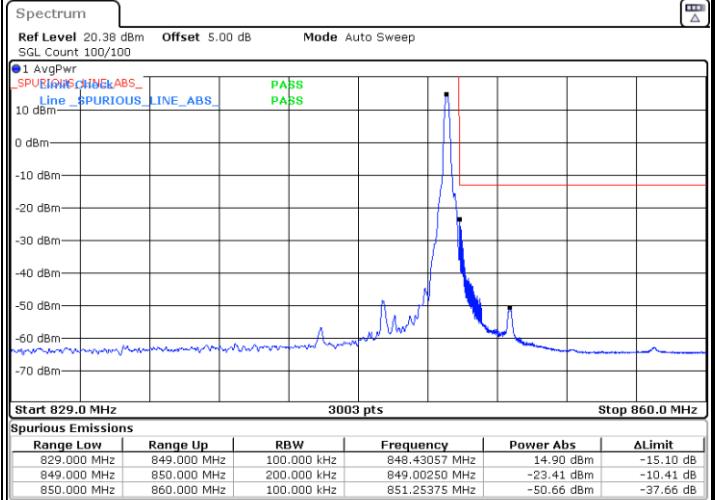
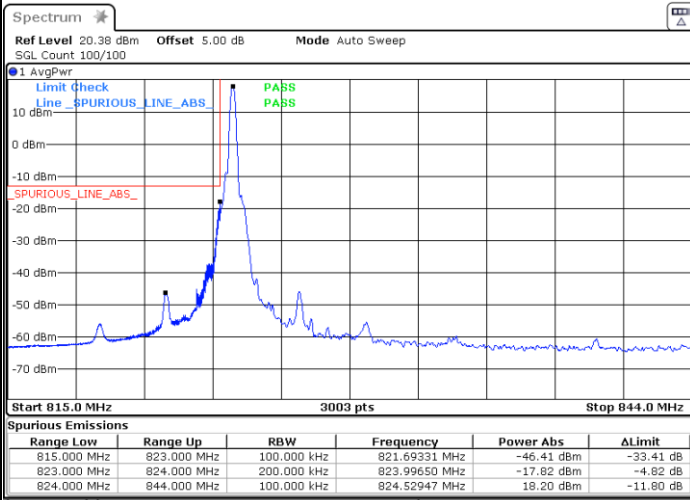

Date: 3.FEB.2021 17:44:33

Date: 3.FEB.2021 17:33:58

Lowest Band Edge / Full RB

Highest Band Edge / Full RB

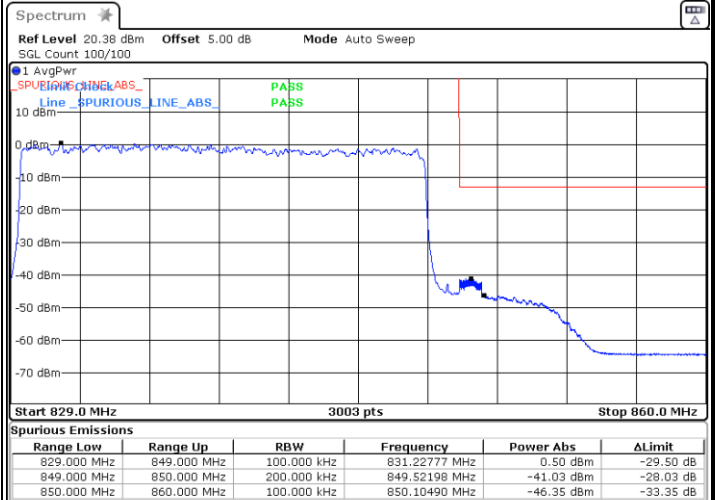
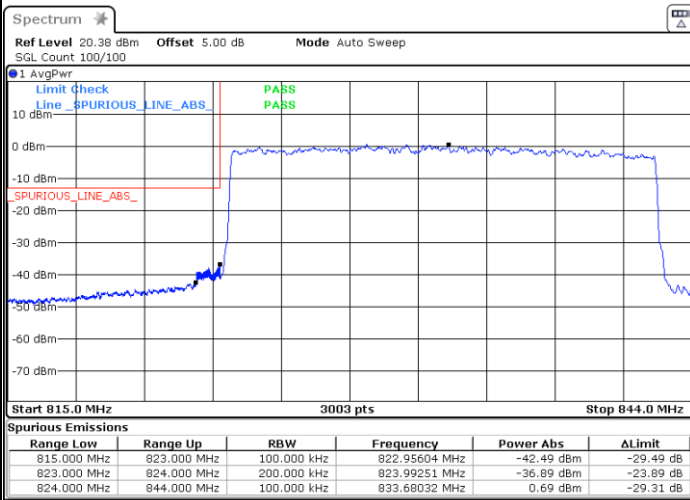

Date: 3.FEB.2021 17:43:44

Date: 3.FEB.2021 17:35:19



FR1 n5/ 20MHz / DFT-s-OFDM / 256QAM

Lowest Band Edge / 1RB0

Highest Band Edge / 1RBMAX

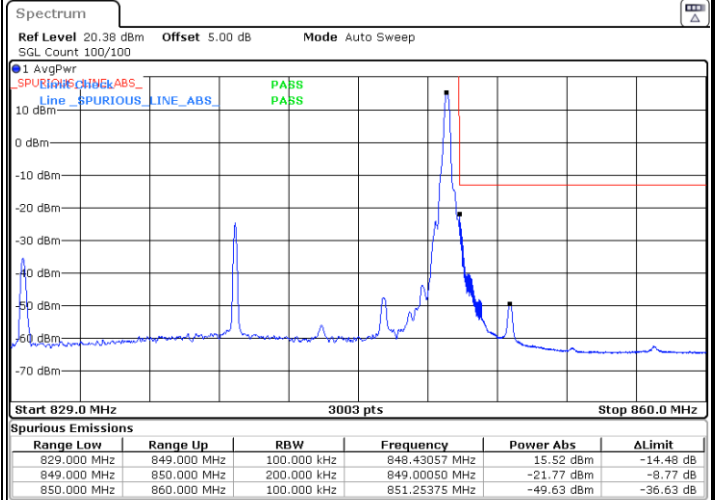
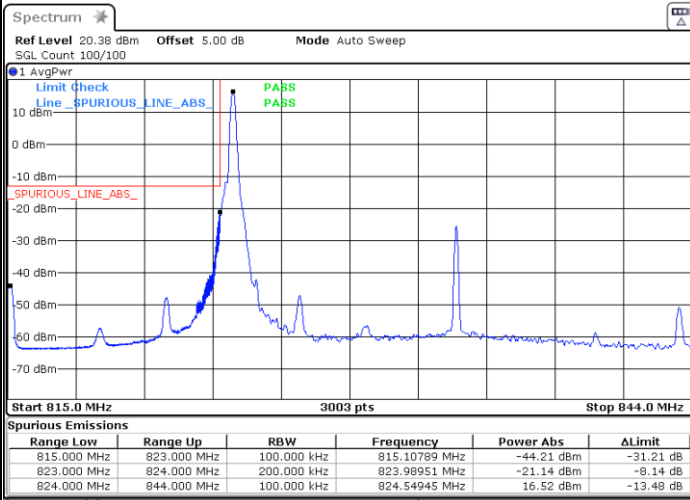

Date: 3.FEB.2021 17:48:42

Date: 3.FEB.2021 17:51:16

Lowest Band Edge / Full RB

Highest Band Edge / Full RB

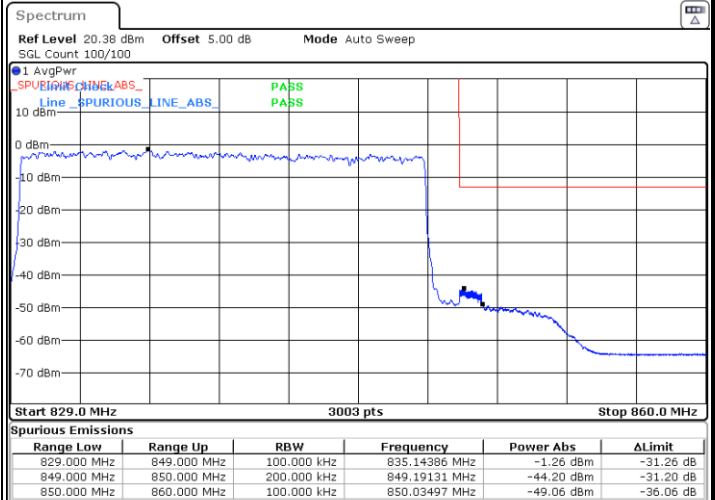
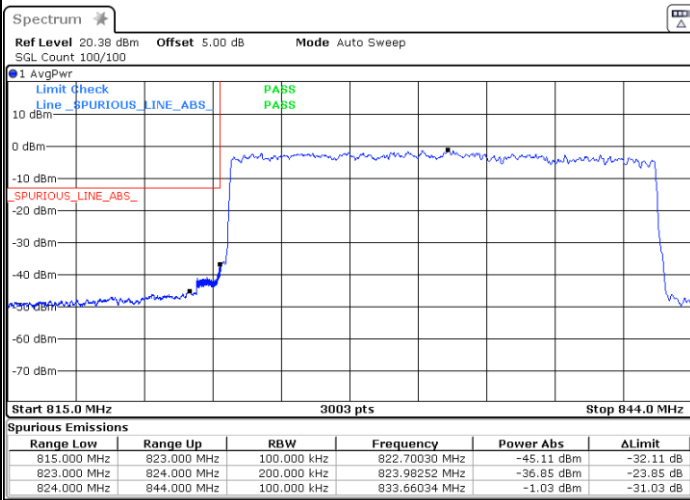

Date: 3.FEB.2021 17:49:45

Date: 3.FEB.2021 17:50:34