

FCC SAR Test Report

APPLICANT : Motorola Mobility LLC
EQUIPMENT : Mobile Cellular Phone
BRAND NAME : Motorola
MODEL NAME : XT2128-2
FCC ID : IHDT56ZQ3
STANDARD : FCC 47 CFR Part 2 (2.1093)

The product was received on Jan. 22, 2021 and testing was started from Jan. 23, 2021 and completed on Feb. 26, 2021. We, Sporton International (ShenZhen) Inc, would like to declare that the tested sample has been evaluated in accordance with the procedures and had been in compliance with the applicable technical standards.

The test results in this report apply exclusively to the tested model / sample. Without written approval of Sporton International (ShenZhen) Inc., the test report shall not be reproduced except in full.

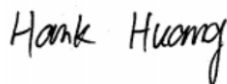

Reviewed by: Hank Huang / Supervisor



Approved by: Johnny Chen / Manager



Sporton International (ShenZhen) Inc.
1/F, 2/F, Bldg 5, Shiling Industrial Zone, Xinwei Village, Xili, Nanshan, Shenzhen, 518055
People's Republic of China



Table of Contents

1. Statement of Compliance 4
2. Administration Data 5
3. Guidance Applied 5
4. Equipment Under Test (EUT) Information 6
4.1 General Information 6
4.2 General LTE SAR Test and Reporting Considerations 7
5. Maximum Tune-up Limit 9
6. Proximity Sensor Triggering Test 10
6.1 Proximity sensor triggering distances(Per KDB616217\$6.2) 10
7. RF Exposure Limits 12
7.1 Uncontrolled Environment 12
7.2 Controlled Environment 12
8. Specific Absorption Rate (SAR) 13
8.1 Introduction 13
8.2 SAR Definition 13
9. System Description and Setup 14
9.1 E-Field Probe 15
9.2 Data Acquisition Electronics (DAE) 15
9.3 Phantom 16
9.4 Device Holder 17
10. Measurement Procedures 18
10.1 Spatial Peak SAR Evaluation 18
10.2 Power Reference Measurement 19
10.3 Area Scan 19
10.4 Zoom Scan 20
10.5 Volume Scan Procedures 20
10.6 Power Drift Monitoring 20
11. Test Equipment List 21
12. System Verification 22
12.1 Tissue Simulating Liquids 22
12.2 Tissue Verification 23
12.3 System Performance Check Results 24
13. RF Exposure Positions 25
13.1 Ear and handset reference point 25
13.2 Definition of the cheek position 26
13.3 Definition of the tilt position 27
13.4 Body Worn Accessory 28
13.5 Product Specific 10g SAR Exposure 29
13.6 Wireless Router 29
14. Conducted RF Output Power (Unit: dBm) 30
15. Antenna Location 40
16. SAR Test Results 41
16.1 Head SAR 44
16.2 Hotspot SAR 47
16.3 Body Worn Accessory SAR 51
16.4 Product specific 10g SAR 55
16.5 Repeated SAR Measurement 58
17. Simultaneous Transmission Analysis 59
17.1 Head Exposure Conditions 60
17.2 Hotspot Exposure Conditions 61
17.3 Body-Worn Accessory Exposure Conditions 62
17.4 Product specific 10g SAR Exposure Conditions 63
17.5 SPLSR Evaluation and Analysis 64
18. Uncertainty Assessment 70
19. References 71
Appendix A. Plots of System Performance Check
Appendix B. Plots of High SAR Measurement
Appendix C. DASY Calibration Certificate
Appendix D. Test Setup Photos
Appendix E. Conducted RF Output Power Table



1. Statement of Compliance

The maximum results of Specific Absorption Rate (SAR) found during testing for **Motorola Mobility LLC, Mobile Cellular Phone, XT2128-2**, are as follows.

Highest 1g SAR Summary						
Equipment Class	Frequency Band		Head (Separation 0mm)	Hotspot (Separation 5mm)	Body-worn (Separation 5mm)	Highest Simultaneous Transmission 1g SAR (W/kg)
			1g SAR (W/kg)			
Licensed	GSM	GSM850	0.57	1.40	1.40	1.54
		GSM1900	0.29	1.30	1.30	
	WCDMA	Band V	0.31	1.33	1.33	
		Band II	0.35	1.31	1.31	
	LTE	Band 26/Band 5	0.48	1.32	1.32	
		Band 2	0.45	1.37	1.37	
		Band 7	0.14	1.34	1.34	
		Band 41/Band 38	<0.10	1.37	1.26	
DTS	WLAN	2.4GHz WLAN	0.94	0.62	0.62	1.47
NII		5GHz WLAN	1.19	1.02	1.16	1.54
DSS	Bluetooth	2.4GHz Bluetooth	<0.10	<0.10	<0.10	1.44

Highest 10g SAR Summary				
Equipment Class	Frequency Band		Product Specific 10g SAR (W/kg) (Separation 0mm)	Highest Simultaneous Transmission 10g SAR (W/kg)
Licensed	GSM	GSM850	2.66	3.53
		GSM1900	3.41	
	WCDMA	Band V	2.43	
		Band II	3.53	
	LTE	Band 26/Band 5	2.56	
		Band 2	3.17	
		Band 7	3.50	
		Band 41/Band 38	2.90	
NII	WLAN	5GHz WLAN	2.50	3.53

Date of Testing: 2021/1/23~2021/2/26

Remark: This device supports LTE B5/B38 and B26/B41. Since the supported frequency span for LTE B5/B38 falls completely within the supports frequency span for LTE B26/B41, both LTE bands have the same target power, and both LTE bands share the same transmission path; therefore, SAR was only assessed for LTE B26/B41.

Declaration of Conformity:

The test results with all measurement uncertainty excluded are presented in accordance with the regulation limits or requirements declared by manufacturers.

Comments and Explanations:

The declared of product specification for EUT presented in the report are provided by the manufacturer, and the manufacturer takes all the responsibilities for the accuracy of product specification.

This device is in compliance with Specific Absorption Rate (SAR) for general population/uncontrolled exposure limits (1.6 W/kg for Partial-Body 1g SAR, 4.0 W/kg for Product Specific 10g SAR) specified in FCC 47 CFR part 2 (2.1093) and ANSI/IEEE C95.1-1992, and had been tested in accordance with the measurement methods and procedures specified in IEEE 1528-2013 and FCC KDB publications.



2. Administration Data

Sporton International (Shenzhen) Inc. is accredited to ISO/IEC 17025:2017 by American Association for Laboratory Accreditation with Certificate Number 5145.01.

Testing Laboratory		
Test Firm	Sporton International (Shenzhen) Inc.	
Test Site Location	1/F, 2/F, Bldg 5, Shiling Industrial Zone, Xinwei Village, Xili, Nanshan, Shenzhen, 518055 People's Republic of China TEL: +86-755-86379589 FAX: +86-755-86379595	
Test Site No.	FCC Designation No.	FCC Test Firm Registration No.
	CN1256	421272

Applicant	
Company Name	Motorola Mobility LLC
Address	222 W, Merchandise Mart Plaza, Chicago, IL60654 USA

Manufacturer	
Company Name	Motorola Mobility LLC
Address	222 W, Merchandise Mart Plaza, Chicago, IL60654 USA

3. Guidance Applied

The Specific Absorption Rate (SAR) testing specification, method, and procedure for this device is in accordance with the following standards:

- FCC 47 CFR Part 2 (2.1093)
- ANSI/IEEE C95.1-1992
- IEEE 1528-2013
- FCC KDB 865664 D01 SAR Measurement 100 MHz to 6 GHz v01r04
- FCC KDB 865664 D02 SAR Reporting v01r02
- FCC KDB 447498 D01 General RF Exposure Guidance v06
- FCC KDB 648474 D04 SAR Evaluation Considerations for Wireless Handsets v01r03
- FCC KDB 248227 D01 802.11 Wi-Fi SAR v02r02
- FCC KDB 616217 D04 SAR for laptop and tablets v01r02
- FCC KDB 941225 D01 3G SAR Procedures v03r01
- FCC KDB 941225 D05 SAR for LTE Devices v02r05
- FCC KDB 941225 D06 Hotspot Mode SAR v02r01

4. Equipment Under Test (EUT) Information

4.1 General Information

Product Feature & Specification	
Equipment Name	Mobile Cellular Phone
Brand Name	Motorola
Model Name	XT2128-2
FCC ID	IHDT56ZQ3
IMEI Code	IMEI 1: 354244970708117 IMEI 2: 354244970708125
Wireless Technology and Frequency Range	GSM850: 824 MHz ~ 849 MHz GSM1900: 1850 MHz ~ 1910 MHz WCDMA Band II: 1850 MHz ~ 1910 MHz WCDMA Band V: 824 MHz ~ 849 MHz LTE Band 2: 1850 MHz ~ 1910 MHz LTE Band 5: 824 MHz ~ 849 MHz LTE Band 7: 2500 MHz ~ 2570 MHz LTE Band 26: 814 MHz ~ 849 MHz LTE Band 38: 2570 MHz ~ 2620 MHz LTE Band 41: 2496 MHz ~ 2690 MHz WLAN 2.4GHz Band: 2412 MHz ~ 2462 MHz WLAN 5.2GHz Band: 5180 MHz ~ 5240 MHz WLAN 5.3GHz Band: 5260 MHz ~ 5320 MHz WLAN 5.5GHz Band: 5500 MHz ~ 5720 MHz WLAN 5.8GHz Band: 5745 MHz ~ 5825 MHz Bluetooth: 2402 MHz ~ 2480 MHz NFC: 13.56 MHz
Mode	GSM/GPRS/EGPRS RMC/AMR 12.2Kbps HSDPA HSUPA DC-HSDPA HSPA+(16QAM uplink is not supported) LTE: QPSK, 16QAM, 64QAM WLAN 2.4GHz 802.11b/g/n HT20 WLAN 5GHz 802.11a/n HT20/HT40 WLAN 5GHz 802.11ac VHT20/VHT40/VHT80 Bluetooth BR/EDR/LE NFC:ASK
HW Version	DVT2
SW Version	RTA31.09
GSM / (E)GPRS Transfer mode	Class B – EUT cannot support Packet Switched and Circuit Switched Network simultaneously but can automatically switch between Packet and Circuit Switched Network.
EUT Stage	Production Unit
Remark:	
<ol style="list-style-type: none"> 802.11n-HT40 is not supported in 2.4GHz WLAN. This device supports VoIP in GPRS, EGPRS, WCDMA and LTE (e.g. for 3rd-party VoIP), LTE supports VoLTE operation. This device 2.4GHz WLAN support hotspot operation and Bluetooth support tethering applications. This device 2.4GHz WLAN/5.2GHz WLAN/5.8GHz WLAN support hotspot operation, and 5.2GHz WLAN/5.8GHz WLAN supports WiFi Direct (GC/GO), and 5.3GHz / 5.5GHz supports WiFi Direct (GC only). This device does not support DTM operation and supports GRPS/EGRPS mode up to multi-slot class 12. The device implements Proximity sensors/receiver detect mechanism/hotspot trigger reduced power for the power management for SAR compliance at different exposure conditions (head, body-worn, hotspot, extremity). The device will invoke corresponding work scenarios power level, which are provided in the operational description. For Some WWAN bands, sensor on reduced power level higher than hotspot reduced power level, so front/back sensor on SAR can represent hotspot conservatively. For dual SIM card mobile has two SIM slots and supports dual SIM dual standby. The WWAN radio transmission will be enabled by either one SIM at a time (single active). After pre-scan two SIM cards power, we found test result of the SIM1 was the worse, so we chose SIM1 slot to perform all tests. 	



9. The device has five headsets, only supplier is different, so we chose headset 1 to perform full SAR testing, and headset 2/3/4/5 only verified the worst case of headset 1.

4.2 General LTE SAR Test and Reporting Considerations

Summarized necessary items addressed in KDB 941225 D05 v02r05																																																															
FCC ID	IHDT56ZQ3																																																														
Equipment Name	Mobile Cellular Phone																																																														
Operating Frequency Range of each LTE transmission band	LTE Band 2: 1850 MHz ~ 1910 MHz LTE Band 5: 824 MHz ~ 849 MHz LTE Band 7: 2500 MHz ~ 2570 MHz LTE Band 26: 814 MHz ~ 849 MHz LTE Band 38: 2570 MHz ~ 2620 MHz LTE Band 41: 2496 MHz ~ 2690 MHz																																																														
Channel Bandwidth	LTE Band 2: 1.4MHz, 3MHz, 5MHz, 10MHz, 15MHz, 20MHz LTE Band 5: 1.4MHz, 3MHz, 5MHz, 10MHz LTE Band 7: 5MHz, 10MHz, 15MHz, 20MHz LTE Band 26: 1.4MHz, 3MHz, 5MHz, 10MHz, 15MHz LTE Band 38: 5MHz, 10MHz, 15MHz, 20MHz LTE Band 41: 5MHz, 10MHz, 15MHz, 20MHz																																																														
uplink modulations used	QPSK/16QAM / 64QAM																																																														
LTE Voice / Data requirements	Voice and Data																																																														
LTE Release Version	R12, Cat5																																																														
CA Support	Not supported																																																														
LTE MPR permanently built-in by design	<p>Table 6.2.3-1: Maximum Power Reduction (MPR) for Power Class 1, 2 and 3</p> <table border="1"> <thead> <tr> <th rowspan="2">Modulation</th> <th colspan="6">Channel bandwidth / Transmission bandwidth (N_{RB})</th> <th rowspan="2">MPR (dB)</th> </tr> <tr> <th>1.4 MHz</th> <th>3.0 MHz</th> <th>5 MHz</th> <th>10 MHz</th> <th>15 MHz</th> <th>20 MHz</th> </tr> </thead> <tbody> <tr> <td>QPSK</td> <td>> 5</td> <td>> 4</td> <td>> 8</td> <td>> 12</td> <td>> 16</td> <td>> 18</td> <td>≤ 1</td> </tr> <tr> <td>16 QAM</td> <td>≤ 5</td> <td>≤ 4</td> <td>≤ 8</td> <td>≤ 12</td> <td>≤ 16</td> <td>≤ 18</td> <td>≤ 1</td> </tr> <tr> <td>16 QAM</td> <td>> 5</td> <td>> 4</td> <td>> 8</td> <td>> 12</td> <td>> 16</td> <td>> 18</td> <td>≤ 2</td> </tr> <tr> <td>64 QAM</td> <td>≤ 5</td> <td>≤ 4</td> <td>≤ 8</td> <td>≤ 12</td> <td>≤ 16</td> <td>≤ 18</td> <td>≤ 2</td> </tr> <tr> <td>64 QAM</td> <td>> 5</td> <td>> 4</td> <td>> 8</td> <td>> 12</td> <td>> 16</td> <td>> 18</td> <td>≤ 3</td> </tr> <tr> <td>256 QAM</td> <td colspan="6" style="text-align: center;">≥ 1</td> <td>≤ 5</td> </tr> </tbody> </table>	Modulation	Channel bandwidth / Transmission bandwidth (N_{RB})						MPR (dB)	1.4 MHz	3.0 MHz	5 MHz	10 MHz	15 MHz	20 MHz	QPSK	> 5	> 4	> 8	> 12	> 16	> 18	≤ 1	16 QAM	≤ 5	≤ 4	≤ 8	≤ 12	≤ 16	≤ 18	≤ 1	16 QAM	> 5	> 4	> 8	> 12	> 16	> 18	≤ 2	64 QAM	≤ 5	≤ 4	≤ 8	≤ 12	≤ 16	≤ 18	≤ 2	64 QAM	> 5	> 4	> 8	> 12	> 16	> 18	≤ 3	256 QAM	≥ 1						≤ 5
Modulation	Channel bandwidth / Transmission bandwidth (N_{RB})						MPR (dB)																																																								
	1.4 MHz	3.0 MHz	5 MHz	10 MHz	15 MHz	20 MHz																																																									
QPSK	> 5	> 4	> 8	> 12	> 16	> 18	≤ 1																																																								
16 QAM	≤ 5	≤ 4	≤ 8	≤ 12	≤ 16	≤ 18	≤ 1																																																								
16 QAM	> 5	> 4	> 8	> 12	> 16	> 18	≤ 2																																																								
64 QAM	≤ 5	≤ 4	≤ 8	≤ 12	≤ 16	≤ 18	≤ 2																																																								
64 QAM	> 5	> 4	> 8	> 12	> 16	> 18	≤ 3																																																								
256 QAM	≥ 1						≤ 5																																																								
LTE A-MPR	In the base station simulator configuration, Network Setting value is set to NS_01 to disable A-MPR during SAR testing and the LTE SAR tests was transmitting on all TTI frames (Maximum TTI)																																																														
Spectrum plots for RB configuration	A properly configured base station simulator was used for the SAR and power measurement; therefore, spectrum plots for each RB allocation and offset configuration are not included in the SAR report.																																																														
Power reduction applied to satisfy SAR compliance	Yes, hotspot and Proximity sensor will trigger reduced power for some LTE bands, the detail please referred to section 14.																																																														



Transmission (H, M, L) channel numbers and frequencies in each LTE band												
LTE Band 2												
	Bandwidth 1.4 MHz		Bandwidth 3 MHz		Bandwidth 5 MHz		Bandwidth 10 MHz		Bandwidth 15 MHz		Bandwidth 20 MHz	
	Ch. #	Freq. (MHz)	Ch. #	Freq. (MHz)	Ch. #	Freq. (MHz)	Ch. #	Freq. (MHz)	Ch. #	Freq. (MHz)	Ch. #	Freq. (MHz)
L	18607	1850.7	18615	1851.5	18625	1852.5	18650	1855	18675	1857.5	18700	1860
M	18900	1880	18900	1880	18900	1880	18900	1880	18900	1880	18900	1880
H	19193	1909.3	19185	1908.5	19175	1907.5	19150	1905	19125	1902.5	19100	1900
LTE Band 5												
	Bandwidth 1.4 MHz		Bandwidth 3 MHz		Bandwidth 5 MHz		Bandwidth 10 MHz					
	Ch. #	Freq. (MHz)	Ch. #	Freq. (MHz)	Ch. #	Freq. (MHz)	Ch. #	Freq. (MHz)	Ch. #	Freq. (MHz)		
L	20407	824.7	20415	825.5	20425	826.5	20450	829				
M	20525	836.5	20525	836.5	20525	836.5	20525	836.5	20525	836.5		
H	20643	848.3	20635	847.5	20625	846.5	20600	844				
LTE Band 7												
	Bandwidth 5 MHz		Bandwidth 10 MHz		Bandwidth 15 MHz		Bandwidth 20 MHz					
	Ch. #	Freq. (MHz)	Ch. #	Freq. (MHz)	Ch. #	Freq. (MHz)	Ch. #	Freq. (MHz)	Ch. #	Freq. (MHz)		
L	20775	2502.5	20800	2505	20825	2507.5	20850	2510				
M	21100	2535	21100	2535	21100	2535	21100	2535				
H	21425	2567.5	21400	2565	21375	2562.5	21350	2560				
LTE Band 26												
	Bandwidth 1.4 MHz		Bandwidth 3 MHz		Bandwidth 5 MHz		Bandwidth 10 MHz		Bandwidth 15 MHz			
	Ch. #	Freq. (MHz)	Ch. #	Freq. (MHz)	Ch. #	Freq. (MHz)	Ch. #	Freq. (MHz)	Ch. #	Freq. (MHz)	Ch. #	Freq. (MHz)
L	26697	814.7	26705	815.5	26715	816.5	26740	819	26765	821.5		
M	26865	831.5	26865	831.5	26865	831.5	26865	831.5	26865	831.5		
H	27033	848.3	27025	847.5	27015	846.5	26990	844	26965	841.5		
LTE Band 38												
	Bandwidth 5 MHz		Bandwidth 10 MHz		Bandwidth 15 MHz		Bandwidth 20 MHz					
	Ch. #	Freq. (MHz)	Ch. #	Freq. (MHz)	Ch. #	Freq. (MHz)	Ch. #	Freq. (MHz)	Ch. #	Freq. (MHz)		
L	37775	2572.5	37800	2575	37825	2577.5	37850	2580				
M	38000	2595	38000	2595	38000	2595	38000	2595				
H	38225	2617.5	38200	2615	38175	2612.5	38150	2610				
LTE Band 41												
	Bandwidth 5 MHz		Bandwidth 10 MHz		Bandwidth 15 MHz		Bandwidth 20 MHz					
	Ch. #	Freq. (MHz)	Ch. #	Freq. (MHz)	Ch. #	Freq. (MHz)	Ch. #	Freq. (MHz)	Ch. #	Freq. (MHz)		
L	39675	2498.5	39700	2501	39725	2503.5	39750	2506				
LM	40148	2545.8	40160	2547	40173	2548.3	40185	2549.5				
M	40620	2593	40620	2593	40620	2593	40620	2593				
HM	41093	2640.3	41080	2639	41068	2637.8	41055	2636.5				
H	41565	2687.5	41540	2685	41515	2682.5	41490	2680				

5. Maximum Tune-up Limit

<Tune-up Limit>

1. For each cellular band, the device has one WWAN Tx antenna, the antenna selection is based on the connection quality condition.
2. The device implements the power management and sensor detection for SAR compliance at different exposure conditions (head, body-worn, hotspot, extremity) and the device will manage to ensure the power level not exceeding the associated power table. Details about the power management decision and sensor detection are provided in the operational description.
3. Below table shows maximum tune up output power configured for this EUT for various transmit conditions by manufacturer, and the detail power measurement and tune-up limit refer to appendix E.

TX. freq.	Default	Head		Body-worn		Hotspot		Handheld	
	max. tune up limit (dBm)	max. tune up limit (dBm)	power reduction (dB)	max. tune up limit (dBm)	power reduction (dB)	max. tune up limit (dBm)	max. tune up limit (dBm)	max. tune up limit (dBm)	max. tune up limit (dBm)
GSM850 GSM 1 Tx slot	33.50	33.50		31.50	2.00	31.50	2.00	33.50	
GSM850 GPRS 1 Tx slot	33.50	33.50		31.50	2.00	31.50	2.00	33.50	
GSM850 GPRS 2 Tx slots	32.00	32.00		30.00	2.00	30.00	2.00	32.00	
GSM850 GPRS 3 Tx slots	30.00	30.00		28.00	2.00	28.00	2.00	30.00	
GSM850 GPRS 4 Tx slots	28.00	28.00		26.00	2.00	26.00	2.00	28.00	
GSM850 EDGE 1 Tx slot	27.00	27.00		25.00	2.00	25.00	2.00	27.00	
GSM850 EDGE 2 Tx slots	25.00	25.00		23.00	2.00	23.00	2.00	25.00	
GSM850 EDGE 3 Tx slots	23.00	23.00		21.00	2.00	21.00	2.00	23.00	
GSM850 EDGE 4 Tx slots	21.00	21.00		19.00	2.00	19.00	2.00	21.00	
GSM1900 GSM 1 Tx slot	30.50	30.50		27.50	3.00	26.00	4.50	29.50	1.00
GSM1900 GPRS 1 Tx slot	30.50	30.50		27.50	3.00	26.00	4.50	29.50	1.00
GSM1900 GPRS 2 Tx slots	29.50	29.50		26.50	3.00	25.00	4.50	28.50	1.00
GSM1900 GPRS 3 Tx slots	27.50	27.50		24.50	3.00	23.00	4.50	26.50	1.00
GSM1900 GPRS 4 Tx slots	25.50	25.50		22.50	3.00	21.00	4.50	24.50	1.00
GSM1900 EDGE 1 Tx slot	26.50	26.50		23.50	3.00	22.00	4.50	25.50	1.00
GSM1900 EDGE 2 Tx slots	25.50	25.50		22.50	3.00	21.00	4.50	24.50	1.00
GSM1900 EDGE 3 Tx slots	23.50	23.50		20.50	3.00	19.00	4.50	22.50	1.00
GSM1900 EDGE 4 Tx slots	21.50	21.50		18.50	3.00	17.00	4.50	20.50	1.00
WCDMA V	24.00	24.00		22.50	1.50	22.50	1.50	24.00	
WCDMA II	24.00	24.00		20.50	3.50	20.50	3.50	22.00	2.00
LTE Band 5	24.00	24.00		23.00	1.00	23.00	1.00	24.00	
LTE Band 26	24.00	24.00		23.00	1.00	23.00	1.00	24.00	
LTE Band 2	24.00	24.00		21.50	2.50	20.00	4.00	23.50	0.50
LTE Band 7	24.00	24.00		19.00	5.00	17.50	6.50	23.50	0.50
LTE Band 38	24.00	24.00		22.00	2.00	21.00	3.00	24.00	
LTE Band 41	24.00	24.00		22.00	2.00	21.00	3.00	24.00	
TX. freq.	Default	Head		Body-worn		Hotspot		Handheld	
	max. tune up limit (dBm)	max. tune up limit (dBm)	power reduction (dB)	max. tune up limit (dBm)	power reduction (dB)	max. tune up limit (dBm)	power reduction (dB)	max. tune up limit (dBm)	power reduction (dB)
WLAN2.4GHz	18.50	17.50	1.00	18.50		18.50		18.50	
WLAN5.2GHz	17.50	16.00	1.50	15.00	2.50	15.00	2.50	17.50	
WLAN5.3GHz	17.50	16.00	1.50	16.00	1.50			17.50	
WLAN5.5GHz	17.50	16.00	1.50	15.00	2.50			17.50	
WLAN5.8GHz	17.50	16.00	1.50	15.00	2.50	15.00	2.50	17.50	
BT	6.00	6.00		6.00		6.00		6.00	

6. Proximity Sensor Triggering Test

6.1 Proximity sensor triggering distances(Per KDB616217§6.2)

- Proximity sensor triggering distance testing was performed according to the procedures outlined in KDB 616217 D04 section 6.2, and EUT moving further away from the flat phantom and EUT moving toward the flat phantom were both assessed and the tissue-equivalent medium for highest frequency (5825MHz) and lowest (850MHz) frequency was used for proximity sensor triggering testing.
- Capacitive proximity sensor placed coincident with antenna elements at the bottom end of the phone are utilized to determine when the device comes in proximity of the user's body at the front or back or bottom surface of the device. There is no need to do sensor coverage testing for the proximity sensor is designed to support sufficient detection range and sensitivity to cover regions of the sensors in all applicable directions since the proximity sensor entirely covers the antenna.
- When the proximity sensor is active, GSM850/1900, WCDMA band II/V, LTE band 2/5/7/26/38/41 and WLAN5.2/5.3/5.5/5.8GHz reduced power will be active for front/ back body worn SAR.
- P-sensor can detect handheld state, GSM1900, WCDMA band II and LTE B2/7 for front/back/bottom sides of product specific 10g SAR condition reduced powers will be active for handheld SAR.
- The proximity sensors used to detect the proximity of the user's body at the front or back or bottom side surface of the device use a detection threshold distance. The data shown in the sections below shows the distance(s).
- For verification of compliance of power reduction scheme, additional SAR testing with EUT transmitting at full RF power at a conservative trigger distance was performed for body worn:
Front: [14 mm](#)
Back: [21 mm](#)
- For verification of compliance of power reduction scheme, additional SAR testing with EUT transmitting at full RF power at a conservative trigger distance was performed for handheld:
Front: [8 mm](#)
Back: [18 mm](#)
Bottom side: [14 mm](#)

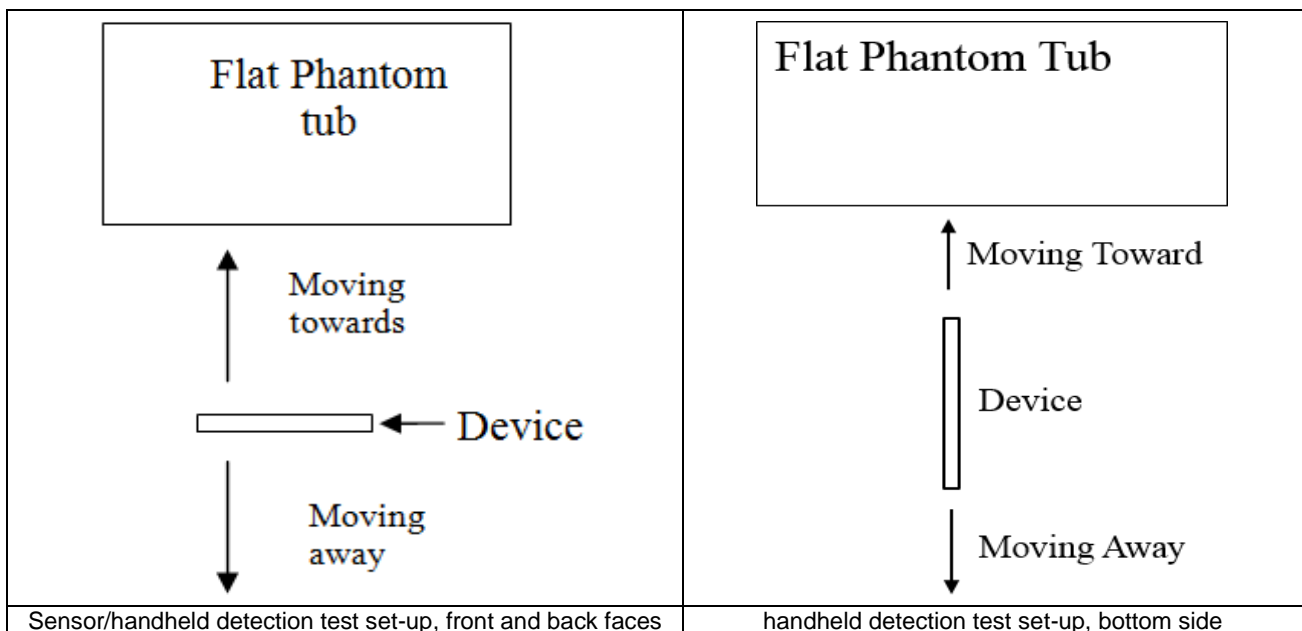

<P-Sensor>

Proximity Sensor Triggering Distance (mm)				
Position	Front		Back	
	Moving towards	Moving away	Moving towards	Moving away
Minimum	15	15	22	22

<Handheld>

Position	Front		Back		Bottom Side	
	Moving towards	Moving away	Moving towards	Moving away	Moving towards	Moving away
Minimum	9	10	19	22	15	17

7. RF Exposure Limits

7.1 Uncontrolled Environment

Uncontrolled Environments are defined as locations where there is the exposure of individuals who have no knowledge or control of their exposure. The general population/uncontrolled exposure limits are applicable to situations in which the general public may be exposed or in which persons who are exposed as a consequence of their employment may not be made fully aware of the potential for exposure or cannot exercise control over their exposure. Members of the general public would come under this category when exposure is not employment-related; for example, in the case of a wireless transmitter that exposes persons in its vicinity.

7.2 Controlled Environment

Controlled Environments are defined as locations where there is exposure that may be incurred by persons who are aware of the potential for exposure, (i.e. as a result of employment or occupation). In general, occupational/controlled exposure limits are applicable to situations in which persons are exposed as a consequence of their employment, who have been made fully aware of the potential for exposure and can exercise control over their exposure. The exposure category is also applicable when the exposure is of a transient nature due to incidental passage through a location where the exposure levels may be higher than the general population/uncontrolled limits, but the exposed person is fully aware of the potential for exposure and can exercise control over his or her exposure by leaving the area or by some other appropriate means.

Limits for Occupational/Controlled Exposure (W/kg)

Whole-Body	Partial-Body	Hands, Wrists, Feet and Ankles
0.4	8.0	20.0

Limits for General Population/Uncontrolled Exposure (W/kg)

Whole-Body	Partial-Body	Hands, Wrists, Feet and Ankles
0.08	1.6	4.0

Whole-Body SAR is averaged over the entire body, partial-body SAR is averaged over any 1gram of tissue defined as a tissue volume in the shape of a cube. SAR for hands, wrists, feet and ankles is averaged over any 10 grams of tissue defined as a tissue volume in the shape of a cube.

8. Specific Absorption Rate (SAR)

8.1 Introduction

SAR is related to the rate at which energy is absorbed per unit mass in an object exposed to a radio field. The SAR distribution in a biological body is complicated and is usually carried out by experimental techniques or numerical modeling. The standard recommends limits for two tiers of groups, occupational/controlled and general population/uncontrolled, based on a person's awareness and ability to exercise control over his or her exposure. In general, occupational/controlled exposure limits are higher than the limits for general population/uncontrolled.

8.2 SAR Definition

The SAR definition is the time derivative (rate) of the incremental energy (dW) absorbed by (dissipated in) an incremental mass (dm) contained in a volume element (dv) of a given density (ρ). The equation description is as below:

$$\text{SAR} = \frac{d}{dt} \left(\frac{dW}{dm} \right) = \frac{d}{dt} \left(\frac{dW}{\rho dv} \right)$$

SAR is expressed in units of Watts per kilogram (W/kg)

$$\text{SAR} = \frac{\sigma |E|^2}{\rho}$$

Where: σ is the conductivity of the tissue, ρ is the mass density of the tissue and E is the RMS electrical field strength.

9. System Description and Setup

The DASY system used for performing compliance tests consists of the following items:

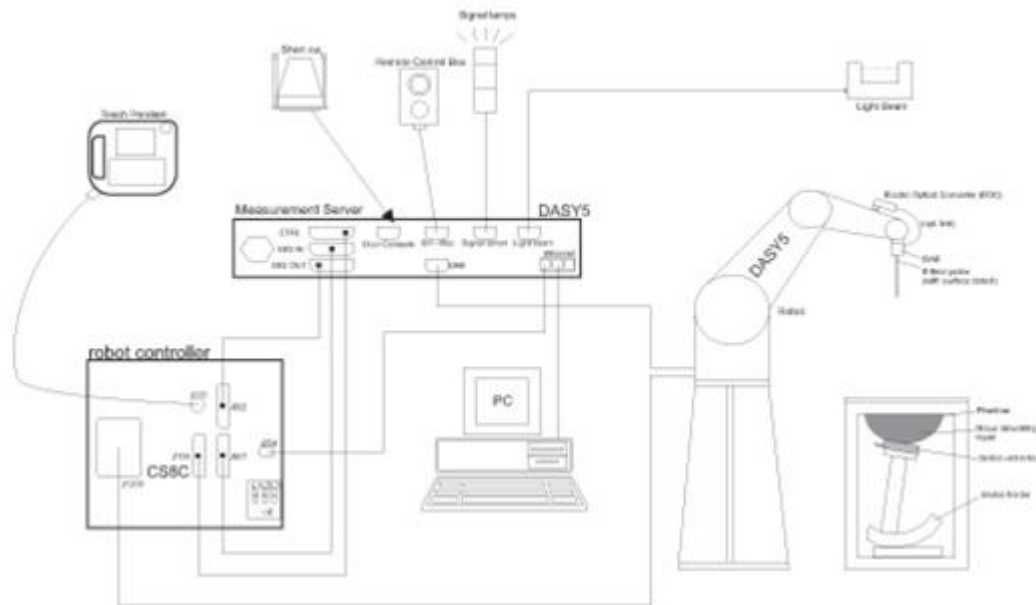

- A standard high precision 6-axis robot with controller, teach pendant and software. An arm extension for accommodating the data acquisition electronics (DAE).
- An isotropic Field probe optimized and calibrated for the targeted measurement.
- A data acquisition electronics (DAE) which performs the signal amplification, signal multiplexing, AD-conversion, offset measurements, mechanical surface detection, collision detection, etc. The unit is battery powered with standard or rechargeable batteries. The signal is optically transmitted to the EOC.
- The Electro-optical converter (EOC) performs the conversion from optical to electrical signals for the digital communication to the DAE. To use optical surface detection, a special version of the EOC is required. The EOC signal is transmitted to the measurement server.
- The function of the measurement server is to perform the time critical tasks such as signal filtering, control of the robot operation and fast movement interrupts.
- The Light Beam used is for probe alignment. This improves the (absolute) accuracy of the probe positioning.
- A computer running WinXP or Win7 and the DASY5 software.
- Remote control and teach pendant as well as additional circuitry for robot safety such as warning lamps, etc.
- The phantom, the device holder and other accessories according to the targeted measurement.

9.1 E-Field Probe

The SAR measurement is conducted with the dosimetric probe (manufactured by SPEAG).The probe is specially designed and calibrated for use in liquid with high permittivity. The dosimetric probe has special calibration in liquid at different frequency. This probe has a built in optical surface detection system to prevent from collision with phantom.

<EX3DV4 Probe>

Construction	Symmetric design with triangular core Built-in shielding against static charges PEEK enclosure material (resistant to organic solvents, e.g., DGBE)	
Frequency	10 MHz – >6 GHz Linearity: ±0.2 dB (30 MHz – 6 GHz)	
Directivity	±0.3 dB in TSL (rotation around probe axis) ±0.5 dB in TSL (rotation normal to probe axis)	
Dynamic Range	10 µW/g – >100 mW/g Linearity: ±0.2 dB (noise: typically <1 µW/g)	
Dimensions	Overall length: 337 mm (tip: 20 mm) Tip diameter: 2.5 mm (body: 12 mm) Typical distance from probe tip to dipole centers: 1 mm	

9.2 Data Acquisition Electronics (DAE)

The data acquisition electronics (DAE) consists of a highly sensitive electrometer-grade preamplifier with auto-zeroing, a channel and gain-switching multiplexer, a fast 16 bit AD-converter and a command decoder and control logic unit. Transmission to the measurement server is accomplished through an optical downlink for data and status information as well as an optical uplink for commands and the clock.

The input impedance of the DAE is 200 MOhm; the inputs are symmetrical and floating. Common mode rejection is above 80 dB.



Photo of DAE

9.3 Phantom

<SAM Twin Phantom>

Shell Thickness	2 ± 0.2 mm; Center ear point: 6 ± 0.2 mm	
Filling Volume	Approx. 25 liters	
Dimensions	Length: 1000 mm; Width: 500 mm; Height: adjustable feet	
Measurement Areas	Left Hand, Right Hand, Flat Phantom	

The bottom plate contains three pair of bolts for locking the device holder. The device holder positions are adjusted to the standard measurement positions in the three sections. A white cover is provided to tap the phantom during off-periods to prevent water evaporation and changes in the liquid parameters. On the phantom top, three reference markers are provided to identify the phantom position with respect to the robot.

<ELI Phantom>

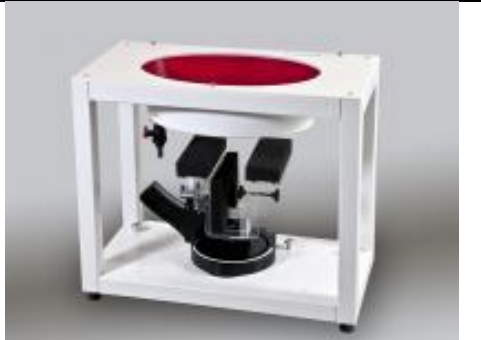
Shell Thickness	2 ± 0.2 mm (sagging: <1%)	
Filling Volume	Approx. 30 liters	
Dimensions	Major ellipse axis: 600 mm Minor axis: 400 mm	

The ELI phantom is intended for compliance testing of handheld and body-mounted wireless devices in the frequency range of 30 MHz to 6 GHz. ELI4 is fully compatible with standard and all known tissue simulating liquids.

9.4 Device Holder

<Mounting Device for Hand-Held Transmitter>

In combination with the Twin SAM V5.0/V5.0c or ELI phantoms, the Mounting Device for Hand-Held Transmitters enables rotation of the mounted transmitter device to specified spherical coordinates. At the heads, the rotation axis is at the ear opening. Transmitter devices can be easily and accurately positioned according to IEC 62209-1, IEEE 1528, FCC, or other specifications. The device holder can be locked for positioning at different phantom sections (left head, right head, flat). And upgrade kit to Mounting Device to enable easy mounting of wider devices like big smart-phones, e-books, small tablets, etc. It holds devices with width up to 140 mm.



Mounting Device for Hand-Held Transmitters



Mounting Device Adaptor for Wide-Phones

<Mounting Device for Laptops and other Body-Worn Transmitters>

The extension is lightweight and made of POM, acrylic glass and foam. It fits easily on the upper part of the mounting device in place of the phone positioned. The extension is fully compatible with the SAM Twin and ELI phantoms.



Mounting Device for Laptops

10. Measurement Procedures

The measurement procedures are as follows:

<Conducted power measurement>

- (a) For WWAN power measurement, use base station simulator to configure EUT WWAN transmission in conducted connection with RF cable, at maximum power in each supported wireless interface and frequency band.
- (b) Read the WWAN RF power level from the base station simulator.
- (c) For WLAN/BT power measurement, use engineering software to configure EUT WLAN/BT continuously transmission, at maximum RF power in each supported wireless interface and frequency band
- (d) Connect EUT RF port through RF cable to the power meter, and measure WLAN/BT output power

<SAR measurement>

- (a) Use base station simulator to configure EUT WWAN transmission in radiated connection, and engineering software to configure EUT WLAN/BT continuously transmission, at maximum RF power, in the highest power channel.
- (b) Place the EUT in the positions as Appendix D demonstrates.
- (c) Set scan area, grid size and other setting on the DASY software.
- (d) Measure SAR results for the highest power channel on each testing position.
- (e) Find out the largest SAR result on these testing positions of each band
- (f) Measure SAR results for other channels in worst SAR testing position if the reported SAR of highest power channel is larger than 0.8 W/kg

According to the test standard, the recommended procedure for assessing the peak spatial-average SAR value consists of the following steps:

- (a) Power reference measurement
- (b) Area scan
- (c) Zoom scan
- (d) Power drift measurement

10.1 Spatial Peak SAR Evaluation

The procedure for spatial peak SAR evaluation has been implemented according to the test standard. It can be conducted for 1g and 10g, as well as for user-specific masses. The DASY software includes all numerical procedures necessary to evaluate the spatial peak SAR value.

The base for the evaluation is a "cube" measurement. The measured volume must include the 1g and 10g cubes with the highest averaged SAR values. For that purpose, the center of the measured volume is aligned to the interpolated peak SAR value of a previously performed area scan.

The entire evaluation of the spatial peak values is performed within the post-processing engine (SEMCAD). The system always gives the maximum values for the 1g and 10g cubes. The algorithm to find the cube with highest averaged SAR is divided into the following stages:

- (a) Extraction of the measured data (grid and values) from the Zoom Scan
- (b) Calculation of the SAR value at every measurement point based on all stored data (A/D values and measurement parameters)
- (c) Generation of a high-resolution mesh within the measured volume
- (d) Interpolation of all measured values from the measurement grid to the high-resolution grid
- (e) Extrapolation of the entire 3-D field distribution to the phantom surface over the distance from sensor to surface
- (f) Calculation of the averaged SAR within masses of 1g and 10g

10.2 Power Reference Measurement

The Power Reference Measurement and Power Drift Measurements are for monitoring the power drift of the device under test in the batch process. The minimum distance of probe sensors to surface determines the closest measurement point to phantom surface. This distance cannot be smaller than the distance of sensor calibration points to probe tip as defined in the probe properties.

10.3 Area Scan

The area scan is used as a fast scan in two dimensions to find the area of high field values, before doing a fine measurement around the hot spot. The sophisticated interpolation routines implemented in DASY software can find the maximum found in the scanned area, within a range of the global maximum. The range (in dB0 is specified in the standards for compliance testing. For example, a 2 dB range is required in IEEE standard 1528 and IEC 62209 standards, whereby 3 dB is a requirement when compliance is assessed in accordance with the ARIB standard (Japan), if only one zoom scan follows the area scan, then only the absolute maximum will be taken as reference. For cases where multiple maximums are detected, the number of zoom scans has to be increased accordingly.

Area scan parameters extracted from FCC KDB 865664 D01v01r04 SAR measurement 100 MHz to 6 GHz.

	≤ 3 GHz	> 3 GHz
Maximum distance from closest measurement point (geometric center of probe sensors) to phantom surface	5 ± 1 mm	$\frac{1}{2} \cdot \delta \cdot \ln(2) \pm 0.5$ mm
Maximum probe angle from probe axis to phantom surface normal at the measurement location	$30^\circ \pm 1^\circ$	$20^\circ \pm 1^\circ$
Maximum area scan spatial resolution: $\Delta x_{Area}, \Delta y_{Area}$	≤ 2 GHz: ≤ 15 mm $2 - 3$ GHz: ≤ 12 mm	$3 - 4$ GHz: ≤ 12 mm $4 - 6$ GHz: ≤ 10 mm
	When the x or y dimension of the test device, in the measurement plane orientation, is smaller than the above, the measurement resolution must be \leq the corresponding x or y dimension of the test device with at least one measurement point on the test device.	

10.4 Zoom Scan

Zoom scans are used to assess the peak spatial SAR values within a cubic averaging volume containing 1 gram and 10 gram of simulated tissue. The zoom scan measures points (refer to table below) within a cube whose base faces are centered on the maxima found in a preceding area scan job within the same procedure. When the measurement is done, the zoom scan evaluates the averaged SAR for 1 gram and 10 gram and displays these values next to the job's label.

Zoom scan parameters extracted from FCC KDB 865664 D01v01r04 SAR measurement 100 MHz to 6 GHz.

			≤ 3 GHz	> 3 GHz
Maximum zoom scan spatial resolution: Δx_{Zoom} , Δy_{Zoom}			≤ 2 GHz: ≤ 8 mm 2 – 3 GHz: ≤ 5 mm*	3 – 4 GHz: ≤ 5 mm* 4 – 6 GHz: ≤ 4 mm*
Maximum zoom scan spatial resolution, normal to phantom surface	uniform grid: $\Delta z_{Zoom}(n)$		≤ 5 mm	3 – 4 GHz: ≤ 4 mm 4 – 5 GHz: ≤ 3 mm 5 – 6 GHz: ≤ 2 mm
	graded grid	$\Delta z_{Zoom}(1)$: between 1 st two points closest to phantom surface	≤ 4 mm	3 – 4 GHz: ≤ 3 mm 4 – 5 GHz: ≤ 2.5 mm 5 – 6 GHz: ≤ 2 mm
		$\Delta z_{Zoom}(n>1)$: between subsequent points	$\leq 1.5 \cdot \Delta z_{Zoom}(n-1)$	
Minimum zoom scan volume	x, y, z		≥ 30 mm	3 – 4 GHz: ≥ 28 mm 4 – 5 GHz: ≥ 25 mm 5 – 6 GHz: ≥ 22 mm
Note: δ is the penetration depth of a plane-wave at normal incidence to the tissue medium; see draft standard IEEE P1528-2011 for details. * When zoom scan is required and the <i>reported</i> SAR from the <i>area scan based 1-g SAR estimation</i> procedures of KDB 447498 is ≤ 1.4 W/kg, ≤ 8 mm, ≤ 7 mm and ≤ 5 mm zoom scan resolution may be applied, respectively, for 2 GHz to 3 GHz, 3 GHz to 4 GHz and 4 GHz to 6 GHz.				

10.5 Volume Scan Procedures

The volume scan is used to assess overlapping SAR distributions for antennas transmitting in different frequency bands. It is equivalent to an oversized zoom scan used in standalone measurements. The measurement volume will be used to enclose all the simultaneous transmitting antennas. For antennas transmitting simultaneously in different frequency bands, the volume scan is measured separately in each frequency band. In order to sum correctly to compute the 1g aggregate SAR, the EUT remain in the same test position for all measurements and all volume scan use the same spatial resolution and grid spacing. When all volume scan were completed, the software, SEMCAD postprocessor can combine and subsequently superpose these measurement data to calculating the multiband SAR.

10.6 Power Drift Monitoring

All SAR testing is under the EUT install full charged battery and transmit maximum output power. In DASy measurement software, the power reference measurement and power drift measurement procedures are used for monitoring the power drift of EUT during SAR test. Both these procedures measure the field at a specified reference position before and after the SAR testing. The software will calculate the field difference in dB. If the power drifts more than 5%, the SAR will be retested.



11. Test Equipment List

Manufacturer	Name of Equipment	Type/Model	Serial Number	Calibration	
				Last Cal.	Due Date
SPEAG	835MHz System Validation Kit	D835V2	4d162	Dec. 05, 2018	Nov. 24, 2021
SPEAG	1900MHz System Validation Kit	D1900V2	5d182	Dec. 07, 2018	Nov. 24, 2021
SPEAG	2450MHz System Validation Kit	D2450V2	924	Sep. 02, 2020	Sep. 01, 2021
SPEAG	2600MHz System Validation Kit	D2600V2	1070	Dec. 07, 2018	Nov. 24, 2021
SPEAG	5000MHz System Validation Kit	D5GHzV2	1167	Aug. 03, 2018	Aug. 02, 2021
SPEAG	Data Acquisition Electronics	DAE4	715	Jul. 27, 2020	Jul. 26, 2021
SPEAG	Dosimetric E-Field Probe	EX3DV4	7577	Sep. 30, 2020	Sep. 29, 2021
SPEAG	SAM Twin Phantom	QD 000 P40 CD	TP-1670	NCR	NCR
SPEAG	Phone Positioner	N/A	N/A	NCR	NCR
Anritsu	Radio communication analyzer	MT8820C	6201341952	Dec. 25, 2020	Dec. 24, 2021
Anritsu	Radio communication analyzer	MT8821C	6262150052	Jul. 15, 2020	Jul. 14, 2021
Agilent	Wireless Communication Test Set	E5515C	MY50267224	Jul. 21, 2020	Jul. 20, 2021
Agilent	Network Analyzer	E5071C	MY46523671	Oct. 15, 2020	Oct. 14, 2021
Speag	Dielectric Assessment KIT	DAK-3.5	1144	Dec. 02, 2020	Dec. 01, 2021
Agilent	Signal Generator	N5181A	MY50145381	Dec. 25, 2020	Dec. 24, 2021
Anritsu	Power Sensor	MA2411B	1306099	Dec. 25, 2020	Dec. 24, 2021
Anritsu	Power Meter	ML2495A	1349001	Jul. 21, 2020	Jul. 20, 2021
Anritsu	Power Sensor	MA2411B	1207253	Dec. 25, 2020	Dec. 24, 2021
Anritsu	Power Meter	ML2495A	1218010	Dec. 25, 2020	Dec. 24, 2021
R&S	CBT BLUETOOTH TESTER	CBT	100963	Dec. 25, 2020	Dec. 24, 2021
R&S	Spectrum Analyzer	FSP7	100818	Jul. 21, 2020	Jul. 20, 2021
TES	Hygrometer	1310	200505600	Jul. 30, 2020	Jul. 29, 2021
Anymetre	Thermo-Hygrometer	JR593	2015030903	Jan. 05, 2021	Jan. 04, 2022
AR	Amplifier	5S1G4	0333096	Note	
mini-circuits	Amplifier	ZVE-3W-83+	599201528	Note	
ARRA	Power Divider	A3200-2	N/A	Note	
PASTERNAK	Dual Directional Coupler	PE2214-10	N/A	Note	
ET Industries	Dual Directional Coupler	C-058-10	N/A	Note	
MCL	Attenuator 1	BW-S10W5	N/A	Note	
Weinschel	Attenuator 2	3M-20	N/A	Note	
Weinschel	Attenuator 3	MVE2214-03	N/A	Note	

Note:

1. Prior to system verification and validation, the path loss from the signal generator to the system check source and the power meter, which includes the amplifier, cable, attenuator and directional coupler, was measured by the network analyzer. The reading of the power meter was offset by the path loss difference between the path to the power meter and the path to the system check source to monitor the actual power level fed to the system check
2. Referring to KDB 865664 D01v01r04, the dipole calibration interval can be extended to 3 years with justification. The dipoles are also not physically damaged, or repaired during the interval.
3. The justification data of dipole can be found in appendix C. The return loss is < -20dB, within 20% of prior calibration, the impedance is within 5 ohm of prior calibration.

12. System Verification

12.1 Tissue Simulating Liquids

For the measurement of the field distribution inside the SAM phantom with DASY, the phantom must be filled with around 25 liters of homogeneous body tissue simulating liquid. For head SAR testing, the liquid height from the ear reference point (ERP) of the phantom to the liquid top surface is larger than 15 cm, which is shown in Fig. 11.1. For body SAR testing, the liquid height from the center of the flat phantom to the liquid top surface is larger than 15 cm, which is shown in Fig. 11.2.

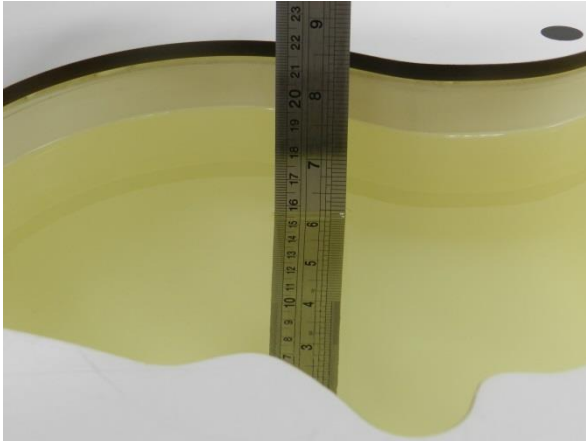

Fig 11.1 Photo of Liquid Height for Head SAR

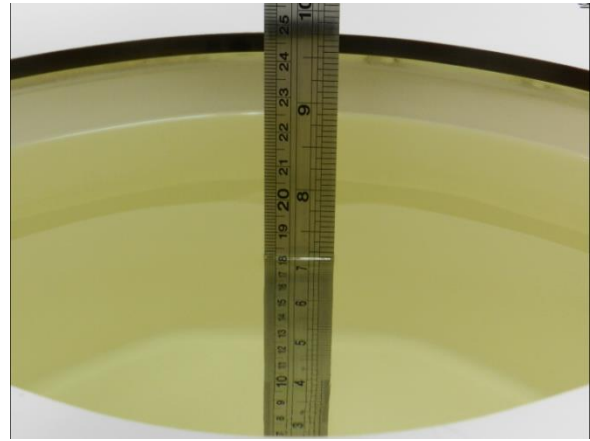

Fig 11.2 Photo of Liquid Height for Body SAR

12.2 Tissue Verification

The following tissue formulations are provided for reference only as some of the parameters have not been thoroughly verified. The composition of ingredients may be modified accordingly to achieve the desired target tissue parameters required for routine SAR evaluation.

Frequency (MHz)	Water (%)	Sugar (%)	Cellulose (%)	Salt (%)	Preventol (%)	DGBE (%)	Conductivity (σ)	Permittivity (ϵ_r)
For Head								
835	40.3	57.9	0.2	1.4	0.2	0	0.90	41.5
1800, 1900, 2000	55.2	0	0	0.3	0	44.5	1.40	40.0
2450	55.0	0	0	0	0	45.0	1.80	39.2
2600	54.8	0	0	0.1	0	45.1	1.96	39.0

Simulating Liquid for 5GHz, Manufactured by SPEAG

Ingredients	(% by weight)
Water	64~78%
Mineral oil	11~18%
Emulsifiers	9~15%
Additives and Salt	2~3%

<Tissue Dielectric Parameter Check Results>

Frequency (MHz)	Tissue Type	Liquid Temp. (°C)	Conductivity (σ)	Permittivity (ϵ_r)	Conductivity Target (σ)	Permittivity Target (ϵ_r)	Delta (σ) (%)	Delta (ϵ_r) (%)	Limit (%)	Date
835	Head	22.4	0.910	42.776	0.90	41.50	1.11	3.07	±5	2021/1/23
1900	Head	22.6	1.422	41.138	1.40	40.00	1.57	2.85	±5	2021/2/20
1900	Head	22.6	1.457	39.135	1.40	40.00	4.07	-2.16	±5	2021/2/25
2450	Head	22.6	1.754	40.370	1.80	39.20	-2.56	2.98	±5	2021/1/31
2600	Head	22.5	1.922	39.818	1.96	39.00	-1.94	2.10	±5	2021/2/22
2600	Head	22.4	2.055	37.597	1.96	39.00	4.85	-3.60	±5	2021/2/26
5250	Head	22.3	4.699	35.407	4.71	35.95	-0.23	-1.51	±5	2021/2/7
5600	Head	22.2	5.044	34.914	5.07	35.50	-0.51	-1.65	±5	2021/2/12
5750	Head	22.5	5.182	34.643	5.22	35.35	-0.73	-2.00	±5	2021/2/12

12.3 System Performance Check Results

Comparing to the original SAR value provided by SPEAG, the verification data should be within its specification of 10 %. Below table shows the target SAR and measured SAR after normalized to 1W input power. The table below indicates the system performance check can meet the variation criterion and the plots can be referred to Appendix A of this report.

<1g SAR>

Date	Frequency (MHz)	Tissue Type	Input Power (mW)	Dipole S/N	Probe S/N	DAE S/N	Measured 1g SAR (W/kg)	Targeted 1g SAR (W/kg)	Normalized 1g SAR (W/kg)	Deviation (%)
2021/1/23	835	Head	250	4d162	7577	715	2.42	9.61	9.68	0.73
2021/2/20	1900	Head	250	5d182	7577	715	10.30	39.60	41.2	4.04
2021/2/25	1900	Head	250	5d182	7577	715	9.79	39.60	39.16	-1.11
2021/1/31	2450	Head	250	924	7577	715	12.00	51.40	48	-6.61
2021/2/22	2600	Head	250	1070	7577	715	13.80	58.10	55.2	-4.99
2021/2/26	2600	Head	250	1070	7577	715	14.30	58.10	57.2	-1.55
2021/2/7	5250	Head	100	1167	7577	715	8.25	77.00	82.5	7.14
2021/2/12	5600	Head	100	1167	7577	715	8.73	80.80	87.3	8.04
2021/2/12	5750	Head	100	1167	7577	715	8.16	76.90	81.6	6.11

<10g SAR>

Date	Frequency (MHz)	Tissue Type	Input Power (mW)	Dipole S/N	Probe S/N	DAE S/N	Measured 10g SAR (W/kg)	Targeted 10g SAR (W/kg)	Normalized 10g SAR (W/kg)	Deviation (%)
2021/1/23	835	Head	250	4d162	7577	715	1.58	6.35	6.32	-0.47
2021/2/20	1900	Head	250	5d182	7577	715	5.28	20.70	21.12	2.03
2021/2/25	1900	Head	250	5d182	7577	715	5.07	20.70	20.28	-2.03
2021/1/31	2450	Head	250	924	7577	715	5.59	24.00	22.36	-6.83
2021/2/22	2600	Head	250	1070	7577	715	6.12	26.10	24.48	-6.21
2021/2/26	2600	Head	250	1070	7577	715	6.41	26.10	25.64	-1.76
2021/2/7	5250	Head	100	1167	7577	715	2.30	22.00	23	4.55
2021/2/12	5600	Head	100	1167	7577	715	2.43	23.20	24.3	4.74
2021/2/12	5750	Head	100	1167	7577	715	2.31	21.60	23.1	6.94

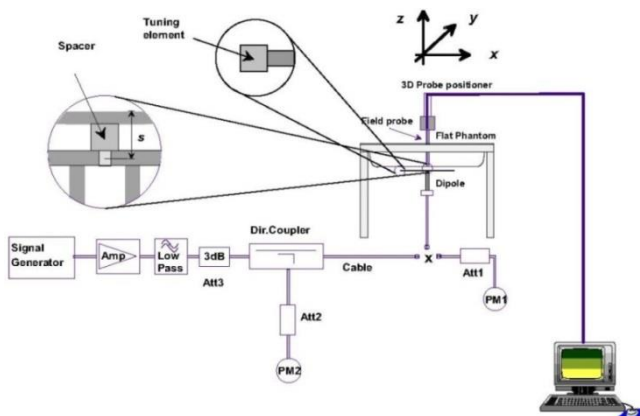

Fig 11.3.1 System Performance Check Setup



Fig 11.3.2 Setup Photo

13. RF Exposure Positions

13.1 Ear and handset reference point

Figure 12.1.1 shows the front, back, and side views of the SAM phantom. The center-of-mouth reference point is labeled “M,” the left ear reference point (ERP) is marked “LE,” and the right ERP is marked “RE.” Each ERP is 15 mm along the B-M (back-mouth) line behind the entrance-to-ear-canal (EEC) point, as shown in Figure 12.1.2 The Reference Plane is defined as passing through the two ear reference points and point M. The line N-F (neck-front), also called the reference pivoting line, is normal to the Reference Plane and perpendicular to both a line passing through RE and LE and the B-M line (see Figure 12.1.3). Both N-F and B-M lines should be marked on the exterior of the phantom shell to facilitate handset positioning. Posterior to the N-F line the ear shape is a flat surface with 6 mm thickness at each ERP, and forward of the N-F line the ear is truncated, as illustrated in Figure 12.1.2. The ear truncation is introduced to preclude the ear lobe from interfering with handset tilt, which could lead to unstable positioning at the cheek.

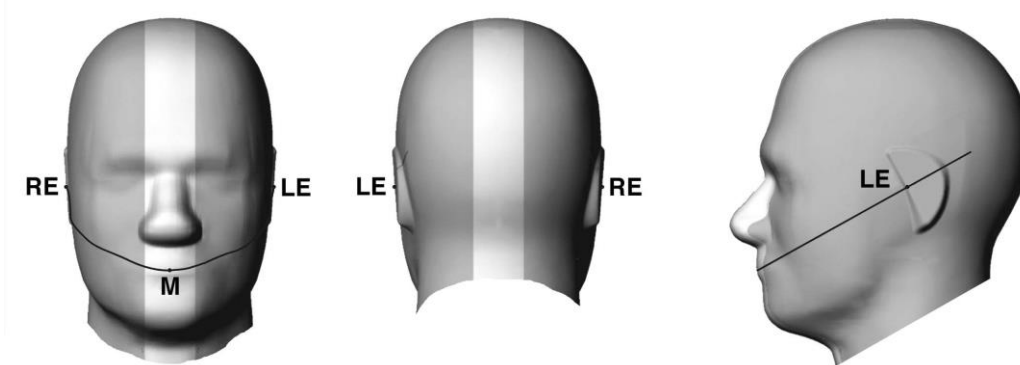

Fig 12.1.1 Front, back, and side views of SAM twin phantom

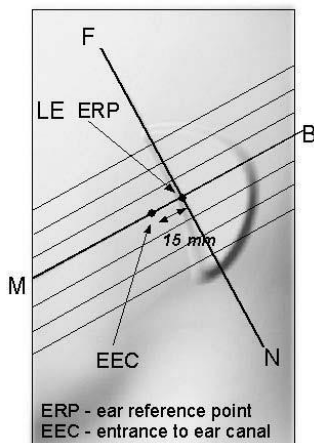

Fig 12.1.2 Close-up side view of phantom showing the ear region.

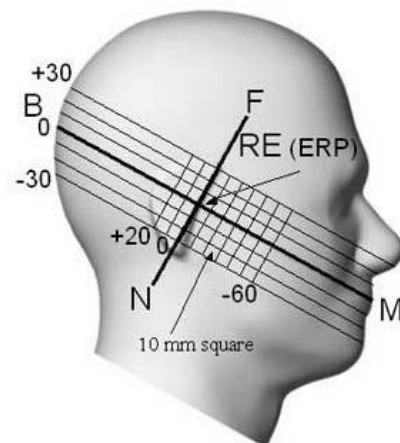

Fig 12.1.3 Side view of the phantom showing relevant markings and seven cross-sectional plane locations

13.2 Definition of the cheek position

1. Ready the handset for talk operation, if necessary. For example, for handsets with a cover piece (flip cover), open the cover. If the handset can transmit with the cover closed, both configurations must be tested.
2. Define two imaginary lines on the handset—the vertical centerline and the horizontal line. The vertical centerline passes through two points on the front side of the handset—the midpoint of the width w_t of the handset at the level of the acoustic output (point A in Figure 12.2.1 and Figure 12.2.2), and the midpoint of the width w_b of the bottom of the handset (point B). The horizontal line is perpendicular to the vertical centerline and passes through the center of the acoustic output (see Figure 12.2.1). The two lines intersect at point A. Note that for many handsets, point A coincides with the center of the acoustic output; however, the acoustic output may be located elsewhere on the horizontal line. Also note that the vertical centerline is not necessarily parallel to the front face of the handset (see Figure 12.2.2), especially for clamshell handsets, handsets with flip covers, and other irregularly-shaped handsets.
3. Position the handset close to the surface of the phantom such that point A is on the (virtual) extension of the line passing through points RE and LE on the phantom (see Figure 12.2.3), such that the plane defined by the vertical centerline and the horizontal line of the handset is approximately parallel to the sagittal plane of the phantom.
4. Translate the handset towards the phantom along the line passing through RE and LE until handset point A touches the pinna at the ERP.
5. While maintaining the handset in this plane, rotate it around the LE-RE line until the vertical centerline is in the plane normal to the plane containing B-M and N-F lines, i.e., the Reference Plane.
6. Rotate the handset around the vertical centerline until the handset (horizontal line) is parallel to the N-F line.
7. While maintaining the vertical centerline in the Reference Plane, keeping point A on the line passing through RE and LE, and maintaining the handset contact with the pinna, rotate the handset about the N-F line until any point on the handset is in contact with a phantom point below the pinna on the cheek. See Figure 12.2.3. The actual rotation angles should be documented in the test report.

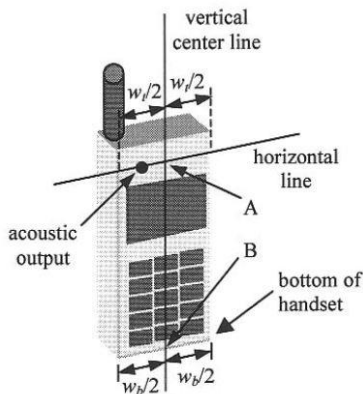

Fig 12.2.1 Handset vertical and horizontal reference lines—“fixed case”

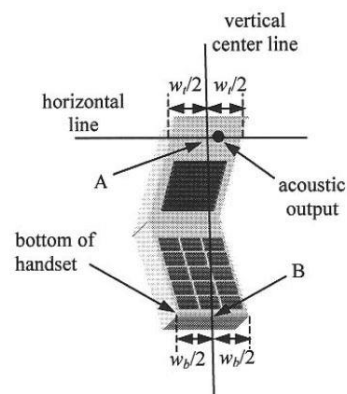

Fig 12.2.2 Handset vertical and horizontal reference lines—“clam-shell case”

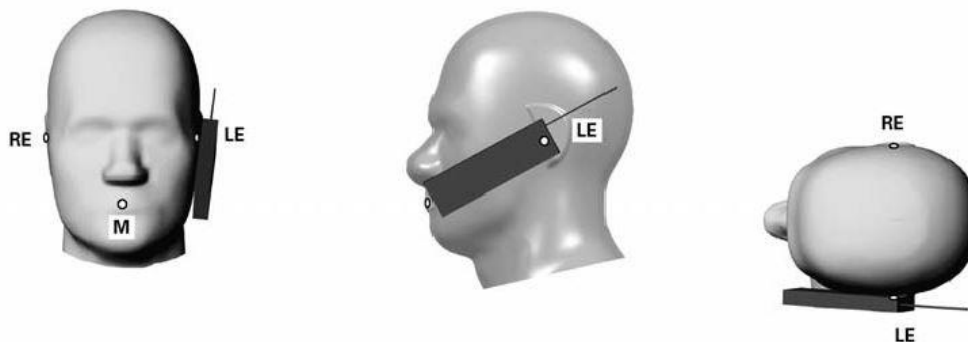

Fig 12.2.3 cheek or touch position. The reference points for the right ear (RE), left ear (LE), and mouth (M), which establish the Reference Plane for handset positioning, are indicated.

13.3 Definition of the tilt position

1. Ready the handset for talk operation, if necessary. For example, for handsets with a cover piece (flip cover), open the cover. If the handset can transmit with the cover closed, both configurations must be tested.
2. While maintaining the orientation of the handset, move the handset away from the pinna along the line passing through RE and LE far enough to allow a rotation of the handset away from the cheek by 15°.
3. Rotate the handset around the horizontal line by 15°.
4. While maintaining the orientation of the handset, move the handset towards the phantom on the line passing through RE and LE until any part of the handset touches the ear. The tilt position is obtained when the contact point is on the pinna. See Figure 12.3.1. If contact occurs at any location other than the pinna, e.g., the antenna at the back of the phantom head, the angle of the handset should be reduced. In this case, the tilt position is obtained if any point on the handset is in contact with the pinna and a second point

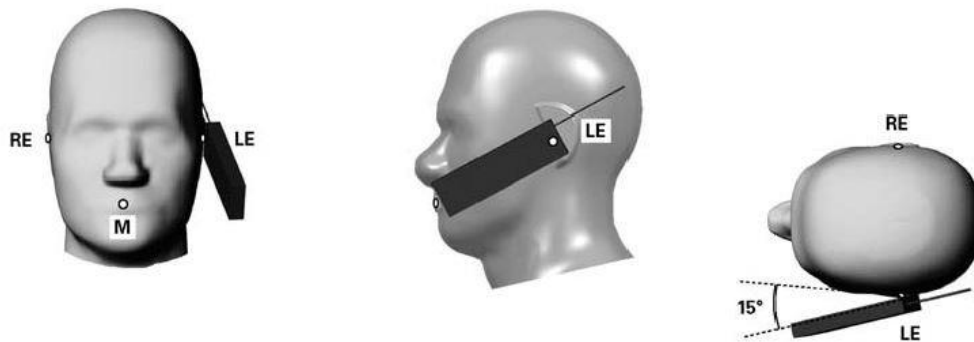

Fig 12.3.1 Tilt position. The reference points for the right ear (RE), left ear (LE), and mouth (M), which define the Reference Plane for handset positioning, are indicated.

13.4 Body Worn Accessory

Body-worn operating configurations are tested with the belt-clips and holsters attached to the device and positioned against a flat phantom in a normal use configuration (see Figure 12.4). Per KDB648474 D04v01r03, body-worn accessory exposure is typically related to voice mode operations when handsets are carried in body-worn accessories. The body-worn accessory procedures in FCC KDB 447498 D01v06 should be used to test for body-worn accessory SAR compliance, without a headset connected to it. This enables the test results for such configuration to be compatible with that required for hotspot mode when the body-worn accessory test separation distance is greater than or equal to that required for hotspot mode, when applicable. When the reported SAR for body-worn accessory, measured without a headset connected to the handset is $> 1.2 \text{ W/kg}$, the highest reported SAR configuration for that wireless mode and frequency band should be repeated for that body-worn accessory with a headset attached to the handset.

Accessories for body-worn operation configurations are divided into two categories: those that do not contain metallic components and those that do contain metallic components. When multiple accessories that do not contain metallic components are supplied with the device, the device is tested with only the accessory that dictates the closest spacing to the body. Then multiple accessories that contain metallic components are tested with the device with each accessory. If multiple accessories share an identical metallic component (i.e. the same metallic belt-clip used with different holsters with no other metallic components) only the accessory that dictates the closest spacing to the body is tested.

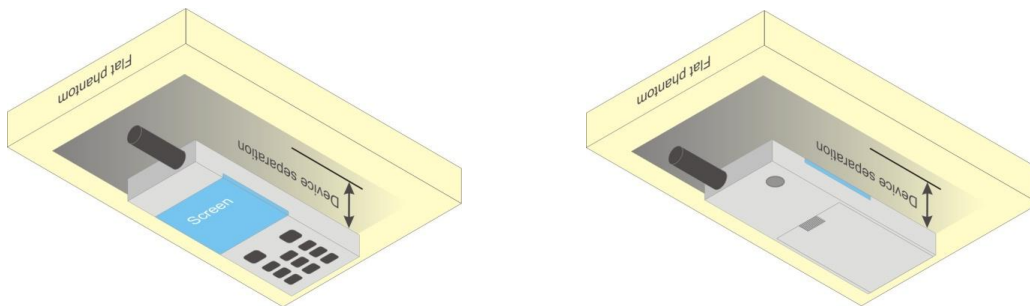

Fig 12.4 Body Worn Position



13.5 Product Specific 10g SAR Exposure

For smart phones with a display diagonal dimension > 15.0 cm or an overall diagonal dimension > 16.0 cm that provide similar mobile web access and multimedia support found in mini-tablets or UMPC mini-tablets that support voice calls next to the ear, According to KDB648474 D04v01r03, the following phablet procedures should be applied to evaluate SAR compliance for each applicable wireless modes and frequency band. Devices marketed as phablets, regardless of form factors and operating characteristics must be tested as a phablet to determine SAR compliance

1. The normally required head and body-worn accessory SAR test procedures for handsets, including hotspot mode, must be applied.
2. The UMPC mini-tablet procedures must also be applied to test the SAR of all surfaces and edges with an antenna located at ≤ 25 mm from that surface or edge, in direct contact with a flat phantom, for 10-g extremity SAR according to the body-equivalent tissue dielectric parameters in KDB 865664 to address interactive hand use exposure conditions.6 The UMPC mini-tablet 1-g SAR at 5 mm is not required. When hotspot mode applies, 10-g extremity SAR is required only for the surfaces and edges with hotspot mode 1-g reported SAR > 1.2 W/kg.

13.6 Wireless Router

Some battery-operated handsets have the capability to transmit and receive user through simultaneous transmission of WIFI simultaneously with a separate licensed transmitter. The FCC has provided guidance in FCC KDB Publication 941225 D06 v02r01 where SAR test considerations for handsets ($L \times W \geq 9 \text{ cm} \times 5 \text{ cm}$) are based on a composite test separation distance of 10mm from the front, back and edges of the device containing transmitting antennas within 2.5cm of their edges, determined from general mixed use conditions for this type of devices. Since the hotspot SAR results may overlap with the body-worn accessory SAR requirements, the more conservative configurations can be considered, thus excluding some body-worn accessory SAR tests.

When the user enables the personal wireless router functions for the handset, actual operations include simultaneous transmission of both the WIFI transmitter and another licensed transmitter. Both transmitters often do not transmit at the same transmitting frequency and thus cannot be evaluated for SAR under actual use conditions due to the limitations of the SAR assessment probes. Therefore, SAR must be evaluated for each frequency transmission and mode separately and spatially summed with the WIFI transmitter according to FCC KDB Publication 447498 D01v06 publication procedures. The "Portable Hotspot" feature on the handset was NOT activated during SAR assessments, to ensure the SAR measurements were evaluated for a single transmission frequency RF signal at a time.

14. Conducted RF Output Power (Unit: dBm)

The detailed conducted power table can refer to Appendix E.

<GSM Conducted Power>

1. Per KDB 447498 D01v06, the maximum output power channel is used for SAR testing and for further SAR test reduction.
2. Per KDB 941225 D01v03r01, for SAR test reduction for GSM / GPRS / EDGE modes is determined by the source-based time-averaged output power including tune-up tolerance. The mode with highest specified time-averaged output power should be tested for SAR compliance in the applicable exposure conditions. For modes with the same specified maximum output power and tolerance, the higher number time-slot configuration should be tested. Therefore, the GPRS 2Tx slots for GSM850/GSM1900 are considered as the primary mode.
3. Other configurations of GSM / GPRS / EDGE are considered as secondary modes. The 3G SAR test reduction procedure is applied, when the maximum output power and tune-up tolerance specified for production units in a secondary mode is $\leq 1/4$ dB higher than the primary mode, SAR measurement is not required for the secondary mode.

<WCDMA Conducted Power>

1. The following tests were conducted according to the test requirements outlines in 3GPP TS 34.121 specification.
2. The procedures in KDB 941225 D01v03r01 are applied for 3GPP Rel. 6 HSPA to configure the device in the required sub-test mode(s) to determine SAR test exclusion.
3. For DC-HSDPA, the device was configured according to the H-Set 12, Fixed Reference Channel (FRC) configuration in Table C.8.1.12 of 3GPP TS 34.121-1, with the primary and the secondary serving HS-DSCH Cell enabled during the power measurement.

A summary of these settings are illustrated below:

HSDPA Setup Configuration:

- a. The EUT was connected to Base Station Agilent E5515C referred to the Setup Configuration.
- b. The RF path losses were compensated into the measurements.
- c. A call was established between EUT and Base Station with following setting:
 - i. Set Gain Factors (β_c and β_d) and parameters were set according to each
 - ii. Specific sub-test in the following table, C10.1.4, quoted from the TS 34.121
 - iii. Set RMC 12.2Kbps + HSDPA mode.
 - iv. Set Cell Power = -86 dBm
 - v. Set HS-DSCH Configuration Type to FRC (H-set 1, QPSK)
 - vi. Select HSDPA Uplink Parameters
 - vii. Set Delta ACK, Delta NACK and Delta CQI = 8
 - viii. Set Ack-Nack Repetition Factor to 3
 - ix. Set CQI Feedback Cycle (k) to 4 ms
 - x. Set CQI Repetition Factor to 2
 - xi. Power Ctrl Mode = All Up bits
- d. The transmitted maximum output power was recorded.

Table C.10.1.4: β values for transmitter characteristics tests with HS-DPCCH

Sub-test	β_c	β_d	β_d (SF)	β_c/β_d	β_{HS} (Note 1, Note 2)	CM (dB) (Note 3)	MPR (dB) (Note 3)
1	2/15	15/15	64	2/15	4/15	0.0	0.0
2	12/15 (Note 4)	15/15 (Note 4)	64	12/15 (Note 4)	24/15	1.0	0.0
3	15/15	8/15	64	15/8	30/15	1.5	0.5
4	15/15	4/15	64	15/4	30/15	1.5	0.5

Note 1: Δ_{ACK} , Δ_{NACK} and $\Delta_{CQI} = 30/15$ with $\beta_{HS} = 30/15 * \beta_c$.

Note 2: For the HS-DPCCH power mask requirement test in clause 5.2C, 5.7A, and the Error Vector Magnitude (EVM) with HS-DPCCH test in clause 5.13.1A, and HSDPA EVM with phase discontinuity in clause 5.13.1AA, Δ_{ACK} and $\Delta_{NACK} = 30/15$ with $\beta_{HS} = 30/15 * \beta_c$, and $\Delta_{CQI} = 24/15$ with $\beta_{HS} = 24/15 * \beta_c$.

Note 3: CM = 1 for $\beta_c/\beta_d = 12/15$, $\beta_{HS}/\beta_c = 24/15$. For all other combinations of DPDCCH, DPCCH and HS-DPCCH the MPR is based on the relative CM difference. This is applicable for only UEs that support HSDPA in release 6 and later releases.

Note 4: For subtest 2 the β_c/β_d ratio of 12/15 for the TFC during the measurement period (TF1, TF0) is achieved by setting the signalled gain factors for the reference TFC (TF1, TF1) to $\beta_c = 11/15$ and $\beta_d = 15/15$.

Setup Configuration

HSUPA Setup Configuration:

- a. The EUT was connected to Base Station Agilent E5515C referred to the Setup Configuration.
- b. The RF path losses were compensated into the measurements.
- c. A call was established between EUT and Base Station with following setting * :
 - i. Call Configs = 5.2B, 5.9B, 5.10B, and 5.13.2B with QPSK
 - ii. Set the Gain Factors (β_c and β_d) and parameters (AG Index) were set according to each specific sub-test in the following table, C11.1.3, quoted from the TS 34.121
 - iii. Set Cell Power = -86 dBm
 - iv. Set Channel Type = 12.2k + HSPA
 - v. Set UE Target Power
 - vi. Power Ctrl Mode= Alternating bits
 - vii. Set and observe the E-TFCI
 - viii. Confirm that E-TFCI is equal to the target E-TFCI of 75 for sub-test 1, and other subtest's E-TFCI
- d. The transmitted maximum output power was recorded.

Table C.11.1.3: β values for transmitter characteristics tests with HS-DPCCH and E-DCH

Sub-test	β_c	β_d	β_d (SF)	β_c/β_d	β_{HS} (Note1)	β_{ec}	β_{ed} (Note 4) (Note 5)	β_{ed} (SF)	β_{ed} (Codes)	CM (dB) (Note 2)	MPR (dB) (Note 2) (Note 6)	AG Index (Note 5)	E-TFCI
1	11/15 (Note 3)	15/15 (Note 3)	64	11/15 (Note 3)	22/15	209/25	1309/225	4	1	1.0	0.0	20	75
2	6/15	15/15	64	6/15	12/15	12/15	94/75	4	1	3.0	2.0	12	67
3	15/15	9/15	64	15/9	30/15	30/15	β_{ed1} : 47/15 β_{ed2} : 47/15	4 4	2	2.0	1.0	15	92
4	2/15	15/15	64	2/15	4/15	2/15	56/75	4	1	3.0	2.0	17	71
5	15/15	0	-	-	5/15	5/15	47/15	4	1	1.0	0.0	12	67

Note 1: For sub-test 1 to 4, Δ_{ACK} , Δ_{NACK} and $\Delta_{CQI} = 30/15$ with $\beta_{hs} = 30/15 * \beta_c$. For sub-test 5, Δ_{ACK} , Δ_{NACK} and $\Delta_{CQI} = 5/15$ with $\beta_{hs} = 5/15 * \beta_c$.

Note 2: CM = 1 for $\beta_c/\beta_d = 12/15$, $\beta_{hs}/\beta_c = 24/15$. For all other combinations of DPDCH, DPCCH, HS- DPCCH, E-DPDCH and E-DPCCH the MPR is based on the relative CM difference.

Note 3: For subtest 1 the β_c/β_d ratio of 11/15 for the TFC during the measurement period (TF1, TF0) is achieved by setting the signalled gain factors for the reference TFC (TF1, TF0) to $\beta_c = 10/15$ and $\beta_d = 15/15$.

Note 4: In case of testing by UE using E-DPDCH Physical Layer category 1, Sub-test 3 is omitted according to TS25.306 Table 5.1g.

Note 5: β_{ed} can not be set directly; it is set by Absolute Grant Value.

Note 6: For subtests 2, 3 and 4, UE may perform E-DPDCH power scaling at max power which could results in slightly smaller MPR values.

Setup Configuration

DC-HSDPA 3GPP release 8 Setup Configuration:

- a. The EUT was connected to Base Station referred to the Setup Configuration below
- b. The RF path losses were compensated into the measurements.
- c. A call was established between EUT and Base Station with following setting:
 - i. Set RMC 12.2Kbps + HSDPA mode.
 - ii. Set Cell Power = -25 dBm
 - iii. Set HS-DSCH Configuration Type to FRC (H-set 12, QPSK)
 - iv. Select HSDPA Uplink Parameters
 - v. Set Gain Factors (β_c and β_d) and parameters were set according to each Specific sub-test in the following table, C10.1.4, quoted from the TS 34.121
 - a). Subtest 1: $\beta_c/\beta_d=2/15$
 - b). Subtest 2: $\beta_c/\beta_d=12/15$
 - c). Subtest 3: $\beta_c/\beta_d=15/8$
 - d). Subtest 4: $\beta_c/\beta_d=15/4$
 - vi. Set Delta ACK, Delta NACK and Delta CQI = 8
 - vii. Set Ack-Nack Repetition Factor to 3
 - viii. Set CQI Feedback Cycle (k) to 4 ms
 - ix. Set CQI Repetition Factor to 2
 - x. Power Ctrl Mode = All Up bits
- d. The transmitted maximum output power was recorded.

The following tests were conducted according to the test requirements outlines in 3GPP TS 34.121 specification. A summary of these settings are illustrated below:

C.8.1.12 Fixed Reference Channel Definition H-Set 12

Table C.8.1.12: Fixed Reference Channel H-Set 12

Parameter	Unit	Value
Nominal Avg. Inf. Bit Rate	kbps	60
Inter-TTI Distance	TTI's	1
Number of HARQ Processes	Processes	6
Information Bit Payload (N_{INF})	Bits	120
Number Code Blocks	Blocks	1
Binary Channel Bits Per TTI	Bits	960
Total Available SML's in UE	SML's	19200
Number of SML's per HARQ Proc.	SML's	3200
Coding Rate		0.15
Number of Physical Channel Codes	Codes	1
Modulation		QPSK
Note 1: The RMC is intended to be used for DC-HSDPA mode and both cells shall transmit with identical parameters as listed in the table. Note 2: Maximum number of transmission is limited to 1, i.e., retransmission is not allowed. The redundancy and constellation version 0 shall be used.		

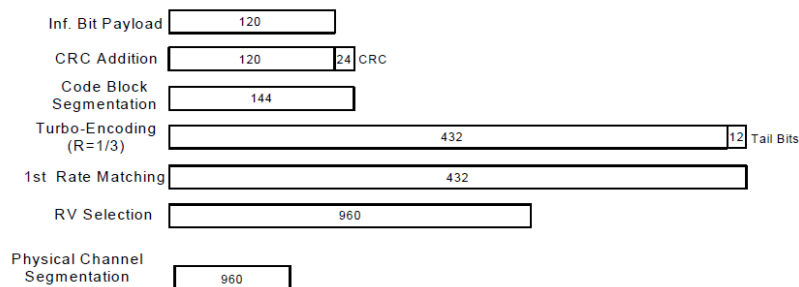

Figure C.8.19: Coding rate for Fixed reference Channel H-Set 12 (QPSK)

Setup Configuration



<WCDMA Conducted Power>

General Note:

1. Per KDB 941225 D01v03r01, for SAR testing is measured using a 12.2 kbps RMC with TPC bits configured to all "1's".
2. Per KDB 941225 D01v03r01, RMC 12.2kbps setting is used to evaluate SAR. The maximum output power and tune-up tolerance specified for production units in HSDPA / HSUPA / DC-HSDPA is $\leq \frac{1}{4}$ dB higher than RMC 12.2Kbps or when the highest reported SAR of the RMC12.2Kbps is scaled by the ratio of specified maximum output power and tune-up tolerance of HSDPA / HSUPA / DC-HSDPA to RMC12.2Kbps and the adjusted SAR is ≤ 1.2 W/kg, SAR measurement is not required for HSDPA / HSUPA / DC-HSDPA, and according to the following RF output power, the output power results of the secondary modes (HSDPA / HSUPA / DC-HSDPA) are less than $\frac{1}{4}$ dB higher than the primary modes; therefore, SAR measurement is not required for HSDPA / HSUPA / DC-HSDPA

<LTE Conducted Power>

General Note:

1. Anritsu MT8820C base station simulator was used to setup the connection with EUT; the frequency band, channel bandwidth, RB allocation configuration, modulation type are set in the base station simulator to configure EUT transmitting at maximum power and at different configurations which are requested to be reported to FCC, for conducted power measurement and SAR testing.
2. Per KDB 941225 D05v02r05, when a properly configured base station simulator is used for the SAR and power measurements, spectrum plots for each RB allocation and offset configuration is not required.
3. Per KDB 941225 D05v02r05, start with the largest channel bandwidth and measure SAR for QPSK with 1 RB allocation, using the RB offset and required test channel combination with the highest maximum output power for RB offsets at the upper edge, middle and lower edge of each required test channel.
4. Per KDB 941225 D05v02r05, 50% RB allocation for QPSK SAR testing follows 1RB QPSK allocation procedure.
5. Per KDB 941225 D05v02r05, for QPSK with 100% RB allocation, SAR is not required when the highest maximum output power for 100 % RB allocation is less than the highest maximum output power in 50% and 1 RB allocations and the highest reported SAR for 1 RB and 50% RB allocation are ≤ 0.8 W/kg. Otherwise, SAR is measured for the highest output power channel; and if the reported SAR is > 1.45 W/kg, the remaining required test channels must also be tested.
6. Per KDB 941225 D05v02r05, 16QAM/64QAM output power for each RB allocation configuration is $>$ not $\frac{1}{2}$ dB higher than the same configuration in QPSK and the reported SAR for the QPSK configuration is ≤ 1.45 W/kg; Per KDB 941225 D05v02r05, 16QAM/64QAM SAR testing is not required.
7. Per KDB 941225 D05v02r05, smaller bandwidth output power for each RB allocation configuration is $>$ not $\frac{1}{2}$ dB higher than the same configuration in the largest supported bandwidth, and the reported SAR for the largest supported bandwidth is ≤ 1.45 W/kg; Per KDB 941225 D05v02r05, smaller bandwidth SAR testing is not required.
8. For LTE B5 / B26 / B38 the maximum bandwidth does not support three non-overlapping channels, per KDB 941225 D05v02r05, when a device supports overlapping channel assignment in a channel bandwidth configuration, the middle channel of the group of overlapping channels should be selected for testing.
9. LTE B5/B38 SAR test was covered by B26/B41; according to April 2015 TCB workshop, SAR test for overlapping LTE bands can be reduced if
 - a. the maximum output power, including tolerance, for the smaller band is \leq the larger band to qualify for the SAR test exclusion
 - b. the channel bandwidth and other operating parameters for the smaller band are fully supported by the larger band
10. According to 2017 TCB workshop, for 64 QAM and 16 QAM should be verified by checking the signal constellation with a call box to avoid incorrect maximum power levels due to MPR and other requirements associated with signal modulation, and the following figure is taken from the "Fundamental Measurement >> Modulation Analysis >> constellation" mode of the device connect to the MT8821C base station, therefore, the device 64QAM and 16QAM signal modulation are correct.

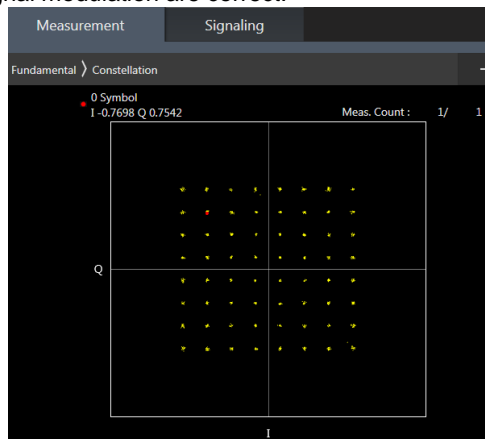

64QAM

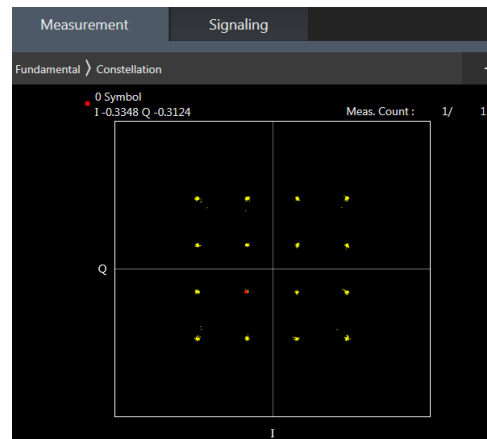

16QAM

<TDD LTE SAR Measurement>

TDD LTE configuration setup for SAR measurement

SAR was tested with a fixed periodic duty factor according to the highest transmission duty factor implemented for the device and supported by 3GPP.

- a. 3GPP TS 36.211 section 4.2 for Type 2 Frame Structure and Table 4.2-2 for uplink-downlink configurations
- b. "special subframe S" contains both uplink and downlink transmissions, it has been taken into consideration to determine the transmission duty factor according to the worst case uplink and downlink cyclic prefix requirements for UpPTS
- c. Establishing connections with base station simulators ensure a consistent means for testing SAR and recommended for evaluating SAR. The Anritsu MT8820C (firmware: #22.52#004) was used for LTE output power measurements and SAR testing.

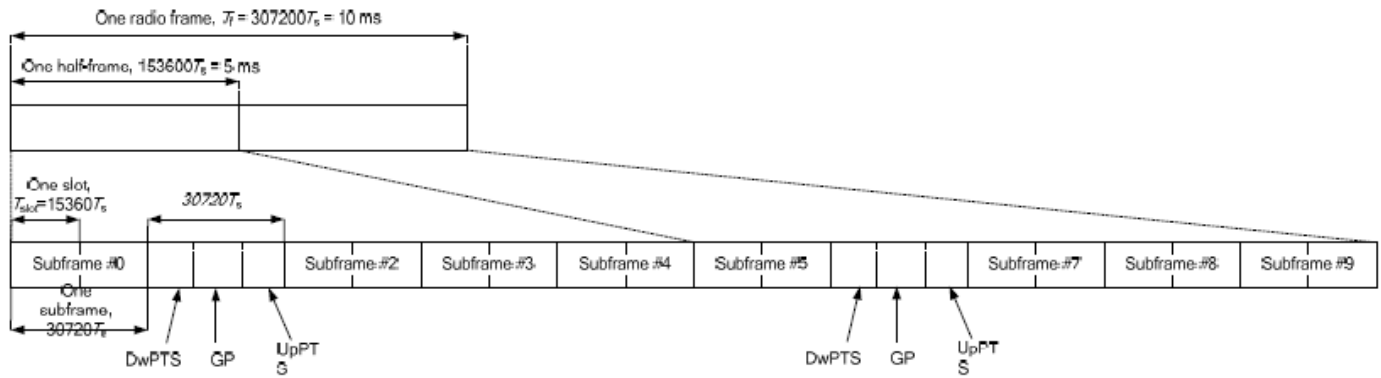

Figure 4.2-1: Frame structure type 2 (for 5 ms switch-point periodicity).

Table 4.2-2: Uplink-downlink configurations.

Uplink-downlink configuration	Downlink-to-Uplink Switch-point periodicity	Subframe number									
		0	1	2	3	4	5	6	7	8	9
0	5 ms	D	S	U	U	U	D	S	U	U	U
1	5 ms	D	S	U	U	D	D	S	U	U	D
2	5 ms	D	S	U	D	D	D	S	U	D	D
3	10 ms	D	S	U	U	U	D	D	D	D	D
4	10 ms	D	S	U	U	D	D	D	D	D	D
5	10 ms	D	S	U	D	D	D	D	D	D	D
6	5 ms	D	S	U	U	U	D	S	U	U	D

Table 4.2-1: Configuration of special subframe (lengths of DwPTS/GP/UpPTS).

Special subframe configuration	Normal cyclic prefix in downlink			Extended cyclic prefix in downlink		
	DwPTS	UpPTS		DwPTS	UpPTS	
		Normal cyclic prefix in uplink	Extended cyclic prefix in uplink		Normal cyclic prefix in uplink	Extended cyclic prefix in uplink
0	$6592 \cdot T_s$	$2192 \cdot T_s$	$2560 \cdot T_s$	$7680 \cdot T_s$	$2192 \cdot T_s$	$2560 \cdot T_s$
1	$19760 \cdot T_s$			$20480 \cdot T_s$		
2	$21952 \cdot T_s$			$23040 \cdot T_s$		
3	$24144 \cdot T_s$			$25600 \cdot T_s$		
4	$26336 \cdot T_s$	$4384 \cdot T_s$	$5120 \cdot T_s$	$7680 \cdot T_s$	$4384 \cdot T_s$	$5120 \cdot T_s$
5	$6592 \cdot T_s$			$20480 \cdot T_s$		
6	$19760 \cdot T_s$			$23040 \cdot T_s$		
7	$21952 \cdot T_s$			$12800 \cdot T_s$		
8	$24144 \cdot T_s$	-	-	-	-	-
9	$13168 \cdot T_s$	-	-	-	-	-

Special subframe (30720·T_s): Normal cyclic prefix in downlink (UpPTS)			
	Special subframe configuration	Normal cyclic prefix in uplink	Extended cyclic prefix in uplink
Uplink duty factor in one special subframe	0~4	7.13%	8.33%
	5~9	14.3%	16.7%

Special subframe(30720·T_s): Extended cyclic prefix in downlink (UpPTS)			
	Special subframe configuration	Normal cyclic prefix in uplink	Extended cyclic prefix in uplink
Uplink duty factor in one special subframe	0~3	7.13%	8.33%
	4~7	14.3%	16.7%

The highest duty factor is resulted from:

For LTE Band 41 Power class 3

- i. Uplink-downlink configuration: 0. In a half-frame consisted of 5 subframes, uplink operation is in 3 uplink subframes and 1 special subframe.
- ii. special subframe configuration: 5-9 for normal cyclic prefix in downlink, 4-7 for extended cyclic prefix in downlink
- iii. for special subframe with extended cyclic prefix in uplink, the total uplink duty factor in one half-frame is: $(3+0.167)/5 = 63.3\%$
- iv. for special subframe with normal cyclic prefix in uplink, the total uplink duty factor in one half-frame is: $(3+0.143)/5 = 62.9\%$
- v. For TDD LTE SAR measurement, the duty cycle 1:1.59 (62.9 %) was used perform testing and considering the theoretical duty cycle of 63.3% for extended cyclic prefix in the uplink, and the theoretical duty cycle of 62.9% for normal cyclic prefix in uplink, a scaling factor of extended cyclic prefix $63.3\%/62.9\% = 1.006$ is applied to scale-up the measured SAR result. The scaled TDD LTE SAR = measured SAR (W/kg)* Tune-up Scaling Factor* scaling factor for extended cyclic prefix.

<WLAN Conducted Power>

General Note:

1. Per KDB 248227 D01v02r02, SAR test reduction is determined according to 802.11 transmission mode configurations and certain exposure conditions with multiple test positions. In the 2.4 GHz band, separate SAR procedures are applied to DSSS and OFDM configurations to simplify DSSS test requirements. For OFDM, in both 2.4 and 5 GHz bands, an initial test configuration must be determined for each standalone and aggregated frequency band, according to the transmission mode configuration with the highest maximum output power specified for production units to perform SAR measurements. If the same highest maximum output power applies to different combinations of channel bandwidths, modulations and data rates, additional procedures are applied to determine which test configurations require SAR measurement. When applicable, an initial test position may be applied to reduce the number of SAR measurements required for next to the ear, UMPC mini-tablet or hotspot mode configurations with multiple test positions.
2. For 2.4 GHz 802.11b DSSS, either the initial test position procedure for multiple exposure test positions or the DSSS procedure for fixed exposure position is applied; these are mutually exclusive. For 2.4 GHz and 5 GHz OFDM configurations, the initial test configuration is applied to measure SAR using either the initial test position procedure for multiple exposure test position configurations or the initial test configuration procedures for fixed exposure test conditions. Based on the reported SAR of the measured configurations and maximum output power of the transmission mode configurations that are not included in the initial test configuration, the subsequent test configuration and initial test position procedures are applied to determine if SAR measurements are required for the remaining OFDM transmission configurations. In general, the number of test channels that require SAR measurement is minimized based on maximum output power measured for the test sample(s).
3. For OFDM transmission configurations in the 2.4 GHz and 5 GHz bands, When the same maximum power is specified for multiple transmission modes in a frequency band, the largest channel bandwidth, lowest order modulation, lowest data rate and lowest order 802.11a/g/n/ac mode is used for SAR measurement, on the highest measured output power channel for each frequency band.
4. DSSS and OFDM configurations are considered separately according to the required SAR procedures. SAR is measured in the initial test position using the 802.11 transmission mode configuration required by the DSSS procedure or initial test configuration and subsequent test configuration(s) according to the OFDM procedures.18 The initial test position procedure is described in the following:
 - a. When the reported SAR of the initial test position is ≤ 0.4 W/kg, further SAR measurement is not required for the other test positions in that exposure configuration and 802.11 transmission mode combinations within the frequency band or aggregated band.
 - b. When the reported SAR of the test position is > 0.4 W/kg, SAR is repeated for the 802.11 transmission mode configuration tested in the initial test position to measure the subsequent next closet/smallest test separation distance and maximum coupling test position on the highest maximum output power channel, until the report SAR is ≤ 0.8 W/kg or all required test position are tested.
 - c. For all positions/configurations, when the reported SAR is > 0.8 W/kg, SAR is measured for these test positions/configurations on the subsequent next highest measured output power channel(s) until the reported SAR is ≤ 1.2 W/kg or all required channels are tested.

<2.4GHz Bluetooth>

General Note:

1. For 2.4GHz Bluetooth SAR testing was selected 1Mbps, due to its highest average power.
2. The Bluetooth duty cycle is 77.67 % as following figure, according to 2016 Oct. TCB workshop for Bluetooth SAR scaling need further consideration and the maximum duty cycle is 100%, therefore the actual duty cycle will be scaled up to 100% for Bluetooth reported SAR calculation

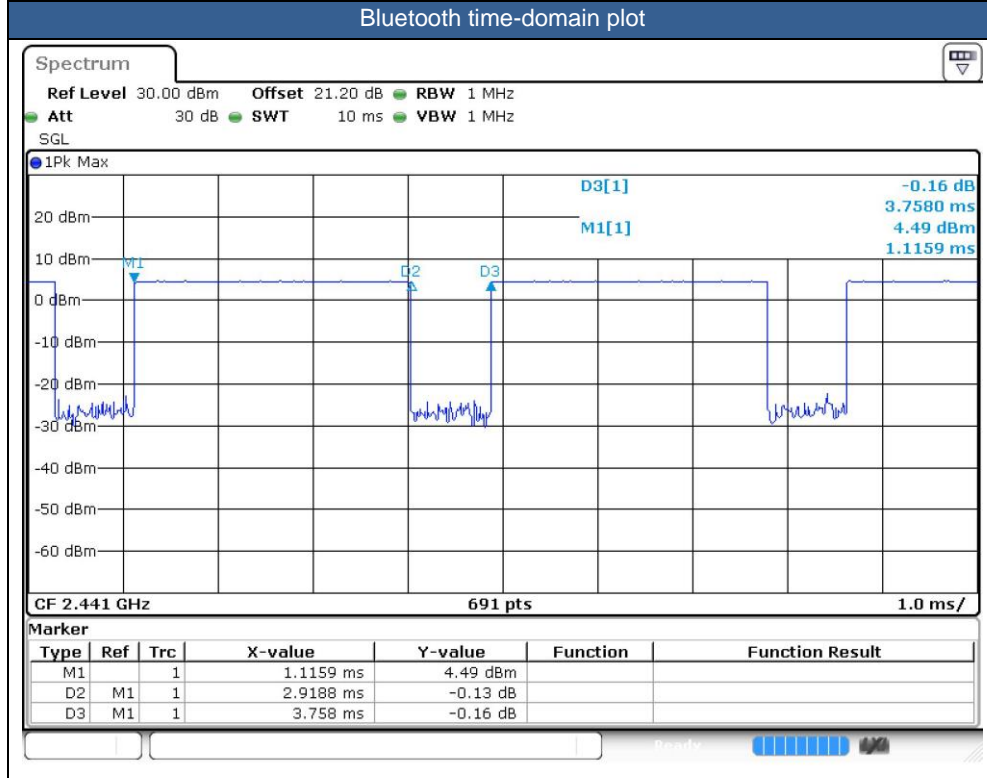



15. Antenna Location

The detailed antenna location information can refer to SAR Test Setup Photos.

16. SAR Test Results

General Note:

1. Per KDB 447498 D01v06, the reported SAR is the measured SAR value adjusted for maximum tune-up tolerance.
 - a. Tune-up scaling Factor = tune-up limit power (mW) / EUT RF power (mW), where tune-up limit is the maximum rated power among all production units.
 - b. For SAR testing of WLAN/Bluetooth signal with non-100% duty cycle, the measured SAR is scaled-up by the duty cycle scaling factor which is equal to "1/(duty cycle)"
 - c. For WWAN: Reported SAR(W/kg)= Measured SAR(W/kg)*Tune-up Scaling Factor
 - d. For BT/WLAN: Reported SAR(W/kg)= Measured SAR(W/kg)* Duty Cycle scaling factor * Tune-up scaling factor
 - e. For TDD LTE SAR measurement, the duty cycle 1:1.59 (62.9 %) was used perform testing and considering the theoretical duty cycle of 63.3% for extended cyclic prefix in the uplink, and the theoretical duty cycle of 62.9% for normal cyclic prefix in uplink, a scaling factor of extended cyclic prefix $63.3\%/62.9\% = 1.006$ is applied to scale-up the measured SAR result. The Reported TDD LTE SAR = measured SAR (W/kg)* Tune-up Scaling Factor* scaling factor for extended cyclic prefix.
2. Per KDB 447498 D01v06, for each exposure position, testing of other required channels within the operating mode of a frequency band is not required when the *reported* 1-g or 10-g SAR for the mid-band or highest output power channel is:
 - ≤ 0.8 W/kg or 2.0 W/kg, for 1-g or 10-g respectively, when the transmission band is ≤ 100 MHz
 - ≤ 0.6 W/kg or 1.5 W/kg, for 1-g or 10-g respectively, when the transmission band is between 100 MHz and 200 MHz
 - ≤ 0.4 W/kg or 1.0 W/kg, for 1-g or 10-g respectively, when the transmission band is ≥ 200 MHz
3. Per KDB 865664 D01v01r04, for each frequency band, repeated SAR measurement is required when the measured SAR is ≥ 0.8 W/kg. Per KDB 865664 D01v01r04, if the extremity repeated SAR is necessary, the same procedures should be adapted for measurements according to extremity and occupational exposure limits by applying a factor of 2.5 for extremity exposure and a factor of 5 for occupational exposure to the corresponding SAR thresholds.
4. Pre KDB648474 D04v01r03, when the reported SAR for a body-worn accessory, measured without a headset connected to the handset, is > 1.2 W/kg, the highest reported SAR configuration for that wireless mode and frequency band should be repeated for that body-worn accessory with a headset attached to the handset. When headset SAR is less than or equal than without headset SAR, no need to verify the remaining channels for headset SAR.
5. The device implements Proximity sensors/receiver detect mechanism/hotspot trigger reduced power for the power management for SAR compliance at different exposure conditions (head, body-worn, hotspot, extremity).
6. The device will invoke corresponding work scenarios power level, which are provided in the operational description.
7. For Some WWAN bands, sensor on reduced power level higher than hotspot reduced power level, so front/back sensor on SAR can represent hotspot conservatively.
8. The following table "n/a" means the measured SAR is too small to find the 10g cube SAR.
9. Per KDB648474 D04v01r03, for smart phones with a display diagonal dimension > 15.0 cm or an overall diagonal dimension > 16.0 cm, when hotspot mode applies, 10-g extremity SAR is required only for the surfaces and edges with hotspot mode 1-g reported SAR > 1.2 W/kg, however, when power reduction applies to hotspot mode the measured SAR must be scaled to the maximum output power (for handheld on state, the maximum full power means reduced power), including tolerance, allowed for phablet modes to compare with the 1.2 W/kg SAR test reduction threshold.
 - a. For this device SAR for WWAN/WLAN transmitter scaled to maximum output power mode for product specific 10g SAR is higher than 1.2 W/kg of GSM850/1900, WCDMA Band II/V, LTE Band 2/5/7/26/38/41 and WLAN 5.2/5.8GHz therefore product specific 10g SAR is necessary.
 - b. WLAN 5.3/5.5GHz tested the product specific 10g SAR since it has no hotspot mode.
 - c. When 10-g product specific 10g SAR is considered, SAR thresholds is specified in the procedures for SAR test reduction and exclusion should be multiplied by 2.5.
10. The device has five headsets, only supplier is different, so we chose headset 1 to perform full SAR testing, and headset 2/3/4/5 only verified the worst case of headset 1.
11. For verification of compliance of power reduction scheme, additional SAR testing with EUT transmitting at full RF power at a conservative trigger distance was performed for body worn:
Front: [14 mm](#)
Back: [21 mm](#)
12. For verification of compliance of power reduction scheme, additional SAR testing with EUT transmitting at full RF power at a conservative trigger distance was performed for handheld:
Front: [8 mm](#)
Back: [18 mm](#)
Bottom side: [14 mm](#)

GSM Note:

1. Per KDB 941225 D01v03r01, for SAR test reduction for GSM / GPRS / EDGE modes is determined by the source-based time-averaged output power including tune-up tolerance. The mode with highest specified time-averaged output power should be tested for SAR compliance in the applicable exposure conditions. For modes with the same specified maximum output power and tolerance, the higher number time-slot configuration should be tested. Therefore, the GPRS 2Tx slots for GSM850/GSM1900 are considered as the primary mode.
2. Other configurations of GSM / GPRS / EDGE are considered as secondary modes. The 3G SAR test reduction procedure is applied, when the maximum output power and tune-up tolerance specified for production units in a secondary mode is \leq ¼ dB higher than the primary mode, SAR measurement is not required for the secondary mode.

WCDMA Note:

1. Per KDB 941225 D01v03r01, for SAR testing is measured using a 12.2 kbps RMC with TPC bits configured to all "1's".
2. Per KDB 941225 D01v03r01, RMC 12.2kbps setting is used to evaluate SAR. The maximum output power and tune-up tolerance specified for production units in HSDPA / HSUPA / DC-HSDPA is \leq ¼ dB higher than RMC 12.2Kbps or when the highest reported SAR of the RMC12.2Kbps is scaled by the ratio of specified maximum output power and tune-up tolerance of HSDPA / HSUPA / DC-HSDPA to RMC12.2Kbps and the adjusted SAR is \leq 1.2 W/kg, SAR measurement is not required for HSDPA / HSUPA / DC-HSDPA, and according to the following RF output power, the output power results of the secondary modes (HSDPA / HSUPA / DC-HSDPA) are less than ¼ dB higher than the primary modes; therefore, SAR measurement is not required for HSDPA / HSUPA / DC-HSDPA.

LTE Note:

1. Per KDB 941225 D05v02r05, start with the largest channel bandwidth and measure SAR for QPSK with 1 RB allocation, using the RB offset and required test channel combination with the highest maximum output power for RB offsets at the upper edge, middle and lower edge of each required test channel.
2. Per KDB 941225 D05v02r05, 50% RB allocation for QPSK SAR testing follows 1RB QPSK allocation procedure.
3. Per KDB 941225 D05v02r05, for QPSK with 100% RB allocation, SAR is not required when the highest maximum output power for 100 % RB allocation is less than the highest maximum output power in 50% and 1 RB allocations and the highest reported SAR for 1 RB and 50% RB allocation are \leq 0.8 W/kg. Otherwise, SAR is measured for the highest output power channel; and if the reported SAR is $>$ 1.45 W/kg, the remaining required test channels must also be tested.
4. Per KDB 941225 D05v02r05, 16QAM/64QAM output power for each RB allocation configuration is $>$ not ½ dB higher than the same configuration in QPSK and the reported SAR for the QPSK configuration is \leq 1.45 W/kg; Per KDB 941225 D05v02r05, 16QAM/64QAM SAR testing is not required.
5. Per KDB 941225 D05v02r05, smaller bandwidth output power for each RB allocation configuration is $>$ not ½ dB higher than the same configuration in the largest supported bandwidth, and the reported SAR for the largest supported bandwidth is \leq 1.45 W/kg; Per KDB 941225 D05v02r05, smaller bandwidth SAR testing is not required.
6. For LTE B5 / B26 / B38 the maximum bandwidth does not support three non-overlapping channels, per KDB 941225 D05v02r05, when a device supports overlapping channel assignment in a channel bandwidth configuration, the middle channel of the group of overlapping channels should be selected for testing.
7. LTE B5 / B38 SAR test was covered by LTE B26 / B41; according to April 2015 TCB workshop, SAR test for overlapping LTE bands can be reduced if
 - a. the maximum output power, including tolerance, for the smaller band is \leq the larger band to qualify for the SAR test exclusion
 - b. the channel bandwidth and other operating parameters for the smaller band are fully supported by the larger band



WLAN Note:

1. Per KDB 248227 D01v02r02, for 2.4GHz 802.11g/n SAR testing is not required when the highest reported SAR for DSSS is adjusted by the ratio of OFDM to DSSS specified maximum output power and the adjusted SAR is ≤ 1.2 W/kg.
2. Per KDB 248227 D01v02r02, U-NII-1 SAR testing is not required when the U-NII-2A band highest reported SAR for a test configuration is ≤ 1.2 W/kg, SAR is not required for U-NII-1 band.
3. When the reported SAR of the test position is > 0.4 W/kg, SAR is repeated for the 802.11 transmission mode configuration tested in the initial test position to measure the subsequent next closet/smallest test separation distance and maximum coupling test position on the highest maximum output power channel, until the report SAR is ≤ 0.8 W/kg or all required test position are tested.
4. For all positions / configurations, when the reported SAR is > 0.8 W/kg, SAR is measured for these test positions / configurations on the subsequent next highest measured output power channel(s) until the reported SAR is ≤ 1.2 W/kg or all required channels are tested.
5. During SAR testing the WLAN transmission was verified using a spectrum analyzer.



16.1 Head SAR

<GSM SAR>

Plot No.	Band	Mode	Test Position	Power Reduction	Ch.	Freq. (MHz)	Average Power (dBm)	Tune-Up Limit (dBm)	Tune-up Scaling Factor	Power Drift (dB)	Measured 1g SAR (W/kg)	Reported 1g SAR (W/kg)
01	GSM850	GPRS(2 Tx slots)	Right Cheek	Full	189	836.4	31.19	32.00	1.205	-0.17	0.472	0.569
	GSM850	GPRS(2 Tx slots)	Right Tilted	Full	189	836.4	31.19	32.00	1.205	-0.02	0.248	0.299
	GSM850	GPRS(2 Tx slots)	Left Cheek	Full	189	836.4	31.19	32.00	1.205	-0.07	0.433	0.522
	GSM850	GPRS(2 Tx slots)	Left Tilted	Full	189	836.4	31.19	32.00	1.205	-0.03	0.245	0.295
	GSM1900	GPRS(2 Tx slots)	Right Cheek	Full	661	1880	27.84	29.50	1.466	0.03	0.130	0.191
	GSM1900	GPRS(2 Tx slots)	Right Tilted	Full	661	1880	27.84	29.50	1.466	0.18	0.112	0.164
02	GSM1900	GPRS(2 Tx slots)	Left Cheek	Full	661	1880	27.84	29.50	1.466	-0.12	0.200	0.293
	GSM1900	GPRS(2 Tx slots)	Left Tilted	Full	661	1880	27.84	29.50	1.466	-0.05	0.133	0.195

<WCDMA SAR>

Plot No.	Band	Mode	Test Position	Power Reduction	Ch.	Freq. (MHz)	Average Power (dBm)	Tune-Up Limit (dBm)	Tune-up Scaling Factor	Power Drift (dB)	Measured 1g SAR (W/kg)	Reported 1g SAR (W/kg)
03	WCDMA V	RMC 12.2Kbps	Right Cheek	Full	4132	826.4	23.64	24.00	1.086	0.18	0.288	0.313
	WCDMA V	RMC 12.2Kbps	Right Tilted	Full	4132	826.4	23.64	24.00	1.086	-0.03	0.198	0.215
	WCDMA V	RMC 12.2Kbps	Left Cheek	Full	4132	826.4	23.64	24.00	1.086	0.07	0.273	0.297
	WCDMA V	RMC 12.2Kbps	Left Tilted	Full	4132	826.4	23.64	24.00	1.086	0.08	0.160	0.174
	WCDMA II	RMC 12.2Kbps	Right Cheek	Full	9538	1907.6	23.37	24.00	1.156	0.14	0.168	0.194
	WCDMA II	RMC 12.2Kbps	Right Tilted	Full	9538	1907.6	23.37	24.00	1.156	-0.12	0.123	0.142
04	WCDMA II	RMC 12.2Kbps	Left Cheek	Full	9538	1907.6	23.37	24.00	1.156	-0.18	0.301	0.348
	WCDMA II	RMC 12.2Kbps	Left Tilted	Full	9538	1907.6	23.37	24.00	1.156	-0.17	0.172	0.199



<FDD LTE SAR>

Plot No.	Band	BW (MHz)	Modulation	RB Size	RB offset	Test Position	Power Reduction	Ch.	Freq. (MHz)	Average Power (dBm)	Tune-Up Limit (dBm)	Tune-up Scaling Factor	Power Drift (dB)	Measured 1g SAR (W/kg)	Reported 1g SAR (W/kg)
05	LTE Band 26	15M	QPSK	1	0	Right Cheek	Full	26865	831.5	23.25	24.00	1.189	-0.07	0.400	0.475
	LTE Band 26	15M	QPSK	1	0	Right Tilted	Full	26865	831.5	23.25	24.00	1.189	-0.12	0.188	0.223
	LTE Band 26	15M	QPSK	1	0	Left Cheek	Full	26865	831.5	23.25	24.00	1.189	0.11	0.298	0.354
	LTE Band 26	15M	QPSK	1	0	Left Tilted	Full	26865	831.5	23.25	24.00	1.189	0.08	0.194	0.231
	LTE Band 26	15M	QPSK	36	20	Right Cheek	Full	26865	831.5	22.80	23.00	1.047	0.03	0.290	0.304
	LTE Band 26	15M	QPSK	36	20	Right Tilted	Full	26865	831.5	22.80	23.00	1.047	0.05	0.171	0.179
	LTE Band 26	15M	QPSK	36	20	Left Cheek	Full	26865	831.5	22.80	23.00	1.047	-0.18	0.261	0.273
	LTE Band 26	15M	QPSK	36	20	Left Tilted	Full	26865	831.5	22.80	23.00	1.047	0.05	0.169	0.177
	LTE Band 2	20M	QPSK	1	0	Right Cheek	Full	18900	1880	22.98	24.00	1.265	0.09	0.329	0.416
	LTE Band 2	20M	QPSK	1	0	Right Tilted	Full	18900	1880	22.98	24.00	1.265	0.08	0.220	0.278
06	LTE Band 2	20M	QPSK	1	0	Left Cheek	Full	18900	1880	22.98	24.00	1.265	0.14	0.357	0.452
	LTE Band 2	20M	QPSK	1	0	Left Tilted	Full	18900	1880	22.98	24.00	1.265	-0.08	0.308	0.390
	LTE Band 2	20M	QPSK	50	0	Right Cheek	Full	18900	1880	22.37	23.00	1.156	0.16	0.255	0.295
	LTE Band 2	20M	QPSK	50	0	Right Tilted	Full	18900	1880	22.37	23.00	1.156	0.05	0.194	0.224
	LTE Band 2	20M	QPSK	50	0	Left Cheek	Full	18900	1880	22.37	23.00	1.156	-0.03	0.285	0.329
	LTE Band 2	20M	QPSK	50	0	Left Tilted	Full	18900	1880	22.37	23.00	1.156	0.12	0.246	0.284
	LTE Band 7	20M	QPSK	1	99	Right Cheek	Full	21350	2560	22.99	24.00	1.262	0.15	0.046	0.058
	LTE Band 7	20M	QPSK	1	99	Right Tilted	Full	21350	2560	22.99	24.00	1.262	0.15	0.019	0.024
07	LTE Band 7	20M	QPSK	1	99	Left Cheek	Full	21350	2560	22.99	24.00	1.262	0.11	0.109	0.138
	LTE Band 7	20M	QPSK	1	99	Left Tilted	Full	21350	2560	22.99	24.00	1.262	-0.14	0.039	0.049
	LTE Band 7	20M	QPSK	50	50	Right Cheek	Full	21350	2560	22.54	23.00	1.112	0.19	0.043	0.048
	LTE Band 7	20M	QPSK	50	50	Right Tilted	Full	21350	2560	22.54	23.00	1.112	-0.01	0.018	0.020
	LTE Band 7	20M	QPSK	50	50	Left Cheek	Full	21350	2560	22.54	23.00	1.112	0.13	0.088	0.098
	LTE Band 7	20M	QPSK	50	50	Left Tilted	Full	21350	2560	22.54	23.00	1.112	-0.08	0.048	0.053

<TDD LTE SAR>

Plot No.	Band	BW (MHz)	Modulation	RB Size	RB offset	Test Position	Power Reduction	Ch.	Freq. (MHz)	Average Power (dBm)	Tune-Up Limit (dBm)	Tune-up Scaling Factor	Duty Cycle %	Duty Cycle Scaling Factor	Power Drift (dB)	Measured 1g SAR (W/kg)	Reported 1g SAR (W/kg)
	LTE Band 41	20M	QPSK	1	99	Right Cheek	Full	41490	2680	22.77	24.00	1.327	62.9	1.006	-0.1	0.030	0.040
	LTE Band 41	20M	QPSK	1	99	Right Tilted	Full	41490	2680	22.77	24.00	1.327	62.9	1.006	0.14	0.022	0.029
	LTE Band 41	20M	QPSK	1	99	Left Cheek	Full	41490	2680	22.77	24.00	1.327	62.9	1.006	0.01	0.051	0.068
	LTE Band 41	20M	QPSK	1	99	Left Tilted	Full	41490	2680	22.77	24.00	1.327	62.9	1.006	-0.05	0.010	0.014
	LTE Band 41	20M	QPSK	50	50	Right Cheek	Full	41490	2680	22.75	24.00	1.334	62.9	1.006	0.08	0.030	0.041
	LTE Band 41	20M	QPSK	50	50	Right Tilted	Full	41490	2680	22.75	24.00	1.334	62.9	1.006	0.07	0.025	0.034
08	LTE Band 41	20M	QPSK	50	50	Left Cheek	Full	41490	2680	22.75	24.00	1.334	62.9	1.006	0.01	0.051	0.069
	LTE Band 41	20M	QPSK	50	50	Left Tilted	Full	41490	2680	22.75	24.00	1.334	62.9	1.006	0.04	0.025	0.034



<WLAN2.4G SAR>

Plot No.	Band	Mode	Test Position	Power Reduction	Ch.	Freq. (MHz)	Average Power (dBm)	Tune-Up Limit (dBm)	Tune-up Scaling Factor	Duty Cycle %	Duty Cycle Scaling Factor	Power Drift (dB)	Measured 1g SAR (W/kg)	Reported 1g SAR (W/kg)
	WLAN2.4GHz	802.11b 1Mbps	Right Cheek	Reduced	1	2412	17.10	17.50	1.096	98.6	1.014	-0.18	0.244	0.271
	WLAN2.4GHz	802.11b 1Mbps	Right Tilted	Reduced	1	2412	17.10	17.50	1.096	98.6	1.014	0.03	0.274	0.305
	WLAN2.4GHz	802.11b 1Mbps	Left Cheek	Reduced	1	2412	17.10	17.50	1.096	98.6	1.014	-0.05	0.721	0.802
	WLAN2.4GHz	802.11b 1Mbps	Left Tilted	Reduced	1	2412	17.10	17.50	1.096	98.6	1.014	0.12	0.456	0.507
09	WLAN2.4GHz	802.11b 1Mbps	Left Cheek	Reduced	11	2462	17.00	17.50	1.122	98.6	1.014	-0.02	0.825	0.939

<WLAN5G SAR>

Plot No.	Band	Mode	Test Position	Power Reduction	Ch.	Freq. (MHz)	Average Power (dBm)	Tune-Up Limit (dBm)	Tune-up Scaling Factor	Duty Cycle %	Duty Cycle Scaling Factor	Power Drift (dB)	Measured 1g SAR (W/kg)	Reported 1g SAR (W/kg)
	WLAN5.3GHz	802.11a 6Mbps	Right Cheek	Reduced	52	5260	15.02	16.00	1.253	91.12	1.097	-0.07	0.570	0.784
	WLAN5.3GHz	802.11a 6Mbps	Right Tilted	Reduced	52	5260	15.02	16.00	1.253	91.12	1.097	0.05	0.596	0.819
10	WLAN5.3GHz	802.11a 6Mbps	Left Cheek	Reduced	52	5260	15.02	16.00	1.253	91.12	1.097	-0.17	0.783	1.076
	WLAN5.3GHz	802.11a 6Mbps	Left Tilted	Reduced	52	5260	15.02	16.00	1.253	91.12	1.097	0.08	0.727	0.999
	WLAN5.3GHz	802.11a 6Mbps	Right Cheek	Reduced	60	5300	14.60	16.00	1.380	91.12	1.097	0.02	0.600	0.909
	WLAN5.3GHz	802.11a 6Mbps	Right Tilted	Reduced	60	5300	14.60	16.00	1.380	91.12	1.097	-0.16	0.614	0.930
	WLAN5.3GHz	802.11a 6Mbps	Left Cheek	Reduced	60	5300	14.60	16.00	1.380	91.12	1.097	-0.09	0.685	1.037
	WLAN5.3GHz	802.11a 6Mbps	Left Tilted	Reduced	60	5300	14.60	16.00	1.380	91.12	1.097	0.01	0.665	1.007
	WLAN5.5GHz	802.11a 6Mbps	Right Cheek	Reduced	100	5500	14.51	16.00	1.409	91.12	1.097	0.04	0.546	0.844
	WLAN5.5GHz	802.11a 6Mbps	Right Tilted	Reduced	100	5500	14.51	16.00	1.409	91.12	1.097	0.03	0.615	0.951
11	WLAN5.5GHz	802.11a 6Mbps	Left Cheek	Reduced	100	5500	14.51	16.00	1.409	91.12	1.097	0.15	0.770	1.190
	WLAN5.5GHz	802.11a 6Mbps	Left Tilted	Reduced	100	5500	14.51	16.00	1.409	91.12	1.097	0.11	0.633	0.979
	WLAN5.5GHz	802.11a 6Mbps	Right Cheek	Reduced	116	5580	14.37	16.00	1.455	91.12	1.097	0.02	0.511	0.816
	WLAN5.5GHz	802.11a 6Mbps	Right Tilted	Reduced	116	5580	14.37	16.00	1.455	91.12	1.097	-0.18	0.559	0.893
	WLAN5.5GHz	802.11a 6Mbps	Left Cheek	Reduced	116	5580	14.37	16.00	1.455	91.12	1.097	0.06	0.511	0.816
	WLAN5.5GHz	802.11a 6Mbps	Left Tilted	Reduced	116	5580	14.37	16.00	1.455	91.12	1.097	-0.12	0.532	0.849
	WLAN5.8GHz	802.11a 6Mbps	Right Cheek	Reduced	165	5825	14.87	16.00	1.297	91.12	1.097	0.07	0.534	0.760
	WLAN5.8GHz	802.11a 6Mbps	Right Tilted	Reduced	165	5825	14.87	16.00	1.297	91.12	1.097	0.12	0.523	0.744
12	WLAN5.8GHz	802.11a 6Mbps	Left Cheek	Reduced	165	5825	14.87	16.00	1.297	91.12	1.097	0.18	0.720	1.025
	WLAN5.8GHz	802.11a 6Mbps	Left Tilted	Reduced	165	5825	14.87	16.00	1.297	91.12	1.097	0.02	0.494	0.703
	WLAN5.8GHz	802.11a 6Mbps	Left Cheek	Reduced	149	5745	14.47	16.00	1.421	91.12	1.097	-0.02	0.472	0.736

<Bluetooth SAR>

Plot No.	Band	Mode	Test Position	Power Reduction	Ch.	Freq. (MHz)	Average Power (dBm)	Tune-Up Limit (dBm)	Tune-up Scaling Factor	Duty Cycle %	Duty Cycle Scaling Factor	Power Drift (dB)	Measured 1g SAR (W/kg)	Reported 1g SAR (W/kg)
	Bluetooth	DH5 1Mbps	Right Cheek	Full	39	2441	5.90	6.00	1.023	77.67	1.287	0.02	0.025	0.033
	Bluetooth	DH5 1Mbps	Right Tilted	Full	39	2441	5.90	6.00	1.023	77.67	1.287	-0.04	0.026	0.034
13	Bluetooth	DH5 1Mbps	Left Cheek	Full	39	2441	5.90	6.00	1.023	77.67	1.287	0.1	0.050	0.066
	Bluetooth	DH5 1Mbps	Left Tilted	Full	39	2441	5.90	6.00	1.023	77.67	1.287	-0.13	0.038	0.050

16.2 Hotspot SAR

<GSM SAR>

Plot No.	Band	Mode	Test Position	Gap (mm)	Power Reduction	Ch.	Freq. (MHz)	Average Power (dBm)	Tune-Up Limit (dBm)	Tune-up Scaling Factor	Power Drift (dB)	Measured 1g SAR (W/kg)	Reported 1g SAR (W/kg)
	GSM850	GPRS(2 Tx slots)	Front	5mm	Reduced	189	836.4	29.35	30.00	1.161	-0.08	0.576	0.669
	GSM850	GPRS(2 Tx slots)	Back	5mm	Reduced	189	836.4	29.35	30.00	1.161	0.05	1.110	1.289
	GSM850	GPRS(2 Tx slots)	Left Side	5mm	Reduced	189	836.4	29.35	30.00	1.161	0.03	0.407	0.473
	GSM850	GPRS(2 Tx slots)	Right Side	5mm	Reduced	189	836.4	29.35	30.00	1.161	0.06	0.630	0.732
	GSM850	GPRS(2 Tx slots)	Bottom Side	5mm	Reduced	189	836.4	29.35	30.00	1.161	-0.07	0.264	0.307
	GSM850	GPRS(2 Tx slots)	Back	5mm	Reduced	128	824.2	29.34	30.00	1.164	-0.12	1.170	1.362
14	GSM850	GPRS(2 Tx slots)	Back	5mm	Reduced	251	848.8	29.26	30.00	1.186	0.11	1.180	1.399
	GSM1900	GPRS(2 Tx slots)	Front	5mm	Reduced	661	1880	25.07	26.50	1.390	0.16	0.670	0.931
	GSM1900	GPRS(2 Tx slots)	Back	5mm	Reduced	661	1880	25.07	26.50	1.390	0.05	0.870	1.209
	GSM1900	GPRS(2 Tx slots)	Left Side	5mm	Reduced	661	1880	23.59	25.00	1.384	-0.03	0.227	0.314
	GSM1900	GPRS(2 Tx slots)	Right Side	5mm	Reduced	661	1880	23.59	25.00	1.384	0.12	0.097	0.134
	GSM1900	GPRS(2 Tx slots)	Bottom Side	5mm	Reduced	661	1880	23.59	25.00	1.384	0.18	0.823	1.139
	GSM1900	GPRS(2 Tx slots)	Bottom Side	5mm	Reduced	512	1850.2	23.58	25.00	1.387	0.09	0.831	1.152
	GSM1900	GPRS(2 Tx slots)	Bottom Side	5mm	Reduced	810	1909.8	23.41	25.00	1.442	0.14	0.786	1.134
	GSM1900	GPRS(2 Tx slots)	Front	5mm	Reduced	512	1850.2	25.04	26.50	1.400	-0.01	0.744	1.041
	GSM1900	GPRS(2 Tx slots)	Front	5mm	Reduced	810	1909.8	25.01	26.50	1.409	0.09	0.701	0.988
15	GSM1900	GPRS(2 Tx slots)	Back	5mm	Reduced	512	1850.2	25.04	26.50	1.400	0.02	0.929	1.300
	GSM1900	GPRS(2 Tx slots)	Back	5mm	Reduced	810	1909.8	25.01	26.50	1.409	0.14	0.911	1.284

<WCDMA SAR>

Plot No.	Band	Mode	Test Position	Gap (mm)	Power Reduction	Ch.	Freq. (MHz)	Average Power (dBm)	Tune-Up Limit (dBm)	Tune-up Scaling Factor	Power Drift (dB)	Measured 1g SAR (W/kg)	Reported 1g SAR (W/kg)
	WCDMA V	RMC 12.2Kbps	Front	5mm	Reduced	4132	826.4	22.04	22.50	1.112	-0.04	0.542	0.603
	WCDMA V	RMC 12.2Kbps	Back	5mm	Reduced	4132	826.4	22.04	22.50	1.112	0.11	1.130	1.256
	WCDMA V	RMC 12.2Kbps	Left Side	5mm	Reduced	4132	826.4	22.04	22.50	1.112	0.02	0.362	0.402
	WCDMA V	RMC 12.2Kbps	Right Side	5mm	Reduced	4132	826.4	22.04	22.50	1.112	-0.06	0.563	0.626
	WCDMA V	RMC 12.2Kbps	Bottom Side	5mm	Reduced	4132	826.4	22.04	22.50	1.112	-0.03	0.228	0.253
	WCDMA V	RMC 12.2Kbps	Back	5mm	Reduced	4182	836.4	21.94	22.50	1.138	-0.03	1.070	1.217
16	WCDMA V	RMC 12.2Kbps	Back	5mm	Reduced	4233	846.6	21.98	22.50	1.127	0.04	1.180	1.330
	WCDMA II	RMC 12.2Kbps	Front	5mm	Reduced	9538	1907.6	19.77	20.50	1.183	0.16	0.778	0.920
	WCDMA II	RMC 12.2Kbps	Back	5mm	Reduced	9538	1907.6	19.77	20.50	1.183	0.05	0.953	1.127
	WCDMA II	RMC 12.2Kbps	Left Side	5mm	Reduced	9538	1907.6	19.77	20.50	1.183	-0.08	0.353	0.418
	WCDMA II	RMC 12.2Kbps	Right Side	5mm	Reduced	9538	1907.6	19.77	20.50	1.183	0.07	0.115	0.136
	WCDMA II	RMC 12.2Kbps	Bottom Side	5mm	Reduced	9538	1907.6	19.77	20.50	1.183	0.08	0.972	1.150
	WCDMA II	RMC 12.2Kbps	Bottom Side	5mm	Reduced	9262	1852.4	19.62	20.50	1.225	0.09	1.020	1.249
	WCDMA II	RMC 12.2Kbps	Bottom Side	5mm	Reduced	9400	1880	19.74	20.50	1.191	0.07	1.100	1.310
	WCDMA II	RMC 12.2Kbps	Front	5mm	Reduced	9262	1852.4	19.62	20.50	1.225	-0.12	0.858	1.051
	WCDMA II	RMC 12.2Kbps	Front	5mm	Reduced	9400	1880	19.74	20.50	1.191	0.09	0.801	0.954
	WCDMA II	RMC 12.2Kbps	Back	5mm	Reduced	9262	1852.4	19.62	20.50	1.225	-0.08	0.858	1.051
17	WCDMA II	RMC 12.2Kbps	Back	5mm	Reduced	9400	1880	19.74	20.50	1.191	-0.09	1.100	1.310



<FDD LTE SAR>

Plot No.	Band	BW (MHz)	Modulation	RB Size	RB offset	Test Position	Gap (mm)	Power Reduction	Ch.	Freq. (MHz)	Average Power (dBm)	Tune-Up Limit (dBm)	Tune-up Scaling Factor	Power Drift (dB)	Measured 1g SAR (W/kg)	Reported 1g SAR (W/kg)
	LTE Band 26	15M	QPSK	1	0	Front	5mm	Reduced	26865	831.5	21.91	23.00	1.285	0.1	0.566	0.727
	LTE Band 26	15M	QPSK	1	0	Back	5mm	Reduced	26865	831.5	21.91	23.00	1.285	-0.1	0.936	1.203
	LTE Band 26	15M	QPSK	1	0	Left Side	5mm	Reduced	26865	831.5	21.91	23.00	1.285	0.06	0.207	0.266
	LTE Band 26	15M	QPSK	1	0	Right Side	5mm	Reduced	26865	831.5	21.91	23.00	1.285	0.01	0.321	0.413
	LTE Band 26	15M	QPSK	1	0	Bottom Side	5mm	Reduced	26865	831.5	21.91	23.00	1.285	0.19	0.108	0.139
	LTE Band 26	15M	QPSK	1	0	Back	5mm	Reduced	26765	821.5	21.59	23.00	1.384	0.02	0.905	1.252
18	LTE Band 26	15M	QPSK	1	0	Back	5mm	Reduced	26965	841.5	21.89	23.00	1.291	0.01	1.020	1.317
	LTE Band 26	15M	QPSK	36	20	Front	5mm	Reduced	26865	831.5	21.39	22.00	1.151	0.04	0.488	0.562
	LTE Band 26	15M	QPSK	36	20	Back	5mm	Reduced	26865	831.5	21.39	22.00	1.151	0.16	0.680	0.783
	LTE Band 26	15M	QPSK	36	20	Left Side	5mm	Reduced	26865	831.5	21.39	22.00	1.151	0.02	0.178	0.205
	LTE Band 26	15M	QPSK	36	20	Right Side	5mm	Reduced	26865	831.5	21.39	22.00	1.151	-0.08	0.196	0.226
	LTE Band 26	15M	QPSK	36	20	Bottom Side	5mm	Reduced	26865	831.5	21.39	22.00	1.151	-0.06	0.111	0.128
	LTE Band 26	15M	QPSK	36	20	Back	5mm	Reduced	26765	821.5	21.33	22.00	1.167	0.02	0.671	0.783
	LTE Band 26	15M	QPSK	36	20	Back	5mm	Reduced	26965	841.5	21.03	22.00	1.250	-0.08	0.717	0.896
	LTE Band 26	15M	QPSK	75	0	Back	5mm	Reduced	26865	831.5	21.26	22.00	1.186	0.08	0.673	0.798
	LTE Band 2	20M	QPSK	1	0	Front	5mm	Reduced	18900	1880	21.39	21.50	1.026	0.19	0.635	0.651
	LTE Band 2	20M	QPSK	1	0	Back	5mm	Reduced	18900	1880	21.39	21.50	1.026	0.17	0.911	0.934
	LTE Band 2	20M	QPSK	1	0	Left Side	5mm	Reduced	18900	1880	19.69	20.00	1.074	-0.09	0.254	0.273
	LTE Band 2	20M	QPSK	1	0	Right Side	5mm	Reduced	18900	1880	19.69	20.00	1.074	-0.09	0.120	0.129
	LTE Band 2	20M	QPSK	1	0	Bottom Side	5mm	Reduced	18900	1880	19.69	20.00	1.074	-0.06	0.976	1.048
	LTE Band 2	20M	QPSK	1	0	Bottom Side	5mm	Reduced	18700	1860	18.66	20.00	1.361	0.17	0.920	1.253
	LTE Band 2	20M	QPSK	1	0	Bottom Side	5mm	Reduced	19100	1900	19.62	20.00	1.091	0.12	0.827	0.903
	LTE Band 2	20M	QPSK	1	0	Back	5mm	Reduced	18700	1860	20.51	21.50	1.256	-0.04	0.978	1.228
	LTE Band 2	20M	QPSK	1	0	Back	5mm	Reduced	19100	1900	21.38	21.50	1.028	0.17	0.793	0.815
	LTE Band 2	20M	QPSK	50	0	Front	5mm	Reduced	18900	1880	19.89	20.50	1.151	0.19	0.749	0.862
	LTE Band 2	20M	QPSK	50	0	Back	5mm	Reduced	18900	1880	19.89	20.50	1.151	0.08	1.100	1.266
	LTE Band 2	20M	QPSK	50	0	Left Side	5mm	Reduced	18900	1880	18.34	19.00	1.164	0.1	0.228	0.265
	LTE Band 2	20M	QPSK	50	0	Right Side	5mm	Reduced	18900	1880	18.34	19.00	1.164	0.16	0.107	0.125
	LTE Band 2	20M	QPSK	50	0	Bottom Side	5mm	Reduced	18900	1880	18.34	19.00	1.164	0.08	0.766	0.892
	LTE Band 2	20M	QPSK	50	0	Bottom Side	5mm	Reduced	18700	1860	17.51	19.00	1.409	0.05	0.574	0.809
	LTE Band 2	20M	QPSK	50	0	Bottom Side	5mm	Reduced	19100	1900	18.32	19.00	1.169	-0.07	0.629	0.736
	LTE Band 2	20M	QPSK	50	0	Front	5mm	Reduced	18700	1860	19.21	20.50	1.346	0.01	0.502	0.676
	LTE Band 2	20M	QPSK	50	0	Front	5mm	Reduced	19100	1900	19.86	20.50	1.159	0.04	0.574	0.665
	LTE Band 2	20M	QPSK	50	0	Back	5mm	Reduced	18700	1860	19.21	20.50	1.346	0.14	0.744	1.001
	LTE Band 2	20M	QPSK	50	0	Back	5mm	Reduced	19100	1900	19.86	20.50	1.159	-0.02	0.859	0.995
	LTE Band 2	20M	QPSK	100	0	Front	5mm	Reduced	18900	1880	19.56	20.50	1.242	-0.14	0.704	0.874
19	LTE Band 2	20M	QPSK	100	0	Back	5mm	Reduced	18900	1880	19.56	20.50	1.242	0.12	1.100	1.366
	LTE Band 2	20M	QPSK	100	0	Bottom Side	5mm	Reduced	18900	1880	18.12	19.00	1.225	0.04	0.788	0.965



Plot No.	Band	BW (MHz)	Modulation	RB Size	RB offset	Test Position	Gap (mm)	Power Reduction	Ch.	Freq. (MHz)	Average Power (dBm)	Tune-Up Limit (dBm)	Tune-up Scaling Factor	Power Drift (dB)	Measured 1g SAR (W/kg)	Reported 1g SAR (W/kg)
	LTE Band 7	20M	QPSK	1	99	Front	5mm	Reduced	21350	2560	17.66	19.00	1.361	0.13	0.330	0.449
	LTE Band 7	20M	QPSK	1	99	Back	5mm	Reduced	21350	2560	17.66	19.00	1.361	0.14	0.814	1.108
	LTE Band 7	20M	QPSK	1	99	Left Side	5mm	Reduced	21350	2560	16.10	17.50	1.380	-0.02	0.083	0.115
	LTE Band 7	20M	QPSK	1	99	Right Side	5mm	Reduced	21350	2560	16.10	17.50	1.380	-0.03	0.070	0.097
	LTE Band 7	20M	QPSK	1	99	Bottom Side	5mm	Reduced	21350	2560	16.10	17.50	1.380	-0.13	0.819	1.131
	LTE Band 7	20M	QPSK	1	99	Bottom Side	5mm	Reduced	20850	2510	15.68	17.50	1.521	0.15	0.702	1.067
	LTE Band 7	20M	QPSK	1	99	Bottom Side	5mm	Reduced	21100	2535	16.09	17.50	1.384	0.16	0.965	1.335
	LTE Band 7	20M	QPSK	1	99	Back	5mm	Reduced	20850	2510	17.43	19.00	1.435	0.14	0.680	0.976
20	LTE Band 7	20M	QPSK	1	99	Back	5mm	Reduced	21100	2535	17.58	19.00	1.387	0.19	0.968	1.342
	LTE Band 7	20M	QPSK	50	50	Front	5mm	Reduced	21350	2560	16.45	18.00	1.429	0.04	0.234	0.334
	LTE Band 7	20M	QPSK	50	50	Back	5mm	Reduced	21350	2560	16.45	18.00	1.429	0.07	0.727	1.039
	LTE Band 7	20M	QPSK	50	50	Left Side	5mm	Reduced	21350	2560	15.28	16.50	1.324	0.09	0.059	0.078
	LTE Band 7	20M	QPSK	50	50	Right Side	5mm	Reduced	21350	2560	15.28	16.50	1.324	-	n/a	n/a
	LTE Band 7	20M	QPSK	50	50	Bottom Side	5mm	Reduced	21350	2560	15.28	16.50	1.324	-0.02	0.600	0.795
	LTE Band 7	20M	QPSK	50	50	Back	5mm	Reduced	20850	2510	16.42	18.00	1.439	0.1	0.553	0.796
	LTE Band 7	20M	QPSK	50	50	Back	5mm	Reduced	21100	2535	16.44	18.00	1.432	0.11	0.858	1.229
	LTE Band 7	20M	QPSK	100	0	Back	5mm	Reduced	21350	2560	16.27	18.00	1.489	0.01	0.602	0.897
	LTE Band 7	20M	QPSK	100	0	Bottom Side	5mm	Reduced	21350	2560	15.29	16.50	1.321	0.14	0.621	0.821

<TDD LTE SAR>

Plot No.	Band	BW (MHz)	Modulation	RB Size	RB offset	Test Position	Gap (mm)	Power Reduction	Ch.	Freq. (MHz)	Average Power (dBm)	Tune-Up Limit (dBm)	Tune-up Scaling Factor	Duty Cycle %	Duty Cycle Scaling Factor	Power Drift (dB)	Measured 1g SAR (W/kg)	Reported 1g SAR (W/kg)
	LTE Band 41	20M	QPSK	1	99	Front	5mm	Reduced	41490	2680	20.31	22.00	1.476	62.9	1.006	0.05	0.282	0.419
	LTE Band 41	20M	QPSK	1	99	Back	5mm	Reduced	41490	2680	20.31	22.00	1.476	62.9	1.006	-0.07	0.742	1.102
	LTE Band 41	20M	QPSK	1	99	Left Side	5mm	Reduced	41490	2680	20.10	21.00	1.230	62.9	1.006	0.04	0.057	0.071
	LTE Band 41	20M	QPSK	1	99	Right Side	5mm	Reduced	41490	2680	20.10	21.00	1.230	62.9	1.006	0.09	0.079	0.098
	LTE Band 41	20M	QPSK	1	99	Bottom Side	5mm	Reduced	41490	2680	20.10	21.00	1.230	62.9	1.006	0.03	0.865	1.071
	LTE Band 41	20M	QPSK	1	99	Bottom Side	5mm	Reduced	39750	2506	19.97	21.00	1.268	62.9	1.006	0.02	0.862	1.099
21	LTE Band 41	20M	QPSK	1	99	Bottom Side	5mm	Reduced	40185	2549.5	20.04	21.00	1.247	62.9	1.006	-0.05	1.090	1.368
	LTE Band 41	20M	QPSK	1	99	Bottom Side	5mm	Reduced	40620	2593	20.08	21.00	1.236	62.9	1.006	-0.12	1.010	1.256
	LTE Band 41	20M	QPSK	1	99	Bottom Side	5mm	Reduced	41055	2636.5	19.96	21.00	1.271	62.9	1.006	-0.07	0.930	1.189
	LTE Band 41	20M	QPSK	1	99	Back	5mm	Reduced	39750	2506	20.19	22.00	1.517	62.9	1.006	0.14	0.585	0.893
	LTE Band 41	20M	QPSK	1	99	Back	5mm	Reduced	40185	2549.5	20.26	22.00	1.493	62.9	1.006	0.1	0.660	0.991
	LTE Band 41	20M	QPSK	1	99	Back	5mm	Reduced	40620	2593	20.12	22.00	1.542	62.9	1.006	0.17	0.723	1.121
	LTE Band 41	20M	QPSK	1	99	Back	5mm	Reduced	41055	2636.5	20.16	22.00	1.528	62.9	1.006	0.09	0.764	1.174
	LTE Band 41	20M	QPSK	50	50	Front	5mm	Reduced	41490	2680	20.59	22.00	1.384	62.9	1.006	0.18	0.304	0.423
	LTE Band 41	20M	QPSK	50	50	Back	5mm	Reduced	41490	2680	20.59	22.00	1.384	62.9	1.006	0.12	0.818	1.139
	LTE Band 41	20M	QPSK	50	50	Left Side	5mm	Reduced	41490	2680	19.05	20.00	1.245	62.9	1.006	0.16	0.047	0.059
	LTE Band 41	20M	QPSK	50	50	Right Side	5mm	Reduced	41490	2680	19.05	20.00	1.245	62.9	1.006	-0.15	0.041	0.051
	LTE Band 41	20M	QPSK	50	50	Bottom Side	5mm	Reduced	41490	2680	19.05	20.00	1.245	62.9	1.006	0.09	0.713	0.893
	LTE Band 41	20M	QPSK	50	50	Bottom Side	5mm	Reduced	39750	2506	18.97	20.00	1.268	62.9	1.006	0.08	0.673	0.858
	LTE Band 41	20M	QPSK	50	50	Bottom Side	5mm	Reduced	40185	2549.5	19.04	20.00	1.247	62.9	1.006	-0.04	0.892	1.119
	LTE Band 41	20M	QPSK	50	50	Bottom Side	5mm	Reduced	40620	2593	19.05	20.00	1.245	62.9	1.006	-0.18	0.857	1.073
	LTE Band 41	20M	QPSK	50	50	Bottom Side	5mm	Reduced	41055	2636.5	19.02	20.00	1.253	62.9	1.006	0.1	0.775	0.977
	LTE Band 41	20M	QPSK	50	50	Back	5mm	Reduced	39750	2506	20.58	22.00	1.387	62.9	1.006	0.01	0.602	0.840
	LTE Band 41	20M	QPSK	50	50	Back	5mm	Reduced	40185	2549.5	20.53	22.00	1.403	62.9	1.006	0.17	0.861	1.215
	LTE Band 41	20M	QPSK	50	50	Back	5mm	Reduced	40620	2593	20.56	22.00	1.393	62.9	1.006	-0.01	0.814	1.141
	LTE Band 41	20M	QPSK	50	50	Back	5mm	Reduced	41055	2636.5	20.51	22.00	1.409	62.9	1.006	-0.01	0.779	1.104
	LTE Band 41	20M	QPSK	100	0	Back	5mm	Reduced	41490	2680	20.61	22.00	1.377	62.9	1.006	0.07	0.810	1.122
	LTE Band 41	20M	QPSK	100	0	Bottom Side	5mm	Reduced	41490	2680	19.15	20.00	1.216	62.9	1.006	0.13	0.714	0.874



<WLAN2.4G SAR>

Plot No.	Band	Mode	Test Position	Gap (mm)	Power Reduction	Ch.	Freq. (MHz)	Average Power (dBm)	Tune-Up Limit (dBm)	Tune-up Scaling Factor	Duty Cycle %	Duty Cycle Scaling Factor	Power Drift (dB)	Measured 1g SAR (W/kg)	Reported 1g SAR (W/kg)
	WLAN2.4GHz	802.11b 1Mbps	Front	5mm	Full	1	2412	18.10	18.50	1.096	98.6	1.014	0.08	0.376	0.418
22	WLAN2.4GHz	802.11b 1Mbps	Back	5mm	Full	1	2412	18.10	18.50	1.096	98.6	1.014	-0.05	0.556	0.618
	WLAN2.4GHz	802.11b 1Mbps	Left Side	5mm	Full	1	2412	18.10	18.50	1.096	98.6	1.014	0.06	0.082	0.091
	WLAN2.4GHz	802.11b 1Mbps	Right Side	5mm	Full	1	2412	18.10	18.50	1.096	98.6	1.014	-0.09	0.400	0.445
	WLAN2.4GHz	802.11b 1Mbps	Top Side	5mm	Full	1	2412	18.10	18.50	1.096	98.6	1.014	0.15	0.310	0.345

<WLAN5G SAR>

Plot No.	Band	Mode	Test Position	Gap (mm)	Power Reduction	Ch.	Freq. (MHz)	Average Power (dBm)	Tune-Up Limit (dBm)	Tune-up Scaling Factor	Duty Cycle %	Duty Cycle Scaling Factor	Power Drift (dB)	Measured 1g SAR (W/kg)	Reported 1g SAR (W/kg)
	WLAN5.2GHz	802.11a 6Mbps	Front	5mm	Reduced	36	5180	14.03	15.00	1.250	91.12	1.097	-0.04	0.199	0.273
	WLAN5.2GHz	802.11a 6Mbps	Back	5mm	Reduced	36	5180	14.03	15.00	1.250	91.12	1.097	0.11	0.629	0.863
	WLAN5.2GHz	802.11a 6Mbps	Back	5mm	Reduced	44	5220	13.87	15.00	1.297	91.12	1.097	0.02	0.584	0.831
	WLAN5.2GHz	802.11a 6Mbps	Left Side	5mm	Reduced	36	5180	14.03	15.00	1.250	91.12	1.097	-0.1	0.026	0.035
	WLAN5.2GHz	802.11a 6Mbps	Right Side	5mm	Reduced	36	5180	14.03	15.00	1.250	91.12	1.097	-0.06	0.118	0.162
23	WLAN5.2GHz	802.11a 6Mbps	Top Side	5mm	Reduced	36	5180	14.03	15.00	1.250	91.12	1.097	0.12	0.708	0.971
	WLAN5.2GHz	802.11a 6Mbps	Top Side	5mm	Reduced	44	5220	13.87	15.00	1.297	91.12	1.097	-0.18	0.680	0.968
	WLAN5.8GHz	802.11a 6Mbps	Front	5mm	Reduced	165	5825	14.07	15.00	1.239	91.12	1.097	0.19	0.207	0.281
	WLAN5.8GHz	802.11a 6Mbps	Back	5mm	Reduced	165	5825	14.07	15.00	1.239	91.12	1.097	0.17	0.617	0.838
24	WLAN5.8GHz	802.11a 6Mbps	Back	5mm	Reduced	149	5745	13.67	15.00	1.358	91.12	1.097	0.17	0.681	1.015
	WLAN5.8GHz	802.11a 6Mbps	Left Side	5mm	Reduced	165	5825	14.07	15.00	1.239	91.12	1.097	0.12	0.022	0.029
	WLAN5.8GHz	802.11a 6Mbps	Right Side	5mm	Reduced	165	5825	14.07	15.00	1.239	91.12	1.097	0.01	0.124	0.169
	WLAN5.8GHz	802.11a 6Mbps	Top Side	5mm	Reduced	165	5825	14.07	15.00	1.239	91.12	1.097	-0.06	0.714	0.970
	WLAN5.8GHz	802.11a 6Mbps	Top Side	5mm	Reduced	149	5745	13.67	15.00	1.358	91.12	1.097	-0.04	0.667	0.994

<Bluetooth SAR>

Plot No.	Band	Mode	Test Position	Gap (mm)	Power Reduction	Ch.	Freq. (MHz)	Average Power (dBm)	Tune-Up Limit (dBm)	Tune-up Scaling Factor	Duty Cycle %	Duty Cycle Scaling Factor	Power Drift (dB)	Measured 1g SAR (W/kg)	Reported 1g SAR (W/kg)
	Bluetooth	DH5 1Mbps	Front	5mm	Full	39	2441	5.90	6.00	1.023	77.67	1.287	0.19	0.024	0.032
25	Bluetooth	DH5 1Mbps	Back	5mm	Full	39	2441	5.90	6.00	1.023	77.67	1.287	-0.05	0.031	0.041
	Bluetooth	DH5 1Mbps	Left Side	5mm	Full	39	2441	5.90	6.00	1.023	77.67	1.287	0.09	0.005	0.007
	Bluetooth	DH5 1Mbps	Right Side	5mm	Full	39	2441	5.90	6.00	1.023	77.67	1.287	0.14	0.028	0.037
	Bluetooth	DH5 1Mbps	Top Side	5mm	Full	39	2441	5.90	6.00	1.023	77.67	1.287	0.13	0.020	0.026



16.3 Body Worn Accessory SAR

<GSM SAR>

Plot No.	Band	Mode	Test Position	Gap (mm)	Headset	Power Reduction	Ch.	Freq. (MHz)	Average Power (dBm)	Tune-Up Limit (dBm)	Tune-up Scaling Factor	Power Drift (dB)	Measured 1g SAR (W/kg)	Reported 1g SAR (W/kg)
	GSM850	GPRS(2 Tx slots)	Front	5mm	-	Reduced	189	836.4	29.35	30.00	1.161	-0.08	0.576	0.669
	GSM850	GPRS(2 Tx slots)	Back	5mm	-	Reduced	189	836.4	29.35	30.00	1.161	0.05	1.110	1.289
	GSM850	GPRS(2 Tx slots)	Back	5mm	-	Reduced	128	824.2	29.34	30.00	1.164	-0.12	1.170	1.362
26	GSM850	GPRS(2 Tx slots)	Back	5mm	-	Reduced	251	848.8	29.26	30.00	1.186	0.11	1.180	1.399
	GSM850	GPRS(2 Tx slots)	Back	5mm	Headset 1	Reduced	251	848.8	29.26	30.00	1.186	0.08	1.160	1.375
	GSM850	GPRS(2 Tx slots)	Back	5mm	Headset 2	Reduced	251	848.8	29.26	30.00	1.186	0.02	1.130	1.340
	GSM850	GPRS(2 Tx slots)	Back	5mm	Headset 3	Reduced	251	848.8	29.26	30.00	1.186	0.06	1.150	1.364
	GSM850	GPRS(2 Tx slots)	Back	5mm	Headset 4	Reduced	251	848.8	29.26	30.00	1.186	-0.03	1.110	1.316
	GSM850	GPRS(2 Tx slots)	Back	5mm	Headset 5	Reduced	251	848.8	29.26	30.00	1.186	-0.08	1.090	1.292
	GSM850	GPRS(2 Tx slots)	Front	14mm	-	Full	189	836.4	31.19	32.00	1.205	0.03	0.398	0.480
	GSM850	GPRS(2 Tx slots)	Back	21mm	-	Full	251	848.8	31.14	32.00	1.219	0.05	0.390	0.475
	GSM1900	GPRS(2 Tx slots)	Front	5mm	-	Reduced	661	1880	25.07	26.50	1.390	0.16	0.670	0.931
	GSM1900	GPRS(2 Tx slots)	Back	5mm	-	Reduced	661	1880	25.07	26.50	1.390	0.05	0.870	1.209
	GSM1900	GPRS(2 Tx slots)	Front	5mm	-	Reduced	512	1850.2	25.04	26.50	1.400	-0.01	0.744	1.041
	GSM1900	GPRS(2 Tx slots)	Front	5mm	-	Reduced	810	1909.8	25.01	26.50	1.409	0.09	0.701	0.988
27	GSM1900	GPRS(2 Tx slots)	Back	5mm	-	Reduced	512	1850.2	25.04	26.50	1.400	0.02	0.929	1.300
	GSM1900	GPRS(2 Tx slots)	Back	5mm	-	Reduced	810	1909.8	25.01	26.50	1.409	0.14	0.911	1.284
	GSM1900	GPRS(2 Tx slots)	Back	5mm	Headset 1	Reduced	512	1850.2	25.04	26.50	1.400	0.09	0.918	1.285
	GSM1900	GPRS(2 Tx slots)	Front	14mm	-	Full	512	1850.2	27.77	29.50	1.489	0.1	0.304	0.453
	GSM1900	GPRS(2 Tx slots)	Back	21mm	-	Full	512	1850.2	27.77	29.50	1.489	0.04	0.195	0.290

<WCDMA SAR>

Plot No.	Band	Mode	Test Position	Gap (mm)	Headset	Power Reduction	Ch.	Freq. (MHz)	Average Power (dBm)	Tune-Up Limit (dBm)	Tune-up Scaling Factor	Power Drift (dB)	Measured 1g SAR (W/kg)	Reported 1g SAR (W/kg)
	WCDMA V	RMC 12.2Kbps	Front	5mm	-	Reduced	4132	826.4	22.04	22.50	1.112	-0.04	0.542	0.603
	WCDMA V	RMC 12.2Kbps	Back	5mm	-	Reduced	4132	826.4	22.04	22.50	1.112	0.11	1.130	1.256
	WCDMA V	RMC 12.2Kbps	Back	5mm	-	Reduced	4182	836.4	21.94	22.50	1.138	-0.03	1.070	1.217
28	WCDMA V	RMC 12.2Kbps	Back	5mm	-	Reduced	4233	846.6	21.98	22.50	1.127	0.04	1.180	1.330
	WCDMA V	RMC 12.2Kbps	Back	5mm	Headset 1	Reduced	4233	846.6	21.98	22.50	1.127	0.08	1.150	1.296
	WCDMA V	RMC 12.2Kbps	Front	14mm	-	Full	4132	826.4	23.64	24.00	1.086	-0.11	0.213	0.231
	WCDMA V	RMC 12.2Kbps	Back	21mm	-	Full	4233	846.6	23.56	24.00	1.107	0.11	0.193	0.214
	WCDMA II	RMC 12.2Kbps	Front	5mm	-	Reduced	9538	1907.6	19.77	20.50	1.183	0.16	0.778	0.920
	WCDMA II	RMC 12.2Kbps	Back	5mm	-	Reduced	9538	1907.6	19.77	20.50	1.183	0.05	0.953	1.127
	WCDMA II	RMC 12.2Kbps	Front	5mm	-	Reduced	9262	1852.4	19.62	20.50	1.225	-0.12	0.858	1.051
	WCDMA II	RMC 12.2Kbps	Front	5mm	-	Reduced	9400	1880	19.74	20.50	1.191	0.09	0.801	0.954
	WCDMA II	RMC 12.2Kbps	Back	5mm	-	Reduced	9262	1852.4	19.62	20.50	1.225	-0.08	0.858	1.051
29	WCDMA II	RMC 12.2Kbps	Back	5mm	-	Reduced	9400	1880	19.74	20.50	1.191	-0.12	1.100	1.310
	WCDMA II	RMC 12.2Kbps	Back	5mm	Headset 1	Reduced	9400	1880	19.74	20.50	1.191	0.07	0.997	1.188
	WCDMA II	RMC 12.2Kbps	Front	14mm	-	Full	9262	1852.4	23.32	24.00	1.169	0.01	0.520	0.608
	WCDMA II	RMC 12.2Kbps	Back	21mm	-	Full	9400	1880	23.36	24.00	1.159	0.13	0.331	0.384



<FDD LTE SAR>

Plot No.	Band	BW (MHz)	Modulation	RB Size	RB offset	Test Position	Gap (mm)	Headset	Power Reduction	Ch.	Freq. (MHz)	Average Power (dBm)	Tune-Up Limit (dBm)	Tune-up Scaling Factor	Power Drift (dB)	Measured 1g SAR (W/kg)	Reported 1g SAR (W/kg)
	LTE Band 26	15M	QPSK	1	0	Front	5mm	-	Reduced	26865	831.5	21.91	23.00	1.285	0.1	0.566	0.727
	LTE Band 26	15M	QPSK	1	0	Back	5mm	-	Reduced	26865	831.5	21.91	23.00	1.285	-0.1	0.936	1.203
	LTE Band 26	15M	QPSK	1	0	Back	5mm	-	Reduced	26765	821.5	21.59	23.00	1.384	0.02	0.905	1.252
30	LTE Band 26	15M	QPSK	1	0	Back	5mm	-	Reduced	26965	841.5	21.89	23.00	1.291	0.01	1.020	1.317
	LTE Band 26	15M	QPSK	1	0	Back	5mm	Headset 1	Reduced	26965	841.5	21.89	23.00	1.291	-0.12	1.010	1.304
	LTE Band 26	15M	QPSK	1	0	Front	14mm	-	Full	26865	831.5	23.25	24.00	1.189	-0.04	0.228	0.271
	LTE Band 26	15M	QPSK	1	0	Back	21mm	-	Full	26965	841.5	23.14	24.00	1.219	0.09	0.192	0.234
	LTE Band 26	15M	QPSK	36	20	Front	5mm	-	Reduced	26865	831.5	21.39	22.00	1.151	0.04	0.488	0.562
	LTE Band 26	15M	QPSK	36	20	Back	5mm	-	Reduced	26865	831.5	21.39	22.00	1.151	0.16	0.680	0.783
	LTE Band 26	15M	QPSK	36	20	Back	5mm	-	Reduced	26765	821.5	21.33	22.00	1.167	0.02	0.671	0.783
	LTE Band 26	15M	QPSK	36	20	Back	5mm	-	Reduced	26965	841.5	21.03	22.00	1.250	-0.08	0.717	0.896
	LTE Band 26	15M	QPSK	75	0	Back	5mm	-	Reduced	26865	831.5	21.26	22.00	1.186	0.08	0.673	0.798
	LTE Band 2	20M	QPSK	1	0	Front	5mm	-	Reduced	18900	1880	21.39	21.50	1.026	0.19	0.635	0.651
	LTE Band 2	20M	QPSK	1	0	Back	5mm	-	Reduced	18900	1880	21.39	21.50	1.026	0.17	0.911	0.934
	LTE Band 2	20M	QPSK	1	0	Back	5mm	-	Reduced	18700	1860	20.51	21.50	1.256	-0.04	0.978	1.228
	LTE Band 2	20M	QPSK	1	0	Back	5mm	-	Reduced	19100	1900	21.38	21.50	1.028	0.17	0.793	0.815
	LTE Band 2	20M	QPSK	1	0	Back	5mm	Headset 1	Reduced	18700	1860	20.51	21.50	1.256	0.11	0.976	1.225
	LTE Band 2	20M	QPSK	1	0	Front	14mm	-	Full	18900	1880	22.98	24.00	1.265	0.18	0.311	0.393
	LTE Band 2	20M	QPSK	1	0	Back	21mm	-	Full	18700	1860	22.78	24.00	1.324	0.05	0.187	0.248
	LTE Band 2	20M	QPSK	50	0	Front	5mm	-	Reduced	18900	1880	19.89	20.50	1.151	0.19	0.749	0.862
	LTE Band 2	20M	QPSK	50	0	Back	5mm	-	Reduced	18900	1880	19.89	20.50	1.151	0.08	1.100	1.266
	LTE Band 2	20M	QPSK	50	0	Front	5mm	-	Reduced	18700	1860	19.21	20.50	1.346	0.01	0.502	0.676
	LTE Band 2	20M	QPSK	50	0	Front	5mm	-	Reduced	19100	1900	19.86	20.50	1.159	0.04	0.574	0.665
	LTE Band 2	20M	QPSK	50	0	Back	5mm	-	Reduced	18700	1860	19.21	20.50	1.346	0.14	0.744	1.001
	LTE Band 2	20M	QPSK	50	0	Back	5mm	-	Reduced	19100	1900	19.86	20.50	1.159	-0.02	0.859	0.995
	LTE Band 2	20M	QPSK	50	0	Back	5mm	Headset 1	Reduced	18900	1880	19.89	20.50	1.151	0.06	1.100	1.266
	LTE Band 2	20M	QPSK	100	0	Front	5mm	-	Reduced	18900	1880	19.56	20.50	1.242	-0.14	0.704	0.874
31	LTE Band 2	20M	QPSK	100	0	Back	5mm	-	Reduced	18900	1880	19.56	20.50	1.242	0.12	1.100	1.366
	LTE Band 2	20M	QPSK	100	0	Back	5mm	Headset 1	Reduced	18900	1880	19.56	20.50	1.242	0.06	0.977	1.213
	LTE Band 2	20M	QPSK	100	0	Front	14mm	-	Full	18900	1880	22.44	23.00	1.138	0.13	0.276	0.314
	LTE Band 2	20M	QPSK	100	0	Back	21mm	-	Full	18900	1880	22.44	23.00	1.138	0.08	0.161	0.183
	LTE Band 7	20M	QPSK	1	99	Front	5mm	-	Reduced	21350	2560	17.66	19.00	1.361	0.13	0.330	0.449
	LTE Band 7	20M	QPSK	1	99	Back	5mm	-	Reduced	21350	2560	17.66	19.00	1.361	0.14	0.814	1.108
	LTE Band 7	20M	QPSK	1	99	Back	5mm	-	Reduced	20850	2510	17.43	19.00	1.435	0.14	0.680	0.976
32	LTE Band 7	20M	QPSK	1	99	Back	5mm	-	Reduced	21100	2535	17.58	19.00	1.387	0.19	0.968	1.342
	LTE Band 7	20M	QPSK	1	99	Back	5mm	Headset 1	Reduced	21100	2535	17.58	19.00	1.387	0.12	0.929	1.288
	LTE Band 7	20M	QPSK	1	99	Front	14mm	-	Full	21350	2560	22.99	24.00	1.262	0.18	0.211	0.266
	LTE Band 7	20M	QPSK	1	99	Back	21mm	-	Full	21100	2535	22.97	24.00	1.268	0.05	0.265	0.336
	LTE Band 7	20M	QPSK	50	50	Front	5mm	-	Reduced	21350	2560	16.45	18.00	1.429	0.04	0.234	0.334
	LTE Band 7	20M	QPSK	50	50	Back	5mm	-	Reduced	21350	2560	16.45	18.00	1.429	0.07	0.727	1.039
	LTE Band 7	20M	QPSK	50	50	Back	5mm	-	Reduced	20850	2510	16.42	18.00	1.439	0.1	0.553	0.796
	LTE Band 7	20M	QPSK	50	50	Back	5mm	-	Reduced	21100	2535	16.44	18.00	1.432	0.11	0.858	1.229
	LTE Band 7	20M	QPSK	50	50	Back	5mm	Headset 1	Reduced	21100	2535	16.44	18.00	1.432	0.14	0.838	1.200
	LTE Band 7	20M	QPSK	100	0	Back	5mm	-	Reduced	21350	2560	16.27	18.00	1.489	0.01	0.602	0.897



<TDD LTE SAR>

Plot No.	Band	BW (MHz)	Modulation	RB Size	RB offset	Test Position	Gap (mm)	Headset	Power Reduction	Ch.	Freq. (MHz)	Average Power (dBm)	Tune-Up Limit (dBm)	Tune-up Scaling Factor	Duty Cycle %	Duty Cycle Scaling Factor	Power Drift (dB)	Measured 1g SAR (W/kg)	Reported 1g SAR (W/kg)
	LTE Band 41	20M	QPSK	1	99	Front	5mm	-	Reduced	41490	2680	20.31	22.00	1.476	62.9	1.006	0.05	0.282	0.419
	LTE Band 41	20M	QPSK	1	99	Back	5mm	-	Reduced	41490	2680	20.31	22.00	1.476	62.9	1.006	-0.07	0.742	1.102
	LTE Band 41	20M	QPSK	1	99	Back	5mm	-	Reduced	39750	2506	20.19	22.00	1.517	62.9	1.006	0.14	0.585	0.893
	LTE Band 41	20M	QPSK	1	99	Back	5mm	-	Reduced	40185	2549.5	20.26	22.00	1.493	62.9	1.006	0.1	0.660	0.991
	LTE Band 41	20M	QPSK	1	99	Back	5mm	-	Reduced	40620	2593	20.12	22.00	1.542	62.9	1.006	0.17	0.723	1.121
	LTE Band 41	20M	QPSK	1	99	Back	5mm	-	Reduced	41055	2636.5	20.16	22.00	1.528	62.9	1.006	0.09	0.764	1.174
	LTE Band 41	20M	QPSK	50	50	Front	5mm	-	Reduced	41490	2680	20.59	22.00	1.384	62.9	1.006	0.18	0.304	0.423
	LTE Band 41	20M	QPSK	50	50	Back	5mm	-	Reduced	41490	2680	20.59	22.00	1.384	62.9	1.006	0.12	0.818	1.139
	LTE Band 41	20M	QPSK	50	50	Back	5mm	-	Reduced	39750	2506	20.58	22.00	1.387	62.9	1.006	0.01	0.602	0.840
	LTE Band 41	20M	QPSK	50	50	Back	5mm	-	Reduced	40185	2549.5	20.53	22.00	1.403	62.9	1.006	0.17	0.861	1.215
	LTE Band 41	20M	QPSK	50	50	Back	5mm	-	Reduced	40620	2593	20.56	22.00	1.393	62.9	1.006	-0.01	0.814	1.141
	LTE Band 41	20M	QPSK	50	50	Back	5mm	-	Reduced	41055	2636.5	20.51	22.00	1.409	62.9	1.006	-0.01	0.779	1.104
33	LTE Band 41	20M	QPSK	50	50	Back	5mm	Headset 1	Reduced	40185	2549.5	20.53	22.00	1.403	62.9	1.006	0.08	0.896	1.264
	LTE Band 41	20M	QPSK	50	50	Back	5mm	Headset 1	Reduced	41490	2680	20.59	22.00	1.384	62.9	1.006	-0.02	0.790	1.100
	LTE Band 41	20M	QPSK	50	50	Back	5mm	Headset 1	Reduced	39750	2506	20.58	22.00	1.387	62.9	1.006	-0.06	0.583	0.813
	LTE Band 41	20M	QPSK	50	50	Back	5mm	Headset 1	Reduced	40620	2593	20.56	22.00	1.393	62.9	1.006	0.02	0.732	1.026
	LTE Band 41	20M	QPSK	50	50	Back	5mm	Headset 1	Reduced	41055	2636.5	20.51	22.00	1.409	62.9	1.006	0.04	0.738	1.046
	LTE Band 41	20M	QPSK	50	50	Front	14mm	-	Full	41490	2680	22.75	24.00	1.334	62.9	1.006	0.06	0.130	0.174
	LTE Band 41	20M	QPSK	50	50	Back	21mm	-	Full	40185	2549.5	22.52	24.00	1.406	62.9	1.006	-0.05	0.161	0.228
	LTE Band 41	20M	QPSK	100	0	Back	5mm	-	Reduced	41490	2680	20.61	22.00	1.377	62.9	1.006	0.07	0.810	1.122

<WLAN2.4G SAR>

Plot No.	Band	Mode	Test Position	Gap (mm)	Power Reduction	Ch.	Freq. (MHz)	Average Power (dBm)	Tune-Up Limit (dBm)	Tune-up Scaling Factor	Duty Cycle %	Duty Cycle Scaling Factor	Power Drift (dB)	Measured 1g SAR (W/kg)	Reported 1g SAR (W/kg)
	WLAN2.4GHz	802.11b 1Mbps	Front	5mm	Full	1	2412	18.10	18.50	1.096	98.6	1.014	0.08	0.376	0.418
34	WLAN2.4GHz	802.11b 1Mbps	Back	5mm	Full	1	2412	18.10	18.50	1.096	98.6	1.014	-0.05	0.556	0.618



<WLAN5G SAR>

Plot No.	Band	Mode	Test Position	Gap (mm)	Power Reduction	Ch.	Freq. (MHz)	Average Power (dBm)	Tune-Up Limit (dBm)	Tune-up Scaling Factor	Duty Cycle %	Duty Cycle Scaling Factor	Power Drift (dB)	Measured 1g SAR (W/kg)	Reported 1g SAR (W/kg)
	WLAN5.3GHz	802.11a 6Mbps	Front	5mm	Reduced	52	5260	15.02	16.00	1.253	91.12	1.097	-0.08	0.329	0.452
35	WLAN5.3GHz	802.11a 6Mbps	Back	5mm	Reduced	52	5260	15.02	16.00	1.253	91.12	1.097	-0.12	0.846	1.163
	WLAN5.3GHz	802.11a 6Mbps	Back	5mm	Reduced	60	5300	14.60	16.00	1.380	91.12	1.097	0.02	0.724	1.096
	WLAN5.3GHz	802.11a 6Mbps	Front	14mm	Full	52	5260	16.62	17.50	1.225	91.12	1.097	-0.16	0.132	0.177
	WLAN5.3GHz	802.11a 6Mbps	Back	21mm	Full	52	5260	16.62	17.50	1.225	91.12	1.097	-0.07	0.174	0.234
	WLAN5.5GHz	802.11a 6Mbps	Front	5mm	Reduced	100	5500	13.64	15.00	1.368	91.12	1.097	0.16	0.250	0.375
36	WLAN5.5GHz	802.11a 6Mbps	Back	5mm	Reduced	100	5500	13.64	15.00	1.368	91.12	1.097	0.15	0.712	1.068
	WLAN5.5GHz	802.11a 6Mbps	Back	5mm	Reduced	116	5580	13.57	15.00	1.390	91.12	1.097	0.1	0.540	0.823
	WLAN5.5GHz	802.11a 6Mbps	Front	14mm	Full	100	5500	16.04	17.50	1.400	91.12	1.097	-0.04	0.172	0.264
	WLAN5.5GHz	802.11a 6Mbps	Back	21mm	Full	100	5500	16.04	17.50	1.400	91.12	1.097	-0.1	0.174	0.267
	WLAN5.8GHz	802.11a 6Mbps	Front	5mm	Reduced	165	5825	14.07	15.00	1.239	91.12	1.097	0.19	0.207	0.281
	WLAN5.8GHz	802.11a 6Mbps	Back	5mm	Reduced	165	5825	14.07	15.00	1.239	91.12	1.097	0.17	0.617	0.838
37	WLAN5.8GHz	802.11a 6Mbps	Back	5mm	Reduced	149	5745	13.67	15.00	1.358	91.12	1.097	0.17	0.681	1.015
	WLAN5.8GHz	802.11a 6Mbps	Front	14mm	Full	165	5825	16.47	17.50	1.268	91.12	1.097	0.17	0.199	0.277
	WLAN5.8GHz	802.11a 6Mbps	Back	21mm	Full	149	5745	16.07	17.50	1.389	91.12	1.097	-0.03	0.277	0.422

<Bluetooth SAR>

Plot No.	Band	Mode	Test Position	Gap (mm)	Power Reduction	Ch.	Freq. (MHz)	Average Power (dBm)	Tune-Up Limit (dBm)	Tune-up Scaling Factor	Duty Cycle %	Duty Cycle Scaling Factor	Power Drift (dB)	Measured 1g SAR (W/kg)	Reported 1g SAR (W/kg)
	Bluetooth	DH5 1Mbps	Front	5mm	Full	39	2441	5.90	6.00	1.023	77.67	1.287	0.19	0.024	0.032
38	Bluetooth	DH5 1Mbps	Back	5mm	Full	39	2441	5.90	6.00	1.023	77.67	1.287	-0.05	0.031	0.041

16.4 Product specific 10g SAR

<GSM SAR>

Plot No.	Band	Mode	Test Position	Gap (mm)	Power Reduction	Ch.	Freq. (MHz)	Average Power (dBm)	Tune-Up Limit (dBm)	Tune-up Scaling Factor	Power Drift (dB)	Measured 10g SAR (W/kg)	Reported 10g SAR (W/kg)
	GSM850	GPRS(2 Tx slots)	Front	0mm	Full	189	836.4	31.19	32.00	1.205	0.09	1.180	1.422
	GSM850	GPRS(2 Tx slots)	Back	0mm	Full	189	836.4	31.19	32.00	1.205	0.08	1.870	2.253
39	GSM850	GPRS(2 Tx slots)	Back	0mm	Full	128	824.2	31.14	32.00	1.219	0.14	2.180	2.657
	GSM850	GPRS(2 Tx slots)	Back	0mm	Full	251	848.8	31.14	32.00	1.219	-0.08	1.770	2.158
	GSM1900	GPRS(2 Tx slots)	Front	0mm	Reduced	661	1880	27.02	28.50	1.406	0.02	1.210	1.701
	GSM1900	GPRS(2 Tx slots)	Back	0mm	Reduced	661	1880	27.02	28.50	1.406	0.19	1.950	2.742
	GSM1900	GPRS(2 Tx slots)	Back	0mm	Reduced	512	1850.2	27.01	28.50	1.409	0.05	1.720	2.424
40	GSM1900	GPRS(2 Tx slots)	Back	0mm	Reduced	810	1909.8	26.87	28.50	1.455	0.09	2.340	3.406
	GSM1900	GPRS(2 Tx slots)	Bottom Side	0mm	Reduced	661	1880	27.02	28.50	1.406	0.04	1.940	2.728
	GSM1900	GPRS(2 Tx slots)	Bottom Side	0mm	Reduced	512	1850.2	27.01	28.50	1.409	0.08	2.060	2.903
	GSM1900	GPRS(2 Tx slots)	Bottom Side	0mm	Reduced	810	1909.8	26.87	28.50	1.455	0.15	2.010	2.925
	GSM1900	GPRS(2 Tx slots)	Front	8mm	Full	661	1880	27.84	29.50	1.466	-0.04	0.397	0.582
	GSM1900	GPRS(2 Tx slots)	Back	18mm	Full	810	1909.8	27.80	29.50	1.479	0.03	0.149	0.220
	GSM1900	GPRS(2 Tx slots)	Bottom Side	14mm	Full	810	1909.8	27.80	29.50	1.479	0.03	0.261	0.386

<WCDMA SAR>

Plot No.	Band	Mode	Test Position	Gap (mm)	Power Reduction	Ch.	Freq. (MHz)	Average Power (dBm)	Tune-Up Limit (dBm)	Tune-up Scaling Factor	Power Drift (dB)	Measured 10g SAR (W/kg)	Reported 10g SAR (W/kg)
	WCDMA V	RMC 12.2Kbps	Front	0mm	Full	4132	826.4	23.64	24.00	1.086	-0.04	1.070	1.162
	WCDMA V	RMC 12.2Kbps	Back	0mm	Full	4132	826.4	23.64	24.00	1.086	-0.04	1.900	2.064
41	WCDMA V	RMC 12.2Kbps	Back	0mm	Full	4182	836.4	23.59	24.00	1.099	0.14	2.210	2.429
	WCDMA V	RMC 12.2Kbps	Back	0mm	Full	4233	846.6	23.56	24.00	1.107	0.03	2.050	2.269
	WCDMA II	RMC 12.2Kbps	Front	0mm	Reduced	9538	1907.6	21.38	22.00	1.153	0.15	1.550	1.788
	WCDMA II	RMC 12.2Kbps	Back	0mm	Reduced	9538	1907.6	21.38	22.00	1.153	0.07	2.910	3.357
	WCDMA II	RMC 12.2Kbps	Back	0mm	Reduced	9262	1852.4	21.14	22.00	1.219	0.1	2.200	2.682
42	WCDMA II	RMC 12.2Kbps	Back	0mm	Reduced	9400	1880	21.36	22.00	1.159	0.11	3.050	3.534
	WCDMA II	RMC 12.2Kbps	Bottom Side	0mm	Reduced	9538	1907.6	21.38	22.00	1.153	0.07	2.380	2.745
	WCDMA II	RMC 12.2Kbps	Bottom Side	0mm	Reduced	9262	1852.4	21.14	22.00	1.219	-0.12	2.460	2.999
	WCDMA II	RMC 12.2Kbps	Bottom Side	0mm	Reduced	9400	1880	21.36	22.00	1.159	0.11	2.850	3.303
	WCDMA II	RMC 12.2Kbps	Front	8mm	Full	9538	1907.6	23.37	24.00	1.156	0.12	0.700	0.809
	WCDMA II	RMC 12.2Kbps	Back	18mm	Full	9400	1880	23.36	24.00	1.159	-0.05	0.268	0.311
	WCDMA II	RMC 12.2Kbps	Bottom Side	14mm	Full	9400	1880	23.36	24.00	1.159	0.05	0.505	0.585



<FDD LTE SAR>

Plot No.	Band	BW (MHz)	Modulation	RB Size	RB offset	Test Position	Gap (mm)	Power Reduction	Ch.	Freq. (MHz)	Average Power (dBm)	Tune-Up Limit (dBm)	Tune-up Scaling Factor	Power Drift (dB)	Measured 10g SAR (W/kg)	Reported 10g SAR (W/kg)
43	LTE Band 26	15M	QPSK	1	0	Back	0mm	Full	26965	841.5	23.14	24.00	1.219	-0.08	2.100	2.560
	LTE Band 26	15M	QPSK	36	20	Back	0mm	Full	26965	841.5	22.65	23.00	1.084	-0.12	1.540	1.669
	LTE Band 26	15M	QPSK	75	0	Back	0mm	Full	26865	831.5	22.76	23.00	1.057	0.01	0.890	0.941
	LTE Band 2	20M	QPSK	1	0	Front	0mm	Reduced	18900	1880	22.12	23.50	1.374	0.14	1.170	1.608
	LTE Band 2	20M	QPSK	1	0	Back	0mm	Reduced	18900	1880	22.12	23.50	1.374	0.08	1.880	2.583
	LTE Band 2	20M	QPSK	1	0	Back	0mm	Reduced	18700	1860	22.11	23.50	1.377	-0.06	1.900	2.617
	LTE Band 2	20M	QPSK	1	0	Back	0mm	Reduced	19100	1900	21.94	23.50	1.432	0.04	1.780	2.549
	LTE Band 2	20M	QPSK	1	0	Bottom Side	0mm	Reduced	18900	1880	22.12	23.50	1.374	-0.08	1.940	2.666
44	LTE Band 2	20M	QPSK	1	0	Bottom Side	0mm	Reduced	18700	1860	22.11	23.50	1.377	0.15	2.300	3.168
	LTE Band 2	20M	QPSK	1	0	Bottom Side	0mm	Reduced	19100	1900	21.94	23.50	1.432	0.12	1.780	2.549
	LTE Band 2	20M	QPSK	1	0	Front	8mm	Full	18900	1880	22.98	24.00	1.265	-0.13	0.390	0.493
	LTE Band 2	20M	QPSK	1	0	Back	18mm	Full	18700	1860	22.78	24.00	1.324	0.07	0.154	0.204
	LTE Band 2	20M	QPSK	1	0	Bottom Side	14mm	Full	18700	1860	22.78	24.00	1.324	-0.02	0.266	0.352
	LTE Band 2	20M	QPSK	50	0	Front	0mm	Reduced	18900	1880	21.60	22.50	1.230	0.11	1.050	1.292
	LTE Band 2	20M	QPSK	50	0	Back	0mm	Reduced	18900	1880	21.60	22.50	1.230	0.14	1.830	2.251
	LTE Band 2	20M	QPSK	50	0	Back	0mm	Reduced	18700	1860	21.59	22.50	1.233	0.09	1.800	2.220
	LTE Band 2	20M	QPSK	50	0	Back	0mm	Reduced	19100	1900	21.35	22.50	1.303	-0.15	1.750	2.281
	LTE Band 2	20M	QPSK	50	0	Bottom Side	0mm	Reduced	18900	1880	21.60	22.50	1.230	0.15	1.850	2.276
	LTE Band 2	20M	QPSK	50	0	Bottom Side	0mm	Reduced	18700	1860	21.59	22.50	1.233	0.07	1.870	2.306
	LTE Band 2	20M	QPSK	50	0	Bottom Side	0mm	Reduced	19100	1900	21.35	22.50	1.303	0.14	1.630	2.124
	LTE Band 2	20M	QPSK	100	0	Back	0mm	Reduced	18900	1880	21.46	22.50	1.271	0.13	1.740	2.211
	LTE Band 2	20M	QPSK	100	0	Bottom Side	0mm	Reduced	18900	1880	21.46	22.50	1.271	0.05	1.680	2.135
	LTE Band 7	20M	QPSK	1	99	Front	0mm	Reduced	21350	2560	21.75	23.50	1.496	-0.15	0.767	1.148
	LTE Band 7	20M	QPSK	1	99	Back	0mm	Reduced	21350	2560	21.75	23.50	1.496	-0.05	2.290	3.426
	LTE Band 7	20M	QPSK	1	99	Back	0mm	Reduced	20850	2510	21.70	23.50	1.514	0.04	2.120	3.209
45	LTE Band 7	20M	QPSK	1	99	Back	0mm	Reduced	21100	2535	21.73	23.50	1.503	0.09	2.330	3.502
	LTE Band 7	20M	QPSK	1	99	Bottom Side	0mm	Reduced	21350	2560	21.75	23.50	1.496	-0.15	2.110	3.157
	LTE Band 7	20M	QPSK	1	99	Bottom Side	0mm	Reduced	20850	2510	21.70	23.50	1.514	0.05	1.990	3.012
	LTE Band 7	20M	QPSK	1	99	Bottom Side	0mm	Reduced	21100	2535	21.73	23.50	1.503	0.11	2.070	3.112
	LTE Band 7	20M	QPSK	1	99	Front	8mm	Full	21350	2560	22.99	24.00	1.262	-0.03	0.192	0.242
	LTE Band 7	20M	QPSK	1	99	Back	18mm	Full	21100	2535	22.97	24.00	1.268	0.03	0.187	0.237
	LTE Band 7	20M	QPSK	1	99	Bottom Side	14mm	Full	21350	2560	22.99	24.00	1.262	0.05	0.315	0.397
	LTE Band 7	20M	QPSK	50	50	Front	0mm	Reduced	21350	2560	21.35	22.50	1.303	0.11	0.677	0.882
	LTE Band 7	20M	QPSK	50	50	Back	0mm	Reduced	21350	2560	21.35	22.50	1.303	0.08	2.250	2.932
	LTE Band 7	20M	QPSK	50	50	Back	0mm	Reduced	20850	2510	21.24	22.50	1.337	-0.02	2.180	2.914
	LTE Band 7	20M	QPSK	50	50	Back	0mm	Reduced	21100	2535	21.34	22.50	1.306	0.02	2.230	2.913
	LTE Band 7	20M	QPSK	50	50	Bottom Side	0mm	Reduced	21350	2560	21.35	22.50	1.303	0.06	2.100	2.737
	LTE Band 7	20M	QPSK	50	50	Bottom Side	0mm	Reduced	20850	2510	21.24	22.50	1.337	0.17	1.960	2.620
	LTE Band 7	20M	QPSK	50	50	Bottom Side	0mm	Reduced	21100	2535	21.34	22.50	1.306	0.07	2.060	2.691
	LTE Band 7	20M	QPSK	100	0	Back	0mm	Reduced	21350	2560	21.39	22.50	1.291	0.1	2.210	2.854
	LTE Band 7	20M	QPSK	100	0	Bottom Side	0mm	Reduced	21350	2560	21.39	22.50	1.291	0.02	2.110	2.724



<TDD LTE SAR>

Plot No.	Band	BW (MHz)	Modulation	RB Size	RB offset	Test Position	Gap (mm)	Power Reduction	Ch.	Freq. (MHz)	Average Power (dBm)	Tune-Up Limit (dBm)	Tune-up Scaling Factor	Duty Cycle %	Duty Cycle Scaling Factor	Power Drift (dB)	Measured 10g SAR (W/kg)	Reported 10g SAR (W/kg)
	LTE Band 41	20M	QPSK	1	99	Front	0mm	Full	41490	2680	22.77	24.00	1.327	62.9	1.006	-0.08	0.513	0.685
	LTE Band 41	20M	QPSK	1	99	Back	0mm	Full	41490	2680	22.77	24.00	1.327	62.9	1.006	0.12	2.100	2.804
	LTE Band 41	20M	QPSK	1	99	Back	0mm	Full	39750	2506	22.41	24.00	1.442	62.9	1.006	-0.02	1.620	2.350
	LTE Band 41	20M	QPSK	1	99	Back	0mm	Full	40185	2549.5	22.43	24.00	1.435	62.9	1.006	0.05	1.700	2.455
	LTE Band 41	20M	QPSK	1	99	Back	0mm	Full	40620	2593	22.48	24.00	1.419	62.9	1.006	-0.05	1.770	2.527
	LTE Band 41	20M	QPSK	1	99	Back	0mm	Full	41055	2636.5	22.45	24.00	1.429	62.9	1.006	0.13	1.670	2.401
	LTE Band 41	20M	QPSK	1	99	Bottom Side	0mm	Full	41490	2680	22.77	24.00	1.327	62.9	1.006	-0.06	1.290	1.723
	LTE Band 41	20M	QPSK	1	99	Bottom Side	0mm	Full	39750	2506	22.41	24.00	1.442	62.9	1.006	0.09	1.520	2.205
	LTE Band 41	20M	QPSK	1	99	Bottom Side	0mm	Full	40185	2549.5	22.43	24.00	1.435	62.9	1.006	0.08	1.590	2.296
	LTE Band 41	20M	QPSK	1	99	Bottom Side	0mm	Full	40620	2593	22.48	24.00	1.419	62.9	1.006	-0.07	1.650	2.355
	LTE Band 41	20M	QPSK	1	99	Bottom Side	0mm	Full	41055	2636.5	22.45	24.00	1.429	62.9	1.006	0.02	1.460	2.099
	LTE Band 41	20M	QPSK	50	50	Front	0mm	Full	41490	2680	22.75	24.00	1.334	62.9	1.006	0.07	0.527	0.707
46	LTE Band 41	20M	QPSK	50	50	Back	0mm	Full	41490	2680	22.75	24.00	1.334	62.9	1.006	0.11	2.160	2.898
	LTE Band 41	20M	QPSK	50	50	Back	0mm	Full	39750	2506	22.61	24.00	1.377	62.9	1.006	0.05	1.750	2.425
	LTE Band 41	20M	QPSK	50	50	Back	0mm	Full	40185	2549.5	22.52	24.00	1.406	62.9	1.006	0.15	1.810	2.560
	LTE Band 41	20M	QPSK	50	50	Back	0mm	Full	40620	2593	22.53	24.00	1.403	62.9	1.006	0.01	1.920	2.710
	LTE Band 41	20M	QPSK	50	50	Back	0mm	Full	41055	2636.5	22.39	24.00	1.449	62.9	1.006	0.09	1.870	2.725
	LTE Band 41	20M	QPSK	50	50	Bottom Side	0mm	Full	41490	2680	22.75	24.00	1.334	62.9	1.006	0.03	1.430	1.918
	LTE Band 41	20M	QPSK	50	50	Bottom Side	0mm	Full	39750	2506	22.61	24.00	1.377	62.9	1.006	0.11	1.640	2.272
	LTE Band 41	20M	QPSK	50	50	Bottom Side	0mm	Full	40185	2549.5	22.52	24.00	1.406	62.9	1.006	0.05	1.770	2.504
	LTE Band 41	20M	QPSK	50	50	Bottom Side	0mm	Full	40620	2593	22.53	24.00	1.403	62.9	1.006	-0.13	1.810	2.554
	LTE Band 41	20M	QPSK	50	50	Bottom Side	0mm	Full	41055	2636.5	22.39	24.00	1.449	62.9	1.006	0.06	1.760	2.565
	LTE Band 41	20M	QPSK	100	0	Back	0mm	Full	41490	2680	22.69	24.00	1.352	62.9	1.006	0.15	1.870	2.544
	LTE Band 41	20M	QPSK	100	0	Bottom Side	0mm	Full	41490	2680	22.69	24.00	1.352	62.9	1.006	0.02	1.600	2.176

<WLAN5G SAR>

Plot No.	Band	Mode	Test Position	Gap (mm)	Power Reduction	Ch.	Freq. (MHz)	Average Power (dBm)	Tune-Up Limit (dBm)	Tune-up Scaling Factor	Duty Cycle %	Duty Cycle Scaling Factor	Power Drift (dB)	Measured 10g SAR (W/kg)	Reported 10g SAR (W/kg)
	WLAN5.2GHz	802.11a 6Mbps	Back	0mm	Full	36	5180	16.43	17.50	1.278	91.12	1.097	0.19	0.726	1.018
47	WLAN5.2GHz	802.11a 6Mbps	Top Side	0mm	Full	36	5180	16.43	17.50	1.278	91.12	1.097	-0.02	1.210	1.697
	WLAN5.3GHz	802.11a 6Mbps	Front	0mm	Full	52	5260	16.62	17.50	1.225	91.12	1.097	0.06	0.495	0.665
	WLAN5.3GHz	802.11a 6Mbps	Back	0mm	Full	52	5260	16.62	17.50	1.225	91.12	1.097	0.01	0.923	1.240
	WLAN5.3GHz	802.11a 6Mbps	Left Side	0mm	Full	52	5260	16.62	17.50	1.225	91.12	1.097	0.14	0.022	0.030
	WLAN5.3GHz	802.11a 6Mbps	Right Side	0mm	Full	52	5260	16.62	17.50	1.225	91.12	1.097	0.07	0.228	0.306
	WLAN5.3GHz	802.11a 6Mbps	Top Side	0mm	Full	52	5260	16.62	17.50	1.225	91.12	1.097	0.11	1.540	2.069
48	WLAN5.3GHz	802.11a 6Mbps	Top Side	0mm	Full	60	5300	16.20	17.50	1.349	91.12	1.097	-0.03	1.560	2.309
	WLAN5.5GHz	802.11a 6Mbps	Front	0mm	Full	100	5500	16.04	17.50	1.400	91.12	1.097	0.08	0.405	0.622
	WLAN5.5GHz	802.11a 6Mbps	Back	0mm	Full	100	5500	16.04	17.50	1.400	91.12	1.097	0.05	1.040	1.597
	WLAN5.5GHz	802.11a 6Mbps	Left Side	0mm	Full	100	5500	16.04	17.50	1.400	91.12	1.097	0.04	0.024	0.036
	WLAN5.5GHz	802.11a 6Mbps	Right Side	0mm	Full	100	5500	16.04	17.50	1.400	91.12	1.097	0.14	0.192	0.295
49	WLAN5.5GHz	802.11a 6Mbps	Top Side	0mm	Full	100	5500	16.04	17.50	1.400	91.12	1.097	0.04	1.630	2.503
	WLAN5.5GHz	802.11a 6Mbps	Top Side	0mm	Full	116	5580	15.97	17.50	1.422	91.12	1.097	-0.08	1.240	1.935
	WLAN5.8GHz	802.11a 6Mbps	Back	0mm	Full	165	5825	16.47	17.50	1.268	91.12	1.097	0.19	0.430	0.598
50	WLAN5.8GHz	802.11a 6Mbps	Top Side	0mm	Full	165	5825	16.47	17.50	1.268	91.12	1.097	0.08	1.320	1.836



16.5 Repeated SAR Measurement

<1g>

No.	Band	BW (MHz)	Modulation	RB Size	RB offset	Mode	Test Position	Gap (mm)	Power Reduction	Headset	Ch.	Freq. (MHz)	Average Power (dBm)	Tune-Up Limit (dBm)	Tune-up Scaling Factor	Duty Cycle %	Duty Cycle Scaling Factor	Power Drift (dB)	Measured 1g SAR (W/kg)	Ratio	Reported 1g SAR (W/kg)
1st	WLAN2.4GHz	-	-	-	-	802.11b 1Mbps	Left Cheek	0mm	Reduced	-	11	2462	17.00	17.50	1.122	98.6	1.014	-0.02	0.825	1	0.939
2nd	WLAN2.4GHz	-	-	-	-	802.11b 1Mbps	Left Cheek	0mm	Reduced	-	11	2462	17.00	17.50	1.122	98.6	1.014	0.08	0.819	1.007	0.932
1st	GSM850	-	-	-	-	GPRS(2 Tx slots)	Back	5mm	Reduced	-	251	848.8	29.26	30.00	1.186		1.000	0.11	1.180	1	1.399
2nd	GSM850	-	-	-	-	GPRS(2 Tx slots)	Back	5mm	Reduced	-	251	848.8	29.26	30.00	1.186		1.000	0.03	1.120	1.054	1.328
1st	LTE Band 2	20M	QPSK	100	0	-	Back	5mm	Reduced	-	18900	1880	19.56	20.50	1.242		1.000	0.12	1.100	1	1.366
2nd	LTE Band 2	20M	QPSK	100	0	-	Back	5mm	Reduced	-	18900	1880	19.56	20.50	1.242		1.000	0.08	1.060	1.038	1.316
1st	LTE Band 41	20M	QPSK	1	99	-	Bottom Side	5mm	Reduced	-	40185	2549.5	20.04	21.00	1.247	62.9	1.006	-0.05	1.090	1	1.368
2nd	LTE Band 41	20M	QPSK	1	99	-	Bottom Side	5mm	Reduced	-	40185	2549.5	20.04	21.00	1.247	62.9	1.006	0.04	1.060	1.028	1.330
1st	WLAN5.3GHz	-	-	-	-	802.11a 6Mbps	Back	5mm	Reduced	-	52	5260	15.02	16.00	1.253	91.12	1.097	-0.12	0.846	1	1.163
2nd	WLAN5.3GHz	-	-	-	-	802.11a 6Mbps	Back	5mm	Reduced	-	52	5260	15.02	16.00	1.253	91.12	1.097	-0.05	0.839	1.008	1.153

<10g>

No.	Band	BW (MHz)	Modulation	RB Size	RB offset	Mode	Test Position	Gap (mm)	Power Reduction	Ch.	Freq. (MHz)	Average Power (dBm)	Tune-Up Limit (dBm)	Tune-up Scaling Factor	Duty Cycle %	Duty Cycle Scaling Factor	Power Drift (dB)	Measured 10g SAR (W/kg)	Ratio	Reported 10g SAR (W/kg)
1st	WCDMA V	-	-	-	-	RMC 12.2Kbps	Back	0mm	Full	4182	836.4	23.59	24.00	1.099		1.000	0.14	2.210	1	2.429
2nd	WCDMA V	-	-	-	-	RMC 12.2Kbps	Back	0mm	Full	4182	836.4	23.59	24.00	1.099		1.000	0.04	2.180	1.014	2.396
1st	WCDMA II	-	-	-	-	RMC 12.2Kbps	Back	0mm	Reduced	9400	1880	21.36	22.00	1.159		1.000	0.11	3.050	1	3.534
2nd	WCDMA II	-	-	-	-	RMC 12.2Kbps	Back	0mm	Reduced	9400	1880	21.36	22.00	1.159		1.000	0.07	3.010	1.013	3.488
1st	LTE Band 7	20M	QPSK	1	99	-	Back	0mm	Reduced	21100	2535	21.73	23.50	1.503		1.000	0.09	2.330	1	3.502
2nd	LTE Band 7	20M	QPSK	1	99	-	Back	0mm	Reduced	21100	2535	21.73	23.50	1.503		1.000	-0.15	2.290	1.017	3.442

General Note:

- Per KDB 865664 D01v01r04, for each frequency band, repeated SAR measurement is required only when the measured SAR is $\geq 0.8W/kg$.
- Per KDB 865664 D01v01r04, if the ratio among the repeated measurement is ≤ 1.2 and the measured SAR $< 1.45W/kg$, only one repeated measurement is required.
- Per KDB 865664 D01v01r04, if the extremity repeated SAR is necessary, the same procedures should be adapted for measurements according to extremity and occupational exposure limits by applying a factor of 2.5 for extremity exposure and a factor of 5 for occupational exposure to the corresponding SAR thresholds.
- The ratio is the difference in percentage between original and repeated *measured SAR*.
- All measurement SAR result is scaled-up to account for tune-up tolerance and is compliant.

17. Simultaneous Transmission Analysis

No.	Simultaneous Transmission Configurations	Portable Handset			
		Head	Body-worn	Hotspot	Product specific 10g SAR
1.	GSM Voice + WLAN2.4GHz	Yes	Yes		Yes
2.	GPRS/EDGE + WLAN2.4GHz	Yes	Yes	Yes	Yes
3.	WCDMA + WLAN2.4GHz	Yes	Yes	Yes	Yes
4.	LTE + WLAN2.4GHz	Yes	Yes	Yes	Yes
5.	GSM Voice + WLAN5.3/5.5GHz	Yes	Yes		Yes
6.	GPRS/EDGE + WLAN5.3/5.5GHz	Yes	Yes		Yes
7.	WCDMA + WLAN5.3/5.5GHz	Yes	Yes		Yes
8.	LTE + WLAN5.3/5.5GHz	Yes	Yes		Yes
9.	GSM Voice + WLAN5.2/5.8GHz	Yes	Yes		Yes
10.	GPRS/EDGE + WLAN5.2/5.8GHz	Yes	Yes	Yes	Yes
11.	WCDMA + WLAN5.2/5.8GHz	Yes	Yes	Yes	Yes
12.	LTE + WLAN5.2/5.8GHz	Yes	Yes	Yes	Yes
13.	GSM Voice + Bluetooth	Yes	Yes		Yes
14.	GPRS/EDGE + Bluetooth	Yes	Yes	Yes	Yes
15.	WCDMA + Bluetooth	Yes	Yes	Yes	Yes
16.	LTE + Bluetooth	Yes	Yes	Yes	Yes

General Note:

- This device supports VoIP in GPRS, EGPRS, WCDMA, and LTE (e.g. for 3rd-party VoIP), LTE supports VoLTE operation.
- EUT will choose each GSM, WCDMA and LTE according to the network signal condition; therefore, they will not operate simultaneously at any moment.
- This device 2.4GHz WLAN support hotspot operation and Bluetooth support tethering applications.
- This device 2.4GHz WLAN/ 5.2GHz WLAN/5.8GHz WLAN support hotspot operation, and 5.2GHz WLAN/5.8GHz WLAN supports WLAN Direct (GC/GO), and 5.3GHz / 5.5GHz supports WLAN Direct (GC only).
- EUT will choose either WLAN 2.4GHz or WLAN 5GHz according to the network signal condition; therefore, 2.4GHz WLAN and 5GHz WLAN will not operate simultaneously at any moment though they have independent antenna.
- WLAN 2.4GHz and Bluetooth share the same antenna so can't transmit simultaneously.
- According to the EUT character, WLAN 5GHz and Bluetooth can't transmit simultaneously.
- Chose the worst zoom scan SAR of WLAN correspondingly for co-located with WWAN analysis.
- The reported SAR summation is calculated based on the same configuration and test position.
- Per KDB 447498 D01v06, simultaneous transmission SAR is compliant if,
 - 1g Scalar SAR summation < 1.6W/kg and 10g Scalar SAR summation < 4.0W/kg.
 - $SPLSR = (SAR1 + SAR2)^{1.5} / (\min. \text{ separation distance, mm})$, and the peak separation distance is determined from the square root of $[(x1-x2)^2 + (y1-y2)^2 + (z1-z2)^2]$, where (x1, y1, z1) and (x2, y2, z2) are the coordinates of the extrapolated peak SAR locations in the zoom scan.
 - If $SPLSR \leq 0.04$ for 1g SAR and $SPLSR \leq 0.10$ for 10g SAR, simultaneously transmission SAR measurement is not necessary.
 - Simultaneously transmission SAR measurement, and the reported multi-band 1g SAR < 1.6W/kg and 10g SAR < 4.0W/kg.
 - The SPLSR calculated results please refer to section 17.5.



17.1 Head Exposure Conditions

WWAN Band	Exposure Position	1	2	4	6	1+2 Summed 1g SAR (W/kg)	1+4 Summed 1g SAR (W/kg)	Case No	SPLSR	1+6 Summed 1g SAR (W/kg)	
		WWAN	2.4GHz WLAN	5GHz WLAN	Bluetooth						
		1g SAR (W/kg)	1g SAR (W/kg)	1g SAR (W/kg)	1g SAR (W/kg)						
GSM	GSM850	Right Cheek	0.569	0.271	0.909	0.033	0.84	1.48			0.60
		Right Tilted	0.299	0.305	0.951	0.034	0.60	1.25			0.33
		Left Cheek	0.522	0.939	1.190	0.066	1.46	1.71	#01	0.03	0.59
		Left Tilted	0.295	0.507	1.007	0.050	0.80	1.30			0.35
	GSM1900	Right Cheek	0.191	0.271	0.909	0.033	0.46	1.10			0.22
		Right Tilted	0.164	0.305	0.951	0.034	0.47	1.12			0.20
		Left Cheek	0.293	0.939	1.190	0.066	1.23	1.48			0.36
		Left Tilted	0.195	0.507	1.007	0.050	0.70	1.20			0.25
WCDMA	WCDMA V	Right Cheek	0.313	0.271	0.909	0.033	0.58	1.22			0.35
		Right Tilted	0.215	0.305	0.951	0.034	0.52	1.17			0.25
		Left Cheek	0.297	0.939	1.190	0.066	1.24	1.49			0.36
		Left Tilted	0.174	0.507	1.007	0.050	0.68	1.18			0.22
	WCDMA II	Right Cheek	0.194	0.271	0.909	0.033	0.47	1.10			0.23
		Right Tilted	0.142	0.305	0.951	0.034	0.45	1.09			0.18
		Left Cheek	0.348	0.939	1.190	0.066	1.29	1.54			0.41
		Left Tilted	0.199	0.507	1.007	0.050	0.71	1.21			0.25
LTE	LTE Band 26	Right Cheek	0.475	0.271	0.909	0.033	0.75	1.38			0.51
		Right Tilted	0.223	0.305	0.951	0.034	0.53	1.17			0.26
		Left Cheek	0.354	0.939	1.190	0.066	1.29	1.54			0.42
		Left Tilted	0.231	0.507	1.007	0.050	0.74	1.24			0.28
	LTE Band 2	Right Cheek	0.416	0.271	0.909	0.033	0.69	1.33			0.45
		Right Tilted	0.278	0.305	0.951	0.034	0.58	1.23			0.31
		Left Cheek	0.452	0.939	1.190	0.066	1.39	1.64	#02	0.02	0.52
		Left Tilted	0.390	0.507	1.007	0.050	0.90	1.40			0.44
	LTE Band 7	Right Cheek	0.058	0.271	0.909	0.033	0.33	0.97			0.09
		Right Tilted	0.024	0.305	0.951	0.034	0.33	0.98			0.06
		Left Cheek	0.138	0.939	1.190	0.066	1.08	1.33			0.20
		Left Tilted	0.053	0.507	1.007	0.050	0.56	1.06			0.10
	LTE Band 41	Right Cheek	0.041	0.271	0.909	0.033	0.31	0.95			0.07
		Right Tilted	0.034	0.305	0.951	0.034	0.34	0.99			0.07
		Left Cheek	0.069	0.939	1.190	0.066	1.01	1.26			0.14
		Left Tilted	0.034	0.507	1.007	0.050	0.54	1.04			0.08



17.2 Hotspot Exposure Conditions

WWAN Band	Exposure Position	1	2	4	6	1+2 Summed 1g SAR (W/kg)	Case No	SPLSR	1+4 Summed 1g SAR (W/kg)	Case No	SPLSR	1+6 Summed 1g SAR (W/kg)	
		WWAN	2.4GHz WLAN	5GHz WLAN	Bluetooth								
		1g SAR (W/kg)	1g SAR (W/kg)	1g SAR (W/kg)	1g SAR (W/kg)								
GSM	GSM850	Front	0.669	0.418	0.281	0.032	1.09			0.95			0.70
		Back	1.399	0.618	1.015	0.041	2.02	#03	0.02	2.41	#11	0.03	1.44
		Left side	0.473	0.091	0.035	0.007	0.56			0.51			0.48
		Right side	0.732	0.445	0.169	0.037	1.18			0.90			0.77
		Top side		0.345	0.994	0.026	0.35			0.99			0.03
		Bottom side	0.307				0.31			0.31			0.31
	GSM1900	Front	1.041	0.418	0.281	0.032	1.46			1.32			1.07
		Back	1.300	0.618	1.015	0.041	1.92	#04	0.02	2.32	#12	0.02	1.34
		Left side	0.314	0.091	0.035	0.007	0.41			0.35			0.32
		Right side	0.134	0.445	0.169	0.037	0.58			0.30			0.17
		Top side		0.345	0.994	0.026	0.35			0.99			0.03
		Bottom side	1.152				1.15			1.15			1.15
WCDMA	WCDMA V	Front	0.603	0.418	0.281	0.032	1.02			0.88			0.64
		Back	1.330	0.618	1.015	0.041	1.95	#05	0.02	2.35	#13	0.02	1.37
		Left side	0.402	0.091	0.035	0.007	0.49			0.44			0.41
		Right side	0.626	0.445	0.169	0.037	1.07			0.80			0.66
		Top side		0.345	0.994	0.026	0.35			0.99			0.03
		Bottom side	0.253				0.25			0.25			0.25
	WCDMA II	Front	1.051	0.418	0.281	0.032	1.47			1.33			1.08
		Back	1.310	0.618	1.015	0.041	1.93	#06	0.02	2.33	#14	0.02	1.35
		Left side	0.418	0.091	0.035	0.007	0.51			0.45			0.43
		Right side	0.136	0.445	0.169	0.037	0.58			0.31			0.17
		Top side		0.345	0.994	0.026	0.35			0.99			0.03
		Bottom side	1.310				1.31			1.31			1.31
LTE	LTE Band 26	Front	0.727	0.418	0.281	0.032	1.15			1.01			0.76
		Back	1.317	0.618	1.015	0.041	1.94	#07	0.02	2.33	#15	0.02	1.36
		Left side	0.266	0.091	0.035	0.007	0.36			0.30			0.27
		Right side	0.413	0.445	0.169	0.037	0.86			0.58			0.45
		Top side		0.345	0.994	0.026	0.35			0.99			0.03
		Bottom side	0.139				0.14			0.14			0.14
	LTE Band 2	Front	0.874	0.418	0.281	0.032	1.29			1.16			0.91
		Back	1.366	0.618	1.015	0.041	1.98	#08	0.02	2.38	#16	0.02	1.41
		Left side	0.273	0.091	0.035	0.007	0.36			0.31			0.28
		Right side	0.129	0.445	0.169	0.037	0.57			0.30			0.17
		Top side		0.345	0.994	0.026	0.35			0.99			0.03
		Bottom side	1.253				1.25			1.25			1.25
	LTE Band 7	Front	0.449	0.418	0.281	0.032	0.87			0.73			0.48
		Back	1.342	0.618	1.015	0.041	1.96	#09	0.02	2.36	#17	0.02	1.38
		Left side	0.115	0.091	0.035	0.007	0.21			0.15			0.12
		Right side	0.097	0.445	0.169	0.037	0.54			0.27			0.13
		Top side		0.345	0.994	0.026	0.35			0.99			0.03
		Bottom side	1.335				1.34			1.34			1.34
	LTE Band 41	Front	0.423	0.418	0.281	0.032	0.84			0.70			0.46
		Back	1.215	0.618	1.015	0.041	1.83	#10	0.02	2.23	#18	0.02	1.26
		Left side	0.071	0.091	0.035	0.007	0.16			0.11			0.08
		Right side	0.098	0.445	0.169	0.037	0.54			0.27			0.14
		Top side		0.345	0.994	0.026	0.35			0.99			0.03
		Bottom side	1.368				1.37			1.37			1.37



17.3 Body-Worn Accessory Exposure Conditions

WWAN Band	Exposure Position	1	2	4	6	1+2	Case	SPLSR	1+4	Case	SPLSR	1+6	
		WWAN 1g SAR (W/kg)	2.4GHz WLAN 1g SAR (W/kg)	5GHz WLAN 1g SAR (W/kg)	Bluetooth 1g SAR (W/kg)	Summed 1g SAR (W/kg)	No		Summed 1g SAR (W/kg)	No		Summed 1g SAR (W/kg)	
GSM	GSM850	Front	0.669	0.418	0.452	0.032	1.09			1.12			0.70
		Back	1.399	0.618	1.163	0.041	2.02	#03	0.02	2.56	#19	0.03	1.44
		Front with Headset					0.00			0.00			0.00
		Back with Headset	1.375				1.38			1.38			1.38
	GSM1900	Front	1.041	0.418	0.452	0.032	1.46			1.49			1.07
		Back	1.300	0.618	1.163	0.041	1.92	#04	0.02	2.46	#20	0.02	1.34
		Front with Headset					0.00			0.00			0.00
		Back with Headset	1.285				1.29			1.29			1.29
WCDMA	WCDMA V	Front	0.603	0.418	0.452	0.032	1.02			1.06			0.64
		Back	1.330	0.618	1.163	0.041	1.95	#05	0.02	2.49	#21	0.02	1.37
		Front with Headset					0.00			0.00			0.00
		Back with Headset	1.296				1.30			1.30			1.30
	WCDMA II	Front	1.051	0.418	0.452	0.032	1.47			1.50			1.08
		Back	1.310	0.618	1.163	0.041	1.93	#06	0.02	2.47	#22	0.02	1.35
		Front with Headset					0.00			0.00			0.00
		Back with Headset	1.188				1.19			1.19			1.19
LTE	LTE Band 26	Front	0.727	0.418	0.452	0.032	1.15			1.18			0.76
		Back	1.317	0.618	1.163	0.041	1.94	#07	0.02	2.48	#23	0.02	1.36
		Front with Headset					0.00			0.00			0.00
		Back with Headset	1.304				1.30			1.30			1.30
	LTE Band 2	Front	0.874	0.418	0.452	0.032	1.29			1.33			0.91
		Back	1.366	0.618	1.163	0.041	1.98	#08	0.02	2.53	#24	0.02	1.41
		Front with Headset					0.00			0.00			0.00
		Back with Headset	1.266				1.27			1.27			1.27
	LTE Band 7	Front	0.449	0.418	0.452	0.032	0.87			0.90			0.48
		Back	1.342	0.618	1.163	0.041	1.96	#09	0.02	2.51	#25	0.02	1.38
		Front with Headset					0.00			0.00			0.00
		Back with Headset	1.288				1.29			1.29			1.29
	LTE Band 41	Front	0.423	0.418	0.452	0.032	0.84			0.88			0.46
		Back	1.215	0.618	1.163	0.041	1.83	#10	0.02	2.38	#26	0.02	1.26
		Front with Headset					0.00			0.00			0.00
		Back with Headset	1.264				1.26			1.26			1.26



17.4 Product specific 10g SAR Exposure Conditions

WWAN Band		Exposure Position	1	4	1+4 Summed 10g SAR (W/kg)	Case No	SPLSR
			WWAN 10g SAR (W/kg)	5GHz WLAN 10g SAR (W/kg)			
GSM	GSM850	Front	1.422	0.665	2.09		
		Back	2.657	1.597	4.25	#27	0.06
		Left side		0.036	0.04		
		Right side		0.306	0.31		
		Top side		2.503	2.50		
		Bottom side			0.00		
	GSM1900	Front	1.701	0.665	2.37		
		Back	3.406	1.597	5.00	#28	0.07
		Left side		0.036	0.04		
		Right side		0.306	0.31		
		Top side		2.503	2.50		
		Bottom side	2.925		2.93		
WCDMA	WCDMA V	Front	1.162	0.665	1.83		
		Back	2.429	1.597	4.03	#29	0.05
		Left side		0.036	0.04		
		Right side		0.306	0.31		
		Top side		2.503	2.50		
		Bottom side			0.00		
	WCDMA II	Front	1.788	0.665	2.45		
		Back	3.534	1.597	5.13	#30	0.07
		Left side		0.036	0.04		
		Right side		0.306	0.31		
		Top side		2.503	2.50		
		Bottom side	3.303		3.30		
LTE	LTE Band 26	Front		0.665	0.67		
		Back	2.560	1.597	4.16	#31	0.05
		Left side		0.036	0.04		
		Right side		0.306	0.31		
		Top side		2.503	2.50		
		Bottom side			0.00		
	LTE Band 2	Front	1.608	0.665	2.27		
		Back	2.617	1.597	4.21	#32	0.06
		Left side		0.036	0.04		
		Right side		0.306	0.31		
		Top side		2.503	2.50		
		Bottom side	3.168		3.17		
	LTE Band 7	Front	1.148	0.665	1.81		
		Back	3.502	1.597	5.10	#33	0.07
		Left side		0.036	0.04		
		Right side		0.306	0.31		
		Top side		2.503	2.50		
		Bottom side	3.157		3.16		
	LTE Band 41	Front	0.707	0.665	1.37		
		Back	2.898	1.597	4.50	#34	0.06
		Left side		0.036	0.04		
		Right side		0.306	0.31		
		Top side		2.503	2.50		
		Bottom side	2.565		2.57		

Remark:

1. For Bluetooth Product specific 10g stand-alone SAR is not required for a transmitter or antenna, due to 1g hotspot SAR is <1.2W/kg.
2. If SPLSR ≤ 0.10 for 10g SAR, simultaneously transmission SAR measurement is not necessary.

17.5 SPLSR Evaluation and Analysis

General Note:

1. When standalone SAR is measured for both antennas in the pair, the peak location separation distance is computed by the square root of $[(x1-x2)^2 + (y1-y2)^2 + (z1-z2)^2]$, where $(x1, y1, z1)$ and $(x2, y2, z2)$ are the coordinates in the area scans or extrapolated peak SAR locations in the zoom scans, as appropriate.
2. $SPLSR = (SAR1 + SAR2)1.5 / (\text{min. separation distance, mm})$. If $SPLSR \leq 0.04$ for 1g SAR and $SPLSR \leq 0.10$ for 10g SAR, simultaneously transmission SAR measurement is not necessary.

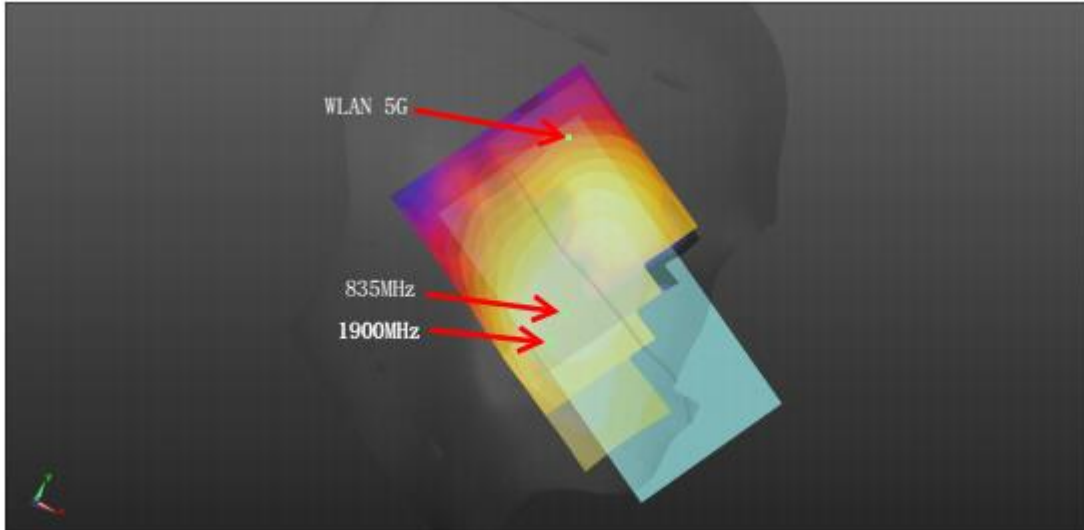

Head for WWAN+WLAN5GHz _0mm

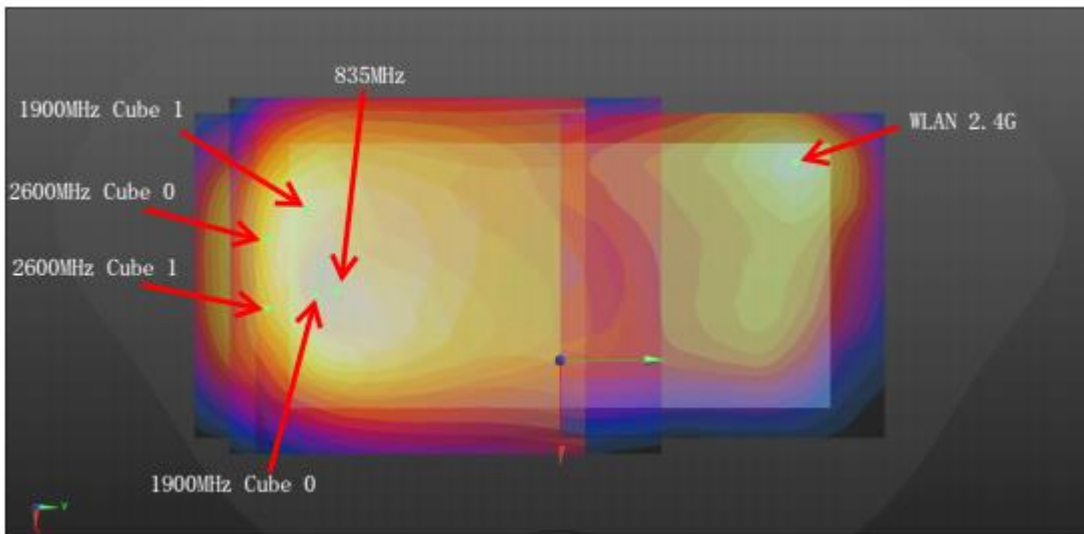

Back for WWAN+WLAN2.4GHz _5mm

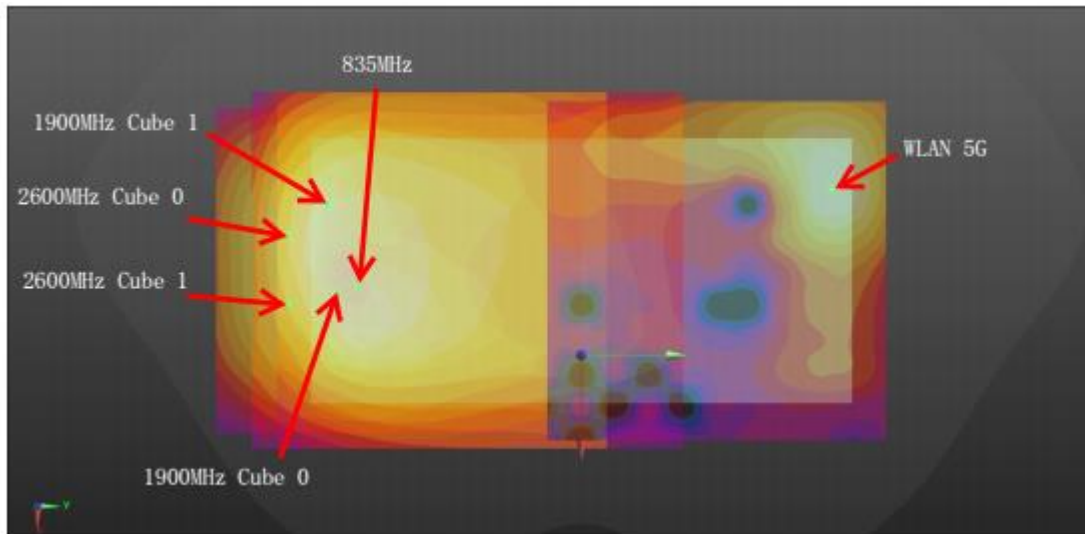

Back for WWAN+WLAN5GHz_5mm

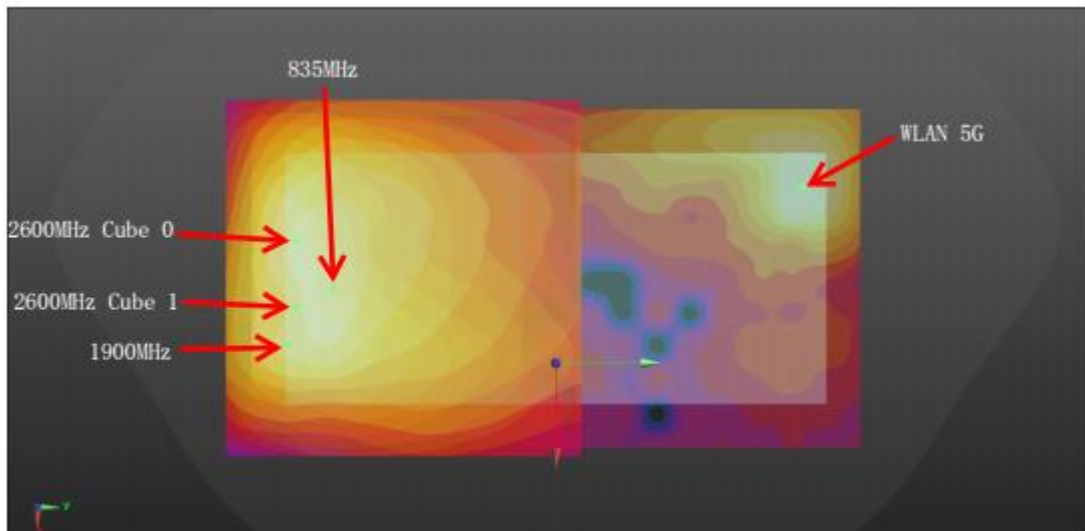

Back for WWAN+WLAN5GHz_0mm



Head WWAN+WLAN5GHz

Case 1	Band	Position	SAR (W/kg)	Gap (mm)	SAR peak location (m)			3D distance (mm)	Summed SAR (W/kg)	SPLSR Results	Simultaneous SAR
					X	Y	Z				
					GSM850	Left Cheek	0.522				
WLAN5GHz	1.19	0	0.0218	0.334	-0.175						

Case 2	Band	Position	SAR (W/kg)	Gap (mm)	SAR peak location (m)			3D distance (mm)	Summed SAR (W/kg)	SPLSR Results	Simultaneous SAR
					X	Y	Z				
					LTE Band 2	Left Cheek	0.452				
WLAN5GHz	1.19	0	0.0218	0.334	-0.175						

Hotspot/Body 5mm WWAN+WLAN2.4GHz

Case 3	Band	Position	SAR (W/kg)	Gap (mm)	SAR peak location (m)			3D distance (mm)	Summed SAR (W/kg)	SPLSR Results	Simultaneous SAR
					X	Y	Z				
					GSM850	Back	1.399				
WLAN2.4GHz	0.618	5	-0.0586	0.0696	-0.209						

Case 4	Band	Position	SAR (W/kg)	Gap (mm)	SAR peak location (m)			3D distance (mm)	Summed SAR (W/kg)	SPLSR Results	Simultaneous SAR
					X	Y	Z				
					GSM1900	Back	1.3				
WLAN2.4GHz	0.618	5	-0.0586	0.0696	-0.209						

Case 5	Band	Position	SAR (W/kg)	Gap (mm)	SAR peak location (m)			3D distance (mm)	Summed SAR (W/kg)	SPLSR Results	Simultaneous SAR
					X	Y	Z				
					WCDMA V	Back	1.33				
WLAN2.4GHz	0.618	5	-0.0586	0.0696	-0.209						

Case 6	Band	Position	SAR (W/kg)	Gap (mm)	SAR peak location (m)			3D distance (mm)	Summed SAR (W/kg)	SPLSR Results	Simultaneous SAR
					X	Y	Z				
	WCDMA II Cube 0	Back	1.31	5	-0.019	-0.08	-0.209	154.8	1.93	0.02	Not required
	WLAN2.4GHz		0.618	5	-0.0586	0.0696	-0.209				
WCDMA II Cube 1	Back	1.128	5	-0.0365	-0.075	-0.209	146.3	1.75	0.02	Not required	
WLAN2.4GHz		0.618	5	-0.0586	0.0696	-0.209					

Case 7	Band	Position	SAR (W/kg)	Gap (mm)	SAR peak location (m)			3D distance (mm)	Summed SAR (W/kg)	SPLSR Results	Simultaneous SAR
					X	Y	Z				
					LTE Band 26	Back	1.317				
WLAN2.4GHz	0.618	5	-0.0586	0.0696	-0.209						

Case 8	Band	Position	SAR (W/kg)	Gap (mm)	SAR peak location (m)			3D distance (mm)	Summed SAR (W/kg)	SPLSR Results	Simultaneous SAR
					X	Y	Z				
					LTE Band 2	Back	1.366				
WLAN2.4GHz	0.618	5	-0.0586	0.0696	-0.209						

Case 9	Band	Position	SAR (W/kg)	Gap (mm)	SAR peak location (m)			3D distance (mm)	Summed SAR (W/kg)	SPLSR Results	Simultaneous SAR
					X	Y	Z				
	LTE Band 7 Cube 0	Back	1.342	5	-0.0358	-0.0864	-0.209	157.7	1.96	0.02	Not required
	WLAN2.4GHz		0.618	5	-0.0586	0.0696	-0.209				
LTE Band 7 Cube 1	Back	1.166	5	-0.0304	-0.0864	-0.209	158.5	1.78	0.02	Not required	
WLAN2.4GHz		0.618	5	-0.0586	0.0696	-0.209					

Case 10	Band	Position	SAR (W/kg)	Gap (mm)	SAR peak location (m)			3D distance (mm)	Summed SAR (W/kg)	SPLSR Results	Simultaneous SAR
					X	Y	Z				
	LTE Band 41 Cube 0	Back	1.215	5	-0.0394	-0.09	-0.209	160.8	1.83	0.02	Not required
	WLAN2.4GHz		0.618	5	-0.0586	0.0696	-0.209				
LTE Band 41 Cube 1	Back	1.029	5	-0.0316	-0.09	-0.209	161.9	1.65	0.01	Not required	
WLAN2.4GHz		0.618	5	-0.0586	0.0696	-0.209					



Hotspot/Body 5mm WWAN+WLAN5GHz											
Case	Band	Position	SAR (W/kg)	Gap (mm)	SAR peak location (m)			3D distance (mm)	Summed SAR (W/kg)	SPLSR Results	Simultaneous SAR
					X	Y	Z				
Case 11	GSM850	Back	1.399	5	-0.0205	-0.066	-0.209	148.2	2.41	0.03	Not required
	WLAN5GHz		1.015	5	-0.046	0.08	-0.209				
Case 12	GSM1900	Back	1.3	5	-0.0085	-0.0705	-0.209	155.1	2.32	0.02	Not required
	WLAN5GHz		1.015	5	-0.046	0.08	-0.209				
Case 13	WCDMA V	Back	1.33	5	-0.023	-0.0805	-0.208	162.1	2.35	0.02	Not required
	WLAN5GHz		1.015	5	-0.046	0.08	-0.209				
Case 14	WCDMA II Cube 0	Back	1.31	5	-0.019	-0.08	-0.209	162.3	2.33	0.02	Not required
	WLAN5GHz		1.015	5	-0.046	0.08	-0.209				
	WCDMA II Cube 1	Back	1.128	5	-0.0365	-0.075	-0.209	155.3	2.14	0.02	Not required
	WLAN5GHz		1.015	5	-0.046	0.08	-0.209				
Case 15	LTE Band 26	Back	1.317	5	-0.022	-0.078	-0.209	159.8	2.33	0.02	Not required
	WLAN5GHz		1.015	5	-0.046	0.08	-0.209				
Case 16	LTE Band 2	Back	1.366	5	-0.019	-0.078	-0.209	160.3	2.38	0.02	Not required
	WLAN5GHz		1.015	5	-0.046	0.08	-0.209				
Case 17	LTE Band 7 Cube 0	Back	1.342	5	-0.0358	-0.0864	-0.209	166.7	2.36	0.02	Not required
	WLAN5GHz		1.015	5	-0.046	0.08	-0.209				
	LTE Band 7 Cube 1	Back	1.166	5	-0.0304	-0.0864	-0.209	167.1	2.18	0.02	Not required
	WLAN5GHz		1.015	5	-0.046	0.08	-0.209				
Case 18	LTE Band 41 Cube 0	Back	1.215	5	-0.0394	-0.09	-0.209	170.1	2.23	0.02	Not required
	WLAN5GHz		1.015	5	-0.046	0.08	-0.209				
	LTE Band 41 Cube 1	Back	1.023	5	-0.0316	-0.09	-0.209	170.6	2.04	0.02	Not required
	WLAN5GHz		1.015	5	-0.046	0.08	-0.209				
Case 19	GSM850	Back	1.399	5	-0.0205	-0.066	-0.209	149.2	2.56	0.03	Not required
	WLAN5GHz		1.163	5	-0.046	0.081	-0.209				
Case 20	GSM1900	Back	1.300	5	-0.0085	-0.0705	-0.209	156.1	2.46	0.02	Not required
	WLAN5GHz		1.163	5	-0.046	0.081	-0.209				



Case	Band	Position	SAR (W/kg)	Gap (mm)	SAR peak location (m)			3D distance (mm)	Summed SAR (W/kg)	SPLSR Results	Simultaneous SAR
					X	Y	Z				
Case 21	WCDMA V	Back	1.330	5	-0.023	-0.0805	-0.208	163.1	2.49	0.02	Not required
	WLAN5GHz		1.163	5	-0.046	0.081	-0.209				
Case 22	WCDMA II Cube 0	Back	1.31	5	-0.019	-0.08	-0.209	163.2	2.47	0.02	Not required
	WLAN5GHz		1.163	5	-0.046	0.081	-0.209				
	WCDMA II Cube 1	Back	1.128	5	-0.0365	-0.075	-0.209	156.3	2.29	0.02	Not required
	WLAN5GHz		1.163	5	-0.046	0.081	-0.209				
Case 23	LTE Band 26	Back	1.317	5	-0.022	-0.078	-0.209	160.8	2.48	0.02	Not required
	WLAN5GHz		1.163	5	-0.046	0.081	-0.209				
Case 24	LTE Band 2	Back	1.366	5	-0.019	-0.078	-0.209	161.3	2.53	0.02	Not required
	WLAN5GHz		1.163	5	-0.046	0.081	-0.209				
Case 25	LTE Band 7 Cube 0	Back	1.342	5	-0.0358	-0.0864	-0.209	167.7	2.51	0.02	Not required
	WLAN5GHz		1.163	5	-0.046	0.081	-0.209				
	LTE Band 7 Cube 1	Back	1.166	5	-0.0304	-0.0864	-0.209	168.1	2.33	0.02	Not required
	WLAN5GHz		1.163	5	-0.046	0.081	-0.209				
Case 26	LTE Band 41 Cube 0	Back	1.215	5	-0.0394	-0.09	-0.209	171.1	2.38	0.02	Not required
	WLAN5GHz		1.163	5	-0.046	0.081	-0.209				
	LTE Band 41 Cube 1	Back	1.023	5	-0.0316	-0.09	-0.209	171.6	2.19	0.02	Not required
	WLAN5GHz		1.163	5	-0.046	0.081	-0.209				
Extremity 0mm WWAN+WLAN5GHz											
Case 27	GSM850	Back	2.657	0	-0.038	-0.074	-0.209	148.4	4.25	0.06	Not required
	WLAN5GHz		1.597	0	-0.049	0.074	-0.209				
Case 28	GSM1900	Back	3.406	0	-0.0095	-0.078	-0.209	157.0	5.00	0.07	Not required
	WLAN5GHz		1.597	0	-0.049	0.074	-0.209				
Case 29	WCDMA V	Back	2.429	0	-0.0325	-0.081	-0.209	155.9	4.03	0.05	Not required
	WLAN5GHz		1.597	0	-0.049	0.074	-0.209				
Case 30	WCDMA II	Back	3.534	0	-0.0055	-0.0795	-0.209	159.5	5.13	0.07	Not required
	WLAN5GHz		1.597	0	-0.049	0.074	-0.209				



Case	Band	Position	SAR (W/kg)	Gap (mm)	SAR peak location (m)			3D distance (mm)	Summed SAR (W/kg)	SPLSR Results	Simultaneous SAR
					X	Y	Z				
Case 31	LTE Band 26	Back	2.560	0	-0.0325	-0.0795	-0.209	154.4	4.16	0.05	Not required
	WLAN5GHz		1.597	0	-0.049	0.074	-0.209				
Case 32	LTE Band 2	Back	2.617	0	-0.0095	-0.078	-0.209	157.0	4.21	0.06	Not required
	WLAN5GHz		1.597	0	-0.049	0.074	-0.209				
Case 33	LTE Band 7	Back	3.502	0	-0.0142	-0.084	-0.209	161.8	5.10	0.07	Not required
	WLAN5GHz		1.597	0	-0.049	0.074	-0.209				
Case 34	LTE Band 41 Cube 0	Back	2.898	0	-0.0216	-0.0768	-0.209	153.3	4.50	0.06	Not required
	WLAN5GHz		1.597	0	-0.049	0.074	-0.209				
	LTE Band 41 Cube 1	Back	2.203	0	-0.0258	-0.0768	-0.209	152.6	3.80	0.05	Not required
	WLAN5GHz		1.597	0	-0.049	0.074	-0.209				

Test Engineer : Changlin Huang, Bin He, Mengming Dai



18. Uncertainty Assessment

Per KDB 865664 D01 SAR measurement 100MHz to 6GHz, when the highest measured 1-g SAR within a frequency band is < 1.5 W/kg and the measured 10-g SAR within a frequency band is < 3.75 W/kg. The expanded SAR measurement uncertainty must be $\leq 30\%$, for a confidence interval of $k = 2$. If these conditions are met, extensive SAR measurement uncertainty analysis described in IEEE Std 1528-2013 is not required in SAR reports submitted for equipment approval. For this device, the highest measured 1-g SAR is less 1.5W/kg and highest measured 10-g SAR is less 3.75W/kg. Therefore, the measurement uncertainty table is not required in this report.

19. References

- [1] FCC 47 CFR Part 2 “Frequency Allocations and Radio Treaty Matters; General Rules and Regulations”
- [2] ANSI/IEEE Std. C95.1-1992, “IEEE Standard for Safety Levels with Respect to Human Exposure to Radio Frequency Electromagnetic Fields, 3 kHz to 300 GHz”, September 1992
- [3] IEEE Std. 1528-2013, “IEEE Recommended Practice for Determining the Peak Spatial-Average Specific Absorption Rate (SAR) in the Human Head from Wireless Communications Devices: Measurement Techniques”, Sep 2013
- [4] SPEAG DASY System Handbook
- [5] FCC KDB 865664 D01 v01r04, "SAR Measurement Requirements for 100 MHz to 6 GHz", Aug 2015.
- [6] FCC KDB 865664 D02 v01r02, “RF Exposure Compliance Reporting and Documentation Considerations” Oct 2015.
- [7] FCC KDB 447498 D01 v06, “Mobile and Portable Device RF Exposure Procedures and Equipment Authorization Policies”, Oct 2015
- [8] FCC KDB 648474 D04 v01r03, “SAR Evaluation Considerations for Wireless Handsets”, Oct 2015.
- [9] FCC KDB 248227 D01 v02r02, “SAR Guidance for IEEE 802.11 (WiFi) Transmitters”, Oct 2015.
- [10] FCC KDB 616217 D04 v01r02, “SAR Evaluation Considerations for Laptop, Notebook, Netbook and Tablet Computers”, Oct 2015
- [11] FCC KDB 941225 D01 v03r01, “3G SAR MEAUREMENT PROCEDURES”, Oct 2015
- [12] FCC KDB 941225 D05 v02r05, “SAR Evaluation Considerations for LTE Devices”, Dec 2015
- [13] FCC KDB 941225 D06 v02r01, "SAR Evaluation Procedures for Portable Devices with Wireless Router Capabilities", Oct 2015.

-----THE END-----



Appendix A. Plots of System Performance Check

The plots are shown as follows.

System Check_Head_835MHz

DUT: D835V2-SN:4d162

Communication System: UID 0, CW; Frequency: 835 MHz; Duty Cycle: 1:1
Medium: HSL_835_210123 Medium parameters used: $f = 835 \text{ MHz}$; $\sigma = 0.91 \text{ S/m}$; $\epsilon_r = 42.776$; $\rho = 1000 \text{ kg/m}^3$
Ambient Temperature : 23.3 °C; Liquid Temperature : 22.4 °C

DASY5 Configuration:

- Probe: EX3DV4 - SN7577; ConvF(9.54, 9.54, 9.54); Calibrated: 2020.09.30
- Sensor-Surface: 1.4mm (Mechanical Surface Detection)
- Electronics: DAE4 Sn715; Calibrated: 2020.07.27
- Phantom: Twin-SAM1(P1aP2a20); Type: QD 000 P40 CD; Serial: TP:1670
- Measurement SW: DASY52, Version 52.10 (3); SEMCAD X Version 14.6.13 (7474)

Pin=250mW/Area Scan (61x61x1): Interpolated grid: $dx=1.500 \text{ mm}$, $dy=1.500 \text{ mm}$
Maximum value of SAR (interpolated) = 3.19 W/kg

Pin=250mW/Zoom Scan (5x5x7)/Cube 0: Measurement grid: $dx=8\text{mm}$, $dy=8\text{mm}$, $dz=5\text{mm}$
Reference Value = 57.29 V/m; Power Drift = 0.04 dB
Peak SAR (extrapolated) = 3.64 W/kg
SAR(1 g) = 2.42 W/kg; SAR(10 g) = 1.58 W/kg
Maximum value of SAR (measured) = 3.24 W/kg

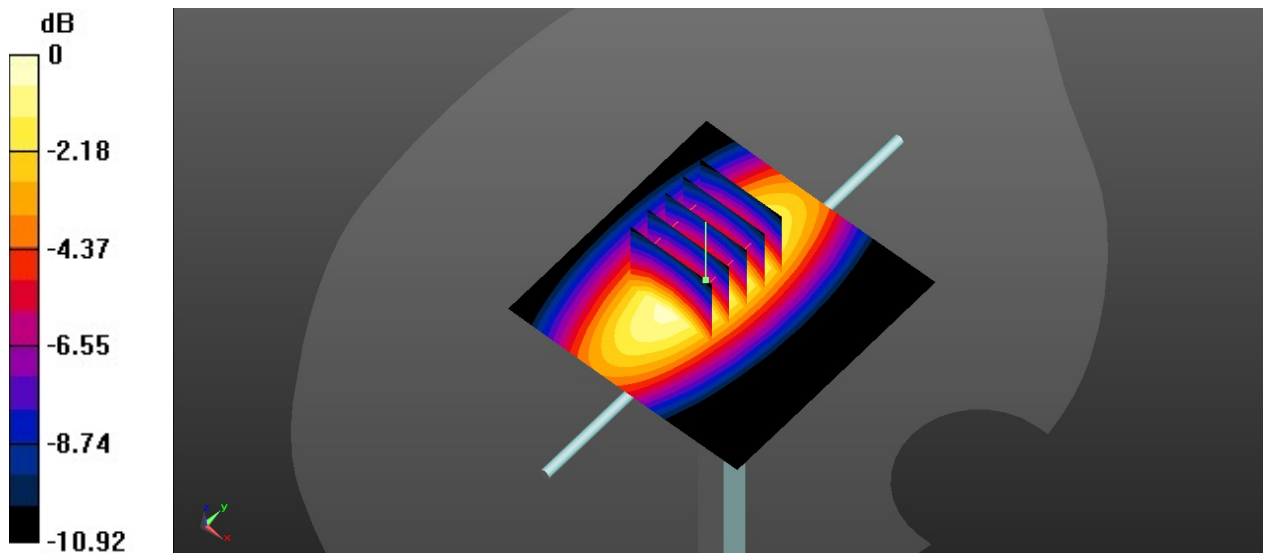

System Check_Head_1900MHz

DUT: D1900V2-SN:5d182

Communication System: UID 0, CW; Frequency: 1900 MHz; Duty Cycle: 1:1
Medium: HSL_1900_210220 Medium parameters used: $f = 1900$ MHz; $\sigma = 1.422$ S/m; $\epsilon_r = 41.138$;
 $\rho = 1000$ kg/m³
Ambient Temperature : 23.4 °C; Liquid Temperature : 22.6 °C

DASY5 Configuration:

- Probe: EX3DV4 - SN7577; ConvF(8.34, 8.34, 8.34); Calibrated: 2020.09.30
- Sensor-Surface: 1.4mm (Mechanical Surface Detection)
- Electronics: DAE4 Sn715; Calibrated: 2020.07.27
- Phantom: Twin-SAM1(P1aP2a20); Type: QD 000 P40 CD; Serial: TP:1670
- Measurement SW: DASY52, Version 52.10 (3); SEMCAD X Version 14.6.13 (7474)

Pin=250mW/Area Scan (61x61x1): Interpolated grid: dx=1.500 mm, dy=1.500 mm
Maximum value of SAR (interpolated) = 15.8 W/kg

Pin=250mW/Zoom Scan (5x5x7)/Cube 0: Measurement grid: dx=8mm, dy=8mm, dz=5mm
Reference Value = 97.63 V/m; Power Drift = 0.09 dB
Peak SAR (extrapolated) = 19.5 W/kg
SAR(1 g) = 10.3 W/kg; SAR(10 g) = 5.28 W/kg
Maximum value of SAR (measured) = 16.2 W/kg

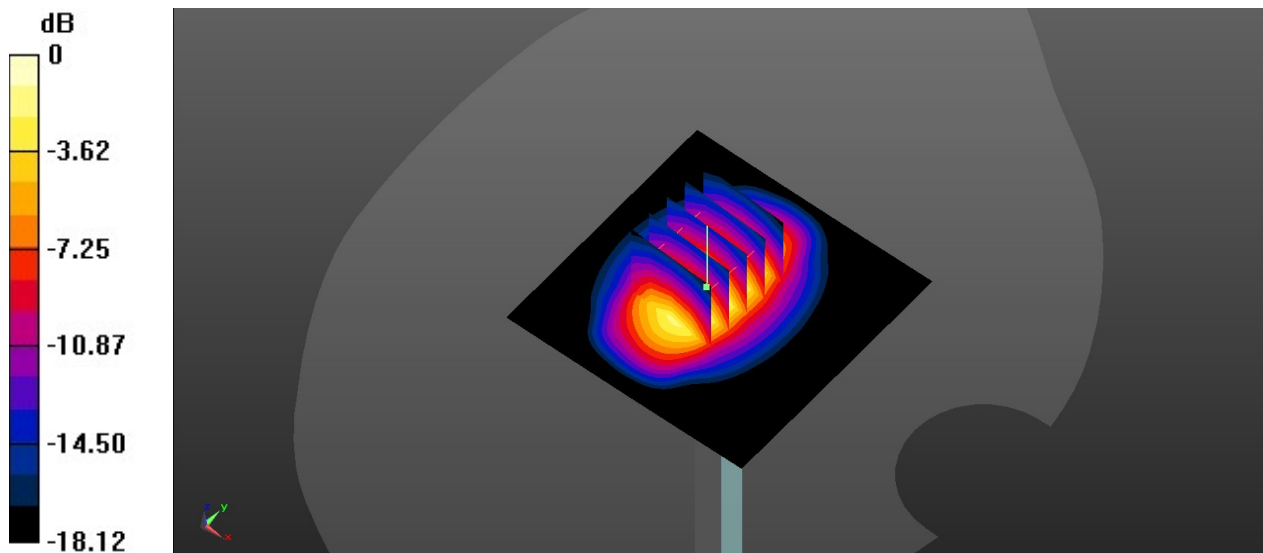

0 dB = 16.2 W/kg

System Check_Head_1900MHz

DUT: D1900V2-SN:5d182

Communication System: UID 0, CW; Frequency: 1900 MHz; Duty Cycle: 1:1
Medium: HSL_1900_210225 Medium parameters used: $f = 1900 \text{ MHz}$; $\sigma = 1.457 \text{ S/m}$; $\epsilon_r = 39.135$;
 $\rho = 1000 \text{ kg/m}^3$
Ambient Temperature : 23.5 °C; Liquid Temperature : 22.6 °C

DASY5 Configuration:

- Probe: EX3DV4 - SN7577; ConvF(8.34, 8.34, 8.34); Calibrated: 2020.09.30
- Sensor-Surface: 1.4mm (Mechanical Surface Detection)
- Electronics: DAE4 Sn715; Calibrated: 2020.07.27
- Phantom: Twin-SAM1(P1aP2a20); Type: QD 000 P40 CD; Serial: TP:1670
- Measurement SW: DASY52, Version 52.10 (3); SEMCAD X Version 14.6.13 (7474)

Pin=250mW/Area Scan (61x61x1): Interpolated grid: $dx=1.500 \text{ mm}$, $dy=1.500 \text{ mm}$
Maximum value of SAR (interpolated) = 14.8 W/kg

Pin=250mW/Zoom Scan (5x5x7)/Cube 0: Measurement grid: $dx=8\text{mm}$, $dy=8\text{mm}$, $dz=5\text{mm}$
Reference Value = 99.56 V/m; Power Drift = 0.12 dB
Peak SAR (extrapolated) = 18.2 W/kg
SAR(1 g) = 9.79 W/kg; SAR(10 g) = 5.07 W/kg
Maximum value of SAR (measured) = 15.3 W/kg

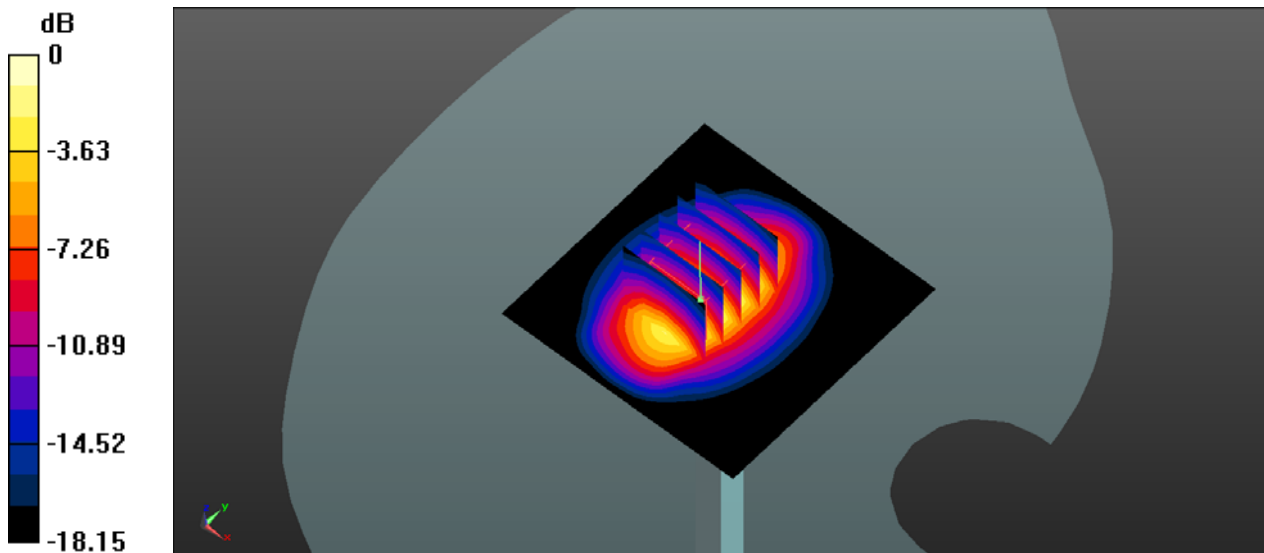

0 dB = 15.3 W/kg

System Check_Head_2450MHz

DUT: D2450V2-SN:924

Communication System: UID 0, CW; Frequency: 2450 MHz; Duty Cycle: 1:1

Medium: HSL_2450_210131 Medium parameters used: $f = 2450$ MHz; $\sigma = 1.754$ S/m; $\epsilon_r = 40.37$; $\rho = 1000$ kg/m³

Ambient Temperature : 23.5 °C; Liquid Temperature : 22.6 °C

DASY5 Configuration:

- Probe: EX3DV4 - SN7577; ConvF(7.95, 7.95, 7.95); Calibrated: 2020.09.30
- Sensor-Surface: 1.4mm (Mechanical Surface Detection)
- Electronics: DAE4 Sn715; Calibrated: 2020.07.27
- Phantom: Twin-SAM1(P1aP2a20); Type: QD 000 P40 CD; Serial: TP:1670
- Measurement SW: DASY52, Version 52.10 (3); SEMCAD X Version 14.6.13 (7474)

Pin=250mW/Area Scan (81x81x1): Interpolated grid: dx=1.200 mm, dy=1.200 mm

Maximum value of SAR (interpolated) = 19.8 W/kg

Pin=250mW/Zoom Scan (7x7x7)/Cube 0: Measurement grid: dx=8mm, dy=8mm, dz=5mm

Reference Value = 102.9 V/m; Power Drift = 0.01 dB

Peak SAR (extrapolated) = 25.8 W/kg

SAR(1 g) = 12 W/kg; SAR(10 g) = 5.59 W/kg

Maximum value of SAR (measured) = 20.7 W/kg

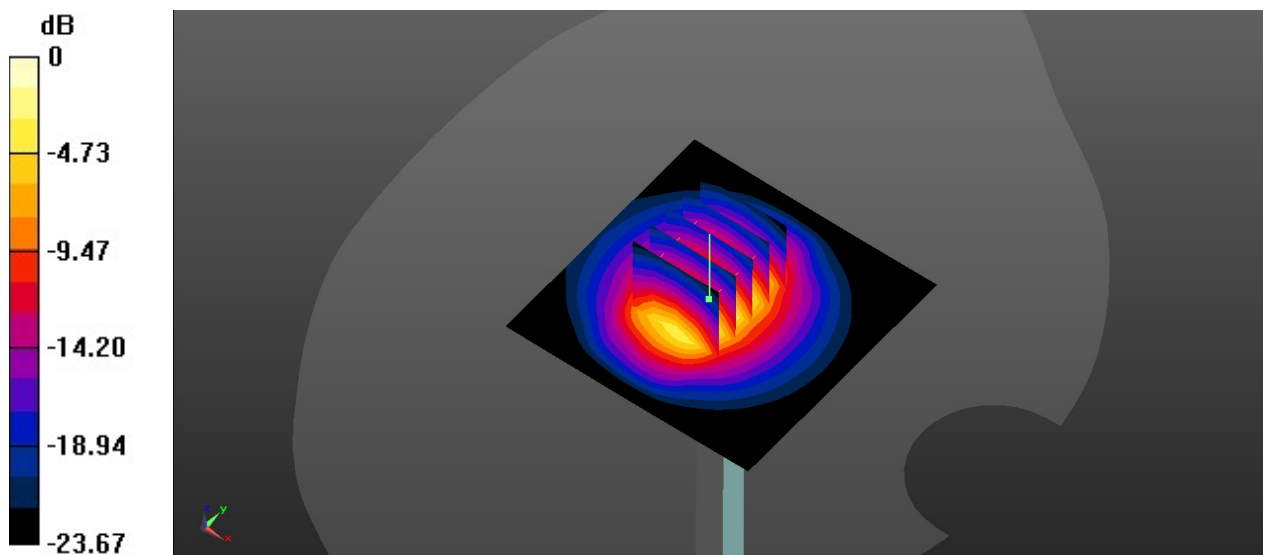

0 dB = 20.7 W/kg

System Check_Head_2600MHz

DUT: D2600V2-SN:1070

Communication System: UID 0, CW (0); Frequency: 2600 MHz; Duty Cycle: 1:1
Medium: HSL_2600_210222 Medium parameters used: $f = 2600$ MHz; $\sigma = 1.922$ S/m; $\epsilon_r = 39.818$;
 $\rho = 1000$ kg/m³
Ambient Temperature : 23.5 °C; Liquid Temperature : 22.5 °C

DASY5 Configuration:

- Probe: EX3DV4 - SN7577; ConvF(7.66, 7.66, 7.66); Calibrated: 2020.09.30
- Sensor-Surface: 1.4mm (Mechanical Surface Detection)
- Electronics: DAE4 Sn715; Calibrated: 2020.07.27
- Phantom: Twin-SAM1(P1aP2a20); Type: QD 000 P40 CD; Serial: TP:1670
- Measurement SW: DASY52, Version 52.10 (3); SEMCAD X Version 14.6.13 (7474)

Pin=250mW/Area Scan (81x81x1): Interpolated grid: dx=1.200 mm, dy=1.200 mm
Maximum value of SAR (interpolated) = 21.3 W/kg

Pin=250mW/Zoom Scan (7x7x7)/Cube 0: Measurement grid: dx=8mm, dy=8mm, dz=5mm
Reference Value = 96.45 V/m; Power Drift = 0.13 dB
Peak SAR (extrapolated) = 29.7 W/kg
SAR(1 g) = 13.8 W/kg; SAR(10 g) = 6.12 W/kg
Maximum value of SAR (measured) = 23.3 W/kg

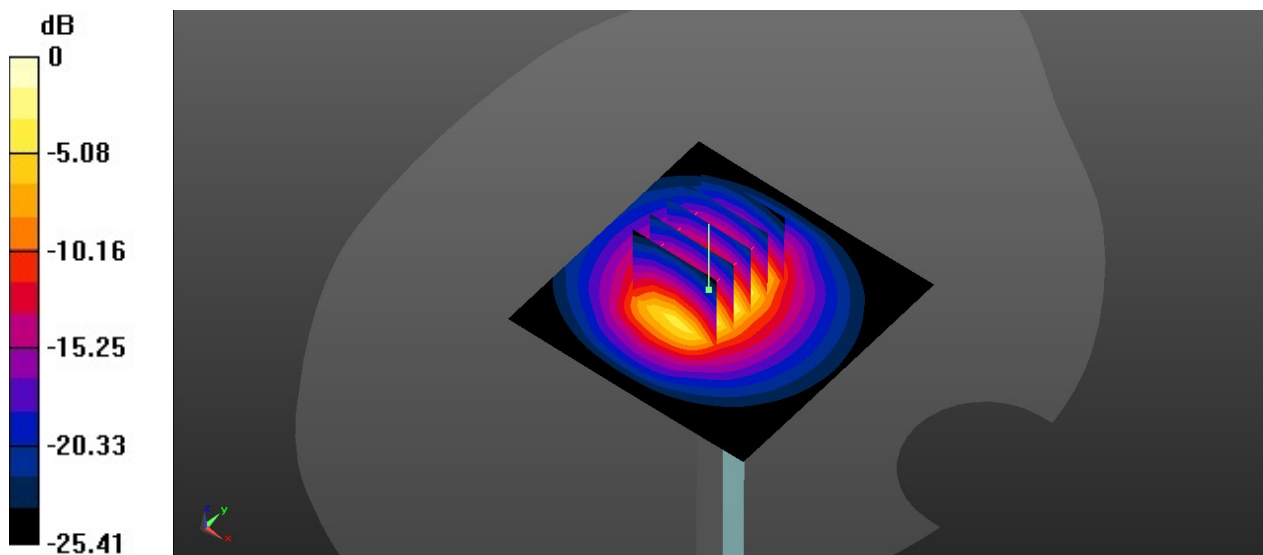

0 dB = 23.3 W/kg

System Check_Head_2600MHz

DUT: D2600V2-SN:1070

Communication System: UID 0, CW (0); Frequency: 2600 MHz; Duty Cycle: 1:1
Medium: HSL_2600_210226 Medium parameters used: $f = 2600$ MHz; $\sigma = 2.055$ S/m; $\epsilon_r = 37.597$;
 $\rho = 1000$ kg/m³
Ambient Temperature : 23.5 °C; Liquid Temperature : 22.4 °C

DASY5 Configuration:

- Probe: EX3DV4 - SN7577; ConvF(7.66, 7.66, 7.66); Calibrated: 2020.09.30
- Sensor-Surface: 1.4mm (Mechanical Surface Detection)
- Electronics: DAE4 Sn715; Calibrated: 2020.07.27
- Phantom: Twin-SAM1(P1aP2a20); Type: QD 000 P40 CD; Serial: TP:1670
- Measurement SW: DASY52, Version 52.10 (3); SEMCAD X Version 14.6.13 (7474)

Pin=250mW/Area Scan (81x81x1): Interpolated grid: dx=1.200 mm, dy=1.200 mm
Maximum value of SAR (interpolated) = 24.9 W/kg

Pin=250mW/Zoom Scan (7x7x7)/Cube 0: Measurement grid: dx=8mm, dy=8mm, dz=5mm
Reference Value = 102.0 V/m; Power Drift = 0.15 dB
Peak SAR (extrapolated) = 30.2 W/kg
SAR(1 g) = 14.3 W/kg; SAR(10 g) = 6.41 W/kg
Maximum value of SAR (measured) = 24.4 W/kg

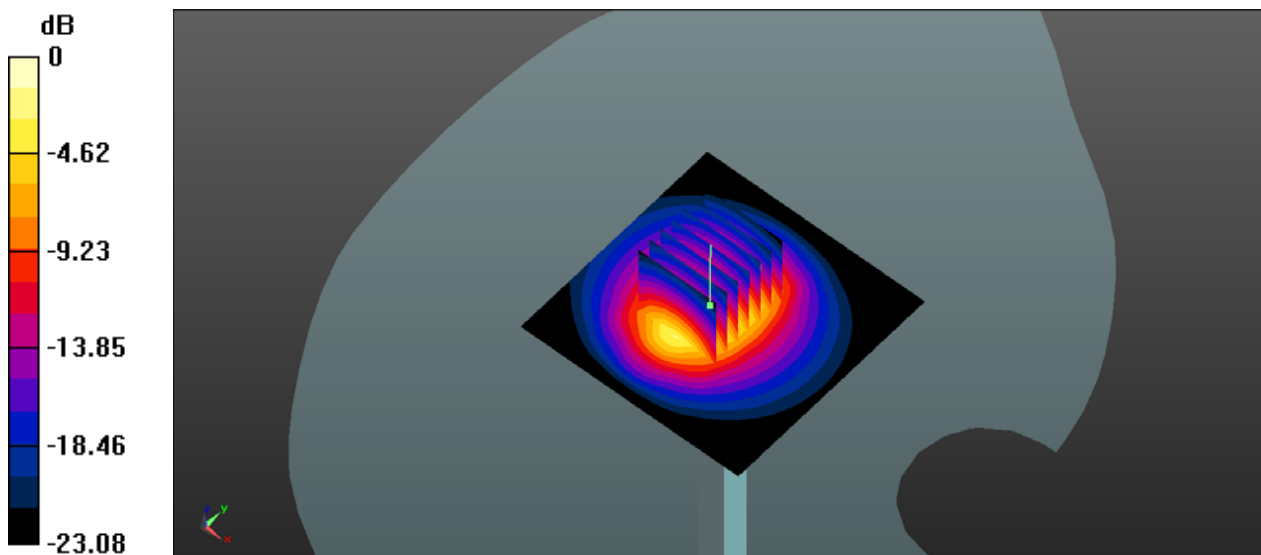

0 dB = 24.4 W/kg

System Check_Head_5250MHz

DUT: D5GHzV2-SN:1167

Communication System: UID 0, CW (0); Frequency: 5250 MHz; Duty Cycle: 1:1
Medium: HSL_5250_210207 Medium parameters used: $f = 5250$ MHz; $\sigma = 4.699$ S/m; $\epsilon_r = 35.407$;
 $\rho = 1000$ kg/m³
Ambient Temperature : 23.6 °C; Liquid Temperature : 22.3 °C

DASY5 Configuration:

- Probe: EX3DV4 - SN7577; ConvF(5.4, 5.4, 5.4); Calibrated: 2020.09.30
- Sensor-Surface: 1.4mm (Mechanical Surface Detection)
- Electronics: DAE4 Sn715; Calibrated: 2020.07.27
- Phantom: Twin-SAM1(P1aP2a20); Type: QD 000 P40 CD; Serial: TP:1670
- Measurement SW: DASY52, Version 52.10 (3); SEMCAD X Version 14.6.13 (7474)

Pin=100mW/Area Scan (71x71x1): Interpolated grid: dx=1.000 mm, dy=1.000 mm
Maximum value of SAR (interpolated) = 20.0 W/kg

Pin=100mW/Zoom Scan (7x7x7)/Cube 0: Measurement grid: dx=4mm, dy=4mm, dz=1.4mm
Reference Value = 61.82 V/m; Power Drift = 0.15 dB
Peak SAR (extrapolated) = 33.4 W/kg
SAR(1 g) = 8.25 W/kg; SAR(10 g) = 2.3 W/kg
Maximum value of SAR (measured) = 20.1 W/kg

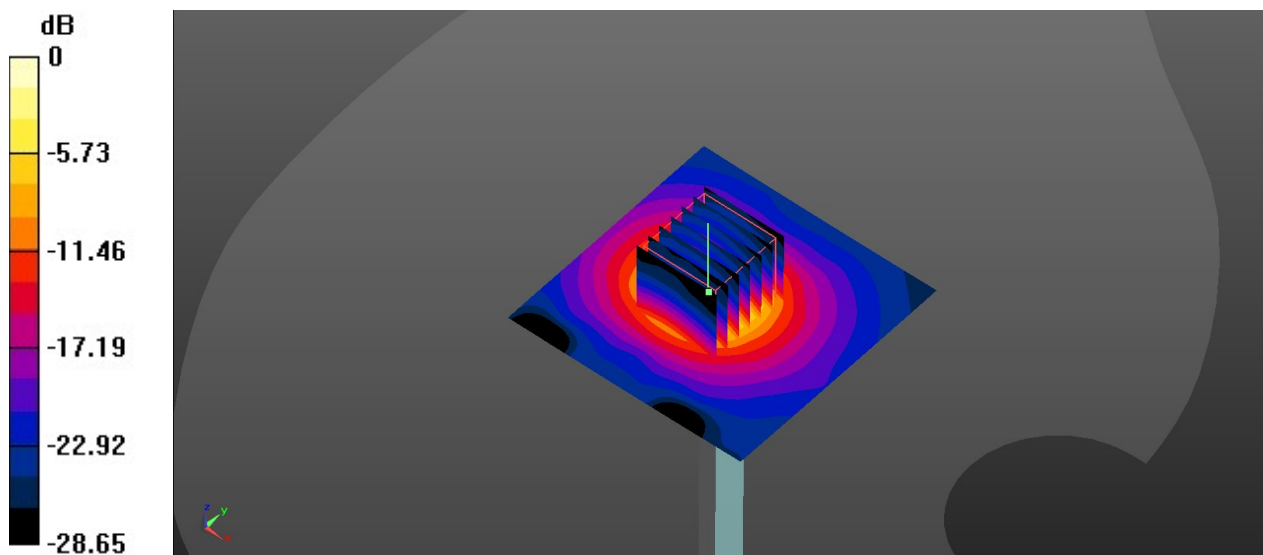

System Check_Head_5600MHz

DUT: D5GHzV2-SN:1167

Communication System: UID 0, CW (0); Frequency: 5600 MHz; Duty Cycle: 1:1
Medium: HSL_5600_210212 Medium parameters used: $f = 5600$ MHz; $\sigma = 5.044$ S/m; $\epsilon_r = 34.914$;
 $\rho = 1000$ kg/m³
Ambient Temperature : 23.3 °C; Liquid Temperature : 22.2 °C

DASY5 Configuration:

- Probe: EX3DV4 - SN7577; ConvF(4.79, 4.79, 4.79); Calibrated: 2020.09.30
- Sensor-Surface: 1.4mm (Mechanical Surface Detection)
- Electronics: DAE4 Sn715; Calibrated: 2020.07.27
- Phantom: Twin-SAM1(P1aP2a20); Type: QD 000 P40 CD; Serial: TP:1670
- Measurement SW: DASY52, Version 52.10 (3); SEMCAD X Version 14.6.13 (7474)

Pin=100mW/Area Scan (71x71x1): Interpolated grid: dx=1.000 mm, dy=1.000 mm
Maximum value of SAR (interpolated) = 22.1 W/kg

Pin=100mW/Zoom Scan (7x7x7)/Cube 0: Measurement grid: dx=4mm, dy=4mm, dz=1.4mm
Reference Value = 67.81 V/m; Power Drift = 0.02 dB
Peak SAR (extrapolated) = 38.8 W/kg
SAR(1 g) = 8.73 W/kg; SAR(10 g) = 2.43 W/kg
Maximum value of SAR (measured) = 21.6 W/kg

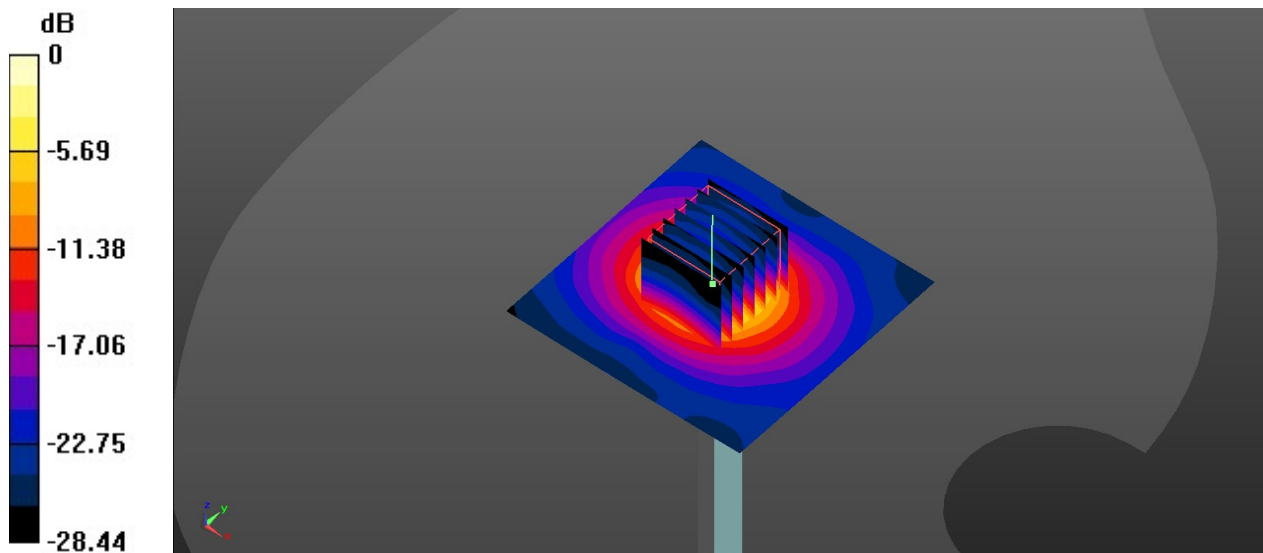

0 dB = 21.6 W/kg

System Check_Head_5750MHz

DUT: D5GHzV2-SN:1167

Communication System: UID 0, CW (0); Frequency: 5750 MHz; Duty Cycle: 1:1
Medium: HSL_5750_210212 Medium parameters used: $f = 5750$ MHz; $\sigma = 5.182$ S/m; $\epsilon_r = 34.643$;
 $\rho = 1000$ kg/m³
Ambient Temperature : 23.7 °C; Liquid Temperature : 22.5 °C

DASY5 Configuration:

- Probe: EX3DV4 - SN7577; ConvF(5.02, 5.02, 5.02); Calibrated: 2020.09.30
- Sensor-Surface: 1.4mm (Mechanical Surface Detection)
- Electronics: DAE4 Sn715; Calibrated: 2020.07.27
- Phantom: Twin-SAM1(P1aP2a20); Type: QD 000 P40 CD; Serial: TP:1670
- Measurement SW: DASY52, Version 52.10 (3); SEMCAD X Version 14.6.13 (7474)

Pin=100mW/Area Scan (71x71x1): Interpolated grid: dx=1.000 mm, dy=1.000 mm
Maximum value of SAR (interpolated) = 22.0 W/kg

Pin=100mW/Zoom Scan (7x7x7)/Cube 0: Measurement grid: dx=4mm, dy=4mm, dz=1.4mm
Reference Value = 62.55 V/m; Power Drift = -0.14 dB
Peak SAR (extrapolated) = 36.7 W/kg
SAR(1 g) = 8.16 W/kg; SAR(10 g) = 2.31 W/kg
Maximum value of SAR (measured) = 20.8 W/kg

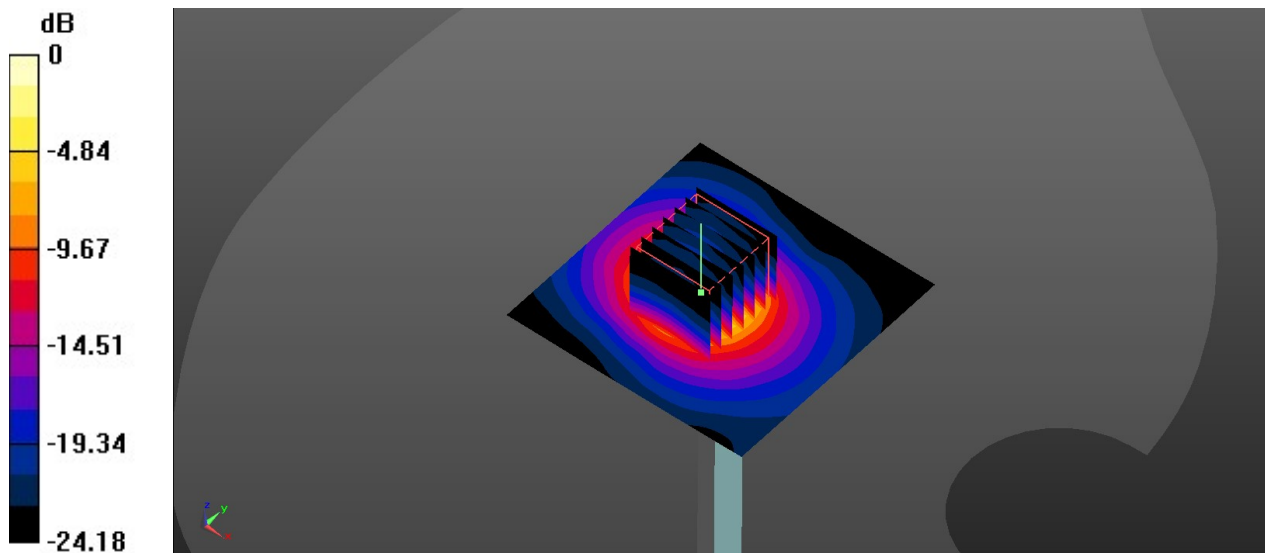

0 dB = 20.8 W/kg



Appendix B. Plots of High SAR Measurement

The plots are shown as follows.

01_GSM850_GPRS(2 Tx slots)_Right Cheek_Ch189

Communication System: UID 0, GPRS/EDGE10 (0); Frequency: 836.4 MHz; Duty Cycle: 1:4.15
 Medium: HSL_835_210123 Medium parameters used: $f = 836.4$ MHz; $\sigma = 0.911$ S/m; $\epsilon_r = 42.758$;
 $\rho = 1000$ kg/m³
 Ambient Temperature : 23.3 °C; Liquid Temperature : 22.4 °C

DASY5 Configuration:

- Probe: EX3DV4 - SN7577; ConvF(9.54, 9.54, 9.54); Calibrated: 2020.09.30
- Sensor-Surface: 1.4mm (Mechanical Surface Detection)
- Electronics: DAE4 Sn715; Calibrated: 2020.07.27
- Phantom: Twin-SAM1(P1aP2a20); Type: QD 000 P40 CD; Serial: TP:1670
- Measurement SW: DASY52, Version 52.10 (3); SEMCAD X Version 14.6.13 (7474)

Ch189/Area Scan (71x81x1): Interpolated grid: dx=1.500 mm, dy=1.500 mm
 Maximum value of SAR (interpolated) = 0.576 W/kg

Ch189/Zoom Scan (6x6x7)/Cube 0: Measurement grid: dx=8mm, dy=8mm, dz=5mm
 Reference Value = 8.192 V/m; Power Drift = -0.17 dB
 Peak SAR (extrapolated) = 0.616 W/kg
SAR(1 g) = 0.472 W/kg; SAR(10 g) = 0.361 W/kg
 Maximum value of SAR (measured) = 0.567 W/kg

