



# FCC RF Test Report

**APPLICANT** : Motorola Mobility LLC  
**EQUIPMENT** : Mobile Cellular Phone  
**BRAND NAME** : Motorola  
**MODEL NAME** : XT2143-1  
**FCC ID** : IHDT56ZP3  
**STANDARD** : 47 CFR Part 2, 22, 27  
**CLASSIFICATION** : PCS Licensed Transmitter Held to Ear (PCE)  
**TEST DATE(S)** : May 22, 2021 ~ Jun. 17, 2021

We, Sporton International (ShenZhen) Inc., would like to declare that the tested sample has been evaluated in accordance with the procedures given in ANSI C63.26-2015 and shown compliance with the applicable technical standards.

The test results in this report apply exclusively to the tested model / sample. Without written approval of Sporton International (ShenZhen) Inc., the test report shall not be reproduced except in full.

Reviewed by: Derreck Chen / Supervisor

Approved by: Eric Shih / Manager



**Sporton International (ShenZhen) Inc.**

1/F, 2/F, Bldg 5, Shiling Industrial Zone, Xinwei Village, Xili, Nanshan, Shenzhen, 518055

People's Republic of China



TABLE OF CONTENTS

REVISION HISTORY...3
SUMMARY OF TEST RESULT...4
1 GENERAL DESCRIPTION...5
1.1 Applicant...5
1.2 Manufacturer...5
1.3 Product Feature of Equipment Under Test...5
1.4 Product Specification of Equipment Under Test...6
1.5 Modification of EUT...6
1.6 Maximum ERP/EIRP Power and Emission Designator...6
1.7 Testing Location...8
1.8 Test Software...8
1.9 Applicable Standards...8
1.10 Specification of Accessory...9
2 TEST CONFIGURATION OF EQUIPMENT UNDER TEST...10
2.1 Test Mode...10
2.2 Connection Diagram of Test System...12
2.3 Support Unit used in test configuration and system...12
2.4 Measurement Results Explanation Example...12
2.5 Frequency List of Low/Middle/High Channels...13
3 CONDUCTED TEST ITEMS...15
3.1 Measuring Instruments...15
3.2 Test Setup...15
3.3 Test Result of Conducted Test...15
3.4 Conducted Output Power and ERP/EIRP...16
3.5 Peak-to-Average Ratio...17
3.6 Occupied Bandwidth...18
3.7 Conducted Band Edge...19
3.8 Conducted Spurious Emission...21
3.9 Frequency Stability...22
4 RADIATED TEST ITEMS...23
4.1 Measuring Instruments...23
4.2 Test Setup...23
4.3 Test Result of Radiated Test...24
4.4 Radiated Spurious Emission...25
5 LIST OF MEASURING EQUIPMENT...26
6 UNCERTAINTY OF EVALUATION...27
APPENDIX A. TEST RESULTS OF CONDUCTED TEST
APPENDIX B. TEST RESULTS OF RADIATED TEST
APPENDIX C. TEST SETUP PHOTOGRAPHS





## SUMMARY OF TEST RESULT

Report Section	FCC Rule	Description	Limit	Result	Remark
3.4	§2.1046	Conducted Output Power	Reporting Only	PASS	-
	§22.913(a)(5)	Effective Radiated Power (5G NR n5)	ERP < 7 Watt		
	§27.50(h)(2)	Equivalent Isotropic Radiated Power (5G NR n41, n7)	EIRP < 2Watt		
	§27.50(d)(4)	Equivalent Isotropic Radiated Power (5G NR n66)	EIRP < 1Watt		
3.5	§27.50(j)(4)	Peak-to-Average Ratio	<13 dB	PASS	-
3.6	§2.1049	Occupied Bandwidth	Reporting Only	PASS	-
3.7	§2.1051 §22.917(a) §27.53(h)	Conducted Band Edge Measurement (5G NR n5) (5G NR n66)	< 43+10log <sub>10</sub> (P[Watts])	PASS	-
	§27.53(m)(4)	Conducted Band Edge Measurement (5G NR n7, n41)	§27.53(m)(4)		
3.8	§2.1051 §22.917(a) §27.53(h)	Conducted Spurious Emission (5G NR n5) (5G NR n66)	< 43+10log <sub>10</sub> (P[Watts])	PASS	-
	§2.1051 §27.53(m)(4)	Conducted Spurious Emission (5G NR n7, n41)	< 55+10log <sub>10</sub> (P[Watts])		
3.9	§2.1055 §22.355	Frequency Stability Temperature & Voltage	< 2.5 ppm for Part 22	PASS	-
	§27.54		Within Authorized Band		
4.4	§2.1053 §22.917(a) §27.53(h)	Radiated Spurious Emission (5G NR n5) (5G NR n66)	< 43+10log <sub>10</sub> (P[Watts])	PASS	Under limit 26.92 dB at 7578.270 MHz
	§2.1053 §27.53(m)(4)	Radiated Spurious Emission (5G NR n7, n41)	< 55+10log <sub>10</sub> (P[Watts])		

<b>Declaration of Conformity:</b>
The test results with all measurement uncertainty excluded are presented in accordance with the regulation limits or requirements declared by manufacturers.
<b>Comments and Explanations:</b>
The declared of product specification for EUT presented in the report are provided by the manufacturer, and the manufacturer takes all the responsibilities for the accuracy of product specification.



# 1 General Description

## 1.1 Applicant

Motorola Mobility LLC  
222 W, Merchandise Mart Plaza, Chicago IL 60654 USA

## 1.2 Manufacturer

Motorola Mobility LLC  
222 W, Merchandise Mart Plaza, Chicago IL 60654 USA

## 1.3 Product Feature of Equipment Under Test

Product Feature	
Equipment	Mobile Cellular Phone
Brand Name	Motorola
Model Name	XT2143-1
FCC ID	IHDT56ZP3
EUT supports Radios application	GSM/WCDMA/LTE/5G NR WLAN 2.4GHz 802.11b/g/n HT20 WLAN 2.4GHz 802.11ac/ax VHT20/HE20 WLAN 5GHz 802.11a/n HT20/HT40 WLAN 5GHz 802.11ac VHT20/VHT40/VHT80/VHT160 WLAN 5GHz 802.11ax HE20/HE40/HE80/HE160 WLAN 6GHz 802.11a/n HT20/HT40 WLAN 6GHz 802.11ac VHT20/VHT40/VHT80/VHT160 WLAN 6GHz 802.11ax HE20/HE40/HE80/HE160 Bluetooth BR/EDR/LE NFC and GNSS
IMEI Code	Conducted : 353121920026553/353121920026561 Radiation : 353121920042550/353121920042568
HW Version	DVT2
SW Version	RRG31.35
EUT Stage	Identical Prototype

**Remark:**

1. Only 5G NR bands are tested in this report, all the other RF bands are tested in the other reports separately.
2. 5G NR bands supports NSA mode only, except n41. For NSA mode of all 5G NR, we only show the combination of the maximum power among all NSA combinations in the report.
3. For modulation of CP-OFDM and DFT-s-OFDM, the maximum power of CP-OFDM is lower than DFT-s-OFDM modulation, therefore, we chose higher power (DFT-s-OFDM modulation) to perform all tests and show in the report.
4. The EN-DC mode combination could be referred to the product spec.
5. 5G NR n41 supports HPUE.

### 1.4 Product Specification of Equipment Under Test

Standards-related Product Specification	
<b>Tx Frequency</b>	5G NR n5 : 824 MHz ~ 849 MHz 5G NR n7 : 2500 MHz ~ 2570 MHz 5G NR n41 : 2496 MHz ~ 2690 MHz 5G NR n66 : 1710 MHz ~ 1780 MHz
<b>Rx Frequency</b>	5G NR n5 : 869 MHz ~ 894 MHz 5G NR n7 : 2620 MHz ~ 2690 MHz 5G NR n41 : 2496 MHz ~ 2690 MHz 5G NR n66 : 2110 MHz~ 2200 MHz
<b>SCS</b>	n5, n7, n66: 15kHz n41: 30kHz
<b>Bandwidth</b>	n5: 5MHz / 10MHz / 15MHz / 20MHz n66: 5MHz / 10MHz / 15MHz / 20MHz / 30MHz / 40MHz n7: 5MHz / 10MHz / 15MHz / 20MHz / 25MHz / 30MHz / 40MHz n41: 20MHz / 30MHz / 40MHz / 50MHz / 60MHz / 80MHz / 90MHz / 100MHz
<b>Antenna Gain</b>	Main Antenna: 5G NR n5: -4.8 dBi 5G NR n7: -0.08 dBi 5G NR n41: -0.15 dBi 5G NR n66: -0.01 dBi ASDIV Antenna: 5G NR n7: -1.63 dBi
<b>Type of Modulation</b>	CP-OFDM: QPSK / 16QAM / 64QAM / 256QAM DFT-s-OFDM: PI/2 BPSK / QPSK / 16QAM / 64QAM / 256QAM

### 1.5 Modification of EUT

No modifications are made to the EUT during all test items.

### 1.6 Maximum ERP/EIRP Power and Emission Designator

5G NR n5 (EN DC_7A-n5A)		PI/2 BPSK / QPSK		16QAM / 64QAM / 256QAM	
BW (MHz)	Frequency Range (MHz)	Maximum ERP(W)	Emission Designator (99%OBW)	Maximum ERP(W)	Emission Designator (99%OBW)
5	826.5 ~ 846.5	0.0428	4M47G7D	0.0344	4M49W7D
10	829.0 ~ 844.0	0.0426	9M27G7D	0.0340	9M28W7D
15	831.5 ~ 841.5	0.0416	14M1G7D	0.0330	14M1W7D
20	834.0 ~ 839.0	0.0447	18M9G7D	0.0330	18M9W7D



5G NR n7 (EN DC_5A-n7A)		PI/2 BPSK / QPSK		16QAM / 64QAM / 256QAM	
BW (MHz)	Frequency Range (MHz)	Maximum EIRP(W)	Emission Designator (99%OBW)	Maximum EIRP(W)	Emission Designator (99%OBW)
5	2502.5 ~ 2567.5	0.2009	4M47G7D	0.1660	4M49W7D
10	2505.0 ~ 2565.0	0.2028	9M28G7D	0.1652	9M29W7D
15	2507.5 ~ 2562.5	0.2009	14M1G7D	0.1607	14M1W7D
20	2510.0 ~ 2560.0	0.2028	18M9G7D	0.1589	19M0W7D
25	2512.5 ~ 2557.5	0.1563	23M7G7D	0.1268	23M8W7D
30	2515.0 ~ 2555.0	0.1592	28M6G7D	0.1300	28M6W7D
40	2520.0 ~ 2550.0	0.1589	38M6G7D	0.1291	38M6W7D

5G NR n41		PI/2 BPSK / QPSK		16QAM / 64QAM / 256QAM	
BW (MHz)	Frequency Range (MHz)	Maximum EIRP(W)	Emission Designator (99%OBW)	Maximum EIRP(W)	Emission Designator (99%OBW)
20	2506.02 ~ 2679.99	0.3811	18M2G7D	0.3006	18M2W7D
30	2511.00 ~ 2674.98	0.3459	27M9G7D	0.2805	27M9W7D
40	2516.01 ~ 2670.00	0.3428	37M8G7D	0.2780	37M8W7D
50	2521.02 ~ 2664.99	0.3251	47M5G7D	0.2594	47M6W7D
60	2526.00 ~ 2659.98	0.3758	58M0G7D	0.3069	57M9W7D
80	2536.02 ~ 2649.99	0.3251	77M4G7D	0.2606	77M6W7D
90	2541.00 ~ 2644.98	0.3373	87M4G7D	0.2673	87M6W7D
100	2546.01 ~ 2640.00	0.3396	97M6G7D	0.2642	97M7W7D

5G NR n66 (EN DC_5A-n66A)		PI/2 BPSK / QPSK		16QAM / 64QAM / 256QAM	
BW (MHz)	Frequency Range (MHz)	Maximum EIRP(W)	Emission Designator (99%OBW)	Maximum EIRP(W)	Emission Designator (99%OBW)
5	1712.5 ~ 1777.5	0.2360	4M48G7D	0.1923	4M48W7D
10	1715.0 ~ 1775.0	0.2410	9M28G7D	0.2094	9M30W7D
15	1717.5 ~ 1772.5	0.2500	14M1G7D	0.1991	14M1W7D
20	1720.0 ~ 1770.0	0.2500	18M9G7D	0.2065	19M0W7D
30	1725.0 ~ 1765.0	0.2296	28M6G7D	0.1828	28M6W7D
40	1730.0 ~ 1760.0	0.2296	38M7G7D	0.1828	38M6W7D

Note: All modulations have been tested, only the worst test results of PSK & QAM are shown in the report.



### 1.7 Testing Location

Sporton International (Shenzhen) Inc. is accredited to ISO/IEC 17025:2017 by American Association for Laboratory Accreditation with Certificate Number 5145.01.

<b>Test Firm</b>	Sporton International (Shenzhen) Inc.		
<b>Test Site Location</b>	1/F, 2/F, Bldg 5, Shiling Industrial Zone, Xinwei Village, Xili, Nanshan, Shenzhen, 518055 People’s Republic of China TEL: +86-755-86379589 FAX: +86-755-86379595		
<b>Test Site No.</b>	<b>Sporton Site No.</b>	<b>FCC Designation No.</b>	<b>FCC Test Firm Registration No.</b>
	TH01-SZ	CN1256	421272

<b>Test Firm</b>	Sporton International (Shenzhen) Inc.		
<b>Test Site Location</b>	101, 1st Floor, Block B, Building 1, No. 2, Tengfeng 4th Road, Fenghuang Community, Fuyong Street, Baoan District, Shenzhen City Guangdong Province China 518103 TEL: +86-755-33202398		
<b>Test Site No.</b>	<b>Sporton Site No.</b>	<b>FCC Designation No.</b>	<b>FCC Test Firm Registration No.</b>
	03CH03-SZ	CN1256	421272

### 1.8 Test Software

Item	Site	Manufacturer	Name	Version
1.	03CH03-SZ	AUDIX	E3	6.2009-8-24

### 1.9 Applicable Standards

According to the specifications of the manufacturer, the EUT must comply with the requirements of the following standards:

- 47 CFR Part 2, 22, 24, 27
- ANSI C63.26-2015
- FCC KDB 971168 D01 Power Meas License Digital Systems v03r01
- FCC KDB 412172 D01 Determining ERP and EIRP v01r01

**Remark:** All test items were verified and recorded according to the standards and without any deviation during the test.





### 1.10 Specification of Accessory

Specification of Accessory				
AC Adapter 1(US)	Brand Name	Motorola(Salom)	Model Name	MC-301
AC Adapter 1(EU)	Brand Name	Motorola(Salom)	Model Name	MC-302
AC Adapter 1(UK)	Brand Name	Motorola(Salom)	Model Name	MC-303
AC Adapter 1(Brazil)	Brand Name	Motorola(Salom)	Model Name	MC-307
AC Adapter 1(AU)	Brand Name	Motorola(Salom)	Model Name	MC-305
AC Adapter 2(US)	Brand Name	Motorola(Acbel)	Model Name	MC-301
AC Adapter 2(EU)	Brand Name	Motorola(Acbel)	Model Name	MC-302
AC Adapter 2(UK)	Brand Name	Motorola(Acbel)	Model Name	MC-303
AC Adapter 2(AU)	Brand Name	Motorola(Acbel)	Model Name	MC-305
AC Adapter 2(IN)	Brand Name	Motorola(Acbel)	Model Name	MC-304
AC Adapter 3(Brazil)	Brand Name	Motorola(Flex)	Model Name	MC-307
Battery	Brand Name	Motorola(ATL)	Model Name	MB40
Earphone 1	Brand Name	Motorola(Lyand)	Model Name	MH191(SH38C81577)
Earphone 2	Brand Name	Motorola(LCHSE)	Model Name	MH191(SH38C81576)
Earphone 3 (Brazil only)	Brand Name	Motorola(Lyand)	Model Name	MH181(SH38C37773)
Earphone 4 (Brazil only)	Brand Name	Motorola(Cosonic)	Model Name	MH181(SH38C44959)
USB Cable 1	Brand Name	Motorola(Luxshare)	Model Name	SC18D13217
USB Cable 2	Brand Name	Motorola(Saibao)	Model Name	SC18D13215
USB Cable 3	Brand Name	Motorola(Cabletech)	Model Name	SC18D13216
Type C to audio cable	Brand Name	Motorola(Luxshare)	Model Name	SC18C27844



## 2 Test Configuration of Equipment Under Test

### 2.1 Test Mode

Antenna port conducted and radiated test items are performed according to KDB 971168 D01 Power Meas License Digital Systems v03r01 with maximum output power.

For radiated measurement, pre-scanned in three orthogonal panels, X, Y, Z. The worst cases (Z plane) were recorded in this report.

The device is investigated from 30MHz to 10 times of fundamental signal for radiated spurious emission test under different RB size/offset and modulations in exploratory test. Subsequently, only the worst case emissions are reported.

Orthogonal Planes of EUT	X Plane	Y Plane	Z Plane
			

Test Items	5G NR	Bandwidth (MHz)						Modulation					RB #		Test Channel			
		5	10	15	20	25-90	100	PI/2 BPSK	QPSK	16QAM	64QAM	256QAM	1	Full	L	M	H	
Max. Output Power	n5	v	v	v	v	-	-	v	v	v	v	v	v	v	v	v	v	v
	n7	v	v	v	v	v	-	v	v	v	v	v	v	v	v	v	v	v
	n41	-	-	-	v	v	v	v	v	v	v	v	v	v	v	v	v	v
	n66	v	v	v	v	v	-	v	v	v	v	v	v	v	v	v	v	v
Peak-to-Average Ratio	n5				v	-	-	v	v				v	v	v	v	v	
	n7				v	-	-	v	v				v	v	v	v	v	
	n41	-	-	-	v			v	v				v	v	v	v	v	
	n66				v	-	-	v	v				v	v	v	v	v	
26dB and 99% Bandwidth	n5	v	v	v	v	-	-	v	v	v	v	v		v		v		
	n7	v	v	v	v	v	-	v	v	v	v	v		v		v		
	n41	-	-	-	v	v	v	v	v	v	v	v		v		v		
	n66	v	v	v	v	v	-	v	v	v	v	v		v		v		



Test Items	Band	Bandwidth (MHz)						Modulation					RB #		Test Channel		
		5	10	15	20	25-90	100	PI/2 BPSK	QPSK	16QAM	64QAM	256QAM	1	Full	L	M	H
Conducted Band Edge	n5	v	v		v	-	-	v	v				v	v	v		v
	n7	v			v	v	-	v	v				v	v	v		v
	n41	-	-	-	v	v	v	v	v				v	v	v		v
	n66	v			v	v	-	v	v				v	v	v		v
Conducted Spurious Emission	n5	v	v		v	-	-	v	v				v		v	v	v
	n7	v			v	v	-	v	v				v		v	v	v
	n41	-	-	-	v	v	v	v	v				v		v	v	v
	n66	v			v	v	-	v	v				v		v	v	v
Frequency Stability	n5				v	-	-		v					v		v	
	n7				v	-	-		v					v		v	
	n41	-	-	-			v		v					v		v	
	n66				v	-	-		v					v		v	
E.R.P / E.I.R.P	n5	v	v	v	v	-	-	v	v	v	v	v	v	v	v	v	v
	n7	v	v	v	v	v	-	v	v	v	v	v	v	v	v	v	v
	n41	-	-	-	v	v	v	v	v	v	v	v	v	v	v	v	v
	n66	v	v	v	v	v	-	v	v	v	v	v	v	v	v	v	v
Radiated Spurious Emission	n5	Worst Case														v	
	n7	Worst Case														v	
	n41	Worst Case														v	
	n66	Worst Case														v	
Note	<ol style="list-style-type: none"> <li>The mark "v " means that this configuration is chosen for testing</li> <li>The mark "- " means that this bandwidth is not supported.</li> <li>The device is investigated from 30MHz to 10 times of fundamental signal for radiated spurious emission test under different RB size/offset and modulations in exploratory test. Subsequently, only the worst case emissions are reported.</li> <li>Based on engineering evaluation, only the worst modulations test results are shown in the report.</li> </ol>																

## 2.2 Connection Diagram of Test System

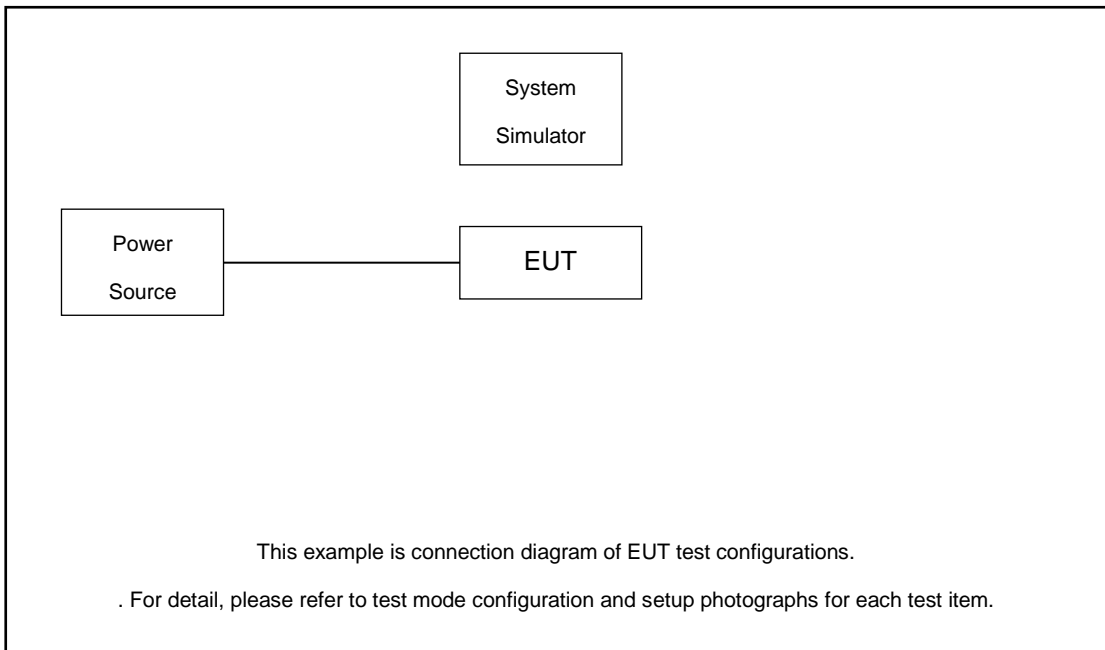

## 2.3 Support Unit used in test configuration and system

Item	Equipment	Trade Name	Model No.	FCC ID	Data Cable	Power Cord
1.	DC Power Supply	GW	GPS-3030D	N/A	N/A	Unshielded, 1.8 m
2.	LTE Base Station	Anritsu	MT8821C	N/A	N/A	Unshielded, 1.8 m
3.	NR Base Station	Anritsu	MT8000A	N/A	N/A	Unshielded, 1.8 m

## 2.4 Measurement Results Explanation Example

### For all conducted test items:

The offset level is set in the spectrum analyzer to compensate the RF cable loss and attenuator factor between EUT conducted output port and spectrum analyzer. With the offset compensation, the spectrum analyzer reading level is exactly the EUT RF output level.

The spectrum analyzer offset is derived from RF cable loss and attenuator factor.

*Offset = RF cable loss + attenuator factor.*

Following shows an offset computation example with cable loss 5.2 dB and 10dB attenuator.

Example :

$$\begin{aligned} \text{Offset(dB)} &= \text{RF cable loss(dB)} + \text{attenuator factor(dB)}. \\ &= 5.2 + 10 = 15.2 \text{ (dB)} \end{aligned}$$



### 2.5 Frequency List of Low/Middle/High Channels

5G NR n5 Channel and Frequency List				
BW [MHz]	Channel/Frequency(MHz)	Lowest	Middle	Highest
20	Channel	175800	176300	176800
	Frequency	834	836.5	839
15	Channel	175300	176300	177300
	Frequency	831.5	836.5	841.5
10	Channel	174800	176300	177800
	Frequency	829	836.5	844
5	Channel	174300	176300	178300
	Frequency	826.5	836.5	846.5

5G NR n7 Channel and Frequency List				
BW [MHz]	Channel/Frequency(MHz)	Lowest	Middle	Highest
40	Channel	528000	531000	534000
	Frequency	2520	2535	2550
30	Channel	527000	531000	535000
	Frequency	2515	2535	2555
25	Channel	526500	531000	535500
	Frequency	2512.5	2535	2557.5
20	Channel	526000	531000	536000
	Frequency	2510	2535	2560
15	Channel	525500	531000	536500
	Frequency	2507.5	2535	2562.5
10	Channel	525000	531000	537000
	Frequency	2505	2535	2565
5	Channel	524500	531000	537500
	Frequency	2502.5	2535	2567.5



5G NR n41 Channel and Frequency List				
BW [MHz]	Channel/Frequency(MHz)	Lowest	Middle	Highest
100	Channel	509202	518598	528000
	Frequency	2546.01	2592.99	2640
90	Channel	508200	518598	528996
	Frequency	2541	2592.99	2644.98
80	Channel	507204	518598	529998
	Frequency	2536.02	2592.99	2649.99
60	Channel	505200	518598	531996
	Frequency	2526	2592.99	2659.98
50	Channel	504204	518598	532998
	Frequency	2521.02	2592.99	2664.99
40	Channel	503202	518598	534000
	Frequency	2516.01	2592.99	2670
30	Channel	502200	518598	534996
	Frequency	2511	2592.99	2674.98
20	Channel	501204	518598	535998
	Frequency	2506.02	2592.99	2679.99

5G NR n66 Channel and Frequency List				
BW [MHz]	Channel/Frequency(MHz)	Lowest	Middle	Highest
40	Channel	426000	429000	432000
	Frequency	1730	1745	1760
30	Channel	425000	429000	433000
	Frequency	1725	1745	1765
20	Channel	424000	429000	434000
	Frequency	1720	1745	1770
15	Channel	423500	429000	434500
	Frequency	1717.5	1745	1772.5
10	Channel	423000	429000	435000
	Frequency	1715	1745	1775
5	Channel	422500	429000	435500
	Frequency	1712.5	1745	1777.5

### 3 Conducted Test Items

#### 3.1 Measuring Instruments

See list of measuring instruments of this test report.

#### 3.2 Test Setup

##### 3.2.1 Conducted Output Power



##### 3.2.2 Peak-to-Average Ratio, Occupied Bandwidth ,Conducted Band-Edge and Conducted Spurious Emission



##### 3.2.3 Frequency Stability

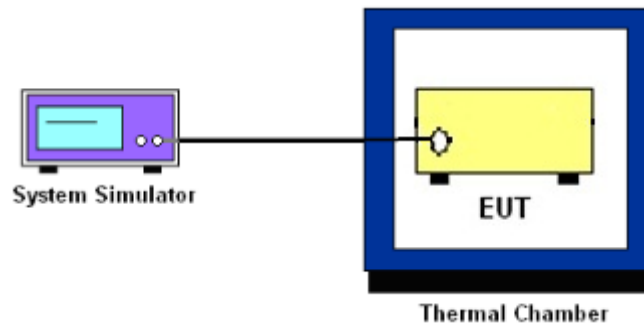

### 3.3 Test Result of Conducted Test

Please refer to Appendix A.



### 3.4 Conducted Output Power and ERP/EIRP

#### 3.4.1 Description of the Conducted Output Power Measurement and ERP/EIRP Measurement

A system simulator was used to establish communication with the EUT. Its parameters were set to force the EUT transmitting at maximum output power. The measured power in the radio frequency on the transmitter output terminals shall be reported.

The ERP of mobile transmitters must not exceed 7 Watts for 5G NR n5.

The EIRP of mobile transmitters must not exceed 2 Watts for 5G NR n7 and n41.

The EIRP of mobile transmitters must not exceed 1 Watts for 5G NR n66.

According to KDB 412172 D01 Power Approach,

$EIRP = P_T + G_T - L_C$ ,  $ERP = EIRP - 2.15$ , where

$P_T$  = transmitter output power in dBm

$G_T$  = gain of the transmitting antenna in dBi

$L_C$  = signal attenuation in the connecting cable between the transmitter and antenna in dB

#### 3.4.2 Test Procedures

1. The testing follows ANSI C63.26 Section 5.2
2. The transmitter output port was connected to the system simulator.
3. Set EUT at maximum power through the system simulator.
4. Select lowest, middle, and highest channels for each band and different modulation.
5. Measure and record the power level from the system simulator.





## **3.5 Peak-to-Average Ratio**

### **3.5.1 Description of the PAR Measurement**

Power Complementary Cumulative Distribution Function (CCDF) curves provide a means for characterizing the power peaks of a digitally modulated signal on a statistical basis. A CCDF curve depicts the probability of the peak signal amplitude exceeding the average power level. Most contemporary measurement instrumentation include the capability to produce CCDF curves for an input signal provided that the instrument's resolution bandwidth can be set wide enough to accommodate the entire input signal bandwidth. In measuring transmissions in this band using an average power technique, the peak-to-average ratio (PAR) of the transmission may not exceed 13 dB.

### **3.5.2 Test Procedures**

1. The testing follows ANSI C63.26 Section 5.2.3.4 (CCDF).
2. The EUT was connected to spectrum and system simulator via a power divider.
3. Set the CCDF (Complementary Cumulative Distribution Function) option in spectrum analyzer.
4. The highest RF powers were measured and recorded the maximum PAPR level associated with a probability of 0.1 %.
5. Record the deviation as Peak to Average Ratio.



## 3.6 Occupied Bandwidth

### 3.6.1 Description of Occupied Bandwidth Measurement

The occupied bandwidth is the width of a frequency band such that, below the lower and above the upper frequency limits, the mean powers emitted are each equal to a specified percentage 0.5% of the total mean transmitted power.

The 26 dB emission bandwidth is defined as the frequency range between two points, one above and one below the carrier frequency, at which the spectral density of the emission is attenuated 26 dB below the maximum in-band spectral density of the modulated signal. Spectral density (power per unit bandwidth) is to be measured with a detector of resolution bandwidth equal to approximately 1.0% of the emission bandwidth.

### 3.6.2 Test Procedures

1. The testing follows ANSI C63.26 Section 5.4
2. The EUT was connected to spectrum analyzer and system simulator via a power divider.
3. The spectrum analyzer center frequency is set to the nominal EUT channel center frequency. The span range for the spectrum analyzer shall be between two and five times the anticipated OBW.
4. The nominal resolution bandwidth (RBW) shall be in the range of 1 to 5 % of the anticipated OBW, and the VBW shall be at least 3 times the RBW.
5. Set the detection mode to peak, and the trace mode to max hold.
6. Determine the reference value: Set the EUT to transmit a modulated signal. Allow the trace to stabilize. Set the spectrum analyzer marker to the highest level of the displayed trace.  
(this is the reference value)
7. Determine the “-26 dB down amplitude” as equal to (Reference Value – X).
8. Place two markers, one at the lowest and the other at the highest frequency of the envelope of the spectral display such that each marker is at or slightly below the “-X dB down amplitude” determined in step 6. If a marker is below this “-X dB down amplitude” value it shall be placed as close as possible to this value. The OBW is the positive frequency difference between the two markers.
9. Use the 99 % power bandwidth function of the spectrum analyzer and report the measured bandwidth.



### 3.7 Conducted Band Edge

#### 3.7.1 Description of Conducted Band Edge Measurement

22.917(a)

For operations in the 824 – 849 MHz band, the FCC limit is  $43 + 10\log_{10}(P[\text{Watts}])$  dB below the transmitter power P(Watts) in a 100kHz bandwidth. However, in the 1MHz bands immediately outside and adjacent to the licensee's frequency block, a resolution bandwidth of at least one percent of the emission bandwidth of the fundamental emission of the transmitter may be employed.

27.53 (h)

For operations in the 1710 – 1755 MHz band, the FCC limit is  $43 + 10\log_{10}(P[\text{Watts}])$  dB below the transmitter power P(Watts) in a 1 MHz bandwidth. However, in the 1MHz bands immediately outside and adjacent to the licensee's frequency block, a resolution bandwidth of at least one percent of the emission bandwidth of the fundamental emission of the transmitter may be employed.

27.53(m)(4)

For mobile digital stations, the attenuation factor shall be not less than  $40 + 10 \log (P)$  dB on all frequencies between the channel edge and 5 megahertz from the channel edge,  $43 + 10 \log (P)$  dB on all frequencies between 5 megahertz and X megahertz from the channel edge, and  $55 + 10 \log (P)$  dB on all frequencies more than X megahertz from the channel edge, where X is the greater of 6 megahertz or the actual emission bandwidth as defined in paragraph (m)(6) of this section. In addition, the attenuation factor shall not be less that  $43 + 10 \log (P)$  dB on all frequencies between 2490.5 MHz and 2496 MHz and  $55 + 10 \log (P)$  dB at or below 2490.5 MHz. Mobile Satellite Service licensees operating on frequencies below 2495 MHz may also submit a documented interference complaint against BRS licensees operating on channel BRS Channel 1 on the same terms and conditions as adjacent channel BRS or EBS licensees.



### 3.7.2 Test Procedures

1. The testing follows ANSI C63.26 section 5.7
2. The EUT was connected to spectrum analyzer and system simulator via a power divider.
3. The band edges of low and high channels for the highest RF powers were measured.
4. Set RBW  $\geq$  1% EBW in the 1MHz band immediately outside and adjacent to the band edge.
5. Beyond the 1 MHz band from the band edge, RBW=1MHz was used.
6. Set spectrum analyzer with RMS detector.
7. The RF fundamental frequency should be excluded against the limit line in the operating frequency band.
8. Checked that all the results comply with the emission limit line.

Example:

The limit line is derived from  $43 + 10\log(P)$ dB below the transmitter power P(Watts)

$$= P(W) - [43 + 10\log(P)] \text{ (dB)}$$

$$= [30 + 10\log(P)] \text{ (dBm)} - [43 + 10\log(P)] \text{ (dB)} = -13\text{dBm}.$$

9. For 5G NR n7/n41, the other 40 dB, and 55 dB have additionally applied same calculation above.



### 3.8 Conducted Spurious Emission

#### 3.8.1 Description of Conducted Spurious Emission Measurement

The power of any emission outside of the authorized operating frequency ranges must be lower than the transmitter power (P) by a factor of at least  $43 + 10 \log (P)$  dB.

For 5G NR n7/n41:

The power of any emission outside of the authorized operating frequency ranges must be lower than the transmitter power (P) by a factor of at least  $55 + 10 \log (P)$  dB.

It is measured by means of a calibrated spectrum analyzer and scanned from 30 MHz up to a frequency including its 10<sup>th</sup> harmonic.

#### 3.8.2 Test Procedures

1. The testing follows ANSI C63.26 section 5.7
2. The EUT was connected to spectrum analyzer and system simulator via a power divider.
3. The RF output of EUT was connected to the spectrum analyzer by RF cable and attenuator. The path loss was compensated to the results for each measurement.
4. The middle channel for the highest RF power within the transmitting frequency was measured.
5. The conducted spurious emission for the whole frequency range was taken.
6. Make the measurement with the spectrum analyzer's RBW = 1MHz, VBW = 3MHz.
7. Set spectrum analyzer with RMS detector.
8. Taking the record of maximum spurious emission.
9. The RF fundamental frequency should be excluded against the limit line in the operating frequency band.
10. The limit line is derived from  $43 + 10\log(P)$ dB below the transmitter power P(Watts)  
 $= P(W) - [43 + 10\log(P)]$  (dB)  
 $= [30 + 10\log(P)]$  (dBm) -  $[43 + 10\log(P)]$  (dB)  
 $= -13$ dBm.
11. For 5G NR n7/n41  
The limit line is derived from  $55 + 10\log(P)$ dB below the transmitter power P(Watts)  
 $= P(W) - [55 + 10\log(P)]$  (dB)  
 $= [30 + 10\log(P)]$  (dBm) -  $[55 + 10\log(P)]$  (dB)  
 $= -25$ dBm.



## 3.9 Frequency Stability

### 3.9.1 Description of Frequency Stability Measurement

The frequency stability shall be measured by variation of ambient temperature and variation of primary supply voltage to ensure that the fundamental emission stays within the authorized frequency block. The frequency stability of the transmitter shall be maintained within  $\pm 0.00025\%$  ( $\pm 2.5\text{ppm}$ ) of the center frequency.

### 3.9.2 Test Procedures for Temperature Variation

1. The testing follows ANSI C63.26 section 5.6.4
2. The EUT was set up in the thermal chamber and connected with the system simulator.
3. With power OFF, the temperature was decreased to  $-30^{\circ}\text{C}$  and the EUT was stabilized before testing. Power was applied and the maximum change in frequency was recorded within one minute.
4. With power OFF, the temperature was raised in  $10^{\circ}\text{C}$  step up to  $50^{\circ}\text{C}$ . The EUT was stabilized at each step for at least half an hour. Power was applied and the maximum frequency change was recorded within one minute.

### 3.9.3 Test Procedures for Voltage Variation

1. The testing follows ANSI C63.26 section 5.6.5
2. The EUT was placed in a temperature chamber at  $20\pm 5^{\circ}\text{C}$  and connected with the system simulator.
3. The power supply voltage to the EUT was varied from 85% to 115% of the nominal value for other than hand carried battery equipment.
4. For hand carried, battery powered equipment, reduce the primary ac or dc supply voltage to the battery operating end point, which shall be specified by the manufacturer.
5. The variation in frequency was measured for the worst case.

## 4 Radiated Test Items

### 4.1 Measuring Instruments

See list of measuring instruments of this test report.

### 4.2 Test Setup

#### 4.2.1 For radiated test below 30MHz

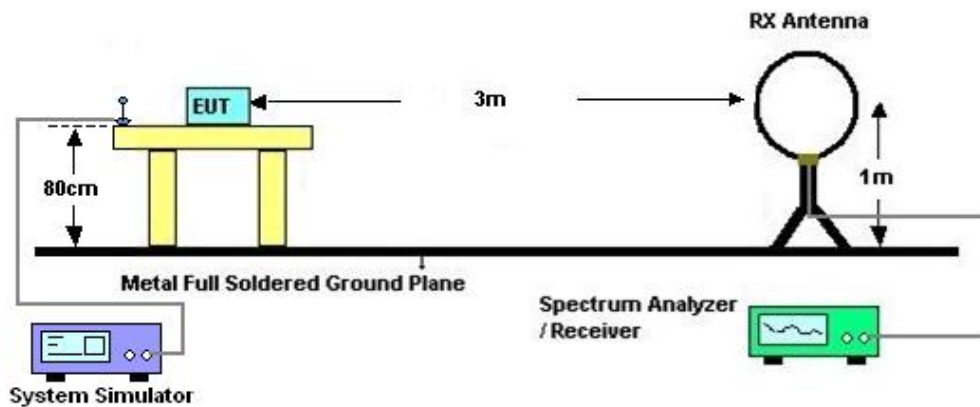

#### 4.2.2 For radiated test from 30MHz to 1GHz

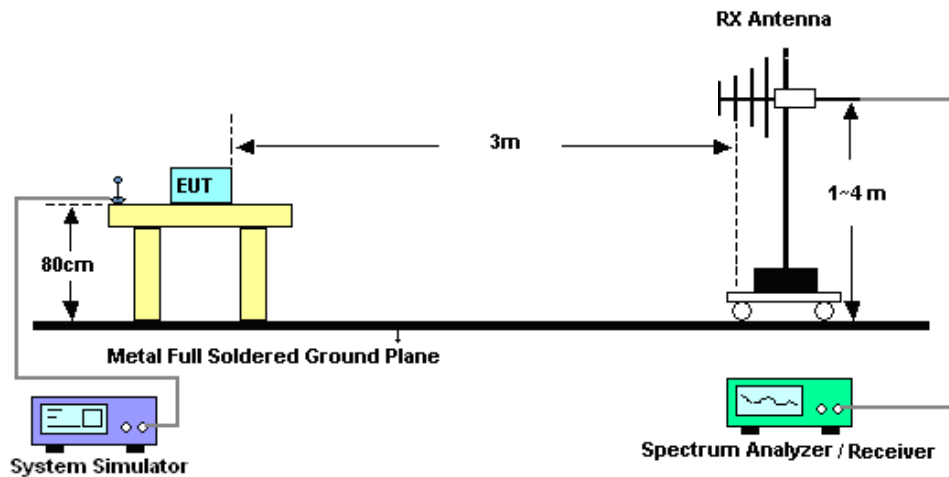

#### 4.2.3 For radiated test above 1GHz

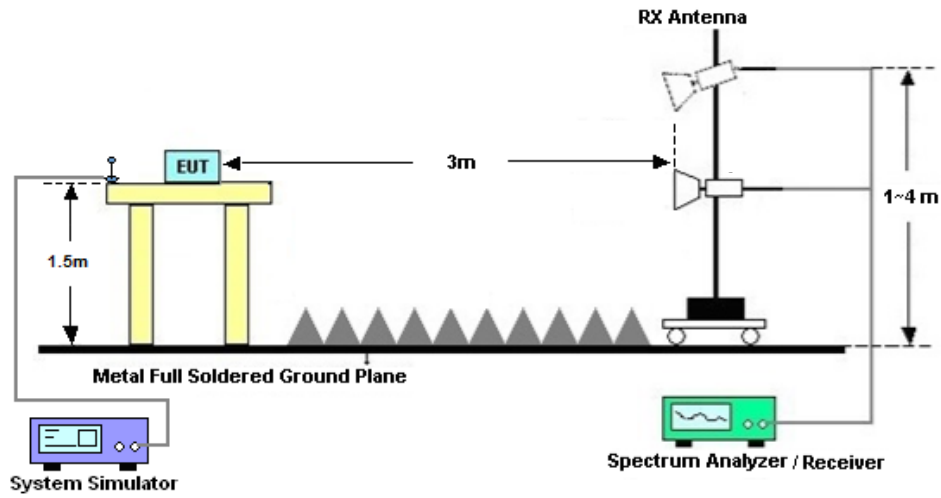

#### 4.3 Test Result of Radiated Test

The low frequency, which started from 9 kHz to 30MHz, was pre-scanned and the result which was 20dB lower than the limit line was not reported.

Please refer to Appendix B.





## 4.4 Radiated Spurious Emission

### 4.4.1 Description of Radiated Spurious Emission

The radiated spurious emission was measured by substitution method according to ANSI C63.26. The power of any emission outside of the authorized operating frequency ranges must be attenuated below the transmitter power (P) by a factor of at least  $43 + 10 \log (P)$  dB.

For 5G NR n7/n41

The power of any emission outside of the authorized operating frequency ranges must be attenuated below the transmitter power (P) by a factor of at least  $55 + 10 \log (P)$  dB.

The spectrum is scanned from 30 MHz up to a frequency including its 10th harmonic.

### 4.4.2 Test Procedures

1. The testing follows ANSI C63.26 Section 5.5
2. The EUT was placed on a turntable with 0.8 meter height for frequency below 1GHz and 1.5 meter height for frequency above 1GHz respectively above ground.
3. The EUT was set 3 meters from the receiving antenna mounted on the antenna tower.
4. The table was rotated 360 degrees to determine the position of the highest spurious emission.
5. The height of the receiving antenna is varied between 1m to 4m to search the maximum spurious emission for both horizontal and vertical polarizations.
6. During the measurement, the system simulator parameters were set to force the EUT transmitting at maximum output power.
7. Make the measurement with the spectrum analyzer's RBW = 1MHz, VBW = 3MHz, taking the record of maximum spurious emission.
8. A horn antenna was substituted in place of the EUT and was driven by a signal generator.
9. Tune the output power of signal generator to the same emission level with EUT maximum spurious emission.
10.  $EIRP (dBm) = S.G. Power - Tx Cable Loss + Tx Antenna Gain$
11.  $ERP (dBm) = EIRP - 2.15$
12. The RF fundamental frequency should be excluded against the limit line in the operating frequency band.

The limit line is derived from  $43 + 10\log(P)$ dB below the transmitter power P(Watts)  
 $= P(W) - [43 + 10\log(P)] (dB)$   
 $= [30 + 10\log(P)] (dBm) - [43 + 10\log(P)] (dB)$   
 $= -13dBm.$

13. For 5G NR n7/n41:

The limit line is derived from  $55 + 10\log(P)$ dB below the transmitter power P(Watts)The limit line is derived from  $55 + 10\log(P)$ dB below the transmitter power P(Watts)



## 5 List of Measuring Equipment

Instrument	Manufacturer	Model No.	Serial No.	Characteristics	Calibration Date	Test Date	Due Date	Remark
Spectrum Analyzer	R&S	FSV40	101078	10Hz~40GHz	Apr. 08, 2021	May 22, 2021~ Jun. 04, 2021	Apr. 07, 2022	Conducted (TH01-SZ)
Power Divider	TOJOIN	PS-2SM-04 265	60.06.020.007 7	0.4GHz~26.5GHz	Dec. 26, 2020	May 22, 2021~ Jun. 04, 2021	Dec. 25, 2021	Conducted (TH01-SZ)
Thermal Chamber	Ten Billion Hongzhangroup	LP-150U	H2014081803	-40~+150°C	Jul. 22, 2020	May 22, 2021~ Jun. 04, 2021	Jul. 21, 2021	Conducted (TH01-SZ)
EMI Test Receiver&SA	KEYSIGHT	N9038A	MY54450083	20Hz~8.4GHz	Apr. 17, 2021	Jun. 17, 2021	Apr. 16, 2022	Radiation (03CH03-SZ)
Loop Antenna	R&S	HFH2-Z2	100354	9kHz~30MHz	Jun. 22, 2020	Jun. 17, 2021	Jun. 21, 2022	Radiation (03CH03-SZ)
EXA Spectrum Analyzer	KEYSIGHT	N9010A	MY55150246	10Hz~44GHz;	Apr. 17, 2021	Jun. 17, 2021	Apr. 16, 2022	Radiation (03CH03-SZ)
Bilog Antenna	TeseQ	CBL6112D	35408	30MHz~2GHz	Jun. 22, 2020	Jun. 17, 2021	Jun. 21, 2021	Radiation (03CH03-SZ)
Double Ridge Horn Antenna	SCHWARZBECK	BBHA9120D	9120D-1355	1GHz~18GHz	Apr. 25, 2021	Jun. 17, 2021	Apr. 24, 2022	Radiation (03CH03-SZ)
Amplifier	Burgeon	BPA-530	102211	0.01Hz ~3000MHz	Oct. 17, 2020	Jun. 17, 2021	Oct. 16, 2021	Radiation (03CH03-SZ)
HF Amplifier	MITEQ	TTA1840-35 -HG	1871923	18GHz~40GHz	Jul. 21, 2020	Jun. 17, 2021	Jul. 20, 2021	Radiation (03CH03-SZ)
SHF-EHF Horn	com-power	AH-840	101071	18Ghz-40GHz	Apr. 23, 2021	Jun. 17, 2021	Apr. 22, 2022	Radiation (03CH03-SZ)
Amplifier	Agilent Technologies	83017A	MY39501302	500MHz~26.5GHz	Dec. 25, 2020	Jun. 17, 2021	Dec. 24, 2021	Radiation (03CH03-SZ)
AC Power Source	Chroma	61601	616010001985	N/A	NCR	Jun. 17, 2021	NCR	Radiation (03CH03-SZ)
Turn Table	EM	EM1000	N/A	0~360 degree	NCR	Jun. 17, 2021	NCR	Radiation (03CH03-SZ)
Antenna Mast	EM	EM1000	N/A	1 m~4 m	NCR	Jun. 17, 2021	NCR	Radiation (03CH03-SZ)

NCR: No Calibration Required



## 6 Uncertainty of Evaluation

The measurement uncertainties shown below were calculated in accordance with the requirements of ANSI 63.26-2015. All the measurement uncertainty value were shown with a coverage K=2 to indicate 95% level of confidence. The measurement data show herein meets or exceeds the CISPR measurement uncertainty values specified in CISPR 16-4-2 and can be compared directly to specified limit to determine compliance.

### Uncertainty of Radiated Emission Measurement (30 MHz ~ 1000 MHz)

Measuring Uncertainty for a Level of Confidence of 95% (U = 2Uc(y))	3.0dB
---	-------

### Uncertainty of Radiated Emission Measurement (1 GHz ~ 18 GHz)

Measuring Uncertainty for a Level of Confidence of 95% (U = 2Uc(y))	3.6dB
---	-------

### Uncertainty of Radiated Emission Measurement (18 GHz ~ 40 GHz)

Measuring Uncertainty for a Level of Confidence of 95% (U = 2Uc(y))	3.8dB
---	-------



## Appendix A. Test Results of Conducted Test

# FR1 N5

LTE Band: 7, LTE BW: 20M, LTE ARFCN: Mid

## Transmitter Conducted Output Power And ERP/EIRP, ( $G_T - L_C$ )=-4.8dB

NR Band	SCS (kHz)	Bandwidth (MHz)	Arfcn	Freq (MHz)	Modulation	RB	Conducted Power(dBm)	ERP(dBm)	ERP(W)
5	15	5	174300	826.5	DFT-s-OFDM PI/2 BPSK	12@6	22.72	15.78	0.0378
5	15	5	174300	826.5	DFT-s-OFDM PI/2 BPSK	1@1	23.2	16.26	0.0423
5	15	5	174300	826.5	DFT-s-OFDM PI/2 BPSK	1@23	23.22	16.28	0.0425
5	15	5	174300	826.5	DFT-s-OFDM QPSK	12@6	23.08	16.14	0.0411
5	15	5	174300	826.5	DFT-s-OFDM QPSK	1@1	23.04	16.1	0.0407
5	15	5	174300	826.5	DFT-s-OFDM QPSK	1@23	23.2	16.26	0.0423
5	15	5	174300	826.5	DFT-s-OFDM 16 QAM	12@6	22.17	15.23	0.0333
5	15	5	174300	826.5	DFT-s-OFDM 16 QAM	1@1	22.24	15.3	0.0339
5	15	5	174300	826.5	DFT-s-OFDM 16 QAM	1@23	22.18	15.24	0.0334
5	15	5	174300	826.5	DFT-s-OFDM 64 QAM	12@6	20.82	13.88	0.0244
5	15	5	174300	826.5	DFT-s-OFDM 64 QAM	1@1	20.97	14.03	0.0253
5	15	5	174300	826.5	DFT-s-OFDM 64 QAM	1@23	20.85	13.91	0.0246
5	15	5	174300	826.5	DFT-s-OFDM 256 QAM	12@6	18.63	11.69	0.0148
5	15	5	174300	826.5	DFT-s-OFDM 256 QAM	1@1	18.27	11.33	0.0136
5	15	5	174300	826.5	DFT-s-OFDM 256 QAM	1@23	18.23	11.29	0.0135
5	15	5	174300	826.5	CP-OFDM QPSK	13@6	21.66	14.72	0.0296
5	15	5	174300	826.5	CP-OFDM QPSK	1@1	22.03	15.09	0.0323
5	15	5	174300	826.5	CP-OFDM QPSK	1@23	21.85	14.91	0.031

5	15	5	176300	836.5	DFT-s-OFDM PI/2 BPSK	12@6	23.04	16.1	0.0407
5	15	5	176300	836.5	DFT-s-OFDM PI/2 BPSK	1@1	23.25	16.31	0.0428
5	15	5	176300	836.5	DFT-s-OFDM PI/2 BPSK	1@23	23.22	16.28	0.0425
5	15	5	176300	836.5	DFT-s-OFDM QPSK	12@6	23.01	16.07	0.0405
5	15	5	176300	836.5	DFT-s-OFDM QPSK	1@1	23.15	16.21	0.0418
5	15	5	176300	836.5	DFT-s-OFDM QPSK	1@23	23.23	16.29	0.0426
5	15	5	176300	836.5	DFT-s-OFDM 16 QAM	12@6	22.31	15.37	0.0344
5	15	5	176300	836.5	DFT-s-OFDM 16 QAM	1@1	22.24	15.3	0.0339
5	15	5	176300	836.5	DFT-s-OFDM 16 QAM	1@23	22.22	15.28	0.0337
5	15	5	176300	836.5	DFT-s-OFDM 64 QAM	12@6	20.67	13.73	0.0236
5	15	5	176300	836.5	DFT-s-OFDM 64 QAM	1@1	20.91	13.97	0.0249
5	15	5	176300	836.5	DFT-s-OFDM 64 QAM	1@23	20.76	13.82	0.0241
5	15	5	176300	836.5	DFT-s-OFDM 256 QAM	12@6	18.6	11.66	0.0147
5	15	5	176300	836.5	DFT-s-OFDM 256 QAM	1@1	18.11	11.17	0.0131
5	15	5	176300	836.5	DFT-s-OFDM 256 QAM	1@23	18.08	11.14	0.013
5	15	5	176300	836.5	CP-OFDM QPSK	13@6	21.53	14.59	0.0288
5	15	5	176300	836.5	CP-OFDM QPSK	1@1	21.55	14.61	0.0289
5	15	5	176300	836.5	CP-OFDM QPSK	1@23	21.55	14.61	0.0289
5	15	5	178300	846.5	DFT-s-OFDM PI/2 BPSK	12@6	22.99	16.05	0.0403
5	15	5	178300	846.5	DFT-s-OFDM PI/2 BPSK	1@1	23.16	16.22	0.0419
5	15	5	178300	846.5	DFT-s-OFDM PI/2 BPSK	1@23	23.12	16.18	0.0415
5	15	5	178300	846.5	DFT-s-OFDM QPSK	12@6	22.9	15.96	0.0394
5	15	5	178300	846.5	DFT-s-OFDM QPSK	1@1	23.07	16.13	0.041
5	15	5	178300	846.5	DFT-s-OFDM QPSK	1@23	23.04	16.1	0.0407

5	15	5	178300	846.5	DFT-s-OFDM 16 QAM	12@6	21.95	15.01	0.0317
5	15	5	178300	846.5	DFT-s-OFDM 16 QAM	1@1	22.07	15.13	0.0326
5	15	5	178300	846.5	DFT-s-OFDM 16 QAM	1@23	22.08	15.14	0.0327
5	15	5	178300	846.5	DFT-s-OFDM 64 QAM	12@6	20.57	13.63	0.0231
5	15	5	178300	846.5	DFT-s-OFDM 64 QAM	1@1	20.73	13.79	0.0239
5	15	5	178300	846.5	DFT-s-OFDM 64 QAM	1@23	20.61	13.67	0.0233
5	15	5	178300	846.5	DFT-s-OFDM 256 QAM	12@6	18.4	11.46	0.014
5	15	5	178300	846.5	DFT-s-OFDM 256 QAM	1@1	17.96	11.02	0.0126
5	15	5	178300	846.5	DFT-s-OFDM 256 QAM	1@23	17.87	10.93	0.0124
5	15	5	178300	846.5	CP-OFDM QPSK	13@6	21.64	14.7	0.0295
5	15	5	178300	846.5	CP-OFDM QPSK	1@1	21.49	14.55	0.0285
5	15	5	178300	846.5	CP-OFDM QPSK	1@23	21.69	14.75	0.0299
5	15	10	174800	829.0	DFT-s-OFDM PI/2 BPSK	25@12	22.78	15.84	0.0384
5	15	10	174800	829.0	DFT-s-OFDM PI/2 BPSK	1@1	23.23	16.29	0.0426
5	15	10	174800	829.0	DFT-s-OFDM PI/2 BPSK	1@50	23.11	16.17	0.0414
5	15	10	174800	829.0	DFT-s-OFDM QPSK	25@12	23.13	16.19	0.0416
5	15	10	174800	829.0	DFT-s-OFDM QPSK	1@1	23.18	16.24	0.0421
5	15	10	174800	829.0	DFT-s-OFDM QPSK	1@50	23.05	16.11	0.0408
5	15	10	174800	829.0	DFT-s-OFDM 16 QAM	25@12	22.25	15.31	0.034
5	15	10	174800	829.0	DFT-s-OFDM 16 QAM	1@1	22.21	15.27	0.0337
5	15	10	174800	829.0	DFT-s-OFDM 16 QAM	1@50	22.14	15.2	0.0331
5	15	10	174800	829.0	DFT-s-OFDM 64 QAM	25@12	20.7	13.76	0.0238
5	15	10	174800	829.0	DFT-s-OFDM 64 QAM	1@1	20.91	13.97	0.0249
5	15	10	174800	829.0	DFT-s-OFDM 64 QAM	1@50	20.69	13.75	0.0237

5	15	10	174800	829.0	DFT-s-OFDM 256 QAM	25@12	18.61	11.67	0.0147
5	15	10	174800	829.0	DFT-s-OFDM 256 QAM	1@1	18.67	11.73	0.0149
5	15	10	174800	829.0	DFT-s-OFDM 256 QAM	1@50	18.59	11.65	0.0146
5	15	10	174800	829.0	CP-OFDM QPSK	26@13	21.71	14.77	0.03
5	15	10	174800	829.0	CP-OFDM QPSK	1@1	21.87	14.93	0.0311
5	15	10	174800	829.0	CP-OFDM QPSK	1@50	21.46	14.52	0.0283
5	15	10	176300	836.5	DFT-s-OFDM PI/2 BPSK	25@12	23.14	16.2	0.0417
5	15	10	176300	836.5	DFT-s-OFDM PI/2 BPSK	1@1	23.07	16.13	0.041
5	15	10	176300	836.5	DFT-s-OFDM PI/2 BPSK	1@50	23.16	16.22	0.0419
5	15	10	176300	836.5	DFT-s-OFDM QPSK	25@12	23.04	16.1	0.0407
5	15	10	176300	836.5	DFT-s-OFDM QPSK	1@1	23.09	16.15	0.0412
5	15	10	176300	836.5	DFT-s-OFDM QPSK	1@50	23.08	16.14	0.0411
5	15	10	176300	836.5	DFT-s-OFDM 16 QAM	25@12	22.15	15.21	0.0332
5	15	10	176300	836.5	DFT-s-OFDM 16 QAM	1@1	22.04	15.1	0.0324
5	15	10	176300	836.5	DFT-s-OFDM 16 QAM	1@50	22.09	15.15	0.0327
5	15	10	176300	836.5	DFT-s-OFDM 64 QAM	25@12	20.59	13.65	0.0232
5	15	10	176300	836.5	DFT-s-OFDM 64 QAM	1@1	20.78	13.84	0.0242
5	15	10	176300	836.5	DFT-s-OFDM 64 QAM	1@50	20.73	13.79	0.0239
5	15	10	176300	836.5	DFT-s-OFDM 256 QAM	25@12	18.59	11.65	0.0146
5	15	10	176300	836.5	DFT-s-OFDM 256 QAM	1@1	18.59	11.65	0.0146
5	15	10	176300	836.5	DFT-s-OFDM 256 QAM	1@50	18.48	11.54	0.0143
5	15	10	176300	836.5	CP-OFDM QPSK	26@13	21.68	14.74	0.0298
5	15	10	176300	836.5	CP-OFDM QPSK	1@1	21.7	14.76	0.0299
5	15	10	176300	836.5	CP-OFDM QPSK	1@50	21.78	14.84	0.0305



5	15	10	177800	844.0	DFT-s-OFDM PI/2 BPSK	25@12	23.05	16.11	0.0408
5	15	10	177800	844.0	DFT-s-OFDM PI/2 BPSK	1@1	23.06	16.12	0.0409
5	15	10	177800	844.0	DFT-s-OFDM PI/2 BPSK	1@50	22.9	15.96	0.0394
5	15	10	177800	844.0	DFT-s-OFDM QPSK	25@12	23.0	16.06	0.0404
5	15	10	177800	844.0	DFT-s-OFDM QPSK	1@1	23.0	16.06	0.0404
5	15	10	177800	844.0	DFT-s-OFDM QPSK	1@50	22.95	16.01	0.0399
5	15	10	177800	844.0	DFT-s-OFDM 16 QAM	25@12	22.05	15.11	0.0324
5	15	10	177800	844.0	DFT-s-OFDM 16 QAM	1@1	22.11	15.17	0.0329
5	15	10	177800	844.0	DFT-s-OFDM 16 QAM	1@50	21.95	15.01	0.0317
5	15	10	177800	844.0	DFT-s-OFDM 64 QAM	25@12	20.48	13.54	0.0226
5	15	10	177800	844.0	DFT-s-OFDM 64 QAM	1@1	20.73	13.79	0.0239
5	15	10	177800	844.0	DFT-s-OFDM 64 QAM	1@50	20.56	13.62	0.023
5	15	10	177800	844.0	DFT-s-OFDM 256 QAM	25@12	18.36	11.42	0.0139
5	15	10	177800	844.0	DFT-s-OFDM 256 QAM	1@1	18.49	11.55	0.0143
5	15	10	177800	844.0	DFT-s-OFDM 256 QAM	1@50	18.39	11.45	0.014
5	15	10	177800	844.0	CP-OFDM QPSK	26@13	21.47	14.53	0.0284
5	15	10	177800	844.0	CP-OFDM QPSK	1@1	21.74	14.8	0.0302
5	15	10	177800	844.0	CP-OFDM QPSK	1@50	21.45	14.51	0.0282
5	15	15	175300	831.5	DFT-s-OFDM PI/2 BPSK	36@18	22.63	15.69	0.0371
5	15	15	175300	831.5	DFT-s-OFDM PI/2 BPSK	1@1	23.13	16.19	0.0416
5	15	15	175300	831.5	DFT-s-OFDM PI/2 BPSK	1@77	23.06	16.12	0.0409
5	15	15	175300	831.5	DFT-s-OFDM QPSK	36@18	23.12	16.18	0.0415
5	15	15	175300	831.5	DFT-s-OFDM QPSK	1@1	22.94	16.0	0.0398
5	15	15	175300	831.5	DFT-s-OFDM QPSK	1@77	22.97	16.03	0.0401

5	15	15	175300	831.5	DFT-s-OFDM 16 QAM	36@18	22.08	15.14	0.0327
5	15	15	175300	831.5	DFT-s-OFDM 16 QAM	1@1	21.97	15.03	0.0318
5	15	15	175300	831.5	DFT-s-OFDM 16 QAM	1@77	21.98	15.04	0.0319
5	15	15	175300	831.5	DFT-s-OFDM 64 QAM	36@18	20.61	13.67	0.0233
5	15	15	175300	831.5	DFT-s-OFDM 64 QAM	1@1	20.81	13.87	0.0244
5	15	15	175300	831.5	DFT-s-OFDM 64 QAM	1@77	20.71	13.77	0.0238
5	15	15	175300	831.5	DFT-s-OFDM 256 QAM	36@18	18.49	11.55	0.0143
5	15	15	175300	831.5	DFT-s-OFDM 256 QAM	1@1	18.11	11.17	0.0131
5	15	15	175300	831.5	DFT-s-OFDM 256 QAM	1@77	18.08	11.14	0.013
5	15	15	175300	831.5	CP-OFDM QPSK	39@191	20.15	13.21	0.0209
5	15	15	175300	831.5	CP-OFDM QPSK	1@1	21.62	14.68	0.0294
5	15	15	175300	831.5	CP-OFDM QPSK	1@77	21.52	14.58	0.0287
5	15	15	176300	836.5	DFT-s-OFDM PI/2 BPSK	36@18	23.01	16.07	0.0405
5	15	15	176300	836.5	DFT-s-OFDM PI/2 BPSK	1@1	22.98	16.04	0.0402
5	15	15	176300	836.5	DFT-s-OFDM PI/2 BPSK	1@77	23.0	16.06	0.0404
5	15	15	176300	836.5	DFT-s-OFDM QPSK	36@18	23.12	16.18	0.0415
5	15	15	176300	836.5	DFT-s-OFDM QPSK	1@1	22.96	16.02	0.04
5	15	15	176300	836.5	DFT-s-OFDM QPSK	1@77	22.93	15.99	0.0397
5	15	15	176300	836.5	DFT-s-OFDM 16 QAM	36@18	22.13	15.19	0.033
5	15	15	176300	836.5	DFT-s-OFDM 16 QAM	1@1	22.07	15.13	0.0326
5	15	15	176300	836.5	DFT-s-OFDM 16 QAM	1@77	21.92	14.98	0.0315
5	15	15	176300	836.5	DFT-s-OFDM 64 QAM	36@18	20.59	13.65	0.0232
5	15	15	176300	836.5	DFT-s-OFDM 64 QAM	1@1	20.82	13.88	0.0244
5	15	15	176300	836.5	DFT-s-OFDM 64 QAM	1@77	20.66	13.72	0.0236

5	15	15	176300	836.5	DFT-s-OFDM 256 QAM	36@18	18.51	11.57	0.0144
5	15	15	176300	836.5	DFT-s-OFDM 256 QAM	1@1	18.05	11.11	0.0129
5	15	15	176300	836.5	DFT-s-OFDM 256 QAM	1@77	18.09	11.15	0.013
5	15	15	176300	836.5	CP-OFDM QPSK	39@191	19.99	13.05	0.0202
5	15	15	176300	836.5	CP-OFDM QPSK	1@1	21.73	14.79	0.0301
5	15	15	176300	836.5	CP-OFDM QPSK	1@77	21.51	14.57	0.0286
5	15	15	177300	841.5	DFT-s-OFDM PI/2 BPSK	36@18	22.91	15.97	0.0395
5	15	15	177300	841.5	DFT-s-OFDM PI/2 BPSK	1@1	22.98	16.04	0.0402
5	15	15	177300	841.5	DFT-s-OFDM PI/2 BPSK	1@77	22.88	15.94	0.0393
5	15	15	177300	841.5	DFT-s-OFDM QPSK	36@18	22.96	16.02	0.04
5	15	15	177300	841.5	DFT-s-OFDM QPSK	1@1	23.0	16.06	0.0404
5	15	15	177300	841.5	DFT-s-OFDM QPSK	1@77	22.83	15.89	0.0388
5	15	15	177300	841.5	DFT-s-OFDM 16 QAM	36@18	22.01	15.07	0.0321
5	15	15	177300	841.5	DFT-s-OFDM 16 QAM	1@1	21.98	15.04	0.0319
5	15	15	177300	841.5	DFT-s-OFDM 16 QAM	1@77	21.78	14.84	0.0305
5	15	15	177300	841.5	DFT-s-OFDM 64 QAM	36@18	20.56	13.62	0.023
5	15	15	177300	841.5	DFT-s-OFDM 64 QAM	1@1	20.63	13.69	0.0234
5	15	15	177300	841.5	DFT-s-OFDM 64 QAM	1@77	20.58	13.64	0.0231
5	15	15	177300	841.5	DFT-s-OFDM 256 QAM	36@18	18.39	11.45	0.014
5	15	15	177300	841.5	DFT-s-OFDM 256 QAM	1@1	18.04	11.1	0.0129
5	15	15	177300	841.5	DFT-s-OFDM 256 QAM	1@77	17.97	11.03	0.0127
5	15	15	177300	841.5	CP-OFDM QPSK	39@191	19.98	13.04	0.0201
5	15	15	177300	841.5	CP-OFDM QPSK	1@1	21.67	14.73	0.0297
5	15	15	177300	841.5	CP-OFDM QPSK	1@77	21.38	14.44	0.0278

5	15	20	175800	834.0	DFT-s-OFDM PI/2 BPSK	50@25	22.65	15.71	0.0372
5	15	20	175800	834.0	DFT-s-OFDM PI/2 BPSK	1@1	23.0	16.06	0.0404
5	15	20	175800	834.0	DFT-s-OFDM PI/2 BPSK	1@104	22.91	15.97	0.0395
5	15	20	175800	834.0	DFT-s-OFDM QPSK	50@25	22.96	16.02	0.04
5	15	20	175800	834.0	DFT-s-OFDM QPSK	1@1	23.07	16.13	0.041
5	15	20	175800	834.0	DFT-s-OFDM QPSK	1@104	22.95	16.01	0.0399
5	15	20	175800	834.0	DFT-s-OFDM 16 QAM	50@25	22.06	15.12	0.0325
5	15	20	175800	834.0	DFT-s-OFDM 16 QAM	1@1	22.03	15.09	0.0323
5	15	20	175800	834.0	DFT-s-OFDM 16 QAM	1@104	21.92	14.98	0.0315
5	15	20	175800	834.0	DFT-s-OFDM 64 QAM	50@25	20.6	13.66	0.0232
5	15	20	175800	834.0	DFT-s-OFDM 64 QAM	1@1	20.78	13.84	0.0242
5	15	20	175800	834.0	DFT-s-OFDM 64 QAM	1@104	21.46	14.52	0.0283
5	15	20	175800	834.0	DFT-s-OFDM 256 QAM	50@25	18.52	11.58	0.0144
5	15	20	175800	834.0	DFT-s-OFDM 256 QAM	1@1	18.1	11.16	0.0131
5	15	20	175800	834.0	DFT-s-OFDM 256 QAM	1@104	18.09	11.15	0.013
5	15	20	175800	834.0	CP-OFDM QPSK	53@26	21.58	14.64	0.0291
5	15	20	175800	834.0	CP-OFDM QPSK	1@1	21.49	14.55	0.0285
5	15	20	175800	834.0	CP-OFDM QPSK	1@104	21.52	14.58	0.0287
5	15	20	176300	836.5	DFT-s-OFDM PI/2 BPSK	50@25	23.15	16.21	0.0418
5	15	20	176300	836.5	DFT-s-OFDM PI/2 BPSK	1@1	23.0	16.06	0.0404
5	15	20	176300	836.5	DFT-s-OFDM PI/2 BPSK	1@104	22.83	15.89	0.0388
5	15	20	176300	836.5	DFT-s-OFDM QPSK	50@25	23.03	16.09	0.0406
5	15	20	176300	836.5	DFT-s-OFDM QPSK	1@1	23.08	16.14	0.0411
5	15	20	176300	836.5	DFT-s-OFDM QPSK	1@104	22.81	15.87	0.0386

5	15	20	176300	836.5	DFT-s-OFDM 16 QAM	50@25	22.13	15.19	0.033
5	15	20	176300	836.5	DFT-s-OFDM 16 QAM	1@1	22.13	15.19	0.033
5	15	20	176300	836.5	DFT-s-OFDM 16 QAM	1@104	21.87	14.93	0.0311
5	15	20	176300	836.5	DFT-s-OFDM 64 QAM	50@25	20.66	13.72	0.0236
5	15	20	176300	836.5	DFT-s-OFDM 64 QAM	1@1	20.42	13.48	0.0223
5	15	20	176300	836.5	DFT-s-OFDM 64 QAM	1@104	21.48	14.54	0.0284
5	15	20	176300	836.5	DFT-s-OFDM 256 QAM	50@25	18.54	11.6	0.0145
5	15	20	176300	836.5	DFT-s-OFDM 256 QAM	1@1	18.15	11.21	0.0132
5	15	20	176300	836.5	DFT-s-OFDM 256 QAM	1@104	17.97	11.03	0.0127
5	15	20	176300	836.5	CP-OFDM QPSK	53@26	21.56	14.62	0.029
5	15	20	176300	836.5	CP-OFDM QPSK	1@1	21.59	14.65	0.0292
5	15	20	176300	836.5	CP-OFDM QPSK	1@104	21.27	14.33	0.0271
5	15	20	176800	839.0	DFT-s-OFDM PI/2 BPSK	50@25	22.96	16.02	0.04
5	15	20	176800	839.0	DFT-s-OFDM PI/2 BPSK	1@1	23.1	16.16	0.0413
5	15	20	176800	839.0	DFT-s-OFDM PI/2 BPSK	1@104	22.74	15.8	0.038
5	15	20	176800	839.0	DFT-s-OFDM QPSK	50@25	23.02	16.08	0.0406
5	15	20	176800	839.0	DFT-s-OFDM QPSK	1@1	23.45	16.50	0.0447
5	15	20	176800	839.0	DFT-s-OFDM QPSK	1@104	22.85	15.91	0.039
5	15	20	176800	839.0	DFT-s-OFDM 16 QAM	50@25	22.04	15.1	0.0324
5	15	20	176800	839.0	DFT-s-OFDM 16 QAM	1@1	21.98	15.04	0.0319
5	15	20	176800	839.0	DFT-s-OFDM 16 QAM	1@104	21.77	14.83	0.0304
5	15	20	176800	839.0	DFT-s-OFDM 64 QAM	50@25	20.63	13.69	0.0234
5	15	20	176800	839.0	DFT-s-OFDM 64 QAM	1@1	20.71	13.77	0.0238
5	15	20	176800	839.0	DFT-s-OFDM 64 QAM	1@104	21.35	14.41	0.0276

5	15	20	176800	839.0	DFT-s-OFDM 256 QAM	50@25	18.49	11.55	0.0143
5	15	20	176800	839.0	DFT-s-OFDM 256 QAM	1@1	18.12	11.18	0.0131
5	15	20	176800	839.0	DFT-s-OFDM 256 QAM	1@104	17.94	11.0	0.0126
5	15	20	176800	839.0	CP-OFDM QPSK	53@26	21.56	14.62	0.029
5	15	20	176800	839.0	CP-OFDM QPSK	1@1	21.68	14.74	0.0298
5	15	20	176800	839.0	CP-OFDM QPSK	1@104	21.45	14.51	0.0282

### Frequency Stability

NR Band	SCS (kHz)	Bandwidth (MHz)	Arfcn	Freq (MHz)	Modulation	RB	Deviation (ppm)	Verdict	Environment
5	15	20	176300	836.5	DFT-s-OFDM QPSK	100@0	0.00681	PASS	NV
5	15	20	176300	836.5	DFT-s-OFDM QPSK	100@0	0.00548	PASS	LV
5	15	20	176300	836.5	DFT-s-OFDM QPSK	100@0	0.00263	PASS	HV
5	15	20	176300	836.5	DFT-s-OFDM QPSK	100@0	0.00556	PASS	-30°C
5	15	20	176300	836.5	DFT-s-OFDM QPSK	100@0	0.00584	PASS	-20°C
5	15	20	176300	836.5	DFT-s-OFDM QPSK	100@0	0.00267	PASS	-10°C
5	15	20	176300	836.5	DFT-s-OFDM QPSK	100@0	0.00358	PASS	0°C
5	15	20	176300	836.5	DFT-s-OFDM QPSK	100@0	0.00684	PASS	10°C
5	15	20	176300	836.5	DFT-s-OFDM QPSK	100@0	0.00582	PASS	20°C
5	15	20	176300	836.5	DFT-s-OFDM QPSK	100@0	0.00624	PASS	30°C
5	15	20	176300	836.5	DFT-s-OFDM QPSK	100@0	0.00635	PASS	40°C
5	15	20	176300	836.5	DFT-s-OFDM QPSK	100@0	0.00524	PASS	50°C

## Peak to Average Ratio

NR Band	SCS (kHz)	Bandwidth (MHz)	Arfcn	Freq (MHz)	Modulation	RB	Result (dB)	Limit (dB)	Verdict
5	15	20	175800	834.0	DFT-s-OFDM PI/2 BPSK	100@0	3.87	13	PASS
5	15	20	175800	834.0	DFT-s-OFDM PI/2 BPSK	1@0	3.56	13	PASS
5	15	20	175800	834.0	DFT-s-OFDM QPSK	100@0	4.59	13	PASS
5	15	20	175800	834.0	DFT-s-OFDM QPSK	1@0	3.6	13	PASS
5	15	20	176300	836.5	DFT-s-OFDM PI/2 BPSK	100@0	3.86	13	PASS
5	15	20	176300	836.5	DFT-s-OFDM PI/2 BPSK	1@0	3.54	13	PASS
5	15	20	176300	836.5	DFT-s-OFDM QPSK	100@0	4.66	13	PASS
5	15	20	176300	836.5	DFT-s-OFDM QPSK	1@0	3.62	13	PASS
5	15	20	176800	839.0	DFT-s-OFDM PI/2 BPSK	100@0	3.93	13	PASS
5	15	20	176800	839.0	DFT-s-OFDM PI/2 BPSK	1@0	3.61	13	PASS
5	15	20	176800	839.0	DFT-s-OFDM QPSK	100@0	4.77	13	PASS
5	15	20	176800	839.0	DFT-s-OFDM QPSK	1@0	3.57	13	PASS



B7\_N5(20M)\_DFT-s-OFDM\_PI\_2-BPSK\_Outer\_Full\_Low\_CH



B7\_N5(20M)\_DFT-s-OFDM\_PI\_2-BPSK\_Edge\_1RB\_Left\_Low\_CH



B7\_N5(20M)\_DFT-s-OFDM\_QPSK\_Outer\_Full\_Low\_CH



B7\_N5(20M)\_DFT-s-OFDM\_QPSK\_Edge\_1RB\_Left\_Low\_CH

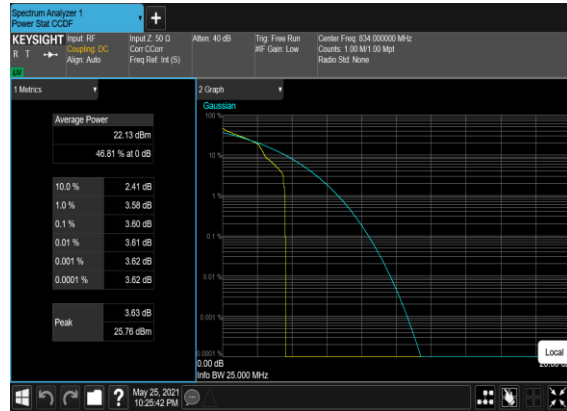

B7\_N5(20M)\_DFT-s-OFDM\_PI\_2-BPSK\_Outer\_Full\_Mid\_CH



B7\_N5(20M)\_DFT-s-OFDM\_PI\_2-BPSK\_Edge\_1RB\_Left\_Mid\_CH



B7\_N5(20M)\_DFT-s-OFDM\_QPSK\_Outer\_Full\_Mid\_CH



B7\_N5(20M)\_DFT-s-OFDM\_QPSK\_Edge\_1RB\_Left\_Mid\_CH



B7\_N5(20M)\_DFT-s-OFDM\_PI\_2-BPSK\_Outer\_Full\_High\_CH



B7\_N5(20M)\_DFT-s-OFDM\_PI\_2-BPSK\_Edge\_1RB\_Left\_High\_CH



B7\_N5(20M)\_DFT-s-OFDM\_QPSK\_Outer\_Full\_High\_CH

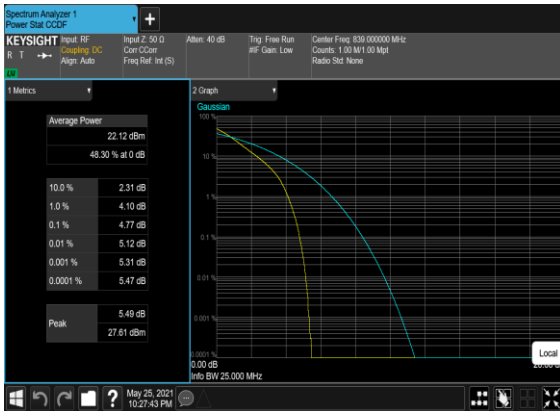

B7\_N5(20M)\_DFT-s-OFDM\_QPSK\_Edge\_1RB\_Left\_High\_CH



## Occupied Bandwidth

NR Band	SCS (kHz)	Bandwidth (MHz)	Arfcn	Freq (MHz)	Modulation	RB	OBW (MHz)	26dB OBW (MHz)
5	15	5	176300	836.5	DFT-s-OFDM PI/2 BPSK	25@0	4.463	4.837
5	15	5	176300	836.5	DFT-s-OFDM QPSK	25@0	4.47	4.835
5	15	5	176300	836.5	CP-OFDM QPSK	25@0	4.468	4.942
5	15	5	176300	836.5	CP-OFDM 16 QAM	25@0	4.488	4.952
5	15	5	176300	836.5	CP-OFDM 64 QAM	25@0	4.477	4.91
5	15	5	176300	836.5	CP-OFDM 256 QAM	25@0	4.463	4.924
5	15	10	176300	836.5	DFT-s-OFDM PI/2 BPSK	50@0	8.887	9.443
5	15	10	176300	836.5	DFT-s-OFDM QPSK	50@0	8.91	9.514
5	15	10	176300	836.5	CP-OFDM QPSK	52@0	9.27	9.927
5	15	10	176300	836.5	CP-OFDM 16 QAM	52@0	9.263	9.915
5	15	10	176300	836.5	CP-OFDM 64 QAM	52@0	9.267	9.84
5	15	10	176300	836.5	CP-OFDM 256 QAM	52@0	9.281	9.902
5	15	15	176300	836.5	DFT-s-OFDM PI/2 BPSK	75@0	13.37	14.1
5	15	15	176300	836.5	DFT-s-OFDM QPSK	75@0	13.376	14.15
5	15	15	176300	836.5	CP-OFDM QPSK	79@0	14.087	14.83
5	15	15	176300	836.5	CP-OFDM 16 QAM	79@0	14.089	14.88
5	15	15	176300	836.5	CP-OFDM 64 QAM	79@0	14.116	14.79
5	15	15	176300	836.5	CP-OFDM 256 QAM	79@0	14.066	14.75
5	15	20	176300	836.5	DFT-s-OFDM PI/2 BPSK	100@0	17.839	18.66
5	15	20	176300	836.5	DFT-s-OFDM QPSK	100@0	17.83	18.64
5	15	20	176300	836.5	CP-OFDM QPSK	106@0	18.875	19.75
5	15	20	176300	836.5	CP-OFDM 16 QAM	106@0	18.917	19.82
5	15	20	176300	836.5	CP-OFDM 64 QAM	106@0	18.894	19.79
5	15	20	176300	836.5	CP-OFDM 256 QAM	106@0	18.927	19.73

### B7\_N5(5M)\_DFT-s-OFDM\_PI\_2- BPSK\_Outer\_Full\_Mid\_CH

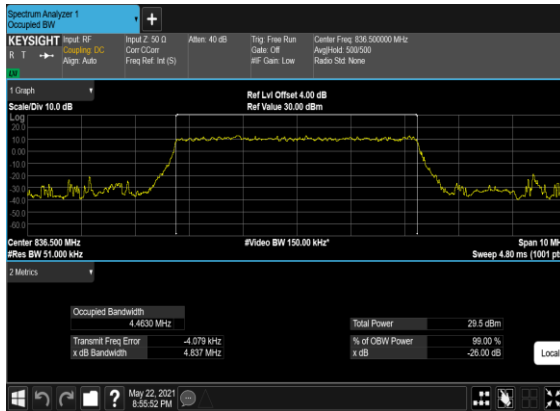

### B7\_N5(5M)\_DFT-s- OFDM\_QPSK\_Outer\_Full\_Mid\_CH

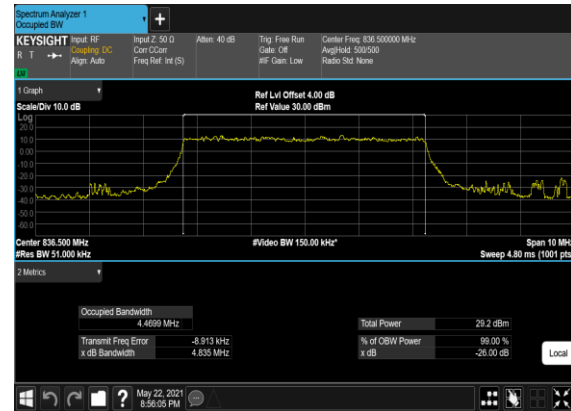

### B7\_N5(5M)\_CP- OFDM\_QPSK\_Outer\_Full\_Mid\_CH



### B7\_N5(5M)\_CP-OFDM\_16 QAM\_Outer\_Full\_Mid\_CH

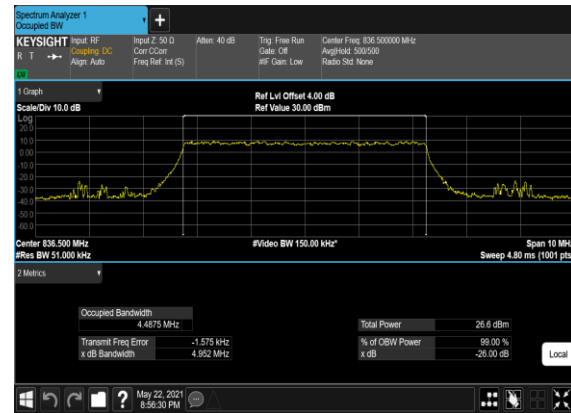

### B7\_N5(5M)\_CP-OFDM\_64 QAM\_Outer\_Full\_Mid\_CH

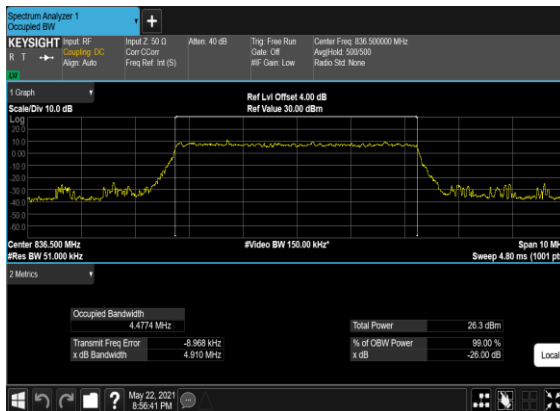

### B7\_N5(5M)\_CP-OFDM\_256 QAM\_Outer\_Full\_Mid\_CH

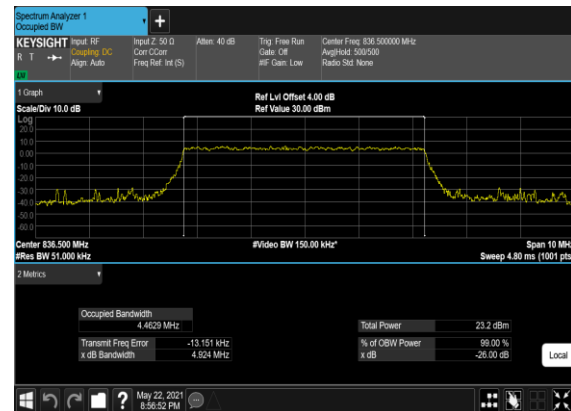

### B7\_N5(10M)\_DFT-s-OFDM\_PI\_2- BPSK\_Outer\_Full\_Mid\_CH

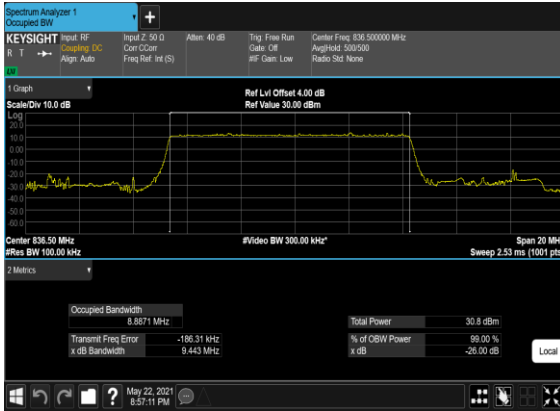

### B7\_N5(10M)\_DFT-s- OFDM\_QPSK\_Outer\_Full\_Mid\_CH

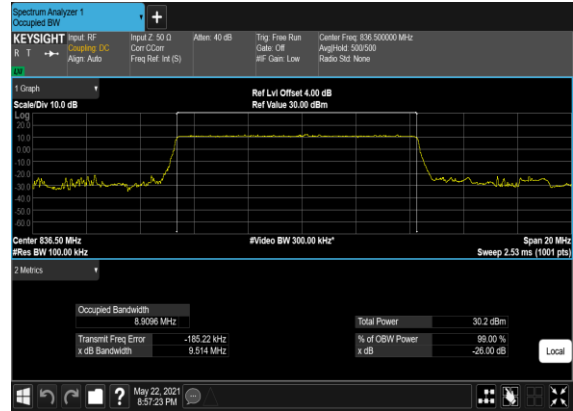

### B7\_N5(10M)\_CP- OFDM\_QPSK\_Outer\_Full\_Mid\_CH

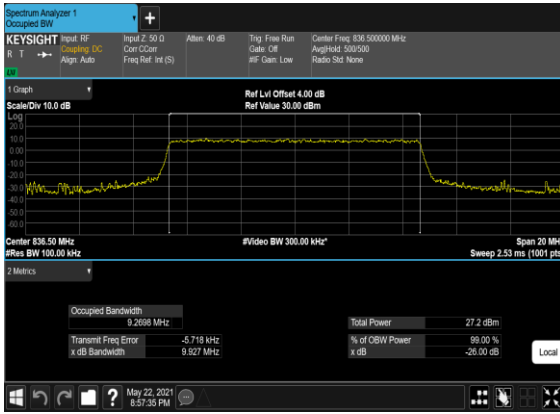

### B7\_N5(10M)\_CP-OFDM\_16 QAM\_Outer\_Full\_Mid\_CH



### B7\_N5(10M)\_CP-OFDM\_64 QAM\_Outer\_Full\_Mid\_CH

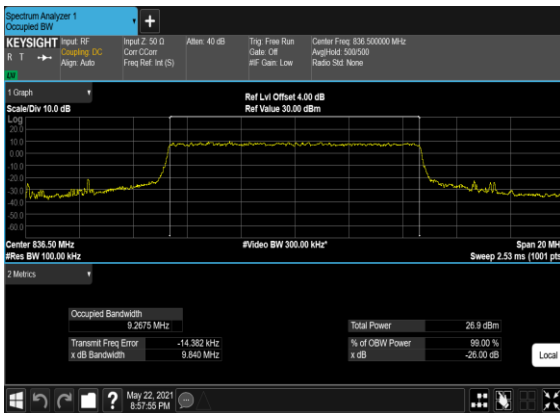

### B7\_N5(10M)\_CP-OFDM\_256 QAM\_Outer\_Full\_Mid\_CH

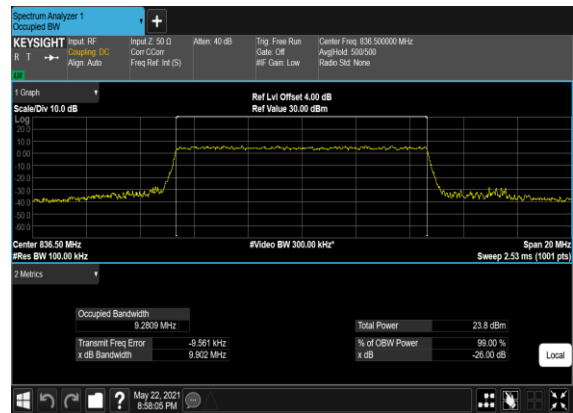

### B7\_N5(15M)\_DFT-s-OFDM\_PI\_2- BPSK\_Outer\_Full\_Mid\_CH

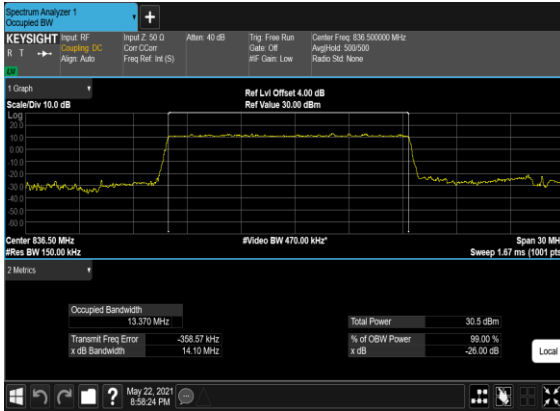

### B7\_N5(15M)\_DFT-s- OFDM\_QPSK\_Outer\_Full\_Mid\_CH

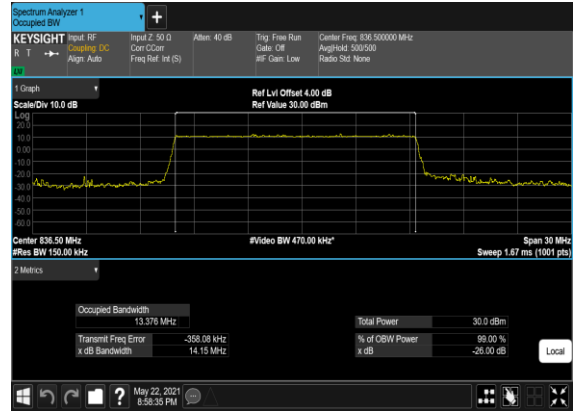

### B7\_N5(15M)\_CP- OFDM\_QPSK\_Outer\_Full\_Mid\_CH



### B7\_N5(15M)\_CP-OFDM\_16 QAM\_Outer\_Full\_Mid\_CH



### B7\_N5(15M)\_CP-OFDM\_64 QAM\_Outer\_Full\_Mid\_CH

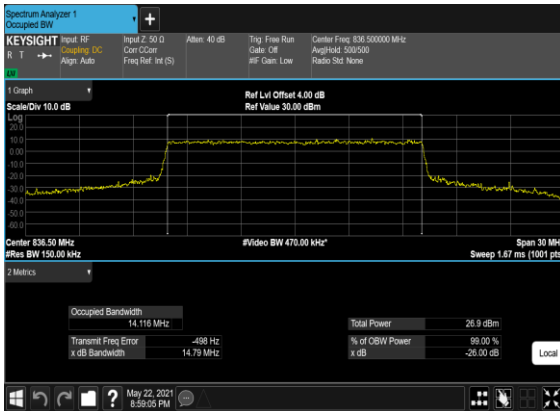

### B7\_N5(15M)\_CP-OFDM\_256 QAM\_Outer\_Full\_Mid\_CH

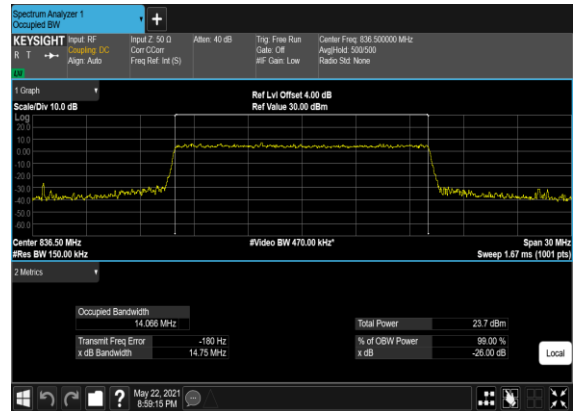

### B7\_N5(20M)\_DFT-s-OFDM\_PI\_2- BPSK\_Outer\_Full\_Mid\_CH

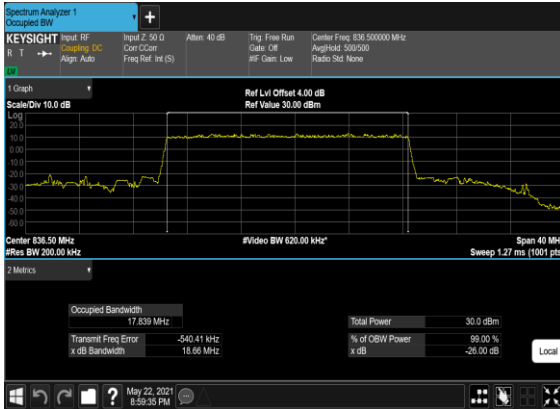

### B7\_N5(20M)\_DFT-s- OFDM\_QPSK\_Outer\_Full\_Mid\_CH



### B7\_N5(20M)\_CP- OFDM\_QPSK\_Outer\_Full\_Mid\_CH

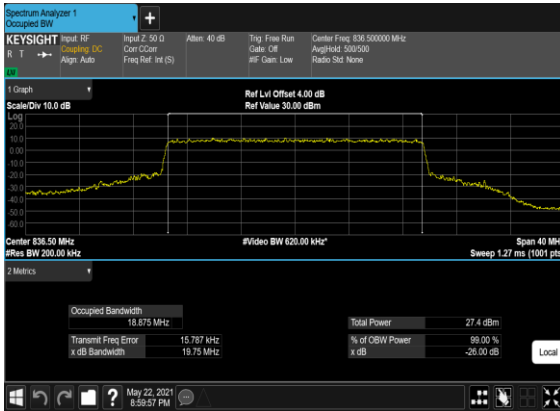

### B7\_N5(20M)\_CP-OFDM\_16 QAM\_Outer\_Full\_Mid\_CH

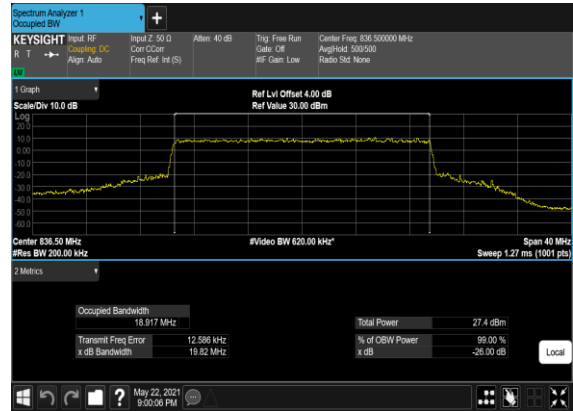

### B7\_N5(20M)\_CP-OFDM\_64 QAM\_Outer\_Full\_Mid\_CH

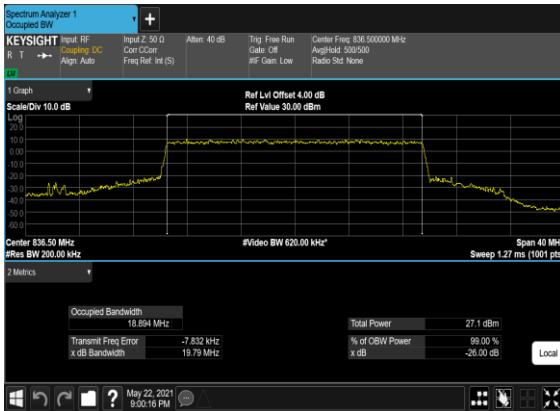

### B7\_N5(20M)\_CP-OFDM\_256 QAM\_Outer\_Full\_Mid\_CH

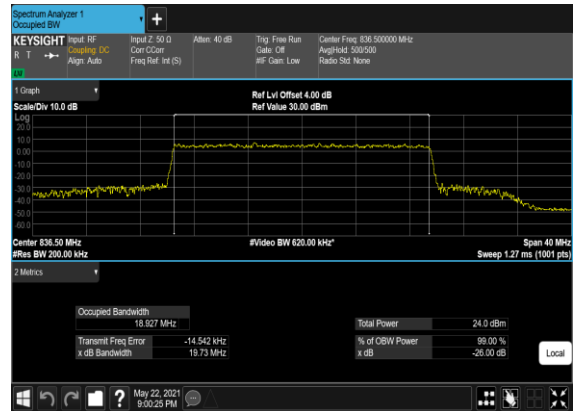

## Conducted Spurious Emissions

NR Band	SCS (kHz)	Bandwidth (MHz)	Arfcn	Freq (MHz)	Modulation	RB	Result	Verdict
5	15	5	174300	826.5	DFT-s-OFDM BPSK	1@0	see graph	---
5	15	5	174300	826.5	DFT-s-OFDM BPSK	1@0	see graph	PASS
5	15	5	174300	826.5	DFT-s-OFDM QPSK	1@0	see graph	---
5	15	5	174300	826.5	DFT-s-OFDM QPSK	1@0	see graph	PASS
5	15	5	176300	836.5	DFT-s-OFDM BPSK	1@0	see graph	---
5	15	5	176300	836.5	DFT-s-OFDM BPSK	1@0	see graph	PASS
5	15	5	176300	836.5	DFT-s-OFDM QPSK	1@0	see graph	---
5	15	5	176300	836.5	DFT-s-OFDM QPSK	1@0	see graph	PASS
5	15	5	178300	846.5	DFT-s-OFDM BPSK	1@0	see graph	---
5	15	5	178300	846.5	DFT-s-OFDM BPSK	1@0	see graph	PASS
5	15	5	178300	846.5	DFT-s-OFDM QPSK	1@0	see graph	---
5	15	5	178300	846.5	DFT-s-OFDM QPSK	1@0	see graph	PASS
5	15	10	174800	829.0	DFT-s-OFDM BPSK	1@0	see graph	---
5	15	10	174800	829.0	DFT-s-OFDM BPSK	1@0	see graph	PASS
5	15	10	174800	829.0	DFT-s-OFDM QPSK	1@0	see graph	---
5	15	10	174800	829.0	DFT-s-OFDM QPSK	1@0	see graph	PASS
5	15	10	176300	836.5	DFT-s-OFDM BPSK	1@0	see graph	---
5	15	10	176300	836.5	DFT-s-OFDM BPSK	1@0	see graph	PASS
5	15	10	176300	836.5	DFT-s-OFDM QPSK	1@0	see graph	---
5	15	10	176300	836.5	DFT-s-OFDM QPSK	1@0	see graph	PASS
5	15	10	177800	844.0	DFT-s-OFDM BPSK	1@0	see graph	---
5	15	10	177800	844.0	DFT-s-OFDM BPSK	1@0	see graph	PASS



5	15	10	177800	844.0	DFT-s-OFDM QPSK	1@0	see graph	---
5	15	10	177800	844.0	DFT-s-OFDM QPSK	1@0	see graph	PASS
5	15	20	175800	834.0	DFT-s-OFDM BPSK	1@0	see graph	---
5	15	20	175800	834.0	DFT-s-OFDM BPSK	1@0	see graph	PASS
5	15	20	175800	834.0	DFT-s-OFDM QPSK	1@0	see graph	---
5	15	20	175800	834.0	DFT-s-OFDM QPSK	1@0	see graph	PASS
5	15	20	176300	836.5	DFT-s-OFDM BPSK	1@0	see graph	---
5	15	20	176300	836.5	DFT-s-OFDM BPSK	1@0	see graph	PASS
5	15	20	176300	836.5	DFT-s-OFDM QPSK	1@0	see graph	---
5	15	20	176300	836.5	DFT-s-OFDM QPSK	1@0	see graph	PASS
5	15	20	176800	839.0	DFT-s-OFDM BPSK	1@0	see graph	---
5	15	20	176800	839.0	DFT-s-OFDM BPSK	1@0	see graph	PASS
5	15	20	176800	839.0	DFT-s-OFDM QPSK	1@0	see graph	---
5	15	20	176800	839.0	DFT-s-OFDM QPSK	1@0	see graph	PASS

### B7\_N5(5M)\_DFT-s-OFDM\_BPSK\_Edge\_1RB\_Left\_Low\_CH

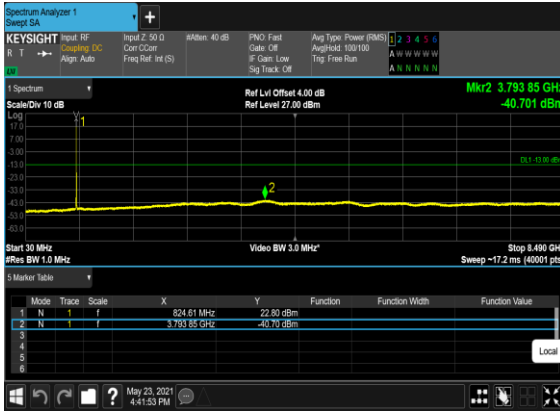

### B7\_N5(5M)\_DFT-s-OFDM\_QPSK\_Edge\_1RB\_Left\_Low\_CH

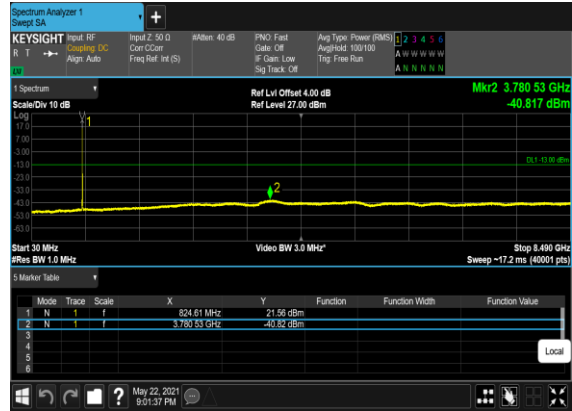

### B7\_N5(5M)\_DFT-s-OFDM\_BPSK\_Edge\_1RB\_Left\_Mid\_CH

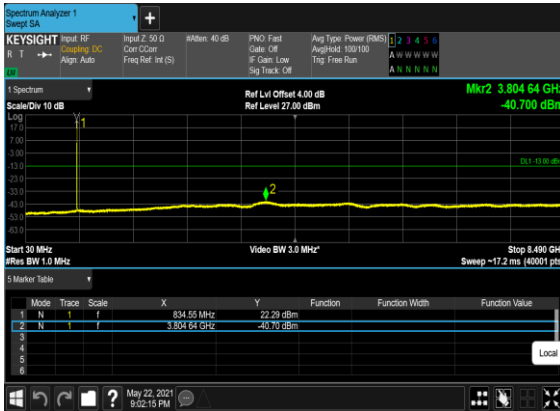

### B7\_N5(5M)\_DFT-s-OFDM\_QPSK\_Edge\_1RB\_Left\_Mid\_CH



### B7\_N5(5M)\_DFT-s-OFDM\_BPSK\_Edge\_1RB\_Left\_High\_CH

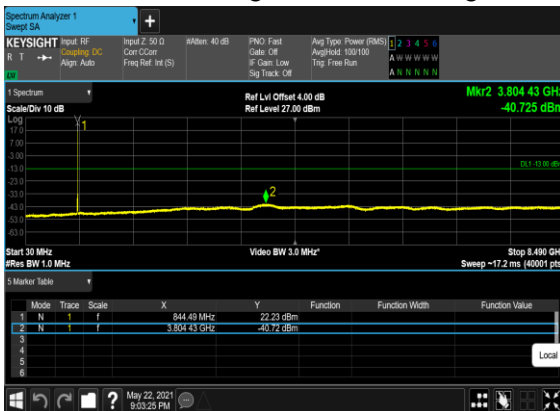

### B7\_N5(5M)\_DFT-s-OFDM\_QPSK\_Edge\_1RB\_Left\_High\_CH

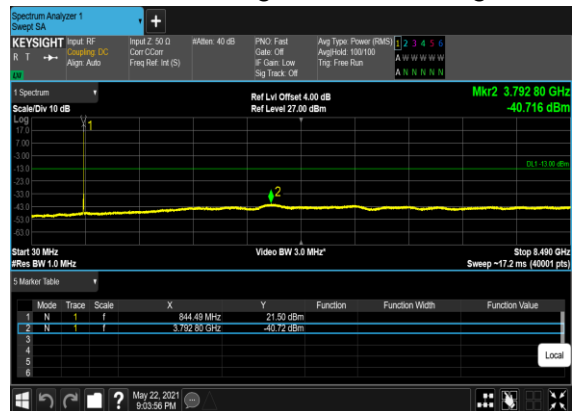

B7\_N5(10M)\_DFT-s-OFDM\_BPSK\_Edge\_1RB\_Left\_Low\_CH



B7\_N5(10M)\_DFT-s-OFDM\_QPSK\_Edge\_1RB\_Left\_Low\_CH



B7\_N5(10M)\_DFT-s-OFDM\_BPSK\_Edge\_1RB\_Left\_Mid\_CH

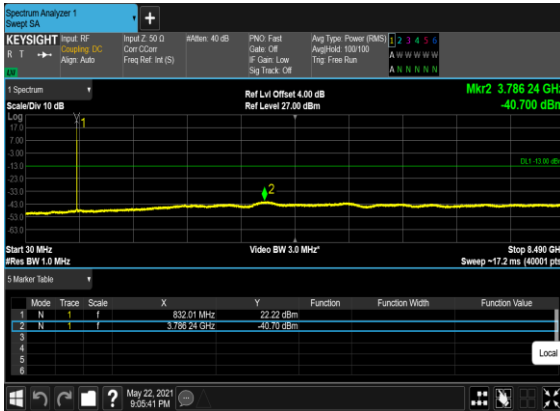

B7\_N5(10M)\_DFT-s-OFDM\_QPSK\_Edge\_1RB\_Left\_Mid\_CH

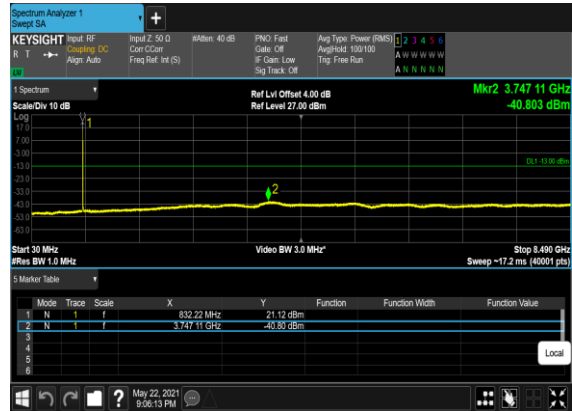

B7\_N5(10M)\_DFT-s-OFDM\_BPSK\_Edge\_1RB\_Left\_High\_CH

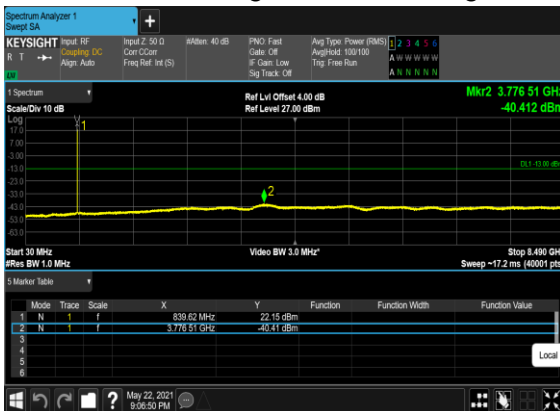

B7\_N5(10M)\_DFT-s-OFDM\_QPSK\_Edge\_1RB\_Left\_High\_CH

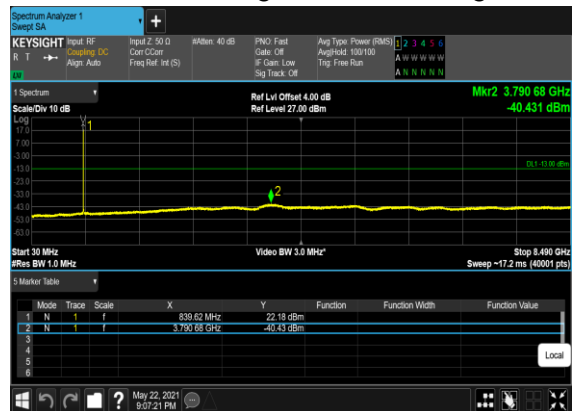

### B7\_N5(20M)\_DFT-s-OFDM\_BPSK\_Edge\_1RB\_Left\_Low\_CH

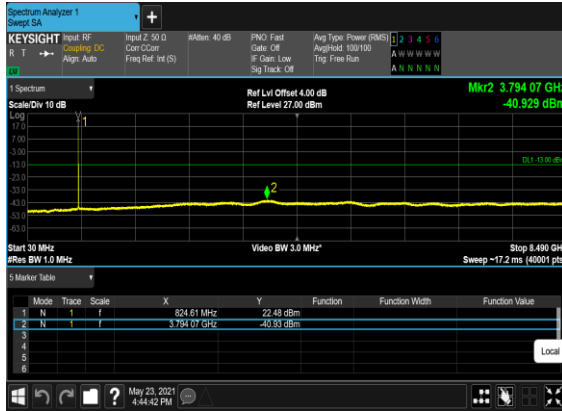

### B7\_N5(20M)\_DFT-s-OFDM\_QPSK\_Edge\_1RB\_Left\_Low\_CH

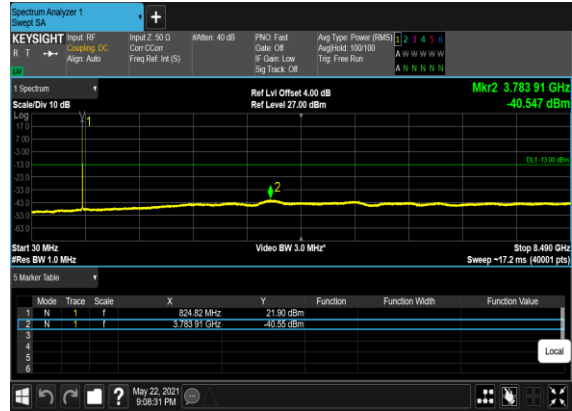

### B7\_N5(20M)\_DFT-s-OFDM\_BPSK\_Edge\_1RB\_Left\_Mid\_CH

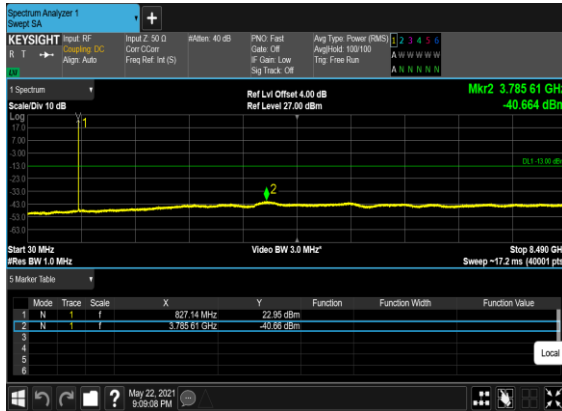

### B7\_N5(20M)\_DFT-s-OFDM\_QPSK\_Edge\_1RB\_Left\_Mid\_CH



### B7\_N5(20M)\_DFT-s-OFDM\_BPSK\_Edge\_1RB\_Left\_High\_CH

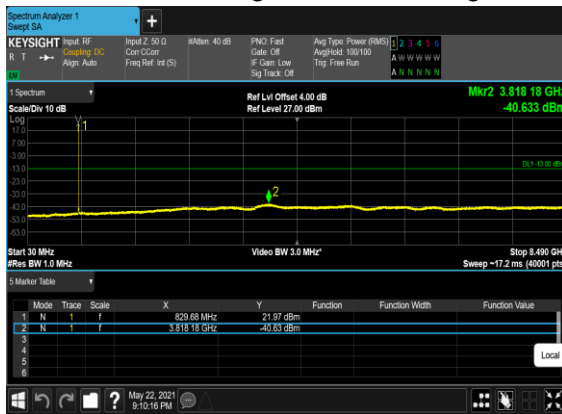

### B7\_N5(20M)\_DFT-s-OFDM\_QPSK\_Edge\_1RB\_Left\_High\_CH

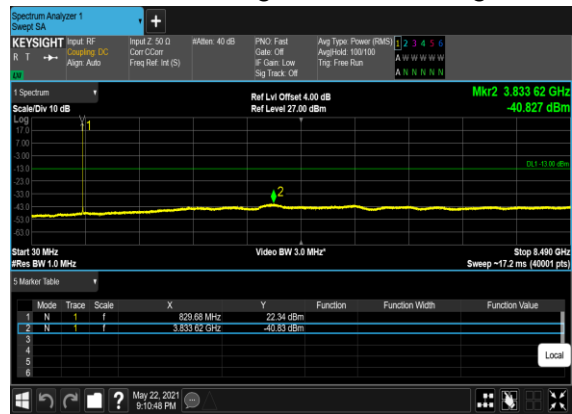

## Conducted Band Edge

NR Band	SCS (kHz)	Bandwidth (MHz)	Arfcn	Freq (MHz)	Modulation	RB	Result	Verdict
5	15	5	174300	826.5	DFT-s-OFDM BPSK	1@0	see graph	PASS
5	15	5	174300	826.5	DFT-s-OFDM QPSK	1@0	see graph	PASS
5	15	5	174300	826.5	DFT-s-OFDM BPSK	25@0	see graph	PASS
5	15	5	174300	826.5	DFT-s-OFDM QPSK	25@0	see graph	PASS
5	15	5	178300	846.5	DFT-s-OFDM BPSK	1@24	see graph	PASS
5	15	5	178300	846.5	DFT-s-OFDM QPSK	1@24	see graph	PASS
5	15	5	178300	846.5	DFT-s-OFDM BPSK	25@0	see graph	PASS
5	15	5	178300	846.5	DFT-s-OFDM QPSK	25@0	see graph	PASS
5	15	10	174800	829.0	DFT-s-OFDM BPSK	1@0	see graph	PASS
5	15	10	174800	829.0	DFT-s-OFDM QPSK	1@0	see graph	PASS
5	15	10	174800	829.0	DFT-s-OFDM BPSK	50@0	see graph	PASS
5	15	10	174800	829.0	DFT-s-OFDM QPSK	50@0	see graph	PASS
5	15	10	177800	844.0	DFT-s-OFDM BPSK	1@51	see graph	PASS
5	15	10	177800	844.0	DFT-s-OFDM QPSK	1@51	see graph	PASS
5	15	10	177800	844.0	DFT-s-OFDM BPSK	50@0	see graph	PASS
5	15	10	177800	844.0	DFT-s-OFDM QPSK	50@0	see graph	PASS
5	15	20	175800	834.0	DFT-s-OFDM BPSK	1@0	see graph	PASS
5	15	20	175800	834.0	DFT-s-OFDM QPSK	1@0	see graph	PASS
5	15	20	175800	834.0	DFT-s-OFDM BPSK	100@0	see graph	PASS
5	15	20	175800	834.0	DFT-s-OFDM QPSK	100@0	see graph	PASS
5	15	20	176800	839.0	DFT-s-OFDM BPSK	1@105	see graph	PASS
5	15	20	176800	839.0	DFT-s-OFDM QPSK	1@105	see graph	PASS

5	15	20	176800	839.0	DFT-s-OFDM BPSK	100@0	see graph	PASS
5	15	20	176800	839.0	DFT-s-OFDM QPSK	100@0	see graph	PASS

B7\_N5(5M)\_DFT-s-  
OFDM\_BPSK\_Edge\_1RB\_Left\_Low\_CH



B7\_N5(5M)\_DFT-s-  
OFDM\_QPSK\_Edge\_1RB\_Left\_Low\_CH

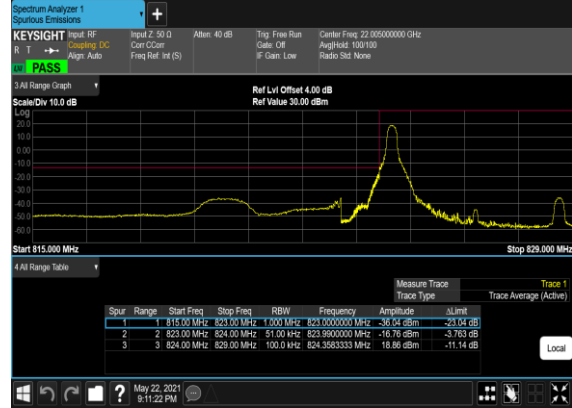

B7\_N5(5M)\_DFT-s-  
OFDM\_BPSK\_Outer\_Full\_Low\_CH

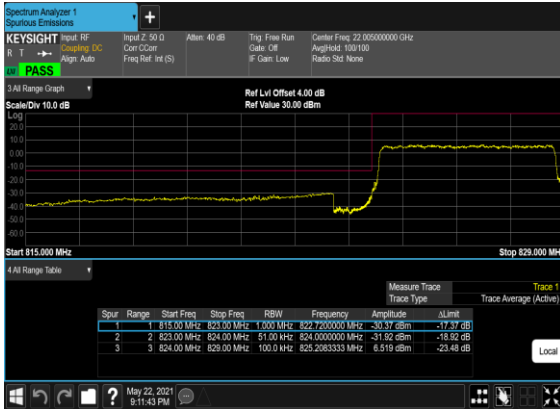

B7\_N5(5M)\_DFT-s-  
OFDM\_QPSK\_Outer\_Full\_Low\_CH

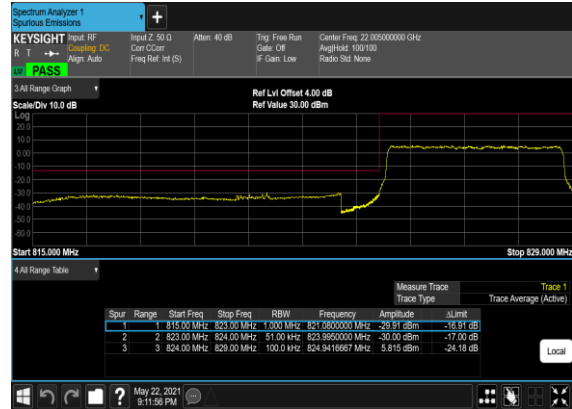

B7\_N5(5M)\_DFT-s-  
OFDM\_BPSK\_Edge\_1RB\_Right\_High\_CH

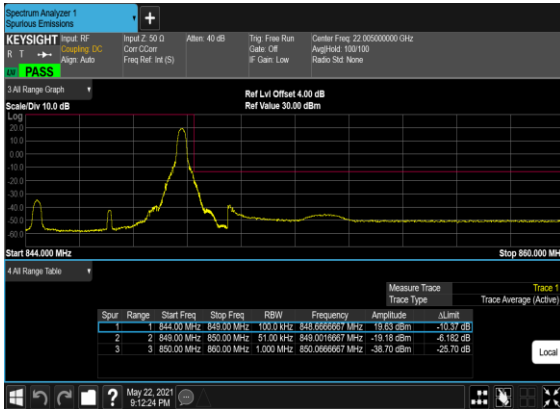

B7\_N5(5M)\_DFT-s-  
OFDM\_QPSK\_Edge\_1RB\_Right\_High\_CH

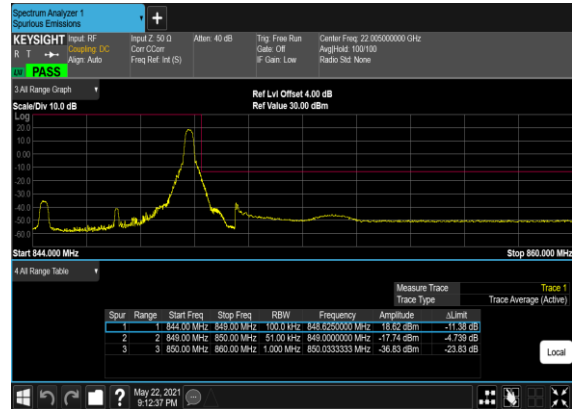

B7\_N5(5M)\_DFT-s-  
OFDM\_BPSK\_Outer\_Full\_High\_CH

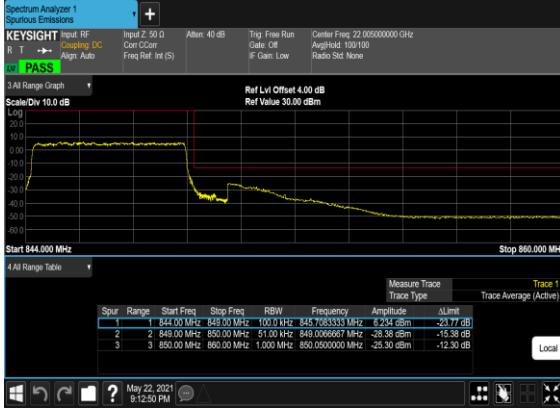

B7\_N5(5M)\_DFT-s-  
OFDM\_QPSK\_Outer\_Full\_High\_CH

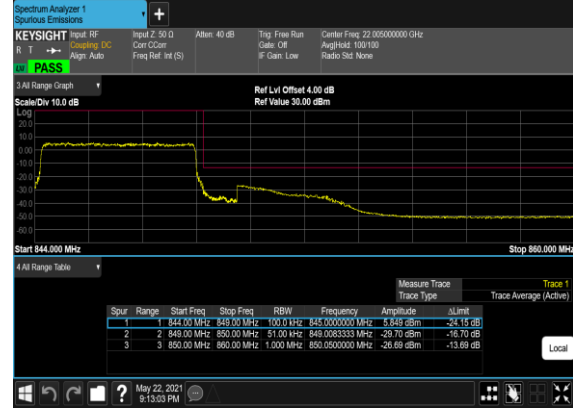

B7\_N5(10M)\_DFT-s-  
OFDM\_BPSK\_Edge\_1RB\_Left\_Low\_CH

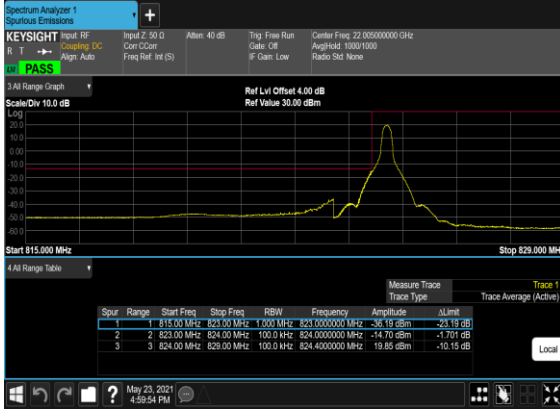

B7\_N5(10M)\_DFT-s-  
OFDM\_BPSK\_Edge\_1RB\_Left\_Low\_CH\_CHP\_PA  
SS

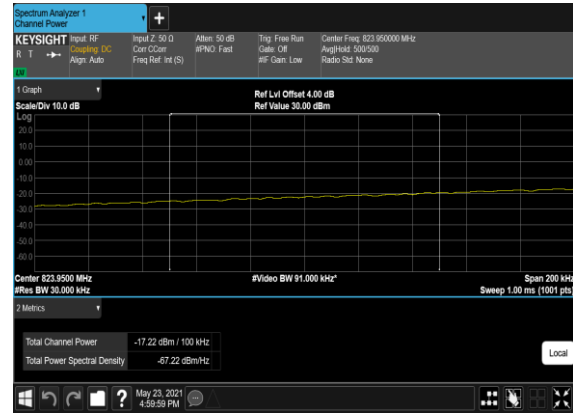

B7\_N5(10M)\_DFT-s-  
OFDM\_QPSK\_Edge\_1RB\_Left\_Low\_CH

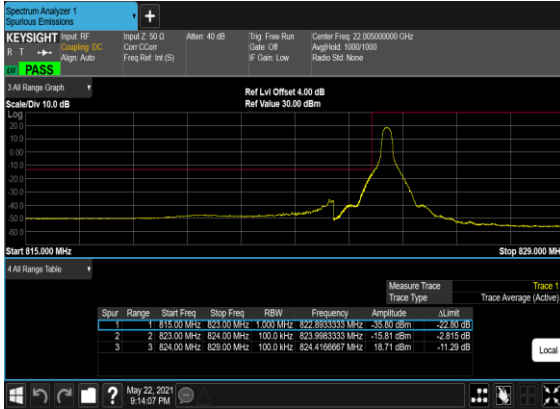

B7\_N5(10M)\_DFT-s-  
OFDM\_QPSK\_Edge\_1RB\_Left\_Low\_CH\_CHP\_PA  
SS

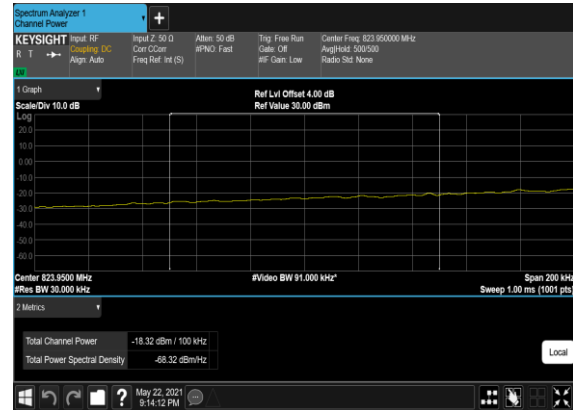



B7\_N5(10M)\_DFT-s-OFDM\_BPSK\_Outer\_Full\_Low\_CH

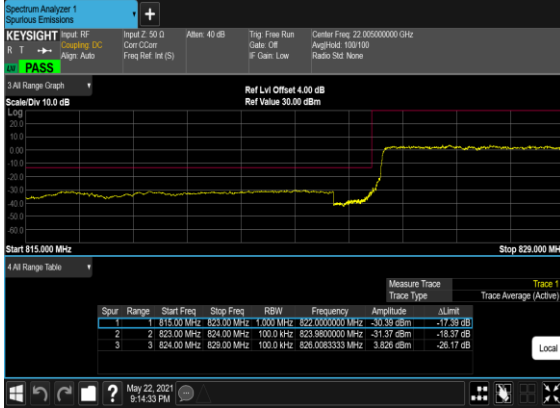

B7\_N5(10M)\_DFT-s-OFDM\_QPSK\_Outer\_Full\_Low\_CH

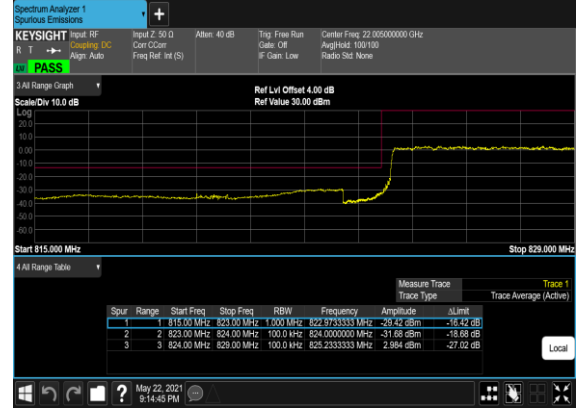

B7\_N5(10M)\_DFT-s-OFDM\_BPSK\_Edge\_1RB\_Right\_High\_CH



B7\_N5(10M)\_DFT-s-OFDM\_QPSK\_Edge\_1RB\_Right\_High\_CH

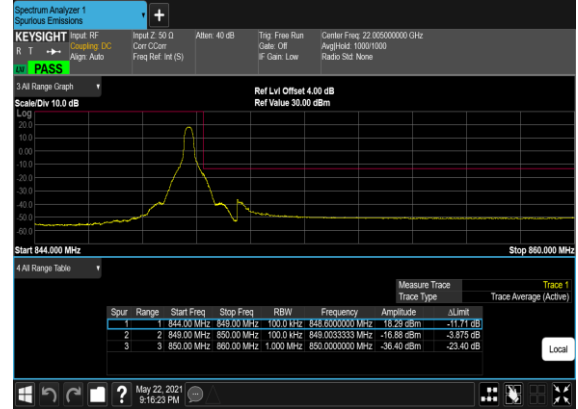

B7\_N5(10M)\_DFT-s-OFDM\_BPSK\_Outer\_Full\_High\_CH



B7\_N5(10M)\_DFT-s-OFDM\_QPSK\_Outer\_Full\_High\_CH



B7\_N5(20M)\_DFT-s-  
OFDM\_BPSK\_Edge\_1RB\_Left\_Low\_CH

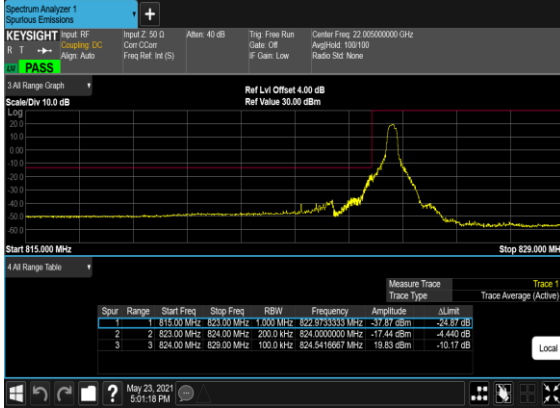

B7\_N5(20M)\_DFT-s-  
OFDM\_QPSK\_Edge\_1RB\_Left\_Low\_CH

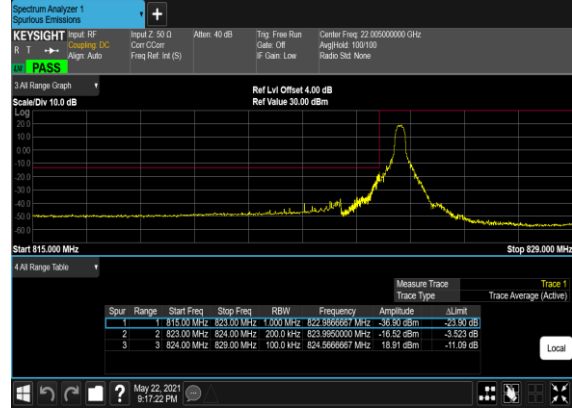

B7\_N5(20M)\_DFT-s-  
OFDM\_BPSK\_Outer\_Full\_Low\_CH



B7\_N5(20M)\_DFT-s-  
OFDM\_QPSK\_Outer\_Full\_Low\_CH



B7\_N5(20M)\_DFT-s-  
OFDM\_BPSK\_Edge\_1RB\_Right\_High\_CH

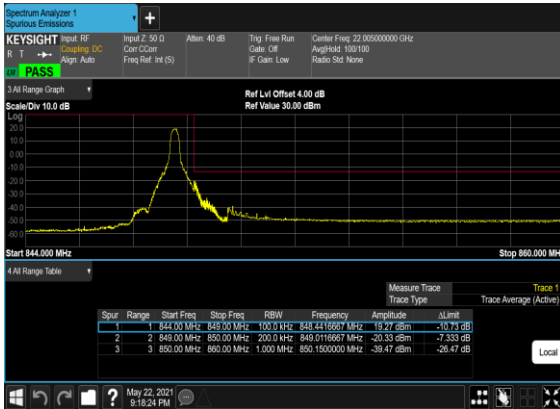

B7\_N5(20M)\_DFT-s-  
OFDM\_QPSK\_Edge\_1RB\_Right\_High\_CH

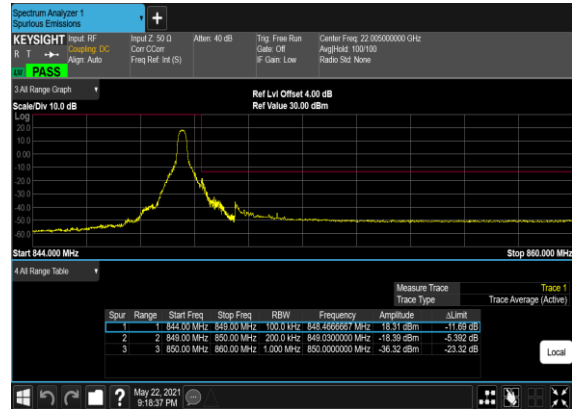

### B7\_N5(20M)\_DFT-s-OFDM\_BPSK\_Outer\_Full\_High\_CH



### B7\_N5(20M)\_DFT-s-OFDM\_QPSK\_Outer\_Full\_High\_CH

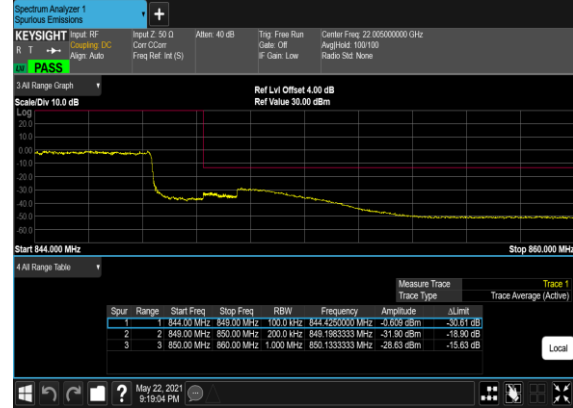

# FR1 N7

LTE Band: 5, LTE BW: 10M, LTE ARFCN: Mid

## Transmitter Conducted Output Power And ERP/EIRP, (G<sub>T</sub> - L<sub>C</sub>)=-0.08dB

NR Band	SCS (kHz)	Bandwidth (MHz)	Arfcn	Freq (MHz)	Modulation	RB	Conducted Power(dBm)	EIRP (dBm)	EIRP (W)
7	15	5	524500	2502.5	DFT-s-OFDM PI/2 BPSK	12@6	22.94	22.86	0.1932
7	15	5	524500	2502.5	DFT-s-OFDM PI/2 BPSK	1@1	23.08	23.0	0.1995
7	15	5	524500	2502.5	DFT-s-OFDM PI/2 BPSK	1@23	23.11	23.03	0.2009
7	15	5	524500	2502.5	DFT-s-OFDM QPSK	12@6	23.09	23.01	0.2
7	15	5	524500	2502.5	DFT-s-OFDM QPSK	1@1	23.11	23.03	0.2009
7	15	5	524500	2502.5	DFT-s-OFDM QPSK	1@23	23.09	23.01	0.2
7	15	5	524500	2502.5	DFT-s-OFDM 16 QAM	12@6	22.28	22.2	0.166
7	15	5	524500	2502.5	DFT-s-OFDM 16 QAM	1@1	22.26	22.18	0.1652
7	15	5	524500	2502.5	DFT-s-OFDM 16 QAM	1@23	22.17	22.09	0.1618
7	15	5	524500	2502.5	DFT-s-OFDM 64 QAM	12@6	20.75	20.67	0.1167
7	15	5	524500	2502.5	DFT-s-OFDM 64 QAM	1@1	20.88	20.8	0.1202
7	15	5	524500	2502.5	DFT-s-OFDM 64 QAM	1@23	20.93	20.85	0.1216
7	15	5	524500	2502.5	DFT-s-OFDM 256 QAM	12@6	18.68	18.6	0.0724
7	15	5	524500	2502.5	DFT-s-OFDM 256 QAM	1@1	18.17	18.09	0.0644
7	15	5	524500	2502.5	DFT-s-OFDM 256 QAM	1@23	18.14	18.06	0.064
7	15	5	524500	2502.5	CP-OFDM QPSK	13@6	21.71	21.63	0.1455
7	15	5	524500	2502.5	CP-OFDM QPSK	1@1	21.67	21.59	0.1442
7	15	5	524500	2502.5	CP-OFDM QPSK	1@23	21.69	21.61	0.1449

7	15	5	531000	2535.0	DFT-s-OFDM PI/2 BPSK	12@6	23.04	22.96	0.1977
7	15	5	531000	2535.0	DFT-s-OFDM PI/2 BPSK	1@1	23.03	22.95	0.1972
7	15	5	531000	2535.0	DFT-s-OFDM PI/2 BPSK	1@23	22.94	22.86	0.1932
7	15	5	531000	2535.0	DFT-s-OFDM QPSK	12@6	22.92	22.84	0.1923
7	15	5	531000	2535.0	DFT-s-OFDM QPSK	1@1	23.11	23.03	0.2009
7	15	5	531000	2535.0	DFT-s-OFDM QPSK	1@23	23.07	22.99	0.1991
7	15	5	531000	2535.0	DFT-s-OFDM 16 QAM	12@6	22.15	22.07	0.1611
7	15	5	531000	2535.0	DFT-s-OFDM 16 QAM	1@1	22.13	22.05	0.1603
7	15	5	531000	2535.0	DFT-s-OFDM 16 QAM	1@23	22.1	22.02	0.1592
7	15	5	531000	2535.0	DFT-s-OFDM 64 QAM	12@6	20.71	20.63	0.1156
7	15	5	531000	2535.0	DFT-s-OFDM 64 QAM	1@1	20.84	20.76	0.1191
7	15	5	531000	2535.0	DFT-s-OFDM 64 QAM	1@23	20.79	20.71	0.1178
7	15	5	531000	2535.0	DFT-s-OFDM 256 QAM	12@6	18.6	18.52	0.0711
7	15	5	531000	2535.0	DFT-s-OFDM 256 QAM	1@1	18.23	18.15	0.0653
7	15	5	531000	2535.0	DFT-s-OFDM 256 QAM	1@23	18.09	18.01	0.0632
7	15	5	531000	2535.0	CP-OFDM QPSK	13@6	21.6	21.52	0.1419
7	15	5	531000	2535.0	CP-OFDM QPSK	1@1	21.66	21.58	0.1439
7	15	5	531000	2535.0	CP-OFDM QPSK	1@23	21.57	21.49	0.1409
7	15	5	537500	2567.5	DFT-s-OFDM PI/2 BPSK	12@6	22.96	22.88	0.1941
7	15	5	537500	2567.5	DFT-s-OFDM PI/2 BPSK	1@1	22.93	22.85	0.1928
7	15	5	537500	2567.5	DFT-s-OFDM PI/2 BPSK	1@23	23.03	22.95	0.1972
7	15	5	537500	2567.5	DFT-s-OFDM QPSK	12@6	22.99	22.91	0.1954
7	15	5	537500	2567.5	DFT-s-OFDM QPSK	1@1	23.0	22.92	0.1959
7	15	5	537500	2567.5	DFT-s-OFDM QPSK	1@23	23.04	22.96	0.1977

7	15	5	537500	2567.5	DFT-s-OFDM 16 QAM	12@6	22.22	22.14	0.1637
7	15	5	537500	2567.5	DFT-s-OFDM 16 QAM	1@1	22.1	22.02	0.1592
7	15	5	537500	2567.5	DFT-s-OFDM 16 QAM	1@23	22.12	22.04	0.16
7	15	5	537500	2567.5	DFT-s-OFDM 64 QAM	12@6	20.72	20.64	0.1159
7	15	5	537500	2567.5	DFT-s-OFDM 64 QAM	1@1	20.8	20.72	0.118
7	15	5	537500	2567.5	DFT-s-OFDM 64 QAM	1@23	20.81	20.73	0.1183
7	15	5	537500	2567.5	DFT-s-OFDM 256 QAM	12@6	18.61	18.53	0.0713
7	15	5	537500	2567.5	DFT-s-OFDM 256 QAM	1@1	18.02	17.94	0.0622
7	15	5	537500	2567.5	DFT-s-OFDM 256 QAM	1@23	18.09	18.01	0.0632
7	15	5	537500	2567.5	CP-OFDM QPSK	13@6	21.53	21.45	0.1396
7	15	5	537500	2567.5	CP-OFDM QPSK	1@1	21.68	21.6	0.1445
7	15	5	537500	2567.5	CP-OFDM QPSK	1@23	21.56	21.48	0.1406
7	15	10	525000	2505.0	DFT-s-OFDM PI/2 BPSK	25@12	22.79	22.71	0.1866
7	15	10	525000	2505.0	DFT-s-OFDM PI/2 BPSK	1@1	23.09	23.01	0.2
7	15	10	525000	2505.0	DFT-s-OFDM PI/2 BPSK	1@50	22.98	22.9	0.195
7	15	10	525000	2505.0	DFT-s-OFDM QPSK	25@12	23.06	22.98	0.1986
7	15	10	525000	2505.0	DFT-s-OFDM QPSK	1@1	23.09	23.01	0.2
7	15	10	525000	2505.0	DFT-s-OFDM QPSK	1@50	23.02	22.94	0.1968
7	15	10	525000	2505.0	DFT-s-OFDM 16 QAM	25@12	22.17	22.09	0.1618
7	15	10	525000	2505.0	DFT-s-OFDM 16 QAM	1@1	22.18	22.1	0.1622
7	15	10	525000	2505.0	DFT-s-OFDM 16 QAM	1@50	22.12	22.04	0.16
7	15	10	525000	2505.0	DFT-s-OFDM 64 QAM	25@12	20.66	20.58	0.1143
7	15	10	525000	2505.0	DFT-s-OFDM 64 QAM	1@1	21.04	20.96	0.1247
7	15	10	525000	2505.0	DFT-s-OFDM 64 QAM	1@50	20.77	20.69	0.1172

7	15	10	525000	2505.0	DFT-s-OFDM 256 QAM	25@12	18.47	18.39	0.069
7	15	10	525000	2505.0	DFT-s-OFDM 256 QAM	1@1	18.63	18.55	0.0716
7	15	10	525000	2505.0	DFT-s-OFDM 256 QAM	1@50	18.41	18.33	0.0681
7	15	10	525000	2505.0	CP-OFDM QPSK	26@13	21.56	21.48	0.1406
7	15	10	525000	2505.0	CP-OFDM QPSK	1@1	21.62	21.54	0.1426
7	15	10	525000	2505.0	CP-OFDM QPSK	1@50	21.56	21.48	0.1406
7	15	10	531000	2535.0	DFT-s-OFDM PI/2 BPSK	25@12	23.01	22.93	0.1963
7	15	10	531000	2535.0	DFT-s-OFDM PI/2 BPSK	1@1	23.15	23.07	0.2028
7	15	10	531000	2535.0	DFT-s-OFDM PI/2 BPSK	1@50	23.08	23.0	0.1995
7	15	10	531000	2535.0	DFT-s-OFDM QPSK	25@12	23.06	22.98	0.1986
7	15	10	531000	2535.0	DFT-s-OFDM QPSK	1@1	23.14	23.06	0.2023
7	15	10	531000	2535.0	DFT-s-OFDM QPSK	1@50	23.02	22.94	0.1968
7	15	10	531000	2535.0	DFT-s-OFDM 16 QAM	25@12	22.26	22.18	0.1652
7	15	10	531000	2535.0	DFT-s-OFDM 16 QAM	1@1	22.25	22.17	0.1648
7	15	10	531000	2535.0	DFT-s-OFDM 16 QAM	1@50	22.15	22.07	0.1611
7	15	10	531000	2535.0	DFT-s-OFDM 64 QAM	25@12	20.67	20.59	0.1146
7	15	10	531000	2535.0	DFT-s-OFDM 64 QAM	1@1	20.96	20.88	0.1225
7	15	10	531000	2535.0	DFT-s-OFDM 64 QAM	1@50	20.76	20.68	0.1169
7	15	10	531000	2535.0	DFT-s-OFDM 256 QAM	25@12	18.59	18.51	0.071
7	15	10	531000	2535.0	DFT-s-OFDM 256 QAM	1@1	18.67	18.59	0.0723
7	15	10	531000	2535.0	DFT-s-OFDM 256 QAM	1@50	18.62	18.54	0.0714
7	15	10	531000	2535.0	CP-OFDM QPSK	26@13	21.58	21.5	0.1413
7	15	10	531000	2535.0	CP-OFDM QPSK	1@1	21.71	21.63	0.1455
7	15	10	531000	2535.0	CP-OFDM QPSK	1@50	21.61	21.53	0.1422

7	15	10	537000	2565.0	DFT-s-OFDM PI/2 BPSK	25@12	23.05	22.97	0.1982
7	15	10	537000	2565.0	DFT-s-OFDM PI/2 BPSK	1@1	22.62	22.54	0.1795
7	15	10	537000	2565.0	DFT-s-OFDM PI/2 BPSK	1@50	22.28	22.2	0.166
7	15	10	537000	2565.0	DFT-s-OFDM QPSK	25@12	23.08	23.0	0.1995
7	15	10	537000	2565.0	DFT-s-OFDM QPSK	1@1	23.02	22.94	0.1968
7	15	10	537000	2565.0	DFT-s-OFDM QPSK	1@50	23.09	23.01	0.2
7	15	10	537000	2565.0	DFT-s-OFDM 16 QAM	25@12	22.25	22.17	0.1648
7	15	10	537000	2565.0	DFT-s-OFDM 16 QAM	1@1	22.12	22.04	0.16
7	15	10	537000	2565.0	DFT-s-OFDM 16 QAM	1@50	22.21	22.13	0.1633
7	15	10	537000	2565.0	DFT-s-OFDM 64 QAM	25@12	20.66	20.58	0.1143
7	15	10	537000	2565.0	DFT-s-OFDM 64 QAM	1@1	20.78	20.7	0.1175
7	15	10	537000	2565.0	DFT-s-OFDM 64 QAM	1@50	20.87	20.79	0.1199
7	15	10	537000	2565.0	DFT-s-OFDM 256 QAM	25@12	18.65	18.57	0.0719
7	15	10	537000	2565.0	DFT-s-OFDM 256 QAM	1@1	18.63	18.55	0.0716
7	15	10	537000	2565.0	DFT-s-OFDM 256 QAM	1@50	18.52	18.44	0.0698
7	15	10	537000	2565.0	CP-OFDM QPSK	26@13	21.52	21.44	0.1393
7	15	10	537000	2565.0	CP-OFDM QPSK	1@1	21.69	21.61	0.1449
7	15	10	537000	2565.0	CP-OFDM QPSK	1@50	21.68	21.6	0.1445
7	15	15	525500	2507.5	DFT-s-OFDM PI/2 BPSK	36@18	22.65	22.57	0.1807
7	15	15	525500	2507.5	DFT-s-OFDM PI/2 BPSK	1@1	23.06	22.98	0.1986
7	15	15	525500	2507.5	DFT-s-OFDM PI/2 BPSK	1@77	22.96	22.88	0.1941
7	15	15	525500	2507.5	DFT-s-OFDM QPSK	36@18	22.99	22.91	0.1954
7	15	15	525500	2507.5	DFT-s-OFDM QPSK	1@1	23.05	22.97	0.1982
7	15	15	525500	2507.5	DFT-s-OFDM QPSK	1@77	23.05	22.97	0.1982



7	15	15	525500	2507.5	DFT-s-OFDM 16 QAM	36@18	22.07	21.99	0.1581
7	15	15	525500	2507.5	DFT-s-OFDM 16 QAM	1@1	22.14	22.06	0.1607
7	15	15	525500	2507.5	DFT-s-OFDM 16 QAM	1@77	22.01	21.93	0.156
7	15	15	525500	2507.5	DFT-s-OFDM 64 QAM	36@18	20.65	20.57	0.114
7	15	15	525500	2507.5	DFT-s-OFDM 64 QAM	1@1	20.91	20.83	0.1211
7	15	15	525500	2507.5	DFT-s-OFDM 64 QAM	1@77	20.83	20.75	0.1189
7	15	15	525500	2507.5	DFT-s-OFDM 256 QAM	36@18	18.46	18.38	0.0689
7	15	15	525500	2507.5	DFT-s-OFDM 256 QAM	1@1	18.38	18.3	0.0676
7	15	15	525500	2507.5	DFT-s-OFDM 256 QAM	1@77	18.22	18.14	0.0652
7	15	15	525500	2507.5	CP-OFDM QPSK	39@191	20.05	19.97	0.0993
7	15	15	525500	2507.5	CP-OFDM QPSK	1@1	21.68	21.6	0.1445
7	15	15	525500	2507.5	CP-OFDM QPSK	1@77	21.5	21.42	0.1387
7	15	15	531000	2535.0	DFT-s-OFDM PI/2 BPSK	36@18	23.01	22.93	0.1963
7	15	15	531000	2535.0	DFT-s-OFDM PI/2 BPSK	1@1	23.1	23.02	0.2004
7	15	15	531000	2535.0	DFT-s-OFDM PI/2 BPSK	1@77	22.95	22.87	0.1936
7	15	15	531000	2535.0	DFT-s-OFDM QPSK	36@18	23.03	22.95	0.1972
7	15	15	531000	2535.0	DFT-s-OFDM QPSK	1@1	23.11	23.03	0.2009
7	15	15	531000	2535.0	DFT-s-OFDM QPSK	1@77	22.99	22.91	0.1954
7	15	15	531000	2535.0	DFT-s-OFDM 16 QAM	36@18	22.12	22.04	0.16
7	15	15	531000	2535.0	DFT-s-OFDM 16 QAM	1@1	22.08	22.0	0.1585
7	15	15	531000	2535.0	DFT-s-OFDM 16 QAM	1@77	22.08	22.0	0.1585
7	15	15	531000	2535.0	DFT-s-OFDM 64 QAM	36@18	20.61	20.53	0.113
7	15	15	531000	2535.0	DFT-s-OFDM 64 QAM	1@1	20.82	20.74	0.1186
7	15	15	531000	2535.0	DFT-s-OFDM 64 QAM	1@77	20.67	20.59	0.1146

7	15	15	531000	2535.0	DFT-s-OFDM 256 QAM	36@18	18.48	18.4	0.0692
7	15	15	531000	2535.0	DFT-s-OFDM 256 QAM	1@1	18.4	18.32	0.0679
7	15	15	531000	2535.0	DFT-s-OFDM 256 QAM	1@77	18.18	18.1	0.0646
7	15	15	531000	2535.0	CP-OFDM QPSK	39@191	20.21	20.13	0.103
7	15	15	531000	2535.0	CP-OFDM QPSK	1@1	21.69	21.61	0.1449
7	15	15	531000	2535.0	CP-OFDM QPSK	1@77	21.53	21.45	0.1396
7	15	15	536500	2562.5	DFT-s-OFDM PI/2 BPSK	36@18	22.79	22.71	0.1866
7	15	15	536500	2562.5	DFT-s-OFDM PI/2 BPSK	1@1	22.83	22.75	0.1884
7	15	15	536500	2562.5	DFT-s-OFDM PI/2 BPSK	1@77	22.59	22.51	0.1782
7	15	15	536500	2562.5	DFT-s-OFDM QPSK	36@18	22.87	22.79	0.1901
7	15	15	536500	2562.5	DFT-s-OFDM QPSK	1@1	22.92	22.84	0.1923
7	15	15	536500	2562.5	DFT-s-OFDM QPSK	1@77	22.96	22.88	0.1941
7	15	15	536500	2562.5	DFT-s-OFDM 16 QAM	36@18	22.03	21.95	0.1567
7	15	15	536500	2562.5	DFT-s-OFDM 16 QAM	1@1	21.97	21.89	0.1545
7	15	15	536500	2562.5	DFT-s-OFDM 16 QAM	1@77	22.08	22.0	0.1585
7	15	15	536500	2562.5	DFT-s-OFDM 64 QAM	36@18	20.49	20.41	0.1099
7	15	15	536500	2562.5	DFT-s-OFDM 64 QAM	1@1	20.67	20.59	0.1146
7	15	15	536500	2562.5	DFT-s-OFDM 64 QAM	1@77	20.85	20.77	0.1194
7	15	15	536500	2562.5	DFT-s-OFDM 256 QAM	36@18	18.34	18.26	0.067
7	15	15	536500	2562.5	DFT-s-OFDM 256 QAM	1@1	18.26	18.18	0.0658
7	15	15	536500	2562.5	DFT-s-OFDM 256 QAM	1@77	18.23	18.15	0.0653
7	15	15	536500	2562.5	CP-OFDM QPSK	39@191	19.94	19.86	0.0968
7	15	15	536500	2562.5	CP-OFDM QPSK	1@1	21.49	21.41	0.1384
7	15	15	536500	2562.5	CP-OFDM QPSK	1@77	21.47	21.39	0.1377

7	15	20	526000	2510.0	DFT-s-OFDM PI/2 BPSK	50@25	22.62	22.54	0.1795
7	15	20	526000	2510.0	DFT-s-OFDM PI/2 BPSK	1@1	22.99	22.91	0.1954
7	15	20	526000	2510.0	DFT-s-OFDM PI/2 BPSK	1@104	23.15	23.07	0.2028
7	15	20	526000	2510.0	DFT-s-OFDM QPSK	50@25	23.0	22.92	0.1959
7	15	20	526000	2510.0	DFT-s-OFDM QPSK	1@1	23.01	22.93	0.1963
7	15	20	526000	2510.0	DFT-s-OFDM QPSK	1@104	22.99	22.91	0.1954
7	15	20	526000	2510.0	DFT-s-OFDM 16 QAM	50@25	22.09	22.01	0.1589
7	15	20	526000	2510.0	DFT-s-OFDM 16 QAM	1@1	22.09	22.01	0.1589
7	15	20	526000	2510.0	DFT-s-OFDM 16 QAM	1@104	22.07	21.99	0.1581
7	15	20	526000	2510.0	DFT-s-OFDM 64 QAM	50@25	20.67	20.59	0.1146
7	15	20	526000	2510.0	DFT-s-OFDM 64 QAM	1@1	20.86	20.78	0.1197
7	15	20	526000	2510.0	DFT-s-OFDM 64 QAM	1@104	20.74	20.66	0.1164
7	15	20	526000	2510.0	DFT-s-OFDM 256 QAM	50@25	18.55	18.47	0.0703
7	15	20	526000	2510.0	DFT-s-OFDM 256 QAM	1@1	18.7	18.62	0.0728
7	15	20	526000	2510.0	DFT-s-OFDM 256 QAM	1@104	18.6	18.52	0.0711
7	15	20	526000	2510.0	CP-OFDM QPSK	53@26	21.55	21.47	0.1403
7	15	20	526000	2510.0	CP-OFDM QPSK	1@1	21.62	21.54	0.1426
7	15	20	526000	2510.0	CP-OFDM QPSK	1@104	21.55	21.47	0.1403
7	15	20	531000	2535.0	DFT-s-OFDM PI/2 BPSK	50@25	23.01	22.93	0.1963
7	15	20	531000	2535.0	DFT-s-OFDM PI/2 BPSK	1@1	22.95	22.87	0.1936
7	15	20	531000	2535.0	DFT-s-OFDM PI/2 BPSK	1@104	22.97	22.89	0.1945
7	15	20	531000	2535.0	DFT-s-OFDM QPSK	50@25	22.93	22.85	0.1928
7	15	20	531000	2535.0	DFT-s-OFDM QPSK	1@1	23.02	22.94	0.1968
7	15	20	531000	2535.0	DFT-s-OFDM QPSK	1@104	22.92	22.84	0.1923

7	15	20	531000	2535.0	DFT-s-OFDM 16 QAM	50@25	22.09	22.01	0.1589
7	15	20	531000	2535.0	DFT-s-OFDM 16 QAM	1@1	22.08	22.0	0.1585
7	15	20	531000	2535.0	DFT-s-OFDM 16 QAM	1@104	22.07	21.99	0.1581
7	15	20	531000	2535.0	DFT-s-OFDM 64 QAM	50@25	20.68	20.6	0.1148
7	15	20	531000	2535.0	DFT-s-OFDM 64 QAM	1@1	20.8	20.72	0.118
7	15	20	531000	2535.0	DFT-s-OFDM 64 QAM	1@104	20.66	20.58	0.1143
7	15	20	531000	2535.0	DFT-s-OFDM 256 QAM	50@25	18.68	18.6	0.0724
7	15	20	531000	2535.0	DFT-s-OFDM 256 QAM	1@1	18.78	18.7	0.0741
7	15	20	531000	2535.0	DFT-s-OFDM 256 QAM	1@104	18.59	18.51	0.071
7	15	20	531000	2535.0	CP-OFDM QPSK	53@26	21.65	21.57	0.1435
7	15	20	531000	2535.0	CP-OFDM QPSK	1@1	21.67	21.59	0.1442
7	15	20	531000	2535.0	CP-OFDM QPSK	1@104	21.44	21.36	0.1368
7	15	20	536000	2560.0	DFT-s-OFDM PI/2 BPSK	50@25	22.91	22.83	0.1919
7	15	20	536000	2560.0	DFT-s-OFDM PI/2 BPSK	1@1	22.88	22.8	0.1905
7	15	20	536000	2560.0	DFT-s-OFDM PI/2 BPSK	1@104	22.98	22.9	0.195
7	15	20	536000	2560.0	DFT-s-OFDM QPSK	50@25	22.93	22.85	0.1928
7	15	20	536000	2560.0	DFT-s-OFDM QPSK	1@1	22.88	22.8	0.1905
7	15	20	536000	2560.0	DFT-s-OFDM QPSK	1@104	23.0	22.92	0.1959
7	15	20	536000	2560.0	DFT-s-OFDM 16 QAM	50@25	21.99	21.91	0.1552
7	15	20	536000	2560.0	DFT-s-OFDM 16 QAM	1@1	21.93	21.85	0.1531
7	15	20	536000	2560.0	DFT-s-OFDM 16 QAM	1@104	22.04	21.96	0.157
7	15	20	536000	2560.0	DFT-s-OFDM 64 QAM	50@25	20.54	20.46	0.1112
7	15	20	536000	2560.0	DFT-s-OFDM 64 QAM	1@1	20.6	20.52	0.1127
7	15	20	536000	2560.0	DFT-s-OFDM 64 QAM	1@104	20.81	20.73	0.1183