



# FCC RF Test Report

**APPLICANT** : Motorola Mobility LLC  
**EQUIPMENT** : Mobile Cellular Phone  
**BRAND NAME** : Motorola  
**MODEL NAME** : XT2129-1  
**FCC ID** : IHDT56ZN1  
**STANDARD** : 47 CFR Part 2, 22(H), 24(E), 27(L), 27(M)  
**CLASSIFICATION** : PCS Licensed Transmitter Held to Ear (PCE)

The product was received on Oct. 20, 2020 and completely tested on Nov. 25, 2020. We, Sporton International (ShenZhen) Inc., would like to declare that the tested sample has been evaluated in accordance with the procedures given in ANSI C63.26-2015 and shown compliance with the applicable technical standards.

The test results in this report apply exclusively to the tested model / sample. Without written approval of Sporton International (ShenZhen) Inc., the test report shall not be reproduced except in full.

Reviewed by: Derreck Chen / Supervisor

Approved by: Eric Shih / Manager



**Sporton International (ShenZhen) Inc.**

**1/F, 2/F, Bldg 5, Shiling Industrial Zone, Xinwei Village, Xili, Nanshan, Shenzhen, 518055**

**People's Republic of China**



TABLE OF CONTENTS

REVISION HISTORY 3
SUMMARY OF TEST RESULT 4
1 GENERAL DESCRIPTION 5
1.1 Applicant 5
1.2 Manufacturer 5
1.3 Product Feature of Equipment Under Test 5
1.4 Product Specification of Equipment Under Test 6
1.5 Modification of EUT 6
1.6 Specification of Accessory 7
1.7 Re-use of Measured Data 8
1.8 Maximum ERP/EIRP Power, Frequency Tolerance, and Emission Designator 9
1.9 Testing Location 11
1.10 Test Software 11
1.11 Applicable Standards 12
2 TEST CONFIGURATION OF EQUIPMENT UNDER TEST 13
2.1 Test Mode 13
2.2 Connection Diagram of Test System 14
2.3 Support Unit used in test configuration and system 14
2.4 Measurement Results Explanation Example 15
2.5 Frequency List of Low/Middle/High Channels 16
3 CONDUCTED TEST ITEMS 18
3.1 Measuring Instruments 18
3.2 Test Setup 18
3.3 Test Result of Conducted Test 18
3.4 Conducted Output Power and ERP/EIRP 19
3.5 Peak-to-Average Ratio 20
3.6 Occupied Bandwidth 21
3.7 Conducted Band Edge 22
3.8 Conducted Spurious Emission 23
3.9 Frequency Stability 24
4 RADIATED TEST ITEMS 25
4.1 Measuring Instruments 25
4.2 Test Setup 25
4.3 Test Result of Radiated Test 25
4.4 Radiated Spurious Emission 26
5 LIST OF MEASURING EQUIPMENT 27
6 UNCERTAINTY OF EVALUATION 28
APPENDIX A. TEST RESULTS OF CONDUCTED TEST
APPENDIX B. TEST RESULTS OF RADIATED TEST
APPENDIX C. TEST SETUP PHOTOGRAPHS
APPENDIX D. REFERENCE REPORT





## SUMMARY OF TEST RESULT

Report Section	FCC Rule	Description	Limit	Result	Remark
3.4	§2.1046	Conducted Output Power	Reporting Only	PASS	-
	§22.913(a)(5)	Effective Radiated Power (Band 5)	ERP < 7 Watt	PASS	-
	§24.232(c) §27.50(h)(2)	Equivalent Isotropic Radiated Power (Band 2) (Band 7)	EIRP < 2Watt	PASS	
	§27.50(d)(4)	Equivalent Isotropic Radiated Power (Band 4) (Band 66)	EIRP < 1Watt	PASS	-
3.5	§24.232(d)	Peak-to-Average Ratio	<13 dB	PASS	-
3.6	§2.1049	Occupied Bandwidth	Reporting Only	PASS	-
3.7	§2.1051 §22.917(a) §27.53(h)	Conducted Band Edge Measurement (Band 2) (Band 4) (Band 5) (Band 66)	< 43+10log <sub>10</sub> (P[Watts])	PASS	-
	§27.53(m)(4)	Conducted Band Edge Measurement (Band 7)	§27.53(m)(4)		
3.8	§2.1051 §22.917(a) §27.53(h)	Conducted Spurious Emission (Band 2) (Band 4) (Band 5) (Band 66)	< 43+10log <sub>10</sub> (P[Watts])	PASS	-
	§2.1051 §27.53(m)(4)	Conducted Spurious Emission (Band 7)	< 55+10log <sub>10</sub> (P[Watts])		
3.9	§2.1055 §22.355	Frequency Stability Temperature & Voltage	< 2.5 ppm for Part 22H	PASS	-
	§2.1055 §27.54		Within Authorized Band		
4.4	§2.1053 §22.917(a) §27.53(h)	Radiated Spurious Emission (Band 2) (Band 4) (Band 5) (Band 66)	< 43+10log <sub>10</sub> (P[Watts])	PASS	Under limit 30.36 dB at 4176.000 MHz
	§2.1053 §27.53(m)(4)	Radiated Spurious Emission (Band 7)	< 55+10log <sub>10</sub> (P[Watts])		

**Declaration of Conformity:**

The test results with all measurement uncertainty excluded are presented in accordance with the regulation limits or requirements declared by manufacturers.

**Comments and Explanations:**

The declared of product specification for EUT presented in the report are provided by the manufacturer, and the manufacturer takes all the responsibilities for the accuracy of product specification.



# 1 General Description

## 1.1 Applicant

Motorola Mobility LLC  
222 W,Merchandise Mart Plaza,Chicago,IL60654 USA

## 1.2 Manufacturer

Motorola Mobility LLC  
222 W,Merchandise Mart Plaza,Chicago,IL60654 USA

## 1.3 Product Feature of Equipment Under Test

Product Feature	
Equipment	Mobile Cellular Phone
Brand Name	Motorola
Model Name	XT2129-1
FCC ID	IHDT56ZN1
EUT supports Radios application	GSM/ WCDMA/ LTE WLAN 2.4GHz 802.11b/g/n HT20 WLAN 5GHz 802.11a/n HT20/HT40 WLAN 5GHz 802.11ac VHT20/VHT40/VHT80 Bluetooth BR/EDR/LE FM Receiver and GNSS
IMEI Code	Conducted: 359939300020178/356939300020186 Radiation: 356939300012977/356939300012985
HW Version	DVT2
SW Version	RRC31.30
EUT Stage	Production Unit



### 1.4 Product Specification of Equipment Under Test

Standards-related Product Specification	
<b>Tx Frequency</b>	LTE Band 2 : 1850.7 MHz ~ 1909.3 MHz LTE Band 4 : 1710.7 MHz ~ 1754.3 MHz LTE Band 5 : 824.7 MHz ~ 848.3 MHz LTE Band 7 : 2502.5 MHz ~ 2567.5 MHz LTE Band 66 : 1710.7 MHz ~ 1779.3 MHz
<b>Rx Frequency</b>	LTE Band 2 : 1930.7 MHz ~ 1989.3 MHz LTE Band 4 : 2110.7 MHz ~ 2154.3 MHz LTE Band 5 : 869.7 MHz ~ 893.3 MHz LTE Band 7 : 2622.5 MHz ~ 2687.5 MHz LTE Band 66 : 2110.7 MHz~ 2179.3 MHz
<b>Bandwidth</b>	LTE Band 5 : 1.4MHz / 3MHz / 5MHz / 10MHz LTE Band 66 : 1.4MHz / 3MHz / 5MHz / 10MHz / 15MHz / 20MHz
<b>Maximum Output Power to Antenna</b>	LTE Band 4: 22.70 dBm LTE Band 5 : 22.69 dBm LTE Band 66 : 22.71 dBm
<b>Antenna Gain</b>	LTE Band 4 : -2.30 dBi LTE Band 5 : -2.80 dBi LTE Band 66 : -2.30 dBi
<b>Type of Modulation</b>	QPSK / 16QAM / 64QAM

### 1.5 Modification of EUT

No modifications are made to the EUT during all test items.



## 1.6 Specification of Accessory

Specification of Accessory				
AC Adapter 1(US)	Brand Name	Motorola (Chenyang)	Model Name	MC-201
AC Adapter 1(EU)	Brand Name	Motorola (Chenyang)	Model Name	MC-202
AC Adapter 1(AR)	Brand Name	Motorola (Chenyang)	Model Name	MC-206
AC Adapter 1(BR)	Brand Name	Motorola (Chenyang)	Model Name	MC-207
AC Adapter 2(US)	Brand Name	Motorola (Acbel)	Model Name	MC-201
AC Adapter 2(EU)	Brand Name	Motorola (Acbel)	Model Name	MC-202
AC Adapter 2(AR)	Brand Name	Motorola (Acbel)	Model Name	MC-206
AC Adapter 2(Chile)	Brand Name	Motorola (Acbel)	Model Name	MC-209
AC Adapter 3(BR)	Brand Name	Motorola (Flex)	Model Name	MC-207
AC Adapter 4(BR)	Brand Name	Motorola (Salcomp)	Model Name	MC-207
Battery	Brand Name	Motorola(Sunwoda)	Model Name	JK50
Earphone 1	Brand Name	Motorola(New Leader)	Model Name	EM301K-11SF
Earphone 2	Brand Name	Motorola(Juwei)	Model Name	JWEP1182-T03H
Earphone 3	Brand Name	Motorola(New Leader)	Model Name	NLD-EM313A-11SF
Earphone 4	Brand Name	Motorola(LIANYUN)	Model Name	SH38C81577
Earphone 5	Brand Name	Motorola(Lianchuang)	Model Name	SH38C81576
USB Cable 1	Brand Name	Motorola (Chuangyitong)	Model Name	88806-024
USB Cable 2	Brand Name	Motorola (SUNTOPS)	Model Name	336258



## 1.7 Re-use of Measured Data

### 1.7.1 Introduction Section

This application re-uses data collected on a similar device. The subject device of this application (Model: XT2129-1, FCC ID: IHDT56ZN1) is electrically identical to the reference device (Model: XT2129-2, FCC ID: IHDT56ZN2) for the portions of the circuitry corresponding to the data being re-used, as treated by KDB Publication 484596 D01.

### 1.7.2 Difference Section

For details concerning the similarity with respect to component placement, mechanical/electrical design etc., please refer to the Product Equality Declaration.

The re-used RF data includes the following bands provided in Appendix A (Sporton RF Report No. FG002023B for the reference device Model: XT2129-2, FCC ID: IHDT56ZN2).

### 1.7.3 Reference detail Section:

Equipment Class	Reference FCC ID	Folder Test	Report Title/Section
PCE	IHDT56ZN2	FG002023B	All sections applicable for LTE Band 2/7

### 1.7.4 Spot Check Verification Data Section

In order to confirm hardware similarity of the subject device with the reference device, spot check measurements were performed on the subject device for the following test items, the test result were consistent with FCC ID: IHDT56ZN2 and LTE Band 5 to re-test.

Assertions concerning the similarity of these devices are based on representations by the applicant. The applicant accepts full responsibility for the validity of the similarity claim, and for the determination that verification test data are sufficient to support it.

Test Item	Mode	IHDT56ZN2 Worst Result	IHDT56ZN1 Worst Result	Difference (dB)
Average Conducted Power (dBm)	LTE Band 2	22.65	22.65	0
	LTE Band 7	23.17	23.11	-0.06





### 1.8 Maximum ERP/EIRP Power, Frequency Tolerance, and Emission Designator

LTE Band 4		QPSK			16QAM		
BW (MHz)	Frequency Range (MHz)	Emission Designator (99%OBW)	Frequency Tolerance (ppm)	Maximum EIRP(W)	Emission Designator (99%OBW)	Frequency Tolerance (ppm)	Maximum EIRP(W)
1.4	1710.7 ~ 1754.3	1M10G7D	-	0.1074	1M10W7D	-	0.0955
3	1711.5 ~ 1753.5	2M71G7D	-	0.1000	2M72W7D	-	0.0893
5	1712.5 ~ 1752.5	4M50G7D	-	0.1050	4M50W7D	-	0.0863
10	1715.0 ~ 1750.0	9M01G7D	0.0066	0.1026	9M01W7D	-	0.0855
15	1717.5 ~ 1747.5	13M4G7D	-	0.1059	13M4W7D	-	0.0964
20	1720.0 ~ 1745.0	17M9G7D	-	0.1099	17M9W7D	-	0.0895
LTE Band 4		64QAM					
BW (MHz)	Frequency Range (MHz)	Emission Designator (99%OBW)	Frequency Tolerance (ppm)		Maximum EIRP(W)		
1.4	1710.7 ~ 1754.3	1M09W7D	-		0.0755		
3	1711.5 ~ 1753.5	2M73W7D	-		0.0705		
5	1712.5 ~ 1752.5	4M50W7D	-		0.0769		
10	1715.0 ~ 1750.0	9M01W7D	-		0.0746		
15	1717.5 ~ 1747.5	13M5W7D	-		0.0755		
20	1720.0 ~ 1745.0	17M9W7D	-		0.0787		
LTE Band 5		QPSK			16QAM		
BW (MHz)	Frequency Range (MHz)	Emission Designator (99%OBW)	Frequency Tolerance (ppm)	Maximum ERP(W)	Emission Designator (99%OBW)	Frequency Tolerance (ppm)	Maximum ERP(W)
1.4	824.7 ~ 848.3	1M09G7D	-	0.0586	1M10W7D	-	0.0479
3	825.5 ~ 847.5	2M73G7D	-	0.0581	2M73W7D	-	0.0463
5	826.5 ~ 846.5	4M49G7D	-	0.0568	4M50W7D	-	0.0447
10	829.0 ~ 844.0	9M11G7D	0.0017	0.0594	9M07W7D	-	0.0461
LTE Band 5		64QAM					
BW (MHz)	Frequency Range (MHz)	Emission Designator (99%OBW)	Frequency Tolerance (ppm)		Maximum ERP(W)		
1.4	824.7 ~ 848.3	1M09W7D	-		0.0381		
3	825.5 ~ 847.5	2M74W7D	-		0.0372		
5	826.5 ~ 846.5	4M50W7D	-		0.0366		
10	829.0 ~ 844.0	9M03W7D	-		0.0368		



LTE Band 66		QPSK			16QAM		
BW (MHz)	Frequency Range (MHz)	Emission Designator (99%OBW)	Frequency Tolerance (ppm)	Maximum EIRP(W)	Emission Designator (99%OBW)	Frequency Tolerance (ppm)	Maximum EIRP(W)
1.4	1710.7 ~ 1779.3	1M10G7D	-	0.1074	1M10W7D	-	0.0955
3	1711.5 ~ 1778.5	2M71G7D	-	0.1000	2M72W7D	-	0.0893
5	1712.5 ~ 1777.5	4M50G7D	-	0.1050	4M50W7D	-	0.0863
10	1715.0 ~ 1775.0	9M01G7D	0.0066	0.1026	9M01W7D	-	0.0855
15	1717.5 ~ 1772.5	13M4G7D	-	0.1059	13M4W7D	-	0.0964
20	1720.0 ~ 1770.0	17M9G7D	-	0.1099	17M9W7D	-	0.0895
LTE Band 66		64QAM					
BW (MHz)	Frequency Range (MHz)	Emission Designator (99%OBW)	Frequency Tolerance (ppm)		Maximum EIRP(W)		
1.4	1710.7 ~ 1779.3	1M09W7D	-		0.0755		
3	1711.5 ~ 1778.5	2M73W7D	-		0.0705		
5	1712.5 ~ 1777.5	4M50W7D	-		0.0769		
10	1715.0 ~ 1775.0	9M01W7D	-		0.0746		
15	1717.5 ~ 1772.5	13M5W7D	-		0.0755		
20	1720.0 ~ 1770.0	17M9W7D	-		0.0787		

Note: LTE Band 66 overlaps the entire frequency range of LTE Band 4. Therefore, the test results provided in this report covers Band 66 as well as Band 4.



### 1.9 Testing Location

Sporton International (Shenzhen) Inc. is accredited to ISO/IEC 17025:2017 by American Association for Laboratory Accreditation with Certificate Number 5145.01.

<b>Test Firm</b>	Sporton International (Shenzhen) Inc.		
<b>Test Site Location</b>	1/F, 2/F, Bldg 5, Shiling Industrial Zone, Xinwei Village, Xili, Nanshan, Shenzhen, 518055 People's Republic of China TEL: +86-755-86379589 FAX: +86-755-86379595		
<b>Test Site No.</b>	<b>Sporton Site No.</b>	<b>FCC Designation No.</b>	<b>FCC Test Firm Registration No.</b>
	TH01-SZ	CN1256	421272

<b>Test Firm</b>	Sporton International (Shenzhen) Inc.		
<b>Test Site Location</b>	101, 1st Floor, Block B, Building 1, No. 2, Tengfeng 4th Road, Fenghuang Community, Fuyong Street, Baoan District, Shenzhen City Guangdong Province China 518103 TEL: +86-755-33202398		
<b>Test Site No.</b>	<b>Sporton Site No.</b>	<b>FCC Designation No.</b>	<b>FCC Test Firm Registration No.</b>
	03CH03-SZ	CN1256	421272

### 1.10 Test Software

Item	Site	Manufacture	Name	Version
1.	03CH03-SZ	AUDIX	E3	6.2009-8-24



## 1.11 Applicable Standards

According to the specifications of the manufacturer, the EUT must comply with the requirements of the following standards:

- ♦ 47 CFR Part 2, 22(H), 24(E), 27(L), 27(M)
- ♦ ANSI C63.26-2015
- ♦ FCC KDB 971168 D01 Power Meas License Digital Systems v03r01
- ♦ FCC KDB 412172 D01 Determining ERP and EIRP v01r01

### **Remark:**

1. All test items were verified and recorded according to the standards and without any deviation during the test.
2. This EUT has also been tested and complied with the requirements of FCC Part 15, Subpart B, recorded in a separate test report.



## 2 Test Configuration of Equipment Under Test

### 2.1 Test Mode

Antenna port conducted and radiated test items listed below are performed according to KDB 971168 D01 Power Meas License Digital Systems v03r01 with maximum output power.

Radiated measurements are performed by rotating the EUT in three different orthogonal test planes to find the maximum emission.

Test Items	Band	Bandwidth (MHz)						Modulation			RB #			Test Channel		
		1.4	3	5	10	15	20	QPSK	16QAM	64QAM	1	Half	Full	L	M	H
Max. Output Power	66	v	v	v	v	v	v	v	v	v	v	v	v	v	v	v
	4	v	v	v	v	v	v	v	v	v	v	v	v	v	v	v
	5	v	v	v	v	-	-	v	v	v	v	v	v	v	v	v
Peak-to-Average Ratio	66						v	v	v	v	v		v	v	v	v
	5				v	-	-	v	v	v	v		v	v	v	v
26dB and 99% Bandwidth	66	v	v	v	v	v	v	v	v	v			v	v	v	v
	5	v	v	v	v	-	-	v	v	v			v	v	v	v
Conducted Band Edge	66	v	v	v	v	v	v	v	v	v	v		v	v		v
	5	v	v	v	v	-	-	v	v	v	v		v	v		v
Conducted Spurious Emission	66	v	v	v	v	v	v	v	v	v	v			v	v	v
	5	v	v	v	v	-	-	v	v	v	v			v	v	v
Frequency Stability	66				v			v					v		v	
	5				v	-	-	v					v		v	
E.R.P / E.I.R.P	66	v	v	v	v	v	v	v	v	v	v			v	v	v
	5	v	v	v	v	-	-	v	v	v	v			v	v	v
Radiated Spurious Emission	66	Worst Case													v	
	5	Worst Case													v	
Note	<ol style="list-style-type: none"> <li>The mark "v" means that this configuration is chosen for testing</li> <li>The mark "-" means that this bandwidth is not supported.</li> <li>The device is investigated from 30MHz to 10 times of fundamental signal for radiated spurious emission test under different RB size/offset and modulations in exploratory test. Subsequently, only the worst case emissions are reported.</li> <li>LTE Band 66 overlaps the entire frequency range of LTE Band 4. Therefore, the test results provided in this report covers Band 66 as well as Band 4.</li> </ol>															

## 2.2 Connection Diagram of Test System

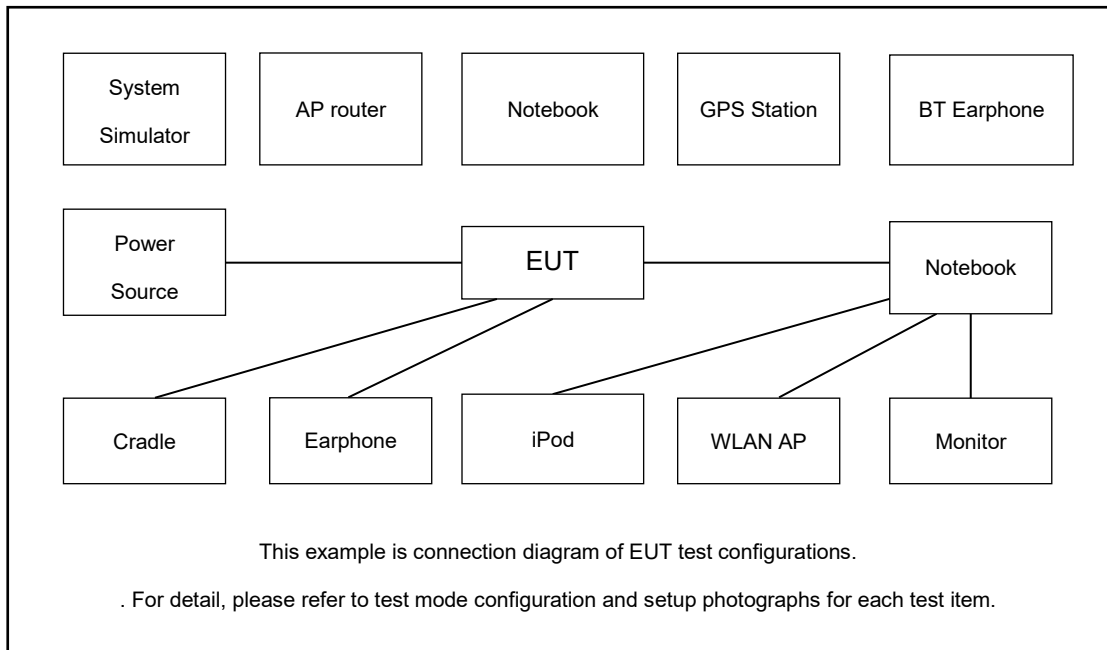

## 2.3 Support Unit used in test configuration and system

Item	Equipment	Trade Name	Model No.	FCC ID	Data Cable	Power Cord
1.	DC Power Supply	GW	GPS-3030D	N/A	N/A	Unshielded, 1.8 m
2.	LTE Base Station	Anritsu	MT8820C	N/A	N/A	Unshielded, 1.8m



## 2.4 Measurement Results Explanation Example

### For all conducted test items:

The offset level is set in the spectrum analyzer to compensate the RF cable loss and attenuator factor between RF conducted output port and spectrum analyzer. With the offset compensation, the spectrum analyzer reading level will be exactly the RF output level.

The spectrum analyzer offset is derived from RF cable loss and attenuator factor.

*Offset = RF cable loss + attenuator factor.*

The following shows an offset computation example with RF cable loss 4.00 dB and a 10dB attenuator.

Example :

$$\begin{aligned} \text{Offset(dB)} &= \text{RF cable loss(dB)} + \text{attenuator factor(dB)}. \\ &= 4.00 + 10 = 14.00 \text{ (dB)} \end{aligned}$$



### 2.5 Frequency List of Low/Middle/High Channels

LTE Band 4 Channel and Frequency List				
BW [MHz]	Channel/Frequency(MHz)	Lowest	Middle	Highest
20	Channel	20050	20175	20300
	Frequency	1720	1732.5	1745
15	Channel	20025	20175	20325
	Frequency	1717.5	1732.5	1747.5
10	Channel	20000	20175	20350
	Frequency	1715	1732.5	1750
5	Channel	19975	20175	20375
	Frequency	1712.5	1732.5	1752.5
3	Channel	19965	20175	20385
	Frequency	1711.5	1732.5	1753.5
1.4	Channel	19957	20175	20393
	Frequency	1710.7	1732.5	1754.3

LTE Band 5 Channel and Frequency List				
BW [MHz]	Channel/Frequency(MHz)	Lowest	Middle	Highest
10	Channel	20450	20525	20600
	Frequency	829	836.5	844
5	Channel	20425	20525	20625
	Frequency	826.5	836.5	846.5
3	Channel	20415	20525	20635
	Frequency	825.5	836.5	847.5
1.4	Channel	20407	20525	20643
	Frequency	824.7	836.5	848.3





LTE Band 66 Channel and Frequency List				
BW [MHz]	Channel/Frequency(MHz)	Lowest	Middle	Highest
20	Channel	132072	132322	132572
	Frequency	1720	1745	1770
15	Channel	132047	132322	132597
	Frequency	1717.5	1745	1772.5
10	Channel	132022	132322	132622
	Frequency	1715	1745	1775
5	Channel	131997	132322	132647
	Frequency	1712.5	1745	1777.5
3	Channel	131987	132322	132657
	Frequency	1711.5	1745	1778.5
1.4	Channel	131979	132322	132665
	Frequency	1710.7	1745	1779.3

### 3 Conducted Test Items

#### 3.1 Measuring Instruments

See list of measuring instruments of this test report.

#### 3.2 Test Setup

##### 3.2.1 Conducted Output Power

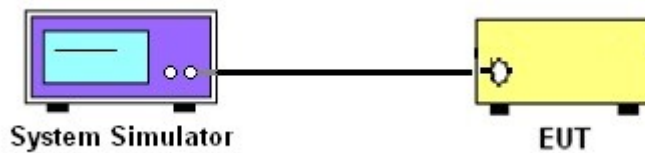

##### 3.2.2 Peak-to-Average Ratio, Occupied Bandwidth ,Conducted Band-Edge and Conducted Spurious Emission



##### 3.2.3 Frequency Stability

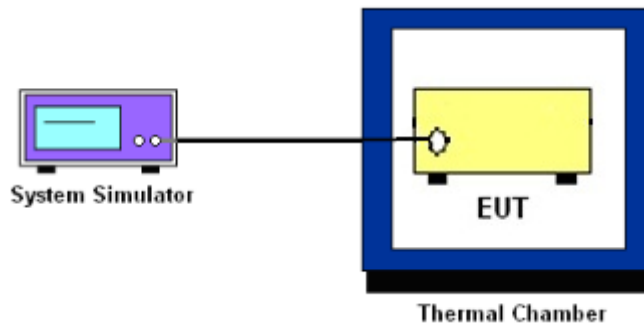

### 3.3 Test Result of Conducted Test

Please refer to Appendix A.



### 3.4 Conducted Output Power and ERP/EIRP

#### 3.4.1 Description of the Conducted Output Power Measurement and ERP/EIRP Measurement

A system simulator was used to establish communication with the EUT. Its parameters were set to force the EUT transmitting at maximum output power. The measured power in the radio frequency on the transmitter output terminals shall be reported.

The ERP of mobile transmitters must not exceed 7 Watts for LTE Band 5.

The EIRP of mobile transmitters must not exceed 1 Watts for LTE Band 4 and Band 66.

According to KDB 412172 D01 Power Approach,

$EIRP = P_T + G_T - L_C$ ,  $ERP = EIRP - 2.15$ , where

$P_T$  = transmitter output power in dBm

$G_T$  = gain of the transmitting antenna in dBi

$L_C$  = signal attenuation in the connecting cable between the transmitter and antenna in dB

#### 3.4.2 Test Procedures

1. The testing follows ANSI C63.26 Section 5.2
2. The transmitter output port was connected to the system simulator.
3. Set EUT at maximum power through the system simulator.
4. Select lowest, middle, and highest channels for each band and different modulation.
5. Measure and record the power level from the system simulator.



## **3.5 Peak-to-Average Ratio**

### **3.5.1 Description of the PAR Measurement**

Power Complementary Cumulative Distribution Function (CCDF) curves provide a means for characterizing the power peaks of a digitally modulated signal on a statistical basis. A CCDF curve depicts the probability of the peak signal amplitude exceeding the average power level. Most contemporary measurement instrumentation include the capability to produce CCDF curves for an input signal provided that the instrument's resolution bandwidth can be set wide enough to accommodate the entire input signal bandwidth. In measuring transmissions in this band using an average power technique, the peak-to-average ratio (PAR) of the transmission may not exceed 13 dB.

### **3.5.2 Test Procedures**

1. The testing follows ANSI C63.26 Section 5.2.3.4 (CCDF).
2. The EUT was connected to spectrum and system simulator via a power divider.
3. Set the CCDF (Complementary Cumulative Distribution Function) option in spectrum analyzer.
4. The highest RF powers were measured and recorded the maximum PAPR level associated with a probability of 0.1 %.
5. Record the deviation as Peak to Average Ratio.



## 3.6 Occupied Bandwidth

### 3.6.1 Description of Occupied Bandwidth Measurement

The occupied bandwidth is the width of a frequency band such that, below the lower and above the upper frequency limits, the mean powers emitted are each equal to a specified percentage 0.5% of the total mean transmitted power.

The 26 dB emission bandwidth is defined as the frequency range between two points, one above and one below the carrier frequency, at which the spectral density of the emission is attenuated 26 dB below the maximum in-band spectral density of the modulated signal. Spectral density (power per unit bandwidth) is to be measured with a detector of resolution bandwidth equal to approximately 1.0% of the emission bandwidth.

### 3.6.2 Test Procedures

1. The testing follows ANSI C63.26 Section 5.4
2. The EUT was connected to spectrum analyzer and system simulator via a power divider.
3. The spectrum analyzer center frequency is set to the nominal EUT channel center frequency. The span range for the spectrum analyzer shall be between two and five times the anticipated OBW.
4. The nominal resolution bandwidth (RBW) shall be in the range of 1 to 5 % of the anticipated OBW, and the VBW shall be at least 3 times the RBW.
5. Set the detection mode to peak, and the trace mode to max hold.
6. Determine the reference value: Set the EUT to transmit a modulated signal. Allow the trace to stabilize. Set the spectrum analyzer marker to the highest level of the displayed trace.  
(this is the reference value)
7. Determine the “-26 dB down amplitude” as equal to (Reference Value – X).
8. Place two markers, one at the lowest and the other at the highest frequency of the envelope of the spectral display such that each marker is at or slightly below the “-X dB down amplitude” determined in step 6. If a marker is below this “-X dB down amplitude” value it shall be placed as close as possible to this value. The OBW is the positive frequency difference between the two markers.
9. Use the 99 % power bandwidth function of the spectrum analyzer and report the measured bandwidth.



### 3.7 Conducted Band Edge

#### 3.7.1 Description of Conducted Band Edge Measurement

22.917(a)

For operations in the 824 – 849 MHz band, the FCC limit is  $43 + 10\log_{10}(P[\text{Watts}])$  dB below the transmitter power P(Watts) in a 100kHz bandwidth. However, in the 1MHz bands immediately outside and adjacent to the licensee's frequency block, a resolution bandwidth of at least one percent of the emission bandwidth of the fundamental emission of the transmitter may be employed.

27.53 (h)

For operations in the 1710 – 1755 MHz band, the FCC limit is  $43 + 10\log_{10}(P[\text{Watts}])$  dB below the transmitter power P(Watts) in a 1 MHz bandwidth. However, in the 1MHz bands immediately outside and adjacent to the licensee's frequency block, a resolution bandwidth of at least one percent of the emission bandwidth of the fundamental emission of the transmitter may be employed.

#### 3.7.2 Test Procedures

1. The testing follows ANSI C63.26 section 5.7
2. The EUT was connected to spectrum analyzer and system simulator via a power divider.
3. The band edges of low and high channels for the highest RF powers were measured.
4. Set RBW  $\geq$  1% EBW in the 1MHz band immediately outside and adjacent to the band edge.
5. Beyond the 1 MHz band from the band edge, RBW=1MHz was used or a narrower RBW was used and the measured power was integrated over the full required measurement bandwidth of 1 MHz.
6. Set spectrum analyzer with RMS detector.
7. The RF fundamental frequency should be excluded against the limit line in the operating frequency band.
8. Checked that all the results comply with the emission limit line.

Example:

$$\begin{aligned} &\text{The limit line is derived from } 43 + 10\log(P)\text{dB below the transmitter power } P(\text{Watts}) \\ &= P(\text{W}) - [43 + 10\log(P)] \text{ (dB)} \\ &= [30 + 10\log(P)] \text{ (dBm)} - [43 + 10\log(P)] \text{ (dB)} = -13\text{dBm}. \end{aligned}$$



### 3.8 Conducted Spurious Emission

#### 3.8.1 Description of Conducted Spurious Emission Measurement

The power of any emission outside of the authorized operating frequency ranges must be lower than the transmitter power (P) by a factor of at least  $43 + 10 \log (P)$  dB.

It is measured by means of a calibrated spectrum analyzer and scanned from 30 MHz up to a frequency including its 10<sup>th</sup> harmonic.

#### 3.8.2 Test Procedures

1. The testing follows ANSI C63.26 section 5.7
2. The EUT was connected to spectrum analyzer and system simulator via a power divider.
3. The RF output of EUT was connected to the spectrum analyzer by RF cable and attenuator. The path loss was compensated to the results for each measurement.
4. The middle channel for the highest RF power within the transmitting frequency was measured.
5. The conducted spurious emission for the whole frequency range was taken.
6. Make the measurement with the spectrum analyzer's RBW = 1MHz, VBW = 3MHz.
7. Set spectrum analyzer with RMS detector.
8. Taking the record of maximum spurious emission.
9. The RF fundamental frequency should be excluded against the limit line in the operating frequency band.
10. The limit line is derived from  $43 + 10\log(P)$ dB below the transmitter power P(Watts)  
= P(W)- [43 + 10log(P)] (dB)  
= [30 + 10log(P)] (dBm) - [43 + 10log(P)] (dB)  
= -13dBm.



## 3.9 Frequency Stability

### 3.9.1 Description of Frequency Stability Measurement

The frequency stability shall be measured by variation of ambient temperature and variation of primary supply voltage to ensure that the fundamental emission stays within the authorized frequency block. The frequency stability of the transmitter shall be maintained within  $\pm 0.00025\%$  ( $\pm 2.5\text{ppm}$ ) of the center frequency.

### 3.9.2 Test Procedures for Temperature Variation

1. The testing follows ANSI C63.26 section 5.6.4
2. The EUT was set up in the thermal chamber and connected with the system simulator.
3. With power OFF, the temperature was decreased to  $-30^{\circ}\text{C}$  and the EUT was stabilized before testing. Power was applied and the maximum change in frequency was recorded within one minute.
4. With power OFF, the temperature was raised in  $10^{\circ}\text{C}$  step up to  $50^{\circ}\text{C}$ . The EUT was stabilized at each step for at least half an hour. Power was applied and the maximum frequency change was recorded within one minute.

### 3.9.3 Test Procedures for Voltage Variation

1. The testing follows ANSI C63.26 section 5.6.5
2. The EUT was placed in a temperature chamber at  $20\pm 5^{\circ}\text{C}$  and connected with the system simulator.
3. The power supply voltage to the EUT was varied from 85% to 115% of the nominal value for other than hand carried battery equipment.
4. For hand carried, battery powered equipment, reduce the primary ac or dc supply voltage to the battery operating end point, which shall be specified by the manufacturer.
5. The variation in frequency was measured for the worst case.



## 4 Radiated Test Items

### 4.1 Measuring Instruments

See list of measuring instruments of this test report.

### 4.2 Test Setup

#### 4.2.1 For radiated test from 30MHz to 1GHz

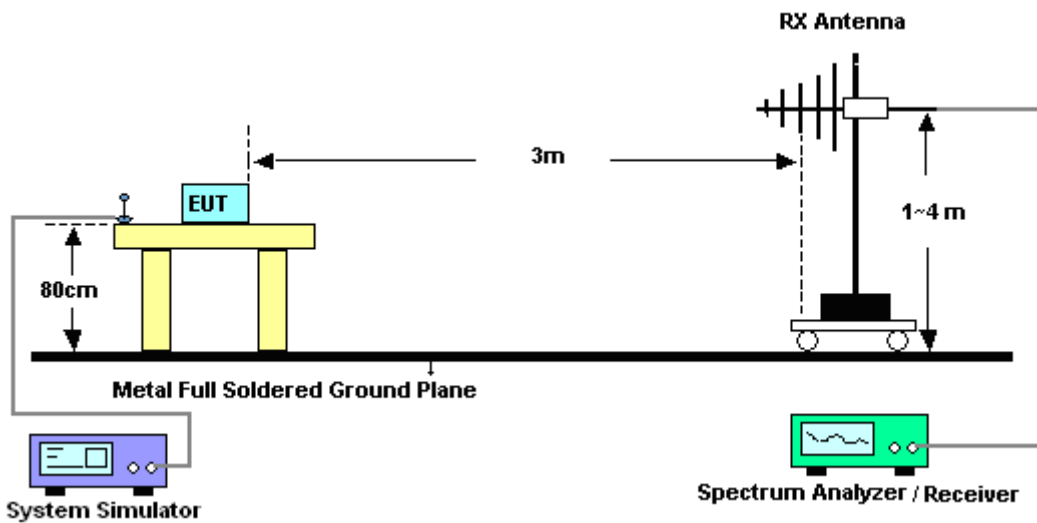

#### 4.2.2 For radiated test above 1GHz

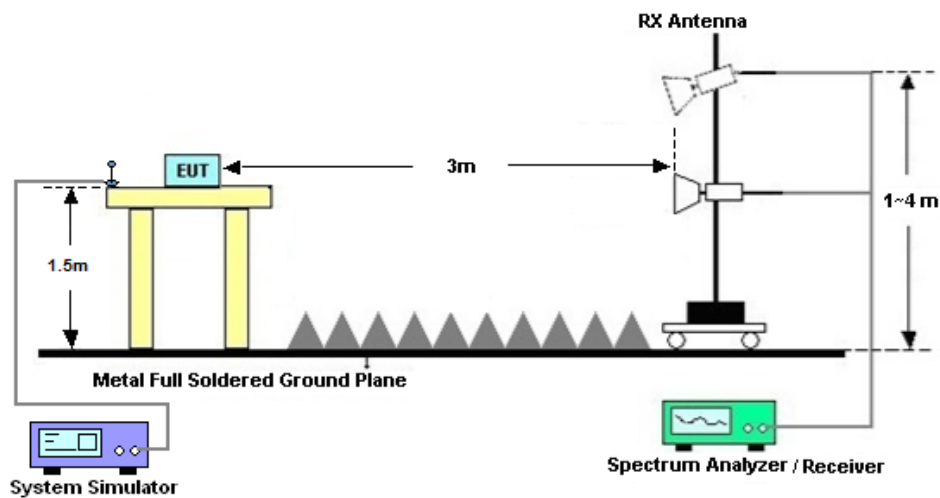

### 4.3 Test Result of Radiated Test

Please refer to Appendix B.



## 4.4 Radiated Spurious Emission

### 4.4.1 Description of Radiated Spurious Emission

The radiated spurious emission was measured by substitution method according to ANSI C63.26. The power of any emission outside of the authorized operating frequency ranges must be attenuated below the transmitter power (P) by a factor of at least  $43 + 10 \log (P)$  dB.

The spectrum is scanned from 30 MHz up to a frequency including its 10th harmonic.

### 4.4.2 Test Procedures

1. The testing follows ANSI C63.26 Section 5.5
2. The EUT was placed on a turntable with 0.8 meter height for frequency below 1GHz and 1.5 meter height for frequency above 1GHz respectively above ground.
3. The EUT was set 3 meters from the receiving antenna mounted on the antenna tower.
4. The table was rotated 360 degrees to determine the position of the highest spurious emission.
5. The height of the receiving antenna is varied between 1m to 4m to search the maximum spurious emission for both horizontal and vertical polarizations.
6. During the measurement, the system simulator parameters were set to force the EUT transmitting at maximum output power.
7. Make the measurement with the spectrum analyzer's RBW = 1MHz, VBW = 3MHz, taking the record of maximum spurious emission.
8. A horn antenna was substituted in place of the EUT and was driven by a signal generator.
9. Tune the output power of signal generator to the same emission level with EUT maximum spurious emission.
10.  $EIRP \text{ (dBm)} = S.G. \text{ Power} - Tx \text{ Cable Loss} + Tx \text{ Antenna Gain}$
11.  $ERP \text{ (dBm)} = EIRP - 2.15$
12. The RF fundamental frequency should be excluded against the limit line in the operating frequency band.

The limit line is derived from  $43 + 10\log(P)$ dB below the transmitter power P(Watts)  
=  $P(W) - [43 + 10\log(P)] \text{ (dB)}$   
=  $[30 + 10\log(P)] \text{ (dBm)} - [43 + 10\log(P)] \text{ (dB)}$   
= -13dBm.



## 5 List of Measuring Equipment

Instrument	Manufacturer	Model No.	Serial No.	Characteristics	Calibration Date	Test Date	Due Date	Remark
Spectrum Analyzer	R&S	FSV40	101078	10Hz~40GHz	Apr. 17, 2020	Nov. 19, 2020~Nov. 20, 2020	Apr. 16, 2021	Conducted (TH01-SZ)
Thermal Chamber	Ten Billion Hongzhangroup	LP-150U	H2014081803	-40~+150°C	Jul. 22, 2020	Nov. 19, 2020~Nov. 20, 2020	Jul. 21, 2021	Conducted (TH01-SZ)
EXA Spectrum Analyzer	KEYSIGHT	N9010A	MY55150246	10Hz~44GHz;	Apr. 17, 2020	Nov. 25, 2020	Apr. 16, 2021	Radiation (03CH03-SZ)
Bilog Antenna	TeseQ	CBL6112D	35408	30MHz-2GHz	Jun. 22, 2020	Nov. 25, 2020	Jun. 21, 2021	Radiation (03CH03-SZ)
Double Ridge Horn Antenna	SCHWARZBECK	BBHA9120D	9120D-1355	1GHz~18GHz	Apr. 30, 2020	Nov. 25, 2020	Apr. 29, 2021	Radiation (03CH03-SZ)
Amplifier	Burgeon	BPA-530	102210	0.01Hz ~3000MHz	Oct. 17, 2020	Nov. 25, 2020	Oct. 16, 2021	Radiation (03CH03-SZ)
HF Amplifier	MITEQ	TTA1840-35-HG	1871923	18GHz~40GHz	Jul. 21, 2020	Nov. 25, 2020	Jul. 20, 2021	Radiation (03CH03-SZ)
SHF-EHF Horn	com-power	AH-840	101071	18Ghz-40GHz	Apr. 23, 2020	Nov. 25, 2020	Apr. 22, 2021	Radiation (03CH03-SZ)
Amplifier	Agilent Technologies	83017A	MY39501302	500MHz~26.5GHz	Dec. 27, 2019	Nov. 25, 2020	Dec. 26, 2020	Radiation (03CH03-SZ)
AC Power Source	Chroma	61601	616010001985	N/A	NCR	Nov. 25, 2020	NCR	Radiation (03CH03-SZ)
Turn Table	EM	EM1000	N/A	0~360 degree	NCR	Nov. 25, 2020	NCR	Radiation (03CH03-SZ)
Antenna Mast	EM	EM1000	N/A	1 m~4 m	NCR	Nov. 25, 2020	NCR	Radiation (03CH03-SZ)

NCR: No Calibration Required



## 6 Uncertainty of Evaluation

The measurement uncertainties shown below were calculated in accordance with the requirements of ANSI 63.26-2015. All the measurement uncertainty value were shown with a coverage K=2 to indicate 95% level of confidence. The measurement data show herein meets or exceeds the CISPR measurement uncertainty values specified in CISPR 16-4-2 and can be compared directly to specified limit to determine compliance.

### Uncertainty of Radiated Emission Measurement (30 MHz ~ 1000 MHz)

Measuring Uncertainty for a Level of Confidence of 95% (U = 2Uc(y))	3.0dB
---	-------

### Uncertainty of Radiated Emission Measurement (1 GHz ~ 18 GHz)

Measuring Uncertainty for a Level of Confidence of 95% (U = 2Uc(y))	3.6dB
---	-------

### Uncertainty of Radiated Emission Measurement (18 GHz ~ 40 GHz)

Measuring Uncertainty for a Level of Confidence of 95% (U = 2Uc(y))	3.8dB
---	-------



### Appendix A. Test Results of Conducted Test

#### Conducted Output Power(Average power)

LTE Band 4						
BW [MHz]	Modulation	RB Size	RB Offset	Power Low Ch. / Freq.	Power Middle Ch. / Freq.	Power High Ch. / Freq.
Channel				20050	20175	20300
Frequency (MHz)				1720	1732.5	1745
20	QPSK	1	0	22.27	22.52	22.51
20	QPSK	1	49	22.40	22.70	22.63
20	QPSK	1	99	22.25	22.25	22.23
20	QPSK	50	0	21.58	21.71	21.65
20	QPSK	50	24	21.49	21.68	21.60
20	QPSK	50	50	21.57	21.66	21.58
20	QPSK	100	0	21.57	21.69	21.62
20	16QAM	1	0	21.35	21.60	21.68
20	16QAM	1	49	21.48	21.62	21.33
20	16QAM	1	99	21.22	21.26	21.27
20	16QAM	50	0	20.59	20.64	20.75
20	16QAM	50	24	20.57	20.56	20.64
20	16QAM	50	50	20.65	20.63	20.60
20	16QAM	100	0	20.58	20.55	20.53
20	64QAM	1	0	20.49	20.72	20.67
20	64QAM	1	49	20.78	20.79	20.89
20	64QAM	1	99	20.45	20.42	20.39
20	64QAM	50	0	19.66	19.72	19.7
20	64QAM	50	24	19.57	19.62	19.59
20	64QAM	50	50	19.64	19.49	19.63
20	64QAM	100	0	19.69	19.63	19.61
Channel				20025	20175	20325
Frequency (MHz)				1717.5	1732.5	1747.5
15	QPSK	1	0	22.47	22.63	22.65
15	QPSK	1	37	22.67	22.69	22.68



15	QPSK	1	74	22.57	22.39	22.17
15	QPSK	36	0	21.47	21.62	21.61
15	QPSK	36	20	21.49	21.54	21.51
15	QPSK	36	39	21.56	21.59	21.51
15	QPSK	75	0	21.61	21.55	21.52
15	16QAM	1	0	21.46	21.27	21.38
15	16QAM	1	37	21.83	21.96	21.41
15	16QAM	1	74	21.48	21.23	21.38
15	16QAM	36	0	20.44	20.49	20.49
15	16QAM	36	20	20.39	20.43	20.43
15	16QAM	36	39	20.49	20.47	20.44
15	16QAM	75	0	20.55	20.54	20.53
15	64QAM	1	0	20.64	20.62	20.69
15	64QAM	1	37	20.87	20.93	20.92
15	64QAM	1	74	20.57	20.31	20.33
15	64QAM	36	0	19.61	19.69	19.71
15	64QAM	36	20	19.55	19.71	19.59
15	64QAM	36	39	19.66	19.66	19.61
15	64QAM	75	0	19.59	19.49	19.5
Channel				20000	20175	20350
Frequency (MHz)				1715	1732.5	1750
10	QPSK	1	0	22.32	22.41	22.27
10	QPSK	1	25	22.69	22.68	22.51
10	QPSK	1	49	22.28	22.26	22.59
10	QPSK	25	0	21.58	21.65	21.56
10	QPSK	25	12	21.46	21.54	21.58
10	QPSK	25	25	21.44	21.55	21.47
10	QPSK	50	0	21.47	21.59	21.59
10	16QAM	1	0	21.42	21.49	21.48
10	16QAM	1	25	21.31	21.43	21.38
10	16QAM	1	49	21.27	21.23	21.48
10	16QAM	25	0	20.62	20.56	20.53
10	16QAM	25	12	20.47	20.45	20.56
10	16QAM	25	25	20.45	20.55	20.56
10	16QAM	50	0	20.51	20.58	20.52
10	64QAM	1	0	20.43	20.48	20.91



10	64QAM	1	25	20.5	20.92	20.96
10	64QAM	1	49	20.39	20.46	20.52
10	64QAM	25	0	19.74	19.81	19.77
10	64QAM	25	12	19.71	19.71	19.75
10	64QAM	25	25	19.56	19.5	19.67
10	64QAM	50	0	19.47	19.56	19.53
Channel				19975	20175	20375
Frequency (MHz)				1712.5	1732.5	1752.5
5	QPSK	1	0	22.17	22.29	22.07
5	QPSK	1	12	22.65	22.63	22.62
5	QPSK	1	24	22.15	22.33	22.35
5	QPSK	12	0	21.42	21.58	21.53
5	QPSK	12	7	21.57	21.6	21.59
5	QPSK	12	13	21.54	21.58	21.52
5	QPSK	25	0	21.54	21.62	21.54
5	16QAM	1	0	21.32	21.42	21.45
5	16QAM	1	12	21.43	21.33	21.39
5	16QAM	1	24	21.19	21.3	21.18
5	16QAM	12	0	20.42	20.53	20.36
5	16QAM	12	7	20.51	20.5	20.5
5	16QAM	12	13	20.51	20.4	20.46
5	16QAM	25	0	20.5	20.52	20.4
5	64QAM	1	0	20.35	20.43	20.39
5	64QAM	1	12	20.87	20.86	20.83
5	64QAM	1	24	20.32	20.42	20.4
5	64QAM	12	0	19.58	19.74	19.61
5	64QAM	12	7	19.56	19.7	19.59
5	64QAM	12	13	19.45	19.69	19.66
5	64QAM	25	0	19.43	19.38	19.69
Channel				19965	20175	20385
Frequency (MHz)				1711.5	1732.5	1753.5
3	QPSK	1	0	22.21	22.62	22.10
3	QPSK	1	8	22.24	22.65	22.21
3	QPSK	1	14	22.28	22.44	22.34
3	QPSK	8	0	21.53	21.59	21.47
3	QPSK	8	4	21.56	21.66	21.51



3	QPSK	8	7	21.56	21.57	21.51
3	QPSK	15	0	21.47	21.68	21.54
3	16QAM	1	0	21.29	21.84	21.18
3	16QAM	1	8	21.66	21.79	21.32
3	16QAM	1	14	21.70	21.78	21.32
3	16QAM	8	0	20.49	20.65	20.35
3	16QAM	8	4	20.66	20.60	20.60
3	16QAM	8	7	20.57	20.56	20.45
3	16QAM	15	0	20.15	20.58	20.33
3	64QAM	1	0	20.45	20.51	20.38
3	64QAM	1	8	20.41	20.48	20.35
3	64QAM	1	14	20.42	20.53	20.49
3	64QAM	8	0	19.37	19.68	19.45
3	64QAM	8	4	19.30	19.56	19.50
3	64QAM	8	7	19.22	19.57	19.35
3	64QAM	15	0	19.42	19.54	19.45
Channel				19957	20175	20393
Frequency (MHz)				1710.7	1732.5	1754.3
1.4	QPSK	1	0	22.29	22.44	22.00
1.4	QPSK	1	3	22.12	22.45	22.58
1.4	QPSK	1	5	22.29	22.33	22.34
1.4	QPSK	3	0	22.53	22.62	22.49
1.4	QPSK	3	1	22.52	22.65	22.62
1.4	QPSK	3	3	22.52	22.69	22.63
1.4	QPSK	6	0	21.49	21.63	21.64
1.4	16QAM	1	0	21.48	21.31	21.10
1.4	16QAM	1	3	21.57	21.70	21.29
1.4	16QAM	1	5	21.39	21.34	21.76
1.4	16QAM	3	0	21.55	21.63	21.54
1.4	16QAM	3	1	21.56	21.68	21.67
1.4	16QAM	3	3	21.56	21.60	21.26
1.4	16QAM	6	0	20.42	20.61	20.26
1.4	64QAM	1	0	20.53	20.88	20.80
1.4	64QAM	1	3	20.86	20.56	20.59
1.4	64QAM	1	5	20.36	20.53	20.51
1.4	64QAM	3	0	20.48	20.49	20.25





---

1.4	64QAM	3	1	20.56	20.53	20.09
1.4	64QAM	3	3	20.41	20.44	20.40
1.4	64QAM	6	0	19.38	19.46	19.49



LTE Band 5						
BW [MHz]	Modulation	RB Size	RB Offset	Power Low Ch. / Freq.	Power Middle Ch. / Freq.	Power High Ch. / Freq.
Channel				20450	20525	20600
Frequency (MHz)				829	836.5	844
10	QPSK	1	0	22.30	22.32	22.20
10	QPSK	1	25	22.69	22.59	22.50
10	QPSK	1	49	22.24	22.22	22.23
10	QPSK	25	0	21.65	21.59	21.50
10	QPSK	25	12	21.62	21.58	21.47
10	QPSK	25	25	21.49	21.49	21.41
10	QPSK	50	0	21.57	21.55	21.49
10	16QAM	1	0	21.10	21.09	21.53
10	16QAM	1	25	21.25	21.59	21.11
10	16QAM	1	49	21.19	21.12	21.29
10	16QAM	25	0	20.56	20.52	20.42
10	16QAM	25	12	20.54	20.53	20.30
10	16QAM	25	25	20.66	20.45	20.33
10	16QAM	50	0	20.61	20.43	20.50
10	64QAM	1	0	20.61	20.51	20.17
10	64QAM	1	25	20.26	20.43	20.33
10	64QAM	1	49	20.56	20.30	20.34
10	64QAM	25	0	19.53	19.51	19.44
10	64QAM	25	12	19.51	19.43	19.69
10	64QAM	25	25	19.49	19.26	19.32
10	64QAM	50	0	19.55	19.43	19.41
Channel				20425	20525	20625
Frequency (MHz)				826.5	836.5	846.5
5	QPSK	1	0	22.34	22.01	22.25
5	QPSK	1	12	22.44	22.43	22.49
5	QPSK	1	24	22.28	22.30	22.20
5	QPSK	12	0	21.61	21.50	21.22
5	QPSK	12	7	21.67	21.38	21.36
5	QPSK	12	13	21.56	21.34	21.41
5	QPSK	25	0	21.54	21.59	21.27



5	16QAM	1	0	21.00	21.05	21.60
5	16QAM	1	12	21.12	21.45	21.05
5	16QAM	1	24	21.27	21.20	21.26
5	16QAM	12	0	20.39	20.35	20.48
5	16QAM	12	7	20.45	20.52	20.14
5	16QAM	12	13	20.53	20.45	20.26
5	16QAM	25	0	20.65	20.26	20.32
5	64QAM	1	0	20.56	20.51	20.58
5	64QAM	1	12	20.34	20.43	20.33
5	64QAM	1	24	20.40	20.39	20.38
5	64QAM	12	0	19.34	19.32	19.45
5	64QAM	12	7	19.53	19.23	19.74
5	64QAM	12	13	19.53	19.33	19.22
5	64QAM	25	0	19.38	19.48	19.32
Channel				20415	20525	20635
Frequency (MHz)				825.5	836.5	847.5
3	QPSK	1	0	22.11	22.15	22.18
3	QPSK	1	8	22.59	22.49	22.38
3	QPSK	1	14	22.09	22.12	22.10
3	QPSK	8	0	21.68	21.58	21.48
3	QPSK	8	4	21.71	21.38	21.53
3	QPSK	8	7	21.51	21.29	21.28
3	QPSK	15	0	21.42	21.64	21.29
3	16QAM	1	0	21.06	21.18	21.47
3	16QAM	1	8	21.22	21.61	21.13
3	16QAM	1	14	21.17	21.08	21.29
3	16QAM	8	0	20.66	20.59	20.42
3	16QAM	8	4	20.54	20.37	20.20
3	16QAM	8	7	20.55	20.32	20.27
3	16QAM	15	0	20.71	20.37	20.45
3	64QAM	1	0	20.65	20.31	20.23
3	64QAM	1	8	20.26	20.32	20.25
3	64QAM	1	14	20.50	20.11	20.18
3	64QAM	8	0	19.51	19.61	19.51
3	64QAM	8	4	19.59	19.45	19.79
3	64QAM	8	7	19.48	19.25	19.35



3	64QAM	15	0	19.45	19.44	19.26
Channel				20407	20525	20643
Frequency (MHz)				824.7	836.5	848.3
1.4	QPSK	1	0	22.40	22.31	22.24
1.4	QPSK	1	3	22.63	22.38	22.29
1.4	QPSK	1	5	22.59	22.46	22.27
1.4	QPSK	3	0	22.54	22.39	22.08
1.4	QPSK	3	1	22.47	22.55	22.25
1.4	QPSK	3	3	22.46	22.45	22.30
1.4	QPSK	6	0	21.70	21.62	21.37
1.4	16QAM	1	0	21.63	21.19	21.19
1.4	16QAM	1	3	21.65	21.56	21.37
1.4	16QAM	1	5	21.29	21.21	21.23
1.4	16QAM	3	0	21.68	21.60	21.44
1.4	16QAM	3	1	21.72	21.75	21.48
1.4	16QAM	3	3	21.67	21.71	21.41
1.4	16QAM	6	0	20.61	20.56	20.26
1.4	64QAM	1	0	20.68	20.69	20.36
1.4	64QAM	1	3	20.73	20.45	20.35
1.4	64QAM	1	5	20.68	20.76	20.72
1.4	64QAM	3	0	20.74	20.60	20.37
1.4	64QAM	3	1	20.72	20.67	20.44
1.4	64QAM	3	3	20.68	20.57	20.33
1.4	64QAM	6	0	19.53	19.42	19.31



LTE Band 66						
BW [MHz]	Modulation	RB Size	RB Offset	Power Low Ch. / Freq.	Power Middle Ch. / Freq.	Power High Ch. / Freq.
Channel				132072	132322	132572
Frequency (MHz)				1720	1745	1770
20	QPSK	1	0	22.40	22.38	22.37
20	QPSK	1	49	22.59	22.71	22.46
20	QPSK	1	99	22.41	22.40	22.39
20	QPSK	50	0	21.80	21.83	21.58
20	QPSK	50	24	21.75	21.81	21.45
20	QPSK	50	50	21.72	21.76	21.56
20	QPSK	100	0	21.74	21.80	21.53
20	16QAM	1	0	21.49	21.54	21.45
20	16QAM	1	49	21.46	21.82	21.52
20	16QAM	1	99	21.44	21.55	21.41
20	16QAM	50	0	20.62	20.82	20.62
20	16QAM	50	24	20.69	20.84	20.47
20	16QAM	50	50	20.76	20.70	20.39
20	16QAM	100	0	20.67	20.79	20.43
20	64QAM	1	0	20.55	21.16	20.76
20	64QAM	1	49	21.25	21.26	21.14
20	64QAM	1	99	20.58	20.77	20.66
20	64QAM	50	0	19.54	19.84	19.59
20	64QAM	50	24	19.68	19.77	19.34
20	64QAM	50	50	19.59	19.76	19.29
20	64QAM	100	0	19.74	19.8	19.44
Channel				132047	132322	132597
Frequency (MHz)				1717.5	1745	1772.5
15	QPSK	1	0	22.23	22.28	22.19
15	QPSK	1	37	22.44	22.55	22.2
15	QPSK	1	74	22.21	22.17	22.12
15	QPSK	36	0	21.51	21.76	21.49
15	QPSK	36	20	21.5	21.76	21.38
15	QPSK	36	39	21.6	21.72	21.31
15	QPSK	75	0	21.52	21.81	21.39



15	16QAM	1	0	21.44	21.75	21.55
15	16QAM	1	37	21.82	22.14	21.74
15	16QAM	1	74	22.05	21.54	21.41
15	16QAM	36	0	20.47	20.75	20.35
15	16QAM	36	20	20.5	20.77	20.25
15	16QAM	36	39	20.49	20.75	20.25
15	16QAM	75	0	20.58	20.79	20.36
15	64QAM	1	0	20.59	20.54	20.48
15	64QAM	1	37	20.96	21.08	20.99
15	64QAM	1	74	20.6	20.96	20.38
15	64QAM	36	0	19.64	19.84	19.51
15	64QAM	36	20	19.66	19.95	19.38
15	64QAM	36	39	19.67	19.61	19.38
15	64QAM	75	0	19.72	19.61	19.25
Channel				132022	132322	132622
Frequency (MHz)				1715	1745	1775
10	QPSK	1	0	22.01	22.22	22.01
10	QPSK	1	25	22.17	22.41	22.15
10	QPSK	1	49	22.11	22.35	22.03
10	QPSK	25	0	21.63	21.88	21.38
10	QPSK	25	12	21.58	21.78	21.3
10	QPSK	25	25	21.54	21.79	21.3
10	QPSK	50	0	21.58	21.81	21.33
10	16QAM	1	0	21.31	21.57	21.26
10	16QAM	1	25	21.44	21.62	21.23
10	16QAM	1	49	21.46	21.62	21.07
10	16QAM	25	0	20.52	20.98	20.38
10	16QAM	25	12	20.5	20.89	20.42
10	16QAM	25	25	20.39	20.6	20.38
10	16QAM	50	0	20.46	20.75	20.37
10	64QAM	1	0	20.25	20.77	20.36
10	64QAM	1	25	21.03	21.03	20.73
10	64QAM	1	49	20.55	20.7	20.37
10	64QAM	25	0	19.68	19.67	19.49
10	64QAM	25	12	19.66	19.71	19.43
10	64QAM	25	25	19.41	19.64	19.2



10	64QAM	50	0	19.53	19.72	19.29
Channel				131997	132322	132647
Frequency (MHz)				1712.5	1745	1777.5
5	QPSK	1	0	22.01	22.03	22.04
5	QPSK	1	12	22.37	22.51	22.19
5	QPSK	1	24	22.03	22.34	22.05
5	QPSK	12	0	21.6	21.79	21.37
5	QPSK	12	7	21.61	21.75	21.4
5	QPSK	12	13	21.5	21.83	21.29
5	QPSK	25	0	21.51	21.84	21.31
5	16QAM	1	0	21.35	21.66	21.15
5	16QAM	1	12	21.34	21.63	21.16
5	16QAM	1	24	21.28	21.54	21.03
5	16QAM	12	0	20.47	20.56	20.1
5	16QAM	12	7	20.48	20.76	20.26
5	16QAM	12	13	20.35	20.75	20.33
5	16QAM	25	0	20.67	20.87	20.36
5	64QAM	1	0	20.42	20.71	20.46
5	64QAM	1	12	20.83	21.16	20.66
5	64QAM	1	24	20.46	20.64	20.55
5	64QAM	12	0	19.56	19.69	19.15
5	64QAM	12	7	19.51	19.65	19.17
5	64QAM	12	13	19.49	19.64	19.12
5	64QAM	25	0	19.53	19.66	19.38
Channel				131987	132322	132657
Frequency (MHz)				1711.5	1745	1778.5
3	QPSK	1	0	22.07	22.26	22.18
3	QPSK	1	8	22.30	22.20	22.17
3	QPSK	1	14	22.17	22.23	22.02
3	QPSK	8	0	21.66	21.76	21.55
3	QPSK	8	4	21.59	21.75	21.46
3	QPSK	8	7	21.66	21.79	21.53
3	QPSK	15	0	21.56	21.76	21.48
3	16QAM	1	0	21.54	21.81	21.16
3	16QAM	1	8	21.40	21.61	21.19
3	16QAM	1	14	21.49	21.50	21.31



3	16QAM	8	0	20.69	20.79	20.40
3	16QAM	8	4	20.44	20.81	20.27
3	16QAM	8	7	20.66	20.84	20.52
3	16QAM	15	0	20.53	20.77	20.28
3	64QAM	1	0	20.46	20.78	20.32
3	64QAM	1	8	20.39	20.66	20.29
3	64QAM	1	14	20.45	20.74	20.25
3	64QAM	8	0	19.63	19.78	19.46
3	64QAM	8	4	19.41	19.78	19.37
3	64QAM	8	7	19.40	19.74	19.31
3	64QAM	15	0	19.39	19.84	19.32
Channel				131979	132322	132665
Frequency (MHz)				1710.7	1745	1779.3
1.4	QPSK	1	0	22.47	22.53	22.16
1.4	QPSK	1	3	22.28	22.61	22.20
1.4	QPSK	1	5	22.20	22.49	22.09
1.4	QPSK	3	0	22.32	22.61	22.17
1.4	QPSK	3	1	22.49	22.54	22.46
1.4	QPSK	3	3	22.41	22.55	22.09
1.4	QPSK	6	0	21.29	22.00	21.45
1.4	16QAM	1	0	21.43	21.67	21.36
1.4	16QAM	1	3	21.52	21.81	21.43
1.4	16QAM	1	5	21.40	21.52	21.30
1.4	16QAM	3	0	21.41	22.10	21.48
1.4	16QAM	3	1	21.57	21.95	21.52
1.4	16QAM	3	3	21.71	21.85	21.52
1.4	16QAM	6	0	20.39	20.69	20.08
1.4	64QAM	1	0	20.84	21.08	20.76
1.4	64QAM	1	3	20.57	21.00	20.39
1.4	64QAM	1	5	20.93	21.05	20.41
1.4	64QAM	3	0	20.70	20.85	20.31
1.4	64QAM	3	1	20.40	20.81	20.26
1.4	64QAM	3	3	20.33	20.80	20.20
1.4	64QAM	6	0	19.37	19.71	19.07





**ERP/EIRP**

LTE Band 5 (GT - LC = -2.8 dB) QPSK									
Bandwidth	1.4M			3M			5M		
Channel	20407	20525	20643	20415	20525	20635	20425	20525	20625
	(Low)	(Mid)	(High)	(Low)	(Mid)	(High)	(Low)	(Mid)	(High)
Frequency	824.7	836.5	848.3	825.5	836.5	847.5	826.5	836.5	846.5
(MHz)									
Conducted Power (dBm)	22.63	22.38	22.29	22.59	22.49	22.38	22.44	22.43	22.49
Conducted Power (Watts)	0.1832	0.1730	0.1694	0.1816	0.1774	0.1730	0.1754	0.1750	0.1774
ERP(dBm)	17.68	17.43	17.34	17.64	17.54	17.43	17.49	17.48	17.54
ERP(Watts)	0.0586	0.0553	0.0542	0.0581	0.0568	0.0553	0.0561	0.0560	0.0568

LTE Band 5 (GT - LC = -2.8 dB) QPSK			
Bandwidth	10M		
Channel	20450	20525	20600
	(Low)	(Mid)	(High)
Frequency	829	836.5	844
(MHz)			
Conducted Power (dBm)	22.69	22.59	22.50
Conducted Power (Watts)	0.1858	0.1816	0.1778
ERP(dBm)	17.74	17.64	17.55
ERP(Watts)	0.0594	0.0581	0.0569



LTE Band 5 (GT - LC = -2.8 dB) 16QAM									
Bandwidth	1.4M			3M			5M		
Channel	20407	20525	20643	20415	20525	20635	20425	20525	20625
	(Low)	(Mid)	(High)	(Low)	(Mid)	(High)	(Low)	(Mid)	(High)
Frequency (MHz)	824.7	836.5	848.3	825.5	836.5	847.5	826.5	836.5	846.5
Conducted Power (dBm)	21.72	21.75	21.48	21.22	21.61	21.13	21.12	21.45	21.05
Conducted Power (Watts)	0.1486	0.1496	0.1406	0.1324	0.1449	0.1297	0.1294	0.1396	0.1274
ERP(dBm)	16.77	16.80	16.53	16.27	16.66	16.18	16.17	16.50	16.10
ERP(Watts)	0.0475	0.0479	0.0450	0.0424	0.0463	0.0415	0.0414	0.0447	0.0407

LTE Band 5 (GT - LC = -2.8 dB) 16QAM			
Bandwidth	10M		
Channel	20450	20525	20600
	(Low)	(Mid)	(High)
Frequency (MHz)	829	836.5	844
Conducted Power (dBm)	21.25	21.59	21.11
Conducted Power (Watts)	0.1334	0.1442	0.1291
ERP(dBm)	16.30	16.64	16.16
ERP(Watts)	0.0427	0.0461	0.0413



LTE Band 5 (GT - LC = -2.8 dB) 64QAM									
Bandwidth	1.4M			3M			5M		
Channel	20407	20525	20643	20415	20525	20635	20425	20525	20625
	(Low)	(Mid)	(High)	(Low)	(Mid)	(High)	(Low)	(Mid)	(High)
Frequency (MHz)	824.7	836.5	848.3	825.5	836.5	847.5	826.5	836.5	846.5
Conducted Power (dBm)	20.68	20.76	20.72	20.65	20.31	20.23	20.56	20.51	20.58
Conducted Power (Watts)	0.1169	0.1191	0.1180	0.1161	0.1074	0.1054	0.1138	0.1125	0.1143
ERP(dBm)	15.73	15.81	15.77	15.70	15.36	15.28	15.61	15.56	15.63
ERP(Watts)	0.0374	0.0381	0.0378	0.0372	0.0344	0.0337	0.0364	0.0360	0.0366

LTE Band 5 (GT - LC = -2.8 dB) 64QAM			
Bandwidth	10M		
Channel	20450	20525	20600
	(Low)	(Mid)	(High)
Frequency (MHz)	829	836.5	844
Conducted Power (dBm)	20.61	20.51	20.17
Conducted Power (Watts)	0.1151	0.1125	0.1040
ERP(dBm)	15.66	15.56	15.22
ERP(Watts)	0.0368	0.0360	0.0333



LTE Band 66 (GT - LC = -2.3 dB) QPSK									
Bandwidth	1.4M			3M			5M		
Channel	131979	132322	132665	131987	132322	132657	131997	132322	132647
	(Low)	(Mid)	(High)	(Low)	(Mid)	(High)	(Low)	(Mid)	(High)
Frequency (MHz)	1710.7	1745	1779.3	1711.5	1745	1778.5	1712.5	1745	1777.5
Conducted Power (dBm)	22.28	22.61	22.20	22.30	22.20	22.17	22.37	22.51	22.19
Conducted Power (Watts)	0.1690	0.1824	0.1660	0.1698	0.1660	0.1648	0.1726	0.1782	0.1656
EIRP(dBm)	19.98	20.31	19.90	20.00	19.90	19.87	20.07	20.21	19.89
EIRP(Watts)	0.0995	0.1074	0.0977	0.1000	0.0977	0.0971	0.1016	0.1050	0.0975

LTE Band 66 (GT - LC = -2.3 dB) QPSK									
Bandwidth	10M			15M			20M		
Channel	132022	132322	132622	132047	132322	132597	132072	132322	132572
	(Low)	(Mid)	(High)	(Low)	(Mid)	(High)	(Low)	(Mid)	(Mid)
Frequency (MHz)	1715	1745	1775	1717.5	1745	1772.5	1720	1745	1770
Conducted Power (dBm)	22.17	22.41	22.15	22.44	22.55	22.20	22.59	22.71	22.46
Conducted Power (Watts)	0.1648	0.1742	0.1641	0.1754	0.1799	0.1660	0.1816	0.1866	0.1762
EIRP(dBm)	19.87	20.11	19.85	20.14	20.25	19.90	20.29	20.41	20.16
EIRP(Watts)	0.0971	0.1026	0.0966	0.1033	0.1059	0.0977	0.1069	0.1099	0.1038



LTE Band 66 (GT - LC = -2.3 dB) 16QAM									
Bandwidth	1.4M			3M			5M		
Channel	131979	132322	132665	131987	132322	132657	131997	132322	132647
	(Low)	(Mid)	(High)	(Low)	(Mid)	(High)	(Low)	(Mid)	(High)
Frequency (MHz)	1710.7	1745	1779.3	1711.5	1745	1778.5	1712.5	1745	1777.5
Conducted Power (dBm)	21.41	22.10	21.48	21.54	21.81	21.16	21.35	21.66	21.15
Conducted Power (Watts)	0.1384	0.1622	0.1406	0.1426	0.1517	0.1306	0.1365	0.1466	0.1303
EIRP(dBm)	19.11	19.80	19.18	19.24	19.51	18.86	19.05	19.36	18.85
EIRP(Watts)	0.0815	0.0955	0.0828	0.0839	0.0893	0.0769	0.0804	0.0863	0.0767

LTE Band 66 (GT - LC = -2.3 dB) 16QAM									
Bandwidth	10M			15M			20M		
Channel	132022	132322	132622	132047	132322	132597	132072	132322	132572
	(Low)	(Mid)	(High)	(Low)	(Mid)	(High)	(Low)	(Mid)	(Mid)
Frequency (MHz)	1715	1745	1775	1717.5	1745	1772.5	1720	1745	1770
Conducted Power (dBm)	21.44	21.62	21.23	21.82	22.14	21.74	21.46	21.82	21.52
Conducted Power (Watts)	0.1393	0.1452	0.1327	0.1521	0.1637	0.1493	0.1400	0.1521	0.1419
EIRP(dBm)	19.14	19.32	18.93	19.52	19.84	19.44	19.16	19.52	19.22
EIRP(Watts)	0.0820	0.0855	0.0782	0.0895	0.0964	0.0879	0.0824	0.0895	0.0836



LTE Band 66 (GT - LC = -2.3 dB) 64QAM									
Bandwidth	1.4M			3M			5M		
Channel	131979	132322	132665	131987	132322	132657	131997	132322	132647
	(Low)	(Mid)	(High)	(Low)	(Mid)	(High)	(Low)	(Mid)	(High)
Frequency	1710.7	1745	1779.3	1711.5	1745	1778.5	1712.5	1745	1777.5
(MHz)									
Conducted Power (dBm)	20.84	21.08	20.76	20.46	20.78	20.32	20.83	21.16	20.66
Conducted Power (Watts)	0.1213	0.1282	0.1191	0.1112	0.1197	0.1076	0.1211	0.1306	0.1164
EIRP(dBm)	18.54	18.78	18.46	18.16	18.48	18.02	18.53	18.86	18.36
EIRP(Watts)	0.0714	0.0755	0.0701	0.0655	0.0705	0.0634	0.0713	0.0769	0.0685

LTE Band 66 (GT - LC = -2.3 dB) 64QAM									
Bandwidth	10M			15M			20M		
Channel	132022	132322	132622	132047	132322	132597	132072	132322	132572
	(Low)	(Mid)	(High)	(Low)	(Mid)	(High)	(Low)	(Mid)	(Mid)
Frequency	1715	1745	1775	1717.5	1745	1772.5	1720	1745	1770
(MHz)									
Conducted Power (dBm)	21.03	21.03	20.73	20.96	21.08	20.99	21.25	21.26	21.14
Conducted Power (Watts)	0.1268	0.1268	0.1183	0.1247	0.1282	0.1256	0.1334	0.1337	0.1300
EIRP(dBm)	18.73	18.73	18.43	18.66	18.78	18.69	18.95	18.96	18.84
EIRP(Watts)	0.0746	0.0746	0.0697	0.0735	0.0755	0.0740	0.0785	0.0787	0.0766



# LTE Band 5

## Peak-to-Average Ratio

Mode	LTE Band 5 / 10MHz				
Mod.	QPSK		16QAM		Limit: 13dB
RB Size	1RB	Full RB	1RB	Full RB	Result
Lowest CH	5.01	5.04	6.23	6.14	<b>PASS</b>
Middle CH	5.04	5.30	6.26	6.23	
Highest CH	5.19	5.10	6.52	6.06	
Mode	LTE Band 5 / 10MHz				
Mod.	64QAM				Limit: 13dB
RB Size	1RB	Full RB			Result
Lowest CH	6.58	6.38	-	-	<b>PASS</b>
Middle CH	6.35	6.46	-	-	
Highest CH	6.84	6.29	-	-	



LTE Band 5 / 10MHz / QPSK

Lowest Channel / 1RB

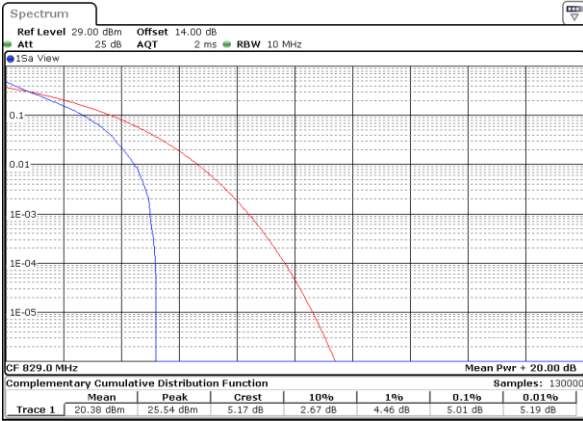

Date: 20\_NOV.2020 11:03:37

Lowest Channel / Full RB

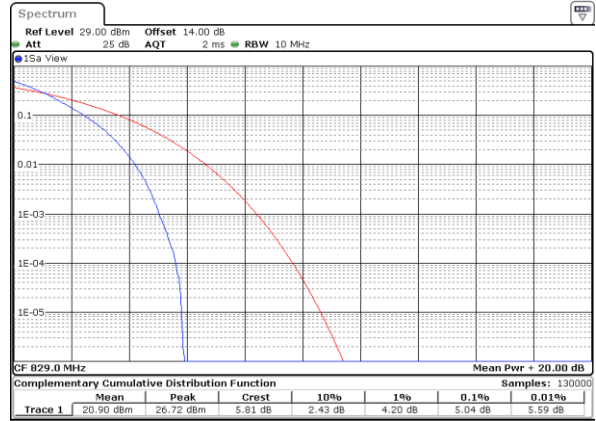

Date: 20\_NOV.2020 11:02:08

Middle Channel / 1RB



Date: 20\_NOV.2020 11:03:56

Middle Channel / Full RB

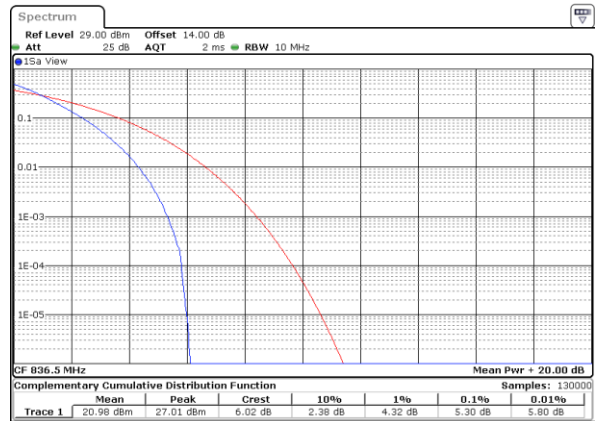

Date: 20\_NOV.2020 11:05:01

Highest Channel / 1RB



Date: 20\_NOV.2020 11:07:18

Highest Channel / Full RB

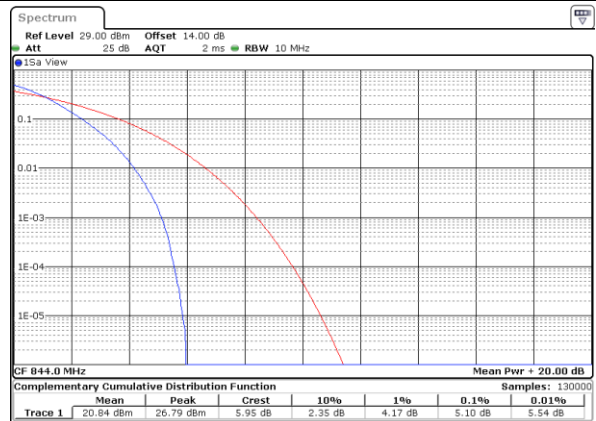

Date: 20\_NOV.2020 11:05:25





LTE Band 5 / 10MHz / 16QAM

Lowest Channel / 1RB

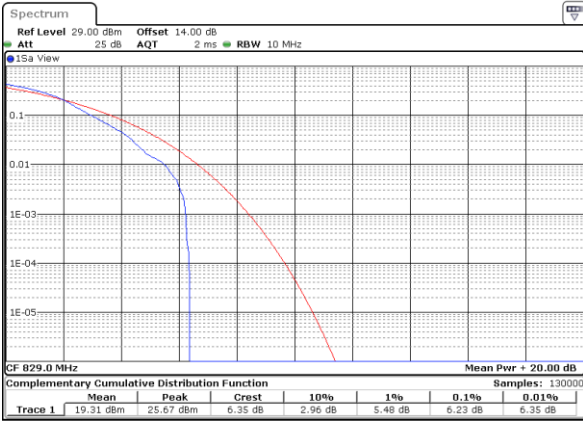

Date: 20,NOV,2020 11:03:25

Lowest Channel / Full RB

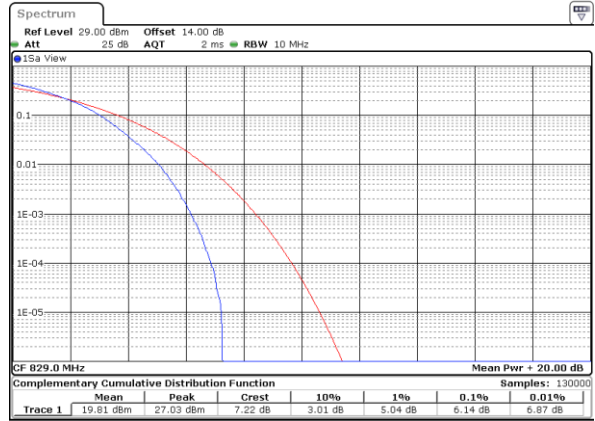

Date: 20,NOV,2020 11:02:20

Middle Channel / 1RB



Date: 20,NOV,2020 11:04:08

Middle Channel / Full RB

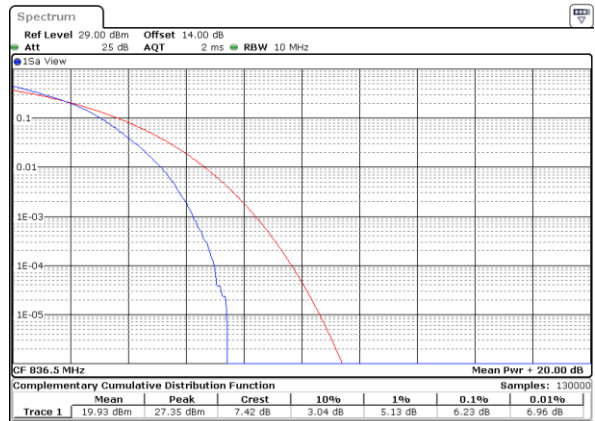

Date: 20,NOV,2020 11:04:50

Highest Channel / 1RB



Date: 20,NOV,2020 11:07:06

Highest Channel / Full RB

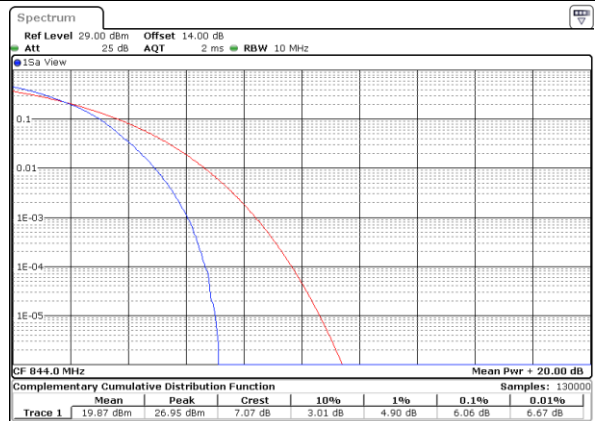

Date: 20,NOV,2020 11:05:56



LTE Band 5 / 10MHz / 64QAM

Lowest Channel / 1RB

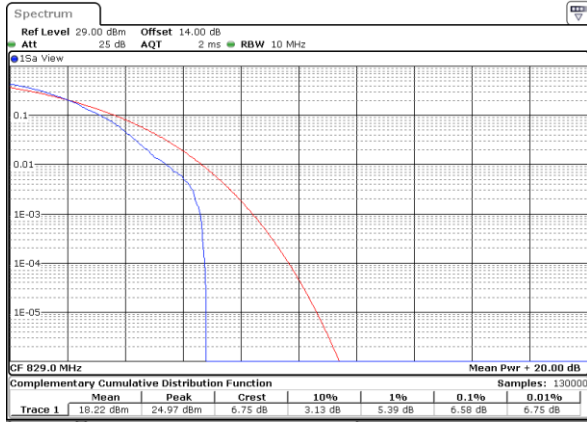

Date: 20,NOV,2020 11:03:13

Lowest Channel / Full RB

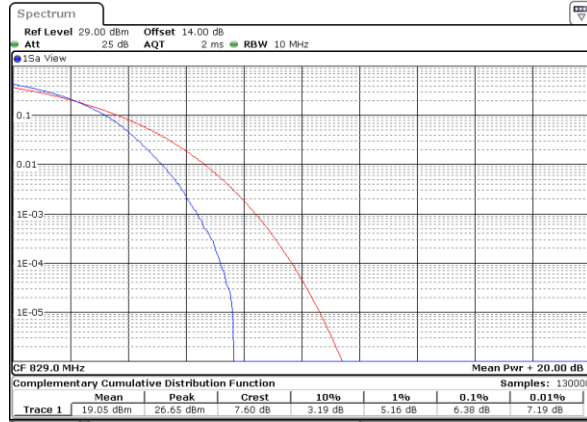

Date: 20,NOV,2020 11:02:51

Middle Channel / 1RB

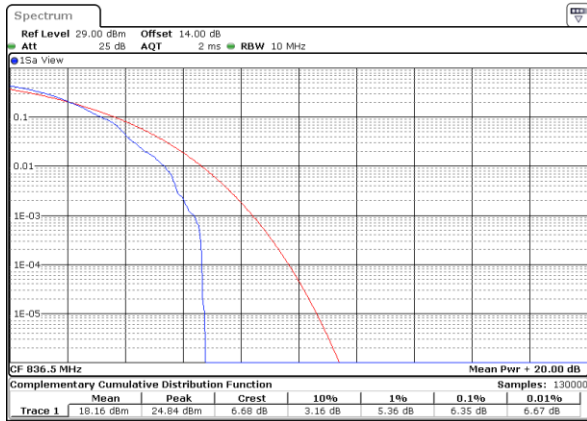

Date: 20,NOV,2020 11:04:20

Middle Channel / Full RB

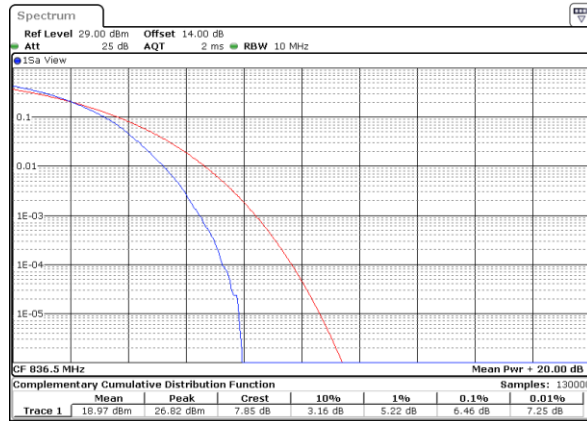

Date: 20,NOV,2020 11:04:34

Highest Channel / 1RB

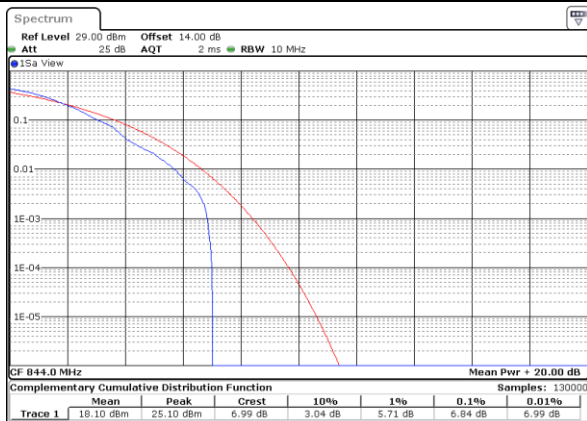

Date: 20,NOV,2020 11:06:29

Highest Channel / Full RB

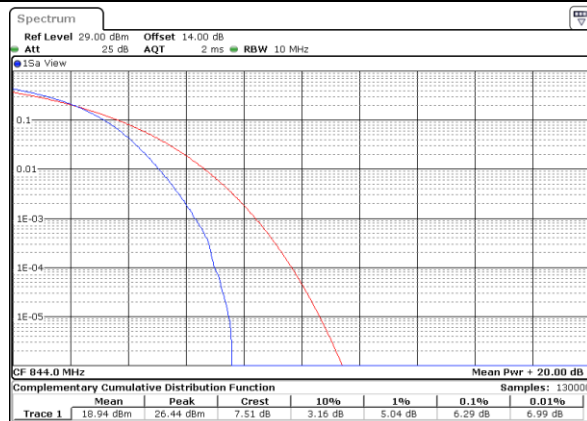

Date: 20,NOV,2020 11:06:13



**26dB Bandwidth**

Mode	LTE Band 5 : 26dB BW(MHz)											
BW	1.4MHz		3MHz		5MHz		10MHz					
Mod.	QPSK	16QAM	QPSK	16QAM	QPSK	16QAM	QPSK	16QAM				
Lowest CH	1.25	1.29	3.06	2.97	4.82	4.88	9.81	9.71				
Middle CH	1.30	1.28	2.97	2.99	4.93	4.88	9.83	9.89				
Highest CH	1.29	1.29	3.03	2.98	4.95	4.85	9.79	9.83				
Mode	LTE Band 5 : 26dB BW(MHz)											
BW	1.4MHz		3MHz		5MHz		10MHz					
Mod.	64QAM		64QAM		64QAM		64QAM					
Lowest CH	1.26	-	3.01	-	4.97	-	9.95	-				
Middle CH	1.29	-	2.99	-	4.87	-	9.85	-				
Highest CH	1.30	-	3.00	-	4.83	-	9.67	-				



LTE Band 5

Lowest Channel / 1.4MHz / QPSK

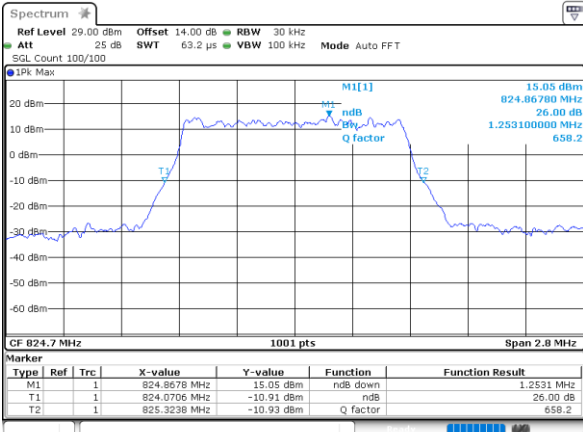

Date: 18\_NOV\_2020 15:12:15

Lowest Channel / 1.4MHz / 16QAM

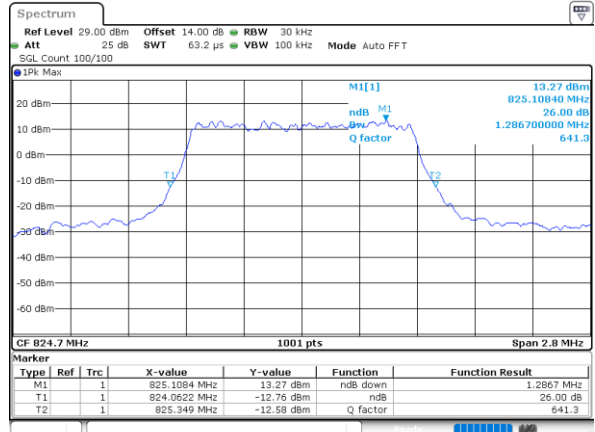

Date: 18\_NOV\_2020 15:12:56

Middle Channel / 1.4MHz / QPSK

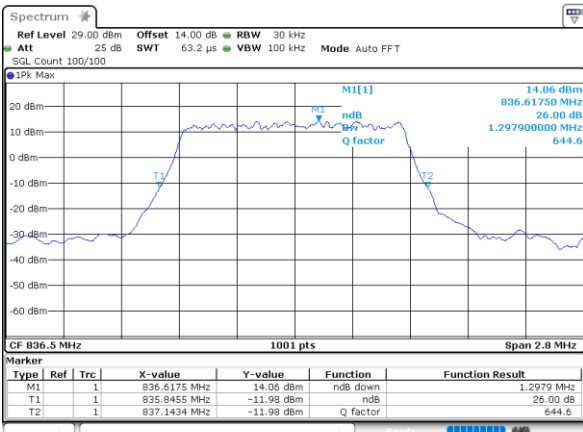

Date: 18\_NOV\_2020 15:28:58

Middle Channel / 1.4MHz / 16QAM

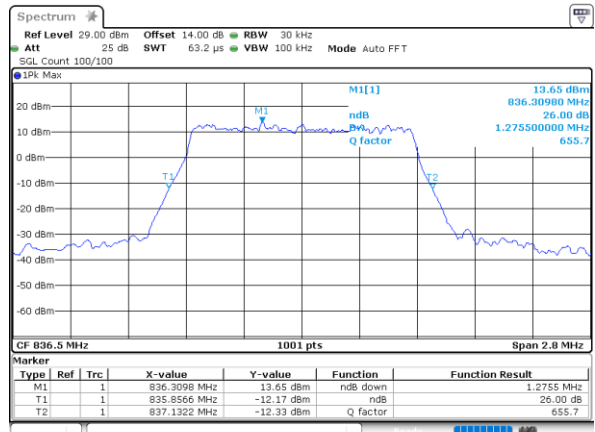

Date: 18\_NOV\_2020 15:28:20

Highest Channel / 1.4MHz / QPSK

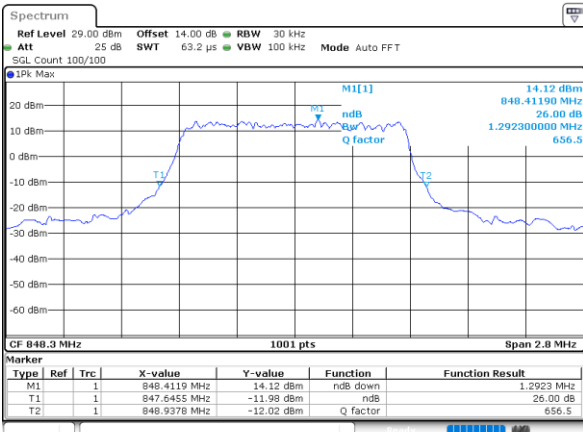

Date: 18\_NOV\_2020 16:08:43

Highest Channel / 1.4MHz / 16QAM

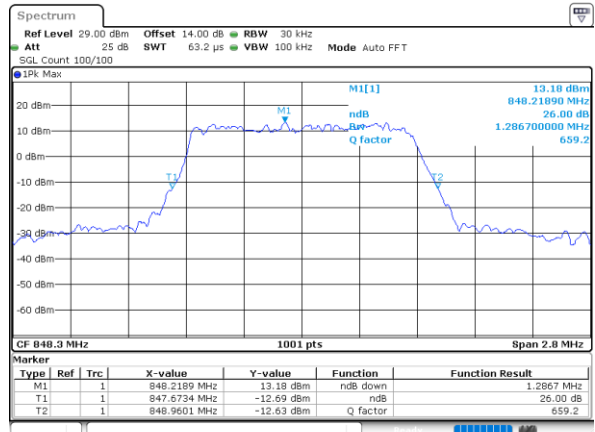

Date: 18\_NOV\_2020 16:10:40



LTE Band 5

Lowest Channel / 3MHz / QPSK

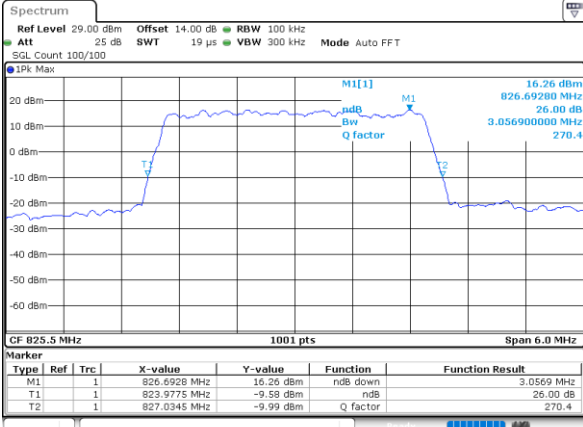

Date: 19\_NOV.2020 16:54:31

Lowest Channel / 3MHz / 16QAM

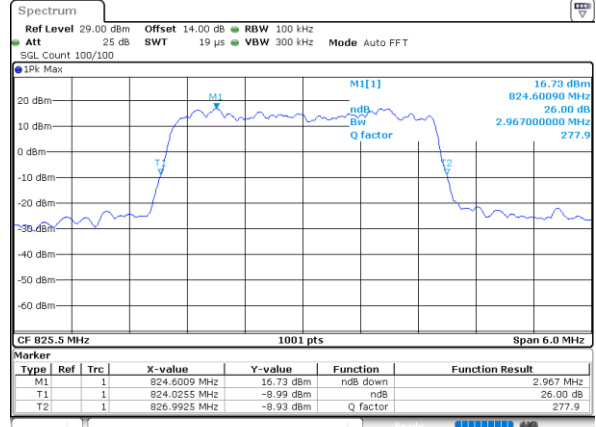

Date: 19\_NOV.2020 16:56:15

Middle Channel / 3MHz / QPSK

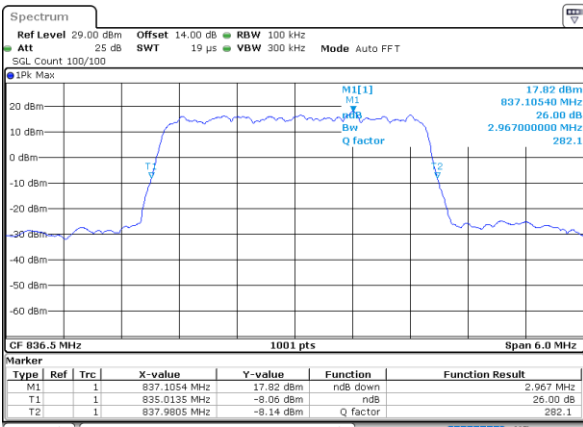

Date: 19\_NOV.2020 17:11:52

Middle Channel / 3MHz / 16QAM

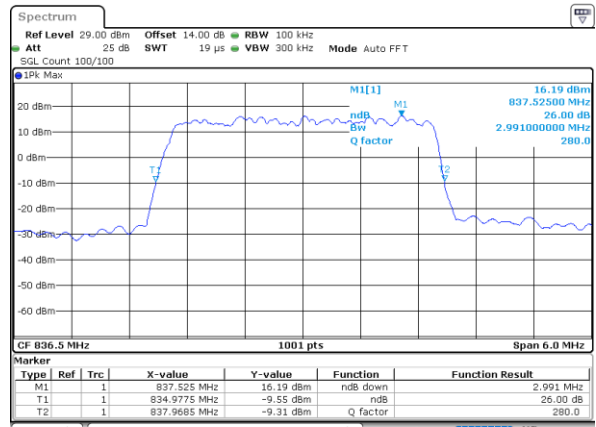

Date: 19\_NOV.2020 17:10:56

Highest Channel / 3MHz / QPSK

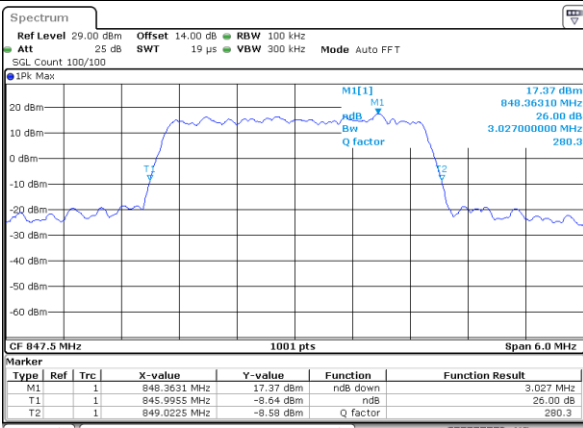

Date: 19\_NOV.2020 17:25:19

Highest Channel / 3MHz / 16QAM

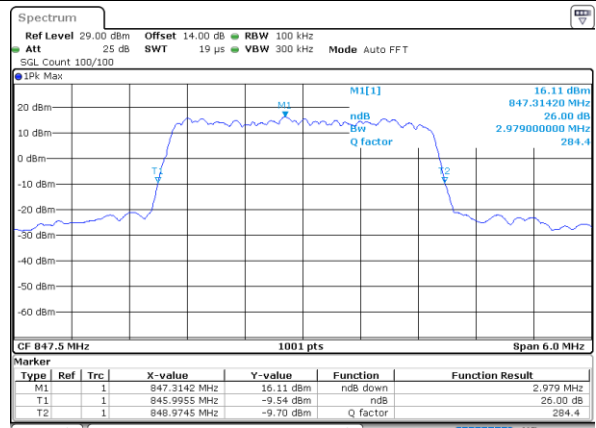

Date: 19\_NOV.2020 17:26:53



LTE Band 5

Lowest Channel / 5MHz / QPSK

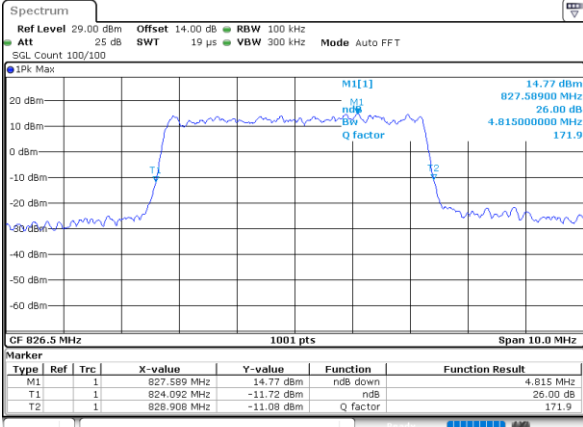

Date: 20,NOV,2020 09:30:17

Lowest Channel / 5MHz / 16QAM

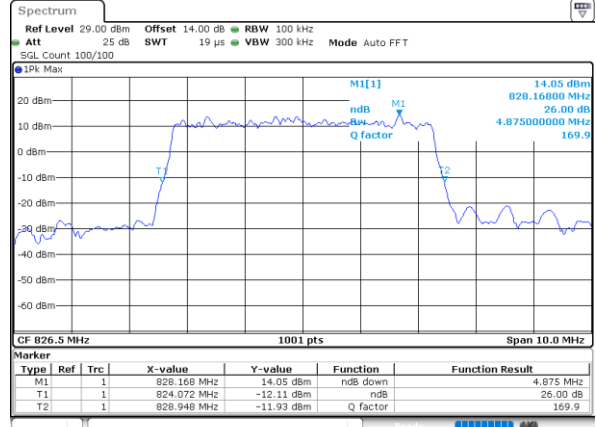

Date: 20,NOV,2020 09:31:24

Middle Channel / 5MHz / QPSK

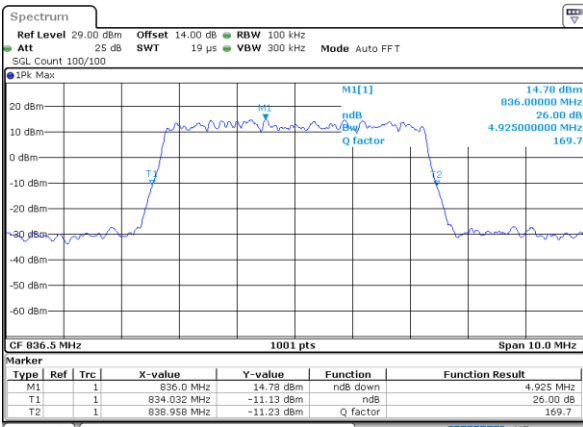

Date: 20,NOV,2020 09:48:53

Middle Channel / 5MHz / 16QAM

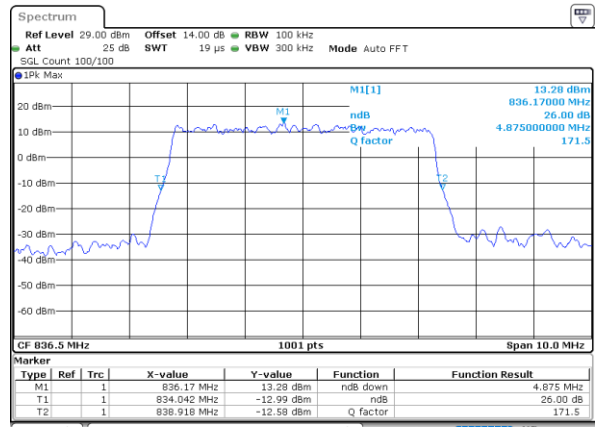

Date: 20,NOV,2020 09:48:34

Highest Channel / 5MHz / QPSK

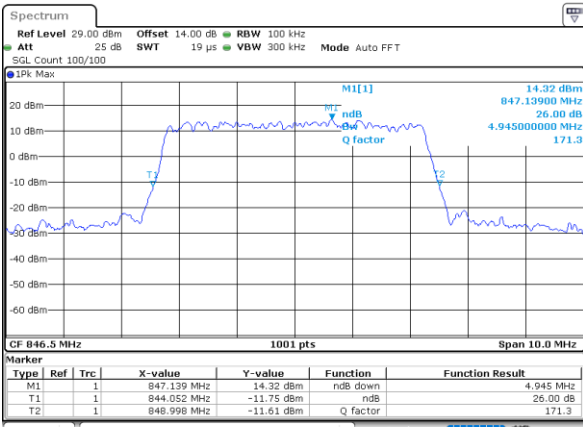

Date: 20,NOV,2020 09:49:29

Highest Channel / 5MHz / 16QAM

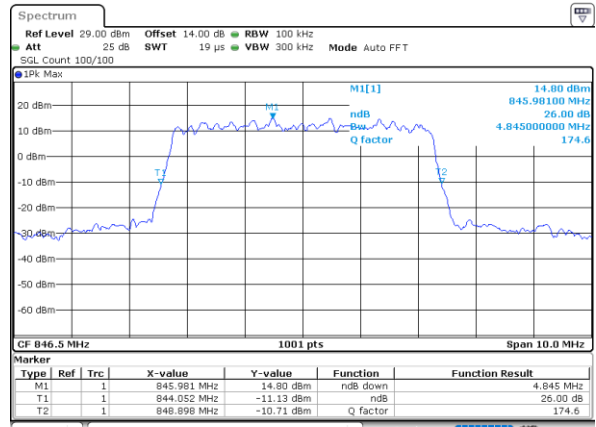

Date: 20,NOV,2020 09:50:30



LTE Band 5

Lowest Channel / 10MHz / QPSK

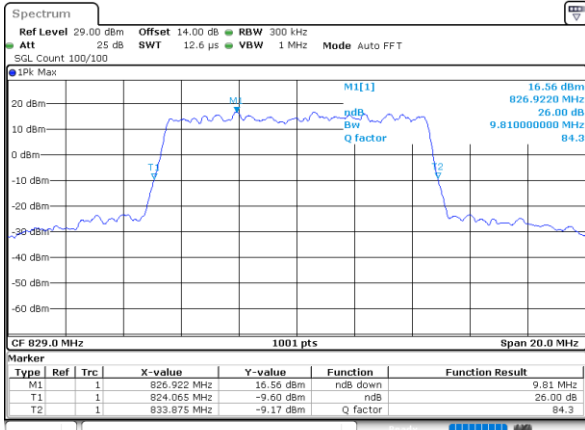

Date: 20,NOV,2020 09:55:14

Lowest Channel / 10MHz / 16QAM

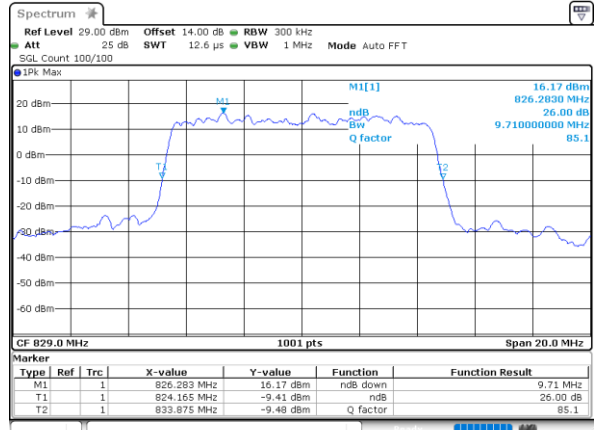

Date: 20,NOV,2020 08:15:57

Middle Channel / 10MHz / QPSK

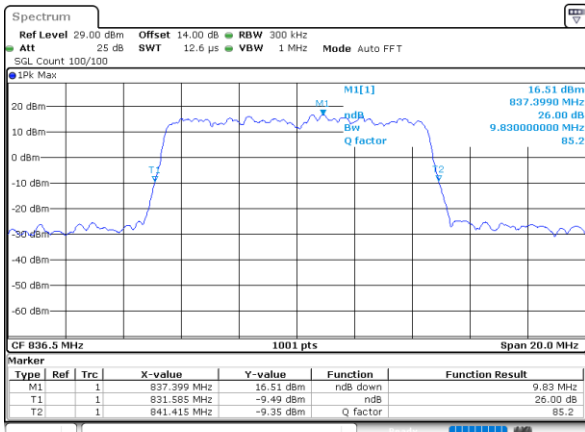

Date: 20,NOV,2020 09:12:08

Middle Channel / 10MHz / 16QAM

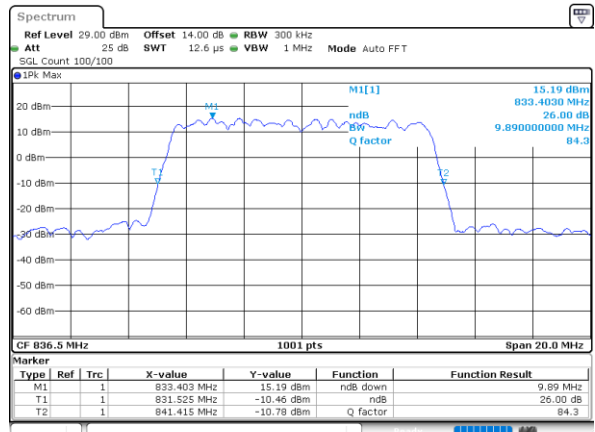

Date: 20,NOV,2020 09:12:13

Highest Channel / 10MHz / QPSK

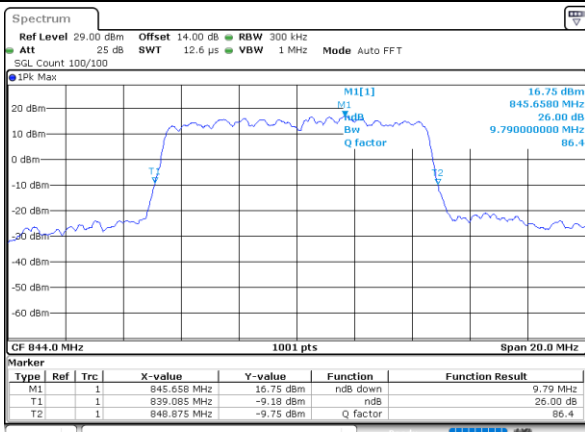

Date: 20,NOV,2020 09:13:20

Highest Channel / 10MHz / 16QAM

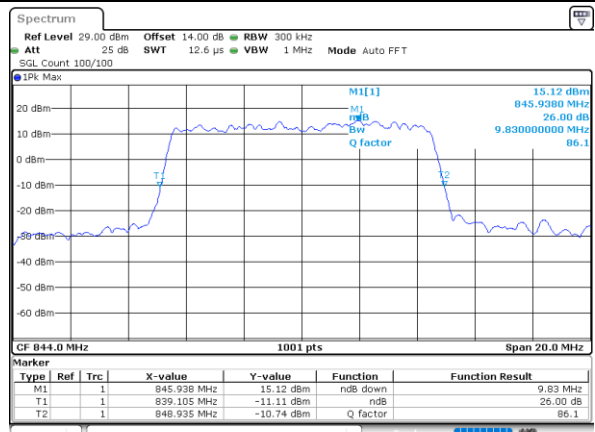

Date: 20,NOV,2020 09:14:15



LTE Band 5

Lowest Channel / 1.4MHz / 64QAM

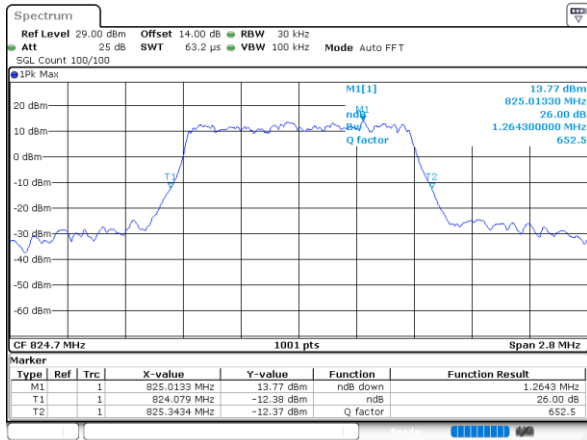

Date: 18,NOV,2020 15:17:55

Lowest Channel / 3MHz / 64QAM

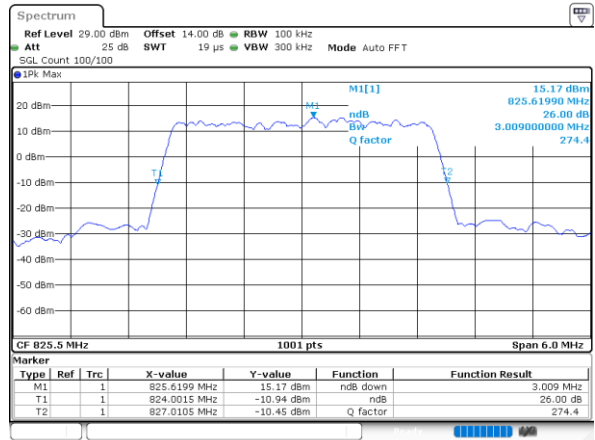

Date: 19,NOV,2020 16:58:04

Middle Channel / 1.4MHz / 64QAM

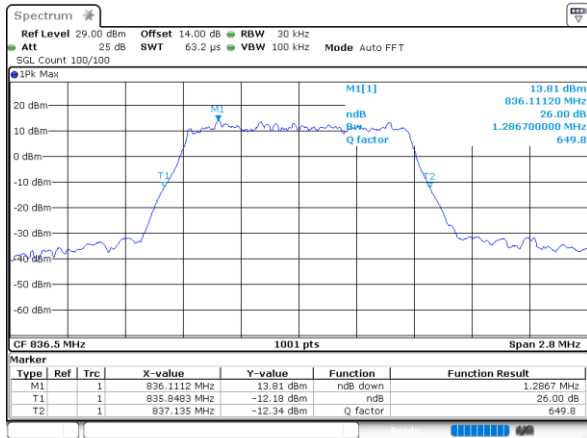

Date: 18,NOV,2020 15:27:51

Middle Channel / 3MHz / 64QAM

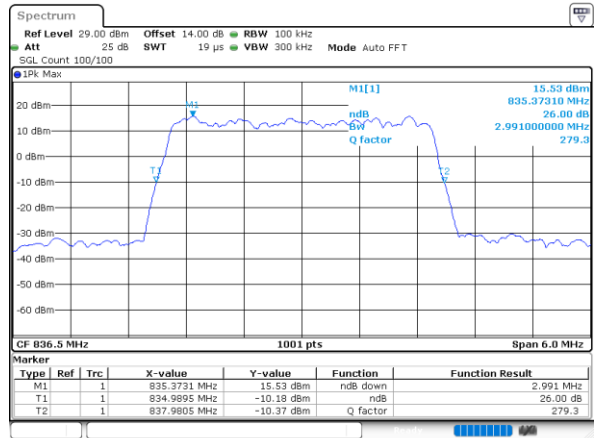

Date: 19,NOV,2020 17:11:26

Highest Channel / 1.4MHz / 64QAM

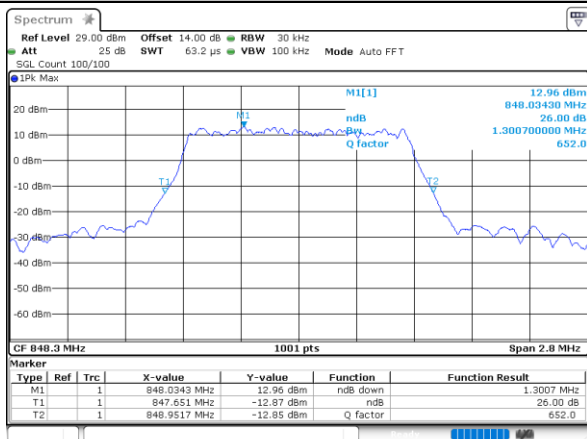

Date: 18,NOV,2020 16:13:20

Highest Channel / 3MHz / 64QAM

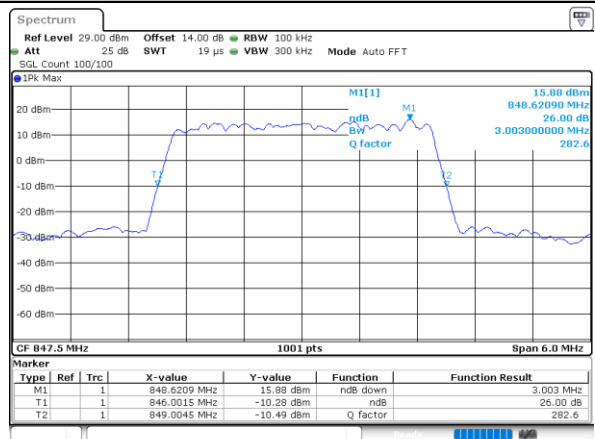

Date: 19,NOV,2020 17:50:41





LTE Band 5

Lowest Channel / 5MHz / 64QAM

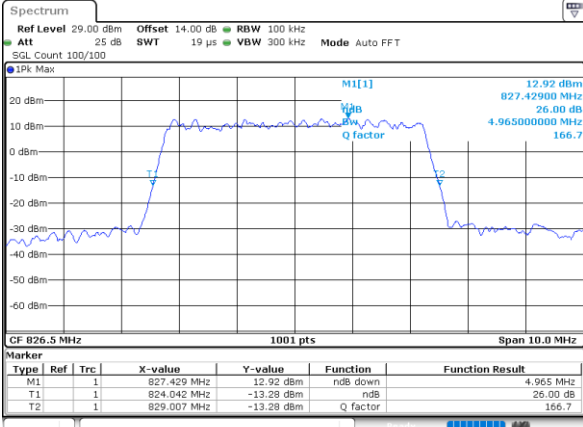

Date: 20,NOV,2020 09:32:30

Lowest Channel / 10MHz / 64QAM

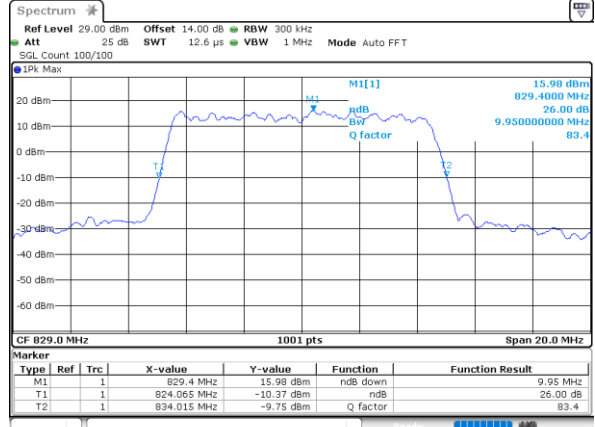

Date: 20,NOV,2020 08:58:07

Middle Channel / 5MHz / 64QAM

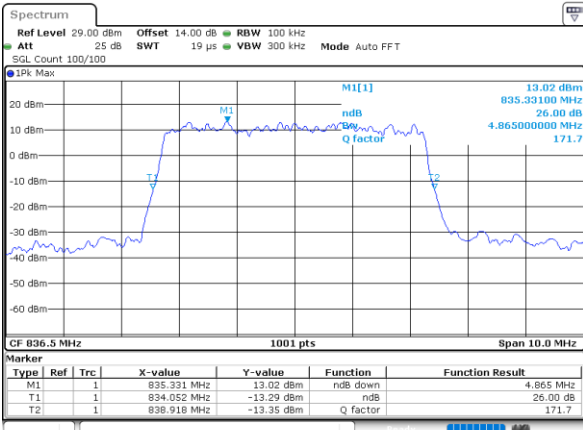

Date: 20,NOV,2020 09:48:15

Middle Channel / 10MHz / 64QAM

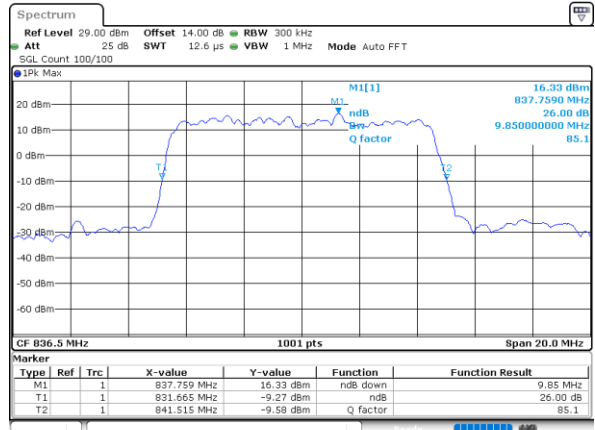

Date: 20,NOV,2020 09:11:54

Highest Channel / 5MHz / 64QAM

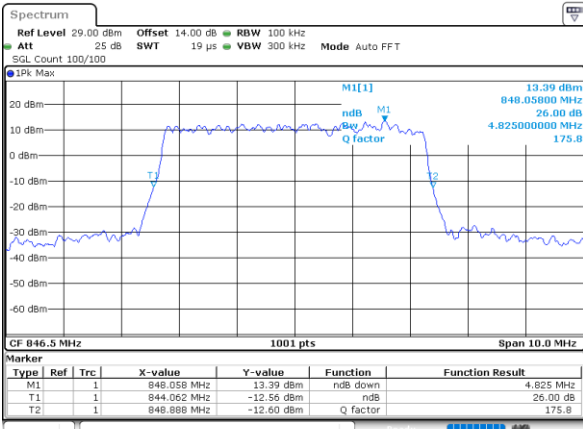

Date: 20,NOV,2020 09:51:29

Highest Channel / 10MHz / 64QAM

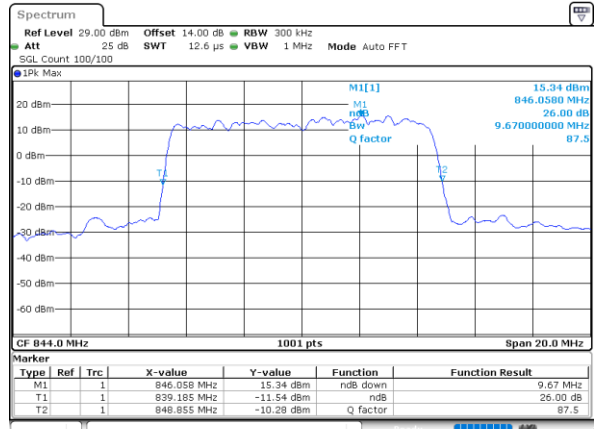

Date: 20,NOV,2020 09:11:41



**Occupied Bandwidth**

Mode	LTE Band 5 : 99%OBW(MHz)											
BW	1.4MHz		3MHz		5MHz		10MHz					
Mod.	QPSK	16QAM	QPSK	16QAM	QPSK	16QAM	QPSK	16QAM				
Lowest CH	1.08	1.10	2.73	2.73	4.49	4.48	8.99	8.99				
Middle CH	1.09	1.09	2.72	2.71	4.49	4.50	9.11	9.07				
Highest CH	1.09	1.09	2.73	2.70	4.48	4.46	9.09	9.03				
Mode	LTE Band 5 : 99%OBW(MHz)											
BW	1.4MHz		3MHz		5MHz		10MHz					
Mod.	64QAM		64QAM		64QAM		64QAM					
Lowest CH	1.09	-	2.74	-	4.49	-	9.03	-				
Middle CH	1.09	-	2.70	-	4.50	-	8.99	-				
Highest CH	1.09	-	2.73	-	4.49	-	9.01	-				



LTE Band 5

Lowest Channel / 1.4MHz / QPSK

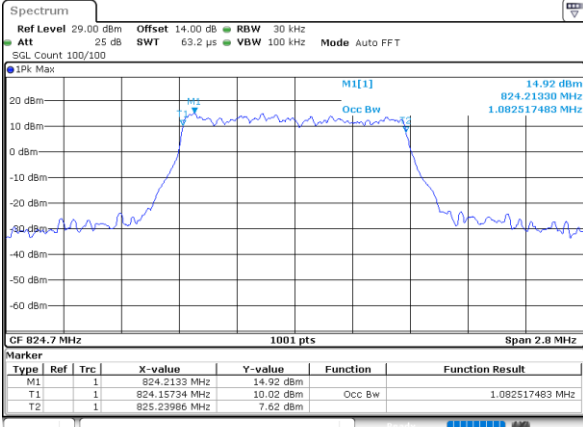

Date: 18\_NOV.2020 15:11:39

Lowest Channel / 1.4MHz / 16QAM

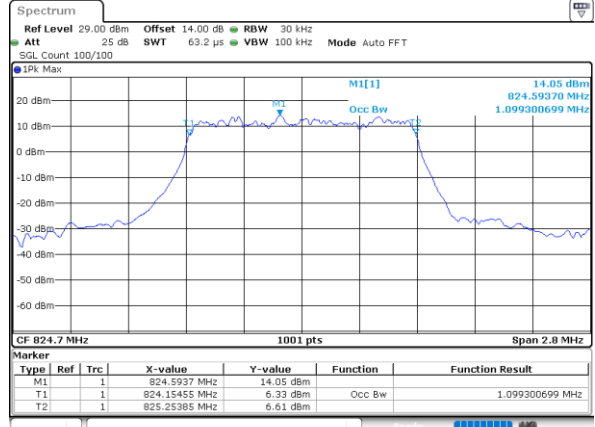

Date: 18\_NOV.2020 15:12:34

Middle Channel / 1.4MHz / QPSK

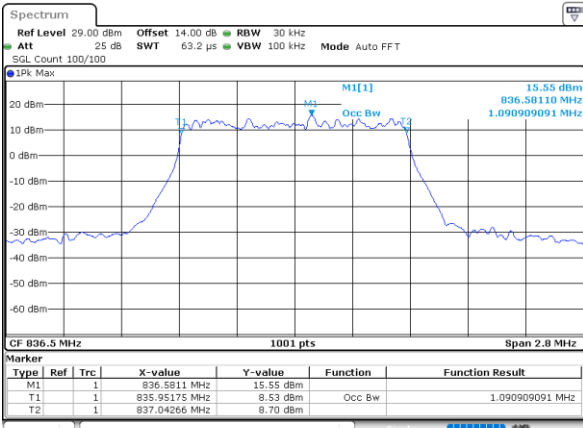

Date: 18\_NOV.2020 15:28:41

Middle Channel / 1.4MHz / 16QAM

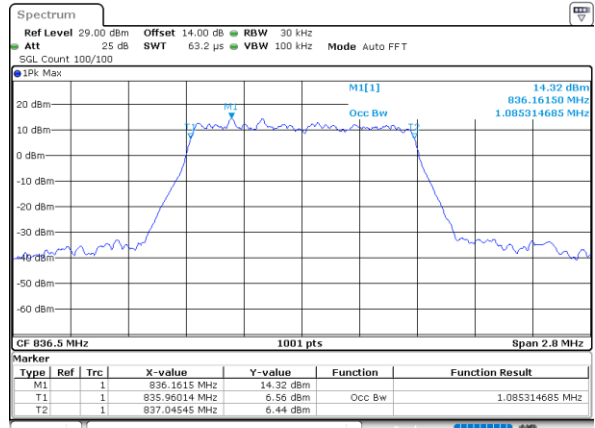

Date: 18\_NOV.2020 15:28:07

Highest Channel / 1.4MHz / QPSK

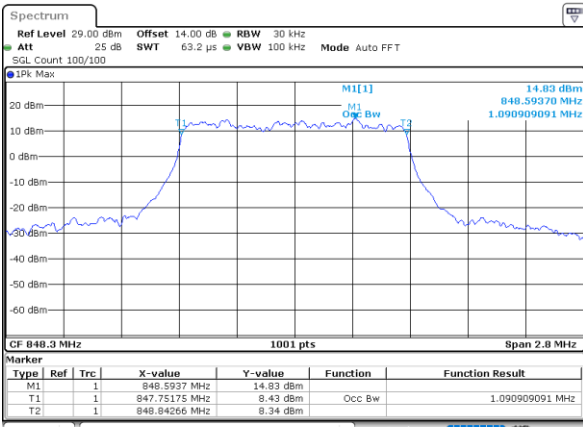

Date: 18\_NOV.2020 16:08:35

Highest Channel / 1.4MHz / 16QAM

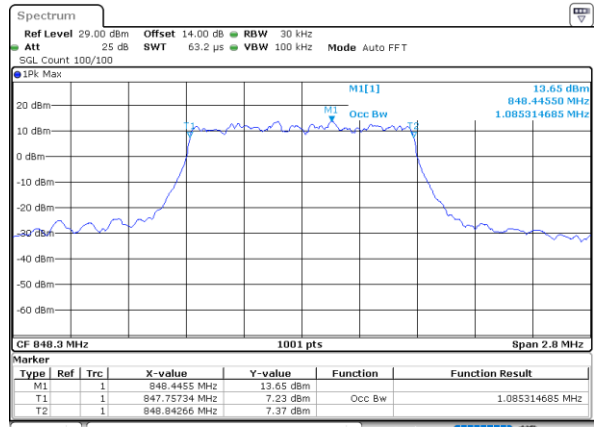

Date: 18\_NOV.2020 16:10:32



LTE Band 5

Lowest Channel / 3MHz / QPSK

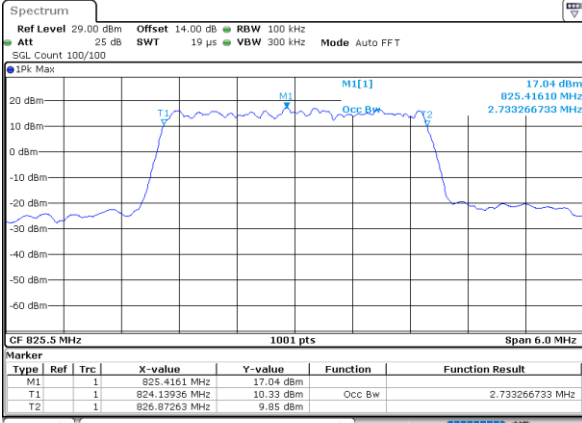

Date: 19\_NOV.2020 16:53:57

Lowest Channel / 3MHz / 16QAM

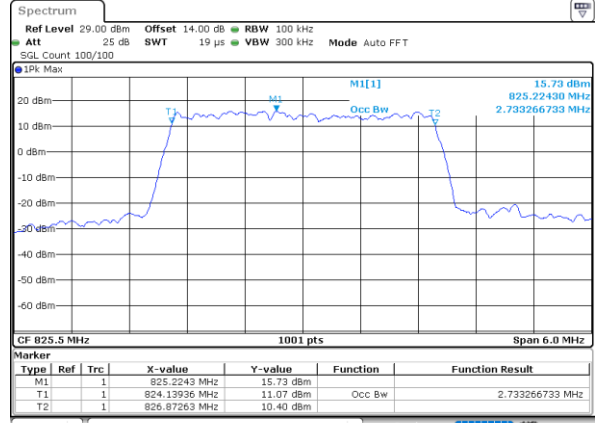

Date: 19\_NOV.2020 16:55:59

Middle Channel / 3MHz / QPSK

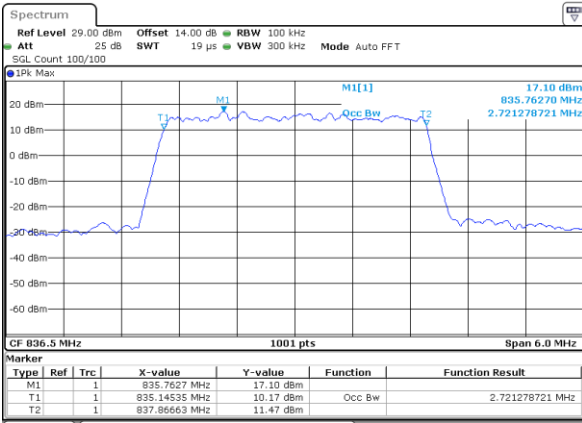

Date: 19\_NOV.2020 17:11:41

Middle Channel / 3MHz / 16QAM

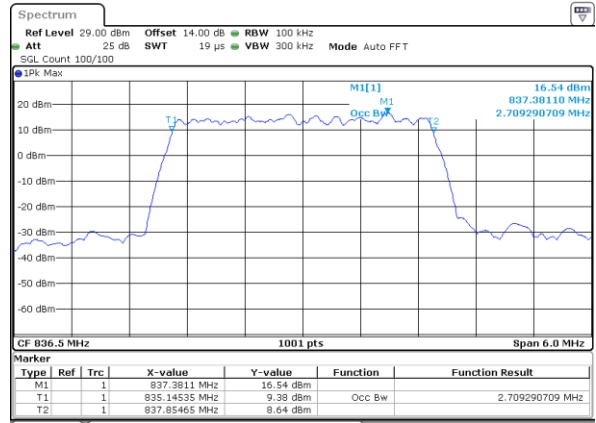

Date: 19\_NOV.2020 17:10:43

Highest Channel / 3MHz / QPSK

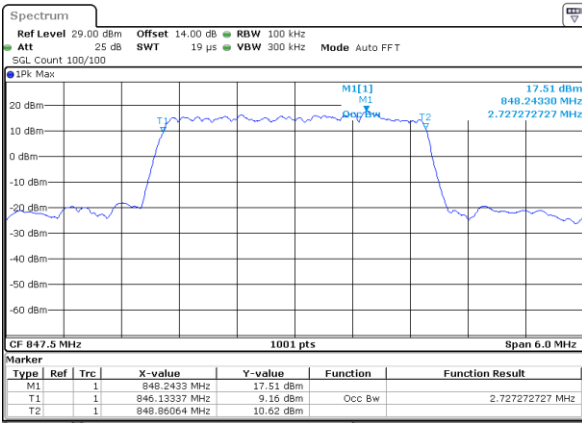

Date: 19\_NOV.2020 17:25:10

Highest Channel / 3MHz / 16QAM

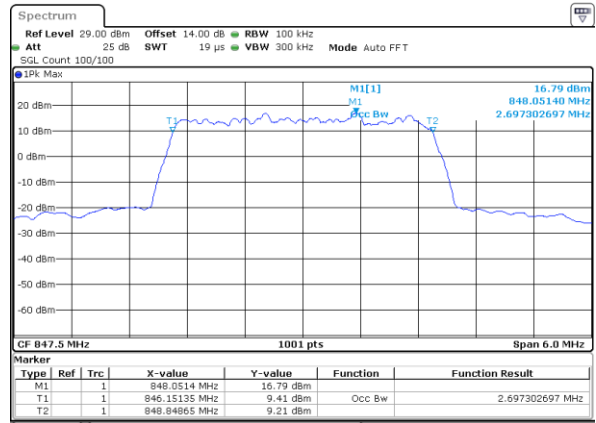

Date: 19\_NOV.2020 17:26:43



LTE Band 5

Lowest Channel / 5MHz / QPSK

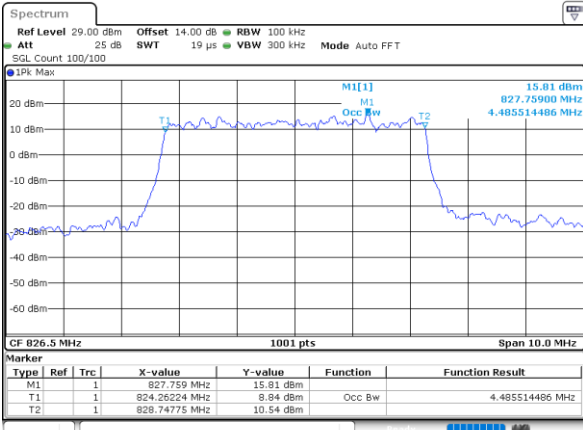

Date: 20,NOV,2020 09:30:07

Lowest Channel / 5MHz / 16QAM

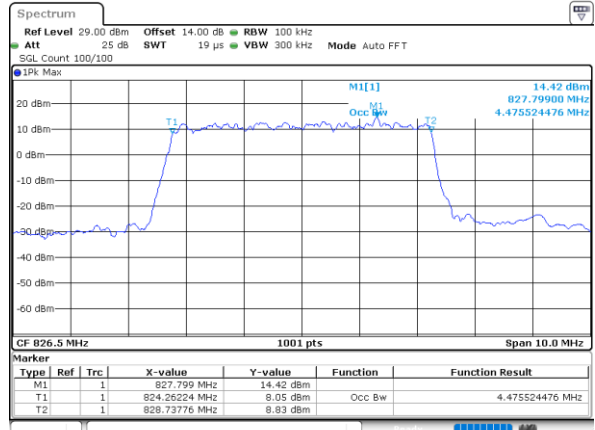

Date: 20,NOV,2020 09:31:17

Middle Channel / 5MHz / QPSK

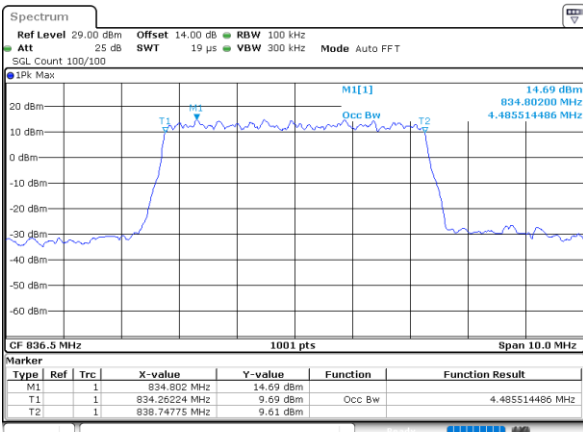

Date: 20,NOV,2020 09:48:46

Middle Channel / 5MHz / 16QAM

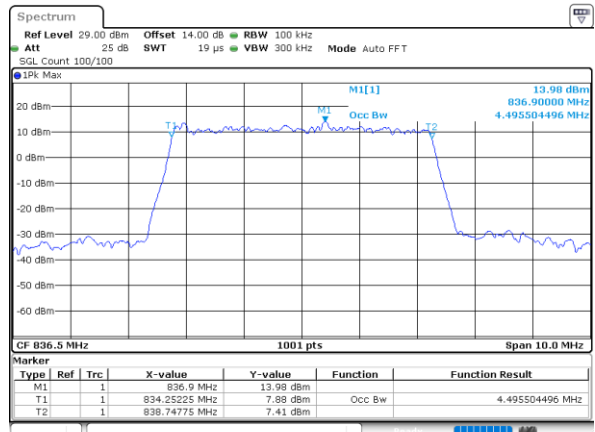

Date: 20,NOV,2020 09:48:28

Highest Channel / 5MHz / QPSK

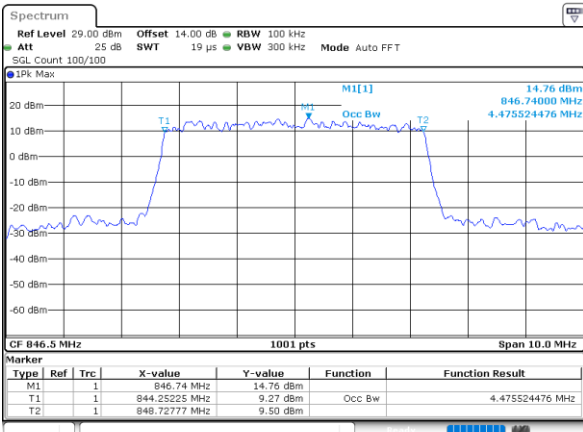

Date: 20,NOV,2020 09:49:23

Highest Channel / 5MHz / 16QAM

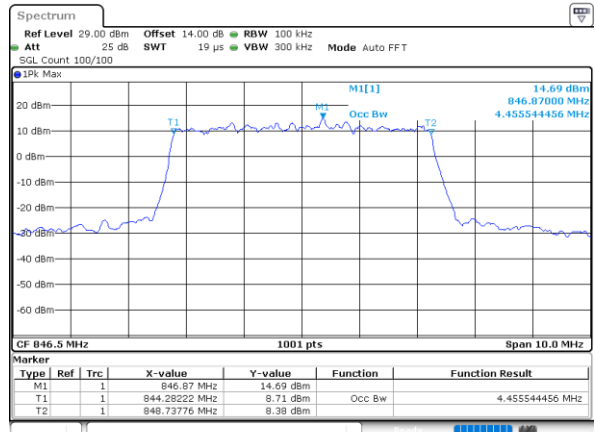

Date: 20,NOV,2020 09:50:23



LTE Band 5

Lowest Channel / 10MHz / QPSK

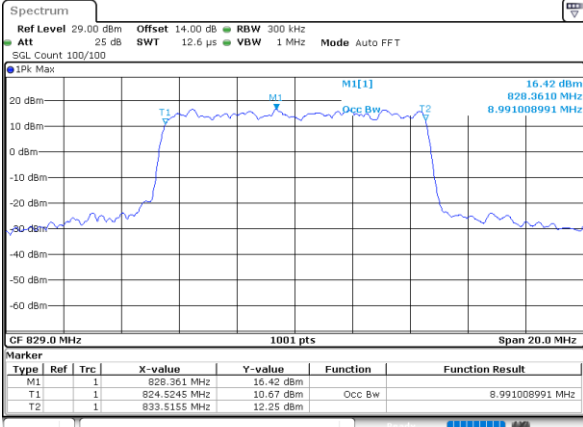

Date: 20\_Nov\_2020 09:55:25

Lowest Channel / 10MHz / 16QAM

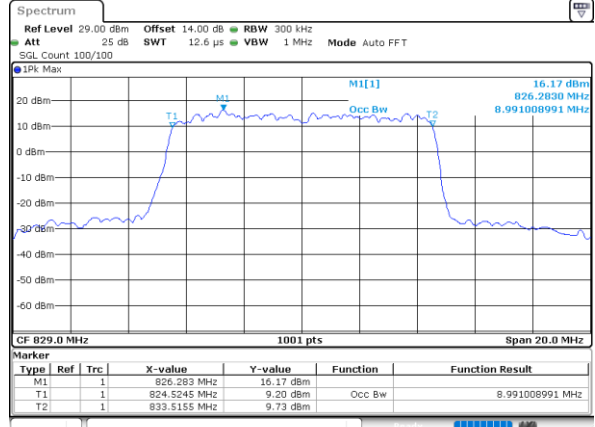

Date: 20\_Nov\_2020 08:15:46

Middle Channel / 10MHz / QPSK

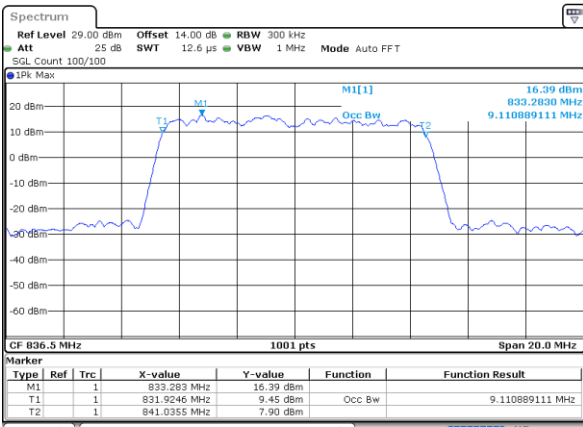

Date: 20\_Nov\_2020 09:12:26

Middle Channel / 10MHz / 16QAM

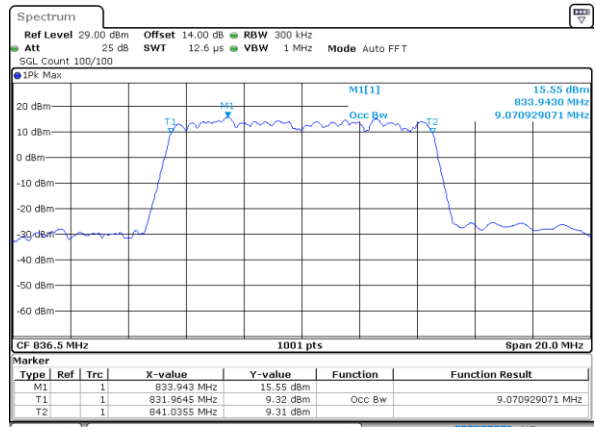

Date: 20\_Nov\_2020 09:12:06

Highest Channel / 10MHz / QPSK

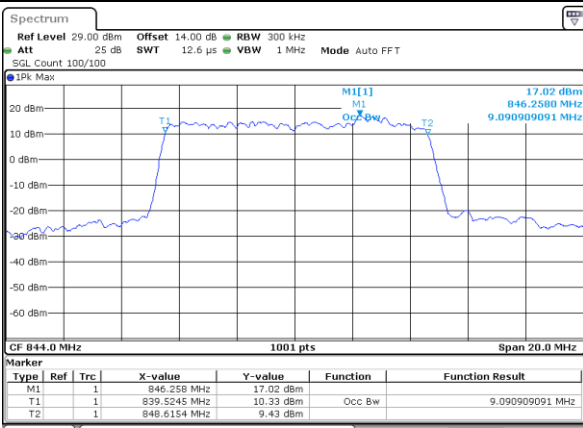

Date: 20\_Nov\_2020 09:13:13

Highest Channel / 10MHz / 16QAM

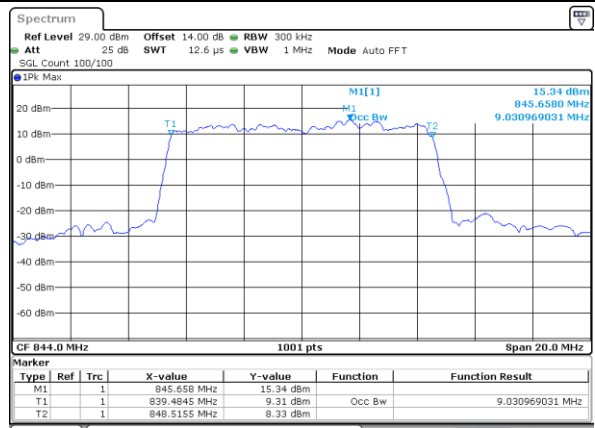

Date: 20\_Nov\_2020 09:14:05



LTE Band 5

Lowest Channel / 1.4MHz / 64QAM

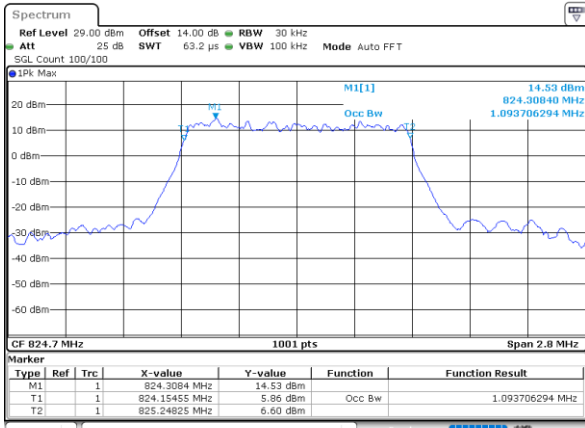

Date: 18.NOV.2020 15:17:28

Lowest Channel / 3MHz / 64QAM

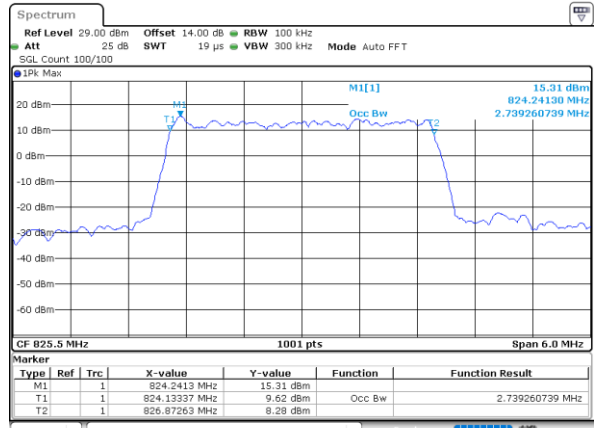

Date: 19.NOV.2020 16:57:42

Middle Channel / 1.4MHz / 64QAM

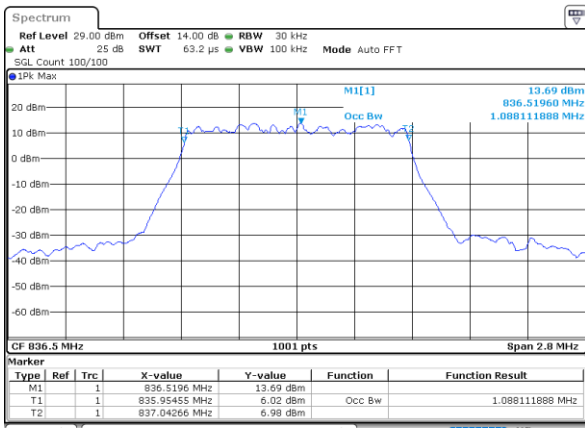

Date: 18.NOV.2020 15:27:20

Middle Channel / 3MHz / 64QAM

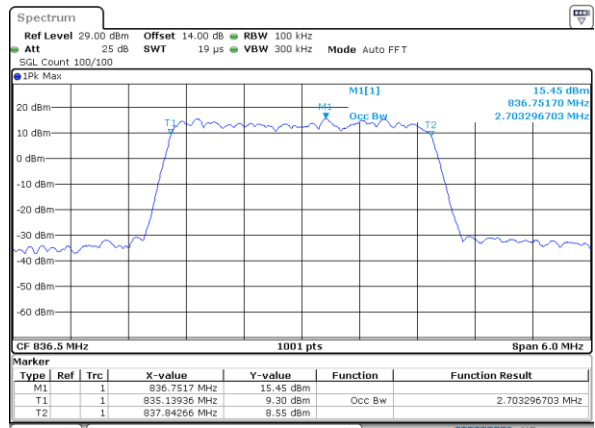

Date: 19.NOV.2020 17:11:16

Highest Channel / 1.4MHz / 64QAM

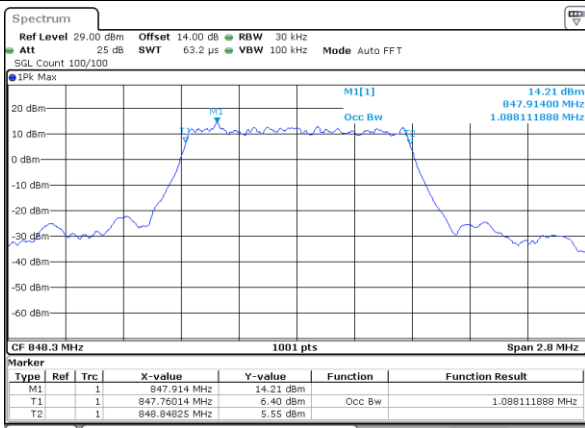

Date: 18.NOV.2020 16:13:02

Highest Channel / 3MHz / 64QAM

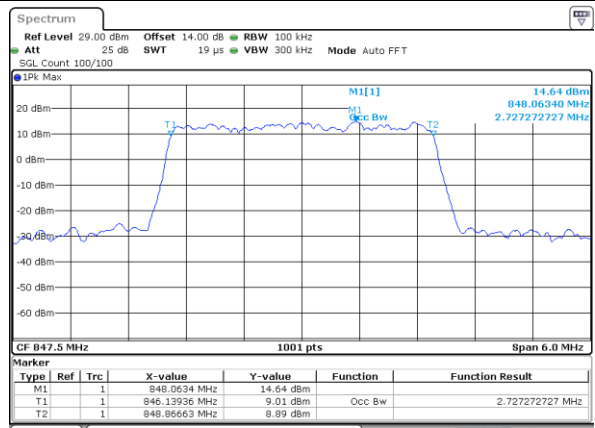

Date: 19.NOV.2020 17:30:33



LTE Band 5

Lowest Channel / 5MHz / 64QAM

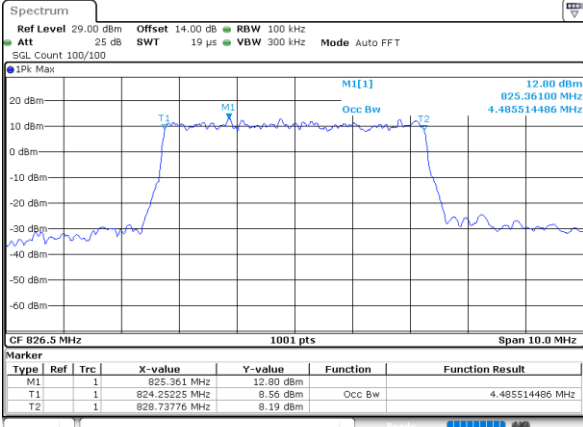

Date: 20,NOV,2020 09:32:14

Lowest Channel / 10MHz / 64QAM

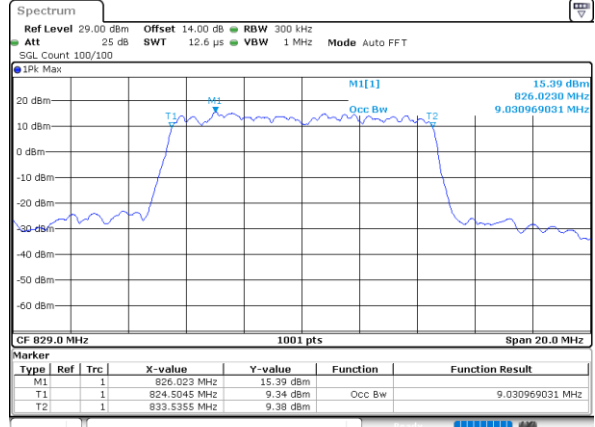

Date: 20,NOV,2020 08:57:58

Middle Channel / 5MHz / 64QAM

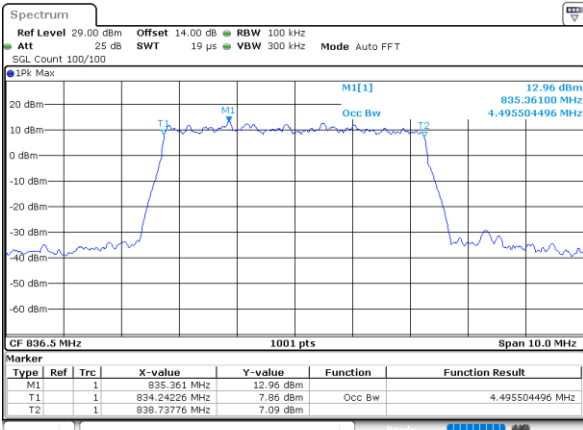

Date: 20,NOV,2020 09:48:08

Middle Channel / 10MHz / 64QAM

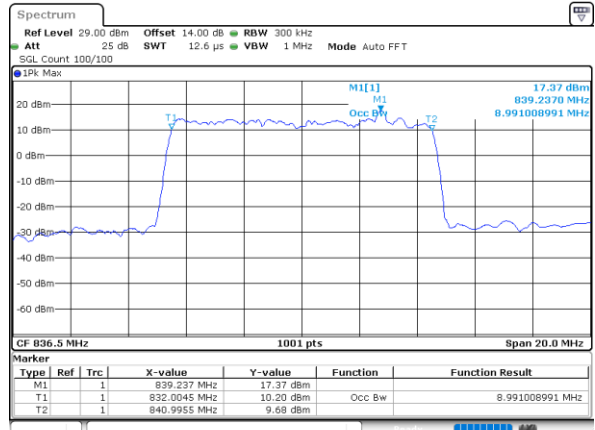

Date: 20,NOV,2020 09:11:46

Highest Channel / 5MHz / 64QAM

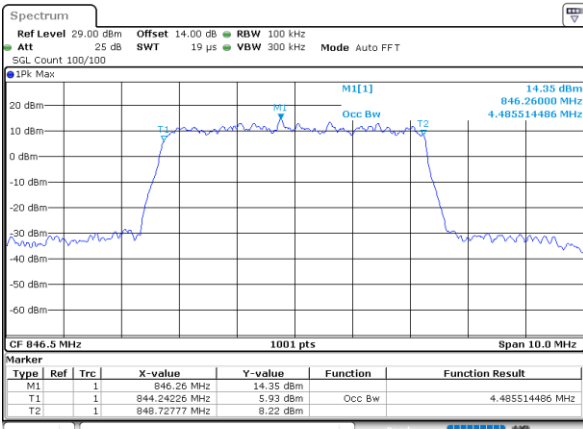

Date: 20,NOV,2020 09:51:22

Highest Channel / 10MHz / 64QAM

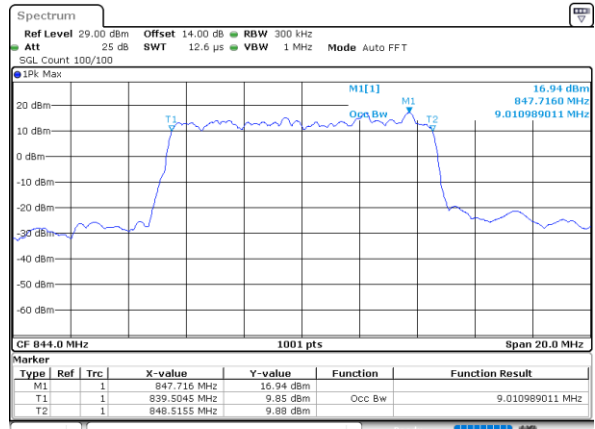

Date: 20,NOV,2020 09:15:32





# Conducted Band Edge

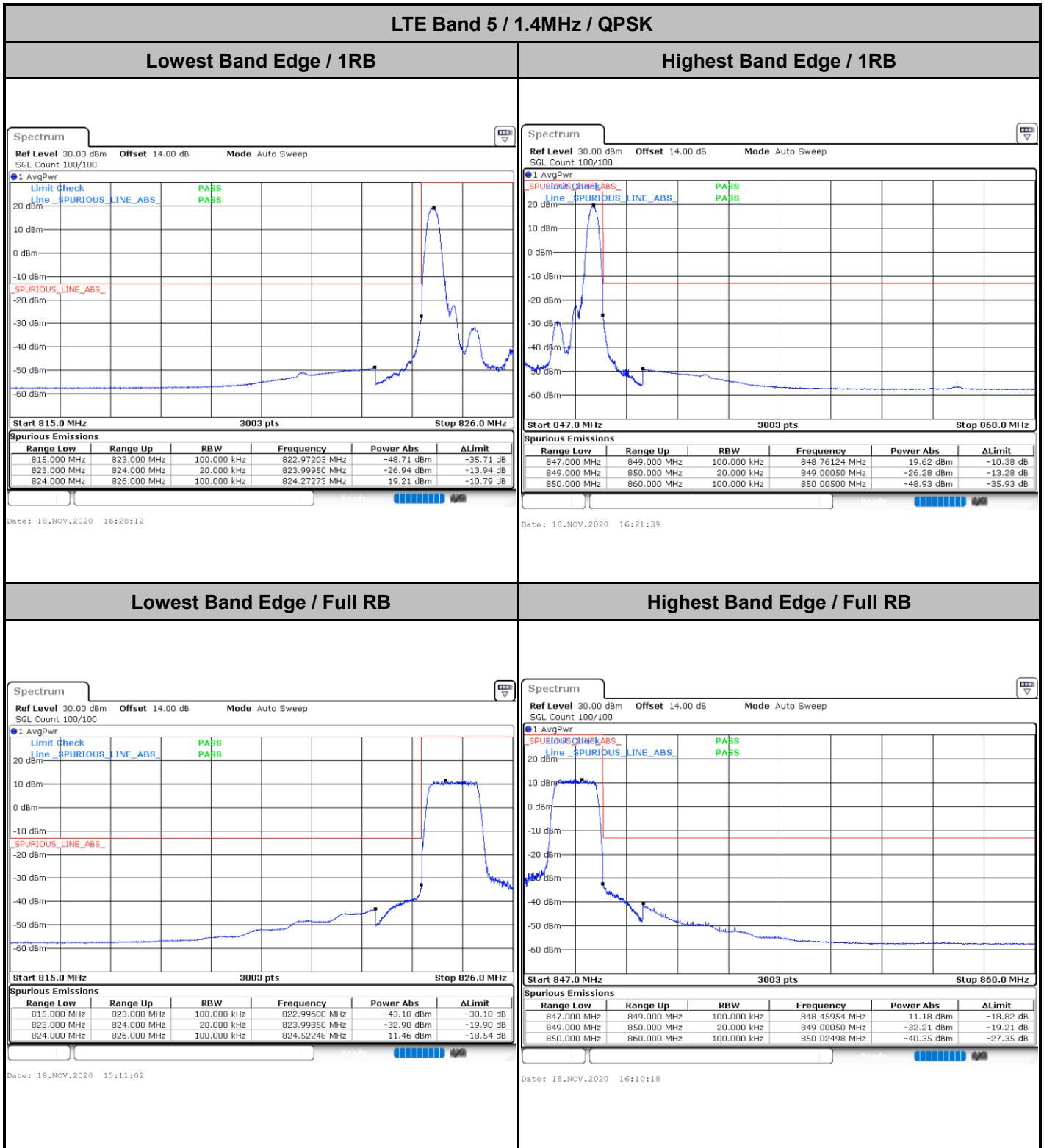



LTE Band 5 / 1.4MHz / 16QAM

Lowest Band Edge / 1 RB

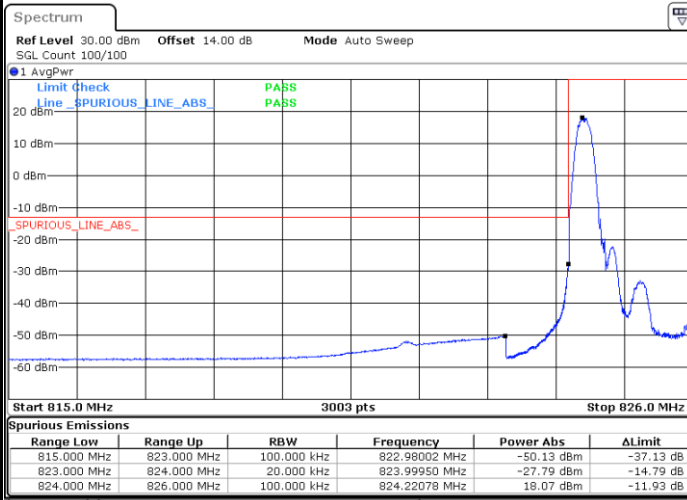

Date: 18.NOV.2020 16:30:40

Highest Band Edge / 1 RB

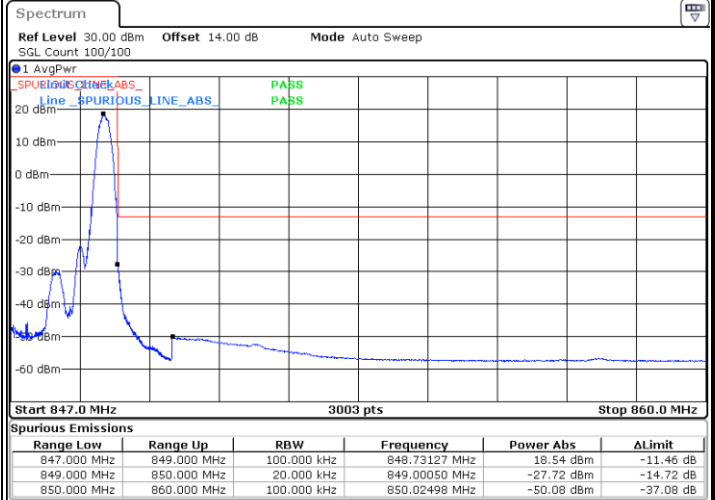

Date: 18.NOV.2020 16:24:36

Lowest Band Edge / Full RB

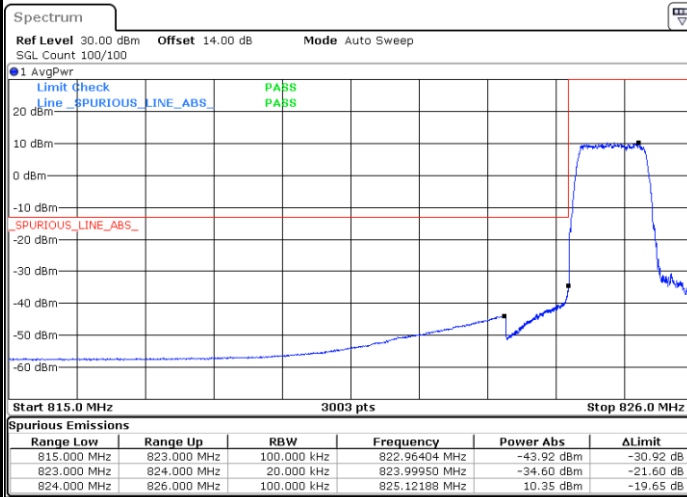

Date: 18.NOV.2020 15:15:25

Highest Band Edge / Full RB



Date: 18.NOV.2020 16:12:34



LTE Band 5 / 1.4MHz / 64QAM

Lowest Band Edge / 1 RB

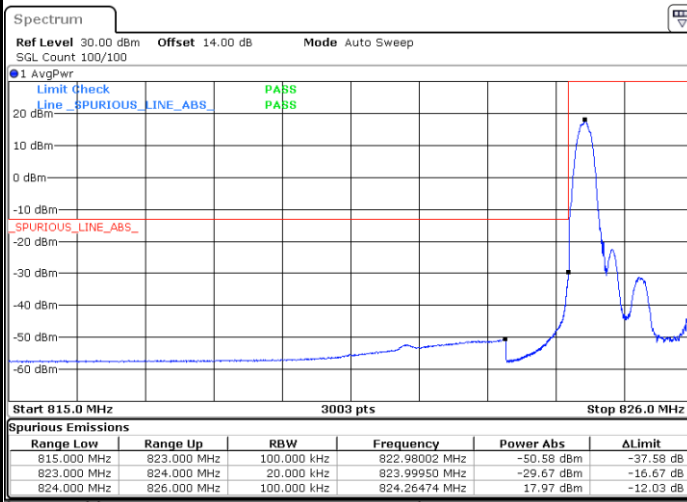

Date: 18.NOV.2020 16:32:38

Highest Band Edge / 1 RB

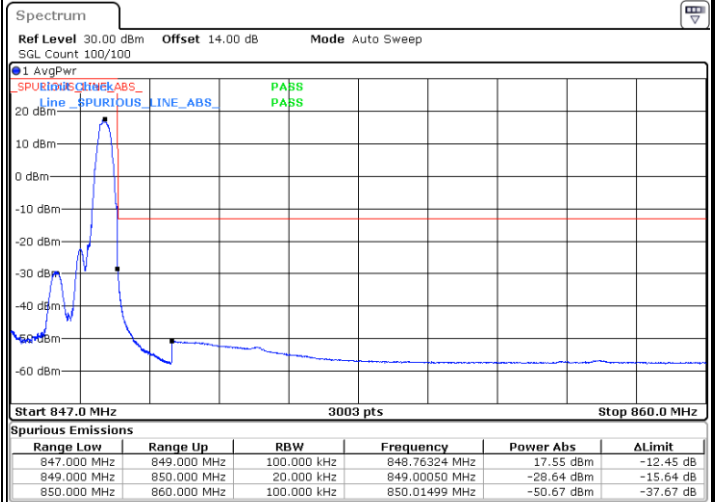

Date: 18.NOV.2020 16:26:25

Lowest Band Edge / Full RB

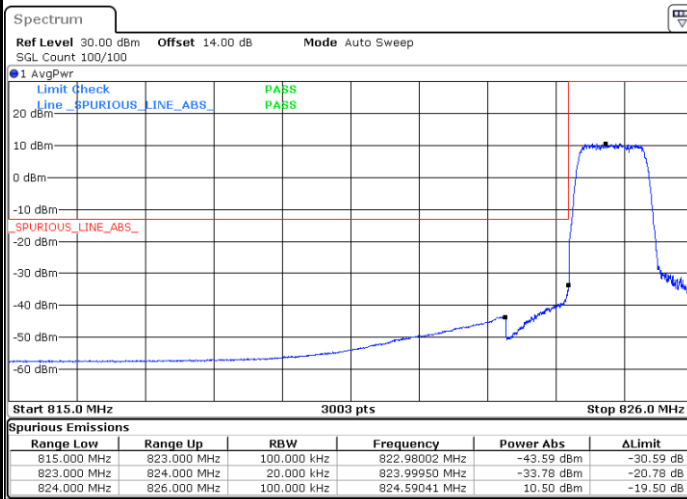

Date: 18.NOV.2020 15:19:25

Highest Band Edge / Full RB

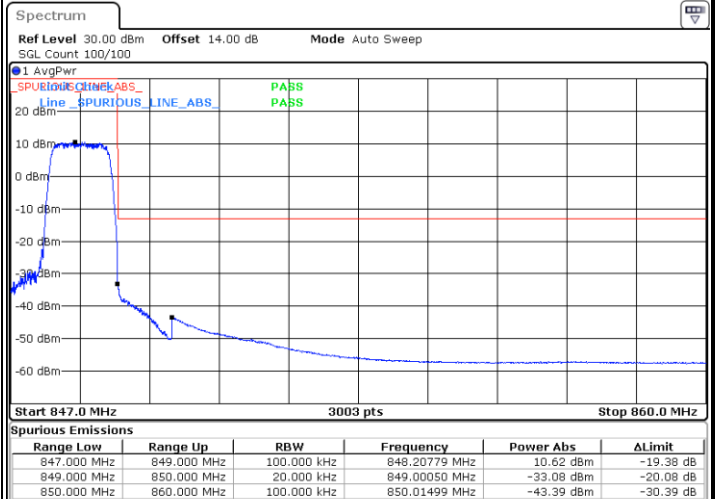

Date: 18.NOV.2020 16:14:58



LTE Band 5 / 3MHz / QPSK

Lowest Band Edge / 1RB

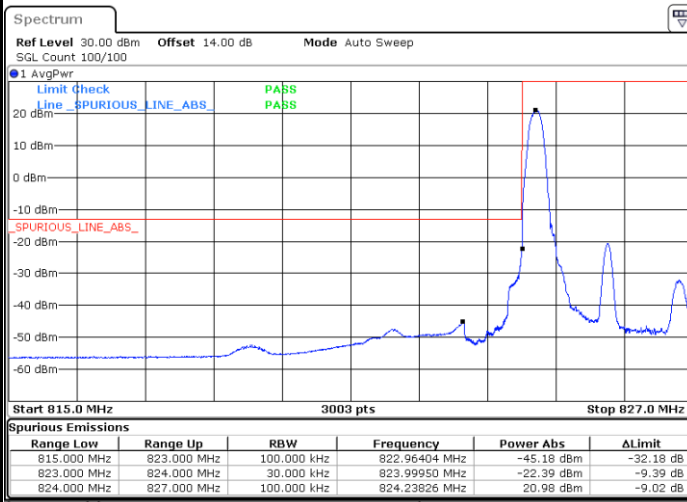

Date: 19.NOV.2020 17:05:18

Highest Band Edge / 1 RB

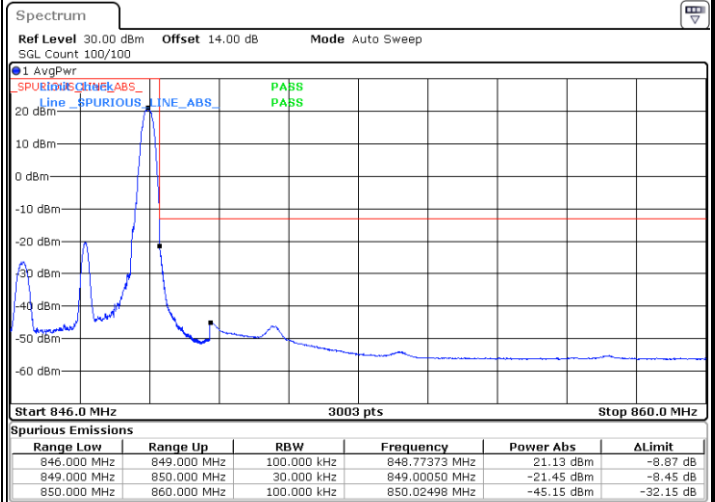

Date: 19.NOV.2020 17:40:12

Lowest Band Edge / Full RB

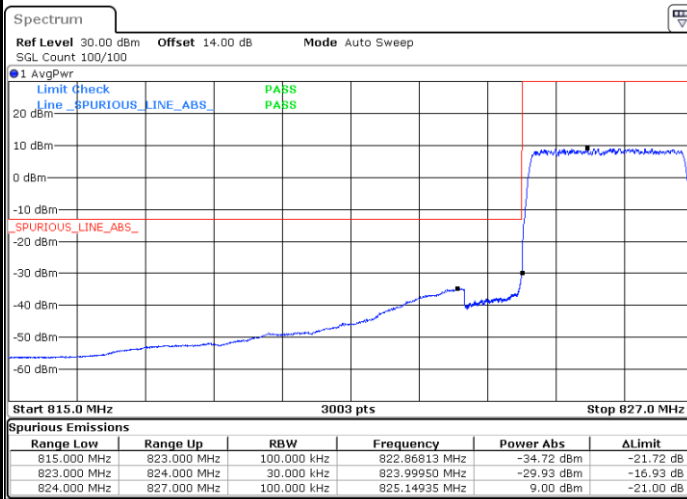

Date: 19.NOV.2020 16:55:26

Highest Band Edge / Full RB

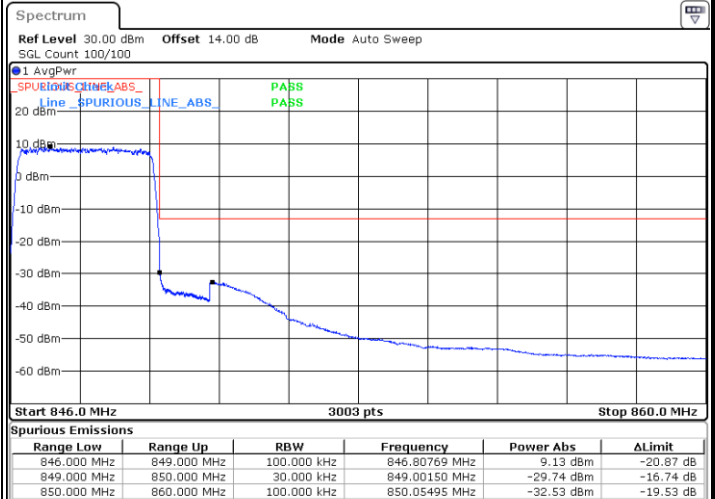

Date: 19.NOV.2020 17:26:20