

FCC SAR Test Report

APPLICANT : Motorola Mobility LLC
EQUIPMENT : Mobile Cellular Phone
BRAND NAME : Motorola
MODEL NAME : XT2127-1
FCC ID : IHDT56ZM4
STANDARD : FCC 47 CFR Part 2 (2.1093)

The product was received on Oct. 20, 2020 and testing was started from Nov. 11, 2020 and completed on Dec. 02, 2020. We, Sporton International (ShenZhen) Inc, would like to declare that the tested sample has been evaluated in accordance with the procedures and had been in compliance with the applicable technical standards.

The test results in this report apply exclusively to the tested model / sample. Without written approval of Sporton International (ShenZhen) Inc., the test report shall not be reproduced except in full.

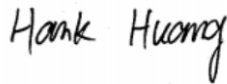

Reviewed by: Hank Huang / Supervisor



Approved by: Johnny Chen / Manager



Sporton International (ShenZhen) Inc.
1/F, 2/F, Bldg 5, Shiling Industrial Zone, Xinwei Village, Xili, Nanshan, Shenzhen, 518055
People's Republic of China



Table of Contents

1. Statement of Compliance 4
2. Administration Data 5
3. Guidance Applied 5
4. Equipment Under Test (EUT) Information 6
4.1 General Information 6
4.2 General LTE SAR Test and Reporting Considerations 7
5. Proximity Sensor Triggering Test 9
5.1 Proximity sensor triggering distances(Per KDB616217§6.2) 9
6. RF Exposure Limits 15
6.1 Uncontrolled Environment 15
6.2 Controlled Environment 15
7. Specific Absorption Rate (SAR) 16
7.1 Introduction 16
7.2 SAR Definition 16
8. System Description and Setup 17
8.1 E-Field Probe 18
8.2 Data Acquisition Electronics (DAE) 18
8.3 Phantom 19
8.4 Device Holder 20
9. Measurement Procedures 21
9.1 Spatial Peak SAR Evaluation 21
9.2 Power Reference Measurement 22
9.3 Area Scan 22
9.4 Zoom Scan 23
9.5 Volume Scan Procedures 23
9.6 Power Drift Monitoring 23
10. Test Equipment List 24
11. System Verification 25
11.1 Tissue Simulating Liquids 25
11.2 Tissue Verification 26
11.3 System Performance Check Results 27
12. RF Exposure Positions 29
12.1 Ear and handset reference point 29
12.2 Definition of the cheek position 30
12.3 Definition of the tilt position 31
12.4 Body Worn Accessory 32
12.5 Product Specific 10g SAR Exposure 33
12.6 Wireless Router 33
13. Conducted RF Output Power (Unit: dBm) 34
14. Antenna Location 42
15. SAR Test Results 43
15.1 Head SAR 46
15.2 Hotspot SAR 49
15.3 Body Worn Accessory SAR 53
15.4 Product specific 10g SAR 57
15.5 Repeated SAR Measurement 60
16. Simultaneous Transmission Analysis 61
16.1 Head Exposure Conditions 62
16.2 Hotspot Exposure Conditions 63
16.3 Body-Worn Accessory Exposure Conditions 64
16.4 Product specific 10g SAR Exposure Conditions 65
16.5 SPLSR Evaluation and Analysis 66
17. Uncertainty Assessment 72
18. References 73
Appendix A. Plots of System Performance Check
Appendix B. Plots of High SAR Measurement
Appendix C. DASY Calibration Certificate
Appendix D. Test Setup Photos
Appendix E. Conducted RF Output Power Table



1. Statement of Compliance

The maximum results of Specific Absorption Rate (SAR) found during testing for **Motorola Mobility LLC, Mobile Cellular Phone, XT2127-1**, are as follows.

| Highest 1g SAR Summary | | | | | | |
|------------------------|----------------|------------------|-----------------------|--------------------------|----------------------------|---|
| Equipment Class | Frequency Band | | Head (Separation 0mm) | Hotspot (Separation 5mm) | Body-worn (Separation 5mm) | Highest Simultaneous Transmission 1g SAR (W/kg) |
| | | | 1g SAR (W/kg) | | | |
| Licensed | GSM | GSM850 | 0.50 | 1.26 | 1.26 | 1.59 |
| | | GSM1900 | 0.29 | 1.30 | 1.22 | |
| | WCDMA | Band V | 0.45 | 1.18 | 1.18 | |
| | | Band IV | 0.32 | 1.37 | 1.36 | |
| | | Band II | 0.27 | 1.21 | 1.21 | |
| | LTE | Band 5 | 0.44 | 1.36 | 1.36 | |
| | | Band 66/Band 4 | 0.29 | 1.44 | 1.44 | |
| Band 2 | | 0.27 | 1.44 | 1.44 | | |
| Band 7 | | 0.26 | 1.44 | 1.21 | | |
| DTS | WLAN | 2.4GHz WLAN | 0.58 | 0.38 | 0.38 | 1.59 |
| NII | | 5GHz WLAN | 1.11 | 0.89 | 1.00 | 1.59 |
| DSS | Bluetooth | 2.4GHz Bluetooth | 0.14 | <0.10 | <0.10 | 1.53 |

| Highest 10g SAR Summary | | | | |
|-------------------------|----------------|----------------|--|--|
| Equipment Class | Frequency Band | | Product Specific 10g SAR (W/kg) (Separation 0mm) | Highest Simultaneous Transmission 10g SAR (W/kg) |
| Licensed | GSM | GSM850 | 1.80 | 3.86 |
| | | GSM1900 | 3.59 | |
| | WCDMA | Band V | 3.31 | |
| | | Band IV | 3.50 | |
| | | Band II | 3.17 | |
| | LTE | Band 5 | 2.41 | |
| | | Band 66/Band 4 | 3.57 | |
| | | Band 2 | 3.07 | |
| Band 7 | | 3.41 | | |
| NII | WLAN | 5GHz WLAN | 2.72 | 3.86 |

Date of Testing: 2020/11/11~2020/12/2

Remark: This device supports LTE B4 and B66. Since the supported frequency span for LTE B4 falls completely within the supports frequency span for LTE B66, both LTE bands have the same target power, and both LTE bands share the same transmission path; therefore, SAR was only assessed for LTE B66.

Declaration of Conformity:

The test results with all measurement uncertainty excluded are presented in accordance with the regulation limits or requirements declared by manufacturers.

Comments and Explanations:

The declared of product specification for EUT presented in the report are provided by the manufacturer, and the manufacturer takes all the responsibilities for the accuracy of product specification.

This device is in compliance with Specific Absorption Rate (SAR) for general population/uncontrolled exposure limits (1.6 W/kg for Partial-Body 1g SAR, 4.0 W/kg for Product Specific 10g SAR) specified in FCC 47 CFR part 2 (2.1093) and ANSI/IEEE C95.1-1992, and had been tested in accordance with the measurement methods and procedures specified in IEEE 1528-2013 and FCC KDB publications.



2. Administration Data

Sporton International (Shenzhen) Inc. is accredited to ISO/IEC 17025:2017 by American Association for Laboratory Accreditation with Certificate Number 5145.01.

| Testing Laboratory | | |
|--------------------|--|--------------------------------|
| Test Firm | Sporton International (Shenzhen) Inc. | |
| Test Site Location | 1/F, 2/F, Bldg 5, Shiling Industrial Zone, Xinwei Village, Xili, Nanshan, Shenzhen, 518055 People's Republic of China TEL: +86-755-86379589 FAX: +86-755-86379595 | |
| Test Site No. | FCC Designation No. | FCC Test Firm Registration No. |
| | CN1256 | 421272 |

| Applicant | |
|--------------|---|
| Company Name | Motorola Mobility LLC |
| Address | 222 W, Merchandise Mart Plaza, Chicago IL 60654 USA |

| Manufacturer | |
|--------------|---|
| Company Name | Motorola Mobility LLC |
| Address | 222 W, Merchandise Mart Plaza, Chicago IL 60654 USA |

3. Guidance Applied

The Specific Absorption Rate (SAR) testing specification, method, and procedure for this device is in accordance with the following standards:

- FCC 47 CFR Part 2 (2.1093)
- ANSI/IEEE C95.1-1992
- IEEE 1528-2013
- FCC KDB 865664 D01 SAR Measurement 100 MHz to 6 GHz v01r04
- FCC KDB 865664 D02 SAR Reporting v01r02
- FCC KDB 447498 D01 General RF Exposure Guidance v06
- FCC KDB 648474 D04 SAR Evaluation Considerations for Wireless Handsets v01r03
- FCC KDB 248227 D01 802.11 Wi-Fi SAR v02r02
- FCC KDB 616217 D04 SAR for laptop and tablets v01r02
- FCC KDB 941225 D01 3G SAR Procedures v03r01
- FCC KDB 941225 D05 SAR for LTE Devices v02r05
- FCC KDB 941225 D06 Hotspot Mode SAR v02r01



4. Equipment Under Test (EUT) Information

4.1 General Information

| Product Feature & Specification | |
|---|--|
| Equipment Name | Mobile Cellular Phone |
| Brand Name | Motorola |
| Model Name | XT2127-1 |
| FCC ID | IHDT56ZM4 |
| IMEI Code | IMEI 1: 356465220019298 IMEI 2: 356465220019306 |
| Wireless Technology and Frequency Range | GSM850: 824.2 MHz ~ 848.8 MHz GSM1900: 1850.2 MHz ~ 1909.8 MHz WCDMA Band II: 1852.4 MHz ~ 1907.6 MHz WCDMA Band IV: 1712.4 MHz ~ 1752.6 MHz WCDMA Band V: 826.4 MHz ~ 846.6 MHz LTE Band 2: 1850.7 MHz ~ 1909.3 MHz LTE Band 4: 1710.7 MHz ~ 1754.3 MHz LTE Band 5: 824.7 MHz ~ 848.3 MHz LTE Band 7: 2502.5 MHz ~ 2567.5 MHz LTE Band 66: 1710.7 MHz ~ 1779.3 MHz WLAN 2.4GHz Band: 2412 MHz ~ 2462 MHz WLAN 5.2GHz Band: 5180 MHz ~ 5240 MHz WLAN 5.3GHz Band: 5260 MHz ~ 5320 MHz WLAN 5.5GHz Band: 5500 MHz ~ 5720 MHz WLAN 5.8GHz Band: 5745 MHz ~ 5825 MHz Bluetooth: 2402 MHz ~ 2480 MHz |
| Mode | GSM/GPRS/EGPRS RMC/AMR 12.2Kbps HSDPA HSUPA DC-HSDPA HSPA+(16QAM uplink is not supported) LTE: QPSK, 16QAM, 64QAM WLAN 2.4GHz 802.11b/g/n HT20 WLAN 5GHz 802.11a/n HT20/HT40 WLAN 5GHz 802.11ac VHT20/VHT40/VHT80 Bluetooth BR/EDR/LE |
| HW Version | DVT2 |
| SW Version | RRB31.30 |
| GSM / (E)GPRS Transfer mode | Class B – EUT cannot support Packet Switched and Circuit Switched Network simultaneously but can automatically switch between Packet and Circuit Switched Network. |
| EUT Stage | Production Unit |
| Remark: | <ol style="list-style-type: none"> 802.11n-HT40 is not supported in 2.4GHz WLAN. This device supports VoIP in GPRS, EGPRS, WCDMA and LTE (e.g. for 3rd-party VoIP), LTE supports VoLTE operation. This device 2.4GHz WLAN support hotspot operation and Bluetooth support tethering applications. This device 2.4GHz WLAN/5.2GHz WLAN/5.8GHz WLAN support hotspot operation, and 5.2GHz WLAN/5.8GHz WLAN supports WiFi Direct (GC/GO), and 5.3GHz / 5.5GHz supports WiFi Direct (GC only). This device does not support DTM operation and supports GRPS/EGRPS mode up to multi-slot class 12. The device implements Proximity sensors/receiver detect mechanism/hotspot trigger reduced power for the power management for SAR compliance at different exposure conditions (head, body-worn, hotspot, extremity). The device will invoke corresponding work scenarios power level, which are provided in the operational description. For Some WWAN bands, sensor on reduced power level higher than hotspot reduced power level, so front/back sensor on SAR can represent hotspot conservatively. There are two different types of EUT. They are single SIM card mobile and dual SIM card mobile. The others are the same including circuit design, PCB board, structure and all components. It is special to declare. After pre-scan two types of EUT, we found test result of the sample that dual SIM was the worst, so we chose dual SIM card mobile to perform all tests. For dual SIM card mobile has two SIM slots and supports dual SIM dual standby. The WWAN radio transmission will |



be enabled by either one SIM at a time (single active). After pre-scan two SIM cards power, we found test result of the SIM1 was the worse, so we chose SIM1 slot to perform all tests.
 11. The device has five headsets, only supplier is different, so we chose headset 1 to perform full SAR testing, and headset 2/3/4/5 only verified the worst case of headset 1.

4.2 General LTE SAR Test and Reporting Considerations

| Summarized necessary items addressed in KDB 941225 D05 v02r05 | | | | | | | | | | | | | | | | | | | | | | | | | | | | | | | | | | | | | | | | | | | | | | | | | | | | | | | | | | | | | | | |
|---|---|------------|---|--------|--------|--------|----------|--|----------|---------|---------|-------|--------|--------|--------|------|-----|-----|-----|------|------|------|-----|--------|-----|-----|-----|------|------|------|-----|--------|-----|-----|-----|------|------|------|-----|--------|-----|-----|-----|------|------|------|-----|--------|-----|-----|-----|------|------|------|-----|---------|-----|--|--|--|--|--|-----|
| FCC ID | IHDT56ZM4 | | | | | | | | | | | | | | | | | | | | | | | | | | | | | | | | | | | | | | | | | | | | | | | | | | | | | | | | | | | | | | |
| Equipment Name | Mobile Cellular Phone | | | | | | | | | | | | | | | | | | | | | | | | | | | | | | | | | | | | | | | | | | | | | | | | | | | | | | | | | | | | | | |
| Operating Frequency Range of each LTE transmission band | LTE Band 2: 1850.7 MHz ~ 1909.3 MHz LTE Band 4: 1710.7 MHz ~ 1754.3 MHz LTE Band 5: 824.7 MHz ~ 848.3 MHz LTE Band 7: 2502.5 MHz ~ 2567.5 MHz LTE Band 66: 1710.7 MHz ~ 1779.3 MHz | | | | | | | | | | | | | | | | | | | | | | | | | | | | | | | | | | | | | | | | | | | | | | | | | | | | | | | | | | | | | | |
| Channel Bandwidth | LTE Band 2: 1.4MHz, 3MHz, 5MHz, 10MHz, 15MHz, 20MHz LTE Band 4: 1.4MHz, 3MHz, 5MHz, 10MHz, 15MHz, 20MHz LTE Band 5: 1.4MHz, 3MHz, 5MHz, 10MHz LTE Band 7: 5MHz, 10MHz, 15MHz, 20MHz LTE Band 66: 1.4MHz, 3MHz, 5MHz, 10MHz, 15MHz, 20MHz | | | | | | | | | | | | | | | | | | | | | | | | | | | | | | | | | | | | | | | | | | | | | | | | | | | | | | | | | | | | | | |
| uplink modulations used | QPSK / 16QAM / 64QAM | | | | | | | | | | | | | | | | | | | | | | | | | | | | | | | | | | | | | | | | | | | | | | | | | | | | | | | | | | | | | | |
| LTE Voice / Data requirements | Voice and Data | | | | | | | | | | | | | | | | | | | | | | | | | | | | | | | | | | | | | | | | | | | | | | | | | | | | | | | | | | | | | | |
| LTE Release Version | R12, Cat5 | | | | | | | | | | | | | | | | | | | | | | | | | | | | | | | | | | | | | | | | | | | | | | | | | | | | | | | | | | | | | | |
| CA Support | Not supported | | | | | | | | | | | | | | | | | | | | | | | | | | | | | | | | | | | | | | | | | | | | | | | | | | | | | | | | | | | | | | |
| LTE MPR permanently built-in by design | <p align="center">Table 6.2.3-1: Maximum Power Reduction (MPR) for Power Class 1, 2 and 3</p> <table border="1"> <thead> <tr> <th rowspan="2">Modulation</th> <th colspan="6">Channel bandwidth / Transmission bandwidth (N_{RB})</th> <th rowspan="2">MPR (dB)</th> </tr> <tr> <th>1.4 MHz</th> <th>3.0 MHz</th> <th>5 MHz</th> <th>10 MHz</th> <th>15 MHz</th> <th>20 MHz</th> </tr> </thead> <tbody> <tr> <td>QPSK</td> <td>> 5</td> <td>> 4</td> <td>> 8</td> <td>> 12</td> <td>> 16</td> <td>> 18</td> <td>≤ 1</td> </tr> <tr> <td>16 QAM</td> <td>≤ 5</td> <td>≤ 4</td> <td>≤ 8</td> <td>≤ 12</td> <td>≤ 16</td> <td>≤ 18</td> <td>≤ 1</td> </tr> <tr> <td>16 QAM</td> <td>> 5</td> <td>> 4</td> <td>> 8</td> <td>> 12</td> <td>> 16</td> <td>> 18</td> <td>≤ 2</td> </tr> <tr> <td>64 QAM</td> <td>≤ 5</td> <td>≤ 4</td> <td>≤ 8</td> <td>≤ 12</td> <td>≤ 16</td> <td>≤ 18</td> <td>≤ 2</td> </tr> <tr> <td>64 QAM</td> <td>> 5</td> <td>> 4</td> <td>> 8</td> <td>> 12</td> <td>> 16</td> <td>> 18</td> <td>≤ 3</td> </tr> <tr> <td>256 QAM</td> <td colspan="6" style="text-align: center;">≥ 1</td> <td>≤ 5</td> </tr> </tbody> </table> | Modulation | Channel bandwidth / Transmission bandwidth (N _{RB}) | | | | | | MPR (dB) | 1.4 MHz | 3.0 MHz | 5 MHz | 10 MHz | 15 MHz | 20 MHz | QPSK | > 5 | > 4 | > 8 | > 12 | > 16 | > 18 | ≤ 1 | 16 QAM | ≤ 5 | ≤ 4 | ≤ 8 | ≤ 12 | ≤ 16 | ≤ 18 | ≤ 1 | 16 QAM | > 5 | > 4 | > 8 | > 12 | > 16 | > 18 | ≤ 2 | 64 QAM | ≤ 5 | ≤ 4 | ≤ 8 | ≤ 12 | ≤ 16 | ≤ 18 | ≤ 2 | 64 QAM | > 5 | > 4 | > 8 | > 12 | > 16 | > 18 | ≤ 3 | 256 QAM | ≥ 1 | | | | | | ≤ 5 |
| Modulation | Channel bandwidth / Transmission bandwidth (N _{RB}) | | | | | | MPR (dB) | | | | | | | | | | | | | | | | | | | | | | | | | | | | | | | | | | | | | | | | | | | | | | | | | | | | | | | | |
| | 1.4 MHz | 3.0 MHz | 5 MHz | 10 MHz | 15 MHz | 20 MHz | | | | | | | | | | | | | | | | | | | | | | | | | | | | | | | | | | | | | | | | | | | | | | | | | | | | | | | | | |
| QPSK | > 5 | > 4 | > 8 | > 12 | > 16 | > 18 | ≤ 1 | | | | | | | | | | | | | | | | | | | | | | | | | | | | | | | | | | | | | | | | | | | | | | | | | | | | | | | | |
| 16 QAM | ≤ 5 | ≤ 4 | ≤ 8 | ≤ 12 | ≤ 16 | ≤ 18 | ≤ 1 | | | | | | | | | | | | | | | | | | | | | | | | | | | | | | | | | | | | | | | | | | | | | | | | | | | | | | | | |
| 16 QAM | > 5 | > 4 | > 8 | > 12 | > 16 | > 18 | ≤ 2 | | | | | | | | | | | | | | | | | | | | | | | | | | | | | | | | | | | | | | | | | | | | | | | | | | | | | | | | |
| 64 QAM | ≤ 5 | ≤ 4 | ≤ 8 | ≤ 12 | ≤ 16 | ≤ 18 | ≤ 2 | | | | | | | | | | | | | | | | | | | | | | | | | | | | | | | | | | | | | | | | | | | | | | | | | | | | | | | | |
| 64 QAM | > 5 | > 4 | > 8 | > 12 | > 16 | > 18 | ≤ 3 | | | | | | | | | | | | | | | | | | | | | | | | | | | | | | | | | | | | | | | | | | | | | | | | | | | | | | | | |
| 256 QAM | ≥ 1 | | | | | | ≤ 5 | | | | | | | | | | | | | | | | | | | | | | | | | | | | | | | | | | | | | | | | | | | | | | | | | | | | | | | | |
| LTE A-MPR | In the base station simulator configuration, Network Setting value is set to NS_01 to disable A-MPR during SAR testing and the LTE SAR tests was transmitting on all TTI frames (Maximum TTI) | | | | | | | | | | | | | | | | | | | | | | | | | | | | | | | | | | | | | | | | | | | | | | | | | | | | | | | | | | | | | | |
| Spectrum plots for RB configuration | A properly configured base station simulator was used for the SAR and power measurement; therefore, spectrum plots for each RB allocation and offset configuration are not included in the SAR report. | | | | | | | | | | | | | | | | | | | | | | | | | | | | | | | | | | | | | | | | | | | | | | | | | | | | | | | | | | | | | | |
| Power reduction applied to satisfy SAR compliance | Yes, head/body-worn/ hotspot/extremity will trigger reduced power for some LTE bands, the detail please referred to section 13. | | | | | | | | | | | | | | | | | | | | | | | | | | | | | | | | | | | | | | | | | | | | | | | | | | | | | | | | | | | | | | |



| Transmission (H, M, L) channel numbers and frequencies in each LTE band | | | | | | | | | | | | |
|---|-------------------|-------------|------------------|-------------|------------------|-------------|------------------|-------------|------------------|-------------|------------------|-------------|
| LTE Band 2 | | | | | | | | | | | | |
| | Bandwidth 1.4 MHz | | Bandwidth 3 MHz | | Bandwidth 5 MHz | | Bandwidth 10 MHz | | Bandwidth 15 MHz | | Bandwidth 20 MHz | |
| | Ch. # | Freq. (MHz) | Ch. # | Freq. (MHz) | Ch. # | Freq. (MHz) | Ch. # | Freq. (MHz) | Ch. # | Freq. (MHz) | Ch. # | Freq. (MHz) |
| L | 18607 | 1850.7 | 18615 | 1851.5 | 18625 | 1852.5 | 18650 | 1855 | 18675 | 1857.5 | 18700 | 1860 |
| M | 18900 | 1880 | 18900 | 1880 | 18900 | 1880 | 18900 | 1880 | 18900 | 1880 | 18900 | 1880 |
| H | 19193 | 1909.3 | 19185 | 1908.5 | 19175 | 1907.5 | 19150 | 1905 | 19125 | 1902.5 | 19100 | 1900 |
| LTE Band 4 | | | | | | | | | | | | |
| | Bandwidth 1.4 MHz | | Bandwidth 3 MHz | | Bandwidth 5 MHz | | Bandwidth 10 MHz | | Bandwidth 15 MHz | | Bandwidth 20 MHz | |
| | Ch. # | Freq. (MHz) | Ch. # | Freq. (MHz) | Ch. # | Freq. (MHz) | Ch. # | Freq. (MHz) | Ch. # | Freq. (MHz) | Ch. # | Freq. (MHz) |
| L | 19957 | 1710.7 | 19965 | 1711.5 | 19975 | 1712.5 | 20000 | 1715 | 20025 | 1717.5 | 20050 | 1720 |
| M | 20175 | 1732.5 | 20175 | 1732.5 | 20175 | 1732.5 | 20175 | 1732.5 | 20175 | 1732.5 | 20175 | 1732.5 |
| H | 20393 | 1754.3 | 20385 | 1753.5 | 20375 | 1752.5 | 20350 | 1750 | 20325 | 1747.5 | 20300 | 1745 |
| LTE Band 5 | | | | | | | | | | | | |
| | Bandwidth 1.4 MHz | | Bandwidth 3 MHz | | Bandwidth 5 MHz | | Bandwidth 10 MHz | | Bandwidth 15 MHz | | Bandwidth 20 MHz | |
| | Ch. # | Freq. (MHz) | Ch. # | Freq. (MHz) | Ch. # | Freq. (MHz) | Ch. # | Freq. (MHz) | Ch. # | Freq. (MHz) | Ch. # | Freq. (MHz) |
| L | 20407 | 824.7 | 20415 | 825.5 | 20425 | 826.5 | 20450 | 829 | 20450 | 829 | 20450 | 829 |
| M | 20525 | 836.5 | 20525 | 836.5 | 20525 | 836.5 | 20525 | 836.5 | 20525 | 836.5 | 20525 | 836.5 |
| H | 20643 | 848.3 | 20635 | 847.5 | 20625 | 846.5 | 20600 | 844 | 20600 | 844 | 20600 | 844 |
| LTE Band 7 | | | | | | | | | | | | |
| | Bandwidth 5 MHz | | Bandwidth 10 MHz | | Bandwidth 15 MHz | | Bandwidth 20 MHz | | Bandwidth 15 MHz | | Bandwidth 20 MHz | |
| | Ch. # | Freq. (MHz) | Ch. # | Freq. (MHz) | Ch. # | Freq. (MHz) | Ch. # | Freq. (MHz) | Ch. # | Freq. (MHz) | Ch. # | Freq. (MHz) |
| L | 20775 | 2502.5 | 20800 | 2505 | 20825 | 2507.5 | 20850 | 2510 | 20850 | 2510 | 20850 | 2510 |
| M | 21100 | 2535 | 21100 | 2535 | 21100 | 2535 | 21100 | 2535 | 21100 | 2535 | 21100 | 2535 |
| H | 21425 | 2567.5 | 21400 | 2565 | 21375 | 2562.5 | 21350 | 2560 | 21350 | 2560 | 21350 | 2560 |
| LTE Band 66 | | | | | | | | | | | | |
| | Bandwidth 1.4 MHz | | Bandwidth 3 MHz | | Bandwidth 5 MHz | | Bandwidth 10 MHz | | Bandwidth 15 MHz | | Bandwidth 20 MHz | |
| | Ch. # | Freq. (MHz) | Ch. # | Freq. (MHz) | Ch. # | Freq. (MHz) | Ch. # | Freq. (MHz) | Ch. # | Freq. (MHz) | Ch. # | Freq. (MHz) |
| L | 131979 | 1710.7 | 131987 | 1711.5 | 131997 | 1712.5 | 132022 | 1715 | 132047 | 1717.5 | 132072 | 1720 |
| M | 132322 | 1745 | 132322 | 1745 | 132322 | 1745 | 132322 | 1745 | 132322 | 1745 | 132322 | 1745 |
| H | 132665 | 1779.3 | 132657 | 1778.5 | 132647 | 1777.5 | 132622 | 1775 | 132597 | 1772.5 | 132572 | 1770 |

5. Proximity Sensor Triggering Test

5.1 Proximity sensor triggering distances(Per KDB616217§6.2)

- Proximity sensor triggering distance testing was performed according to the procedures outlined in KDB 616217 D04 section 6.2, and EUT moving further away from the flat phantom and EUT moving toward the flat phantom were both assessed and the tissue-equivalent medium for highest frequency (5720MHz) and lowest (850MHz) frequency was used for proximity sensor triggering testing.
- Capacitive proximity sensor placed coincident with antenna elements at the bottom end of the phone are utilized to determine when the device comes in proximity of the user's body at the front or back or bottom or left side surface of the device. There is no need to do sensor coverage testing for the proximity sensor is designed to support sufficient detection range and sensitivity to cover regions of the sensors in all applicable directions since the proximity sensor entirely covers the antenna.
- When the proximity sensor is active, GSM850/1900, WCDMA band II/IV/V, LTE band 2/4/5/7/66 and WLAN5.5GHZ reduced power will be active for front/ back body worn SAR.
- P-sensor can detect handheld state, WCDMA band II/IV and LTE B2/4/7/66 for front/back/bottom sides of product specific 10g SAR condition reduced powers will be active for handheld SAR.
- The proximity sensors used to detect the proximity of the user's body at the front or back or bottom side surface of the device use a detection threshold distance. The data shown in the sections below shows the distance(s).
- For verification of compliance of power reduction scheme, additional SAR testing with EUT transmitting at full RF power at a conservative trigger distance was performed for body worn:
Front: [12 mm](#)
Back: [20 mm](#)
- For verification of compliance of power reduction scheme, additional SAR testing with EUT transmitting at full RF power at a conservative trigger distance was performed for handheld:
Front: [9 mm](#)
Back: [13 mm](#)
Bottom side: [10 mm](#)

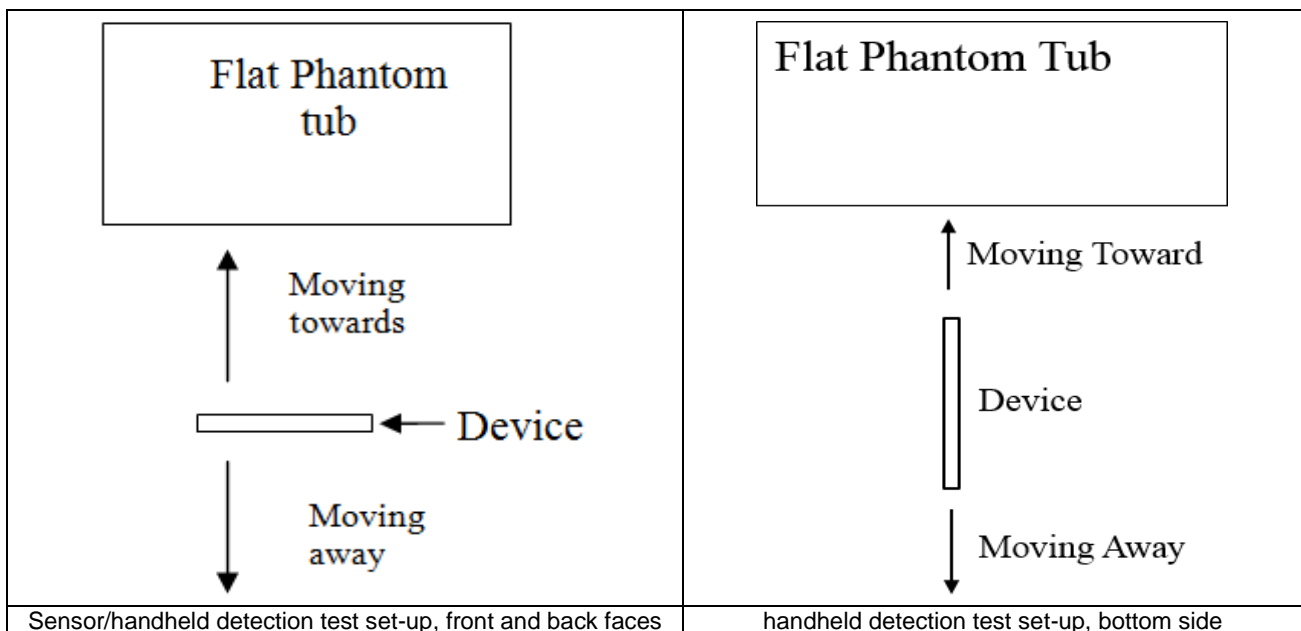

<P-Sensor>

| Proximity Sensor Triggering Distance (mm) | | | | |
|---|----------------|-------------|----------------|-------------|
| Position | Front | | Back | |
| | Moving towards | Moving away | Moving towards | Moving away |
| Minimum | 13 | 14 | 21 | 23 |

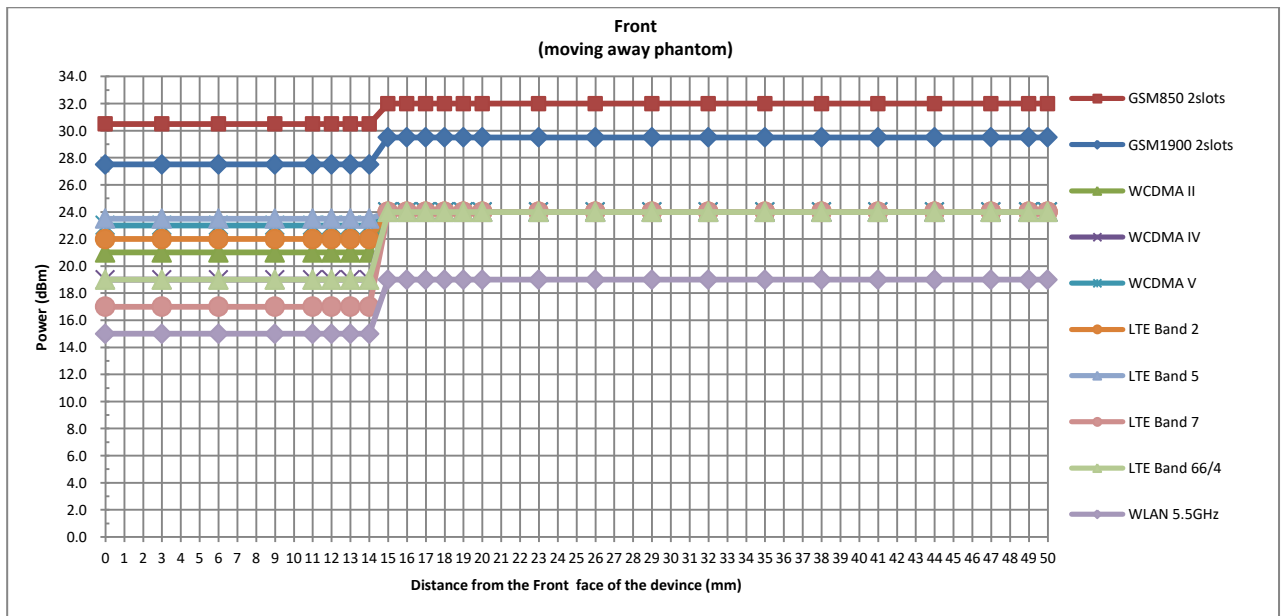
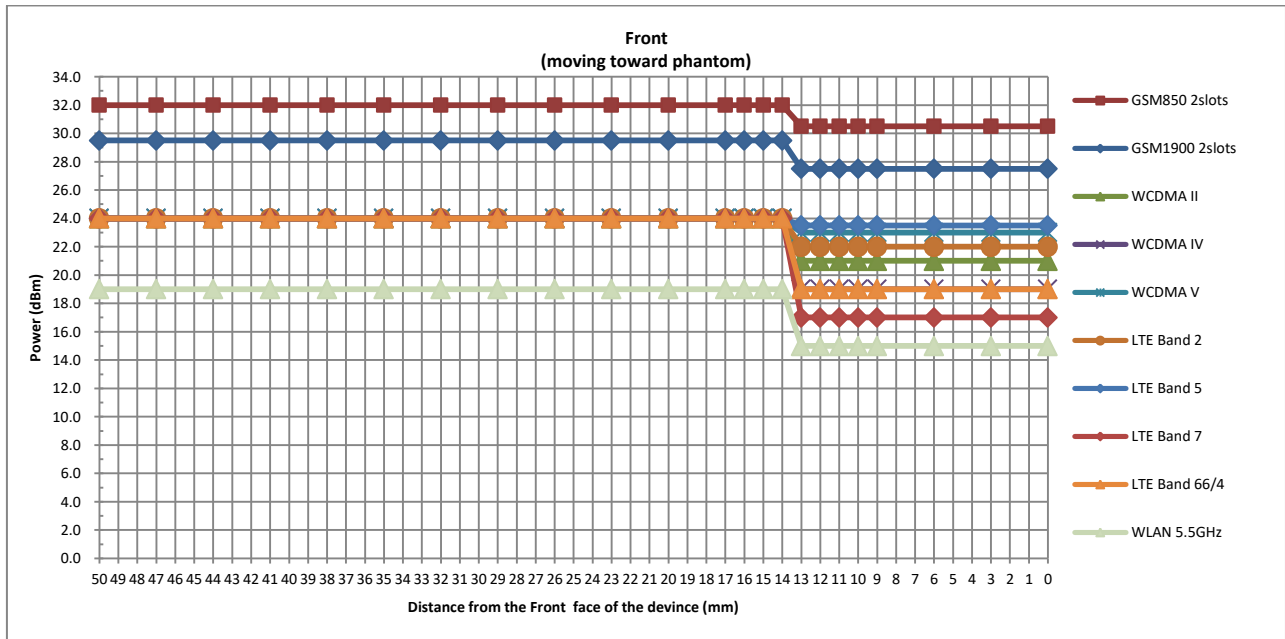

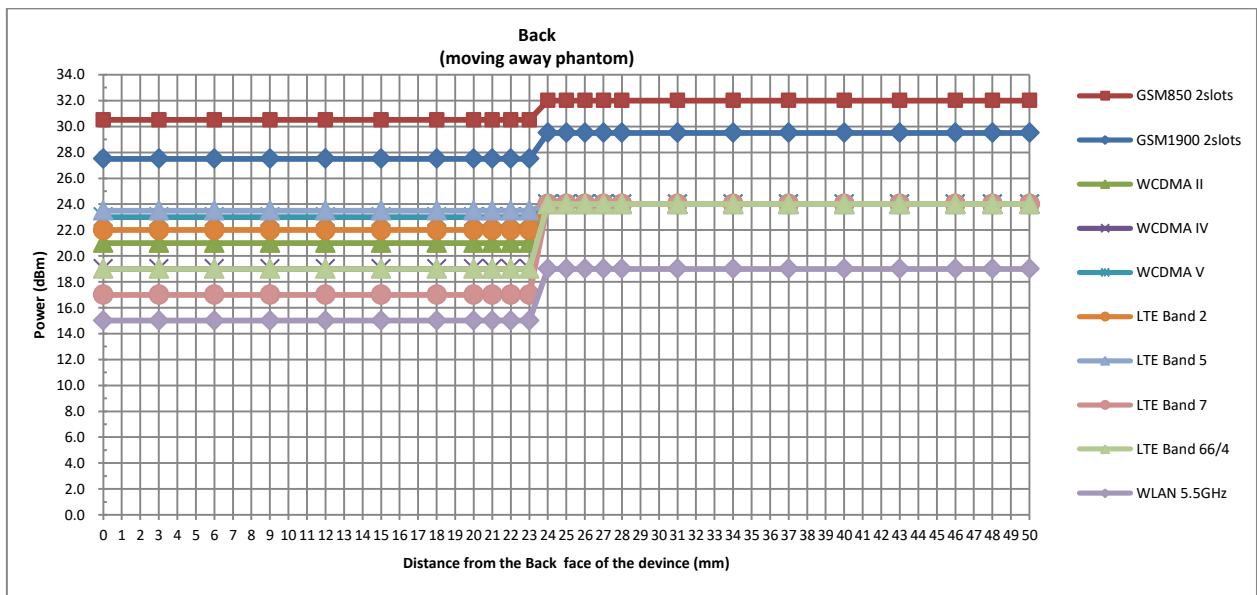
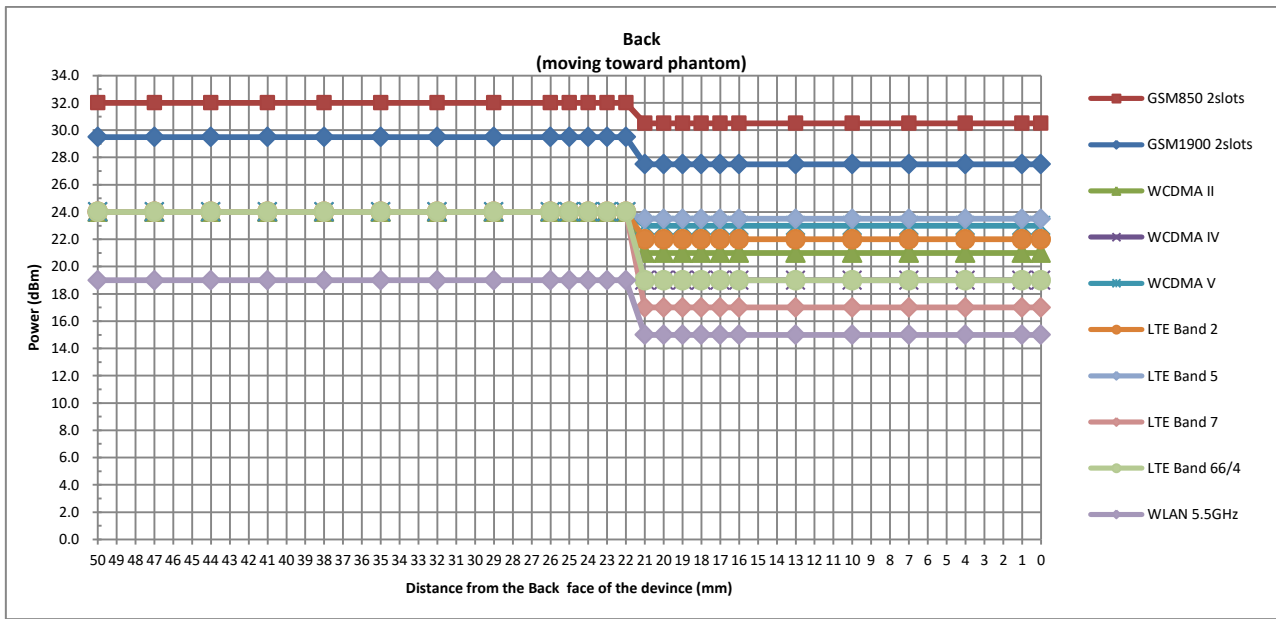

<Handheld>

| Position | Front | | Back | | Bottom Side | |
|----------|----------------|-------------|----------------|-------------|----------------|-------------|
| | Moving towards | Moving away | Moving towards | Moving away | Moving towards | Moving away |
| Minimum | 10 | 12 | 14 | 17 | 11 | 14 |

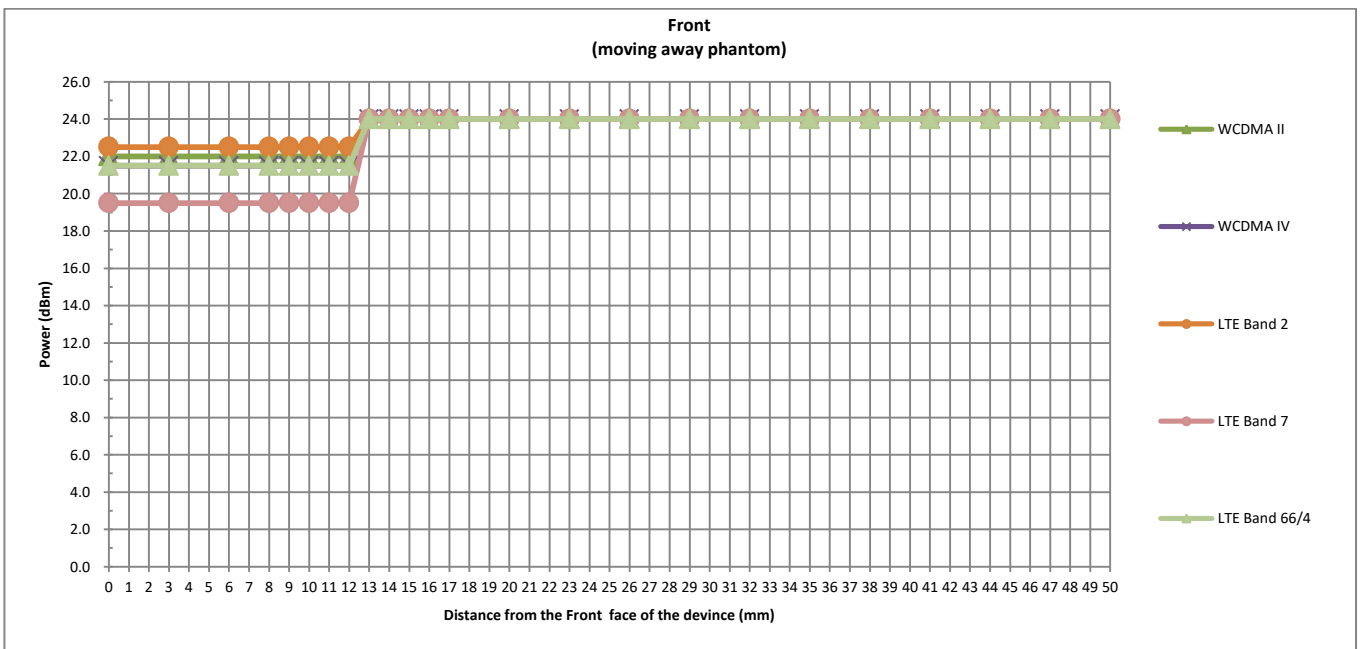
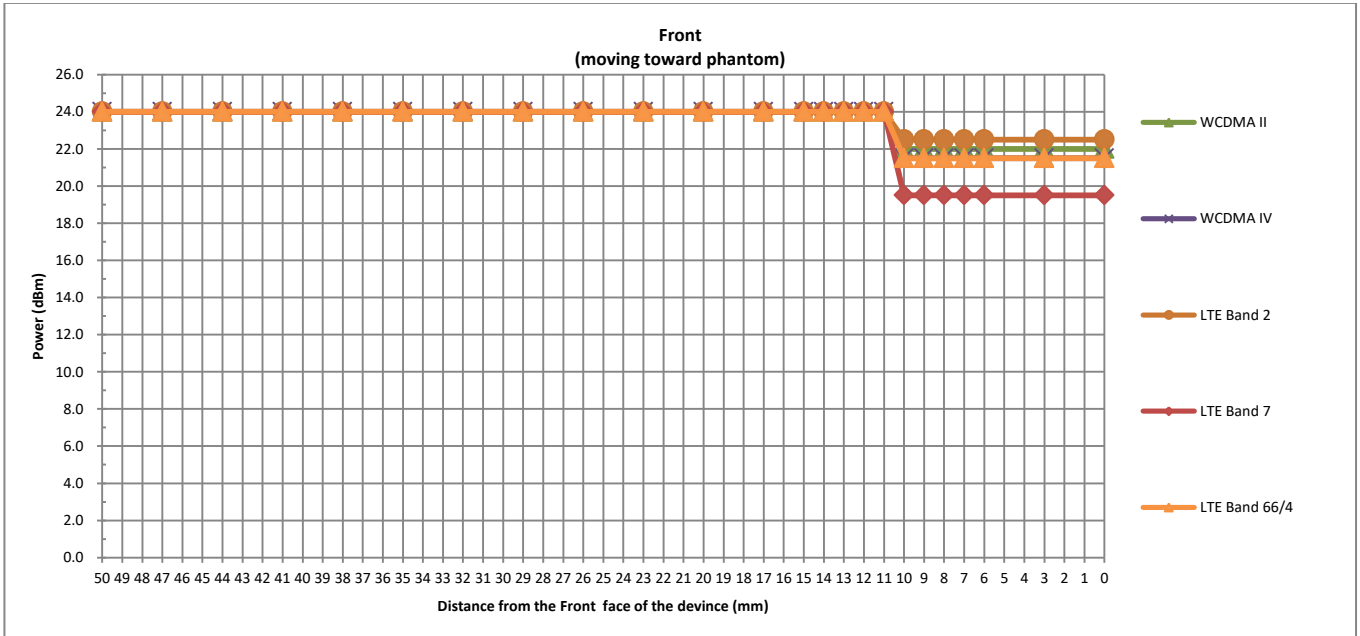

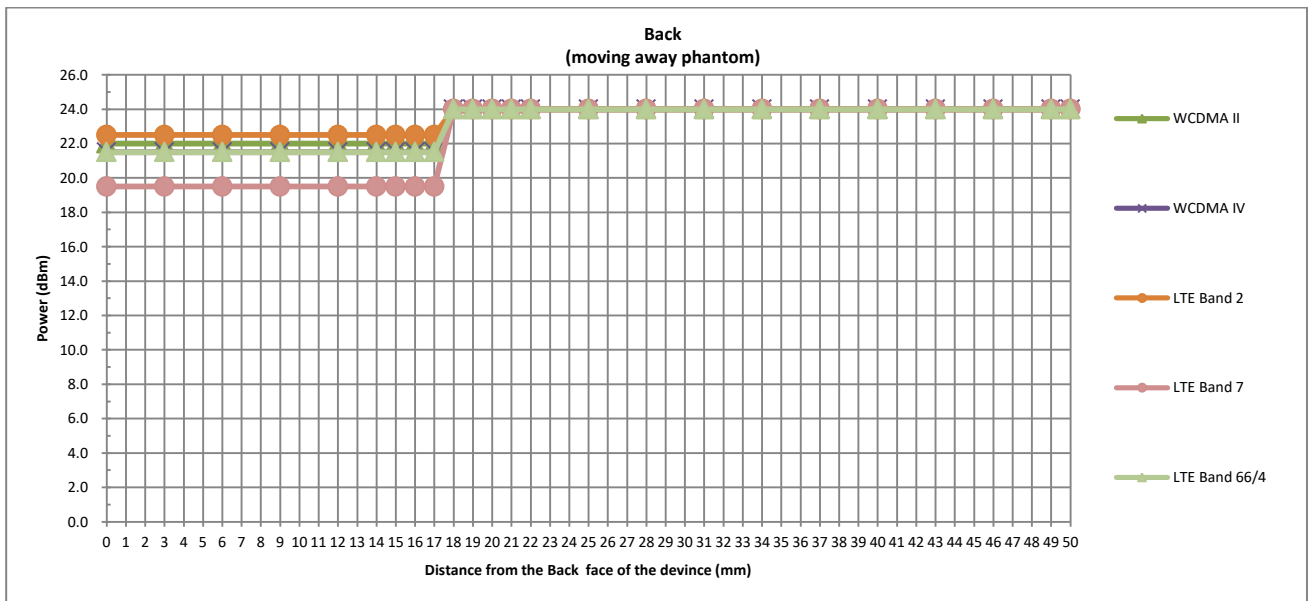
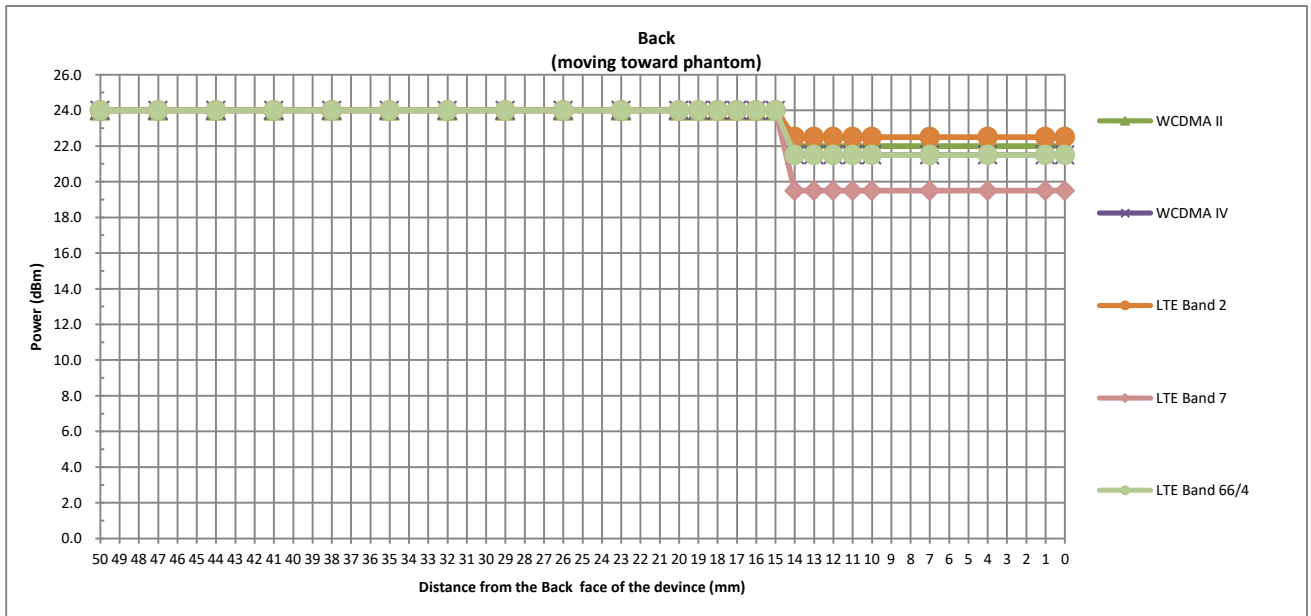

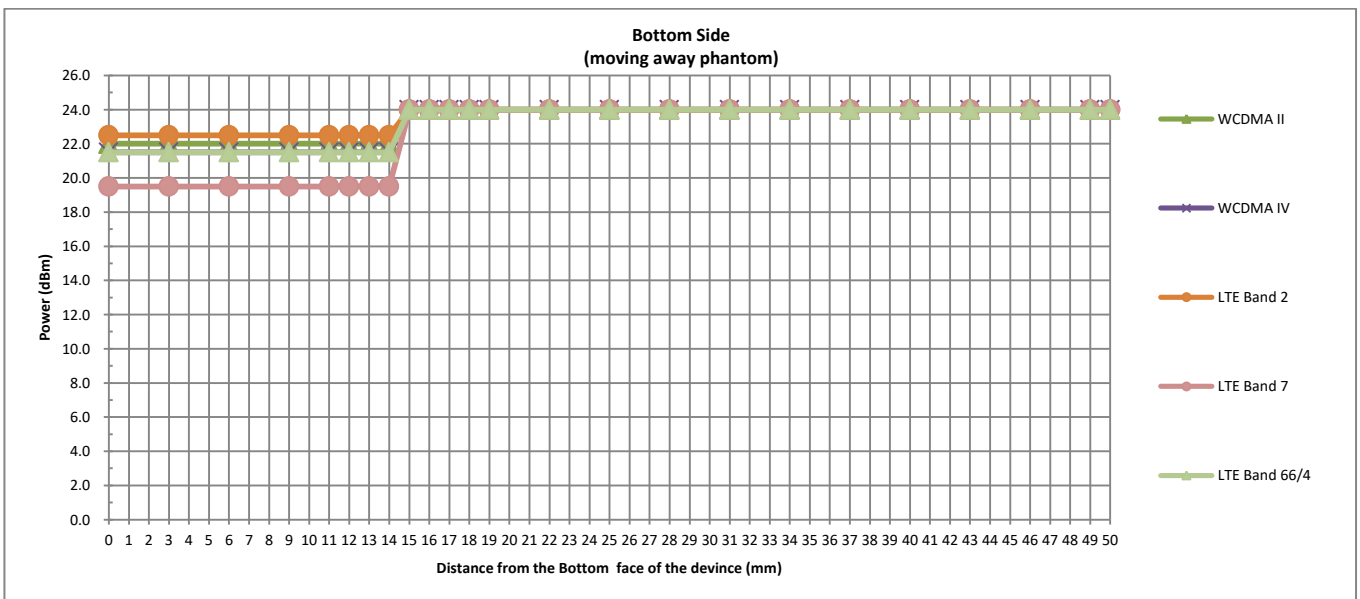
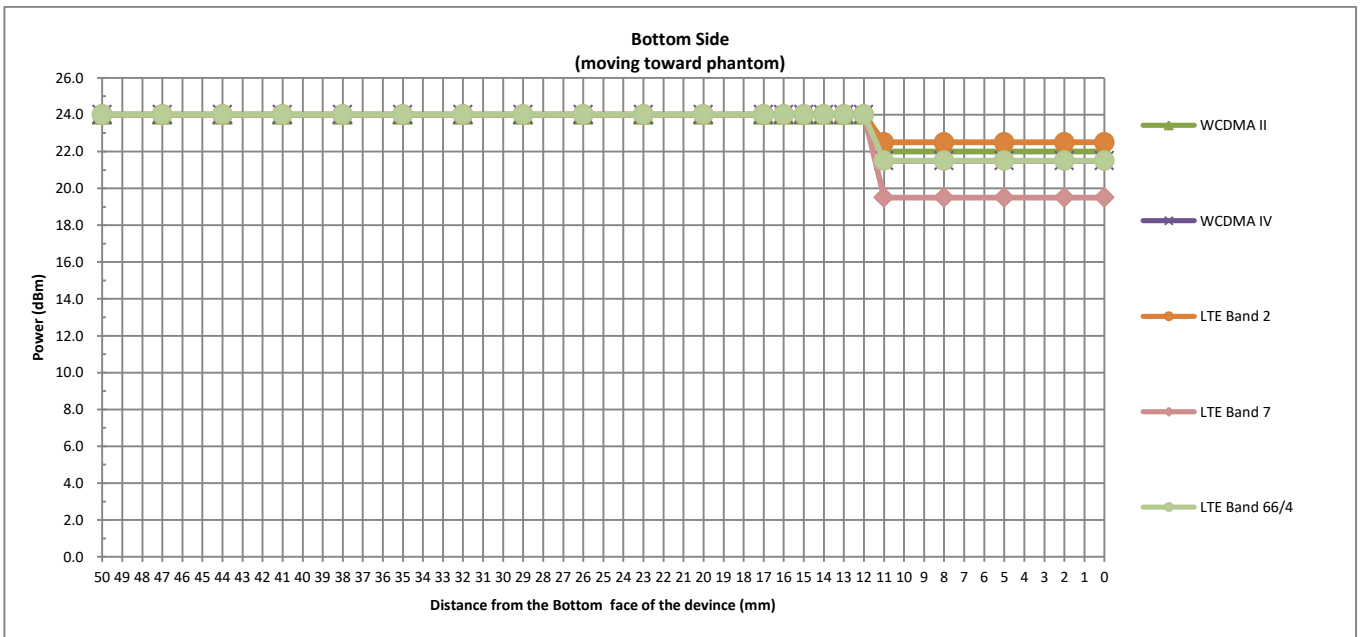



6. RF Exposure Limits

6.1 Uncontrolled Environment

Uncontrolled Environments are defined as locations where there is the exposure of individuals who have no knowledge or control of their exposure. The general population/uncontrolled exposure limits are applicable to situations in which the general public may be exposed or in which persons who are exposed as a consequence of their employment may not be made fully aware of the potential for exposure or cannot exercise control over their exposure. Members of the general public would come under this category when exposure is not employment-related; for example, in the case of a wireless transmitter that exposes persons in its vicinity.

6.2 Controlled Environment

Controlled Environments are defined as locations where there is exposure that may be incurred by persons who are aware of the potential for exposure, (i.e. as a result of employment or occupation). In general, occupational/controlled exposure limits are applicable to situations in which persons are exposed as a consequence of their employment, who have been made fully aware of the potential for exposure and can exercise control over their exposure. The exposure category is also applicable when the exposure is of a transient nature due to incidental passage through a location where the exposure levels may be higher than the general population/uncontrolled limits, but the exposed person is fully aware of the potential for exposure and can exercise control over his or her exposure by leaving the area or by some other appropriate means.

Limits for Occupational/Controlled Exposure (W/kg)

| Whole-Body | Partial-Body | Hands, Wrists, Feet and Ankles |
|------------|--------------|--------------------------------|
| 0.4 | 8.0 | 20.0 |

Limits for General Population/Uncontrolled Exposure (W/kg)

| Whole-Body | Partial-Body | Hands, Wrists, Feet and Ankles |
|------------|--------------|--------------------------------|
| 0.08 | 1.6 | 4.0 |

Whole-Body SAR is averaged over the entire body, partial-body SAR is averaged over any 1gram of tissue defined as a tissue volume in the shape of a cube. SAR for hands, wrists, feet and ankles is averaged over any 10 grams of tissue defined as a tissue volume in the shape of a cube.

7. Specific Absorption Rate (SAR)

7.1 Introduction

SAR is related to the rate at which energy is absorbed per unit mass in an object exposed to a radio field. The SAR distribution in a biological body is complicated and is usually carried out by experimental techniques or numerical modeling. The standard recommends limits for two tiers of groups, occupational/controlled and general population/uncontrolled, based on a person's awareness and ability to exercise control over his or her exposure. In general, occupational/controlled exposure limits are higher than the limits for general population/uncontrolled.

7.2 SAR Definition

The SAR definition is the time derivative (rate) of the incremental energy (dW) absorbed by (dissipated in) an incremental mass (dm) contained in a volume element (dv) of a given density (ρ). The equation description is as below:

$$\text{SAR} = \frac{d}{dt} \left(\frac{dW}{dm} \right) = \frac{d}{dt} \left(\frac{dW}{\rho dv} \right)$$

SAR is expressed in units of Watts per kilogram (W/kg)

$$\text{SAR} = \frac{\sigma |E|^2}{\rho}$$

Where: σ is the conductivity of the tissue, ρ is the mass density of the tissue and E is the RMS electrical field strength.

8. System Description and Setup

The DASY system used for performing compliance tests consists of the following items:

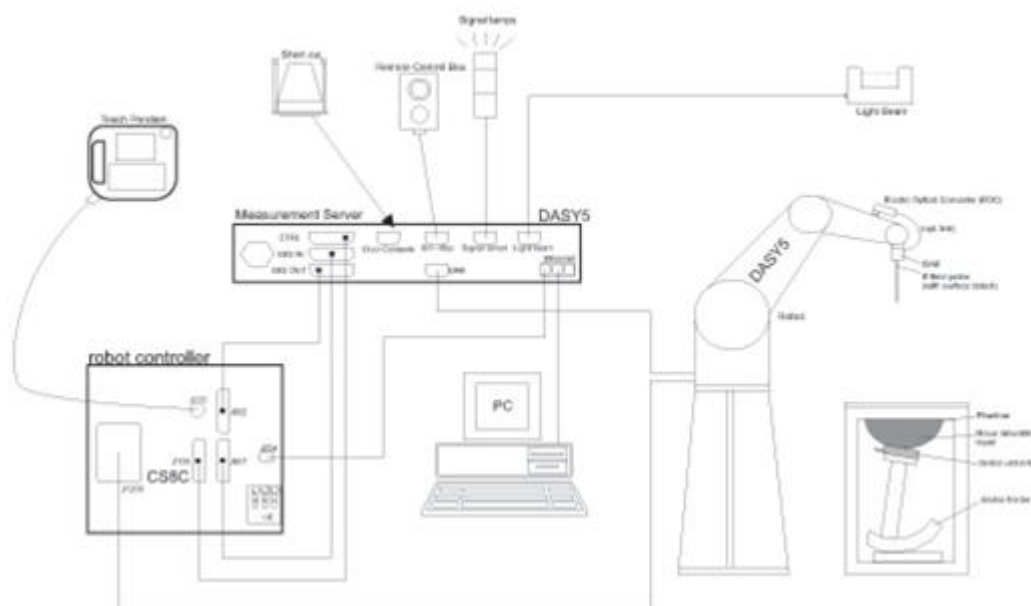

- A standard high precision 6-axis robot with controller, teach pendant and software. An arm extension for accommodating the data acquisition electronics (DAE).
- An isotropic Field probe optimized and calibrated for the targeted measurement.
- A data acquisition electronics (DAE) which performs the signal amplification, signal multiplexing, AD-conversion, offset measurements, mechanical surface detection, collision detection, etc. The unit is battery powered with standard or rechargeable batteries. The signal is optically transmitted to the EOC.
- The Electro-optical converter (EOC) performs the conversion from optical to electrical signals for the digital communication to the DAE. To use optical surface detection, a special version of the EOC is required. The EOC signal is transmitted to the measurement server.
- The function of the measurement server is to perform the time critical tasks such as signal filtering, control of the robot operation and fast movement interrupts.
- The Light Beam used is for probe alignment. This improves the (absolute) accuracy of the probe positioning.
- A computer running WinXP or Win7 and the DASY5 software.
- Remote control and teach pendant as well as additional circuitry for robot safety such as warning lamps, etc.
- The phantom, the device holder and other accessories according to the targeted measurement.

8.1 E-Field Probe

The SAR measurement is conducted with the dosimetric probe (manufactured by SPEAG).The probe is specially designed and calibrated for use in liquid with high permittivity. The dosimetric probe has special calibration in liquid at different frequency. This probe has a built in optical surface detection system to prevent from collision with phantom.

<EX3DV4 Probe>

| | | |
|----------------------|---|--|
| Construction | Symmetric design with triangular core Built-in shielding against static charges PEEK enclosure material (resistant to organic solvents, e.g., DGBE) |  |
| Frequency | 10 MHz – >6 GHz Linearity: ±0.2 dB (30 MHz – 6 GHz) | |
| Directivity | ±0.3 dB in TSL (rotation around probe axis) ±0.5 dB in TSL (rotation normal to probe axis) | |
| Dynamic Range | 10 µW/g – >100 mW/g Linearity: ±0.2 dB (noise: typically <1 µW/g) | |
| Dimensions | Overall length: 337 mm (tip: 20 mm) Tip diameter: 2.5 mm (body: 12 mm) Typical distance from probe tip to dipole centers: 1 mm | |

<ES3DV3 Probe>

| | | |
|----------------------|--|---|
| Construction | Symmetric design with triangular core Interleaved sensors Built-in shielding against static charges PEEK enclosure material (resistant to organic solvents, e.g., DGBE) |  |
| Frequency | 10 MHz – 4 GHz; Linearity: ±0.2 dB (30 MHz – 4 GHz) | |
| Directivity | ±0.2 dB in TSL (rotation around probe axis) ±0.3 dB in TSL (rotation normal to probe axis) | |
| Dynamic Range | 5 µW/g – >100 mW/g; Linearity: ±0.2 dB | |
| Dimensions | Overall length: 337 mm (tip: 20 mm) Tip diameter: 3.9 mm (body: 12 mm) Distance from probe tip to dipole centers: 3.0 mm | |

8.2 Data Acquisition Electronics (DAE)

The data acquisition electronics (DAE) consists of a highly sensitive electrometer-grade preamplifier with auto-zeroing, a channel and gain-switching multiplexer, a fast 16 bit AD-converter and a command decoder and control logic unit. Transmission to the measurement server is accomplished through an optical downlink for data and status information as well as an optical uplink for commands and the clock.

The input impedance of the DAE is 200 MOhm; the inputs are symmetrical and floating. Common mode rejection is above 80 dB.



Photo of DAE

8.3 Phantom

<SAM Twin Phantom>

| | | |
|--------------------------|---|--|
| Shell Thickness | 2 ± 0.2 mm; Center ear point: 6 ± 0.2 mm |  |
| Filling Volume | Approx. 25 liters | |
| Dimensions | Length: 1000 mm; Width: 500 mm; Height: adjustable feet | |
| Measurement Areas | Left Hand, Right Hand, Flat Phantom | |

The bottom plate contains three pair of bolts for locking the device holder. The device holder positions are adjusted to the standard measurement positions in the three sections. A white cover is provided to tap the phantom during off-periods to prevent water evaporation and changes in the liquid parameters. On the phantom top, three reference markers are provided to identify the phantom position with respect to the robot.

<ELI Phantom>

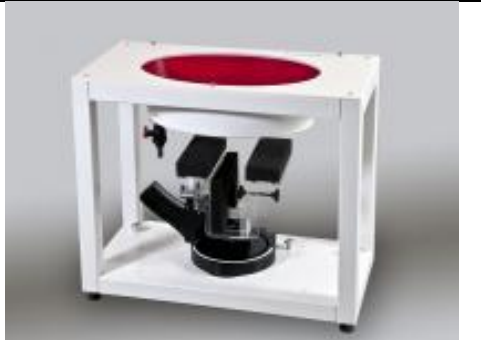
| | | |
|------------------------|--|---|
| Shell Thickness | 2 ± 0.2 mm (sagging: <1%) |  |
| Filling Volume | Approx. 30 liters | |
| Dimensions | Major ellipse axis: 600 mm Minor axis: 400 mm | |

The ELI phantom is intended for compliance testing of handheld and body-mounted wireless devices in the frequency range of 30 MHz to 6 GHz. ELI4 is fully compatible with standard and all known tissue simulating liquids.

8.4 Device Holder

<Mounting Device for Hand-Held Transmitter>

In combination with the Twin SAM V5.0/V5.0c or ELI phantoms, the Mounting Device for Hand-Held Transmitters enables rotation of the mounted transmitter device to specified spherical coordinates. At the heads, the rotation axis is at the ear opening. Transmitter devices can be easily and accurately positioned according to IEC 62209-1, IEEE 1528, FCC, or other specifications. The device holder can be locked for positioning at different phantom sections (left head, right head, flat). And upgrade kit to Mounting Device to enable easy mounting of wider devices like big smart-phones, e-books, small tablets, etc. It holds devices with width up to 140 mm.



Mounting Device for Hand-Held Transmitters



Mounting Device Adaptor for Wide-Phones

<Mounting Device for Laptops and other Body-Worn Transmitters>

The extension is lightweight and made of POM, acrylic glass and foam. It fits easily on the upper part of the mounting device in place of the phone positioned. The extension is fully compatible with the SAM Twin and ELI phantoms.



Mounting Device for Laptops

9. Measurement Procedures

The measurement procedures are as follows:

<Conducted power measurement>

- (a) For WWAN power measurement, use base station simulator to configure EUT WWAN transmission in conducted connection with RF cable, at maximum power in each supported wireless interface and frequency band.
- (b) Read the WWAN RF power level from the base station simulator.
- (c) For WLAN/BT power measurement, use engineering software to configure EUT WLAN/BT continuously transmission, at maximum RF power in each supported wireless interface and frequency band
- (d) Connect EUT RF port through RF cable to the power meter, and measure WLAN/BT output power

<SAR measurement>

- (a) Use base station simulator to configure EUT WWAN transmission in radiated connection, and engineering software to configure EUT WLAN/BT continuously transmission, at maximum RF power, in the highest power channel.
- (b) Place the EUT in the positions as Appendix D demonstrates.
- (c) Set scan area, grid size and other setting on the DASY software.
- (d) Measure SAR results for the highest power channel on each testing position.
- (e) Find out the largest SAR result on these testing positions of each band
- (f) Measure SAR results for other channels in worst SAR testing position if the reported SAR of highest power channel is larger than 0.8 W/kg

According to the test standard, the recommended procedure for assessing the peak spatial-average SAR value consists of the following steps:

- (a) Power reference measurement
- (b) Area scan
- (c) Zoom scan
- (d) Power drift measurement

9.1 Spatial Peak SAR Evaluation

The procedure for spatial peak SAR evaluation has been implemented according to the test standard. It can be conducted for 1g and 10g, as well as for user-specific masses. The DASY software includes all numerical procedures necessary to evaluate the spatial peak SAR value.

The base for the evaluation is a "cube" measurement. The measured volume must include the 1g and 10g cubes with the highest averaged SAR values. For that purpose, the center of the measured volume is aligned to the interpolated peak SAR value of a previously performed area scan.

The entire evaluation of the spatial peak values is performed within the post-processing engine (SEMCAD). The system always gives the maximum values for the 1g and 10g cubes. The algorithm to find the cube with highest averaged SAR is divided into the following stages:

- (a) Extraction of the measured data (grid and values) from the Zoom Scan
- (b) Calculation of the SAR value at every measurement point based on all stored data (A/D values and measurement parameters)
- (c) Generation of a high-resolution mesh within the measured volume
- (d) Interpolation of all measured values from the measurement grid to the high-resolution grid
- (e) Extrapolation of the entire 3-D field distribution to the phantom surface over the distance from sensor to surface
- (f) Calculation of the averaged SAR within masses of 1g and 10g

9.2 Power Reference Measurement

The Power Reference Measurement and Power Drift Measurements are for monitoring the power drift of the device under test in the batch process. The minimum distance of probe sensors to surface determines the closest measurement point to phantom surface. This distance cannot be smaller than the distance of sensor calibration points to probe tip as defined in the probe properties.

9.3 Area Scan

The area scan is used as a fast scan in two dimensions to find the area of high field values, before doing a fine measurement around the hot spot. The sophisticated interpolation routines implemented in DASY software can find the maximum found in the scanned area, within a range of the global maximum. The range (in dB0 is specified in the standards for compliance testing. For example, a 2 dB range is required in IEEE standard 1528 and IEC 62209 standards, whereby 3 dB is a requirement when compliance is assessed in accordance with the ARIB standard (Japan), if only one zoom scan follows the area scan, then only the absolute maximum will be taken as reference. For cases where multiple maximums are detected, the number of zoom scans has to be increased accordingly.

Area scan parameters extracted from FCC KDB 865664 D01v01r04 SAR measurement 100 MHz to 6 GHz.

| | ≤ 3 GHz | > 3 GHz |
|--|--|--|
| Maximum distance from closest measurement point (geometric center of probe sensors) to phantom surface | 5 ± 1 mm | $\frac{1}{2} \cdot \delta \cdot \ln(2) \pm 0.5$ mm |
| Maximum probe angle from probe axis to phantom surface normal at the measurement location | $30^\circ \pm 1^\circ$ | $20^\circ \pm 1^\circ$ |
| Maximum area scan spatial resolution: Δx_{Area} , Δy_{Area} | ≤ 2 GHz: ≤ 15 mm 2 – 3 GHz: ≤ 12 mm | 3 – 4 GHz: ≤ 12 mm 4 – 6 GHz: ≤ 10 mm |
| | When the x or y dimension of the test device, in the measurement plane orientation, is smaller than the above, the measurement resolution must be \leq the corresponding x or y dimension of the test device with at least one measurement point on the test device. | |

9.4 Zoom Scan

Zoom scans are used to assess the peak spatial SAR values within a cubic averaging volume containing 1 gram and 10 gram of simulated tissue. The zoom scan measures points (refer to table below) within a cube whose base faces are centered on the maxima found in a preceding area scan job within the same procedure. When the measurement is done, the zoom scan evaluates the averaged SAR for 1 gram and 10 gram and displays these values next to the job's label.

Zoom scan parameters extracted from FCC KDB 865664 D01v01r04 SAR measurement 100 MHz to 6 GHz.

| | | | ≤ 3 GHz | > 3 GHz |
|--|------------------------------------|--|--|---|
| Maximum zoom scan spatial resolution: Δx_{Zoom} , Δy_{Zoom} | | | ≤ 2 GHz: ≤ 8 mm 2 – 3 GHz: ≤ 5 mm* | 3 – 4 GHz: ≤ 5 mm* 4 – 6 GHz: ≤ 4 mm* |
| Maximum zoom scan spatial resolution, normal to phantom surface | uniform grid: $\Delta z_{Zoom}(n)$ | | ≤ 5 mm | 3 – 4 GHz: ≤ 4 mm 4 – 5 GHz: ≤ 3 mm 5 – 6 GHz: ≤ 2 mm |
| | graded grid | $\Delta z_{Zoom}(1)$: between 1 st two points closest to phantom surface | ≤ 4 mm | 3 – 4 GHz: ≤ 3 mm 4 – 5 GHz: ≤ 2.5 mm 5 – 6 GHz: ≤ 2 mm |
| | | $\Delta z_{Zoom}(n>1)$: between subsequent points | $\leq 1.5 \cdot \Delta z_{Zoom}(n-1)$ | |
| Minimum zoom scan volume | x, y, z | | ≥ 30 mm | 3 – 4 GHz: ≥ 28 mm 4 – 5 GHz: ≥ 25 mm 5 – 6 GHz: ≥ 22 mm |
| Note: δ is the penetration depth of a plane-wave at normal incidence to the tissue medium; see draft standard IEEE P1528-2011 for details. * When zoom scan is required and the <i>reported</i> SAR from the <i>area scan based 1-g SAR estimation</i> procedures of KDB 447498 is ≤ 1.4 W/kg, ≤ 8 mm, ≤ 7 mm and ≤ 5 mm zoom scan resolution may be applied, respectively, for 2 GHz to 3 GHz, 3 GHz to 4 GHz and 4 GHz to 6 GHz. | | | | |

9.5 Volume Scan Procedures

The volume scan is used to assess overlapping SAR distributions for antennas transmitting in different frequency bands. It is equivalent to an oversized zoom scan used in standalone measurements. The measurement volume will be used to enclose all the simultaneous transmitting antennas. For antennas transmitting simultaneously in different frequency bands, the volume scan is measured separately in each frequency band. In order to sum correctly to compute the 1g aggregate SAR, the EUT remain in the same test position for all measurements and all volume scan use the same spatial resolution and grid spacing. When all volume scan were completed, the software, SEMCAD postprocessor can combine and subsequently superpose these measurement data to calculating the multiband SAR.

9.6 Power Drift Monitoring

All SAR testing is under the EUT install full charged battery and transmit maximum output power. In DASy measurement software, the power reference measurement and power drift measurement procedures are used for monitoring the power drift of EUT during SAR test. Both these procedures measure the field at a specified reference position before and after the SAR testing. The software will calculate the field difference in dB. If the power drifts more than 5%, the SAR will be retested.



10. Test Equipment List

| Manufacturer | Name of Equipment | Type/Model | Serial Number | Calibration | |
|---------------|---------------------------------|---------------|---------------|---------------|---------------|
| | | | | Last Cal. | Due Date |
| SPEAG | 835MHz System Validation Kit | D835V2 | 4d162 | Dec. 05, 2018 | Nov. 24, 2021 |
| SPEAG | 1750MHz System Validation Kit | D1750V2 | 1137 | Jul. 30, 2018 | Jul. 22, 2021 |
| SPEAG | 1900MHz System Validation Kit | D1900V2 | 5d182 | Dec. 07, 2018 | Nov. 24, 2021 |
| SPEAG | 2450MHz System Validation Kit | D2450V2 | 924 | Sep. 02, 2020 | Sep. 01, 2021 |
| SPEAG | 2600MHz System Validation Kit | D2600V2 | 1070 | Dec. 07, 2018 | Nov. 24, 2021 |
| SPEAG | 5000MHz System Validation Kit | D5GHzV2 | 1167 | Aug. 03, 2018 | Aug. 02, 2021 |
| SPEAG | Data Acquisition Electronics | DAE4 | 1210 | Jul. 27, 2020 | Jul. 26, 2021 |
| SPEAG | Data Acquisition Electronics | DAE4 | 1437 | Nov. 19, 2019 | Nov. 18, 2020 |
| SPEAG | Data Acquisition Electronics | DAE3 | 528 | Mar. 16, 2020 | Mar. 15, 2021 |
| SPEAG | Dosimetric E-Field Probe | EX3DV4 | 7576 | Jan. 22, 2020 | Jan. 21, 2021 |
| SPEAG | Dosimetric E-Field Probe | EX3DV4 | 3826 | May 20, 2020 | May 19, 2021 |
| SPEAG | Dosimetric E-Field Probe | ES3DV3 | 3241 | May 14, 2020 | May 13, 2021 |
| SPEAG | SAM Twin Phantom | QD 000 P40 CD | TP-1671 | NCR | NCR |
| SPEAG | SAM Twin Phantom | SAM V5.0 | 1795 | NCR | NCR |
| SPEAG | SAM Twin Phantom | SAM V4.0 | 1576 | NCR | NCR |
| SPEAG | Phone Positioner | N/A | N/A | NCR | NCR |
| Anritsu | Radio communication analyzer | MT8820C | 6201300653 | Jul. 21, 2020 | Jul. 20, 2021 |
| Anritsu | Radio communication analyzer | MT8821C | 6201588577 | Mar. 26, 2020 | Mar. 25, 2021 |
| Agilent | Wireless Communication Test Set | E5515C | MY50267224 | Jul. 21, 2020 | Jul. 20, 2021 |
| Agilent | Network Analyzer | E5071C | MY46523671 | Oct. 15, 2020 | Oct. 14, 2021 |
| Speag | Dielectric Assessment KIT | DAK-3.5 | 1138 | May 19, 2020 | May 18, 2021 |
| Agilent | Signal Generator | N5181A | MY50145381 | Dec. 26, 2019 | Dec. 25, 2020 |
| Anritsu | Power Sensor | MA2411B | 1306099 | Jul. 21, 2020 | Jul. 20, 2021 |
| Anritsu | Power Meter | ML2495A | 1349001 | Jul. 21, 2020 | Jul. 20, 2021 |
| Anritsu | Power Sensor | MA2411B | 1207253 | Dec. 26, 2019 | Dec. 25, 2020 |
| Anritsu | Power Meter | ML2495A | 1218010 | Dec. 26, 2019 | Dec. 25, 2020 |
| R&S | CBT BLUETOOTH TESTER | CBT | 100963 | Dec. 26, 2019 | Dec. 25, 2020 |
| R&S | Spectrum Analyzer | FSP7 | 100818 | Jul. 21, 2020 | Jul. 20, 2021 |
| TES | Hygrometer | 1310 | 200505600 | Jul. 30, 2020 | Jul. 29, 2021 |
| Anymetre | Thermo-Hygrometer | JR593 | 2015030904 | Jul. 21, 2020 | Jul. 20, 2021 |
| AR | Amplifier | 5S1G4 | 0333096 | Note | |
| mini-circuits | Amplifier | ZVE-3W-83+ | 599201528 | Note | |
| ARRA | Power Divider | A3200-2 | N/A | Note | |
| PASTERNAK | Dual Directional Coupler | PE2214-10 | N/A | Note | |
| Agilent | Dual Directional Coupler | 778D | 50422 | Note | |
| MCL | Attenuator 1 | BW-S10W5 | N/A | Note | |
| Weinschel | Attenuator 2 | 3M-20 | N/A | Note | |
| Zhongjilianhe | Attenuator 3 | MVE2214-03 | N/A | Note | |

Note:

1. Prior to system verification and validation, the path loss from the signal generator to the system check source and the power meter, which includes the amplifier, cable, attenuator and directional coupler, was measured by the network analyzer. The reading of the power meter was offset by the path loss difference between the path to the power meter and the path to the system check source to monitor the actual power level fed to the system check
2. Referring to KDB 865664 D01v01r04, the dipole calibration interval can be extended to 3 years with justification. The dipoles are also not physically damaged, or repaired during the interval.
3. The justification data of dipole can be found in appendix C. The return loss is < -20dB, within 20% of prior calibration, the impedance is within 5 ohm of prior calibration.

11. System Verification

11.1 Tissue Simulating Liquids

For the measurement of the field distribution inside the SAM phantom with DASY, the phantom must be filled with around 25 liters of homogeneous body tissue simulating liquid. For head SAR testing, the liquid height from the ear reference point (ERP) of the phantom to the liquid top surface is larger than 15 cm, which is shown in Fig. 11.1. For body SAR testing, the liquid height from the center of the flat phantom to the liquid top surface is larger than 15 cm, which is shown in Fig. 11.2.

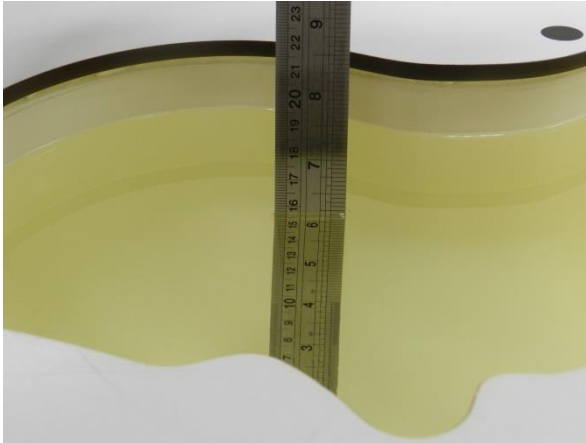

Fig 11.1 Photo of Liquid Height for Head SAR

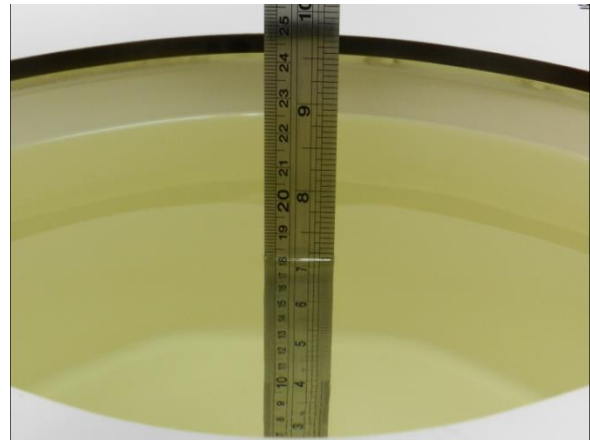

Fig 11.2 Photo of Liquid Height for Body SAR

11.2 Tissue Verification

The following tissue formulations are provided for reference only as some of the parameters have not been thoroughly verified. The composition of ingredients may be modified accordingly to achieve the desired target tissue parameters required for routine SAR evaluation.

| Frequency (MHz) | Water (%) | Sugar (%) | Cellulose (%) | Salt (%) | Preventol (%) | DGBE (%) | Conductivity (σ) | Permittivity (ϵ_r) |
|------------------|-----------|-----------|---------------|----------|---------------|----------|---------------------------|-------------------------------|
| For Head | | | | | | | | |
| 835 | 40.3 | 57.9 | 0.2 | 1.4 | 0.2 | 0 | 0.90 | 41.5 |
| 1800, 1900, 2000 | 55.2 | 0 | 0 | 0.3 | 0 | 44.5 | 1.40 | 40.0 |
| 2450 | 55.0 | 0 | 0 | 0 | 0 | 45.0 | 1.80 | 39.2 |
| 2600 | 54.8 | 0 | 0 | 0.1 | 0 | 45.1 | 1.96 | 39.0 |

Simulating Liquid for 5GHz, Manufactured by SPEAG

| Ingredients | (% by weight) |
|--------------------|---------------|
| Water | 64~78% |
| Mineral oil | 11~18% |
| Emulsifiers | 9~15% |
| Additives and Salt | 2~3% |

<Tissue Dielectric Parameter Check Results>

| Frequency (MHz) | Tissue Type | Liquid Temp. (°C) | Conductivity (σ) | Permittivity (ϵ_r) | Conductivity Target (σ) | Permittivity Target (ϵ_r) | Delta (σ) (%) | Delta (ϵ_r) (%) | Limit (%) | Date |
|-----------------|-------------|-------------------|---------------------------|-------------------------------|----------------------------------|--------------------------------------|------------------------|----------------------------|-----------|------------|
| 835 | Head | 22.4 | 0.929 | 41.793 | 0.90 | 41.50 | 3.22 | 0.71 | ±5 | 2020/11/11 |
| 835 | Head | 22.4 | 0.938 | 42.518 | 0.90 | 41.50 | 4.22 | 2.45 | ±5 | 2020/11/15 |
| 1750 | Head | 22.6 | 1.373 | 41.392 | 1.37 | 40.10 | 0.22 | 3.22 | ±5 | 2020/11/11 |
| 1750 | Head | 22.3 | 1.406 | 41.525 | 1.37 | 40.10 | 2.63 | 3.55 | ±5 | 2020/11/12 |
| 1900 | Head | 22.5 | 1.455 | 40.068 | 1.40 | 40.00 | 3.93 | 0.17 | ±5 | 2020/11/11 |
| 1900 | Head | 22.5 | 1.453 | 39.146 | 1.40 | 40.00 | 3.79 | -2.14 | ±5 | 2020/11/12 |
| 2450 | Head | 22.7 | 1.809 | 37.604 | 1.80 | 39.20 | 0.50 | -4.07 | ±5 | 2020/11/18 |
| 2600 | Head | 22.4 | 1.992 | 40.445 | 1.96 | 39.00 | 1.63 | 3.71 | ±5 | 2020/11/12 |
| 2600 | Head | 22.3 | 2.053 | 38.007 | 1.96 | 39.00 | 4.74 | -2.55 | ±5 | 2020/11/13 |
| 5250 | Head | 22.8 | 4.595 | 36.652 | 4.71 | 35.95 | -2.44 | 1.95 | ±5 | 2020/11/19 |
| 5250 | Head | 22.6 | 4.597 | 36.241 | 4.71 | 35.95 | -2.40 | 0.81 | ±5 | 2020/11/27 |
| 5600 | Head | 22.6 | 5.002 | 36.115 | 5.07 | 35.50 | -1.34 | 1.73 | ±5 | 2020/11/20 |
| 5600 | Head | 22.7 | 4.954 | 35.793 | 5.07 | 35.50 | -2.29 | 0.83 | ±5 | 2020/11/30 |
| 5750 | Head | 22.6 | 5.170 | 35.843 | 5.22 | 35.35 | -0.96 | 1.39 | ±5 | 2020/11/22 |
| 5750 | Head | 22.5 | 5.119 | 35.497 | 5.22 | 35.35 | -1.93 | 0.42 | ±5 | 2020/12/2 |

11.3 System Performance Check Results

Comparing to the original SAR value provided by SPEAG, the verification data should be within its specification of 10 %. Below table shows the target SAR and measured SAR after normalized to 1W input power. The table below indicates the system performance check can meet the variation criterion and the plots can be referred to Appendix A of this report.

<1g SAR>

| Date | Frequency (MHz) | Tissue Type | Input Power (mW) | Dipole S/N | Probe S/N | DAE S/N | Measured 1g SAR (W/kg) | Targeted 1g SAR (W/kg) | Normalized 1g SAR (W/kg) | Deviation (%) |
|------------|-----------------|-------------|------------------|------------|-----------|---------|------------------------|------------------------|--------------------------|---------------|
| 2020/11/11 | 835 | Head | 250 | 4d162 | 7576 | 528 | 2.36 | 9.61 | 9.44 | -1.77 |
| 2020/11/15 | 835 | Head | 250 | 4d162 | 3826 | 1210 | 2.52 | 9.61 | 10.08 | 4.89 |
| 2020/11/11 | 1750 | Head | 250 | 1137 | 3826 | 1210 | 9.39 | 36.50 | 37.56 | 2.90 |
| 2020/11/12 | 1750 | Head | 250 | 1137 | 3241 | 1437 | 9.66 | 36.50 | 38.64 | 5.86 |
| 2020/11/11 | 1900 | Head | 250 | 5d182 | 3826 | 1210 | 10.50 | 39.60 | 42 | 6.06 |
| 2020/11/12 | 1900 | Head | 250 | 5d182 | 3241 | 1437 | 10.60 | 39.60 | 42.4 | 7.07 |
| 2020/11/18 | 2450 | Head | 250 | 924 | 3826 | 1210 | 13.80 | 51.40 | 55.2 | 7.39 |
| 2020/11/12 | 2600 | Head | 250 | 1070 | 3826 | 1210 | 14.40 | 58.10 | 57.6 | -0.86 |
| 2020/11/13 | 2600 | Head | 250 | 1070 | 3241 | 1437 | 15.80 | 58.10 | 63.2 | 8.78 |
| 2020/11/19 | 5250 | Head | 100 | 1167 | 3826 | 1210 | 8.20 | 77.00 | 82 | 6.49 |
| 2020/11/27 | 5250 | Head | 100 | 1167 | 3826 | 1210 | 7.42 | 77.00 | 74.2 | -3.64 |
| 2020/11/20 | 5600 | Head | 100 | 1167 | 3826 | 1210 | 8.12 | 80.80 | 81.2 | 0.50 |
| 2020/11/30 | 5600 | Head | 100 | 1167 | 3826 | 1210 | 7.96 | 80.80 | 79.6 | -1.49 |
| 2020/11/22 | 5750 | Head | 100 | 1167 | 3826 | 1210 | 8.32 | 76.90 | 83.2 | 8.19 |
| 2020/12/2 | 5750 | Head | 100 | 1167 | 3826 | 1210 | 7.39 | 76.90 | 73.9 | -3.90 |

<10g SAR>

| Date | Frequency (MHz) | Tissue Type | Input Power (mW) | Dipole S/N | Probe S/N | DAE S/N | Measured 10g SAR (W/kg) | Targeted 10g SAR (W/kg) | Normalized 10g SAR (W/kg) | Deviation (%) |
|------------|-----------------|-------------|------------------|------------|-----------|---------|-------------------------|-------------------------|---------------------------|---------------|
| 2020/11/11 | 835 | Head | 250 | 4d162 | 7576 | 528 | 1.54 | 6.35 | 6.16 | -2.99 |
| 2020/11/15 | 835 | Head | 250 | 4d162 | 3826 | 1210 | 1.65 | 6.35 | 6.6 | 3.94 |
| 2020/11/11 | 1750 | Head | 250 | 1137 | 3826 | 1210 | 4.99 | 19.50 | 19.96 | 2.36 |
| 2020/11/12 | 1750 | Head | 250 | 1137 | 3241 | 1437 | 5.27 | 19.50 | 21.08 | 8.10 |
| 2020/11/11 | 1900 | Head | 250 | 5d182 | 3826 | 1210 | 5.34 | 20.70 | 21.36 | 3.19 |
| 2020/11/12 | 1900 | Head | 250 | 5d182 | 3241 | 1437 | 5.49 | 20.70 | 21.96 | 6.09 |
| 2020/11/18 | 2450 | Head | 250 | 924 | 3826 | 1210 | 6.17 | 24.00 | 24.68 | 2.83 |
| 2020/11/12 | 2600 | Head | 250 | 1070 | 3826 | 1210 | 6.17 | 26.10 | 24.68 | -5.44 |
| 2020/11/13 | 2600 | Head | 250 | 1070 | 3241 | 1437 | 6.84 | 26.10 | 27.36 | 4.83 |
| 2020/11/19 | 5250 | Head | 100 | 1167 | 3826 | 1210 | 2.28 | 22.00 | 22.8 | 3.64 |
| 2020/11/27 | 5250 | Head | 100 | 1167 | 3826 | 1210 | 2.04 | 22.00 | 20.4 | -7.27 |
| 2020/11/20 | 5600 | Head | 100 | 1167 | 3826 | 1210 | 2.22 | 23.20 | 22.2 | -4.31 |
| 2020/11/30 | 5600 | Head | 100 | 1167 | 3826 | 1210 | 2.16 | 23.20 | 21.6 | -6.90 |
| 2020/11/22 | 5750 | Head | 100 | 1167 | 3826 | 1210 | 2.35 | 21.60 | 23.5 | 8.80 |
| 2020/12/2 | 5750 | Head | 100 | 1167 | 3826 | 1210 | 2.03 | 21.60 | 20.3 | -6.02 |

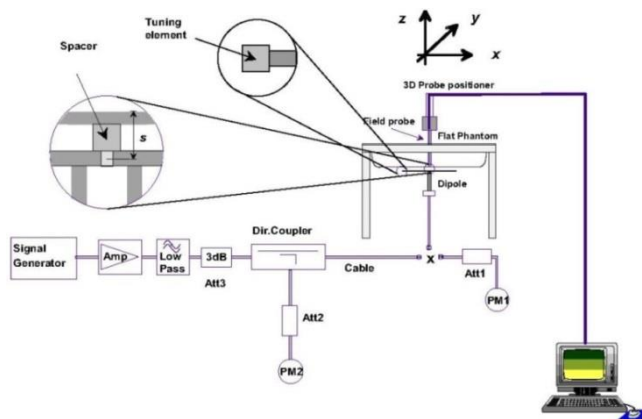

Fig 11.3.1 System Performance Check Setup



Fig 11.3.2 Setup Photo

12. RF Exposure Positions

12.1 Ear and handset reference point

Figure 12.1.1 shows the front, back, and side views of the SAM phantom. The center-of-mouth reference point is labeled “M,” the left ear reference point (ERP) is marked “LE,” and the right ERP is marked “RE.” Each ERP is 15 mm along the B-M (back-mouth) line behind the entrance-to-ear-canal (EEC) point, as shown in Figure 12.1.2 The Reference Plane is defined as passing through the two ear reference points and point M. The line N-F (neck-front), also called the reference pivoting line, is normal to the Reference Plane and perpendicular to both a line passing through RE and LE and the B-M line (see Figure 12.1.3). Both N-F and B-M lines should be marked on the exterior of the phantom shell to facilitate handset positioning. Posterior to the N-F line the ear shape is a flat surface with 6 mm thickness at each ERP, and forward of the N-F line the ear is truncated, as illustrated in Figure 12.1.2. The ear truncation is introduced to preclude the ear lobe from interfering with handset tilt, which could lead to unstable positioning at the cheek.

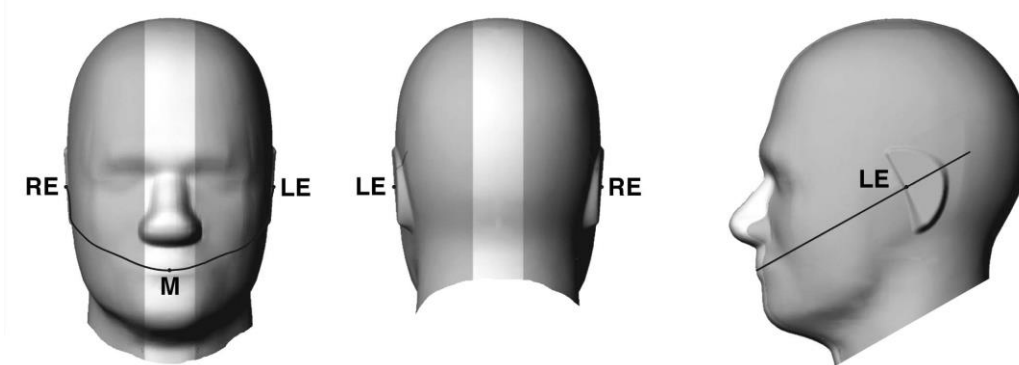

Fig 12.1.1 Front, back, and side views of SAM twin phantom

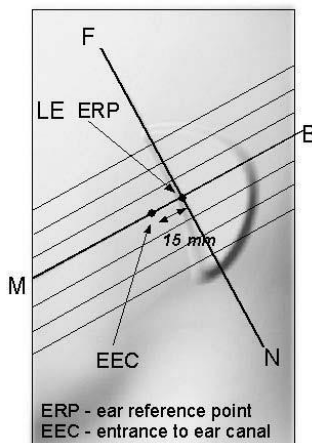

Fig 12.1.2 Close-up side view of phantom showing the ear region.

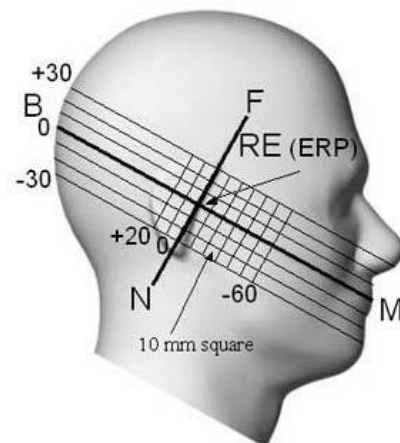

Fig 12.1.3 Side view of the phantom showing relevant markings and seven cross-sectional plane locations

12.2 Definition of the cheek position

1. Ready the handset for talk operation, if necessary. For example, for handsets with a cover piece (flip cover), open the cover. If the handset can transmit with the cover closed, both configurations must be tested.
2. Define two imaginary lines on the handset—the vertical centerline and the horizontal line. The vertical centerline passes through two points on the front side of the handset—the midpoint of the width w_t of the handset at the level of the acoustic output (point A in Figure 12.2.1 and Figure 12.2.2), and the midpoint of the width w_b of the bottom of the handset (point B). The horizontal line is perpendicular to the vertical centerline and passes through the center of the acoustic output (see Figure 12.2.1). The two lines intersect at point A. Note that for many handsets, point A coincides with the center of the acoustic output; however, the acoustic output may be located elsewhere on the horizontal line. Also note that the vertical centerline is not necessarily parallel to the front face of the handset (see Figure 12.2.2), especially for clamshell handsets, handsets with flip covers, and other irregularly-shaped handsets.
3. Position the handset close to the surface of the phantom such that point A is on the (virtual) extension of the line passing through points RE and LE on the phantom (see Figure 12.2.3), such that the plane defined by the vertical centerline and the horizontal line of the handset is approximately parallel to the sagittal plane of the phantom.
4. Translate the handset towards the phantom along the line passing through RE and LE until handset point A touches the pinna at the ERP.
5. While maintaining the handset in this plane, rotate it around the LE-RE line until the vertical centerline is in the plane normal to the plane containing B-M and N-F lines, i.e., the Reference Plane.
6. Rotate the handset around the vertical centerline until the handset (horizontal line) is parallel to the N-F line.
7. While maintaining the vertical centerline in the Reference Plane, keeping point A on the line passing through RE and LE, and maintaining the handset contact with the pinna, rotate the handset about the N-F line until any point on the handset is in contact with a phantom point below the pinna on the cheek. See Figure 12.2.3. The actual rotation angles should be documented in the test report.

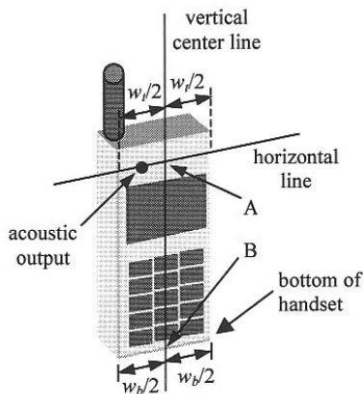

Fig 12.2.1 Handset vertical and horizontal reference lines—“fixed case”

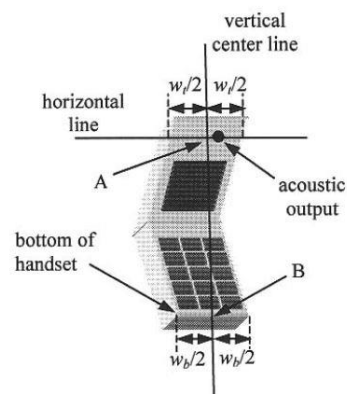

Fig 12.2.2 Handset vertical and horizontal reference lines—“clam-shell case”

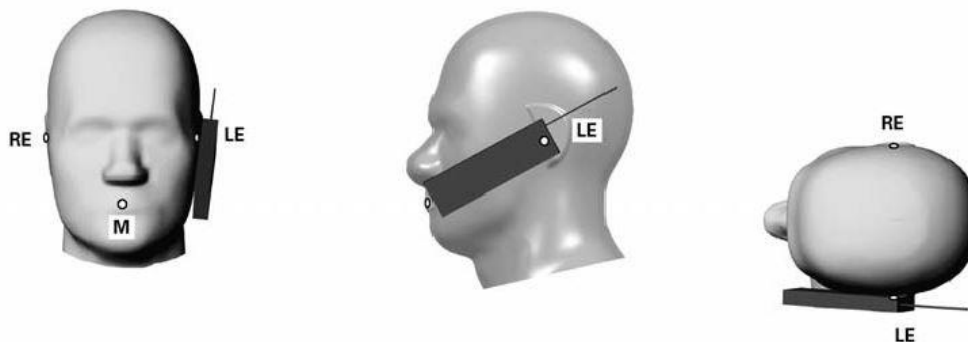

Fig 12.2.3 cheek or touch position. The reference points for the right ear (RE), left ear (LE), and mouth (M), which establish the Reference Plane for handset positioning, are indicated.

12.3 Definition of the tilt position

1. Ready the handset for talk operation, if necessary. For example, for handsets with a cover piece (flip cover), open the cover. If the handset can transmit with the cover closed, both configurations must be tested.
2. While maintaining the orientation of the handset, move the handset away from the pinna along the line passing through RE and LE far enough to allow a rotation of the handset away from the cheek by 15°.
3. Rotate the handset around the horizontal line by 15°.
4. While maintaining the orientation of the handset, move the handset towards the phantom on the line passing through RE and LE until any part of the handset touches the ear. The tilt position is obtained when the contact point is on the pinna. See Figure 12.3.1. If contact occurs at any location other than the pinna, e.g., the antenna at the back of the phantom head, the angle of the handset should be reduced. In this case, the tilt position is obtained if any point on the handset is in contact with the pinna and a second point

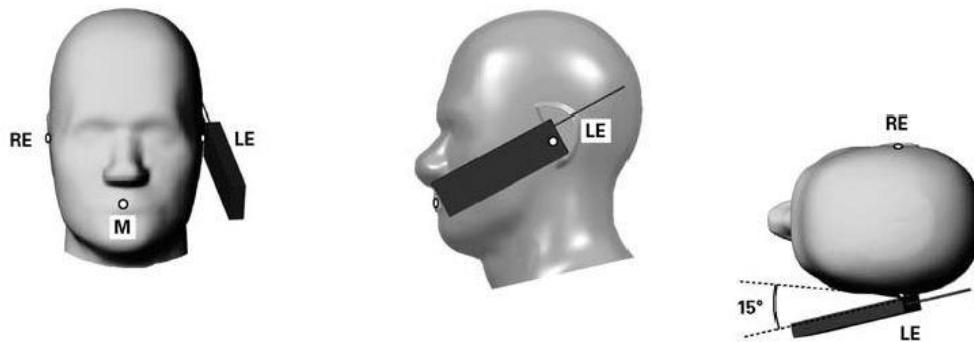

Fig 12.3.1 Tilt position. The reference points for the right ear (RE), left ear (LE), and mouth (M), which define the Reference Plane for handset positioning, are indicated.

12.4 Body Worn Accessory

Body-worn operating configurations are tested with the belt-clips and holsters attached to the device and positioned against a flat phantom in a normal use configuration (see Figure 12.4). Per KDB648474 D04v01r03, body-worn accessory exposure is typically related to voice mode operations when handsets are carried in body-worn accessories. The body-worn accessory procedures in FCC KDB 447498 D01v06 should be used to test for body-worn accessory SAR compliance, without a headset connected to it. This enables the test results for such configuration to be compatible with that required for hotspot mode when the body-worn accessory test separation distance is greater than or equal to that required for hotspot mode, when applicable. When the reported SAR for body-worn accessory, measured without a headset connected to the handset is > 1.2 W/kg, the highest reported SAR configuration for that wireless mode and frequency band should be repeated for that body-worn accessory with a headset attached to the handset.

Accessories for body-worn operation configurations are divided into two categories: those that do not contain metallic components and those that do contain metallic components. When multiple accessories that do not contain metallic components are supplied with the device, the device is tested with only the accessory that dictates the closest spacing to the body. Then multiple accessories that contain metallic components are tested with the device with each accessory. If multiple accessories share an identical metallic component (i.e. the same metallic belt-clip used with different holsters with no other metallic components) only the accessory that dictates the closest spacing to the body is tested.

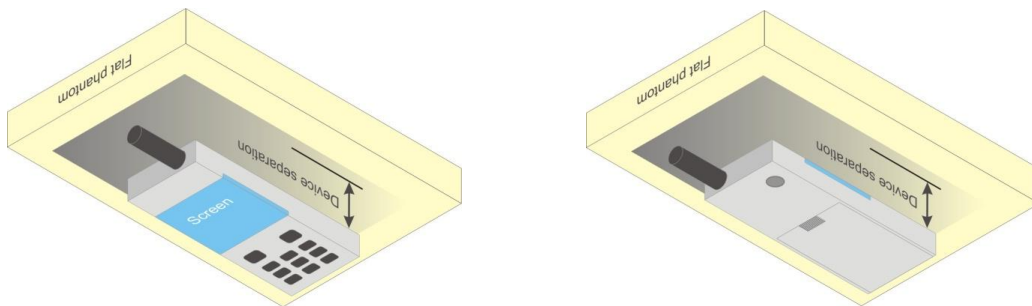

Fig 12.4 Body Worn Position

12.5 Product Specific 10g SAR Exposure

For smart phones with a display diagonal dimension > 15.0 cm or an overall diagonal dimension > 16.0 cm that provide similar mobile web access and multimedia support found in mini-tablets or UMPC mini-tablets that support voice calls next to the ear, According to KDB648474 D04v01r03, the following phablet procedures should be applied to evaluate SAR compliance for each applicable wireless modes and frequency band. Devices marketed as phablets, regardless of form factors and operating characteristics must be tested as a phablet to determine SAR compliance

1. The normally required head and body-worn accessory SAR test procedures for handsets, including hotspot mode, must be applied.
2. The UMPC mini-tablet procedures must also be applied to test the SAR of all surfaces and edges with an antenna located at ≤ 25 mm from that surface or edge, in direct contact with a flat phantom, for 10-g extremity SAR according to the body-equivalent tissue dielectric parameters in KDB 865664 to address interactive hand use exposure conditions.6 The UMPC mini-tablet 1-g SAR at 5 mm is not required. When hotspot mode applies, 10-g extremity SAR is required only for the surfaces and edges with hotspot mode 1-g reported SAR > 1.2 W/kg.

12.6 Wireless Router

Some battery-operated handsets have the capability to transmit and receive user through simultaneous transmission of WIFI simultaneously with a separate licensed transmitter. The FCC has provided guidance in FCC KDB Publication 941225 D06 v02r01 where SAR test considerations for handsets ($L \times W \geq 9$ cm x 5 cm) are based on a composite test separation distance of 10mm from the front, back and edges of the device containing transmitting antennas within 2.5cm of their edges, determined from general mixed use conditions for this type of devices. Since the hotspot SAR results may overlap with the body-worn accessory SAR requirements, the more conservative configurations can be considered, thus excluding some body-worn accessory SAR tests.

When the user enables the personal wireless router functions for the handset, actual operations include simultaneous transmission of both the WIFI transmitter and another licensed transmitter. Both transmitters often do not transmit at the same transmitting frequency and thus cannot be evaluated for SAR under actual use conditions due to the limitations of the SAR assessment probes. Therefore, SAR must be evaluated for each frequency transmission and mode separately and spatially summed with the WIFI transmitter according to FCC KDB Publication 447498 D01v06 publication procedures. The "Portable Hotspot" feature on the handset was NOT activated during SAR assessments, to ensure the SAR measurements were evaluated for a single transmission frequency RF signal at a time.

13. Conducted RF Output Power (Unit: dBm)

The detailed conducted power table can refer to Appendix E.

<GSM Conducted Power>

1. Per KDB 447498 D01v06, the maximum output power channel is used for SAR testing and for further SAR test reduction.
2. Per KDB 941225 D01v03r01, for SAR test reduction for GSM / GPRS / EDGE modes is determined by the source-based time-averaged output power including tune-up tolerance. The mode with highest specified time-averaged output power should be tested for SAR compliance in the applicable exposure conditions. For modes with the same specified maximum output power and tolerance, the higher number time-slot configuration should be tested. Therefore, the GPRS 2Tx slots for GSM850/GSM1900 are considered as the primary mode.
3. Other configurations of GSM / GPRS / EDGE are considered as secondary modes. The 3G SAR test reduction procedure is applied, when the maximum output power and tune-up tolerance specified for production units in a secondary mode is $\leq 1/4$ dB higher than the primary mode, SAR measurement is not required for the secondary mode.

<WCDMA Conducted Power>

1. The following tests were conducted according to the test requirements outlines in 3GPP TS 34.121 specification.
2. The procedures in KDB 941225 D01v03r01 are applied for 3GPP Rel. 6 HSPA to configure the device in the required sub-test mode(s) to determine SAR test exclusion.
3. For DC-HSDPA, the device was configured according to the H-Set 12, Fixed Reference Channel (FRC) configuration in Table C.8.1.12 of 3GPP TS 34.121-1, with the primary and the secondary serving HS-DSCH Cell enabled during the power measurement.

A summary of these settings are illustrated below:

HSDPA Setup Configuration:

- a. The EUT was connected to Base Station Agilent E5515C referred to the Setup Configuration.
- b. The RF path losses were compensated into the measurements.
- c. A call was established between EUT and Base Station with following setting:
 - i. Set Gain Factors (β_c and β_d) and parameters were set according to each
 - ii. Specific sub-test in the following table, C10.1.4, quoted from the TS 34.121
 - iii. Set RMC 12.2Kbps + HSDPA mode.
 - iv. Set Cell Power = -86 dBm
 - v. Set HS-DSCH Configuration Type to FRC (H-set 1, QPSK)
 - vi. Select HSDPA Uplink Parameters
 - vii. Set Delta ACK, Delta NACK and Delta CQI = 8
 - viii. Set Ack-Nack Repetition Factor to 3
 - ix. Set CQI Feedback Cycle (k) to 4 ms
 - x. Set CQI Repetition Factor to 2
 - xi. Power Ctrl Mode = All Up bits
- d. The transmitted maximum output power was recorded.

Table C.10.1.4: β values for transmitter characteristics tests with HS-DPCCH

| Sub-test | β_c | β_d | β_d (SF) | β_c/β_d | β_{HS} (Note 1, Note 2) | CM (dB) (Note 3) | MPR (dB) (Note 3) |
|----------|-------------------|-------------------|-------------------|-------------------|-------------------------------------|---------------------|----------------------|
| 1 | 2/15 | 15/15 | 64 | 2/15 | 4/15 | 0.0 | 0.0 |
| 2 | 12/15 (Note 4) | 15/15 (Note 4) | 64 | 12/15 (Note 4) | 24/15 | 1.0 | 0.0 |
| 3 | 15/15 | 8/15 | 64 | 15/8 | 30/15 | 1.5 | 0.5 |
| 4 | 15/15 | 4/15 | 64 | 15/4 | 30/15 | 1.5 | 0.5 |

Note 1: Δ_{ACK} , Δ_{NACK} and $\Delta_{CQI} = 30/15$ with $\beta_{HS} = 30/15 * \beta_c$.

Note 2: For the HS-DPCCH power mask requirement test in clause 5.2C, 5.7A, and the Error Vector Magnitude (EVM) with HS-DPCCH test in clause 5.13.1A, and HSDPA EVM with phase discontinuity in clause 5.13.1AA, Δ_{ACK} and $\Delta_{NACK} = 30/15$ with $\beta_{HS} = 30/15 * \beta_c$, and $\Delta_{CQI} = 24/15$ with $\beta_{HS} = 24/15 * \beta_c$.

Note 3: CM = 1 for $\beta_c/\beta_d = 12/15$, $\beta_{HS}/\beta_c = 24/15$. For all other combinations of DPDCCH, DPCCH and HS-DPCCH the MPR is based on the relative CM difference. This is applicable for only UEs that support HSDPA in release 6 and later releases.

Note 4: For subtest 2 the β_c/β_d ratio of 12/15 for the TFC during the measurement period (TF1, TF0) is achieved by setting the signalled gain factors for the reference TFC (TF1, TF1) to $\beta_c = 11/15$ and $\beta_d = 15/15$.

Setup Configuration

HSUPA Setup Configuration:

- a. The EUT was connected to Base Station Agilent E5515C referred to the Setup Configuration.
- b. The RF path losses were compensated into the measurements.
- c. A call was established between EUT and Base Station with following setting * :
 - i. Call Configs = 5.2B, 5.9B, 5.10B, and 5.13.2B with QPSK
 - ii. Set the Gain Factors (β_c and β_d) and parameters (AG Index) were set according to each specific sub-test in the following table, C11.1.3, quoted from the TS 34.121
 - iii. Set Cell Power = -86 dBm
 - iv. Set Channel Type = 12.2k + HSPA
 - v. Set UE Target Power
 - vi. Power Ctrl Mode= Alternating bits
 - vii. Set and observe the E-TFCI
 - viii. Confirm that E-TFCI is equal to the target E-TFCI of 75 for sub-test 1, and other subtest's E-TFCI
- d. The transmitted maximum output power was recorded.

Table C.11.1.3: β values for transmitter characteristics tests with HS-DPCCH and E-DCH

| Sub-test | β_c | β_d | β_d (SF) | β_c/β_d | β_{HS} (Note1) | β_{ec} | β_{ed} (Note 4) (Note 5) | β_{ed} (SF) | β_{ed} (Codes) | CM (dB) (Note 2) | MPR (dB) (Note 2) (Note 6) | AG Index (Note 5) | E-TFCI |
|----------|----------------|----------------|----------------|-------------------|----------------------|--------------|--|-------------------|----------------------|------------------|----------------------------|-------------------|--------|
| 1 | 11/15 (Note 3) | 15/15 (Note 3) | 64 | 11/15 (Note 3) | 22/15 | 209/25 | 1309/225 | 4 | 1 | 1.0 | 0.0 | 20 | 75 |
| 2 | 6/15 | 15/15 | 64 | 6/15 | 12/15 | 12/15 | 94/75 | 4 | 1 | 3.0 | 2.0 | 12 | 67 |
| 3 | 15/15 | 9/15 | 64 | 15/9 | 30/15 | 30/15 | β_{ed1} : 47/15 β_{ed2} : 47/15 | 4 4 | 2 | 2.0 | 1.0 | 15 | 92 |
| 4 | 2/15 | 15/15 | 64 | 2/15 | 4/15 | 2/15 | 56/75 | 4 | 1 | 3.0 | 2.0 | 17 | 71 |
| 5 | 15/15 | 0 | - | - | 5/15 | 5/15 | 47/15 | 4 | 1 | 1.0 | 0.0 | 12 | 67 |

Note 1: For sub-test 1 to 4, Δ_{ACK} , Δ_{NACK} and $\Delta_{CQI} = 30/15$ with $\beta_{hs} = 30/15 * \beta_c$. For sub-test 5, Δ_{ACK} , Δ_{NACK} and $\Delta_{CQI} = 5/15$ with $\beta_{hs} = 5/15 * \beta_c$.

Note 2: CM = 1 for $\beta_c/\beta_d = 12/15$, $\beta_{hs}/\beta_c = 24/15$. For all other combinations of DPDCH, DPCCH, HS- DPCCH, E-DPDCH and E-DPCCH the MPR is based on the relative CM difference.

Note 3: For subtest 1 the β_c/β_d ratio of 11/15 for the TFC during the measurement period (TF1, TF0) is achieved by setting the signalled gain factors for the reference TFC (TF1, TF1) to $\beta_c = 10/15$ and $\beta_d = 15/15$.

Note 4: In case of testing by UE using E-DPDCH Physical Layer category 1, Sub-test 3 is omitted according to TS25.306 Table 5.1g.

Note 5: β_{ed} can not be set directly; it is set by Absolute Grant Value.

Note 6: For subtests 2, 3 and 4, UE may perform E-DPDCH power scaling at max power which could results in slightly smaller MPR values.

Setup Configuration

DC-HSDPA 3GPP release 8 Setup Configuration:

- a. The EUT was connected to Base Station referred to the Setup Configuration below
- b. The RF path losses were compensated into the measurements.
- c. A call was established between EUT and Base Station with following setting:
 - i. Set RMC 12.2Kbps + HSDPA mode.
 - ii. Set Cell Power = -25 dBm
 - iii. Set HS-DSCH Configuration Type to FRC (H-set 12, QPSK)
 - iv. Select HSDPA Uplink Parameters
 - v. Set Gain Factors (β_c and β_d) and parameters were set according to each Specific sub-test in the following table, C10.1.4, quoted from the TS 34.121
 - a). Subtest 1: $\beta_c/\beta_d=2/15$
 - b). Subtest 2: $\beta_c/\beta_d=12/15$
 - c). Subtest 3: $\beta_c/\beta_d=15/8$
 - d). Subtest 4: $\beta_c/\beta_d=15/4$
 - vi. Set Delta ACK, Delta NACK and Delta CQI = 8
 - vii. Set Ack-Nack Repetition Factor to 3
 - viii. Set CQI Feedback Cycle (k) to 4 ms
 - ix. Set CQI Repetition Factor to 2
 - x. Power Ctrl Mode = All Up bits
- d. The transmitted maximum output power was recorded.

The following tests were conducted according to the test requirements outlines in 3GPP TS 34.121 specification. A summary of these settings are illustrated below:

C.8.1.12 Fixed Reference Channel Definition H-Set 12

Table C.8.1.12: Fixed Reference Channel H-Set 12

| Parameter | Unit | Value |
|--|-----------|-------|
| Nominal Avg. Inf. Bit Rate | kbps | 60 |
| Inter-TTI Distance | TTI's | 1 |
| Number of HARQ Processes | Processes | 6 |
| Information Bit Payload (N_{INF}) | Bits | 120 |
| Number Code Blocks | Blocks | 1 |
| Binary Channel Bits Per TTI | Bits | 960 |
| Total Available SML's in UE | SML's | 19200 |
| Number of SML's per HARQ Proc. | SML's | 3200 |
| Coding Rate | | 0.15 |
| Number of Physical Channel Codes | Codes | 1 |
| Modulation | | QPSK |
| Note 1: The RMC is intended to be used for DC-HSDPA mode and both cells shall transmit with identical parameters as listed in the table. Note 2: Maximum number of transmission is limited to 1, i.e., retransmission is not allowed. The redundancy and constellation version 0 shall be used. | | |

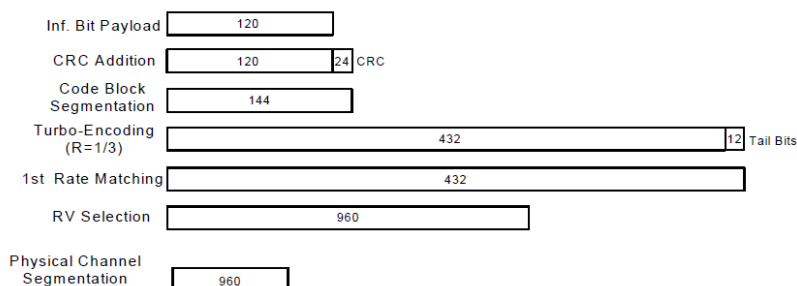

Figure C.8.19: Coding rate for Fixed reference Channel H-Set 12 (QPSK)

Setup Configuration



<WCDMA Conducted Power>

General Note:

1. Per KDB 941225 D01v03r01, for SAR testing is measured using a 12.2 kbps RMC with TPC bits configured to all "1's".
2. Per KDB 941225 D01v03r01, RMC 12.2kbps setting is used to evaluate SAR. The maximum output power and tune-up tolerance specified for production units in HSDPA / HSUPA / DC-HSDPA is $\leq \frac{1}{4}$ dB higher than RMC 12.2Kbps or when the highest reported SAR of the RMC12.2Kbps is scaled by the ratio of specified maximum output power and tune-up tolerance of HSDPA / HSUPA / DC-HSDPA to RMC12.2Kbps and the adjusted SAR is ≤ 1.2 W/kg, SAR measurement is not required for HSDPA / HSUPA / DC-HSDPA, and according to the following RF output power, the output power results of the secondary modes (HSDPA / HSUPA / DC-HSDPA) are less than $\frac{1}{4}$ dB higher than the primary modes; therefore, SAR measurement is not required for HSDPA / HSUPA / DC-HSDPA

<LTE Conducted Power>

General Note:

1. Anritsu MT8820C base station simulator was used to setup the connection with EUT; the frequency band, channel bandwidth, RB allocation configuration, modulation type are set in the base station simulator to configure EUT transmitting at maximum power and at different configurations which are requested to be reported to FCC, for conducted power measurement and SAR testing.
2. Per KDB 941225 D05v02r05, when a properly configured base station simulator is used for the SAR and power measurements, spectrum plots for each RB allocation and offset configuration is not required.
3. Per KDB 941225 D05v02r05, start with the largest channel bandwidth and measure SAR for QPSK with 1 RB allocation, using the RB offset and required test channel combination with the highest maximum output power for RB offsets at the upper edge, middle and lower edge of each required test channel.
4. Per KDB 941225 D05v02r05, 50% RB allocation for QPSK SAR testing follows 1RB QPSK allocation procedure.
5. Per KDB 941225 D05v02r05, for QPSK with 100% RB allocation, SAR is not required when the highest maximum output power for 100 % RB allocation is less than the highest maximum output power in 50% and 1 RB allocations and the highest reported SAR for 1 RB and 50% RB allocation are ≤ 0.8 W/kg. Otherwise, SAR is measured for the highest output power channel; and if the reported SAR is > 1.45 W/kg, the remaining required test channels must also be tested.
6. Per KDB 941225 D05v02r05, 16QAM/64QAM output power for each RB allocation configuration is $>$ not $\frac{1}{2}$ dB higher than the same configuration in QPSK and the reported SAR for the QPSK configuration is ≤ 1.45 W/kg; Per KDB 941225 D05v02r05, 16QAM/64QAM SAR testing is not required.
7. Per KDB 941225 D05v02r05, smaller bandwidth output power for each RB allocation configuration is $>$ not $\frac{1}{2}$ dB higher than the same configuration in the largest supported bandwidth, and the reported SAR for the largest supported bandwidth is ≤ 1.45 W/kg; Per KDB 941225 D05v02r05, smaller bandwidth SAR testing is not required.
8. For LTE B4 / B5 the maximum bandwidth does not support three non-overlapping channels, per KDB 941225 D05v02r05, when a device supports overlapping channel assignment in a channel bandwidth configuration, the middle channel of the group of overlapping channels should be selected for testing.
9. LTE B4 SAR test was covered by B66; according to April 2015 TCB workshop, SAR test for overlapping LTE bands can be reduced if
 - a. the maximum output power, including tolerance, for the smaller band is \leq the larger band to qualify for the SAR test exclusion
 - b. the channel bandwidth and other operating parameters for the smaller band are fully supported by the larger band
10. According to 2017 TCB workshop, for 64 QAM and 16 QAM should be verified by checking the signal constellation with a call box to avoid incorrect maximum power levels due to MPR and other requirements associated with signal modulation, and the following figure is taken from the "Fundamental Measurement >> Modulation Analysis >> constellation" mode of the device connect to the MT8821C base station, therefore, the device 64QAM and 16QAM signal modulation are correct.

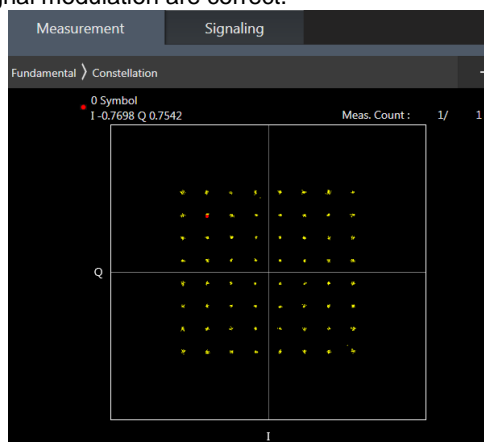

64QAM



16QAM

<WLAN Conducted Power>

General Note:

1. Per KDB 248227 D01v02r02, SAR test reduction is determined according to 802.11 transmission mode configurations and certain exposure conditions with multiple test positions. In the 2.4 GHz band, separate SAR procedures are applied to DSSS and OFDM configurations to simplify DSSS test requirements. For OFDM, in both 2.4 and 5 GHz bands, an initial test configuration must be determined for each standalone and aggregated frequency band, according to the transmission mode configuration with the highest maximum output power specified for production units to perform SAR measurements. If the same highest maximum output power applies to different combinations of channel bandwidths, modulations and data rates, additional procedures are applied to determine which test configurations require SAR measurement. When applicable, an initial test position may be applied to reduce the number of SAR measurements required for next to the ear, UMPC mini-tablet or hotspot mode configurations with multiple test positions.
2. For 2.4 GHz 802.11b DSSS, either the initial test position procedure for multiple exposure test positions or the DSSS procedure for fixed exposure position is applied; these are mutually exclusive. For 2.4 GHz and 5 GHz OFDM configurations, the initial test configuration is applied to measure SAR using either the initial test position procedure for multiple exposure test position configurations or the initial test configuration procedures for fixed exposure test conditions. Based on the reported SAR of the measured configurations and maximum output power of the transmission mode configurations that are not included in the initial test configuration, the subsequent test configuration and initial test position procedures are applied to determine if SAR measurements are required for the remaining OFDM transmission configurations. In general, the number of test channels that require SAR measurement is minimized based on maximum output power measured for the test sample(s).
3. For OFDM transmission configurations in the 2.4 GHz and 5 GHz bands, When the same maximum power is specified for multiple transmission modes in a frequency band, the largest channel bandwidth, lowest order modulation, lowest data rate and lowest order 802.11a/g/n/ac mode is used for SAR measurement, on the highest measured output power channel for each frequency band.
4. DSSS and OFDM configurations are considered separately according to the required SAR procedures. SAR is measured in the initial test position using the 802.11 transmission mode configuration required by the DSSS procedure or initial test configuration and subsequent test configuration(s) according to the OFDM procedures.18 The initial test position procedure is described in the following:
 - a. When the reported SAR of the initial test position is ≤ 0.4 W/kg, further SAR measurement is not required for the other test positions in that exposure configuration and 802.11 transmission mode combinations within the frequency band or aggregated band.
 - b. When the reported SAR of the test position is > 0.4 W/kg, SAR is repeated for the 802.11 transmission mode configuration tested in the initial test position to measure the subsequent next closet/smallest test separation distance and maximum coupling test position on the highest maximum output power channel, until the report SAR is ≤ 0.8 W/kg or all required test position are tested.
 - c. For all positions/configurations, when the reported SAR is > 0.8 W/kg, SAR is measured for these test positions/configurations on the subsequent next highest measured output power channel(s) until the reported SAR is ≤ 1.2 W/kg or all required channels are tested.



<2.4GHz Bluetooth>

General Note:

1. For 2.4GHz Bluetooth SAR testing was selected 1Mbps, due to its highest average power.
2. The Bluetooth duty cycle is 77.36 % as following figure, according to 2016 Oct. TCB workshop for Bluetooth SAR scaling need further consideration and the maximum duty cycle is 100%, therefore the actual duty cycle will be scaled up to100% for Bluetooth reported SAR calculation

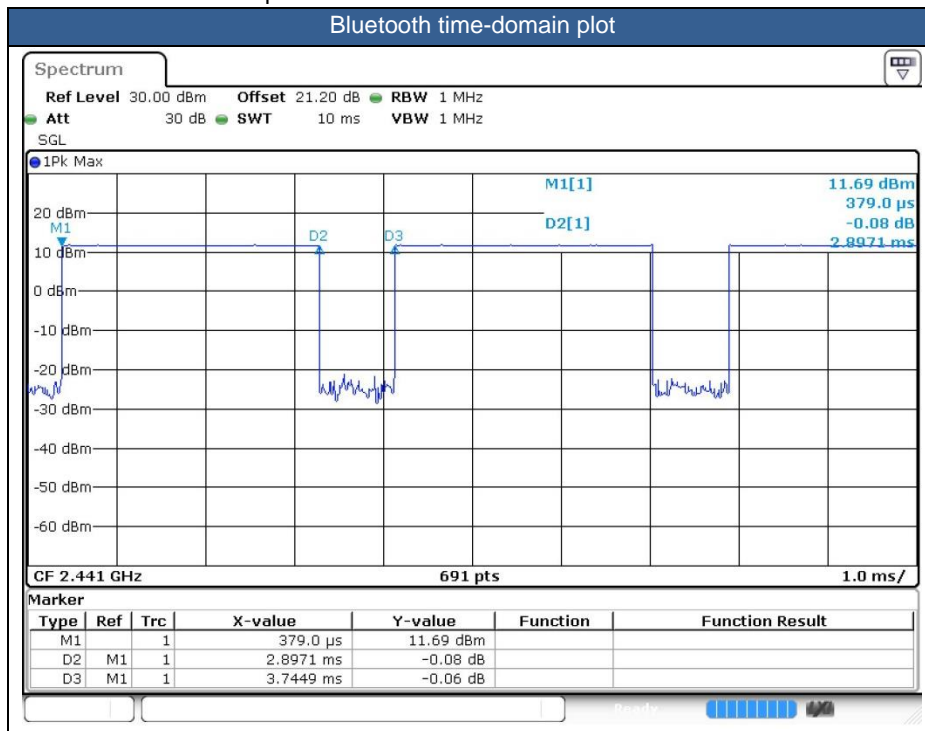



14. Antenna Location

The detailed antenna location information can refer to SAR Test Setup Photos.

15. SAR Test Results

General Note:

1. Per KDB 447498 D01v06, the reported SAR is the measured SAR value adjusted for maximum tune-up tolerance.
 - a. Tune-up scaling Factor = tune-up limit power (mW) / EUT RF power (mW), where tune-up limit is the maximum rated power among all production units.
 - b. For SAR testing of WLAN/Bluetooth signal with non-100% duty cycle, the measured SAR is scaled-up by the duty cycle scaling factor which is equal to "1/(duty cycle)"
 - c. For WWAN: Reported SAR(W/kg)= Measured SAR(W/kg)*Tune-up Scaling Factor
 - d. For BT/WLAN: Reported SAR(W/kg)= Measured SAR(W/kg)* Duty Cycle scaling factor * Tune-up scaling factor
2. Per KDB 447498 D01v06, for each exposure position, testing of other required channels within the operating mode of a frequency band is not required when the *reported* 1-g or 10-g SAR for the mid-band or highest output power channel is:
 - ≤ 0.8 W/kg or 2.0 W/kg, for 1-g or 10-g respectively, when the transmission band is ≤ 100 MHz
 - ≤ 0.6 W/kg or 1.5 W/kg, for 1-g or 10-g respectively, when the transmission band is between 100 MHz and 200 MHz
 - ≤ 0.4 W/kg or 1.0 W/kg, for 1-g or 10-g respectively, when the transmission band is ≥ 200 MHz
3. Per KDB 865664 D01v01r04, for each frequency band, repeated SAR measurement is required when the measured SAR is ≥ 0.8 W/kg. Per KDB 865664 D01v01r04, if the extremity repeated SAR is necessary, the same procedures should be adapted for measurements according to extremity and occupational exposure limits by applying a factor of 2.5 for extremity exposure and a factor of 5 for occupational exposure to the corresponding SAR thresholds.
4. Per KDB648474 D04v01r03, when the reported SAR for a body-worn accessory, measured without a headset connected to the handset, is > 1.2 W/kg, the highest reported SAR configuration for that wireless mode and frequency band should be repeated for that body-worn accessory with a headset attached to the handset. When headset SAR is less than or equal than without headset SAR, no need to verify the remaining channels for headset SAR.
5. The device implements Proximity sensors/receiver detect mechanism/hotspot trigger reduced power for the power management for SAR compliance at different exposure conditions (head, body-worn, hotspot, extremity).
6. The device will invoke corresponding work scenarios power level, which are provided in the operational description.
7. For Some WWAN bands, sensor on reduced power level higher than hotspot reduced power level, so front/back sensor on SAR can represent hotspot conservatively.
8. Per KDB648474 D04v01r03, for smart phones with a display diagonal dimension > 15.0 cm or an overall diagonal dimension > 16.0 cm, when hotspot mode applies, 10-g extremity SAR is required only for the surfaces and edges with hotspot mode 1-g reported SAR > 1.2 W/kg, however, when power reduction applies to hotspot mode the measured SAR must be scaled to the maximum output power (for handheld on state, the maximum full power means reduced power), including tolerance, allowed for phablet modes to compare with the 1.2 W/kg SAR test reduction threshold.
 - a. For this device SAR for WWAN transmitter scaled to maximum output power mode for product specific 10g SAR is higher than 1.2W/kg of GSM850/1900, WCDMA Band II/IV/V, LTE Band 2/4/5/7/66 therefore product specific 10g SAR is necessary.
 - b. WLAN 5.3/5.5GHz tested the product specific 10g SAR since it has no hotspot mode.
 - c. When 10-g product specific 10g SAR is considered, SAR thresholds is specified in the procedures for SAR test reduction and exclusion should be multiplied by 2.5.
9. The device has five headsets, only supplier is different, so we chose headset 1 to perform full SAR testing, and headset 2/3/4/5 only verified the worst case of headset 1.
10. For verification of compliance of power reduction scheme, additional SAR testing with EUT transmitting at full RF power at a conservative trigger distance was performed for body worn:
Front: [12 mm](#)
Back: [20 mm](#)
11. For verification of compliance of power reduction scheme, additional SAR testing with EUT transmitting at full RF power at a conservative trigger distance was performed for handheld:
Front: [9 mm](#)
Back: [13 mm](#)
Bottom side: [10 mm](#)

GSM Note:

1. Per KDB 941225 D01v03r01, for SAR test reduction for GSM / GPRS / EDGE modes is determined by the source-based time-averaged output power including tune-up tolerance. The mode with highest specified time-averaged output power should be tested for SAR compliance in the applicable exposure conditions. For modes with the same specified maximum output power and tolerance, the higher number time-slot configuration should be tested. Therefore, the GPRS 2Tx slots for GSM850/GSM1900 are considered as the primary mode.
2. Other configurations of GSM / GPRS / EDGE are considered as secondary modes. The 3G SAR test reduction procedure is applied, when the maximum output power and tune-up tolerance specified for production units in a secondary mode is \leq ¼ dB higher than the primary mode, SAR measurement is not required for the secondary mode.

WCDMA Note:

1. Per KDB 941225 D01v03r01, for SAR testing is measured using a 12.2 kbps RMC with TPC bits configured to all "1's".
2. Per KDB 941225 D01v03r01, RMC 12.2kbps setting is used to evaluate SAR. The maximum output power and tune-up tolerance specified for production units in HSDPA / HSUPA / DC-HSDPA is \leq ¼ dB higher than RMC 12.2Kbps or when the highest reported SAR of the RMC12.2Kbps is scaled by the ratio of specified maximum output power and tune-up tolerance of HSDPA / HSUPA / DC-HSDPA to RMC12.2Kbps and the adjusted SAR is \leq 1.2 W/kg, SAR measurement is not required for HSDPA / HSUPA / DC-HSDPA, and according to the following RF output power, the output power results of the secondary modes (HSDPA / HSUPA / DC-HSDPA) are less than ¼ dB higher than the primary modes; therefore, SAR measurement is not required for HSDPA / HSUPA / DC-HSDPA.

LTE Note:

1. Per KDB 941225 D05v02r05, start with the largest channel bandwidth and measure SAR for QPSK with 1 RB allocation, using the RB offset and required test channel combination with the highest maximum output power for RB offsets at the upper edge, middle and lower edge of each required test channel.
2. Per KDB 941225 D05v02r05, 50% RB allocation for QPSK SAR testing follows 1RB QPSK allocation procedure.
3. Per KDB 941225 D05v02r05, for QPSK with 100% RB allocation, SAR is not required when the highest maximum output power for 100 % RB allocation is less than the highest maximum output power in 50% and 1 RB allocations and the highest reported SAR for 1 RB and 50% RB allocation are \leq 0.8 W/kg. Otherwise, SAR is measured for the highest output power channel; and if the reported SAR is $>$ 1.45 W/kg, the remaining required test channels must also be tested.
4. Per KDB 941225 D05v02r05, 16QAM/64QAM output power for each RB allocation configuration is $>$ not ½ dB higher than the same configuration in QPSK and the reported SAR for the QPSK configuration is \leq 1.45 W/kg; Per KDB 941225 D05v02r05, 16QAM/64QAM SAR testing is not required.
5. Per KDB 941225 D05v02r05, smaller bandwidth output power for each RB allocation configuration is $>$ not ½ dB higher than the same configuration in the largest supported bandwidth, and the reported SAR for the largest supported bandwidth is \leq 1.45 W/kg; Per KDB 941225 D05v02r05, smaller bandwidth SAR testing is not required.
6. For LTE B4 / B5 the maximum bandwidth does not support three non-overlapping channels, per KDB 941225 D05v02r05, when a device supports overlapping channel assignment in a channel bandwidth configuration, the middle channel of the group of overlapping channels should be selected for testing.
7. LTE B4 SAR test was covered by LTE B66; according to April 2015 TCB workshop, SAR test for overlapping LTE bands can be reduced if
 - a. the maximum output power, including tolerance, for the smaller band is \leq the larger band to qualify for the SAR test exclusion
 - b. the channel bandwidth and other operating parameters for the smaller band are fully supported by the larger band



WLAN Note:

1. Per KDB 248227 D01v02r02, for 2.4GHz 802.11g/n SAR testing is not required when the highest reported SAR for DSSS is adjusted by the ratio of OFDM to DSSS specified maximum output power and the adjusted SAR is ≤ 1.2 W/kg.
2. Per KDB 248227 D01v02r02, U-NII-1 SAR testing is not required when the U-NII-2A band highest reported SAR for a test configuration is ≤ 1.2 W/kg, SAR is not required for U-NII-1 band.
3. When the reported SAR of the test position is > 0.4 W/kg, SAR is repeated for the 802.11 transmission mode configuration tested in the initial test position to measure the subsequent next closet/smallest test separation distance and maximum coupling test position on the highest maximum output power channel, until the report SAR is ≤ 0.8 W/kg or all required test position are tested.
4. For all positions / configurations, when the reported SAR is > 0.8 W/kg, SAR is measured for these test positions / configurations on the subsequent next highest measured output power channel(s) until the reported SAR is ≤ 1.2 W/kg or all required channels are tested.
5. During SAR testing the WLAN transmission was verified using a spectrum analyzer.



15.1 Head SAR

<GSM SAR>

| Plot No. | Band | Mode | Test Position | Power Reduction | Ch. | Freq. (MHz) | Average Power (dBm) | Tune-Up Limit (dBm) | Tune-up Scaling Factor | Power Drift (dB) | Measured 1g SAR (W/kg) | Reported 1g SAR (W/kg) |
|----------|---------|------------------|---------------|-----------------|-----|-------------|---------------------|---------------------|------------------------|------------------|------------------------|------------------------|
| 01 | GSM850 | GPRS(2 Tx slots) | Right Cheek | Full | 251 | 848.8 | 31.09 | 32.00 | 1.233 | 0.05 | 0.402 | 0.496 |
| | GSM850 | GPRS(2 Tx slots) | Right Tilted | Full | 251 | 848.8 | 31.09 | 32.00 | 1.233 | 0.07 | 0.210 | 0.259 |
| | GSM850 | GPRS(2 Tx slots) | Left Cheek | Full | 251 | 848.8 | 31.09 | 32.00 | 1.233 | -0.05 | 0.390 | 0.481 |
| | GSM850 | GPRS(2 Tx slots) | Left Tilted | Full | 251 | 848.8 | 31.09 | 32.00 | 1.233 | -0.05 | 0.219 | 0.270 |
| | GSM1900 | GPRS(2 Tx slots) | Right Cheek | Full | 661 | 1880 | 28.25 | 29.50 | 1.334 | -0.08 | 0.189 | 0.252 |
| | GSM1900 | GPRS(2 Tx slots) | Right Tilted | Full | 661 | 1880 | 28.25 | 29.50 | 1.334 | 0.05 | 0.105 | 0.140 |
| 02 | GSM1900 | GPRS(2 Tx slots) | Left Cheek | Full | 661 | 1880 | 28.25 | 29.50 | 1.334 | 0.13 | 0.216 | 0.288 |
| | GSM1900 | GPRS(2 Tx slots) | Left Tilted | Full | 661 | 1880 | 28.25 | 29.50 | 1.334 | -0.12 | 0.161 | 0.215 |

<WCDMA SAR>

| Plot No. | Band | Mode | Test Position | Power Reduction | Ch. | Freq. (MHz) | Average Power (dBm) | Tune-Up Limit (dBm) | Tune-up Scaling Factor | Power Drift (dB) | Measured 1g SAR (W/kg) | Reported 1g SAR (W/kg) |
|----------|----------|--------------|---------------|-----------------|------|-------------|---------------------|---------------------|------------------------|------------------|------------------------|------------------------|
| 03 | WCDMA V | RMC 12.2Kbps | Right Cheek | Full | 4182 | 836.4 | 23.13 | 24.00 | 1.222 | 0.01 | 0.366 | 0.447 |
| | WCDMA V | RMC 12.2Kbps | Right Tilted | Full | 4182 | 836.4 | 23.13 | 24.00 | 1.222 | -0.07 | 0.196 | 0.239 |
| | WCDMA V | RMC 12.2Kbps | Left Cheek | Full | 4182 | 836.4 | 23.13 | 24.00 | 1.222 | 0.07 | 0.333 | 0.407 |
| | WCDMA V | RMC 12.2Kbps | Left Tilted | Full | 4182 | 836.4 | 23.13 | 24.00 | 1.222 | -0.05 | 0.197 | 0.241 |
| 04 | WCDMA IV | RMC 12.2Kbps | Right Cheek | Full | 1413 | 1732.6 | 23.04 | 24.00 | 1.247 | 0.18 | 0.257 | 0.321 |
| | WCDMA IV | RMC 12.2Kbps | Right Tilted | Full | 1413 | 1732.6 | 23.04 | 24.00 | 1.247 | -0.07 | 0.101 | 0.126 |
| | WCDMA IV | RMC 12.2Kbps | Left Cheek | Full | 1413 | 1732.6 | 23.04 | 24.00 | 1.247 | 0.01 | 0.183 | 0.228 |
| | WCDMA IV | RMC 12.2Kbps | Left Tilted | Full | 1413 | 1732.6 | 23.04 | 24.00 | 1.247 | 0.01 | 0.136 | 0.170 |
| | WCDMA II | RMC 12.2Kbps | Right Cheek | Full | 9538 | 1907.6 | 23.22 | 24.00 | 1.197 | -0.14 | 0.224 | 0.268 |
| | WCDMA II | RMC 12.2Kbps | Right Tilted | Full | 9538 | 1907.6 | 23.22 | 24.00 | 1.197 | 0.06 | 0.102 | 0.122 |
| 05 | WCDMA II | RMC 12.2Kbps | Left Cheek | Full | 9538 | 1907.6 | 23.22 | 24.00 | 1.197 | 0.06 | 0.228 | 0.273 |
| | WCDMA II | RMC 12.2Kbps | Left Tilted | Full | 9538 | 1907.6 | 23.22 | 24.00 | 1.197 | 0.01 | 0.159 | 0.190 |



<FDD LTE SAR>

| Plot No. | Band | BW (MHz) | Modulation | RB Size | RB offset | Test Position | Power Reduction | Ch. | Freq. (MHz) | Average Power (dBm) | Tune-Up Limit (dBm) | Tune-up Scaling Factor | Power Drift (dB) | Measured 1g SAR (W/kg) | Reported 1g SAR (W/kg) |
|----------|-------------|----------|------------|---------|-----------|---------------|-----------------|--------|-------------|---------------------|---------------------|------------------------|------------------|------------------------|------------------------|
| 06 | LTE Band 5 | 10M | QPSK | 1 | 25 | Right Cheek | Full | 20525 | 836.5 | 23.25 | 24.00 | 1.189 | -0.11 | 0.371 | 0.441 |
| | LTE Band 5 | 10M | QPSK | 1 | 25 | Right Tilted | Full | 20525 | 836.5 | 23.25 | 24.00 | 1.189 | 0.05 | 0.191 | 0.227 |
| | LTE Band 5 | 10M | QPSK | 1 | 25 | Left Cheek | Full | 20525 | 836.5 | 23.25 | 24.00 | 1.189 | -0.14 | 0.339 | 0.403 |
| | LTE Band 5 | 10M | QPSK | 1 | 25 | Left Tilted | Full | 20525 | 836.5 | 23.25 | 24.00 | 1.189 | 0.07 | 0.176 | 0.209 |
| | LTE Band 5 | 10M | QPSK | 25 | 12 | Right Cheek | Full | 20525 | 836.5 | 22.05 | 23.00 | 1.245 | 0.19 | 0.213 | 0.265 |
| | LTE Band 5 | 10M | QPSK | 25 | 12 | Right Tilted | Full | 20525 | 836.5 | 22.05 | 23.00 | 1.245 | 0.01 | 0.112 | 0.139 |
| | LTE Band 5 | 10M | QPSK | 25 | 12 | Left Cheek | Full | 20525 | 836.5 | 22.05 | 23.00 | 1.245 | -0.15 | 0.189 | 0.235 |
| | LTE Band 5 | 10M | QPSK | 25 | 12 | Left Tilted | Full | 20525 | 836.5 | 22.05 | 23.00 | 1.245 | -0.03 | 0.104 | 0.129 |
| 07 | LTE Band 66 | 20M | QPSK | 1 | 49 | Right Cheek | Full | 132322 | 1745 | 23.10 | 24.00 | 1.230 | 0.06 | 0.236 | 0.290 |
| | LTE Band 66 | 20M | QPSK | 1 | 49 | Right Tilted | Full | 132322 | 1745 | 23.10 | 24.00 | 1.230 | -0.13 | 0.099 | 0.121 |
| | LTE Band 66 | 20M | QPSK | 1 | 49 | Left Cheek | Full | 132322 | 1745 | 23.10 | 24.00 | 1.230 | -0.02 | 0.180 | 0.221 |
| | LTE Band 66 | 20M | QPSK | 1 | 49 | Left Tilted | Full | 132322 | 1745 | 23.10 | 24.00 | 1.230 | 0.04 | 0.134 | 0.165 |
| | LTE Band 66 | 20M | QPSK | 50 | 24 | Right Cheek | Full | 132322 | 1745 | 22.55 | 23.00 | 1.109 | -0.15 | 0.189 | 0.210 |
| | LTE Band 66 | 20M | QPSK | 50 | 24 | Right Tilted | Full | 132322 | 1745 | 22.55 | 23.00 | 1.109 | 0.09 | 0.082 | 0.091 |
| | LTE Band 66 | 20M | QPSK | 50 | 24 | Left Cheek | Full | 132322 | 1745 | 22.55 | 23.00 | 1.109 | 0.04 | 0.127 | 0.141 |
| | LTE Band 66 | 20M | QPSK | 50 | 24 | Left Tilted | Full | 132322 | 1745 | 22.55 | 23.00 | 1.109 | -0.17 | 0.117 | 0.130 |
| 08 | LTE Band 2 | 20M | QPSK | 1 | 49 | Right Cheek | Full | 18900 | 1880 | 23.09 | 24.00 | 1.233 | 0.03 | 0.206 | 0.254 |
| | LTE Band 2 | 20M | QPSK | 1 | 49 | Right Tilted | Full | 18900 | 1880 | 23.09 | 24.00 | 1.233 | -0.08 | 0.106 | 0.131 |
| | LTE Band 2 | 20M | QPSK | 1 | 49 | Left Cheek | Full | 18900 | 1880 | 23.09 | 24.00 | 1.233 | 0.02 | 0.218 | 0.269 |
| | LTE Band 2 | 20M | QPSK | 1 | 49 | Left Tilted | Full | 18900 | 1880 | 23.09 | 24.00 | 1.233 | 0.05 | 0.168 | 0.207 |
| | LTE Band 2 | 20M | QPSK | 50 | 0 | Right Cheek | Full | 18900 | 1880 | 21.90 | 23.00 | 1.288 | -0.09 | 0.121 | 0.156 |
| | LTE Band 2 | 20M | QPSK | 50 | 0 | Right Tilted | Full | 18900 | 1880 | 21.90 | 23.00 | 1.288 | 0.03 | 0.063 | 0.081 |
| | LTE Band 2 | 20M | QPSK | 50 | 0 | Left Cheek | Full | 18900 | 1880 | 21.90 | 23.00 | 1.288 | 0.03 | 0.127 | 0.164 |
| | LTE Band 2 | 20M | QPSK | 50 | 0 | Left Tilted | Full | 18900 | 1880 | 21.90 | 23.00 | 1.288 | 0.02 | 0.103 | 0.133 |
| 09 | LTE Band 7 | 20M | QPSK | 1 | 49 | Right Cheek | Full | 21100 | 2535 | 23.29 | 24.00 | 1.178 | -0.1 | 0.123 | 0.145 |
| | LTE Band 7 | 20M | QPSK | 1 | 49 | Right Tilted | Full | 21100 | 2535 | 23.29 | 24.00 | 1.178 | 0.17 | 0.065 | 0.077 |
| | LTE Band 7 | 20M | QPSK | 1 | 49 | Left Cheek | Full | 21100 | 2535 | 23.29 | 24.00 | 1.178 | 0.08 | 0.218 | 0.257 |
| | LTE Band 7 | 20M | QPSK | 1 | 49 | Left Tilted | Full | 21100 | 2535 | 23.29 | 24.00 | 1.178 | -0.05 | 0.086 | 0.101 |
| | LTE Band 7 | 20M | QPSK | 50 | 0 | Right Cheek | Full | 21100 | 2535 | 22.37 | 23.00 | 1.156 | 0.02 | 0.118 | 0.136 |
| | LTE Band 7 | 20M | QPSK | 50 | 0 | Right Tilted | Full | 21100 | 2535 | 22.37 | 23.00 | 1.156 | 0.15 | 0.066 | 0.076 |
| | LTE Band 7 | 20M | QPSK | 50 | 0 | Left Cheek | Full | 21100 | 2535 | 22.37 | 23.00 | 1.156 | -0.03 | 0.189 | 0.219 |
| | LTE Band 7 | 20M | QPSK | 50 | 0 | Left Tilted | Full | 21100 | 2535 | 22.37 | 23.00 | 1.156 | 0.18 | 0.081 | 0.093 |



<WLAN2.4G SAR>

| Plot No. | Band | Mode | Test Position | Power Reduction | Ch. | Freq. (MHz) | Average Power (dBm) | Tune-Up Limit (dBm) | Tune-up Scaling Factor | Duty Cycle % | Duty Cycle Scaling Factor | Power Drift (dB) | Measured 1g SAR (W/kg) | Reported 1g SAR (W/kg) |
|----------|------------|---------------|---------------|-----------------|-----|-------------|---------------------|---------------------|------------------------|--------------|---------------------------|------------------|------------------------|------------------------|
| | WLAN2.4GHz | 802.11b 1Mbps | Right Cheek | Full | 11 | 2462 | 18.50 | 19.50 | 1.259 | 99.31 | 1.007 | 0.12 | 0.233 | 0.295 |
| | WLAN2.4GHz | 802.11b 1Mbps | Right Tilted | Full | 11 | 2462 | 18.50 | 19.50 | 1.259 | 99.31 | 1.007 | 0.11 | 0.292 | 0.370 |
| 10 | WLAN2.4GHz | 802.11b 1Mbps | Left Cheek | Full | 11 | 2462 | 18.50 | 19.50 | 1.259 | 99.31 | 1.007 | -0.11 | 0.461 | 0.584 |
| | WLAN2.4GHz | 802.11b 1Mbps | Left Tilted | Full | 11 | 2462 | 18.50 | 19.50 | 1.259 | 99.31 | 1.007 | 0.12 | 0.458 | 0.581 |

<WLAN5G SAR>

| Plot No. | Band | Mode | Test Position | Power Reduction | Ch. | Freq. (MHz) | Average Power (dBm) | Tune-Up Limit (dBm) | Tune-up Scaling Factor | Duty Cycle % | Duty Cycle Scaling Factor | Power Drift (dB) | Measured 1g SAR (W/kg) | Reported 1g SAR (W/kg) |
|----------|------------|---------------------|---------------|-----------------|-----|-------------|---------------------|---------------------|------------------------|--------------|---------------------------|------------------|------------------------|------------------------|
| | WLAN5.3GHz | 802.11n-HT40 MCS0 | Right Cheek | Full | 54 | 5270 | 17.24 | 19.00 | 1.500 | 96.32 | 1.038 | 0.12 | 0.388 | 0.604 |
| | WLAN5.3GHz | 802.11n-HT40 MCS0 | Right Tilted | Full | 54 | 5270 | 17.24 | 19.00 | 1.500 | 96.32 | 1.038 | 0.11 | 0.428 | 0.666 |
| 11 | WLAN5.3GHz | 802.11n-HT40 MCS0 | Left Cheek | Full | 54 | 5270 | 17.24 | 19.00 | 1.500 | 96.32 | 1.038 | 0.16 | 0.568 | 0.884 |
| | WLAN5.3GHz | 802.11n-HT40 MCS0 | Left Tilted | Full | 54 | 5270 | 17.24 | 19.00 | 1.500 | 96.32 | 1.038 | 0.03 | 0.535 | 0.833 |
| | WLAN5.3GHz | 802.11n-HT40 MCS0 | Left Cheek | Full | 62 | 5310 | 15.72 | 17.00 | 1.343 | 96.32 | 1.038 | 0.04 | 0.413 | 0.576 |
| | WLAN5.3GHz | 802.11n-HT40 MCS0 | Left Tilted | Full | 62 | 5310 | 15.72 | 17.00 | 1.343 | 96.32 | 1.038 | 0.05 | 0.379 | 0.528 |
| | WLAN5.5GHz | 802.11ac-VHT80 MCS0 | Right Cheek | Reduced | 122 | 5610 | 15.54 | 17.00 | 1.400 | 92.79 | 1.078 | 0.05 | 0.326 | 0.492 |
| | WLAN5.5GHz | 802.11ac-VHT80 MCS0 | Right Tilted | Reduced | 122 | 5610 | 15.54 | 17.00 | 1.400 | 92.79 | 1.078 | -0.02 | 0.413 | 0.623 |
| | WLAN5.5GHz | 802.11ac-VHT80 MCS0 | Left Cheek | Reduced | 122 | 5610 | 15.54 | 17.00 | 1.400 | 92.79 | 1.078 | 0.06 | 0.556 | 0.839 |
| | WLAN5.5GHz | 802.11ac-VHT80 MCS0 | Left Tilted | Reduced | 122 | 5610 | 15.54 | 17.00 | 1.400 | 92.79 | 1.078 | 0.01 | 0.520 | 0.785 |
| 12 | WLAN5.5GHz | 802.11ac-VHT80 MCS0 | Left Cheek | Reduced | 138 | 5690 | 15.49 | 17.00 | 1.416 | 92.79 | 1.078 | -0.09 | 0.724 | 1.105 |
| | WLAN5.8GHz | 802.11ac-VHT80 MCS0 | Right Cheek | Full | 155 | 5775 | 12.25 | 13.50 | 1.334 | 92.79 | 1.078 | 0.12 | 0.160 | 0.230 |
| | WLAN5.8GHz | 802.11ac-VHT80 MCS0 | Right Tilted | Full | 155 | 5775 | 12.25 | 13.50 | 1.334 | 92.79 | 1.078 | 0.11 | 0.196 | 0.282 |
| | WLAN5.8GHz | 802.11ac-VHT80 MCS0 | Left Cheek | Full | 155 | 5775 | 12.25 | 13.50 | 1.334 | 92.79 | 1.078 | 0.13 | 0.224 | 0.322 |
| 13 | WLAN5.8GHz | 802.11ac-VHT80 MCS0 | Left Tilted | Full | 155 | 5775 | 12.25 | 13.50 | 1.334 | 92.79 | 1.078 | 0.17 | 0.241 | 0.346 |

<Bluetooth SAR>

| Plot No. | Band | Mode | Test Position | Power Reduction | Ch. | Freq. (MHz) | Average Power (dBm) | Tune-Up Limit (dBm) | Tune-up Scaling Factor | Duty Cycle % | Duty Cycle Scaling Factor | Power Drift (dB) | Measured 1g SAR (W/kg) | Reported 1g SAR (W/kg) |
|----------|-----------|-----------|---------------|-----------------|-----|-------------|---------------------|---------------------|------------------------|--------------|---------------------------|------------------|------------------------|------------------------|
| | Bluetooth | DH5 1Mbps | Right Cheek | Full | 39 | 2441 | 11.20 | 12.00 | 1.202 | 77.36 | 1.293 | 0.11 | 0.030 | 0.047 |
| | Bluetooth | DH5 1Mbps | Right Tilted | Full | 39 | 2441 | 11.20 | 12.00 | 1.202 | 77.36 | 1.293 | 0.03 | 0.039 | 0.061 |
| 14 | Bluetooth | DH5 1Mbps | Left Cheek | Full | 39 | 2441 | 11.20 | 12.00 | 1.202 | 77.36 | 1.293 | -0.13 | 0.090 | 0.140 |
| | Bluetooth | DH5 1Mbps | Left Tilted | Full | 39 | 2441 | 11.20 | 12.00 | 1.202 | 77.36 | 1.293 | 0.04 | 0.073 | 0.114 |



15.2 Hotspot SAR

<GSM SAR>

| Plot No. | Band | Mode | Test Position | Gap (mm) | Power Reduction | Ch. | Freq. (MHz) | Average Power (dBm) | Tune-Up Limit (dBm) | Tune-up Scaling Factor | Power Drift (dB) | Measured 1g SAR (W/kg) | Reported 1g SAR (W/kg) |
|----------|---------|------------------|---------------|----------|-----------------|-----|-------------|---------------------|---------------------|------------------------|------------------|------------------------|------------------------|
| | GSM850 | GPRS(2 Tx slots) | Front | 5mm | Reduced | 251 | 848.8 | 29.84 | 30.50 | 1.164 | -0.13 | 0.555 | 0.646 |
| 15 | GSM850 | GPRS(2 Tx slots) | Back | 5mm | Reduced | 251 | 848.8 | 29.84 | 30.50 | 1.164 | 0.15 | 1.080 | 1.257 |
| | GSM850 | GPRS(2 Tx slots) | Left Side | 5mm | Reduced | 251 | 848.8 | 29.84 | 30.50 | 1.164 | -0.02 | 0.211 | 0.246 |
| | GSM850 | GPRS(2 Tx slots) | Right Side | 5mm | Reduced | 251 | 848.8 | 29.84 | 30.50 | 1.164 | -0.05 | 0.382 | 0.445 |
| | GSM850 | GPRS(2 Tx slots) | Bottom Side | 5mm | Reduced | 251 | 848.8 | 29.84 | 30.50 | 1.164 | -0.08 | 0.361 | 0.420 |
| | GSM850 | GPRS(2 Tx slots) | Back | 5mm | Reduced | 128 | 824.2 | 29.56 | 30.50 | 1.242 | 0.05 | 0.888 | 1.103 |
| | GSM850 | GPRS(2 Tx slots) | Back | 5mm | Reduced | 189 | 836.4 | 29.81 | 30.50 | 1.172 | -0.13 | 0.933 | 1.094 |
| | GSM1900 | GPRS(2 Tx slots) | Front | 5mm | Reduced | 810 | 1909.8 | 26.44 | 27.50 | 1.276 | 0.02 | 0.629 | 0.803 |
| | GSM1900 | GPRS(2 Tx slots) | Back | 5mm | Reduced | 810 | 1909.8 | 26.44 | 27.50 | 1.276 | -0.17 | 0.740 | 0.945 |
| | GSM1900 | GPRS(2 Tx slots) | Left Side | 5mm | Reduced | 810 | 1909.8 | 25.00 | 26.00 | 1.259 | 0.04 | 0.242 | 0.305 |
| | GSM1900 | GPRS(2 Tx slots) | Right Side | 5mm | Reduced | 810 | 1909.8 | 25.00 | 26.00 | 1.259 | 0.02 | 0.072 | 0.090 |
| | GSM1900 | GPRS(2 Tx slots) | Bottom Side | 5mm | Reduced | 810 | 1909.8 | 25.00 | 26.00 | 1.259 | 0.15 | 0.820 | 1.032 |
| 16 | GSM1900 | GPRS(2 Tx slots) | Bottom Side | 5mm | Reduced | 512 | 1850.2 | 24.87 | 26.00 | 1.297 | 0.02 | 1.000 | 1.297 |
| | GSM1900 | GPRS(2 Tx slots) | Bottom Side | 5mm | Reduced | 661 | 1880 | 24.90 | 26.00 | 1.288 | 0.01 | 0.876 | 1.129 |
| | GSM1900 | GPRS(2 Tx slots) | Front | 5mm | Reduced | 512 | 1850.2 | 26.14 | 27.50 | 1.368 | -0.13 | 0.783 | 1.071 |
| | GSM1900 | GPRS(2 Tx slots) | Front | 5mm | Reduced | 661 | 1880 | 26.42 | 27.50 | 1.282 | -0.14 | 0.732 | 0.939 |
| | GSM1900 | GPRS(2 Tx slots) | Back | 5mm | Reduced | 512 | 1850.2 | 26.14 | 27.50 | 1.368 | -0.13 | 0.888 | 1.215 |
| | GSM1900 | GPRS(2 Tx slots) | Back | 5mm | Reduced | 661 | 1880 | 26.42 | 27.50 | 1.282 | -0.14 | 0.842 | 1.080 |

<WCDMA SAR>

| Plot No. | Band | Mode | Test Position | Gap (mm) | Power Reduction | Ch. | Freq. (MHz) | Average Power (dBm) | Tune-Up Limit (dBm) | Tune-up Scaling Factor | Power Drift (dB) | Measured 1g SAR (W/kg) | Reported 1g SAR (W/kg) |
|----------|----------|--------------|---------------|----------|-----------------|------|-------------|---------------------|---------------------|------------------------|------------------|------------------------|------------------------|
| | WCDMA V | RMC 12.2Kbps | Front | 5mm | Reduced | 4132 | 826.4 | 22.35 | 23.00 | 1.161 | 0.16 | 0.526 | 0.611 |
| | WCDMA V | RMC 12.2Kbps | Back | 5mm | Reduced | 4132 | 826.4 | 22.35 | 23.00 | 1.161 | -0.15 | 0.940 | 1.092 |
| | WCDMA V | RMC 12.2Kbps | Left Side | 5mm | Reduced | 4132 | 826.4 | 22.35 | 23.00 | 1.161 | -0.04 | 0.230 | 0.267 |
| | WCDMA V | RMC 12.2Kbps | Right Side | 5mm | Reduced | 4132 | 826.4 | 22.35 | 23.00 | 1.161 | -0.08 | 0.339 | 0.394 |
| | WCDMA V | RMC 12.2Kbps | Bottom Side | 5mm | Reduced | 4132 | 826.4 | 22.35 | 23.00 | 1.161 | -0.02 | 0.263 | 0.305 |
| | WCDMA V | RMC 12.2Kbps | Back | 5mm | Reduced | 4182 | 836.4 | 22.33 | 23.00 | 1.167 | -0.03 | 0.964 | 1.125 |
| 17 | WCDMA V | RMC 12.2Kbps | Back | 5mm | Reduced | 4233 | 846.6 | 22.18 | 23.00 | 1.208 | -0.1 | 0.980 | 1.184 |
| | WCDMA IV | RMC 12.2Kbps | Front | 5mm | Reduced | 1413 | 1732.6 | 18.09 | 19.00 | 1.233 | -0.1 | 0.740 | 0.912 |
| | WCDMA IV | RMC 12.2Kbps | Back | 5mm | Reduced | 1413 | 1732.6 | 18.09 | 19.00 | 1.233 | -0.12 | 1.000 | 1.233 |
| | WCDMA IV | RMC 12.2Kbps | Left Side | 5mm | Reduced | 1413 | 1732.6 | 17.13 | 18.00 | 1.222 | 0.03 | 0.124 | 0.152 |
| | WCDMA IV | RMC 12.2Kbps | Right Side | 5mm | Reduced | 1413 | 1732.6 | 17.13 | 18.00 | 1.222 | 0.02 | 0.094 | 0.114 |
| | WCDMA IV | RMC 12.2Kbps | Bottom Side | 5mm | Reduced | 1413 | 1732.6 | 17.13 | 18.00 | 1.222 | 0.05 | 1.110 | 1.356 |
| | WCDMA IV | RMC 12.2Kbps | Bottom Side | 5mm | Reduced | 1312 | 1712.4 | 16.99 | 18.00 | 1.262 | -0.08 | 1.020 | 1.287 |
| 18 | WCDMA IV | RMC 12.2Kbps | Bottom Side | 5mm | Reduced | 1513 | 1752.6 | 17.12 | 18.00 | 1.225 | -0.12 | 1.120 | 1.372 |
| | WCDMA IV | RMC 12.2Kbps | Front | 5mm | Reduced | 1312 | 1712.4 | 18.04 | 19.00 | 1.247 | -0.01 | 0.657 | 0.820 |
| | WCDMA IV | RMC 12.2Kbps | Front | 5mm | Reduced | 1513 | 1752.6 | 17.99 | 19.00 | 1.262 | -0.13 | 0.741 | 0.935 |
| | WCDMA IV | RMC 12.2Kbps | Back | 5mm | Reduced | 1312 | 1712.4 | 18.04 | 19.00 | 1.247 | -0.18 | 0.962 | 1.200 |
| | WCDMA IV | RMC 12.2Kbps | Back | 5mm | Reduced | 1513 | 1752.6 | 17.99 | 19.00 | 1.262 | -0.07 | 1.080 | 1.363 |
| | WCDMA II | RMC 12.2Kbps | Front | 5mm | Reduced | 9538 | 1907.6 | 20.06 | 21.00 | 1.242 | 0.06 | 0.736 | 0.914 |
| | WCDMA II | RMC 12.2Kbps | Back | 5mm | Reduced | 9538 | 1907.6 | 20.06 | 21.00 | 1.242 | -0.11 | 0.782 | 0.971 |
| | WCDMA II | RMC 12.2Kbps | Left Side | 5mm | Reduced | 9538 | 1907.6 | 17.69 | 18.50 | 1.205 | 0.08 | 0.173 | 0.208 |
| | WCDMA II | RMC 12.2Kbps | Right Side | 5mm | Reduced | 9538 | 1907.6 | 17.69 | 18.50 | 1.205 | 0.05 | 0.031 | 0.037 |
| | WCDMA II | RMC 12.2Kbps | Bottom Side | 5mm | Reduced | 9538 | 1907.6 | 17.69 | 18.50 | 1.205 | -0.02 | 0.781 | 0.941 |
| | WCDMA II | RMC 12.2Kbps | Bottom Side | 5mm | Reduced | 9262 | 1852.4 | 17.63 | 18.50 | 1.222 | 0.02 | 0.952 | 1.163 |
| | WCDMA II | RMC 12.2Kbps | Bottom Side | 5mm | Reduced | 9400 | 1880 | 17.66 | 18.50 | 1.213 | -0.1 | 0.858 | 1.041 |
| | WCDMA II | RMC 12.2Kbps | Front | 5mm | Reduced | 9262 | 1852.4 | 19.90 | 21.00 | 1.288 | 0.03 | 0.754 | 0.971 |
| | WCDMA II | RMC 12.2Kbps | Front | 5mm | Reduced | 9400 | 1880 | 20.01 | 21.00 | 1.256 | 0.06 | 0.727 | 0.913 |
| 19 | WCDMA II | RMC 12.2Kbps | Back | 5mm | Reduced | 9262 | 1852.4 | 19.90 | 21.00 | 1.288 | -0.13 | 0.936 | 1.206 |
| | WCDMA II | RMC 12.2Kbps | Back | 5mm | Reduced | 9400 | 1880 | 20.01 | 21.00 | 1.256 | -0.19 | 0.851 | 1.069 |



<FDD LTE SAR>

| Plot No. | Band | BW (MHz) | Modulation | RB Size | RB offset | Test Position | Gap (mm) | Power Reduction | Ch. | Freq. (MHz) | Average Power (dBm) | Tune-Up Limit (dBm) | Tune-up Scaling Factor | Power Drift (dB) | Measured 1g SAR (W/kg) | Reported 1g SAR (W/kg) |
|----------|-------------|----------|------------|---------|-----------|---------------|----------|-----------------|--------|-------------|---------------------|---------------------|------------------------|------------------|------------------------|------------------------|
| 20 | LTE Band 5 | 10M | QPSK | 1 | 25 | Front | 5mm | Reduced | 20525 | 836.5 | 22.81 | 23.50 | 1.172 | 0.05 | 0.603 | 0.707 |
| | LTE Band 5 | 10M | QPSK | 1 | 25 | Back | 5mm | Reduced | 20525 | 836.5 | 22.81 | 23.50 | 1.172 | -0.16 | 1.160 | 1.360 |
| | LTE Band 5 | 10M | QPSK | 1 | 25 | Left Side | 5mm | Reduced | 20525 | 836.5 | 22.81 | 23.50 | 1.172 | 0.05 | 0.336 | 0.394 |
| | LTE Band 5 | 10M | QPSK | 1 | 25 | Right Side | 5mm | Reduced | 20525 | 836.5 | 22.81 | 23.50 | 1.172 | -0.07 | 0.477 | 0.559 |
| | LTE Band 5 | 10M | QPSK | 1 | 25 | Bottom Side | 5mm | Reduced | 20525 | 836.5 | 22.81 | 23.50 | 1.172 | -0.08 | 0.338 | 0.396 |
| | LTE Band 5 | 10M | QPSK | 25 | 12 | Front | 5mm | Reduced | 20525 | 836.5 | 21.61 | 22.50 | 1.227 | -0.09 | 0.319 | 0.392 |
| | LTE Band 5 | 10M | QPSK | 25 | 12 | Back | 5mm | Reduced | 20525 | 836.5 | 21.61 | 22.50 | 1.227 | -0.14 | 0.620 | 0.761 |
| | LTE Band 5 | 10M | QPSK | 25 | 12 | Left Side | 5mm | Reduced | 20525 | 836.5 | 21.61 | 22.50 | 1.227 | -0.16 | 0.196 | 0.241 |
| | LTE Band 5 | 10M | QPSK | 25 | 12 | Right Side | 5mm | Reduced | 20525 | 836.5 | 21.61 | 22.50 | 1.227 | -0.18 | 0.273 | 0.335 |
| | LTE Band 5 | 10M | QPSK | 25 | 12 | Bottom Side | 5mm | Reduced | 20525 | 836.5 | 21.61 | 22.50 | 1.227 | -0.06 | 0.189 | 0.232 |
| | LTE Band 5 | 10M | QPSK | 50 | 0 | Back | 5mm | Reduced | 20525 | 836.5 | 21.50 | 22.50 | 1.259 | -0.07 | 0.616 | 0.775 |
| | LTE Band 66 | 20M | QPSK | 1 | 49 | Front | 5mm | Reduced | 132322 | 1745 | 18.26 | 19.00 | 1.186 | 0.02 | 0.778 | 0.923 |
| | LTE Band 66 | 20M | QPSK | 1 | 49 | Back | 5mm | Reduced | 132322 | 1745 | 18.26 | 19.00 | 1.186 | 0.06 | 1.150 | 1.364 |
| | LTE Band 66 | 20M | QPSK | 1 | 49 | Left Side | 5mm | Reduced | 132322 | 1745 | 17.01 | 17.50 | 1.119 | -0.11 | 0.106 | 0.119 |
| | LTE Band 66 | 20M | QPSK | 1 | 49 | Right Side | 5mm | Reduced | 132322 | 1745 | 17.01 | 17.50 | 1.119 | 0.08 | 0.103 | 0.115 |
| | LTE Band 66 | 20M | QPSK | 1 | 49 | Bottom Side | 5mm | Reduced | 132322 | 1745 | 17.01 | 17.50 | 1.119 | 0.05 | 1.020 | 1.142 |
| | LTE Band 66 | 20M | QPSK | 1 | 49 | Bottom Side | 5mm | Reduced | 132072 | 1720 | 16.55 | 17.50 | 1.245 | -0.02 | 0.906 | 1.128 |
| | LTE Band 66 | 20M | QPSK | 1 | 49 | Bottom Side | 5mm | Reduced | 132572 | 1770 | 16.77 | 17.50 | 1.183 | 0.02 | 1.020 | 1.207 |
| | LTE Band 66 | 20M | QPSK | 1 | 49 | Front | 5mm | Reduced | 132072 | 1720 | 17.80 | 19.00 | 1.318 | -0.1 | 0.686 | 0.904 |
| | LTE Band 66 | 20M | QPSK | 1 | 49 | Front | 5mm | Reduced | 132572 | 1770 | 18.22 | 19.00 | 1.197 | 0.03 | 0.791 | 0.947 |
| | LTE Band 66 | 20M | QPSK | 1 | 49 | Back | 5mm | Reduced | 132072 | 1720 | 17.80 | 19.00 | 1.318 | 0.06 | 1.020 | 1.345 |
| | LTE Band 66 | 20M | QPSK | 1 | 49 | Back | 5mm | Reduced | 132572 | 1770 | 18.22 | 19.00 | 1.197 | -0.13 | 1.110 | 1.328 |
| | LTE Band 66 | 20M | QPSK | 50 | 24 | Front | 5mm | Reduced | 132322 | 1745 | 18.15 | 19.00 | 1.216 | 0.06 | 0.765 | 0.930 |
| | LTE Band 66 | 20M | QPSK | 50 | 24 | Front | 5mm | Reduced | 132072 | 1720 | 17.78 | 19.00 | 1.324 | -0.13 | 0.678 | 0.898 |
| | LTE Band 66 | 20M | QPSK | 50 | 24 | Front | 5mm | Reduced | 132572 | 1770 | 17.93 | 19.00 | 1.279 | -0.19 | 0.751 | 0.961 |
| | LTE Band 66 | 20M | QPSK | 50 | 24 | Back | 5mm | Reduced | 132322 | 1745 | 18.15 | 19.00 | 1.216 | -0.06 | 1.140 | 1.386 |
| | LTE Band 66 | 20M | QPSK | 50 | 24 | Back | 5mm | Reduced | 132072 | 1720 | 17.78 | 19.00 | 1.324 | -0.07 | 0.952 | 1.261 |
| | LTE Band 66 | 20M | QPSK | 50 | 24 | Back | 5mm | Reduced | 132572 | 1770 | 17.93 | 19.00 | 1.279 | 0.05 | 1.030 | 1.318 |
| | LTE Band 66 | 20M | QPSK | 50 | 24 | Left Side | 5mm | Reduced | 132322 | 1745 | 16.90 | 17.50 | 1.148 | -0.02 | 0.107 | 0.123 |
| | LTE Band 66 | 20M | QPSK | 50 | 24 | Right Side | 5mm | Reduced | 132322 | 1745 | 16.90 | 17.50 | 1.148 | 0.02 | 0.100 | 0.115 |
| | LTE Band 66 | 20M | QPSK | 50 | 24 | Bottom Side | 5mm | Reduced | 132322 | 1745 | 16.90 | 17.50 | 1.148 | -0.1 | 1.030 | 1.183 |
| | LTE Band 66 | 20M | QPSK | 50 | 24 | Bottom Side | 5mm | Reduced | 132072 | 1720 | 16.53 | 17.50 | 1.250 | 0.03 | 0.905 | 1.131 |
| | LTE Band 66 | 20M | QPSK | 50 | 24 | Bottom Side | 5mm | Reduced | 132572 | 1770 | 16.68 | 17.50 | 1.208 | 0.06 | 1.040 | 1.256 |
| | LTE Band 66 | 20M | QPSK | 100 | 0 | Front | 5mm | Reduced | 132322 | 1745 | 18.14 | 19.00 | 1.219 | 0.03 | 0.836 | 1.019 |
| 21 | LTE Band 66 | 20M | QPSK | 100 | 0 | Back | 5mm | Reduced | 132322 | 1745 | 18.14 | 19.00 | 1.219 | -0.17 | 1.180 | 1.438 |
| | LTE Band 66 | 20M | QPSK | 100 | 0 | Bottom Side | 5mm | Reduced | 132322 | 1745 | 16.77 | 17.50 | 1.183 | 0.05 | 1.030 | 1.219 |



FCC SAR Test Report

Report No. : FA002013-01

| Plot No. | Band | BW (MHz) | Modulation | RB Size | RB offset | Test Position | Gap (mm) | Power Reduction | Ch. | Freq. (MHz) | Average Power (dBm) | Tune-Up Limit (dBm) | Tune-up Scaling Factor | Power Drift (dB) | Measured 1g SAR (W/kg) | Reported 1g SAR (W/kg) |
|----------|------------|----------|------------|---------|-----------|---------------|----------|-----------------|-------|-------------|---------------------|---------------------|------------------------|------------------|------------------------|------------------------|
| | LTE Band 2 | 20M | QPSK | 1 | 49 | Front | 5mm | Reduced | 19100 | 1900 | 21.42 | 22.00 | 1.143 | 0.03 | 0.872 | 0.997 |
| | LTE Band 2 | 20M | QPSK | 1 | 49 | Back | 5mm | Reduced | 19100 | 1900 | 21.42 | 22.00 | 1.143 | 0.07 | 1.160 | 1.326 |
| | LTE Band 2 | 20M | QPSK | 1 | 49 | Left Side | 5mm | Reduced | 19100 | 1900 | 18.68 | 19.50 | 1.208 | 0.02 | 0.242 | 0.292 |
| | LTE Band 2 | 20M | QPSK | 1 | 49 | Right Side | 5mm | Reduced | 19100 | 1900 | 18.68 | 19.50 | 1.208 | -0.07 | 0.068 | 0.082 |
| | LTE Band 2 | 20M | QPSK | 1 | 49 | Bottom Side | 5mm | Reduced | 19100 | 1900 | 18.68 | 19.50 | 1.208 | 0.05 | 0.940 | 1.135 |
| | LTE Band 2 | 20M | QPSK | 1 | 49 | Bottom Side | 5mm | Reduced | 18700 | 1860 | 18.61 | 19.50 | 1.227 | -0.02 | 1.140 | 1.399 |
| | LTE Band 2 | 20M | QPSK | 1 | 49 | Bottom Side | 5mm | Reduced | 18900 | 1880 | 18.59 | 19.50 | 1.233 | 0.15 | 1.020 | 1.258 |
| | LTE Band 2 | 20M | QPSK | 1 | 49 | Front | 5mm | Reduced | 18700 | 1860 | 21.41 | 22.00 | 1.146 | 0.02 | 1.150 | 1.317 |
| | LTE Band 2 | 20M | QPSK | 1 | 49 | Front | 5mm | Reduced | 18900 | 1880 | 21.27 | 22.00 | 1.183 | 0.08 | 0.920 | 1.088 |
| 22 | LTE Band 2 | 20M | QPSK | 1 | 49 | Back | 5mm | Reduced | 18700 | 1860 | 21.41 | 22.00 | 1.146 | -0.04 | 1.260 | 1.443 |
| | LTE Band 2 | 20M | QPSK | 1 | 49 | Back | 5mm | Reduced | 18900 | 1880 | 21.27 | 22.00 | 1.183 | 0.04 | 1.160 | 1.372 |
| | LTE Band 2 | 20M | QPSK | 50 | 24 | Front | 5mm | Reduced | 19100 | 1900 | 21.16 | 22.00 | 1.213 | -0.03 | 0.799 | 0.969 |
| | LTE Band 2 | 20M | QPSK | 50 | 24 | Front | 5mm | Reduced | 18700 | 1860 | 21.14 | 22.00 | 1.219 | 0.07 | 0.851 | 1.037 |
| | LTE Band 2 | 20M | QPSK | 50 | 24 | Front | 5mm | Reduced | 18900 | 1880 | 21.09 | 22.00 | 1.233 | 0.02 | 0.808 | 0.996 |
| | LTE Band 2 | 20M | QPSK | 50 | 24 | Back | 5mm | Reduced | 19100 | 1900 | 21.16 | 22.00 | 1.213 | -0.07 | 0.992 | 1.204 |
| | LTE Band 2 | 20M | QPSK | 50 | 24 | Back | 5mm | Reduced | 18700 | 1860 | 21.14 | 22.00 | 1.219 | 0.05 | 1.160 | 1.414 |
| | LTE Band 2 | 20M | QPSK | 50 | 24 | Back | 5mm | Reduced | 18900 | 1880 | 21.09 | 22.00 | 1.233 | -0.02 | 1.040 | 1.282 |
| | LTE Band 2 | 20M | QPSK | 50 | 24 | Left Side | 5mm | Reduced | 19100 | 1900 | 18.56 | 19.50 | 1.242 | 0.08 | 0.243 | 0.302 |
| | LTE Band 2 | 20M | QPSK | 50 | 24 | Right Side | 5mm | Reduced | 19100 | 1900 | 18.56 | 19.50 | 1.242 | 0.05 | 0.068 | 0.085 |
| | LTE Band 2 | 20M | QPSK | 50 | 24 | Bottom Side | 5mm | Reduced | 19100 | 1900 | 18.56 | 19.50 | 1.242 | -0.02 | 0.944 | 1.172 |
| | LTE Band 2 | 20M | QPSK | 50 | 24 | Bottom Side | 5mm | Reduced | 18700 | 1860 | 18.54 | 19.50 | 1.247 | 0.11 | 1.130 | 1.410 |
| | LTE Band 2 | 20M | QPSK | 50 | 24 | Bottom Side | 5mm | Reduced | 18900 | 1880 | 18.49 | 19.50 | 1.262 | 0.13 | 1.010 | 1.274 |
| | LTE Band 2 | 20M | QPSK | 100 | 0 | Front | 5mm | Reduced | 19100 | 1900 | 21.14 | 22.00 | 1.219 | -0.02 | 0.722 | 0.880 |
| | LTE Band 2 | 20M | QPSK | 100 | 0 | Back | 5mm | Reduced | 19100 | 1900 | 21.14 | 22.00 | 1.219 | 0.05 | 1.010 | 1.231 |
| | LTE Band 2 | 20M | QPSK | 100 | 0 | Bottom Side | 5mm | Reduced | 19100 | 1900 | 18.54 | 19.50 | 1.247 | 0.06 | 1.060 | 1.322 |
| | LTE Band 7 | 20M | QPSK | 1 | 49 | Front | 5mm | Reduced | 21100 | 2535 | 16.34 | 17.00 | 1.164 | 0.02 | 0.419 | 0.488 |
| | LTE Band 7 | 20M | QPSK | 1 | 49 | Back | 5mm | Reduced | 21100 | 2535 | 16.34 | 17.00 | 1.164 | -0.1 | 0.919 | 1.070 |
| | LTE Band 7 | 20M | QPSK | 1 | 49 | Left Side | 5mm | Reduced | 21100 | 2535 | 15.54 | 16.00 | 1.112 | -0.02 | 0.111 | 0.123 |
| | LTE Band 7 | 20M | QPSK | 1 | 49 | Right Side | 5mm | Reduced | 21100 | 2535 | 15.54 | 16.00 | 1.112 | 0.06 | 0.041 | 0.045 |
| | LTE Band 7 | 20M | QPSK | 1 | 49 | Bottom Side | 5mm | Reduced | 21100 | 2535 | 15.54 | 16.00 | 1.112 | 0.01 | 1.250 | 1.390 |
| 23 | LTE Band 7 | 20M | QPSK | 1 | 49 | Bottom Side | 5mm | Reduced | 20850 | 2510 | 15.51 | 16.00 | 1.119 | -0.16 | 1.290 | 1.444 |
| | LTE Band 7 | 20M | QPSK | 1 | 49 | Bottom Side | 5mm | Reduced | 21350 | 2560 | 15.31 | 16.00 | 1.172 | 0.03 | 1.040 | 1.219 |
| | LTE Band 7 | 20M | QPSK | 1 | 49 | Back | 5mm | Reduced | 20850 | 2510 | 16.32 | 17.00 | 1.169 | -0.04 | 1.030 | 1.205 |
| | LTE Band 7 | 20M | QPSK | 1 | 49 | Back | 5mm | Reduced | 21350 | 2560 | 16.21 | 17.00 | 1.199 | -0.19 | 0.815 | 0.978 |
| | LTE Band 7 | 20M | QPSK | 50 | 24 | Front | 5mm | Reduced | 21100 | 2535 | 16.26 | 17.00 | 1.186 | 0.08 | 0.428 | 0.508 |
| | LTE Band 7 | 20M | QPSK | 50 | 24 | Back | 5mm | Reduced | 21100 | 2535 | 16.26 | 17.00 | 1.186 | 0.05 | 0.870 | 1.032 |
| | LTE Band 7 | 20M | QPSK | 50 | 24 | Back | 5mm | Reduced | 20850 | 2510 | 16.19 | 17.00 | 1.205 | 0.04 | 0.939 | 1.132 |
| | LTE Band 7 | 20M | QPSK | 50 | 24 | Back | 5mm | Reduced | 21350 | 2560 | 16.16 | 17.00 | 1.213 | 0.03 | 0.788 | 0.956 |
| | LTE Band 7 | 20M | QPSK | 50 | 24 | Left Side | 5mm | Reduced | 21100 | 2535 | 15.50 | 16.00 | 1.122 | -0.01 | 0.110 | 0.123 |
| | LTE Band 7 | 20M | QPSK | 50 | 24 | Right Side | 5mm | Reduced | 21100 | 2535 | 15.50 | 16.00 | 1.122 | 0.08 | 0.041 | 0.046 |
| | LTE Band 7 | 20M | QPSK | 50 | 24 | Bottom Side | 5mm | Reduced | 21100 | 2535 | 15.50 | 16.00 | 1.122 | 0.1 | 1.150 | 1.290 |
| | LTE Band 7 | 20M | QPSK | 50 | 24 | Bottom Side | 5mm | Reduced | 20850 | 2510 | 15.49 | 16.00 | 1.125 | -0.04 | 1.250 | 1.406 |
| | LTE Band 7 | 20M | QPSK | 50 | 24 | Bottom Side | 5mm | Reduced | 21350 | 2560 | 15.16 | 16.00 | 1.213 | -0.19 | 1.030 | 1.250 |
| | LTE Band 7 | 20M | QPSK | 100 | 0 | Back | 5mm | Reduced | 21100 | 2535 | 16.23 | 17.00 | 1.194 | -0.04 | 0.858 | 1.024 |
| | LTE Band 7 | 20M | QPSK | 100 | 0 | Bottom Side | 5mm | Reduced | 21100 | 2535 | 15.23 | 16.00 | 1.194 | 0.06 | 1.130 | 1.349 |



<WLAN2.4G SAR>

| Plot No. | Band | Mode | Test Position | Gap (mm) | Power Reduction | Ch. | Freq. (MHz) | Average Power (dBm) | Tune-Up Limit (dBm) | Tune-up Scaling Factor | Duty Cycle % | Duty Cycle Scaling Factor | Power Drift (dB) | Measured 1g SAR (W/kg) | Reported 1g SAR (W/kg) |
|----------|------------|---------------|---------------|----------|-----------------|-----|-------------|---------------------|---------------------|------------------------|--------------|---------------------------|------------------|------------------------|------------------------|
| | WLAN2.4GHz | 802.11b 1Mbps | Front | 5mm | Full | 11 | 2462 | 18.50 | 19.50 | 1.259 | 99.31 | 1.007 | 0.08 | 0.234 | 0.297 |
| 24 | WLAN2.4GHz | 802.11b 1Mbps | Back | 5mm | Full | 11 | 2462 | 18.50 | 19.50 | 1.259 | 99.31 | 1.007 | 0.02 | 0.301 | 0.382 |
| | WLAN2.4GHz | 802.11b 1Mbps | Left Side | 5mm | Full | 11 | 2462 | 18.50 | 19.50 | 1.259 | 99.31 | 1.007 | 0.14 | 0.037 | 0.047 |
| | WLAN2.4GHz | 802.11b 1Mbps | Right Side | 5mm | Full | 11 | 2462 | 18.50 | 19.50 | 1.259 | 99.31 | 1.007 | 0.15 | 0.251 | 0.318 |
| | WLAN2.4GHz | 802.11b 1Mbps | Top Side | 5mm | Full | 11 | 2462 | 18.50 | 19.50 | 1.259 | 99.31 | 1.007 | 0.11 | 0.253 | 0.321 |

<WLAN5G SAR>

| Plot No. | Band | Mode | Test Position | Gap (mm) | Power Reduction | Ch. | Freq. (MHz) | Average Power (dBm) | Tune-Up Limit (dBm) | Tune-up Scaling Factor | Duty Cycle % | Duty Cycle Scaling Factor | Power Drift (dB) | Measured 1g SAR (W/kg) | Reported 1g SAR (W/kg) |
|----------|------------|---------------------|---------------|----------|-----------------|-----|-------------|---------------------|---------------------|------------------------|--------------|---------------------------|------------------|------------------------|------------------------|
| | WLAN5.2GHz | 802.11n-HT40 MCS0 | Front | 5mm | Full | 46 | 5230 | 17.40 | 19.00 | 1.445 | 96.32 | 1.038 | 0.11 | 0.270 | 0.405 |
| 25 | WLAN5.2GHz | 802.11n-HT40 MCS0 | Back | 5mm | Full | 46 | 5230 | 17.40 | 19.00 | 1.445 | 96.32 | 1.038 | 0.06 | 0.594 | 0.891 |
| | WLAN5.2GHz | 802.11n-HT40 MCS0 | Back | 5mm | Full | 38 | 5190 | 17.28 | 19.00 | 1.486 | 96.32 | 1.038 | 0.1 | 0.301 | 0.464 |
| | WLAN5.2GHz | 802.11n-HT40 MCS0 | Left Side | 5mm | Full | 46 | 5230 | 17.40 | 19.00 | 1.445 | 96.32 | 1.038 | 0.12 | 0.000 | 0.000 |
| | WLAN5.2GHz | 802.11n-HT40 MCS0 | Right Side | 5mm | Full | 46 | 5230 | 17.40 | 19.00 | 1.445 | 96.32 | 1.038 | -0.1 | 0.104 | 0.156 |
| | WLAN5.2GHz | 802.11n-HT40 MCS0 | Top Side | 5mm | Full | 46 | 5230 | 17.40 | 19.00 | 1.445 | 96.32 | 1.038 | 0.04 | 0.444 | 0.666 |
| | WLAN5.8GHz | 802.11ac-VHT80 MCS0 | Front | 5mm | Full | 155 | 5775 | 12.25 | 13.50 | 1.334 | 92.79 | 1.078 | 0.12 | 0.162 | 0.233 |
| | WLAN5.8GHz | 802.11ac-VHT80 MCS0 | Back | 5mm | Full | 155 | 5775 | 12.25 | 13.50 | 1.334 | 92.79 | 1.078 | -0.1 | 0.325 | 0.467 |
| | WLAN5.8GHz | 802.11ac-VHT80 MCS0 | Left Side | 5mm | Full | 155 | 5775 | 12.25 | 13.50 | 1.334 | 92.79 | 1.078 | 0.13 | 0.010 | 0.015 |
| | WLAN5.8GHz | 802.11ac-VHT80 MCS0 | Right Side | 5mm | Full | 155 | 5775 | 12.25 | 13.50 | 1.334 | 92.79 | 1.078 | 0.14 | 0.112 | 0.161 |
| 26 | WLAN5.8GHz | 802.11ac-VHT80 MCS0 | Top Side | 5mm | Full | 155 | 5775 | 12.25 | 13.50 | 1.334 | 92.79 | 1.078 | -0.19 | 0.525 | 0.755 |

<Bluetooth SAR>

| Plot No. | Band | Mode | Test Position | Gap (mm) | Power Reduction | Ch. | Freq. (MHz) | Average Power (dBm) | Tune-Up Limit (dBm) | Tune-up Scaling Factor | Duty Cycle % | Duty Cycle Scaling Factor | Power Drift (dB) | Measured 1g SAR (W/kg) | Reported 1g SAR (W/kg) |
|----------|-----------|-----------|---------------|----------|-----------------|-----|-------------|---------------------|---------------------|------------------------|--------------|---------------------------|------------------|------------------------|------------------------|
| | Bluetooth | DH5 1Mbps | Front | 5mm | Full | 39 | 2441 | 11.20 | 12.00 | 1.202 | 77.36 | 1.293 | 0.03 | 0.040 | 0.062 |
| 27 | Bluetooth | DH5 1Mbps | Back | 5mm | Full | 39 | 2441 | 11.20 | 12.00 | 1.202 | 77.36 | 1.293 | -0.15 | 0.053 | 0.082 |
| | Bluetooth | DH5 1Mbps | Left Side | 5mm | Full | 39 | 2441 | 11.20 | 12.00 | 1.202 | 77.36 | 1.293 | 0.04 | 0.004 | 0.006 |
| | Bluetooth | DH5 1Mbps | Right Side | 5mm | Full | 39 | 2441 | 11.20 | 12.00 | 1.202 | 77.36 | 1.293 | 0.11 | 0.043 | 0.066 |
| | Bluetooth | DH5 1Mbps | Top Side | 5mm | Full | 39 | 2441 | 11.20 | 12.00 | 1.202 | 77.36 | 1.293 | 0.06 | 0.038 | 0.058 |



15.3 Body Worn Accessory SAR

<GSM SAR>

| Plot No. | Band | Mode | Test Position | Gap (mm) | Headset | Power Reduction | Ch. | Freq. (MHz) | Average Power (dBm) | Tune-Up Limit (dBm) | Tune-up Scaling Factor | Power Drift (dB) | Measured 1g SAR (W/kg) | Reported 1g SAR (W/kg) |
|----------|---------|------------------|---------------|----------|-----------|-----------------|-----|-------------|---------------------|---------------------|------------------------|------------------|------------------------|------------------------|
| | GSM850 | GPRS(2 Tx slots) | Front | 5mm | - | Reduced | 251 | 848.8 | 29.84 | 30.50 | 1.164 | -0.13 | 0.555 | 0.646 |
| 28 | GSM850 | GPRS(2 Tx slots) | Back | 5mm | - | Reduced | 251 | 848.8 | 29.84 | 30.50 | 1.164 | 0.15 | 1.080 | 1.257 |
| | GSM850 | GPRS(2 Tx slots) | Back | 5mm | - | Reduced | 128 | 824.2 | 29.56 | 30.50 | 1.242 | 0.05 | 0.888 | 1.103 |
| | GSM850 | GPRS(2 Tx slots) | Back | 5mm | - | Reduced | 189 | 836.4 | 29.81 | 30.50 | 1.172 | -0.13 | 0.933 | 1.094 |
| | GSM850 | GPRS(2 Tx slots) | Back | 5mm | Headset 1 | Reduced | 251 | 848.8 | 29.84 | 30.50 | 1.164 | 0.15 | 1.010 | 1.176 |
| | GSM850 | GPRS(2 Tx slots) | Front | 12mm | - | Full | 251 | 848.8 | 31.09 | 32.00 | 1.233 | 0.1 | 0.367 | 0.453 |
| | GSM850 | GPRS(2 Tx slots) | Back | 20mm | - | Full | 251 | 848.8 | 31.09 | 32.00 | 1.233 | 0.02 | 0.403 | 0.497 |
| | GSM1900 | GPRS(2 Tx slots) | Front | 5mm | - | Reduced | 810 | 1909.8 | 26.44 | 27.50 | 1.276 | 0.02 | 0.629 | 0.803 |
| | GSM1900 | GPRS(2 Tx slots) | Front | 5mm | - | Reduced | 512 | 1850.2 | 26.14 | 27.50 | 1.368 | -0.13 | 0.783 | 1.071 |
| | GSM1900 | GPRS(2 Tx slots) | Front | 5mm | - | Reduced | 661 | 1880 | 26.42 | 27.50 | 1.282 | -0.14 | 0.732 | 0.939 |
| | GSM1900 | GPRS(2 Tx slots) | Back | 5mm | - | Reduced | 810 | 1909.8 | 26.44 | 27.50 | 1.276 | -0.17 | 0.740 | 0.945 |
| 29 | GSM1900 | GPRS(2 Tx slots) | Back | 5mm | - | Reduced | 512 | 1850.2 | 26.14 | 27.50 | 1.368 | -0.13 | 0.888 | 1.215 |
| | GSM1900 | GPRS(2 Tx slots) | Back | 5mm | - | Reduced | 661 | 1880 | 26.42 | 27.50 | 1.282 | -0.14 | 0.842 | 1.080 |
| | GSM1900 | GPRS(2 Tx slots) | Back | 5mm | Headset 1 | Reduced | 512 | 1850.2 | 26.14 | 27.50 | 1.368 | 0.02 | 0.878 | 1.201 |
| | GSM1900 | GPRS(2 Tx slots) | Front | 12mm | - | Full | 512 | 1850.2 | 28.21 | 29.50 | 1.346 | 0.03 | 0.610 | 0.821 |
| | GSM1900 | GPRS(2 Tx slots) | Back | 20mm | - | Full | 512 | 1850.2 | 28.21 | 29.50 | 1.346 | 0.07 | 0.276 | 0.371 |

<WCDMA SAR>

| Plot No. | Band | Mode | Test Position | Gap (mm) | Headset | Power Reduction | Ch. | Freq. (MHz) | Average Power (dBm) | Tune-Up Limit (dBm) | Tune-up Scaling Factor | Power Drift (dB) | Measured 1g SAR (W/kg) | Reported 1g SAR (W/kg) |
|----------|----------|--------------|---------------|----------|-----------|-----------------|------|-------------|---------------------|---------------------|------------------------|------------------|------------------------|------------------------|
| | WCDMA V | RMC 12.2Kbps | Front | 5mm | - | Reduced | 4132 | 826.4 | 22.35 | 23.00 | 1.161 | 0.16 | 0.526 | 0.611 |
| | WCDMA V | RMC 12.2Kbps | Back | 5mm | - | Reduced | 4132 | 826.4 | 22.35 | 23.00 | 1.161 | -0.15 | 0.940 | 1.092 |
| | WCDMA V | RMC 12.2Kbps | Back | 5mm | - | Reduced | 4182 | 836.4 | 22.33 | 23.00 | 1.167 | -0.03 | 0.964 | 1.125 |
| 30 | WCDMA V | RMC 12.2Kbps | Back | 5mm | - | Reduced | 4233 | 846.6 | 22.18 | 23.00 | 1.208 | -0.1 | 0.980 | 1.184 |
| | WCDMA V | RMC 12.2Kbps | Front | 12mm | - | Full | 4132 | 826.4 | 23.09 | 24.00 | 1.233 | 0.03 | 0.385 | 0.475 |
| | WCDMA V | RMC 12.2Kbps | Back | 20mm | - | Full | 4233 | 846.6 | 22.94 | 24.00 | 1.276 | 0.12 | 0.387 | 0.494 |
| | WCDMA IV | RMC 12.2Kbps | Front | 5mm | - | Reduced | 1413 | 1732.6 | 18.09 | 19.00 | 1.233 | -0.1 | 0.740 | 0.912 |
| | WCDMA IV | RMC 12.2Kbps | Back | 5mm | - | Reduced | 1413 | 1732.6 | 18.09 | 19.00 | 1.233 | -0.12 | 1.000 | 1.233 |
| | WCDMA IV | RMC 12.2Kbps | Front | 5mm | - | Reduced | 1312 | 1712.4 | 18.04 | 19.00 | 1.247 | -0.01 | 0.657 | 0.820 |
| | WCDMA IV | RMC 12.2Kbps | Front | 5mm | - | Reduced | 1513 | 1752.6 | 17.99 | 19.00 | 1.262 | -0.13 | 0.741 | 0.935 |
| | WCDMA IV | RMC 12.2Kbps | Back | 5mm | - | Reduced | 1312 | 1712.4 | 18.04 | 19.00 | 1.247 | -0.18 | 0.962 | 1.200 |
| 31 | WCDMA IV | RMC 12.2Kbps | Back | 5mm | - | Reduced | 1513 | 1752.6 | 17.99 | 19.00 | 1.262 | -0.07 | 1.080 | 1.363 |
| | WCDMA IV | RMC 12.2Kbps | Back | 5mm | Headset 1 | Reduced | 1513 | 1752.6 | 17.99 | 19.00 | 1.262 | 0.14 | 1.010 | 1.274 |
| | WCDMA IV | RMC 12.2Kbps | Front | 12mm | - | Full | 1513 | 1752.6 | 23.03 | 24.00 | 1.250 | 0.07 | 0.728 | 0.910 |
| | WCDMA IV | RMC 12.2Kbps | Back | 20mm | - | Full | 1513 | 1752.6 | 23.03 | 24.00 | 1.250 | 0.03 | 0.449 | 0.561 |
| | WCDMA II | RMC 12.2Kbps | Front | 5mm | - | Reduced | 9538 | 1907.6 | 20.06 | 21.00 | 1.242 | 0.06 | 0.736 | 0.914 |
| | WCDMA II | RMC 12.2Kbps | Back | 5mm | - | Reduced | 9538 | 1907.6 | 20.06 | 21.00 | 1.242 | -0.11 | 0.782 | 0.971 |
| | WCDMA II | RMC 12.2Kbps | Front | 5mm | - | Reduced | 9262 | 1852.4 | 19.90 | 21.00 | 1.288 | 0.03 | 0.754 | 0.971 |
| | WCDMA II | RMC 12.2Kbps | Front | 5mm | - | Reduced | 9400 | 1880 | 20.01 | 21.00 | 1.256 | 0.06 | 0.727 | 0.913 |
| 32 | WCDMA II | RMC 12.2Kbps | Back | 5mm | - | Reduced | 9262 | 1852.4 | 19.90 | 21.00 | 1.288 | -0.13 | 0.936 | 1.206 |
| | WCDMA II | RMC 12.2Kbps | Back | 5mm | - | Reduced | 9400 | 1880 | 20.01 | 21.00 | 1.256 | -0.19 | 0.851 | 1.069 |
| | WCDMA II | RMC 12.2Kbps | Back | 5mm | Headset 1 | Reduced | 9262 | 1852.4 | 19.90 | 21.00 | 1.288 | -0.06 | 0.923 | 1.189 |
| | WCDMA II | RMC 12.2Kbps | Front | 12mm | - | Full | 9262 | 1852.4 | 23.09 | 24.00 | 1.233 | 0.02 | 0.680 | 0.839 |
| | WCDMA II | RMC 12.2Kbps | Back | 20mm | - | Full | 9262 | 1852.4 | 23.09 | 24.00 | 1.233 | 0.06 | 0.377 | 0.465 |



<FDD LTE SAR>

| Plot No. | Band | BW (MHz) | Modulation | RB Size | RB offset | Test Position | Gap (mm) | Headset | Power Reduction | Ch. | Freq. (MHz) | Average Power (dBm) | Tune-Up Limit (dBm) | Tune-up Scaling Factor | Power Drift (dB) | Measured 1g SAR (W/kg) | Reported 1g SAR (W/kg) |
|-------------|-------------|----------|------------|---------|-----------|---------------|-----------|-----------|-----------------|--------|-------------|---------------------|---------------------|------------------------|------------------|------------------------|------------------------|
| 33 | LTE Band 5 | 10M | QPSK | 1 | 25 | Front | 5mm | - | Reduced | 20525 | 836.5 | 22.81 | 23.50 | 1.172 | 0.05 | 0.603 | 0.707 |
| | LTE Band 5 | 10M | QPSK | 1 | 25 | Back | 5mm | - | Reduced | 20525 | 836.5 | 22.81 | 23.50 | 1.172 | -0.16 | 1.160 | 1.360 |
| | LTE Band 5 | 10M | QPSK | 1 | 25 | Back | 5mm | Headset 1 | Reduced | 20525 | 836.5 | 22.81 | 23.50 | 1.172 | 0.08 | 1.100 | 1.289 |
| | LTE Band 5 | 10M | QPSK | 1 | 25 | Front | 12mm | - | Full | 20525 | 836.5 | 23.25 | 24.00 | 1.189 | 0.11 | 0.373 | 0.443 |
| | LTE Band 5 | 10M | QPSK | 1 | 25 | Back | 20mm | - | Full | 20525 | 836.5 | 23.25 | 24.00 | 1.189 | 0.12 | 0.416 | 0.494 |
| | LTE Band 5 | 10M | QPSK | 25 | 12 | Front | 5mm | - | Reduced | 20525 | 836.5 | 21.61 | 22.50 | 1.227 | -0.09 | 0.319 | 0.392 |
| | LTE Band 5 | 10M | QPSK | 25 | 12 | Back | 5mm | - | Reduced | 20525 | 836.5 | 21.61 | 22.50 | 1.227 | -0.14 | 0.620 | 0.761 |
| | LTE Band 5 | 10M | QPSK | 50 | 0 | Back | 5mm | - | Reduced | 20525 | 836.5 | 21.50 | 22.50 | 1.259 | -0.07 | 0.616 | 0.775 |
| | LTE Band 66 | 20M | QPSK | 1 | 49 | Front | 5mm | - | Reduced | 132322 | 1745 | 18.26 | 19.00 | 1.186 | 0.02 | 0.778 | 0.923 |
| | LTE Band 66 | 20M | QPSK | 1 | 49 | Back | 5mm | - | Reduced | 132322 | 1745 | 18.26 | 19.00 | 1.186 | 0.06 | 1.150 | 1.364 |
| LTE Band 66 | 20M | QPSK | 1 | 49 | Front | 5mm | - | Reduced | 132072 | 1720 | 17.80 | 19.00 | 1.318 | -0.1 | 0.686 | 0.904 | |
| LTE Band 66 | 20M | QPSK | 1 | 49 | Front | 5mm | - | Reduced | 132572 | 1770 | 18.22 | 19.00 | 1.197 | 0.03 | 0.791 | 0.947 | |
| LTE Band 66 | 20M | QPSK | 1 | 49 | Back | 5mm | - | Reduced | 132072 | 1720 | 17.80 | 19.00 | 1.318 | 0.06 | 1.020 | 1.345 | |
| LTE Band 66 | 20M | QPSK | 1 | 49 | Back | 5mm | - | Reduced | 132572 | 1770 | 18.22 | 19.00 | 1.197 | -0.13 | 1.110 | 1.328 | |
| LTE Band 66 | 20M | QPSK | 1 | 49 | Back | 5mm | Headset 1 | Reduced | 132322 | 1745 | 18.26 | 19.00 | 1.186 | -0.19 | 1.020 | 1.209 | |
| LTE Band 66 | 20M | QPSK | 1 | 49 | Front | 12mm | - | Full | 132572 | 1770 | 23.02 | 24.00 | 1.253 | 0.04 | 0.694 | 0.870 | |
| LTE Band 66 | 20M | QPSK | 1 | 49 | Back | 20mm | - | Full | 132322 | 1745 | 23.10 | 24.00 | 1.230 | -0.01 | 0.421 | 0.518 | |
| LTE Band 66 | 20M | QPSK | 50 | 24 | Front | 5mm | - | Reduced | 132322 | 1745 | 18.15 | 19.00 | 1.216 | 0.06 | 0.765 | 0.930 | |
| LTE Band 66 | 20M | QPSK | 50 | 24 | Front | 5mm | - | Reduced | 132072 | 1720 | 17.78 | 19.00 | 1.324 | -0.13 | 0.678 | 0.898 | |
| LTE Band 66 | 20M | QPSK | 50 | 24 | Front | 5mm | - | Reduced | 132572 | 1770 | 17.93 | 19.00 | 1.279 | -0.19 | 0.751 | 0.961 | |
| LTE Band 66 | 20M | QPSK | 50 | 24 | Back | 5mm | - | Reduced | 132322 | 1745 | 18.15 | 19.00 | 1.216 | -0.06 | 1.130 | 1.374 | |
| LTE Band 66 | 20M | QPSK | 50 | 24 | Back | 5mm | Headset 1 | Reduced | 132322 | 1745 | 18.15 | 19.00 | 1.216 | -0.06 | 1.140 | 1.386 | |
| LTE Band 66 | 20M | QPSK | 50 | 24 | Back | 5mm | - | Reduced | 132072 | 1720 | 17.78 | 19.00 | 1.324 | -0.07 | 0.952 | 1.261 | |
| LTE Band 66 | 20M | QPSK | 50 | 24 | Back | 5mm | - | Reduced | 132572 | 1770 | 17.93 | 19.00 | 1.279 | 0.05 | 1.030 | 1.318 | |
| LTE Band 66 | 20M | QPSK | 50 | 24 | Front | 12mm | - | Full | 132572 | 1770 | 22.33 | 23.00 | 1.167 | 0.02 | 0.510 | 0.595 | |
| LTE Band 66 | 20M | QPSK | 50 | 24 | Back | 20mm | Headset 1 | Full | 132322 | 1745 | 22.55 | 23.00 | 1.109 | 0.08 | 0.361 | 0.400 | |
| LTE Band 66 | 20M | QPSK | 100 | 0 | Front | 5mm | - | Reduced | 132322 | 1745 | 18.14 | 19.00 | 1.219 | 0.03 | 0.836 | 1.019 | |
| 34 | LTE Band 66 | 20M | QPSK | 100 | 0 | Back | 5mm | - | Reduced | 132322 | 1745 | 18.14 | 19.00 | 1.219 | -0.17 | 1.180 | 1.438 |
| | LTE Band 66 | 20M | QPSK | 100 | 0 | Back | 5mm | Headset 1 | Reduced | 132322 | 1745 | 18.14 | 19.00 | 1.219 | -0.17 | 1.150 | 1.402 |
| | LTE Band 66 | 20M | QPSK | 100 | 0 | Back | 5mm | Headset 2 | Reduced | 132322 | 1745 | 18.14 | 19.00 | 1.219 | 0.02 | 1.130 | 1.377 |
| | LTE Band 66 | 20M | QPSK | 100 | 0 | Back | 5mm | Headset 3 | Reduced | 132322 | 1745 | 18.14 | 19.00 | 1.219 | -0.05 | 1.130 | 1.377 |
| | LTE Band 66 | 20M | QPSK | 100 | 0 | Back | 5mm | Headset 4 | Reduced | 132322 | 1745 | 18.14 | 19.00 | 1.219 | 0.01 | 1.120 | 1.365 |
| | LTE Band 66 | 20M | QPSK | 100 | 0 | Back | 5mm | Headset 5 | Reduced | 132322 | 1745 | 18.14 | 19.00 | 1.219 | -0.04 | 1.130 | 1.377 |
| | LTE Band 66 | 20M | QPSK | 100 | 0 | Front | 12mm | - | Full | 132322 | 1745 | 22.52 | 23.00 | 1.117 | 0.01 | 0.490 | 0.547 |
| | LTE Band 66 | 20M | QPSK | 100 | 0 | Back | 20mm | - | Full | 132322 | 1745 | 22.52 | 23.00 | 1.117 | 0.09 | 0.355 | 0.396 |



| Plot No. | Band | BW (MHz) | Modulation | RB Size | RB offset | Test Position | Gap (mm) | Headset | Power Reduction | Ch. | Freq. (MHz) | Average Power (dBm) | Tune-Up Limit (dBm) | Tune-up Scaling Factor | Power Drift (dB) | Measured 1g SAR (W/kg) | Reported 1g SAR (W/kg) |
|----------|------------|----------|------------|---------|-----------|---------------|----------|-----------|-----------------|-------|-------------|---------------------|---------------------|------------------------|------------------|------------------------|------------------------|
| | LTE Band 2 | 20M | QPSK | 1 | 49 | Front | 5mm | - | Reduced | 19100 | 1900 | 21.42 | 22.00 | 1.143 | 0.03 | 0.872 | 0.997 |
| | LTE Band 2 | 20M | QPSK | 1 | 49 | Back | 5mm | - | Reduced | 19100 | 1900 | 21.42 | 22.00 | 1.143 | 0.07 | 1.160 | 1.326 |
| | LTE Band 2 | 20M | QPSK | 1 | 49 | Front | 5mm | - | Reduced | 18700 | 1860 | 21.41 | 22.00 | 1.146 | 0.02 | 1.150 | 1.317 |
| | LTE Band 2 | 20M | QPSK | 1 | 49 | Front | 5mm | - | Reduced | 18900 | 1880 | 21.27 | 22.00 | 1.183 | 0.08 | 0.920 | 1.088 |
| 35 | LTE Band 2 | 20M | QPSK | 1 | 49 | Back | 5mm | - | Reduced | 18700 | 1860 | 21.41 | 22.00 | 1.146 | -0.04 | 1.260 | 1.443 |
| | LTE Band 2 | 20M | QPSK | 1 | 49 | Back | 5mm | - | Reduced | 18900 | 1880 | 21.27 | 22.00 | 1.183 | 0.04 | 1.160 | 1.372 |
| | LTE Band 2 | 20M | QPSK | 1 | 49 | Front | 5mm | Headset 1 | Reduced | 18700 | 1860 | 21.41 | 22.00 | 1.146 | 0.06 | 1.110 | 1.272 |
| | LTE Band 2 | 20M | QPSK | 1 | 49 | Back | 5mm | Headset 1 | Reduced | 18700 | 1860 | 21.41 | 22.00 | 1.146 | 0.03 | 1.210 | 1.386 |
| | LTE Band 2 | 20M | QPSK | 1 | 49 | Front | 12mm | - | Full | 18700 | 1860 | 23.03 | 24.00 | 1.250 | -0.02 | 0.590 | 0.738 |
| | LTE Band 2 | 20M | QPSK | 1 | 49 | Back | 20mm | - | Full | 18700 | 1860 | 23.03 | 24.00 | 1.250 | -0.07 | 0.328 | 0.410 |
| | LTE Band 2 | 20M | QPSK | 50 | 24 | Front | 5mm | - | Reduced | 19100 | 1900 | 21.16 | 22.00 | 1.213 | -0.03 | 0.799 | 0.969 |
| | LTE Band 2 | 20M | QPSK | 50 | 24 | Front | 5mm | - | Reduced | 18700 | 1860 | 21.14 | 22.00 | 1.219 | 0.07 | 0.851 | 1.037 |
| | LTE Band 2 | 20M | QPSK | 50 | 24 | Front | 5mm | - | Reduced | 18900 | 1880 | 21.09 | 22.00 | 1.233 | 0.02 | 0.808 | 0.996 |
| | LTE Band 2 | 20M | QPSK | 50 | 24 | Back | 5mm | - | Reduced | 19100 | 1900 | 21.16 | 22.00 | 1.213 | -0.07 | 0.992 | 1.204 |
| | LTE Band 2 | 20M | QPSK | 50 | 24 | Back | 5mm | - | Reduced | 18700 | 1860 | 21.14 | 22.00 | 1.219 | 0.05 | 1.160 | 1.414 |
| | LTE Band 2 | 20M | QPSK | 50 | 24 | Back | 5mm | - | Reduced | 18900 | 1880 | 21.09 | 22.00 | 1.233 | -0.02 | 1.040 | 1.282 |
| | LTE Band 2 | 20M | QPSK | 50 | 24 | Back | 5mm | Headset 1 | Reduced | 18700 | 1860 | 21.14 | 22.00 | 1.219 | 0.02 | 1.130 | 1.377 |
| | LTE Band 2 | 20M | QPSK | 100 | 0 | Front | 5mm | - | Reduced | 19100 | 1900 | 21.14 | 22.00 | 1.219 | -0.02 | 0.722 | 0.880 |
| | LTE Band 2 | 20M | QPSK | 100 | 0 | Back | 5mm | - | Reduced | 19100 | 1900 | 21.14 | 22.00 | 1.219 | 0.05 | 1.010 | 1.231 |
| | LTE Band 2 | 20M | QPSK | 100 | 0 | Back | 5mm | Headset 1 | Reduced | 19100 | 1900 | 21.14 | 22.00 | 1.219 | 0.01 | 1.000 | 1.219 |
| | LTE Band 7 | 20M | QPSK | 1 | 49 | Front | 5mm | - | Reduced | 21100 | 2535 | 16.34 | 17.00 | 1.164 | 0.02 | 0.419 | 0.488 |
| | LTE Band 7 | 20M | QPSK | 1 | 49 | Back | 5mm | - | Reduced | 21100 | 2535 | 16.34 | 17.00 | 1.164 | -0.1 | 0.919 | 1.070 |
| 36 | LTE Band 7 | 20M | QPSK | 1 | 49 | Back | 5mm | - | Reduced | 20850 | 2510 | 16.32 | 17.00 | 1.169 | -0.04 | 1.030 | 1.205 |
| | LTE Band 7 | 20M | QPSK | 1 | 49 | Back | 5mm | - | Reduced | 21350 | 2560 | 16.21 | 17.00 | 1.199 | -0.19 | 0.815 | 0.978 |
| | LTE Band 7 | 20M | QPSK | 1 | 49 | Back | 5mm | Headset 1 | Reduced | 20850 | 2510 | 16.32 | 17.00 | 1.169 | 0.02 | 1.010 | 1.181 |
| | LTE Band 7 | 20M | QPSK | 1 | 49 | Front | 12mm | - | Full | 21100 | 2535 | 23.29 | 24.00 | 1.178 | 0.08 | 0.410 | 0.483 |
| | LTE Band 7 | 20M | QPSK | 1 | 49 | Back | 20mm | - | Full | 20850 | 2510 | 22.90 | 24.00 | 1.288 | -0.02 | 0.458 | 0.590 |
| | LTE Band 7 | 20M | QPSK | 50 | 24 | Front | 5mm | - | Reduced | 21100 | 2535 | 16.26 | 17.00 | 1.186 | 0.08 | 0.428 | 0.508 |
| | LTE Band 7 | 20M | QPSK | 50 | 24 | Back | 5mm | - | Reduced | 21100 | 2535 | 16.26 | 17.00 | 1.186 | 0.05 | 0.870 | 1.032 |
| | LTE Band 7 | 20M | QPSK | 50 | 24 | Back | 5mm | - | Reduced | 20850 | 2510 | 16.19 | 17.00 | 1.205 | 0.04 | 0.939 | 1.132 |
| | LTE Band 7 | 20M | QPSK | 50 | 24 | Back | 5mm | - | Reduced | 21350 | 2560 | 16.16 | 17.00 | 1.213 | 0.03 | 0.788 | 0.956 |
| | LTE Band 7 | 20M | QPSK | 100 | 0 | Back | 5mm | - | Reduced | 21100 | 2535 | 16.23 | 17.00 | 1.194 | -0.04 | 0.858 | 1.024 |



<WLAN2.4G SAR>

| Plot No. | Band | Mode | Test Position | Gap (mm) | Headset | Power Reduction | Ch. | Freq. (MHz) | Average Power (dBm) | Tune-Up Limit (dBm) | Tune-up Scaling Factor | Duty Cycle % | Duty Cycle Scaling Factor | Power Drift (dB) | Measured 1g SAR (W/kg) | Reported 1g SAR (W/kg) |
|----------|------------|---------------|---------------|----------|---------|-----------------|-----|-------------|---------------------|---------------------|------------------------|--------------|---------------------------|------------------|------------------------|------------------------|
| | WLAN2.4GHz | 802.11b 1Mbps | Front | 5mm | - | Full | 11 | 2462 | 18.50 | 19.50 | 1.259 | 99.31 | 1.007 | 0.08 | 0.234 | 0.297 |
| 37 | WLAN2.4GHz | 802.11b 1Mbps | Back | 5mm | - | Full | 11 | 2462 | 18.50 | 19.50 | 1.259 | 99.31 | 1.007 | 0.02 | 0.301 | 0.382 |

<WLAN5G SAR>

| Plot No. | Band | Mode | Test Position | Gap (mm) | Headset | Power Reduction | Ch. | Freq. (MHz) | Average Power (dBm) | Tune-Up Limit (dBm) | Tune-up Scaling Factor | Duty Cycle % | Duty Cycle Scaling Factor | Power Drift (dB) | Measured 1g SAR (W/kg) | Reported 1g SAR (W/kg) |
|----------|------------|---------------------|---------------|----------|---------|-----------------|-----|-------------|---------------------|---------------------|------------------------|--------------|---------------------------|------------------|------------------------|------------------------|
| | WLAN5.3GHz | 802.11n-HT40 MCS0 | Front | 5mm | - | Full | 54 | 5270 | 17.24 | 19.00 | 1.500 | 96.32 | 1.038 | 0.1 | 0.292 | 0.455 |
| 38 | WLAN5.3GHz | 802.11n-HT40 MCS0 | Back | 5mm | - | Full | 54 | 5270 | 17.24 | 19.00 | 1.500 | 96.32 | 1.038 | 0.11 | 0.614 | 0.956 |
| | WLAN5.3GHz | 802.11n-HT40 MCS0 | Back | 5mm | - | Full | 62 | 5310 | 15.72 | 17.00 | 1.343 | 96.32 | 1.038 | 0.1 | 0.532 | 0.741 |
| | WLAN5.5GHz | 802.11ac-VHT80 MCS0 | Front | 5mm | - | Reduced | 122 | 5610 | 13.54 | 15.00 | 1.400 | 92.79 | 1.078 | 0.02 | 0.256 | 0.386 |
| | WLAN5.5GHz | 802.11ac-VHT80 MCS0 | Back | 5mm | - | Reduced | 122 | 5610 | 13.54 | 15.00 | 1.400 | 92.79 | 1.078 | 0.03 | 0.575 | 0.868 |
| 39 | WLAN5.5GHz | 802.11ac-VHT80 MCS0 | Back | 5mm | - | Reduced | 138 | 5690 | 13.49 | 15.00 | 1.416 | 92.79 | 1.078 | -0.03 | 0.656 | 1.001 |
| | WLAN5.5GHz | 802.11ac-VHT80 MCS0 | Front | 12mm | - | Full | 122 | 5610 | 17.54 | 19.00 | 1.400 | 92.79 | 1.078 | 0.08 | 0.202 | 0.305 |
| | WLAN5.5GHz | 802.11ac-VHT80 MCS0 | Back | 20mm | - | Full | 138 | 5690 | 17.49 | 19.00 | 1.416 | 92.79 | 1.078 | 0.02 | 0.439 | 0.670 |
| | WLAN5.8GHz | 802.11ac-VHT80 MCS0 | Front | 5mm | - | Full | 155 | 5775 | 12.25 | 13.50 | 1.334 | 92.79 | 1.078 | 0.12 | 0.162 | 0.233 |
| 40 | WLAN5.8GHz | 802.11ac-VHT80 MCS0 | Back | 5mm | - | Full | 155 | 5775 | 12.25 | 13.50 | 1.334 | 92.79 | 1.078 | -0.1 | 0.325 | 0.467 |

<Bluetooth SAR>

| Plot No. | Band | Mode | Test Position | Gap (mm) | Headset | Power Reduction | Ch. | Freq. (MHz) | Average Power (dBm) | Tune-Up Limit (dBm) | Tune-up Scaling Factor | Duty Cycle % | Duty Cycle Scaling Factor | Power Drift (dB) | Measured 1g SAR (W/kg) | Reported 1g SAR (W/kg) |
|----------|-----------|-----------|---------------|----------|---------|-----------------|-----|-------------|---------------------|---------------------|------------------------|--------------|---------------------------|------------------|------------------------|------------------------|
| | Bluetooth | DH5 1Mbps | Front | 5mm | - | Full | 39 | 2441 | 11.20 | 12.00 | 1.202 | 77.36 | 1.293 | 0.03 | 0.040 | 0.062 |
| 41 | Bluetooth | DH5 1Mbps | Back | 5mm | - | Full | 39 | 2441 | 11.20 | 12.00 | 1.202 | 77.36 | 1.293 | -0.15 | 0.053 | 0.082 |



15.4 Product specific 10g SAR

<GSM SAR>

| Plot No. | Band | Mode | Test Position | Gap (mm) | Power Reduction | Ch. | Freq. (MHz) | Average Power (dBm) | Tune-Up Limit (dBm) | Tune-up Scaling Factor | Power Drift (dB) | Measured 10g SAR (W/kg) | Reported 10g SAR (W/kg) |
|----------|---------|------------------|---------------|----------|-----------------|-----|-------------|---------------------|---------------------|------------------------|------------------|-------------------------|-------------------------|
| 42 | GSM850 | GPRS(2 Tx slots) | Back | 0mm | Full | 251 | 848.8 | 31.09 | 32.00 | 1.233 | 0.15 | 1.460 | 1.800 |
| 43 | GSM1900 | GPRS(2 Tx slots) | Bottom Side | 0mm | Full | 661 | 1880 | 28.25 | 29.50 | 1.334 | -0.14 | 2.690 | 3.587 |
| | GSM1900 | GPRS(2 Tx slots) | Bottom Side | 0mm | Full | 810 | 1909.8 | 28.24 | 29.50 | 1.337 | -0.03 | 2.620 | 3.502 |
| | GSM1900 | GPRS(2 Tx slots) | Bottom Side | 0mm | Full | 512 | 1850.2 | 28.21 | 29.50 | 1.346 | -0.07 | 2.660 | 3.580 |
| | GSM1900 | GPRS(2 Tx slots) | Front | 0mm | Full | 661 | 1880 | 28.25 | 29.50 | 1.334 | 0.06 | 1.470 | 1.960 |
| | GSM1900 | GPRS(2 Tx slots) | Back | 0mm | Full | 661 | 1880 | 28.25 | 29.50 | 1.334 | -0.05 | 1.870 | 2.494 |
| | GSM1900 | GPRS(2 Tx slots) | Back | 0mm | Full | 810 | 1909.8 | 28.24 | 29.50 | 1.337 | 0.1 | 2.090 | 2.793 |
| | GSM1900 | GPRS(2 Tx slots) | Back | 0mm | Full | 512 | 1850.2 | 28.21 | 29.50 | 1.346 | -0.15 | 1.890 | 2.544 |

<WCDMA SAR>

| Plot No. | Band | Mode | Test Position | Gap (mm) | Power Reduction | Ch. | Freq. (MHz) | Average Power (dBm) | Tune-Up Limit (dBm) | Tune-up Scaling Factor | Power Drift (dB) | Measured 10g SAR (W/kg) | Reported 10g SAR (W/kg) |
|----------|----------|--------------|---------------|----------|-----------------|------|-------------|---------------------|---------------------|------------------------|------------------|-------------------------|-------------------------|
| | WCDMA V | RMC 12.2Kbps | Back | 0mm | Full | 4182 | 836.4 | 23.13 | 24.00 | 1.222 | -0.07 | 2.290 | 2.798 |
| | WCDMA V | RMC 12.2Kbps | Back | 0mm | Full | 4132 | 826.4 | 23.09 | 24.00 | 1.233 | -0.02 | 2.280 | 2.811 |
| 44 | WCDMA V | RMC 12.2Kbps | Back | 0mm | Full | 4233 | 846.6 | 22.94 | 24.00 | 1.276 | 0.04 | 2.590 | 3.306 |
| | WCDMA IV | RMC 12.2Kbps | Front | 0mm | Reduced | 1413 | 1732.6 | 20.67 | 21.50 | 1.211 | 0.05 | 1.790 | 2.167 |
| | WCDMA IV | RMC 12.2Kbps | Front | 0mm | Reduced | 1312 | 1712.4 | 20.58 | 21.50 | 1.236 | 0.04 | 1.670 | 2.064 |
| | WCDMA IV | RMC 12.2Kbps | Front | 0mm | Reduced | 1513 | 1752.6 | 20.59 | 21.50 | 1.233 | 0.03 | 1.740 | 2.146 |
| | WCDMA IV | RMC 12.2Kbps | Back | 0mm | Reduced | 1413 | 1732.6 | 20.67 | 21.50 | 1.211 | 0.04 | 2.650 | 3.208 |
| | WCDMA IV | RMC 12.2Kbps | Back | 0mm | Reduced | 1312 | 1712.4 | 20.58 | 21.50 | 1.236 | 0.01 | 2.610 | 3.226 |
| | WCDMA IV | RMC 12.2Kbps | Back | 0mm | Reduced | 1513 | 1752.6 | 20.59 | 21.50 | 1.233 | 0.06 | 2.400 | 2.959 |
| | WCDMA IV | RMC 12.2Kbps | Bottom Side | 0mm | Reduced | 1413 | 1732.6 | 20.67 | 21.50 | 1.211 | 0.11 | 2.780 | 3.365 |
| | WCDMA IV | RMC 12.2Kbps | Bottom Side | 0mm | Reduced | 1312 | 1712.4 | 20.58 | 21.50 | 1.236 | -0.02 | 2.690 | 3.325 |
| 45 | WCDMA IV | RMC 12.2Kbps | Bottom Side | 0mm | Reduced | 1513 | 1752.6 | 20.59 | 21.50 | 1.233 | -0.08 | 2.840 | 3.502 |
| | WCDMA IV | RMC 12.2Kbps | Front | 9mm | Full | 1413 | 1732.6 | 23.04 | 24.00 | 1.247 | 0.04 | 0.686 | 0.856 |
| | WCDMA IV | RMC 12.2Kbps | Back | 13mm | Full | 1312 | 1712.4 | 22.90 | 24.00 | 1.288 | -0.07 | 0.650 | 0.837 |
| | WCDMA IV | RMC 12.2Kbps | Bottom Side | 10mm | Full | 1513 | 1752.6 | 23.03 | 24.00 | 1.250 | 0.02 | 1.020 | 1.275 |
| | WCDMA II | RMC 12.2Kbps | Front | 0mm | Reduced | 9538 | 1907.6 | 21.16 | 22.00 | 1.213 | -0.06 | 1.320 | 1.602 |
| | WCDMA II | RMC 12.2Kbps | Back | 0mm | Reduced | 9538 | 1907.6 | 21.16 | 22.00 | 1.213 | 0.14 | 1.540 | 1.869 |
| | WCDMA II | RMC 12.2Kbps | Bottom Side | 0mm | Reduced | 9538 | 1907.6 | 21.16 | 22.00 | 1.213 | 0.07 | 2.230 | 2.706 |
| 46 | WCDMA II | RMC 12.2Kbps | Bottom Side | 0mm | Reduced | 9262 | 1852.4 | 21.09 | 22.00 | 1.233 | -0.17 | 2.570 | 3.169 |
| | WCDMA II | RMC 12.2Kbps | Bottom Side | 0mm | Reduced | 9400 | 1880 | 21.12 | 22.00 | 1.225 | -0.16 | 2.450 | 3.000 |
| | WCDMA II | RMC 12.2Kbps | Front | 9mm | Full | 9538 | 1907.6 | 23.22 | 24.00 | 1.197 | 0.12 | 0.553 | 0.662 |
| | WCDMA II | RMC 12.2Kbps | Back | 13mm | Full | 9538 | 1907.6 | 23.22 | 24.00 | 1.197 | 0.02 | 0.403 | 0.482 |
| | WCDMA II | RMC 12.2Kbps | Bottom Side | 10mm | Full | 9262 | 1852.4 | 23.09 | 24.00 | 1.233 | -0.03 | 0.672 | 0.829 |



<FDD LTE SAR>

| Plot No. | Band | BW (MHz) | Modulation | RB Size | RB offset | Test Position | Gap (mm) | Power Reduction | Ch. | Freq. (MHz) | Average Power (dBm) | Tune-Up Limit (dBm) | Tune-up Scaling Factor | Power Drift (dB) | Measured 10g SAR (W/kg) | Reported 10g SAR (W/kg) |
|----------|-------------|----------|------------|---------|-----------|---------------|----------|-----------------|--------|-------------|---------------------|---------------------|------------------------|------------------|-------------------------|-------------------------|
| 47 | LTE Band 5 | 10M | QPSK | 1 | 25 | Back | 0mm | Full | 20525 | 836.5 | 23.25 | 24.00 | 1.189 | 0.08 | 2.030 | 2.413 |
| | LTE Band 5 | 10M | QPSK | 25 | 12 | Back | 0mm | Full | 20525 | 836.5 | 22.05 | 23.00 | 1.245 | 0.07 | 1.170 | 1.456 |
| | LTE Band 5 | 10M | QPSK | 50 | 0 | Back | 0mm | Full | 20525 | 836.5 | 21.94 | 23.00 | 1.276 | 0.07 | 1.150 | 1.468 |
| | LTE Band 66 | 20M | QPSK | 1 | 49 | Front | 0mm | Reduced | 132322 | 1745 | 20.98 | 21.50 | 1.127 | 0.02 | 1.850 | 2.085 |
| | LTE Band 66 | 20M | QPSK | 1 | 49 | Front | 0mm | Reduced | 132072 | 1720 | 20.61 | 21.50 | 1.227 | -0.1 | 1.560 | 1.915 |
| | LTE Band 66 | 20M | QPSK | 1 | 49 | Front | 0mm | Reduced | 132572 | 1770 | 20.78 | 21.50 | 1.180 | 0.03 | 1.660 | 1.959 |
| | LTE Band 66 | 20M | QPSK | 1 | 49 | Back | 0mm | Reduced | 132322 | 1745 | 20.98 | 21.50 | 1.127 | 0.06 | 2.740 | 3.089 |
| | LTE Band 66 | 20M | QPSK | 1 | 49 | Back | 0mm | Reduced | 132072 | 1720 | 20.61 | 21.50 | 1.227 | -0.13 | 2.380 | 2.921 |
| | LTE Band 66 | 20M | QPSK | 1 | 49 | Back | 0mm | Reduced | 132572 | 1770 | 20.78 | 21.50 | 1.180 | -0.19 | 2.230 | 2.632 |
| | LTE Band 66 | 20M | QPSK | 1 | 49 | Bottom Side | 0mm | Reduced | 132322 | 1745 | 20.98 | 21.50 | 1.127 | -0.06 | 2.890 | 3.258 |
| | LTE Band 66 | 20M | QPSK | 1 | 49 | Bottom Side | 0mm | Reduced | 132072 | 1720 | 20.61 | 21.50 | 1.227 | -0.07 | 2.770 | 3.400 |
| | LTE Band 66 | 20M | QPSK | 1 | 49 | Bottom Side | 0mm | Reduced | 132572 | 1770 | 20.78 | 21.50 | 1.180 | -0.04 | 2.940 | 3.470 |
| | LTE Band 66 | 20M | QPSK | 1 | 49 | Front | 9mm | Full | 132322 | 1745 | 23.10 | 24.00 | 1.230 | 0.02 | 0.595 | 0.732 |
| | LTE Band 66 | 20M | QPSK | 1 | 49 | Back | 13mm | Full | 132322 | 1745 | 23.10 | 24.00 | 1.230 | 0.06 | 0.544 | 0.669 |
| | LTE Band 66 | 20M | QPSK | 1 | 49 | Bottom Side | 10mm | Full | 132572 | 1770 | 23.02 | 24.00 | 1.253 | 0.01 | 1.070 | 1.341 |
| | LTE Band 66 | 20M | QPSK | 50 | 24 | Front | 0mm | Reduced | 132322 | 1745 | 20.93 | 21.50 | 1.140 | -0.07 | 1.840 | 2.098 |
| | LTE Band 66 | 20M | QPSK | 50 | 24 | Front | 0mm | Reduced | 132072 | 1720 | 20.52 | 21.50 | 1.253 | 0.05 | 1.550 | 1.942 |
| | LTE Band 66 | 20M | QPSK | 50 | 24 | Front | 0mm | Reduced | 132572 | 1770 | 20.75 | 21.50 | 1.189 | -0.02 | 1.660 | 1.973 |
| | LTE Band 66 | 20M | QPSK | 50 | 24 | Back | 0mm | Reduced | 132322 | 1745 | 20.93 | 21.50 | 1.140 | 0.08 | 2.510 | 2.862 |
| | LTE Band 66 | 20M | QPSK | 50 | 24 | Back | 0mm | Reduced | 132072 | 1720 | 20.52 | 21.50 | 1.253 | 0.05 | 2.430 | 3.045 |
| | LTE Band 66 | 20M | QPSK | 50 | 24 | Back | 0mm | Reduced | 132572 | 1770 | 20.75 | 21.50 | 1.189 | -0.02 | 2.140 | 2.543 |
| | LTE Band 66 | 20M | QPSK | 50 | 24 | Bottom Side | 0mm | Reduced | 132322 | 1745 | 20.93 | 21.50 | 1.140 | 0.02 | 3.130 | 3.569 |
| | LTE Band 66 | 20M | QPSK | 50 | 24 | Bottom Side | 0mm | Reduced | 132072 | 1720 | 20.52 | 21.50 | 1.253 | 0.03 | 2.850 | 3.571 |
| | LTE Band 66 | 20M | QPSK | 50 | 24 | Bottom Side | 0mm | Reduced | 132572 | 1770 | 20.75 | 21.50 | 1.189 | 0.06 | 2.970 | 3.530 |
| | LTE Band 66 | 20M | QPSK | 50 | 24 | Front | 9mm | Full | 132322 | 1745 | 22.55 | 23.00 | 1.109 | 0.03 | 0.450 | 0.499 |
| | LTE Band 66 | 20M | QPSK | 50 | 24 | Back | 13mm | Full | 132072 | 1720 | 22.37 | 23.00 | 1.156 | 0.01 | 0.400 | 0.462 |
| | LTE Band 66 | 20M | QPSK | 50 | 24 | Bottom Side | 10mm | Full | 132072 | 1720 | 22.37 | 23.00 | 1.156 | 0.07 | 0.860 | 0.994 |
| | LTE Band 66 | 20M | QPSK | 100 | 0 | Front | 0mm | Reduced | 132322 | 1745 | 20.91 | 21.50 | 1.146 | 0.03 | 1.780 | 2.039 |
| | LTE Band 66 | 20M | QPSK | 100 | 0 | Back | 0mm | Reduced | 132322 | 1745 | 20.91 | 21.50 | 1.146 | 0.14 | 2.750 | 3.150 |
| 48 | LTE Band 66 | 20M | QPSK | 100 | 0 | Bottom Side | 0mm | Reduced | 132322 | 1745 | 20.91 | 21.50 | 1.146 | 0.11 | 3.120 | 3.574 |
| | LTE Band 66 | 20M | QPSK | 100 | 0 | Front | 9mm | Full | 132322 | 1745 | 22.52 | 23.00 | 1.117 | 0.02 | 0.430 | 0.480 |
| | LTE Band 66 | 20M | QPSK | 100 | 0 | Back | 13mm | Full | 132322 | 1745 | 22.52 | 23.00 | 1.117 | 0.09 | 0.394 | 0.440 |
| | LTE Band 66 | 20M | QPSK | 100 | 0 | Bottom Side | 10mm | Full | 132322 | 1745 | 22.52 | 23.00 | 1.117 | 0.03 | 0.810 | 0.905 |
| | LTE Band 2 | 20M | QPSK | 1 | 49 | Front | 0mm | Reduced | 19100 | 1900 | 21.91 | 22.50 | 1.146 | 0.04 | 1.520 | 1.741 |
| | LTE Band 2 | 20M | QPSK | 1 | 49 | Back | 0mm | Reduced | 19100 | 1900 | 21.91 | 22.50 | 1.146 | 0.02 | 1.760 | 2.016 |
| | LTE Band 2 | 20M | QPSK | 1 | 49 | Back | 0mm | Reduced | 18700 | 1860 | 21.88 | 22.50 | 1.153 | 0.11 | 1.740 | 2.007 |
| | LTE Band 2 | 20M | QPSK | 1 | 49 | Back | 0mm | Reduced | 18900 | 1880 | 21.78 | 22.50 | 1.180 | 0.13 | 1.680 | 1.983 |
| | LTE Band 2 | 20M | QPSK | 1 | 49 | Bottom Side | 0mm | Reduced | 19100 | 1900 | 21.91 | 22.50 | 1.146 | 0.12 | 2.510 | 2.875 |
| 49 | LTE Band 2 | 20M | QPSK | 1 | 49 | Bottom Side | 0mm | Reduced | 18700 | 1860 | 21.88 | 22.50 | 1.153 | -0.11 | 2.660 | 3.068 |
| | LTE Band 2 | 20M | QPSK | 1 | 49 | Bottom Side | 0mm | Reduced | 18900 | 1880 | 21.78 | 22.50 | 1.180 | -0.13 | 2.590 | 3.057 |
| | LTE Band 2 | 20M | QPSK | 1 | 49 | Front | 9mm | Full | 19100 | 1900 | 23.01 | 24.00 | 1.256 | 0.02 | 0.563 | 0.707 |
| | LTE Band 2 | 20M | QPSK | 1 | 49 | Back | 13mm | Full | 19100 | 1900 | 23.01 | 24.00 | 1.256 | -0.03 | 0.413 | 0.519 |
| | LTE Band 2 | 20M | QPSK | 1 | 49 | Bottom Side | 10mm | Full | 18700 | 1860 | 23.03 | 24.00 | 1.250 | 0.07 | 0.776 | 0.970 |
| | LTE Band 2 | 20M | QPSK | 50 | 24 | Front | 0mm | Reduced | 19100 | 1900 | 21.76 | 22.50 | 1.186 | 0.06 | 1.160 | 1.375 |
| | LTE Band 2 | 20M | QPSK | 50 | 24 | Back | 0mm | Reduced | 19100 | 1900 | 21.76 | 22.50 | 1.186 | -0.13 | 1.360 | 1.613 |
| | LTE Band 2 | 20M | QPSK | 50 | 24 | Bottom Side | 0mm | Reduced | 19100 | 1900 | 21.76 | 22.50 | 1.186 | -0.19 | 2.050 | 2.431 |
| | LTE Band 2 | 20M | QPSK | 50 | 24 | Bottom Side | 0mm | Reduced | 18700 | 1860 | 21.58 | 22.50 | 1.236 | -0.06 | 2.220 | 2.744 |
| | LTE Band 2 | 20M | QPSK | 50 | 24 | Bottom Side | 0mm | Reduced | 18900 | 1880 | 21.68 | 22.50 | 1.208 | -0.07 | 2.180 | 2.633 |
| | LTE Band 2 | 20M | QPSK | 100 | 0 | Back | 0mm | Reduced | 19100 | 1900 | 21.72 | 22.50 | 1.197 | 0.08 | 1.370 | 1.640 |
| | LTE Band 2 | 20M | QPSK | 100 | 0 | Bottom Side | 0mm | Reduced | 19100 | 1900 | 21.72 | 22.50 | 1.197 | 0.05 | 2.050 | 2.453 |



| Plot No. | Band | BW (MHz) | Modulation | RB Size | RB offset | Test Position | Gap (mm) | Power Reduction | Ch. | Freq. (MHz) | Average Power (dBm) | Tune-Up Limit (dBm) | Tune-up Scaling Factor | Power Drift (dB) | Measured 10g SAR (W/kg) | Reported 10g SAR (W/kg) |
|----------|------------|----------|------------|---------|-----------|---------------|----------|-----------------|-------|-------------|---------------------|---------------------|------------------------|------------------|-------------------------|-------------------------|
| | LTE Band 7 | 20M | QPSK | 1 | 49 | Front | 0mm | Reduced | 21100 | 2535 | 18.83 | 19.50 | 1.167 | -0.19 | 1.000 | 1.167 |
| | LTE Band 7 | 20M | QPSK | 1 | 49 | Back | 0mm | Reduced | 21100 | 2535 | 18.83 | 19.50 | 1.167 | -0.06 | 2.750 | 3.209 |
| | LTE Band 7 | 20M | QPSK | 1 | 49 | Back | 0mm | Reduced | 20850 | 2510 | 18.78 | 19.50 | 1.180 | -0.07 | 2.850 | 3.364 |
| | LTE Band 7 | 20M | QPSK | 1 | 49 | Back | 0mm | Reduced | 21350 | 2560 | 18.81 | 19.50 | 1.172 | -0.02 | 2.600 | 3.048 |
| | LTE Band 7 | 20M | QPSK | 1 | 49 | Bottom Side | 0mm | Reduced | 21100 | 2535 | 18.83 | 19.50 | 1.167 | 0.08 | 2.320 | 2.707 |
| | LTE Band 7 | 20M | QPSK | 1 | 49 | Bottom Side | 0mm | Reduced | 20850 | 2510 | 18.78 | 19.50 | 1.180 | -0.19 | 2.430 | 2.868 |
| | LTE Band 7 | 20M | QPSK | 1 | 49 | Bottom Side | 0mm | Reduced | 21350 | 2560 | 18.81 | 19.50 | 1.172 | -0.06 | 2.150 | 2.520 |
| | LTE Band 7 | 20M | QPSK | 1 | 49 | Front | 9mm | Full | 21100 | 2535 | 23.29 | 24.00 | 1.178 | 0.11 | 0.282 | 0.332 |
| | LTE Band 7 | 20M | QPSK | 1 | 49 | Back | 13mm | Full | 20850 | 2510 | 22.90 | 24.00 | 1.288 | 0.05 | 0.514 | 0.662 |
| | LTE Band 7 | 20M | QPSK | 1 | 49 | Bottom Side | 10mm | Full | 20850 | 2510 | 22.90 | 24.00 | 1.288 | 0.04 | 1.040 | 1.340 |
| | LTE Band 7 | 20M | QPSK | 50 | 24 | Front | 0mm | Reduced | 21100 | 2535 | 18.75 | 19.50 | 1.189 | 0.12 | 0.979 | 1.164 |
| | LTE Band 7 | 20M | QPSK | 50 | 24 | Back | 0mm | Reduced | 21100 | 2535 | 18.75 | 19.50 | 1.189 | 0.11 | 2.670 | 3.173 |
| 50 | LTE Band 7 | 20M | QPSK | 50 | 24 | Back | 0mm | Reduced | 20850 | 2510 | 18.66 | 19.50 | 1.213 | -0.06 | 2.810 | 3.410 |
| | LTE Band 7 | 20M | QPSK | 50 | 24 | Back | 0mm | Reduced | 21350 | 2560 | 18.70 | 19.50 | 1.202 | -0.07 | 2.600 | 3.126 |
| | LTE Band 7 | 20M | QPSK | 50 | 24 | Bottom Side | 0mm | Reduced | 21100 | 2535 | 18.75 | 19.50 | 1.189 | -0.04 | 2.340 | 2.781 |
| | LTE Band 7 | 20M | QPSK | 50 | 24 | Bottom Side | 0mm | Reduced | 20850 | 2510 | 18.66 | 19.50 | 1.213 | 0.06 | 2.480 | 3.009 |
| | LTE Band 7 | 20M | QPSK | 50 | 24 | Bottom Side | 0mm | Reduced | 21350 | 2560 | 18.70 | 19.50 | 1.202 | -0.13 | 2.150 | 2.585 |
| | LTE Band 7 | 20M | QPSK | 50 | 0 | Front | 9mm | Full | 21100 | 2535 | 22.37 | 23.00 | 1.156 | 0.11 | 0.219 | 0.253 |
| | LTE Band 7 | 20M | QPSK | 50 | 0 | Back | 13mm | Full | 20850 | 2510 | 22.09 | 23.00 | 1.233 | 0.05 | 0.470 | 0.580 |
| | LTE Band 7 | 20M | QPSK | 50 | 0 | Bottom Side | 10mm | Full | 20850 | 2510 | 22.09 | 23.00 | 1.233 | 0.04 | 0.840 | 1.036 |
| | LTE Band 7 | 20M | QPSK | 100 | 0 | Back | 0mm | Reduced | 21100 | 2535 | 18.68 | 19.50 | 1.208 | -0.07 | 2.760 | 3.334 |
| | LTE Band 7 | 20M | QPSK | 100 | 0 | Bottom Side | 0mm | Reduced | 21100 | 2535 | 18.68 | 19.50 | 1.208 | 0.05 | 2.300 | 2.778 |

<WLAN5G SAR>

| Plot No. | Band | Mode | Test Position | Gap (mm) | Power Reduction | Ch. | Freq. (MHz) | Average Power (dBm) | Tune-Up Limit (dBm) | Tune-up Scaling Factor | Duty Cycle % | Duty Cycle Scaling Factor | Power Drift (dB) | Measured 10g SAR (W/kg) | Reported 10g SAR (W/kg) |
|----------|------------|---------------------|---------------|----------|-----------------|-----|-------------|---------------------|---------------------|------------------------|--------------|---------------------------|------------------|-------------------------|-------------------------|
| | WLAN5.3GHz | 802.11n-HT40 MCS0 | Front | 0mm | Full | 54 | 5270 | 17.24 | 19.00 | 1.500 | 96.32 | 1.038 | 0.03 | 0.224 | 0.349 |
| | WLAN5.3GHz | 802.11n-HT40 MCS0 | Back | 0mm | Full | 54 | 5270 | 17.24 | 19.00 | 1.500 | 96.32 | 1.038 | 0.1 | 0.399 | 0.621 |
| | WLAN5.3GHz | 802.11n-HT40 MCS0 | Left Side | 0mm | Full | 54 | 5270 | 17.24 | 19.00 | 1.500 | 96.32 | 1.038 | 0.12 | 0.003 | 0.004 |
| | WLAN5.3GHz | 802.11n-HT40 MCS0 | Right Side | 0mm | Full | 54 | 5270 | 17.24 | 19.00 | 1.500 | 96.32 | 1.038 | 0.14 | 0.115 | 0.179 |
| 51 | WLAN5.3GHz | 802.11n-HT40 MCS0 | Top Side | 0mm | Full | 54 | 5270 | 17.24 | 19.00 | 1.500 | 96.32 | 1.038 | -0.01 | 0.709 | 1.104 |
| | WLAN5.5GHz | 802.11ac-VHT80 MCS0 | Front | 0mm | Full | 122 | 5610 | 17.54 | 19.00 | 1.400 | 92.79 | 1.078 | 0.02 | 0.394 | 0.594 |
| | WLAN5.5GHz | 802.11ac-VHT80 MCS0 | Back | 0mm | Full | 122 | 5610 | 17.54 | 19.00 | 1.400 | 92.79 | 1.078 | 0.04 | 0.961 | 1.450 |
| | WLAN5.5GHz | 802.11ac-VHT80 MCS0 | Left Side | 0mm | Full | 122 | 5610 | 17.54 | 19.00 | 1.400 | 92.79 | 1.078 | 0.01 | 0.037 | 0.055 |
| | WLAN5.5GHz | 802.11ac-VHT80 MCS0 | Right Side | 0mm | Full | 122 | 5610 | 17.54 | 19.00 | 1.400 | 92.79 | 1.078 | -0.03 | 0.373 | 0.563 |
| | WLAN5.5GHz | 802.11ac-VHT80 MCS0 | Top Side | 0mm | Full | 122 | 5610 | 17.54 | 19.00 | 1.400 | 92.79 | 1.078 | 0.05 | 1.400 | 2.112 |
| 52 | WLAN5.5GHz | 802.11ac-VHT80 MCS0 | Top Side | 0mm | Full | 138 | 5690 | 17.49 | 19.00 | 1.416 | 92.79 | 1.078 | -0.08 | 1.780 | 2.717 |

15.5 Repeated SAR Measurement

<1g>

| No. | Band | BW (MHz) | Modulation | RB Size | RB offset | Test Position | Gap (mm) | Power Reduction | Ch. | Freq. (MHz) | Average Power (dBm) | Tune-Up Limit (dBm) | Tune-up Scaling Factor | Power Drift (dB) | Measured 1g SAR (W/kg) | Ratio | Reported 1g SAR (W/kg) |
|-----|-------------|----------|------------|---------|-----------|---------------|----------|-----------------|--------|-------------|---------------------|---------------------|------------------------|------------------|------------------------|-------|------------------------|
| 1st | LTE Band 5 | 10M | QPSK | 1 | 25 | Back | 5mm | Reduced | 20525 | 836.5 | 22.81 | 23.50 | 1.172 | -0.16 | 1.160 | 1 | 1.360 |
| 2nd | LTE Band 5 | 10M | QPSK | 1 | 25 | Back | 5mm | Reduced | 20525 | 836.5 | 22.81 | 23.50 | 1.172 | -0.02 | 1.060 | 1.094 | 1.243 |
| 1st | LTE Band 66 | 20M | QPSK | 100 | 0 | Back | 5mm | Reduced | 132322 | 1745 | 18.14 | 19.00 | 1.219 | -0.17 | 1.180 | 1 | 1.438 |
| 2nd | LTE Band 66 | 20M | QPSK | 100 | 0 | Back | 5mm | Reduced | 132322 | 1745 | 18.14 | 19.00 | 1.219 | 0.08 | 1.140 | 1.035 | 1.390 |
| 1st | LTE Band 2 | 20M | QPSK | 1 | 49 | Back | 5mm | Reduced | 18700 | 1860 | 21.41 | 22.00 | 1.146 | -0.04 | 1.260 | 1 | 1.443 |
| 2nd | LTE Band 2 | 20M | QPSK | 1 | 49 | Back | 5mm | Reduced | 18700 | 1860 | 21.41 | 22.00 | 1.146 | 0.11 | 1.250 | 1.008 | 1.432 |
| 1st | LTE Band 7 | 20M | QPSK | 1 | 49 | Bottom Side | 5mm | Reduced | 20850 | 2510 | 15.51 | 16.00 | 1.119 | -0.16 | 1.290 | 1 | 1.444 |
| 2nd | LTE Band 7 | 20M | QPSK | 1 | 49 | Bottom Side | 5mm | Reduced | 20850 | 2510 | 15.51 | 16.00 | 1.119 | 0.02 | 1.240 | 1.040 | 1.388 |

<10g>

| No. | Band | BW (MHz) | Modulation | RB Size | RB offset | Mode | Test Position | Gap (mm) | Power Reduction | Ch. | Freq. (MHz) | Average Power (dBm) | Tune-Up Limit (dBm) | Tune-up Scaling Factor | Power Drift (dB) | Measured 10g SAR (W/kg) | Ratio | Reported 10g SAR (W/kg) |
|-----|-------------|----------|------------|---------|-----------|------------------|---------------|----------|-----------------|--------|-------------|---------------------|---------------------|------------------------|------------------|-------------------------|-------|-------------------------|
| 1st | GSM1900 | - | - | - | - | GPRS(2 Tx slots) | Bottom Side | 0mm | Full | 661 | 1880 | 28.25 | 29.50 | 1.334 | -0.14 | 2.690 | 1 | 3.587 |
| 2nd | GSM1900 | - | - | - | - | GPRS(2 Tx slots) | Bottom Side | 0mm | Full | 661 | 1880 | 28.25 | 29.50 | 1.334 | 0.19 | 2.550 | 1.055 | 3.400 |
| 1st | WCDMA V | - | - | - | - | RMC 12.2Kbps | Back | 0mm | Full | 4233 | 846.6 | 22.94 | 24.00 | 1.276 | 0.04 | 2.590 | 1 | 3.306 |
| 2nd | WCDMA V | - | - | - | - | RMC 12.2Kbps | Back | 0mm | Full | 4233 | 846.6 | 22.94 | 24.00 | 1.276 | 0.02 | 2.480 | 1.044 | 3.166 |
| 1st | LTE Band 66 | 20M | QPSK | 50 | 24 | - | Bottom Side | 0mm | Reduced | 132322 | 1745 | 20.93 | 21.50 | 1.140 | 0.02 | 3.130 | 1 | 3.569 |
| 2nd | LTE Band 66 | 20M | QPSK | 50 | 24 | - | Bottom Side | 0mm | Reduced | 132322 | 1745 | 20.93 | 21.50 | 1.140 | -0.1 | 3.040 | 1.030 | 3.466 |
| 1st | LTE Band 7 | 20M | QPSK | 1 | 49 | - | Back | 0mm | Reduced | 20850 | 2510 | 18.78 | 19.50 | 1.180 | -0.07 | 2.850 | 1 | 3.364 |
| 2nd | LTE Band 7 | 20M | QPSK | 1 | 49 | - | Back | 0mm | Reduced | 20850 | 2510 | 18.78 | 19.50 | 1.180 | 0.05 | 2.820 | 1.011 | 3.329 |

General Note:

1. Per KDB 865664 D01v01r04, for each frequency band, repeated SAR measurement is required only when the measured SAR is $\geq 0.8W/kg$.
2. Per KDB 865664 D01v01r04, if the ratio among the repeated measurement is ≤ 1.2 and the measured SAR $< 1.45W/kg$, only one repeated measurement is required.
3. Per KDB 865664 D01v01r04, if the extremity repeated SAR is necessary, the same procedures should be adapted for measurements according to extremity and occupational exposure limits by applying a factor of 2.5 for extremity exposure and a factor of 5 for occupational exposure to the corresponding SAR thresholds.
4. The ratio is the difference in percentage between original and repeated *measured SAR*.
5. All measurement SAR result is scaled-up to account for tune-up tolerance and is compliant.

16. Simultaneous Transmission Analysis

| No. | Simultaneous Transmission Configurations | Portable Handset | | | |
|-----|--|------------------|-----------|---------|--------------------------|
| | | Head | Body-worn | Hotspot | Product specific 10g SAR |
| 1. | GSM Voice + WLAN2.4GHz | Yes | Yes | | Yes |
| 2. | GPRS/EDGE + WLAN2.4GHz | Yes | Yes | Yes | Yes |
| 3. | WCDMA + WLAN2.4GHz | Yes | Yes | Yes | Yes |
| 4. | LTE + WLAN2.4GHz | Yes | Yes | Yes | Yes |
| 5. | GSM Voice + WLAN5.3/5.5GHz | Yes | Yes | | Yes |
| 6. | GPRS/EDGE + WLAN5.3/5.5GHz | Yes | Yes | | Yes |
| 7. | WCDMA + WLAN5.3/5.5GHz | Yes | Yes | | Yes |
| 8. | LTE + WLAN5.3/5.5GHz | Yes | Yes | | Yes |
| 9. | GSM Voice + WLAN5.2/5.8GHz | Yes | Yes | | Yes |
| 10. | GPRS/EDGE + WLAN5.2/5.8GHz | Yes | Yes | Yes | Yes |
| 11. | WCDMA + WLAN5.2/5.8GHz | Yes | Yes | Yes | Yes |
| 12. | LTE + WLAN5.2/5.8GHz | Yes | Yes | Yes | Yes |
| 13. | GSM Voice + Bluetooth | Yes | Yes | | Yes |
| 14. | GPRS/EDGE + Bluetooth | Yes | Yes | Yes | Yes |
| 15. | WCDMA + Bluetooth | Yes | Yes | Yes | Yes |
| 16. | LTE + Bluetooth | Yes | Yes | Yes | Yes |

General Note:

- This device supports VoIP in GPRS, EGPRS, WCDMA, and LTE (e.g. for 3rd-party VoIP), LTE supports VoLTE operation.
- EUT will choose each GSM, WCDMA and LTE according to the network signal condition; therefore, they will not operate simultaneously at any moment.
- This device 2.4GHz WLAN support hotspot operation and Bluetooth support tethering applications.
- This device 2.4GHz WLAN/ 5.2GHz WLAN/5.8GHz WLAN support hotspot operation, and 5.2GHz WLAN/5.8GHz WLAN supports WLAN Direct (GC/GO), and 5.3GHz / 5.5GHz supports WLAN Direct (GC only).
- EUT will choose either WLAN 2.4GHz or WLAN 5GHz according to the network signal condition; therefore, 2.4GHz WLAN and 5GHz WLAN will not operate simultaneously at any moment though they have independent antenna.
- WLAN 2.4GHz and Bluetooth share the same antenna so can't transmit simultaneously.
- According to the EUT character, WLAN 5GHz and Bluetooth can't transmit simultaneously.
- Chose the worst zoom scan SAR of WLAN correspondingly for co-located with WWAN analysis.
- The reported SAR summation is calculated based on the same configuration and test position.
- Per KDB 447498 D01v06, simultaneous transmission SAR is compliant if,
 - 1g Scalar SAR summation < 1.6W/kg and 10g Scalar SAR summation < 4.0W/kg.
 - $SPLSR = (SAR1 + SAR2)^{1.5} / (\text{min. separation distance, mm})$, and the peak separation distance is determined from the square root of $[(x1-x2)^2 + (y1-y2)^2 + (z1-z2)^2]$, where (x1, y1, z1) and (x2, y2, z2) are the coordinates of the extrapolated peak SAR locations in the zoom scan.
 - If $SPLSR \leq 0.04$ for 1g SAR and $SPLSR \leq 0.10$ for 10g SAR, simultaneously transmission SAR measurement is not necessary.
 - Simultaneously transmission SAR measurement, and the reported multi-band 1g SAR < 1.6W/kg and 10g SAR < 4.0W/kg.
 - The SPLSR calculated results please refer to section 16.5.

16.1 Head Exposure Conditions

| WWAN Band | | Exposure Position | 1 | 2 | 4 | 6 | 1+2 Summed 1g SAR (W/kg) | 1+4 Summed 1g SAR (W/kg) | 1+6 Summed 1g SAR (W/kg) |
|-----------|-------------|-------------------|------------------|------------------|------------------|------------------|-----------------------------------|-----------------------------------|-----------------------------------|
| | | | WWAN | 2.4GHz WLAN | 5GHz WLAN | Bluetooth | | | |
| | | | 1g SAR (W/kg) | 1g SAR (W/kg) | 1g SAR (W/kg) | 1g SAR (W/kg) | | | |
| GSM | GSM850 | Right Cheek | 0.496 | 0.295 | 0.604 | 0.047 | 0.79 | 1.10 | 0.54 |
| | | Right Tilted | 0.259 | 0.370 | 0.666 | 0.061 | 0.63 | 0.93 | 0.32 |
| | | Left Cheek | 0.481 | 0.584 | 1.105 | 0.140 | 1.07 | 1.59 | 0.62 |
| | | Left Tilted | 0.270 | 0.581 | 0.833 | 0.114 | 0.85 | 1.10 | 0.38 |
| | GSM1900 | Right Cheek | 0.252 | 0.295 | 0.604 | 0.047 | 0.55 | 0.86 | 0.30 |
| | | Right Tilted | 0.140 | 0.370 | 0.666 | 0.061 | 0.51 | 0.81 | 0.20 |
| | | Left Cheek | 0.288 | 0.584 | 1.105 | 0.140 | 0.87 | 1.39 | 0.43 |
| | | Left Tilted | 0.215 | 0.581 | 0.833 | 0.114 | 0.80 | 1.05 | 0.33 |
| WCDMA | WCDMA V | Right Cheek | 0.447 | 0.295 | 0.604 | 0.047 | 0.74 | 1.05 | 0.49 |
| | | Right Tilted | 0.239 | 0.370 | 0.666 | 0.061 | 0.61 | 0.91 | 0.30 |
| | | Left Cheek | 0.407 | 0.584 | 1.105 | 0.140 | 0.99 | 1.51 | 0.55 |
| | | Left Tilted | 0.241 | 0.581 | 0.833 | 0.114 | 0.82 | 1.07 | 0.36 |
| | WCDMA IV | Right Cheek | 0.321 | 0.295 | 0.604 | 0.047 | 0.62 | 0.93 | 0.37 |
| | | Right Tilted | 0.126 | 0.370 | 0.666 | 0.061 | 0.50 | 0.79 | 0.19 |
| | | Left Cheek | 0.228 | 0.584 | 1.105 | 0.140 | 0.81 | 1.33 | 0.37 |
| | | Left Tilted | 0.170 | 0.581 | 0.833 | 0.114 | 0.75 | 1.00 | 0.28 |
| | WCDMA II | Right Cheek | 0.268 | 0.295 | 0.604 | 0.047 | 0.56 | 0.87 | 0.32 |
| | | Right Tilted | 0.122 | 0.370 | 0.666 | 0.061 | 0.49 | 0.79 | 0.18 |
| | | Left Cheek | 0.273 | 0.584 | 1.105 | 0.140 | 0.86 | 1.38 | 0.41 |
| | | Left Tilted | 0.190 | 0.581 | 0.833 | 0.114 | 0.77 | 1.02 | 0.30 |
| LTE | LTE Band 5 | Right Cheek | 0.441 | 0.295 | 0.604 | 0.047 | 0.74 | 1.05 | 0.49 |
| | | Right Tilted | 0.227 | 0.370 | 0.666 | 0.061 | 0.60 | 0.89 | 0.29 |
| | | Left Cheek | 0.403 | 0.584 | 1.105 | 0.140 | 0.99 | 1.51 | 0.54 |
| | | Left Tilted | 0.209 | 0.581 | 0.833 | 0.114 | 0.79 | 1.04 | 0.32 |
| | LTE Band 66 | Right Cheek | 0.290 | 0.295 | 0.604 | 0.047 | 0.59 | 0.89 | 0.34 |
| | | Right Tilted | 0.121 | 0.370 | 0.666 | 0.061 | 0.49 | 0.79 | 0.18 |
| | | Left Cheek | 0.221 | 0.584 | 1.105 | 0.140 | 0.81 | 1.33 | 0.36 |
| | | Left Tilted | 0.165 | 0.581 | 0.833 | 0.114 | 0.75 | 1.00 | 0.28 |
| | LTE Band 2 | Right Cheek | 0.254 | 0.295 | 0.604 | 0.047 | 0.55 | 0.86 | 0.30 |
| | | Right Tilted | 0.131 | 0.370 | 0.666 | 0.061 | 0.50 | 0.80 | 0.19 |
| | | Left Cheek | 0.269 | 0.584 | 1.105 | 0.140 | 0.85 | 1.37 | 0.41 |
| | | Left Tilted | 0.207 | 0.581 | 0.833 | 0.114 | 0.79 | 1.04 | 0.32 |
| | LTE Band 7 | Right Cheek | 0.145 | 0.295 | 0.604 | 0.047 | 0.44 | 0.75 | 0.19 |
| | | Right Tilted | 0.077 | 0.370 | 0.666 | 0.061 | 0.45 | 0.74 | 0.14 |
| | | Left Cheek | 0.257 | 0.584 | 1.105 | 0.140 | 0.84 | 1.36 | 0.40 |
| | | Left Tilted | 0.101 | 0.581 | 0.833 | 0.114 | 0.68 | 0.93 | 0.22 |



16.2 Hotspot Exposure Conditions

| WWAN Band | Exposure Position | 1 | 2 | 4 | 6 | 1+2 Summed 1g SAR (W/kg) | Case No | SPLSR | 1+4 | Case No | SPLSR | 1+6 | |
|-------------|-------------------|--------------------|---------------------------|-------------------------|-------------------------|--------------------------|---------|-------|----------------------|---------|-------|----------------------|----------------------|
| | | WWAN 1g SAR (W/kg) | 2.4GHz WLAN 1g SAR (W/kg) | 5GHz WLAN 1g SAR (W/kg) | Bluetooth 1g SAR (W/kg) | | | | Summed 1g SAR (W/kg) | | | Summed 1g SAR (W/kg) | Summed 1g SAR (W/kg) |
| GSM | GSM850 | Front | 0.646 | 0.297 | 0.405 | 0.062 | 0.94 | | | 1.05 | | | 0.71 |
| | | Back | 1.257 | 0.382 | 0.891 | 0.082 | 1.64 | #01 | 0.01 | 2.15 | #10 | 0.02 | 1.34 |
| | | Left side | 0.246 | 0.047 | 0.015 | 0.006 | 0.29 | | | 0.26 | | | 0.25 |
| | | Right side | 0.445 | 0.318 | 0.161 | 0.066 | 0.76 | | | 0.61 | | | 0.51 |
| | | Top side | | 0.321 | 0.755 | 0.058 | 0.32 | | | 0.76 | | | 0.06 |
| | Bottom side | 0.420 | | | | 0.42 | | | 0.42 | | | 0.42 | |
| | GSM1900 | Front | 1.071 | 0.297 | 0.405 | 0.062 | 1.37 | | | 1.48 | | | 1.13 |
| | | Back | 1.215 | 0.382 | 0.891 | 0.082 | 1.60 | #02 | 0.01 | 2.11 | #11 | 0.02 | 1.30 |
| | | Left side | 0.305 | 0.047 | 0.015 | 0.006 | 0.35 | | | 0.32 | | | 0.31 |
| | | Right side | 0.090 | 0.318 | 0.161 | 0.066 | 0.41 | | | 0.25 | | | 0.16 |
| Top side | | | 0.321 | 0.755 | 0.058 | 0.32 | | | 0.76 | | | 0.06 | |
| Bottom side | 1.297 | | | | 1.30 | | | 1.30 | | | 1.30 | | |
| WCDMA | WCDMA V | Front | 0.611 | 0.297 | 0.405 | 0.062 | 0.91 | | | 1.02 | | | 0.67 |
| | | Back | 1.184 | 0.382 | 0.891 | 0.082 | 1.57 | | | 2.08 | #12 | 0.02 | 1.27 |
| | | Left side | 0.267 | 0.047 | 0.015 | 0.006 | 0.31 | | | 0.28 | | | 0.27 |
| | | Right side | 0.394 | 0.318 | 0.161 | 0.066 | 0.71 | | | 0.56 | | | 0.46 |
| | | Top side | | 0.321 | 0.755 | 0.058 | 0.32 | | | 0.76 | | | 0.06 |
| | Bottom side | 0.305 | | | | 0.31 | | | 0.31 | | | 0.31 | |
| | WCDMA IV | Front | 0.935 | 0.297 | 0.405 | 0.062 | 1.23 | | | 1.34 | | | 1.00 |
| | | Back | 1.363 | 0.382 | 0.891 | 0.082 | 1.75 | #04 | 0.02 | 2.25 | #13 | 0.02 | 1.45 |
| | | Left side | 0.152 | 0.047 | 0.015 | 0.006 | 0.20 | | | 0.17 | | | 0.16 |
| | | Right side | 0.114 | 0.318 | 0.161 | 0.066 | 0.43 | | | 0.28 | | | 0.18 |
| | | Top side | | 0.321 | 0.755 | 0.058 | 0.32 | | | 0.76 | | | 0.06 |
| | Bottom side | 1.372 | | | | 1.37 | | | 1.37 | | | 1.37 | |
| | WCDMA II | Front | 0.971 | 0.297 | 0.405 | 0.062 | 1.27 | | | 1.38 | | | 1.03 |
| | | Back | 1.206 | 0.382 | 0.891 | 0.082 | 1.59 | | | 2.10 | #14 | 0.02 | 1.29 |
| | | Left side | 0.208 | 0.047 | 0.015 | 0.006 | 0.26 | | | 0.22 | | | 0.21 |
| Right side | | 0.037 | 0.318 | 0.161 | 0.066 | 0.36 | | | 0.20 | | | 0.10 | |
| Top side | | | 0.321 | 0.755 | 0.058 | 0.32 | | | 0.76 | | | 0.06 | |
| Bottom side | 1.163 | | | | 1.16 | | | 1.16 | | | 1.16 | | |
| LTE | LTE Band 5 | Front | 0.707 | 0.297 | 0.405 | 0.062 | 1.00 | | | 1.11 | | | 0.77 |
| | | Back | 1.360 | 0.382 | 0.891 | 0.082 | 1.74 | #06 | 0.02 | 2.25 | #15 | 0.02 | 1.44 |
| | | Left side | 0.394 | 0.047 | 0.015 | 0.006 | 0.44 | | | 0.41 | | | 0.40 |
| | | Right side | 0.559 | 0.318 | 0.161 | 0.066 | 0.88 | | | 0.72 | | | 0.63 |
| | | Top side | | 0.321 | 0.755 | 0.058 | 0.32 | | | 0.76 | | | 0.06 |
| | Bottom side | 0.396 | | | | 0.40 | | | 0.40 | | | 0.40 | |
| | LTE Band 66 | Front | 1.019 | 0.297 | 0.405 | 0.062 | 1.32 | | | 1.42 | | | 1.08 |
| | | Back | 1.438 | 0.382 | 0.891 | 0.082 | 1.82 | #07 | 0.02 | 2.33 | #16 | 0.02 | 1.52 |
| | | Left side | 0.123 | 0.047 | 0.015 | 0.006 | 0.17 | | | 0.14 | | | 0.13 |
| | | Right side | 0.115 | 0.318 | 0.161 | 0.066 | 0.43 | | | 0.28 | | | 0.18 |
| | | Top side | | 0.321 | 0.755 | 0.058 | 0.32 | | | 0.76 | | | 0.06 |
| | Bottom side | 1.256 | | | | 1.26 | | | 1.26 | | | 1.26 | |
| | LTE Band 2 | Front | 1.317 | 0.297 | 0.405 | 0.062 | 1.61 | #19 | 0.01 | 1.72 | #20 | 0.01 | 1.38 |
| | | Back | 1.443 | 0.382 | 0.891 | 0.082 | 1.83 | #08 | 0.02 | 2.33 | #17 | 0.02 | 1.53 |
| | | Left side | 0.302 | 0.047 | 0.015 | 0.006 | 0.35 | | | 0.32 | | | 0.31 |
| | | Right side | 0.085 | 0.318 | 0.161 | 0.066 | 0.40 | | | 0.25 | | | 0.15 |
| | | Top side | | 0.321 | 0.755 | 0.058 | 0.32 | | | 0.76 | | | 0.06 |
| | Bottom side | 1.410 | | | | 1.41 | | | 1.41 | | | 1.41 | |
| LTE Band 7 | Front | 0.508 | 0.297 | 0.405 | 0.062 | 0.81 | | | 0.91 | | | 0.57 | |
| | Back | 1.205 | 0.382 | 0.891 | 0.082 | 1.59 | | | 2.10 | #18 | 0.02 | 1.29 | |
| | Left side | 0.123 | 0.047 | 0.015 | 0.006 | 0.17 | | | 0.14 | | | 0.13 | |
| | Right side | 0.046 | 0.318 | 0.161 | 0.066 | 0.36 | | | 0.21 | | | 0.11 | |
| | Top side | | 0.321 | 0.755 | 0.058 | 0.32 | | | 0.76 | | | 0.06 | |
| Bottom side | 1.444 | | | | 1.44 | | | 1.44 | | | 1.44 | | |



16.3 Body-Worn Accessory Exposure Conditions

| WWAN Band | Exposure Position | 1 | 2 | 4 | 6 | 1+2 Summed 1g SAR (W/kg) | Case No | SPLSR | 1+4 Summed 1g SAR (W/kg) | Case No | SPLSR | 1+6 Summed 1g SAR (W/kg) | |
|-----------|-------------------|--------------------|---------------------------|-------------------------|-------------------------|--------------------------|---------|-------|--------------------------|---------|-------|--------------------------|------|
| | | WWAN 1g SAR (W/kg) | 2.4GHz WLAN 1g SAR (W/kg) | 5GHz WLAN 1g SAR (W/kg) | Bluetooth 1g SAR (W/kg) | | | | | | | | |
| GSM | GSM850 | Front | 0.646 | 0.297 | 0.455 | 0.062 | 0.94 | | | 1.10 | | | 0.71 |
| | | Back | 1.257 | 0.382 | 1.001 | 0.082 | 1.64 | #01 | 0.01 | 2.26 | #26 | 0.02 | 1.34 |
| | | Front with Headset | | | | | 0.00 | | | 0.00 | | | 0.00 |
| | | Back with Headset | 1.176 | | | | 1.18 | | | 1.18 | | | 1.18 |
| | GSM1900 | Front | 1.071 | 0.297 | 0.455 | 0.062 | 1.37 | | | 1.53 | | | 1.13 |
| | | Back | 1.215 | 0.382 | 1.001 | 0.082 | 1.60 | #02 | 0.01 | 2.22 | #27 | 0.02 | 1.30 |
| | | Front with Headset | | | | | 0.00 | | | 0.00 | | | 0.00 |
| | | Back with Headset | 1.201 | | | | 1.20 | | | 1.20 | | | 1.20 |
| WCDMA | WCDMA V | Front | 0.611 | 0.297 | 0.455 | 0.062 | 0.91 | | | 1.07 | | | 0.67 |
| | | Back | 1.184 | 0.382 | 1.001 | 0.082 | 1.57 | | | 2.19 | #28 | 0.02 | 1.27 |
| | | Front with Headset | | | | | 0.00 | | | 0.00 | | | 0.00 |
| | | Back with Headset | | | | | 0.00 | | | 0.00 | | | 0.00 |
| | WCDMA IV | Front | 0.935 | 0.297 | 0.455 | 0.062 | 1.23 | | | 1.39 | | | 1.00 |
| | | Back | 1.363 | 0.382 | 1.001 | 0.082 | 1.75 | #04 | 0.02 | 2.36 | #29 | 0.02 | 1.45 |
| | | Front with Headset | | | | | 0.00 | | | 0.00 | | | 0.00 |
| | | Back with Headset | 1.274 | | | | 1.27 | | | 1.27 | | | 1.27 |
| | WCDMA II | Front | 0.971 | 0.297 | 0.455 | 0.062 | 1.27 | | | 1.43 | | | 1.03 |
| | | Back | 1.206 | 0.382 | 1.001 | 0.082 | 1.59 | | | 2.21 | #30 | 0.02 | 1.29 |
| | | Front with Headset | | | | | 0.00 | | | 0.00 | | | 0.00 |
| | | Back with Headset | 1.189 | | | | 1.19 | | | 1.19 | | | 1.19 |
| LTE | LTE Band 5 | Front | 0.707 | 0.297 | 0.455 | 0.062 | 1.00 | | | 1.16 | | | 0.77 |
| | | Back | 1.360 | 0.382 | 1.001 | 0.082 | 1.74 | #06 | 0.02 | 2.36 | #31 | 0.02 | 1.44 |
| | | Front with Headset | | | | | 0.00 | | | 0.00 | | | 0.00 |
| | | Back with Headset | 1.289 | | | | 1.29 | | | 1.29 | | | 1.29 |
| | LTE Band 66 | Front | 1.019 | 0.297 | 0.455 | 0.062 | 1.32 | | | 1.47 | | | 1.08 |
| | | Back | 1.438 | 0.382 | 1.001 | 0.082 | 1.82 | #07 | 0.02 | 2.44 | #32 | 0.02 | 1.52 |
| | | Front with Headset | | | | | 0.00 | | | 0.00 | | | 0.00 |
| | | Back with Headset | 1.402 | | | | 1.40 | | | 1.40 | | | 1.40 |
| | LTE Band 2 | Front | 1.317 | 0.297 | 0.455 | 0.062 | 1.61 | #19 | 0.01 | 1.77 | #35 | 0.01 | 1.38 |
| | | Back | 1.443 | 0.382 | 1.001 | 0.082 | 1.83 | #08 | 0.02 | 2.44 | #33 | 0.02 | 1.53 |
| | | Front with Headset | 1.272 | | | | 1.27 | | | 1.27 | | | 1.27 |
| | | Back with Headset | 1.386 | | | | 1.39 | | | 1.39 | | | 1.39 |
| | LTE Band 7 | Front | 0.508 | 0.297 | 0.455 | 0.062 | 0.81 | | | 0.96 | | | 0.57 |
| | | Back | 1.205 | 0.382 | 1.001 | 0.082 | 1.59 | | | 2.21 | #34 | 0.02 | 1.29 |
| | | Front with Headset | | | | | 0.00 | | | 0.00 | | | 0.00 |
| | | Back with Headset | 1.181 | | | | 1.18 | | | 1.18 | | | 1.18 |



16.4 Product specific 10g SAR Exposure Conditions

| WWAN Band | | Exposure Position | 1 | 4 | 1+4 Summed 10g SAR (W/kg) | Case No | SPLSR |
|-----------|-------------|-------------------|---------------------|--------------------------|---------------------------|---------|-------|
| | | | WWAN 10g SAR (W/kg) | 5GHz WLAN 10g SAR (W/kg) | | | |
| GSM | GSM850 | Front | | 0.594 | 0.59 | | |
| | | Back | 1.800 | 1.450 | 3.25 | | |
| | | Left side | | 0.055 | 0.06 | | |
| | | Right side | | 0.563 | 0.56 | | |
| | | Top side | | 2.717 | 2.72 | | |
| | | Bottom side | | | 0.00 | | |
| | GSM1900 | Front | 1.960 | 0.594 | 2.55 | | |
| | | Back | 2.793 | 1.450 | 4.24 | #21 | 0.06 |
| | | Left side | | 0.055 | 0.06 | | |
| | | Right side | | 0.563 | 0.56 | | |
| WCDMA | WCDMA V | Front | | 0.594 | 0.59 | | |
| | | Back | 3.306 | 1.450 | 4.76 | #22 | 0.07 |
| | | Left side | | 0.055 | 0.06 | | |
| | | Right side | | 0.563 | 0.56 | | |
| | | Top side | | 2.717 | 2.72 | | |
| | | Bottom side | | | 0.00 | | |
| | WCDMA IV | Front | 2.167 | 0.594 | 2.76 | | |
| | | Back | 3.226 | 1.450 | 4.68 | #23 | 0.07 |
| | | Left side | | 0.055 | 0.06 | | |
| | | Right side | | 0.563 | 0.56 | | |
| | | Top side | | 2.717 | 2.72 | | |
| | | Bottom side | 3.502 | | 3.50 | | |
| | WCDMA II | Front | 1.602 | 0.594 | 2.20 | | |
| | | Back | 1.869 | 1.450 | 3.32 | | |
| | | Left side | | 0.055 | 0.06 | | |
| | | Right side | | 0.563 | 0.56 | | |
| | | Top side | | 2.717 | 2.72 | | |
| | | Bottom side | 3.169 | | 3.17 | | |
| LTE | LTE Band 5 | Front | | 0.594 | 0.59 | | |
| | | Back | 2.413 | 1.450 | 3.86 | | |
| | | Left side | | 0.055 | 0.06 | | |
| | | Right side | | 0.563 | 0.56 | | |
| | | Top side | | 2.717 | 2.72 | | |
| | | Bottom side | | | 0.00 | | |
| | LTE Band 66 | Front | 2.098 | 0.594 | 2.69 | | |
| | | Back | 3.150 | 1.450 | 4.60 | #24 | 0.07 |
| | | Left side | | 0.055 | 0.06 | | |
| | | Right side | | 0.563 | 0.56 | | |
| | | Top side | | 2.717 | 2.72 | | |
| | | Bottom side | 3.574 | | 3.57 | | |
| | LTE Band 2 | Front | 1.741 | 0.594 | 2.34 | | |
| | | Back | 2.016 | 1.450 | 3.47 | | |
| | | Left side | | 0.055 | 0.06 | | |
| | | Right side | | 0.563 | 0.56 | | |
| | | Top side | | 2.717 | 2.72 | | |
| | | Bottom side | 3.068 | | 3.07 | | |
| | LTE Band 7 | Front | 1.167 | 0.594 | 1.76 | | |
| | | Back | 3.410 | 1.450 | 4.86 | #25 | 0.07 |
| | | Left side | | 0.055 | 0.06 | | |
| | | Right side | | 0.563 | 0.56 | | |
| | | Top side | | 2.717 | 2.72 | | |
| | | Bottom side | 3.009 | | 3.01 | | |

Remark:

1. For Bluetooth Product specific 10g stand-alone SAR is not required for a transmitter or antenna, due to 1g hotspot SAR is <1.2W/kg.
2. If SPLSR ≤ 0.10 for 10g SAR, simultaneously transmission SAR measurement is not necessary.

16.5 SPLSR Evaluation and Analysis

General Note:

1. When standalone SAR is measured for both antennas in the pair, the peak location separation distance is computed by the square root of $[(x1-x2)^2 + (y1-y2)^2 + (z1-z2)^2]$, where $(x1, y1, z1)$ and $(x2, y2, z2)$ are the coordinates in the area scans or extrapolated peak SAR locations in the zoom scans, as appropriate.
2. $SPLSR = (SAR1 + SAR2)1.5 / (\text{min. separation distance, mm})$. If $SPLSR \leq 0.04$ for 1g SAR and $SPLSR \leq 0.10$ for 10g SAR, simultaneously transmission SAR measurement is not necessary.

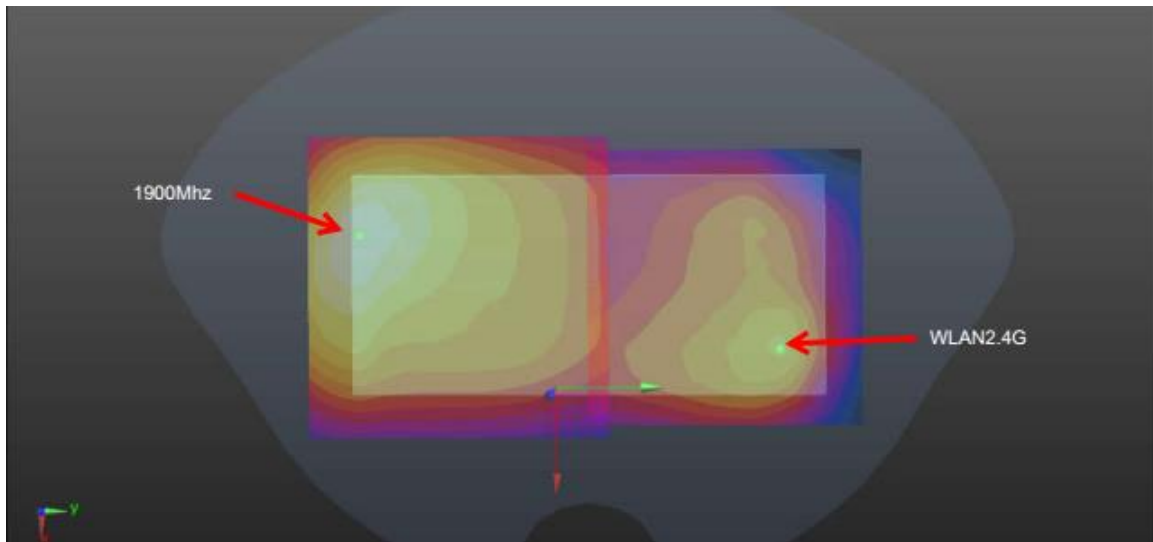

Front for WWAN+WLAN2.4GHz_5mm

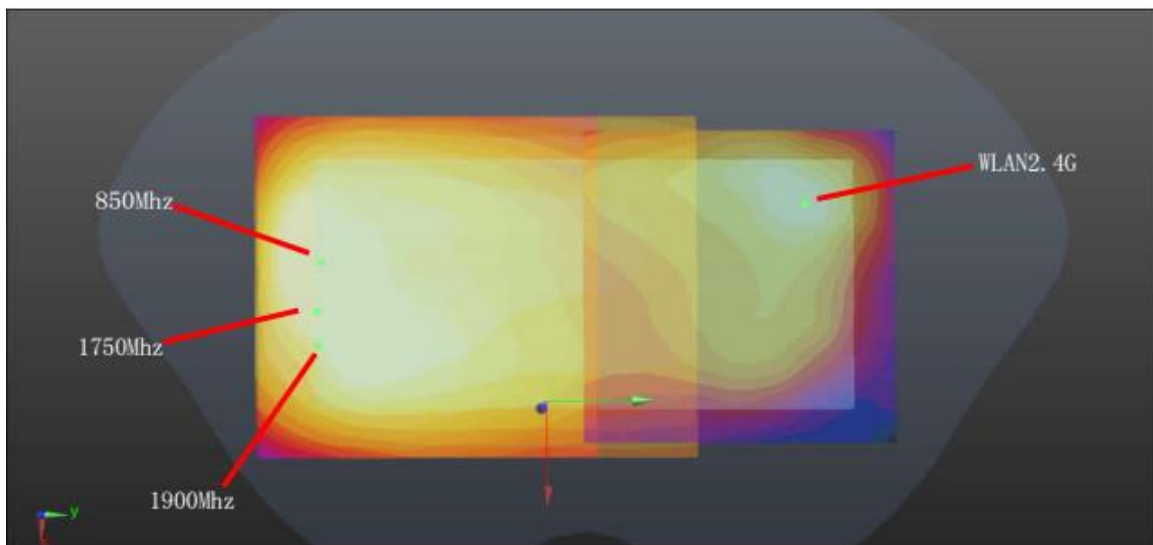

Back for WWAN+WLAN2.4GHz_5mm

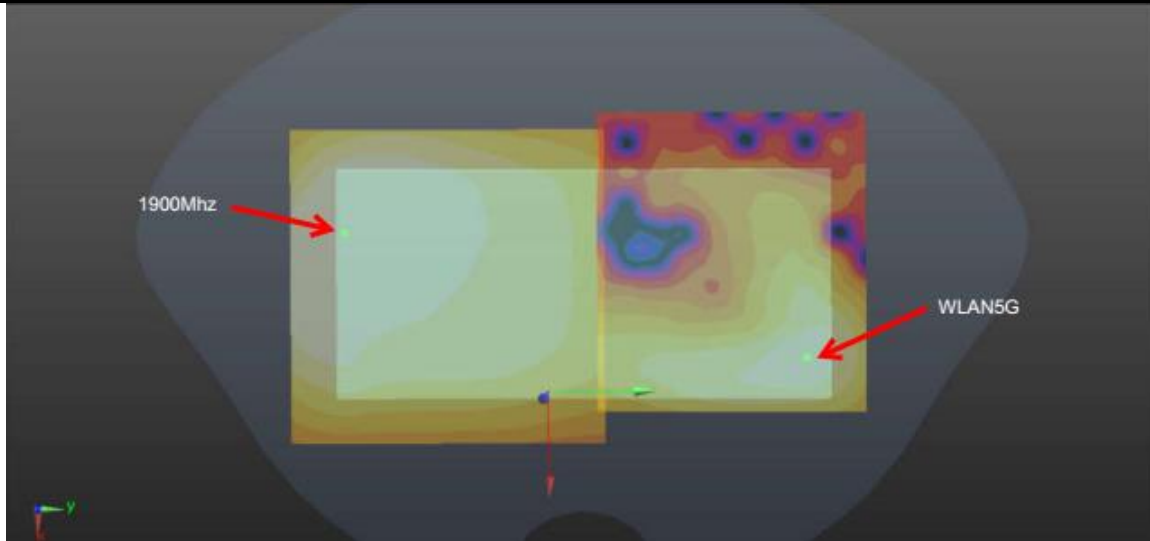

Front for WWAN+ WLAN5GHz_5mm

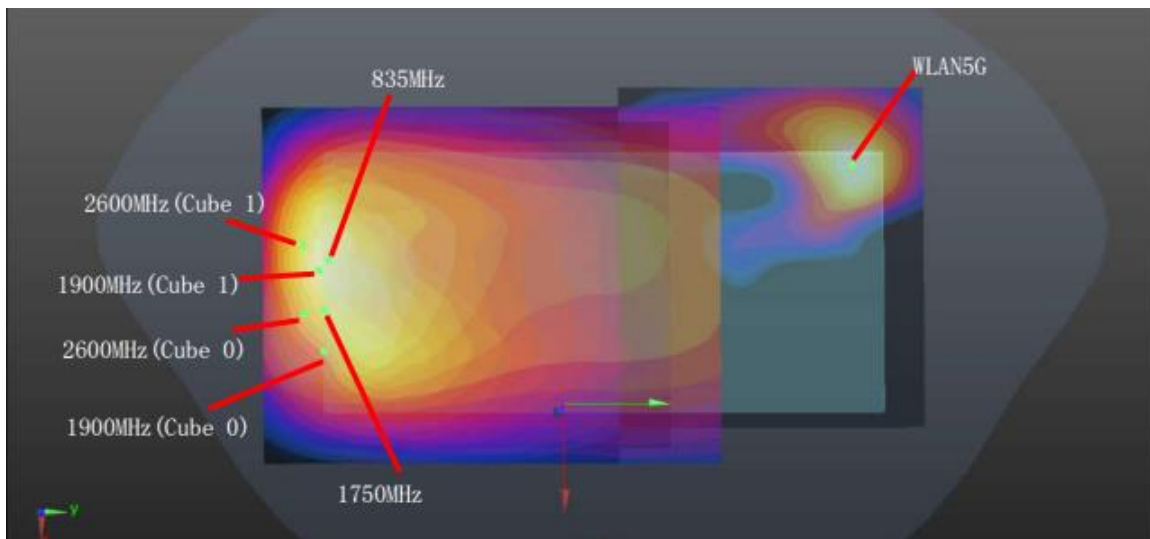

Back for WWAN+WLAN5GHz_5mm

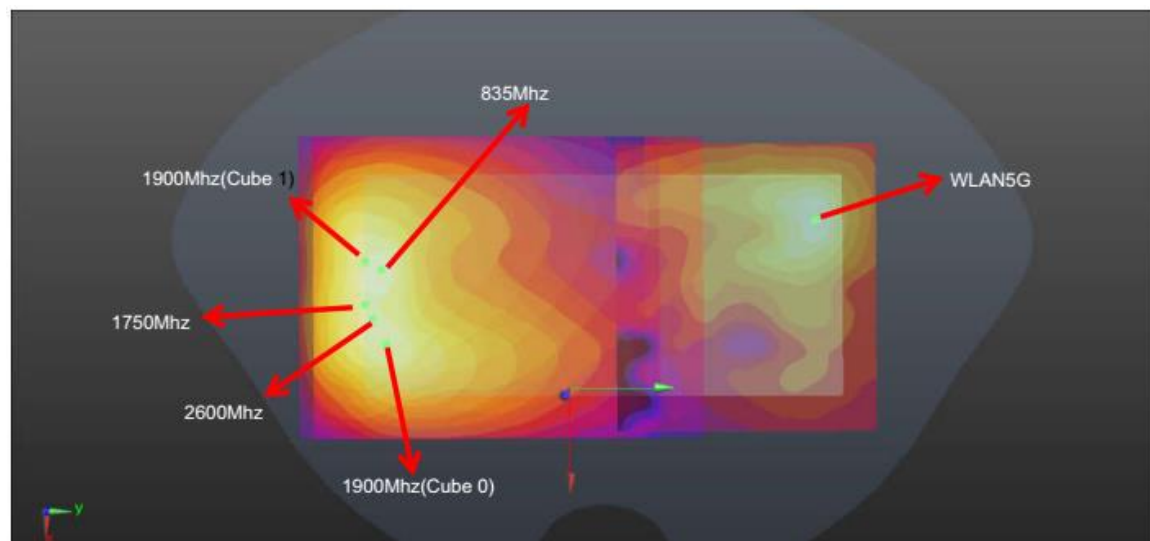

Back for WWAN+WLAN5GHz_0mm

| Back 5mm (wwan+2.4G)-Hotspot/Body worn | | | | | | | | | | | |
|--|-------------|----------|---------------|-------------|-----------------------|---------|--------|------------------------|----------------------|------------------|---------------------|
| Case 1 Plot No | Band | Position | SAR (W/kg) | Gap (mm) | SAR peak location (m) | | | 3D distance (mm) | Summed SAR (W/kg) | SPLSR Results | Simultaneous SAR |
| | | | | | X | Y | Z | | | | |
| | GSM 850 | Back | 1.257 | 5 | -0.0245 | -0.0805 | -0.208 | 150.0 | 1.64 | 0.01 | Not required |
| | WLAN2.4GHz | | 0.382 | 5 | -0.0422 | 0.0684 | -0.207 | | | | |
| Back 5mm (wwan+2.4G)-Hotspot/Body worn | | | | | | | | | | | |
| Case 2 Plot No | Band | Position | SAR (W/kg) | Gap (mm) | SAR peak location (m) | | | 3D distance (mm) | Summed SAR (W/kg) | SPLSR Results | Simultaneous SAR |
| | | | | | X | Y | Z | | | | |
| | GSM 1900 | Back | 1.215 | 5 | 0.001 | -0.0815 | -0.207 | 156.0 | 1.60 | 0.01 | Not required |
| | WLAN2.4GHz | | 0.382 | 5 | -0.0422 | 0.0684 | -0.207 | | | | |
| Back 5mm (wwan+2.4G)-Hotspot/Body worn | | | | | | | | | | | |
| Case 4 Plot No | Band | Position | SAR (W/kg) | Gap (mm) | SAR peak location (m) | | | 3D distance (mm) | Summed SAR (W/kg) | SPLSR Results | Simultaneous SAR |
| | | | | | X | Y | Z | | | | |
| | WCDMA IV | Back | 1.363 | 5 | -0.023 | -0.0715 | -0.208 | 141.2 | 1.75 | 0.02 | Not required |
| | WLAN2.4GHz | | 0.382 | 5 | -0.0422 | 0.0684 | -0.207 | | | | |
| Back 5mm (wwan+2.4G)-Hotspot/Body worn | | | | | | | | | | | |
| Case 6 Plot No | Band | Position | SAR (W/kg) | Gap (mm) | SAR peak location (m) | | | 3D distance (mm) | Summed SAR (W/kg) | SPLSR Results | Simultaneous SAR |
| | | | | | X | Y | Z | | | | |
| | LTE Band 5 | Back | 1.36 | 5 | -0.0245 | -0.0805 | -0.208 | 150.0 | 1.74 | 0.02 | Not required |
| | WLAN2.4GHz | | 0.382 | 5 | -0.0422 | 0.0684 | -0.207 | | | | |
| Back 5mm (wwan+2.4G)-Hotspot/Body worn | | | | | | | | | | | |
| Case 7 Plot No | Band | Position | SAR (W/kg) | Gap (mm) | SAR peak location (m) | | | 3D distance (mm) | Summed SAR (W/kg) | SPLSR Results | Simultaneous SAR |
| | | | | | X | Y | Z | | | | |
| | LTE Band 66 | Back | 1.438 | 5 | -0.0095 | -0.082 | -0.207 | 153.9 | 1.82 | 0.02 | Not required |
| | WLAN2.4GHz | | 0.382 | 5 | -0.0422 | 0.0684 | -0.207 | | | | |
| Back 5mm (wwan+2.4G)-Hotspot/Body worn | | | | | | | | | | | |
| Case 8 Plot No | Band | Position | SAR (W/kg) | Gap (mm) | SAR peak location (m) | | | 3D distance (mm) | Summed SAR (W/kg) | SPLSR Results | Simultaneous SAR |
| | | | | | X | Y | Z | | | | |
| | LTE Band 2 | Back | 1.443 | 5 | -0.0255 | -0.0795 | -0.206 | 148.8 | 1.83 | 0.02 | Not required |
| | WLAN2.4GHz | | 0.382 | 5 | -0.0422 | 0.0684 | -0.207 | | | | |
| Front 5mm (wwan+2.4G)-Hotspot/Body worn | | | | | | | | | | | |
| Case 19 Plot No | Band | Position | SAR (W/kg) | Gap (mm) | SAR peak location (m) | | | 3D distance (mm) | Summed SAR (W/kg) | SPLSR Results | Simultaneous SAR |
| | | | | | X | Y | Z | | | | |
| | LTE Band 2 | Front | 1.317 | 5 | -0.035 | -0.0795 | -0.206 | 167.6 | 1.61 | 0.01 | Not required |
| | WLAN2.4GHz | | 0.297 | 5 | 0.046 | 0.0672 | -0.207 | | | | |
| Front 5mm (wwan+5G)-Hotspot | | | | | | | | | | | |
| Case 20 Plot No | Band | Position | SAR (W/kg) | Gap (mm) | SAR peak location (m) | | | 3D distance (mm) | Summed SAR (W/kg) | SPLSR Results | Simultaneous SAR |
| | | | | | X | Y | Z | | | | |
| | LTE Band 2 | Front | 1.317 | 5 | -0.035 | -0.0795 | -0.206 | 160.8 | 1.72 | 0.01 | Not required |
| | WLAN5GHz | | 0.405 | 5 | 0.006 | 0.076 | -0.208 | | | | |

| Back 5mm (wwan+5G)-Hotspot | | | | | | | | | | | |
|----------------------------|-------------------|----------|------------|----------|-----------------------|---------|--------|------------------|-------------------|---------------|------------------|
| Case Plot No | Band | Position | SAR (W/kg) | Gap (mm) | SAR peak location (m) | | | 3D distance (mm) | Summed SAR (W/kg) | SPLSR Results | Simultaneous SAR |
| | | | | | X | Y | Z | | | | |
| Case 10 Plot No | GSM 850 | Back | 1.257 | 5 | -0.0245 | -0.0805 | -0.208 | 158.1 | 2.15 | 0.02 | Not required |
| | WLAN5GHz | | 0.891 | 5 | -0.053 | 0.075 | -0.209 | | | | |
| Case 11 Plot No | GSM 1900 | Back | 1.215 | 5 | 0.001 | -0.0815 | -0.207 | 165.6 | 2.11 | 0.02 | Not required |
| | WLAN5GHz | | 0.891 | 5 | -0.053 | 0.075 | -0.209 | | | | |
| Case 12 Plot No | WCDMA V | Back | 1.184 | 5 | -0.0205 | -0.0765 | -0.208 | 154.9 | 2.08 | 0.02 | Not required |
| | WLAN5GHz | | 0.891 | 5 | -0.053 | 0.075 | -0.209 | | | | |
| Case 13 Plot No | WCDMA IV | Back | 1.363 | 5 | -0.023 | -0.0715 | -0.208 | 149.5 | 2.25 | 0.02 | Not required |
| | WLAN5GHz | | 0.891 | 5 | -0.053 | 0.075 | -0.209 | | | | |
| Case 14 Plot No | WCDMA II Cube 0 | Back | 1.206 | 5 | -0.0135 | -0.082 | -0.207 | 161.9 | 2.10 | 0.02 | Not required |
| | WLAN5GHz | | 0.891 | 5 | -0.053 | 0.075 | -0.209 | | | | |
| | WCDMA II Cube 1 | Back | 1.189 | 5 | -0.0135 | -0.0835 | -0.207 | 163.4 | 2.08 | 0.02 | Not required |
| | WLAN5GHz | | 0.891 | 5 | -0.053 | 0.075 | -0.209 | | | | |
| Case 15 Plot No | LTE Band 5 | Back | 1.36 | 5 | -0.0245 | -0.0805 | -0.208 | 158.1 | 2.25 | 0.02 | Not required |
| | WLAN5GHz | | 0.891 | 5 | -0.053 | 0.075 | -0.209 | | | | |
| Case 16 Plot No | LTE Band 66 | Back | 1.438 | 5 | -0.0095 | -0.082 | -0.207 | 162.9 | 2.33 | 0.02 | Not required |
| | WLAN5GHz | | 0.891 | 5 | -0.053 | 0.075 | -0.209 | | | | |
| Case 17 Plot No | LTE Band 2 | Back | 1.443 | 5 | -0.0255 | -0.0795 | -0.206 | 157.0 | 2.33 | 0.02 | Not required |
| | WLAN5GHz | | 0.891 | 5 | -0.053 | 0.075 | -0.209 | | | | |
| Case 18 Plot No | LTE Band 7 Cube 0 | Back | 1.205 | 5 | -0.0086 | -0.088 | -0.207 | 169.0 | 2.10 | 0.02 | Not required |
| | WLAN5GHz | | 0.891 | 5 | -0.053 | 0.075 | -0.209 | | | | |
| | LTE Band 7 Cube 1 | Back | 1.138 | 5 | -0.014 | -0.088 | -0.207 | 167.6 | 2.03 | 0.02 | Not required |
| | WLAN5GHz | | 0.891 | 5 | -0.053 | 0.075 | -0.209 | | | | |

| Back 5mm (wwan+5G)-Body worn | | | | | | | | | | | |
|------------------------------|-------------------|----------|------------|----------|-----------------------|---------|--------|------------------|-------------------|---------------|------------------|
| Case Plot No | Band | Position | SAR (W/kg) | Gap (mm) | SAR peak location (m) | | | 3D distance (mm) | Summed SAR (W/kg) | SPLSR Results | Simultaneous SAR |
| | | | | | X | Y | Z | | | | |
| Case 26 Plot No | GSM 850 | Back | 1.257 | 5 | -0.0245 | -0.0805 | -0.208 | 158.3 | 2.26 | 0.02 | Not required |
| | WLAN5GHz | | 1.001 | 5 | -0.048 | 0.076 | -0.208 | | | | |
| Case 27 Plot No | GSM 1900 | Back | 1.215 | 5 | 0.001 | -0.0815 | -0.207 | 164.9 | 2.22 | 0.02 | Not required |
| | WLAN5GHz | | 1.001 | 5 | -0.048 | 0.076 | -0.208 | | | | |
| Case 28 Plot No | WCDMA V | Back | 1.184 | 5 | -0.0205 | -0.0765 | -0.208 | 155.0 | 2.19 | 0.02 | Not required |
| | WLAN5GHz | | 1.001 | 5 | -0.048 | 0.076 | -0.208 | | | | |
| Case 29 Plot No | WCDMA IV | Back | 1.363 | 5 | -0.023 | -0.0715 | -0.208 | 149.6 | 2.36 | 0.02 | Not required |
| | WLAN5GHz | | 1.001 | 5 | -0.048 | 0.076 | -0.208 | | | | |
| Case 30 Plot No | WCDMA II Cube 0 | Back | 1.206 | 5 | -0.0135 | -0.082 | -0.207 | 161.7 | 2.21 | 0.02 | Not required |
| | WLAN5GHz | | 1.001 | 5 | -0.048 | 0.076 | -0.208 | | | | |
| | WCDMA II Cube 1 | Back | 1.189 | 5 | -0.0135 | -0.0835 | -0.207 | | | | |
| | WLAN5GHz | | 1.001 | 5 | -0.048 | 0.076 | -0.208 | | | | |
| Case 31 Plot No | LTE Band 5 | Back | 1.36 | 5 | -0.0245 | -0.0805 | -0.208 | 158.3 | 2.36 | 0.02 | Not required |
| | WLAN5GHz | | 1.001 | 5 | -0.048 | 0.076 | -0.208 | | | | |
| Case 32 Plot No | LTE Band 66 | Back | 1.438 | 5 | -0.0095 | -0.082 | -0.207 | 162.6 | 2.44 | 0.02 | Not required |
| | WLAN5GHz | | 1.001 | 5 | -0.048 | 0.076 | -0.208 | | | | |
| Case 33 Plot No | LTE Band 2 | Back | 1.443 | 5 | -0.0255 | -0.0795 | -0.206 | 157.1 | 2.44 | 0.02 | Not required |
| | WLAN5GHz | | 1.001 | 5 | -0.048 | 0.076 | -0.208 | | | | |
| Case 34 Plot No | LTE Band 7 Cube 0 | Back | 1.205 | 5 | -0.0086 | -0.088 | -0.207 | 168.7 | 2.21 | 0.02 | Not required |
| | WLAN5GHz | | 1.001 | 5 | -0.048 | 0.076 | -0.208 | | | | |
| | LTE Band 7 Cube 1 | Back | 1.138 | 5 | -0.014 | -0.088 | -0.207 | | | | |
| | WLAN5GHz | | 1.001 | 5 | -0.048 | 0.076 | -0.208 | | | | |

| Front 5mm (wwan+5G)-Body worn | | | | | | | | | | | |
|-------------------------------|------------|----------|---------------|-------------|-----------------------|---------|--------|------------------------|----------------------|------------------|---------------------|
| Case 35 Plot No | Band | Position | SAR (W/kg) | Gap (mm) | SAR peak location (m) | | | 3D distance (mm) | Summed SAR (W/kg) | SPLSR Results | Simultaneous SAR |
| | | | | | X | Y | Z | | | | |
| | LTE Band 2 | Front | 1.317 | 5 | -0.035 | -0.0795 | -0.206 | 167.8 | 1.77 | 0.01 | Not required |
| | WLAN5GHz | | 0.455 | 5 | 0.02 | 0.079 | -0.207 | | | | |

| Back 0mm (wwan+5G) | | | | | | | | | | | |
|--------------------|-----------------|----------|---------------|-------------|-----------------------|---------|--------|------------------------|----------------------|------------------|---------------------|
| Case 21 Plot No | Band | Position | SAR (W/kg) | Gap (mm) | SAR peak location (m) | | | 3D distance (mm) | Summed SAR (W/kg) | SPLSR Results | Simultaneous SAR |
| | | | | | X | Y | Z | | | | |
| | GSM 1900 Cube 0 | Back | 2.793 | 0 | 0.0025 | -0.075 | -0.207 | 152.3 | 4.24 | 0.06 | Not required |
| | WLAN5GHz | | 1.45 | 0 | -0.041 | 0.071 | -0.208 | | | | |
| | GSM 1900 Cube 1 | Back | 2.433 | 0 | -0.023 | -0.0765 | -0.207 | 148.6 | 3.88 | 0.05 | Not required |
| | WLAN5GHz | | 1.45 | 0 | -0.041 | 0.071 | -0.208 | | | | |

| Case 22 Plot No | Band | Position | SAR (W/kg) | Gap (mm) | SAR peak location (m) | | | 3D distance (mm) | Summed SAR (W/kg) | SPLSR Results | Simultaneous SAR |
|--------------------|----------|----------|---------------|-------------|-----------------------|--------|--------|------------------------|----------------------|------------------|---------------------|
| | | | | | X | Y | Z | | | | |
| | WCDMA V | Back | 3.306 | 0 | -0.026 | -0.082 | -0.207 | 153.7 | 4.76 | 0.07 | Not required |
| | WLAN5GHz | | 1.45 | 0 | -0.041 | 0.071 | -0.208 | | | | |

| Case 23 Plot No | Band | Position | SAR (W/kg) | Gap (mm) | SAR peak location (m) | | | 3D distance (mm) | Summed SAR (W/kg) | SPLSR Results | Simultaneous SAR |
|--------------------|----------|----------|---------------|-------------|-----------------------|--------|--------|------------------------|----------------------|------------------|---------------------|
| | | | | | X | Y | Z | | | | |
| | WCDMA IV | Back | 3.226 | 0 | -0.027 | -0.074 | -0.207 | 145.7 | 4.68 | 0.07 | Not required |
| | WLAN5GHz | | 1.45 | 0 | -0.041 | 0.071 | -0.208 | | | | |

| Case 24 Plot No | Band | Position | SAR (W/kg) | Gap (mm) | SAR peak location (m) | | | 3D distance (mm) | Summed SAR (W/kg) | SPLSR Results | Simultaneous SAR |
|--------------------|-------------|----------|---------------|-------------|-----------------------|--------|--------|------------------------|----------------------|------------------|---------------------|
| | | | | | X | Y | Z | | | | |
| | LTE Band 66 | Back | 3.15 | 0 | -0.027 | -0.074 | -0.207 | 145.7 | 4.60 | 0.07 | Not required |
| | WLAN5GHz | | 1.45 | 0 | -0.041 | 0.071 | -0.208 | | | | |

| Case 25 Plot No | Band | Position | SAR (W/kg) | Gap (mm) | SAR peak location (m) | | | 3D distance (mm) | Summed SAR (W/kg) | SPLSR Results | Simultaneous SAR |
|--------------------|------------|----------|---------------|-------------|-----------------------|---------|--------|------------------------|----------------------|------------------|---------------------|
| | | | | | X | Y | Z | | | | |
| | LTE Band 7 | Back | 3.41 | 0 | -0.0062 | -0.0796 | -0.207 | 154.6 | 4.86 | 0.07 | Not required |
| | WLAN5GHz | | 1.45 | 0 | -0.041 | 0.071 | -0.208 | | | | |

Test Engineer : Changlin Huang, Bin He, Mengming Dai



17. Uncertainty Assessment

Per KDB 865664 D01 SAR measurement 100MHz to 6GHz, when the highest measured 1-g SAR within a frequency band is < 1.5 W/kg and the measured 10-g SAR within a frequency band is < 3.75 W/kg. The expanded SAR measurement uncertainty must be $\leq 30\%$, for a confidence interval of $k = 2$. If these conditions are met, extensive SAR measurement uncertainty analysis described in IEEE Std 1528-2013 is not required in SAR reports submitted for equipment approval. For this device, the highest measured 1-g SAR is less 1.5W/kg and highest measured 10-g SAR is less 3.75W/kg. Therefore, the measurement uncertainty table is not required in this report.

18. References

- [1] FCC 47 CFR Part 2 “Frequency Allocations and Radio Treaty Matters; General Rules and Regulations”
- [2] ANSI/IEEE Std. C95.1-1992, “IEEE Standard for Safety Levels with Respect to Human Exposure to Radio Frequency Electromagnetic Fields, 3 kHz to 300 GHz”, September 1992
- [3] IEEE Std. 1528-2013, “IEEE Recommended Practice for Determining the Peak Spatial-Average Specific Absorption Rate (SAR) in the Human Head from Wireless Communications Devices: Measurement Techniques”, Sep 2013
- [4] SPEAG DASY System Handbook
- [5] FCC KDB 865664 D01 v01r04, "SAR Measurement Requirements for 100 MHz to 6 GHz", Aug 2015.
- [6] FCC KDB 865664 D02 v01r02, “RF Exposure Compliance Reporting and Documentation Considerations” Oct 2015.
- [7] FCC KDB 447498 D01 v06, “Mobile and Portable Device RF Exposure Procedures and Equipment Authorization Policies”, Oct 2015
- [8] FCC KDB 648474 D04 v01r03, “SAR Evaluation Considerations for Wireless Handsets”, Oct 2015.
- [9] FCC KDB 248227 D01 v02r02, “SAR Guidance for IEEE 802.11 (WiFi) Transmitters”, Oct 2015.
- [10] FCC KDB 616217 D04 v01r02, “SAR Evaluation Considerations for Laptop, Notebook, Netbook and Tablet Computers”, Oct 2015
- [11] FCC KDB 941225 D01 v03r01, “3G SAR MEAUREMENT PROCEDURES”, Oct 2015
- [12] FCC KDB 941225 D05 v02r05, “SAR Evaluation Considerations for LTE Devices”, Dec 2015
- [13] FCC KDB 941225 D06 v02r01, "SAR Evaluation Procedures for Portable Devices with Wireless Router Capabilities", Oct 2015.

-----THE END-----



Appendix A. Plots of System Performance Check

The plots are shown as follows.

System Check_Head_835MHz

DUT: D835V2-SN:4d162

Communication System: UID 0, CW (0); Frequency: 835 MHz; Duty Cycle: 1:1
Medium: HSL_835_201111 Medium parameters used: $f = 835 \text{ MHz}$; $\sigma = 0.929 \text{ S/m}$; $\epsilon_r = 41.793$; $\rho = 1000 \text{ kg/m}^3$
Ambient Temperature : $23.4 \text{ }^\circ\text{C}$; Liquid Temperature : $22.4 \text{ }^\circ\text{C}$

DASY5 Configuration:

- Probe: EX3DV4 - SN7576; ConvF(10.45, 10.45, 10.45); Calibrated: 2020.01.22;
- Sensor-Surface: 1.4mm (Mechanical Surface Detection)
- Electronics: DAE3 Sn528; Calibrated: 2020.03.16
- Phantom: SAM (Front) with CRP v5.0; Type: QD000P40CD; Serial: TP:1795
- Measurement SW: DASY52, Version 52.8 (8); SEMCAD X Version 14.6.10 (7331)

Pin=250mW/Area Scan (61x61x1): Interpolated grid: $dx=1.500 \text{ mm}$, $dy=1.500 \text{ mm}$
Maximum value of SAR (interpolated) = 3.09 W/kg

Pin=250mW/Zoom Scan (5x5x7)/Cube 0: Measurement grid: $dx=8\text{mm}$, $dy=8\text{mm}$, $dz=5\text{mm}$
Reference Value = 59.30 V/m ; Power Drift = 0.08 dB
Peak SAR (extrapolated) = 3.53 W/kg
SAR(1 g) = 2.36 W/kg ; SAR(10 g) = 1.54 W/kg
Maximum value of SAR (measured) = 3.14 W/kg

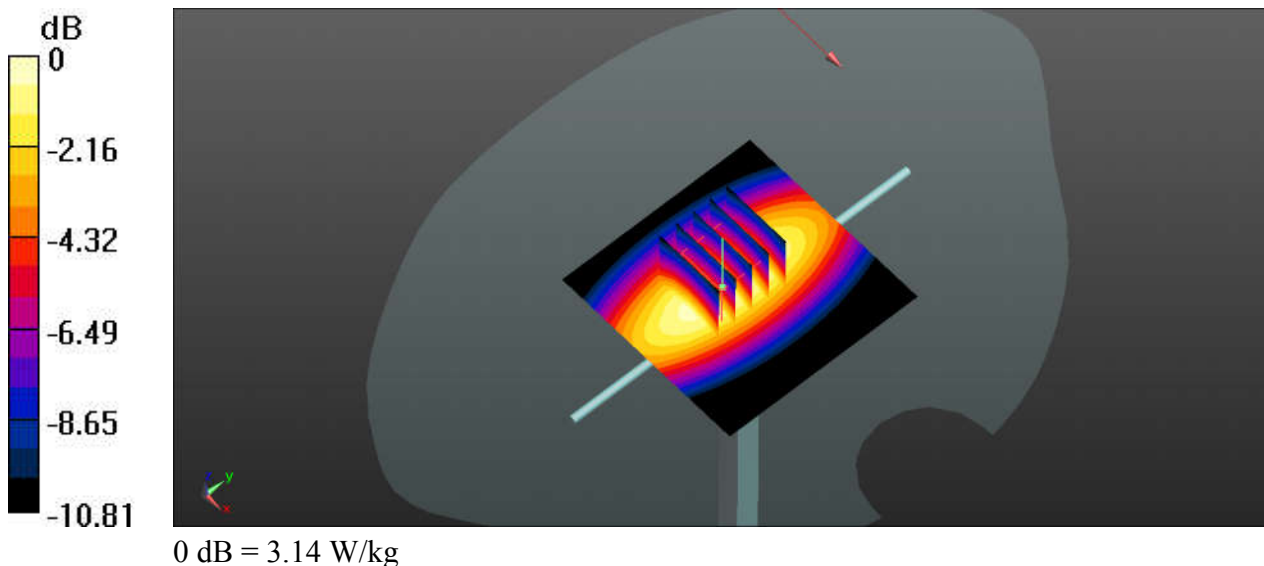

System Check_Head_835MHz

DUT: D835V2-SN:4d162

Communication System: UID 0, CW (0); Frequency: 835 MHz; Duty Cycle: 1:1

Medium: HSL_835_201115 Medium parameters used: $f = 835$ MHz; $\sigma = 0.938$ S/m; $\epsilon_r = 42.518$; $\rho = 1000$ kg/m³

Ambient Temperature : 23.4 °C ; Liquid Temperature : 22.4 °C

DASY5 Configuration:

- Probe: EX3DV4 - SN3826; ConvF(9.12, 9.12, 9.12); Calibrated: 2020.05.20;
- Sensor-Surface: 2mm (Mechanical Surface Detection)
- Electronics: DAE4 Sn1210; Calibrated: 2020.07.27
- Phantom: SAM2; Type: QD000P40CD; Serial: TP:1671
- Measurement SW: DASY52, Version 52.8 (8); SEMCAD X Version 14.6.10 (7331)

Pin=250mW/Area Scan (61x61x1): Interpolated grid: dx=1.500 mm, dy=1.500 mm
Maximum value of SAR (interpolated) = 3.23 W/kg

Pin=250mW/Zoom Scan (5x5x7)/Cube 0: Measurement grid: dx=8mm, dy=8mm, dz=5mm
Reference Value = 60.32 V/m; Power Drift = -0.14 dB
Peak SAR (extrapolated) = 3.81 W/kg
SAR(1 g) = 2.52 W/kg; SAR(10 g) = 1.65 W/kg
Maximum value of SAR (measured) = 3.22 W/kg

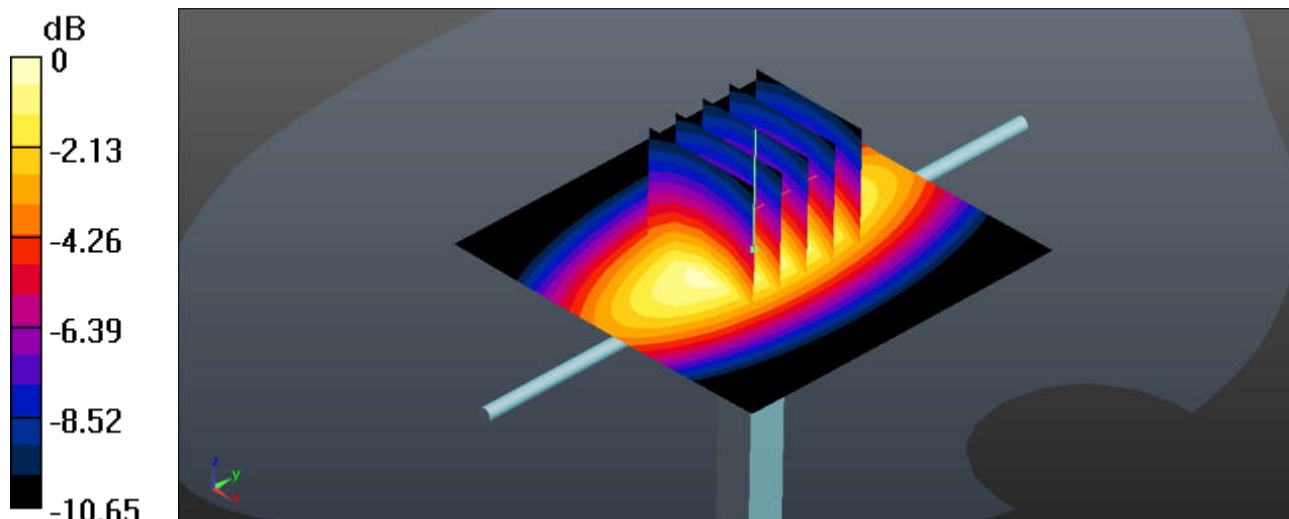

0 dB = 3.22 W/kg

System Check_Head_1750MHz

DUT: D1750V2-SN:1137

Communication System: UID 0, CW; Frequency: 1750 MHz; Duty Cycle: 1:1

Medium: HSL_1750_201111 Medium parameters used: $f = 1750$ MHz; $\sigma = 1.373$ S/m; $\epsilon_r = 41.392$; $\rho = 1000$ kg/m³

Ambient Temperature : 23.4 °C; Liquid Temperature : 22.6 °C

DASY5 Configuration:

- Probe: EX3DV4 - SN3826; ConvF(7.98, 7.98, 7.98); Calibrated: 2020.05.20;
- Sensor-Surface: 2mm (Mechanical Surface Detection)
- Electronics: DAE4 Sn1210; Calibrated: 2020.07.27
- Phantom: SAM2; Type: QD000P40CD; Serial: TP:1671
- Measurement SW: DASY52, Version 52.8 (8); SEMCAD X Version 14.6.10 (7331)

Pin=250mW/Area Scan (61x61x1): Interpolated grid: dx=1.500 mm, dy=1.500 mm

Maximum value of SAR (interpolated) = 13.2 W/kg

Pin=250mW/Zoom Scan (5x5x7)/Cube 0: Measurement grid: dx=8mm, dy=8mm, dz=5mm

Reference Value = 92.43 V/m; Power Drift = -0.02 dB

Peak SAR (extrapolated) = 16.9 W/kg

SAR(1 g) = 9.39 W/kg; SAR(10 g) = 4.99 W/kg

Maximum value of SAR (measured) = 13.3 W/kg

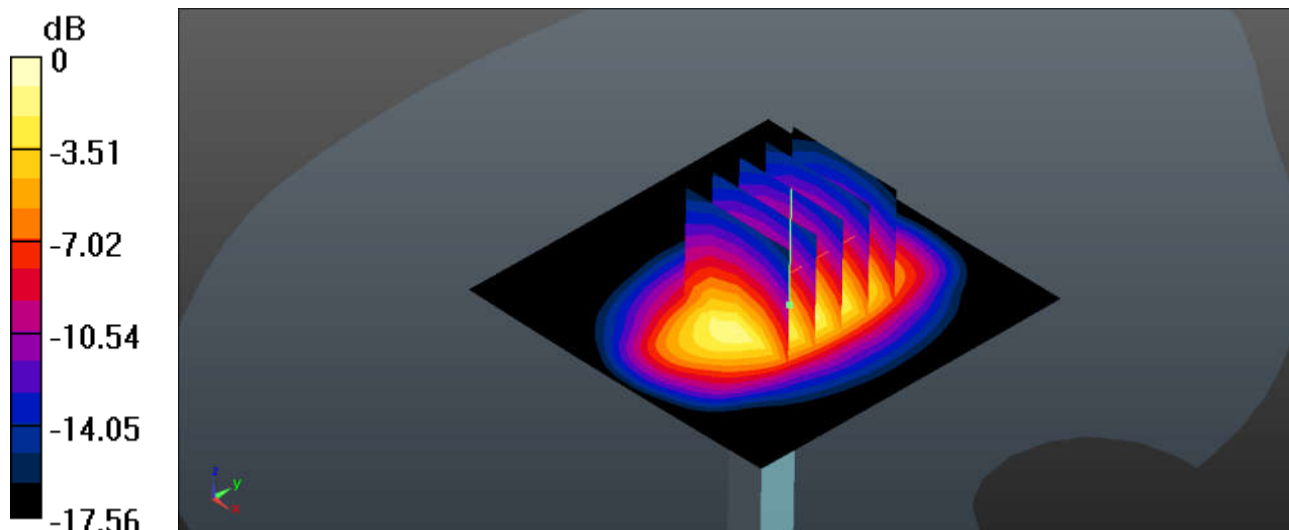

0 dB = 13.3 W/kg

System Check_Head_1750MHz

DUT: D1750V2-SN:1137

Communication System: UID 0, CW; Frequency: 1750 MHz; Duty Cycle: 1:1

Medium: HSL_1750_201112 Medium parameters used: $f = 1750$ MHz; $\sigma = 1.406$ S/m; $\epsilon_r = 41.525$; $\rho = 1000$ kg/m³

Ambient Temperature : 23.5 °C; Liquid Temperature : 22.3 °C

DASY5 Configuration:

- Probe: ES3DV3 - SN3241; ConvF(5.22, 5.22, 5.22); Calibrated: 2020.05.14;
- Sensor-Surface: 3mm (Mechanical Surface Detection)
- Electronics: DAE4 Sn1437; Calibrated: 2019.11.19
- Phantom: SAM with CRP v4.0(Left); Type: QD000P40CC; Serial: TP:1576
- Measurement SW: DASY52, Version 52.8 (8); SEMCAD X Version 14.6.10 (7331)

Pin=250mW/Area Scan (61x61x1): Interpolated grid: dx=1.500 mm, dy=1.500 mm
Maximum value of SAR (interpolated) = 12.0 W/kg

Pin=250mW/Zoom Scan (5x5x7)/Cube 0: Measurement grid: dx=8mm, dy=8mm, dz=5mm
Reference Value = 92.62 V/m; Power Drift = 0.13 dB
Peak SAR (extrapolated) = 16.7 W/kg
SAR(1 g) = 9.66 W/kg; SAR(10 g) = 5.27 W/kg
Maximum value of SAR (measured) = 12.0 W/kg

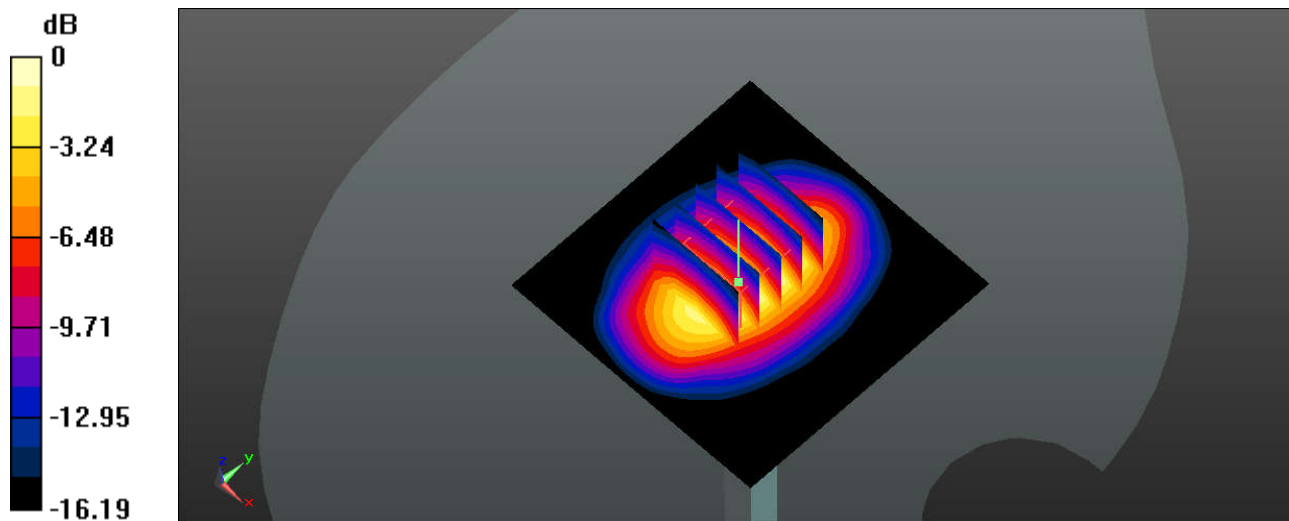

System Check_Head_1900MHz

DUT: D1900V2-SN:5d182

Communication System: UID 0, CW; Frequency: 1900 MHz; Duty Cycle: 1:1

Medium: HSL_1900_201111 Medium parameters used: $f = 1900$ MHz; $\sigma = 1.455$ S/m; $\epsilon_r = 40.068$; $\rho = 1000$ kg/m³

Ambient Temperature : 23.5 °C; Liquid Temperature : 22.5 °C

DASY5 Configuration:

- Probe: EX3DV4 - SN3826; ConvF(7.67, 7.67, 7.67); Calibrated: 2020.05.20;
- Sensor-Surface: 2mm (Mechanical Surface Detection)
- Electronics: DAE4 Sn1210; Calibrated: 2020.07.27
- Phantom: SAM2; Type: QD000P40CD; Serial: TP:1671
- Measurement SW: DASY52, Version 52.8 (8); SEMCAD X Version 14.6.10 (7331)

Pin=250mW/Area Scan (61x61x1): Interpolated grid: dx=1.500 mm, dy=1.500 mm

Maximum value of SAR (interpolated) = 15.2 W/kg

Pin=250mW/Zoom Scan (5x5x7)/Cube 0: Measurement grid: dx=8mm, dy=8mm, dz=5mm

Reference Value = 101.4 V/m; Power Drift = 0.18 dB

Peak SAR (extrapolated) = 19.7 W/kg

SAR(1 g) = 10.5 W/kg; SAR(10 g) = 5.34 W/kg

Maximum value of SAR (measured) = 15.1 W/kg

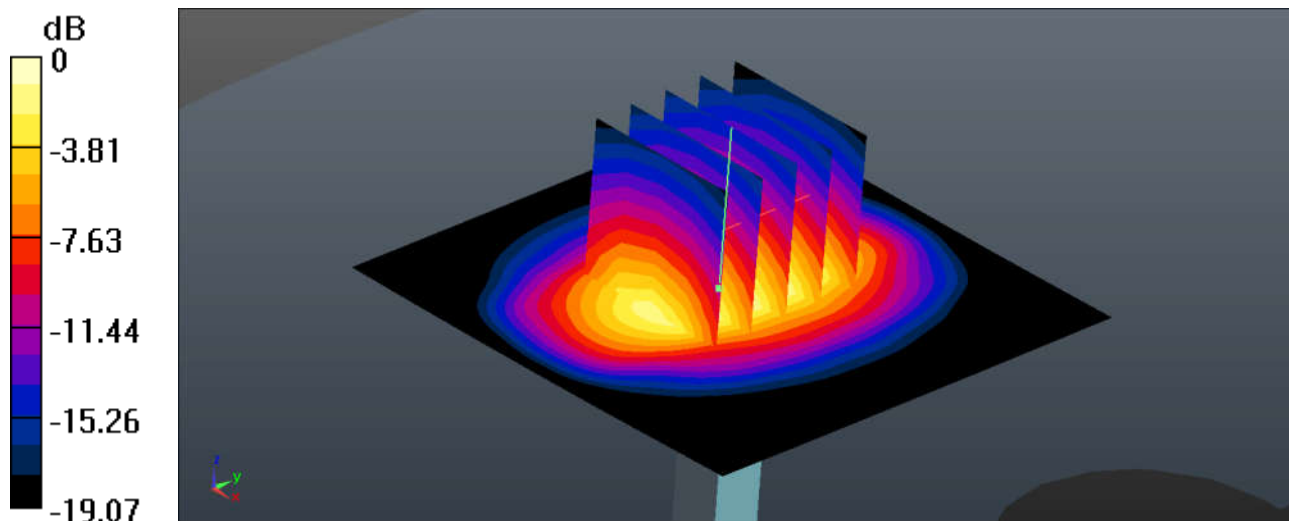

0 dB = 15.1 W/kg

System Check_Head_1900MHz

DUT: D1900V2-SN:5d182

Communication System: UID 0, CW; Frequency: 1900 MHz; Duty Cycle: 1:1

Medium: HSL_1900_201112 Medium parameters used: $f = 1900$ MHz; $\sigma = 1.453$ S/m; $\epsilon_r = 39.146$; $\rho = 1000$ kg/m³

Ambient Temperature : 23.4 °C; Liquid Temperature : 22.5 °C

DASY5 Configuration:

- Probe: ES3DV3 - SN3241; ConvF(5.04, 5.04, 5.04); Calibrated: 2020.05.14;
- Sensor-Surface: 3mm (Mechanical Surface Detection)
- Electronics: DAE4 Sn1437; Calibrated: 2019.11.19
- Phantom: SAM with CRP v4.0(Left); Type: QD000P40CC; Serial: TP:1576
- Measurement SW: DASY52, Version 52.8 (8); SEMCAD X Version 14.6.10 (7331)

Pin=250mW/Area Scan (61x61x1): Interpolated grid: dx=1.500 mm, dy=1.500 mm

Maximum value of SAR (interpolated) = 13.7 W/kg

Pin=250mW/Zoom Scan (5x5x7)/Cube 0: Measurement grid: dx=8mm, dy=8mm, dz=5mm

Reference Value = 99.04 V/m; Power Drift = -0.07 dB

Peak SAR (extrapolated) = 19.7 W/kg

SAR(1 g) = 10.6 W/kg; SAR(10 g) = 5.49 W/kg

Maximum value of SAR (measured) = 13.4 W/kg

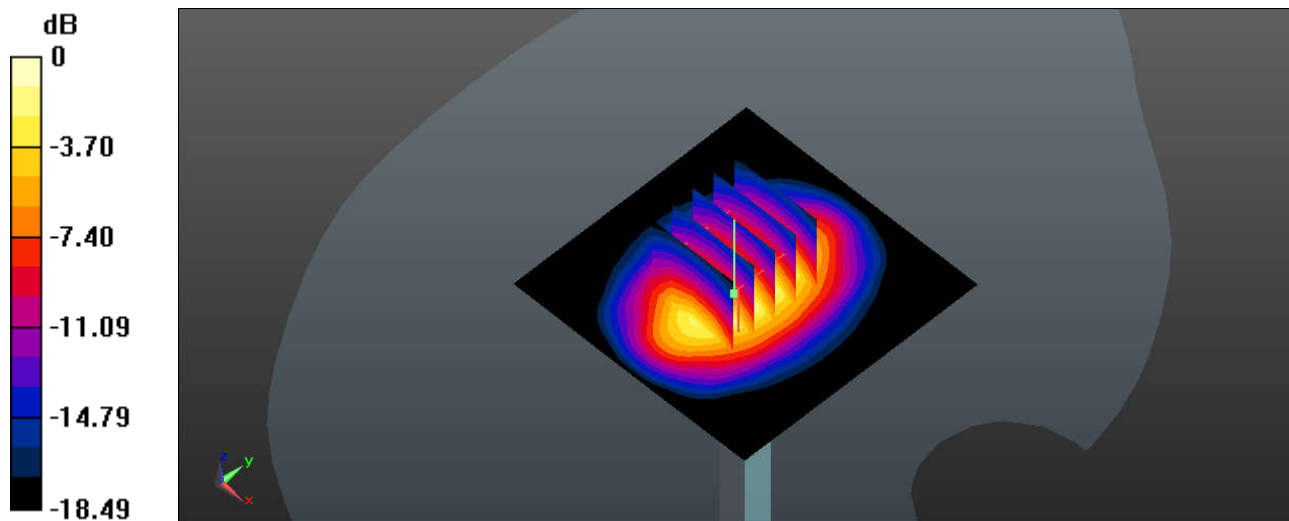

0 dB = 13.4 W/kg

System Check_Head_2450MHz

DUT: D2450V2-SN:924

Communication System: UID 0, CW; Frequency: 2450 MHz; Duty Cycle: 1:1

Medium: HSL_2450_201118 Medium parameters used: $f = 2450$ MHz; $\sigma = 1.809$ S/m; $\epsilon_r = 37.604$; $\rho = 1000$ kg/m³

Ambient Temperature : 23.4 °C; Liquid Temperature : 22.7 °C

DASY5 Configuration:

- Probe: EX3DV4 - SN3826; ConvF(7.12, 7.12, 7.12); Calibrated: 2020.05.20;
- Sensor-Surface: 1.4mm (Mechanical Surface Detection)
- Electronics: DAE4 Sn1210; Calibrated: 2020.07.27
- Phantom: SAM2; Type: QD000P40CD; Serial: TP:1671
- Measurement SW: DASY52, Version 52.8 (8); SEMCAD X Version 14.6.10 (7331)

Pin=250mW/Area Scan (81x81x1): Interpolated grid: dx=1.200 mm, dy=1.200 mm

Maximum value of SAR (interpolated) = 23.7 W/kg

Pin=250mW/Zoom Scan (7x7x7)/Cube 0: Measurement grid: dx=5mm, dy=5mm, dz=5mm

Reference Value = 105.6 V/m; Power Drift = 0.11 dB

Peak SAR (extrapolated) = 30.4 W/kg

SAR(1 g) = 13.8 W/kg; SAR(10 g) = 6.17 W/kg

Maximum value of SAR (measured) = 24.0 W/kg

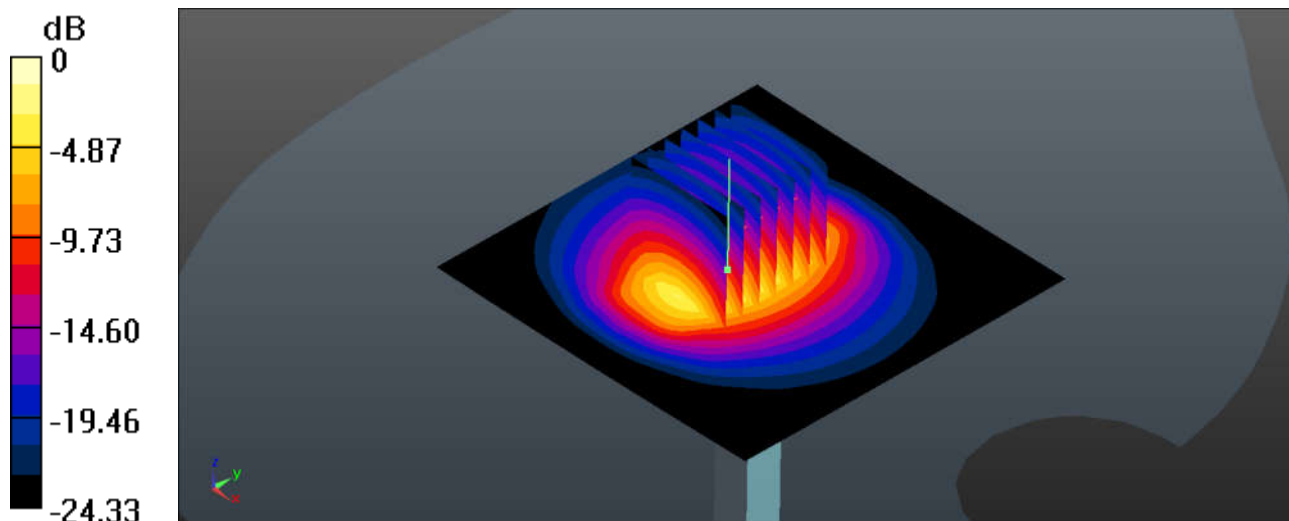

0 dB = 24.0 W/kg

System Check_Head_2600MHz

DUT: D2600V2-SN:1070

Communication System: UID 0, CW (0); Frequency: 2600 MHz; Duty Cycle: 1:1

Medium: HSL_2600_201112 Medium parameters used: $f = 2600$ MHz; $\sigma = 1.992$ S/m; $\epsilon_r = 40.445$; $\rho = 1000$ kg/m³

Ambient Temperature : 23.6 °C; Liquid Temperature : 22.4 °C

DASY5 Configuration:

- Probe: EX3DV4 - SN3826; ConvF(6.94, 6.94, 6.94); Calibrated: 2020.05.20;
- Sensor-Surface: 1.4mm (Mechanical Surface Detection)
- Electronics: DAE4 Sn1210; Calibrated: 2020.07.27
- Phantom: SAM2; Type: QD000P40CD; Serial: TP:1671
- Measurement SW: DASY52, Version 52.8 (8); SEMCAD X Version 14.6.10 (7331)

Pin=250mW/Area Scan (71x71x1): Interpolated grid: dx=1.200 mm, dy=1.200 mm

Maximum value of SAR (interpolated) = 26.0 W/kg

Pin=250mW/Zoom Scan (7x7x7)/Cube 0: Measurement grid: dx=5mm, dy=5mm, dz=5mm

Reference Value = 118.7 V/m; Power Drift = -0.11 dB

Peak SAR (extrapolated) = 33.4 W/kg

SAR(1 g) = 14.4 W/kg; SAR(10 g) = 6.17 W/kg

Maximum value of SAR (measured) = 26.0 W/kg

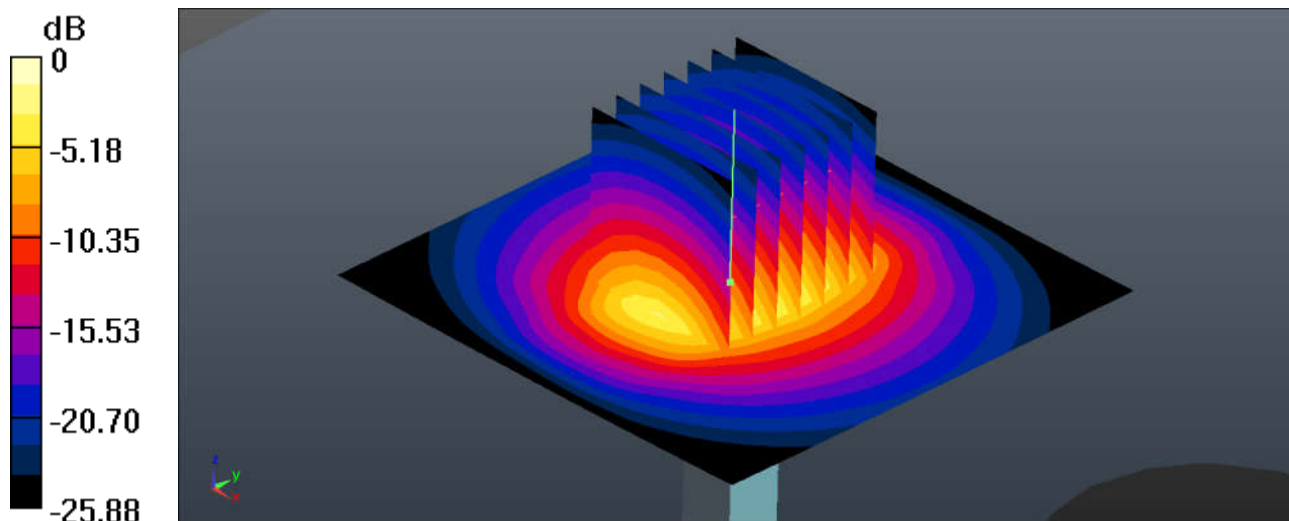

0 dB = 26.0 W/kg

System Check_Head_2600MHz

DUT: D2600V2-SN:1070

Communication System: UID 0, CW (0); Frequency: 2600 MHz; Duty Cycle: 1:1

Medium: HSL_2600_201113 Medium parameters used: $f = 2600$ MHz; $\sigma = 2.053$ S/m; $\epsilon_r = 38.007$; $\rho = 1000$ kg/m³

Ambient Temperature : 23.2 °C; Liquid Temperature : 22.3 °C

DASY5 Configuration:

- Probe: ES3DV3 - SN3241; ConvF(4.42, 4.42, 4.42); Calibrated: 2020.05.14;
- Sensor-Surface: 3mm (Mechanical Surface Detection)
- Electronics: DAE4 Sn1437; Calibrated: 2019.11.19
- Phantom: SAM with CRP v4.0(Left); Type: QD000P40CC; Serial: TP:1576
- Measurement SW: DASY52, Version 52.8 (8); SEMCAD X Version 14.6.10 (7331)

Pin=250mW/Area Scan (81x81x1): Interpolated grid: dx=1.200 mm, dy=1.200 mm

Maximum value of SAR (interpolated) = 21.5 W/kg

Pin=250mW/Zoom Scan (7x7x7)/Cube 0: Measurement grid: dx=5mm, dy=5mm, dz=5mm

Reference Value = 105.8 V/m; Power Drift = 0.11 dB

Peak SAR (extrapolated) = 35.1 W/kg

SAR(1 g) = 15.8 W/kg; SAR(10 g) = 6.84 W/kg

Maximum value of SAR (measured) = 21.3 W/kg

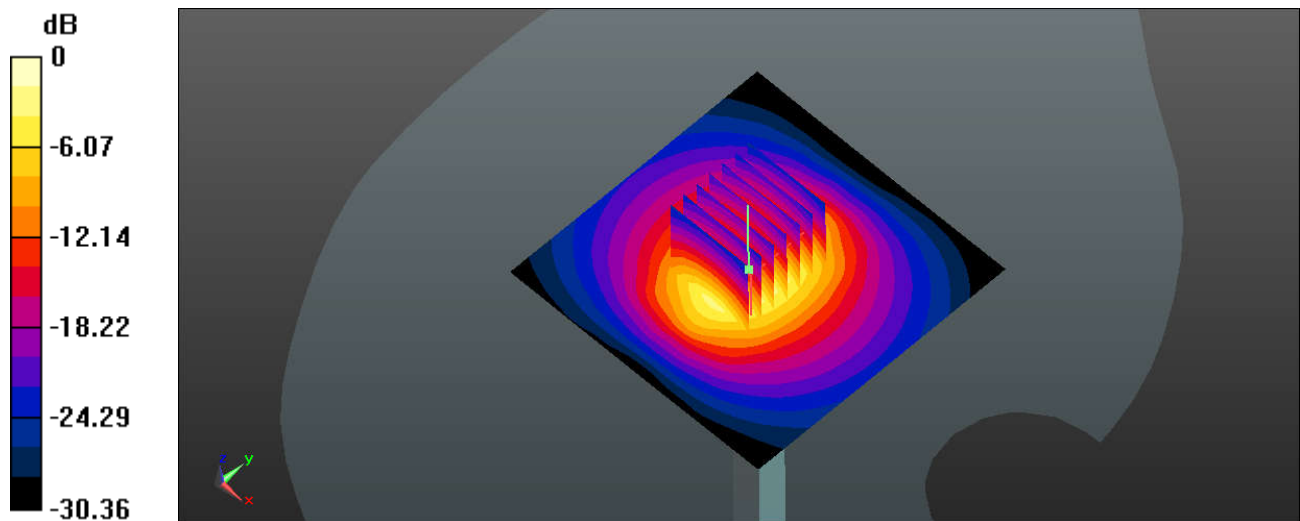

0 dB = 21.3 W/kg

System Check_Head_5250MHz

DUT: D5GHzV2-SN:1167

Communication System: UID 0, CW (0); Frequency: 5250 MHz;Duty Cycle: 1:1
 Medium: HSL_5250_201119 Medium parameters used: $f = 5250$ MHz; $\sigma = 4.595$ S/m; $\epsilon_r = 36.652$; $\rho = 1000$ kg/m³
 Ambient Temperature : 23.4 °C; Liquid Temperature : 22.8 °C

DASY5 Configuration:

- Probe: EX3DV4 - SN3826; ConvF(5.09, 5.09, 5.09); Calibrated: 2020.05.20;
- Sensor-Surface: 1.4mm (Mechanical Surface Detection)
- Electronics: DAE4 Sn1210; Calibrated: 2020.07.27
- Phantom: SAM2; Type: QD000P40CD; Serial: TP:1671
- Measurement SW: DASY52, Version 52.8 (8); SEMCAD X Version 14.6.10 (7331)

Pin=100mW/Area Scan (71x71x1): Interpolated grid: dx=1.000 mm, dy=1.000 mm
 Maximum value of SAR (interpolated) = 20.8 W/kg

Pin=100mW/Zoom Scan (7x7x7)/Cube 0: Measurement grid: dx=4mm, dy=4mm, dz=1.4mm
 Reference Value = 59.40 V/m; Power Drift = -0.11 dB
 Peak SAR (extrapolated) = 33.7 W/kg
SAR(1 g) = 8.2 W/kg; SAR(10 g) = 2.28 W/kg
 Maximum value of SAR (measured) = 20.5 W/kg

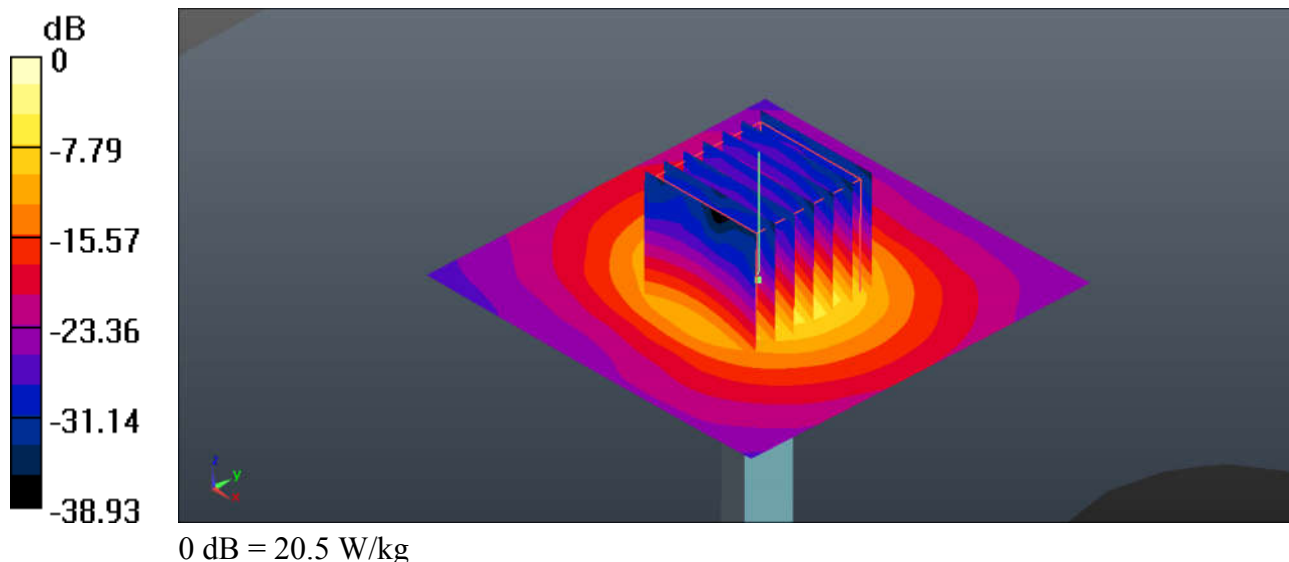

System Check_Head_5250MHz

DUT: D5GHzV2-SN:1167

Communication System: UID 0, CW (0); Frequency: 5250 MHz;Duty Cycle: 1:1
 Medium: HSL_5250_201127 Medium parameters used: $f = 5250$ MHz; $\sigma = 4.597$ S/m; $\epsilon_r = 36.241$; $\rho = 1000$ kg/m³
 Ambient Temperature : 23.5 °C; Liquid Temperature : 22.6 °C

DASY5 Configuration:

- Probe: EX3DV4 - SN3826; ConvF(5.09, 5.09, 5.09); Calibrated: 2020.05.20;
- Sensor-Surface: 1.4mm (Mechanical Surface Detection)
- Electronics: DAE4 Sn1210; Calibrated: 2020.07.27
- Phantom: SAM2; Type: QD000P40CD; Serial: TP:1671
- Measurement SW: DASY52, Version 52.8 (8); SEMCAD X Version 14.6.10 (7331)

Pin=100mW/Area Scan (71x71x1): Interpolated grid: dx=1.000 mm, dy=1.000 mm
 Maximum value of SAR (interpolated) = 18.5 W/kg

Pin=100mW/Zoom Scan (7x7x7)/Cube 0: Measurement grid: dx=4mm, dy=4mm, dz=1.4mm
 Reference Value = 44.13 V/m; Power Drift = 0.01 dB
 Peak SAR (extrapolated) = 30.6 W/kg
SAR(1 g) = 7.42 W/kg; SAR(10 g) = 2.04 W/kg
 Maximum value of SAR (measured) = 18.3 W/kg

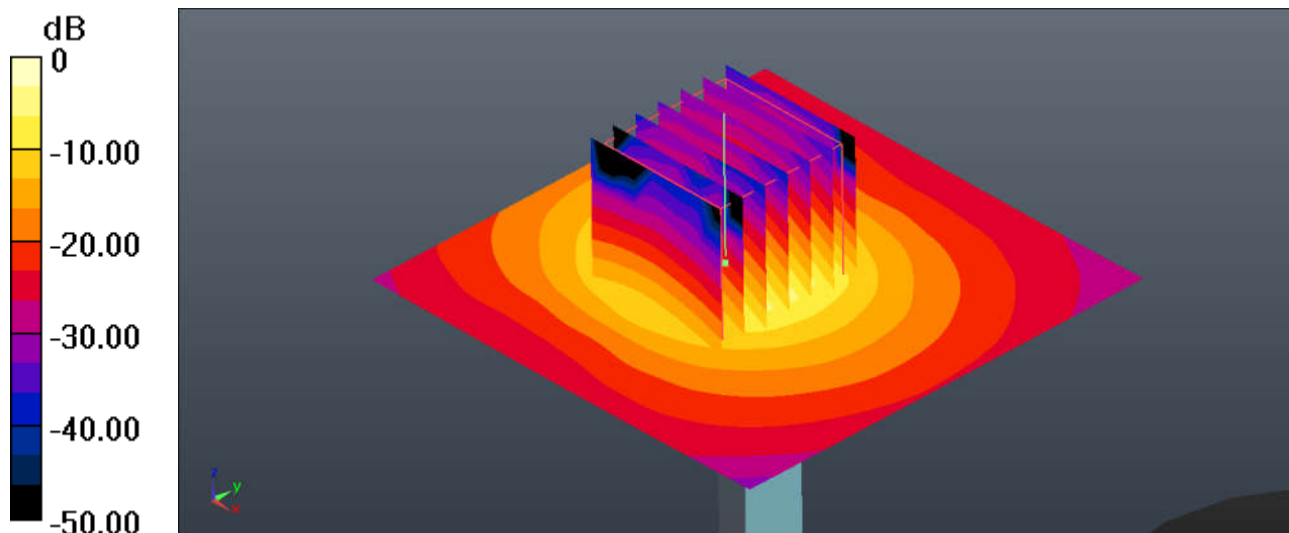

0 dB = 18.3 W/kg

System Check_Head_5600MHz

DUT: D5GHzV2-SN:1167

Communication System: UID 0, CW (0); Frequency: 5600 MHz;Duty Cycle: 1:1
Medium: HSL_5600_201120 Medium parameters used: $f = 5600$ MHz; $\sigma = 5.002$ S/m; $\epsilon_r = 36.115$; $\rho = 1000$ kg/m³
Ambient Temperature : 23.5 °C; Liquid Temperature : 22.6 °C

DASY5 Configuration:

- Probe: EX3DV4 - SN3826; ConvF(4.66, 4.66, 4.66); Calibrated: 2020.05.20;
- Sensor-Surface: 1.4mm (Mechanical Surface Detection)
- Electronics: DAE4 Sn1210; Calibrated: 2020.07.27
- Phantom: SAM2; Type: QD000P40CD; Serial: TP:1671
- Measurement SW: DASY52, Version 52.8 (8); SEMCAD X Version 14.6.10 (7331)

Pin=100mW/Area Scan (71x71x1): Interpolated grid: dx=1.000 mm, dy=1.000 mm
Maximum value of SAR (interpolated) = 24.9 W/kg

Pin=100mW/Zoom Scan (7x7x7)/Cube 0: Measurement grid: dx=4mm, dy=4mm, dz=1.4mm
Reference Value = 73.72 V/m; Power Drift = -0.12 dB
Peak SAR (extrapolated) = 43.2 W/kg
SAR(1 g) = 8.12 W/kg; SAR(10 g) = 2.22 W/kg
Maximum value of SAR (measured) = 24.1 W/kg

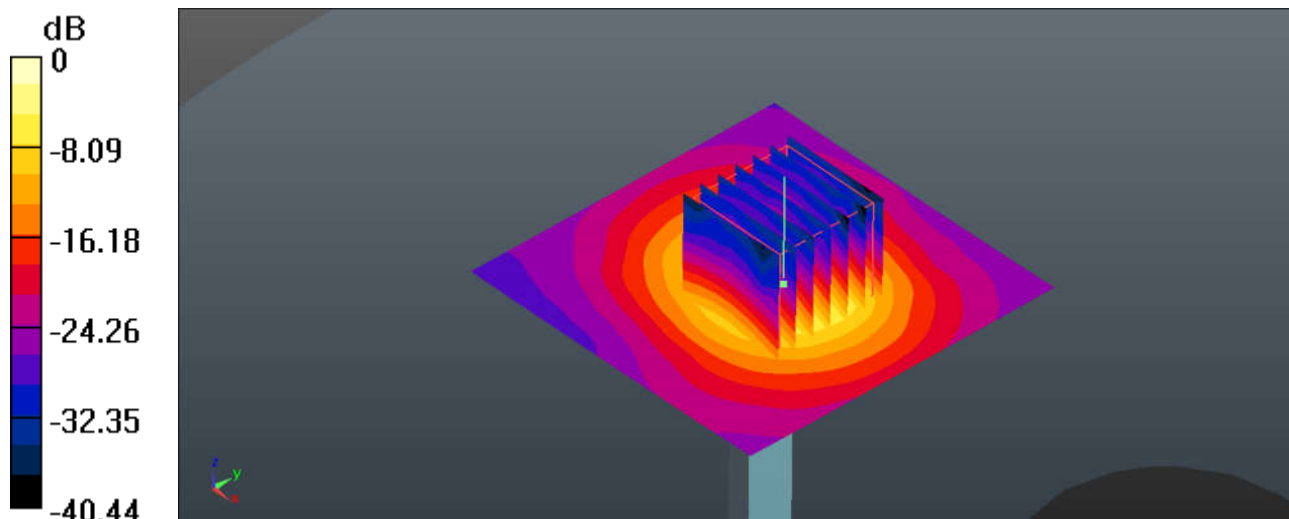

0 dB = 24.1 W/kg

System Check_Head_5600MHz

DUT: D5GHzV2-SN:1167

Communication System: UID 0, CW (0); Frequency: 5600 MHz;Duty Cycle: 1:1
Medium: HSL_5600_201130 Medium parameters used: $f = 5600$ MHz; $\sigma = 4.954$ S/m; $\epsilon_r = 35.793$; $\rho = 1000$ kg/m³
Ambient Temperature : 23.6 °C; Liquid Temperature : 22.7 °C

DASY5 Configuration:

- Probe: EX3DV4 - SN3826; ConvF(4.66, 4.66, 4.66); Calibrated: 2020.05.20;
- Sensor-Surface: 1.4mm (Mechanical Surface Detection)
- Electronics: DAE4 Sn1210; Calibrated: 2020.07.27
- Phantom: SAM2; Type: QD000P40CD; Serial: TP:1671
- Measurement SW: DASY52, Version 52.8 (8); SEMCAD X Version 14.6.10 (7331)

Pin=100mW/Area Scan (71x71x1): Interpolated grid: dx=1.000 mm, dy=1.000 mm
Maximum value of SAR (interpolated) = 20.9 W/kg

Pin=100mW/Zoom Scan (7x7x7)/Cube 0: Measurement grid: dx=4mm, dy=4mm, dz=1.4mm
Reference Value = 45.65 V/m; Power Drift = 0.13 dB
Peak SAR (extrapolated) = 36.0 W/kg
SAR(1 g) = 7.96 W/kg; SAR(10 g) = 2.16 W/kg
Maximum value of SAR (measured) = 20.2 W/kg

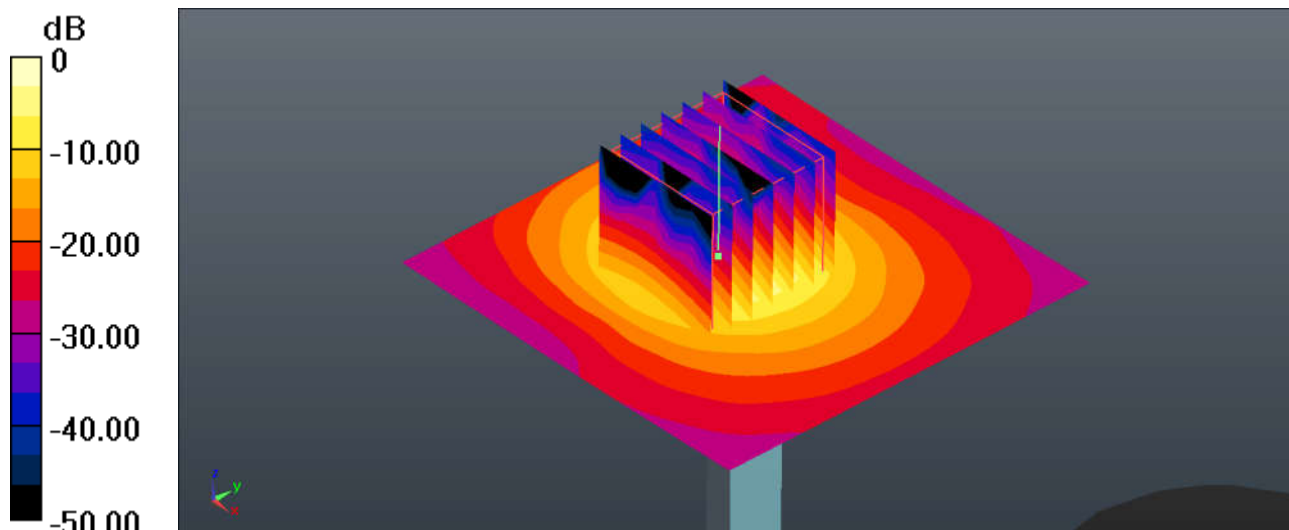

0 dB = 20.2 W/kg

System Check_Head_5750MHz

DUT: D5GHzV2-SN:1167

Communication System: UID 0, CW (0); Frequency: 5750 MHz;Duty Cycle: 1:1

Medium: HSL_5750_201122 Medium parameters used: $f = 5750$ MHz; $\sigma = 5.17$ S/m; $\epsilon_r = 35.843$; $\rho = 1000$ kg/m³

Ambient Temperature : 23.6 °C; Liquid Temperature : 22.6 °C

DASY5 Configuration:

- Probe: EX3DV4 - SN3826; ConvF(4.68, 4.68, 4.68); Calibrated: 2020.05.20;
- Sensor-Surface: 1.4mm (Mechanical Surface Detection)
- Electronics: DAE4 Sn1210; Calibrated: 2020.07.27
- Phantom: SAM2; Type: QD000P40CD; Serial: TP:1671
- Measurement SW: DASY52, Version 52.8 (8); SEMCAD X Version 14.6.10 (7331)

Pin=100mW/Area Scan (71x71x1): Interpolated grid: dx=1.000 mm, dy=1.000 mm

Maximum value of SAR (interpolated) = 5.71 W/kg

Pin=100mW/Zoom Scan (7x7x7)/Cube 0: Measurement grid: dx=4mm, dy=4mm, dz=1.4mm

Reference Value = 35.06 V/m; Power Drift = -0.11 dB

Peak SAR (extrapolated) = 10.3 W/kg

SAR(1 g) = 8.32 W/kg; SAR(10 g) = 2.35 W/kg

Maximum value of SAR (measured) = 5.70 W/kg

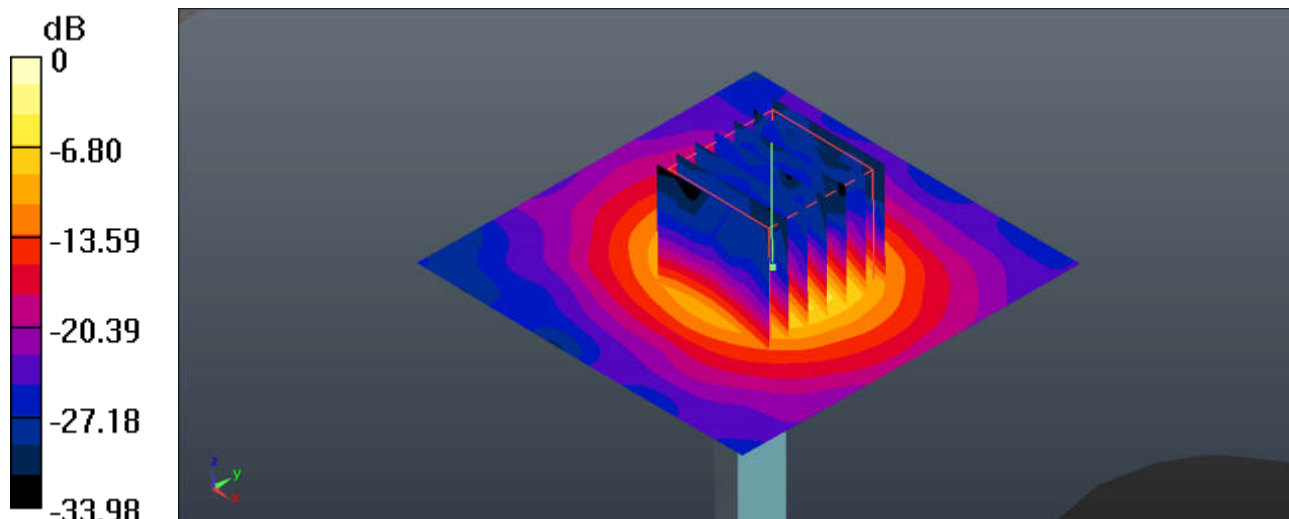

0 dB = 5.70 W/kg

System Check_Head_5750MHz

DUT: D5GHzV2-SN:1167

Communication System: UID 0, CW (0); Frequency: 5750 MHz; Duty Cycle: 1:1

Medium: HSL_5750_201202 Medium parameters used: $f = 5750$ MHz; $\sigma = 5.119$ S/m; $\epsilon_r = 35.497$; $\rho = 1000$ kg/m³

Ambient Temperature : 23.4 °C; Liquid Temperature : 22.5 °C

DASY5 Configuration:

- Probe: EX3DV4 - SN3826; ConvF(4.68, 4.68, 4.68); Calibrated: 2020.05.20;
- Sensor-Surface: 1.4mm (Mechanical Surface Detection)
- Electronics: DAE4 Sn1210; Calibrated: 2020.07.27
- Phantom: SAM2; Type: QD000P40CD; Serial: TP:1671
- Measurement SW: DASY52, Version 52.8 (8); SEMCAD X Version 14.6.10 (7331)

Pin=100mW/Area Scan (71x71x1): Interpolated grid: dx=1.000 mm, dy=1.000 mm

Maximum value of SAR (interpolated) = 18.9 W/kg

Pin=100mW/Zoom Scan (7x7x7)/Cube 0: Measurement grid: dx=4mm, dy=4mm, dz=1.4mm

Reference Value = 46.55 V/m; Power Drift = 0.11 dB

Peak SAR (extrapolated) = 34.2 W/kg

SAR(1 g) = 7.39 W/kg; SAR(10 g) = 2.03 W/kg

Maximum value of SAR (measured) = 19.1 W/kg

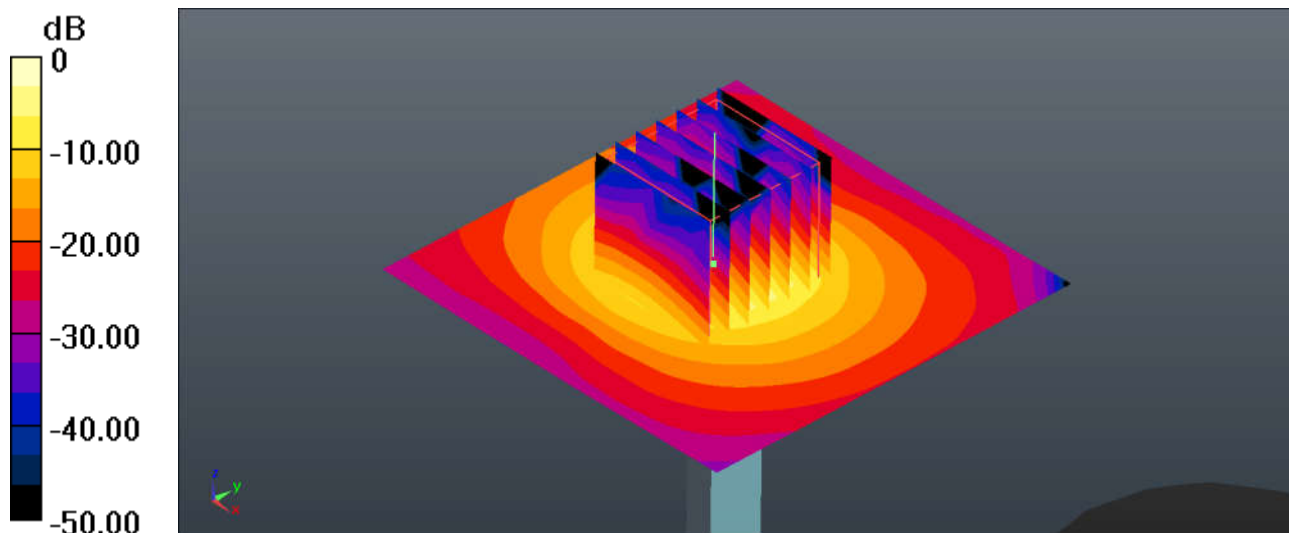

0 dB = 19.1 W/kg



Appendix B. Plots of High SAR Measurement

The plots are shown as follows.

01_GSM850_GPRS(2 Tx slots)_Right Cheek_Ch251

Communication System: UID 0, GPRS/EDGE10 (0); Frequency: 848.8 MHz; Duty Cycle: 1:4.15
Medium: HSL_835_201111 Medium parameters used: $f = 849$ MHz; $\sigma = 0.941$ S/m; $\epsilon_r = 41.625$; $\rho = 1000$ kg/m³
Ambient Temperature : 23.4 °C; Liquid Temperature : 22.4 °C

DASY5 Configuration:

- Probe: EX3DV4 - SN7576; ConvF(10.45, 10.45, 10.45); Calibrated: 2020.01.22;
- Sensor-Surface: 1.4mm (Mechanical Surface Detection)
- Electronics: DAE3 Sn528; Calibrated: 2020.03.16
- Phantom: SAM (Front) with CRP v5.0; Type: QD000P40CD; Serial: TP:1795
- Measurement SW: DASY52, Version 52.8 (8); SEMCAD X Version 14.6.10 (7331)

Ch251/Area Scan (71x81x1): Interpolated grid: dx=1.500 mm, dy=1.500 mm
Maximum value of SAR (interpolated) = 0.492 W/kg

Ch251/Zoom Scan (6x6x7)/Cube 0: Measurement grid: dx=8mm, dy=8mm, dz=5mm
Reference Value = 7.252 V/m; Power Drift = 0.05 dB
Peak SAR (extrapolated) = 0.512 W/kg
SAR(1 g) = 0.402 W/kg; SAR(10 g) = 0.308 W/kg
Maximum value of SAR (measured) = 0.477 W/kg

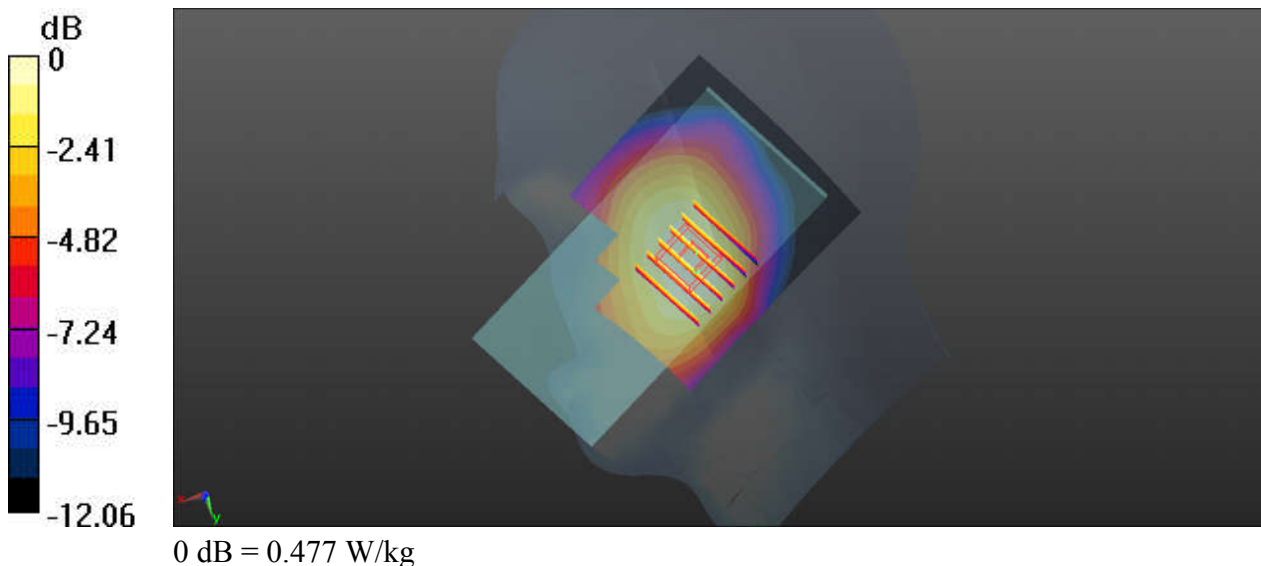

02_GSM1900_GPRS(2 Tx slots)_Left Cheek_Ch661

Communication System: UID 0, GPRS/EDGE10 (0); Frequency: 1880 MHz; Duty Cycle: 1:4.15
Medium: HSL_1900_201112 Medium parameters used: $f = 1880$ MHz; $\sigma = 1.432$ S/m; $\epsilon_r = 39.215$; $\rho = 1000$ kg/m³
Ambient Temperature : 23.4 °C; Liquid Temperature : 22.5 °C

DASY5 Configuration:

- Probe: ES3DV3 - SN3241; ConvF(5.04, 5.04, 5.04); Calibrated: 2020.05.14;
- Sensor-Surface: 3mm (Mechanical Surface Detection)
- Electronics: DAE4 Sn1437; Calibrated: 2019.11.19
- Phantom: SAM with CRP v4.0(Left); Type: QD000P40CC; Serial: TP:1576
- Measurement SW: DASY52, Version 52.8 (8); SEMCAD X Version 14.6.10 (7331)

Ch661/Area Scan (71x121x1): Interpolated grid: dx=1.500 mm, dy=1.500 mm
Maximum value of SAR (interpolated) = 0.258 W/kg

Ch661/Zoom Scan (5x5x7)/Cube 0: Measurement grid: dx=8mm, dy=8mm, dz=5mm
Reference Value = 2.897 V/m; Power Drift = 0.13 dB
Peak SAR (extrapolated) = 0.337 W/kg
SAR(1 g) = 0.216 W/kg; SAR(10 g) = 0.136 W/kg
Maximum value of SAR (measured) = 0.253 W/kg

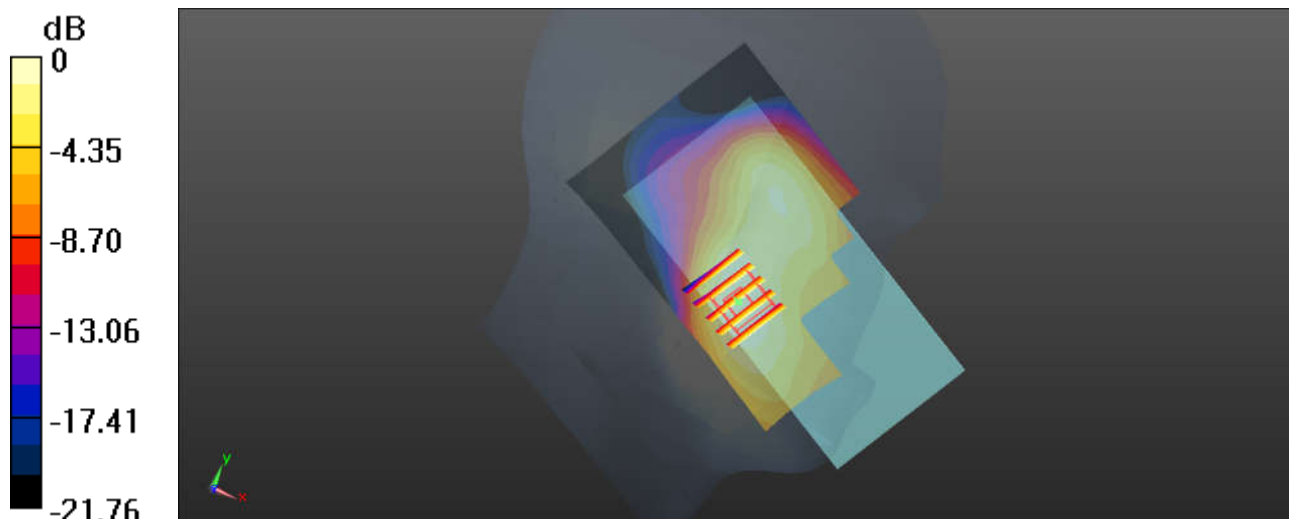

0 dB = 0.253 W/kg

03_WCDMA V_RMC 12.2Kbps_Right Cheek_Ch4182

Communication System: UID 0, UMTS (0); Frequency: 836.4 MHz; Duty Cycle: 1:1
 Medium: HSL_835_201111 Medium parameters used: $f = 836.5$ MHz; $\sigma = 0.93$ S/m; $\epsilon_r = 41.777$; $\rho = 1000$ kg/m³
 Ambient Temperature : 23.4 °C; Liquid Temperature : 22.4 °C

DASY5 Configuration:

- Probe: EX3DV4 - SN7576; ConvF(10.45, 10.45, 10.45); Calibrated: 2020.01.22;
- Sensor-Surface: 1.4mm (Mechanical Surface Detection)
- Electronics: DAE3 Sn528; Calibrated: 2020.03.16
- Phantom: SAM (Front) with CRP v5.0; Type: QD000P40CD; Serial: TP:1795
- Measurement SW: DASY52, Version 52.8 (8); SEMCAD X Version 14.6.10 (7331)

Ch4182/Area Scan (71x81x1): Interpolated grid: dx=1.500 mm, dy=1.500 mm
 Maximum value of SAR (interpolated) = 0.444 W/kg

Ch4182/Zoom Scan (6x6x7)/Cube 0: Measurement grid: dx=8mm, dy=8mm, dz=5mm
 Reference Value = 7.201 V/m; Power Drift = 0.01 dB
 Peak SAR (extrapolated) = 0.461 W/kg
SAR(1 g) = 0.366 W/kg; SAR(10 g) = 0.283 W/kg
 Maximum value of SAR (measured) = 0.427 W/kg

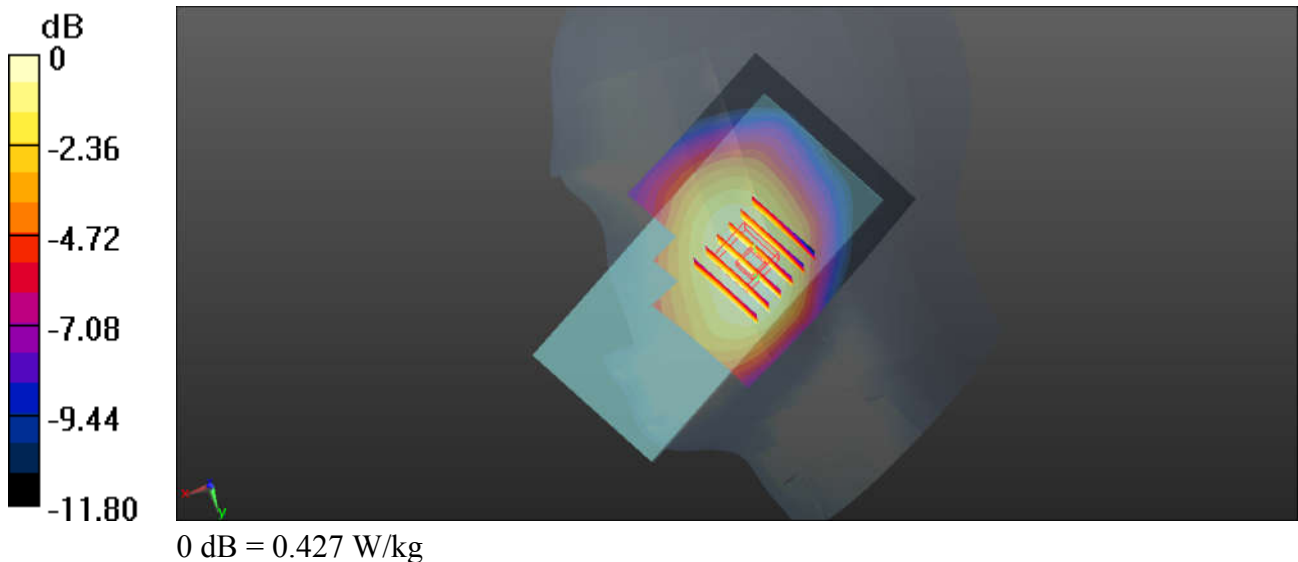

04_WCDMA IV_RMC 12.2Kbps_Right Cheek_Ch1413

Communication System: UID 0, WCDMA (0); Frequency: 1732.6 MHz; Duty Cycle: 1:1
 Medium: HSL_1750_201112 Medium parameters used: $f = 1733 \text{ MHz}$; $\sigma = 1.386 \text{ S/m}$; $\epsilon_r = 41.592$; $\rho = 1000 \text{ kg/m}^3$
 Ambient Temperature : 23.5 °C; Liquid Temperature : 22.3 °C

DASY5 Configuration:

- Probe: ES3DV3 - SN3241; ConvF(5.22, 5.22, 5.22); Calibrated: 2020.05.14;
- Sensor-Surface: 3mm (Mechanical Surface Detection)
- Electronics: DAE4 Sn1437; Calibrated: 2019.11.19
- Phantom: SAM with CRP v4.0(Left); Type: QD000P40CC; Serial: TP:1576
- Measurement SW: DASY52, Version 52.8 (8); SEMCAD X Version 14.6.10 (7331)

Ch1413/Area Scan (71x121x1): Interpolated grid: $dx=1.500 \text{ mm}$, $dy=1.500 \text{ mm}$
 Maximum value of SAR (interpolated) = 0.310 W/kg

Ch1413/Zoom Scan (5x5x7)/Cube 0: Measurement grid: $dx=8\text{mm}$, $dy=8\text{mm}$, $dz=5\text{mm}$
 Reference Value = 3.742 V/m; Power Drift = 0.18 dB
 Peak SAR (extrapolated) = 0.376 W/kg
SAR(1 g) = 0.257 W/kg; SAR(10 g) = 0.164 W/kg
 Maximum value of SAR (measured) = 0.292 W/kg

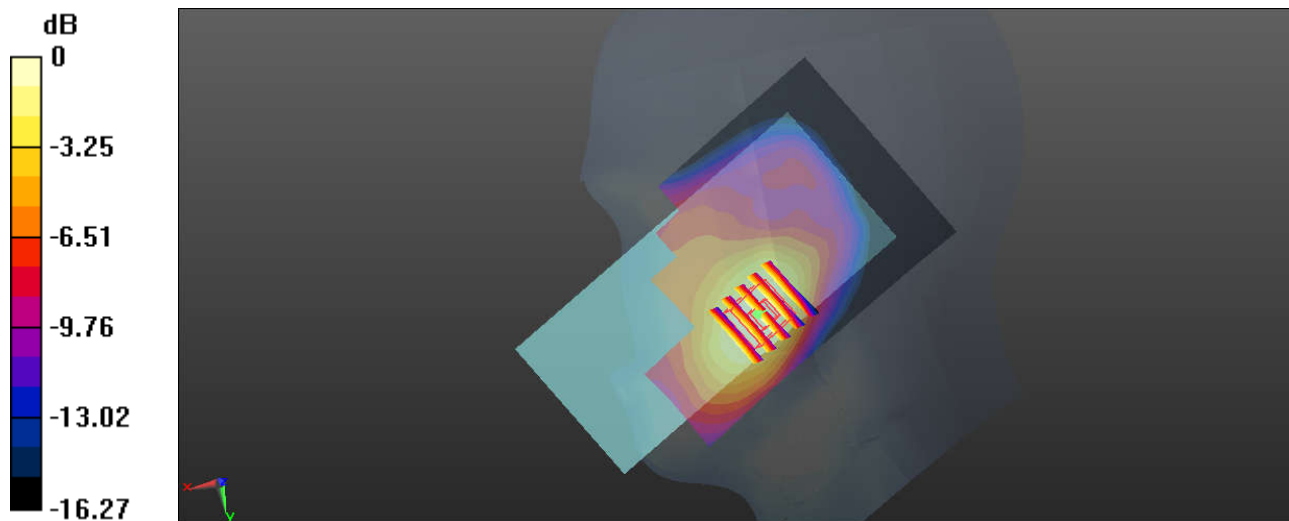

0 dB = 0.292 W/kg

05_WCDMA II_RMC 12.2Kbps_Left Cheek_Ch9538

Communication System: UID 0, WCDMA (0); Frequency: 1907.6 MHz; Duty Cycle: 1:1
 Medium: HSL_1900_201112 Medium parameters used: $f = 1908 \text{ MHz}$; $\sigma = 1.462 \text{ S/m}$; $\epsilon_r = 39.116$; $\rho = 1000 \text{ kg/m}^3$
 Ambient Temperature : 23.4 °C; Liquid Temperature : 22.5 °C

DASY5 Configuration:

- Probe: ES3DV3 - SN3241; ConvF(5.04, 5.04, 5.04); Calibrated: 2020.05.14;
- Sensor-Surface: 3mm (Mechanical Surface Detection)
- Electronics: DAE4 Sn1437; Calibrated: 2019.11.19
- Phantom: SAM with CRP v4.0(Left); Type: QD000P40CC; Serial: TP:1576
- Measurement SW: DASY52, Version 52.8 (8); SEMCAD X Version 14.6.10 (7331)

Ch9538/Area Scan (71x121x1): Interpolated grid: $dx=1.500 \text{ mm}$, $dy=1.500 \text{ mm}$
 Maximum value of SAR (interpolated) = 0.264 W/kg

Ch9538/Zoom Scan (5x5x7)/Cube 0: Measurement grid: $dx=8\text{mm}$, $dy=8\text{mm}$, $dz=5\text{mm}$
 Reference Value = 2.921 V/m; Power Drift = 0.06 dB
 Peak SAR (extrapolated) = 0.354 W/kg
SAR(1 g) = 0.228 W/kg; SAR(10 g) = 0.143 W/kg
 Maximum value of SAR (measured) = 0.269 W/kg

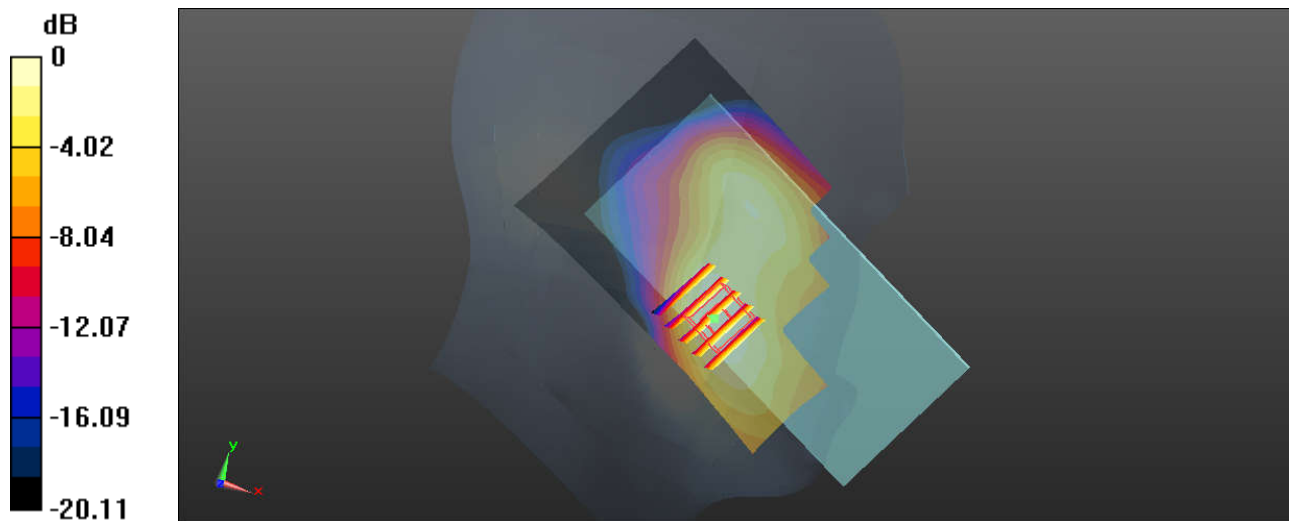

0 dB = 0.269 W/kg

06_LTE Band 5_10M_QPSK_1RB_25Offset_Right Cheek_Ch20525

Communication System: UID 0, LTE (0); Frequency: 836.5 MHz; Duty Cycle: 1:1
Medium: HSL_835_201111 Medium parameters used: $f = 836.5$ MHz; $\sigma = 0.93$ S/m; $\epsilon_r = 41.777$; $\rho = 1000$ kg/m³
Ambient Temperature : 23.4 °C; Liquid Temperature : 22.4 °C

DASY5 Configuration:

- Probe: EX3DV4 - SN7576; ConvF(10.45, 10.45, 10.45); Calibrated: 2020.01.22;
- Sensor-Surface: 1.4mm (Mechanical Surface Detection)
- Electronics: DAE3 Sn528; Calibrated: 2020.03.16
- Phantom: SAM (Front) with CRP v5.0; Type: QD000P40CD; Serial: TP:1795
- Measurement SW: DASY52, Version 52.8 (8); SEMCAD X Version 14.6.10 (7331)

Ch20525/Area Scan (71x81x1): Interpolated grid: dx=1.500 mm, dy=1.500 mm
Maximum value of SAR (interpolated) = 0.439 W/kg

Ch20525/Zoom Scan (6x5x7)/Cube 0: Measurement grid: dx=8mm, dy=8mm, dz=5mm
Reference Value = 6.853 V/m; Power Drift = -0.11 dB
Peak SAR (extrapolated) = 0.473 W/kg
SAR(1 g) = 0.371 W/kg; SAR(10 g) = 0.286 W/kg
Maximum value of SAR (measured) = 0.436 W/kg

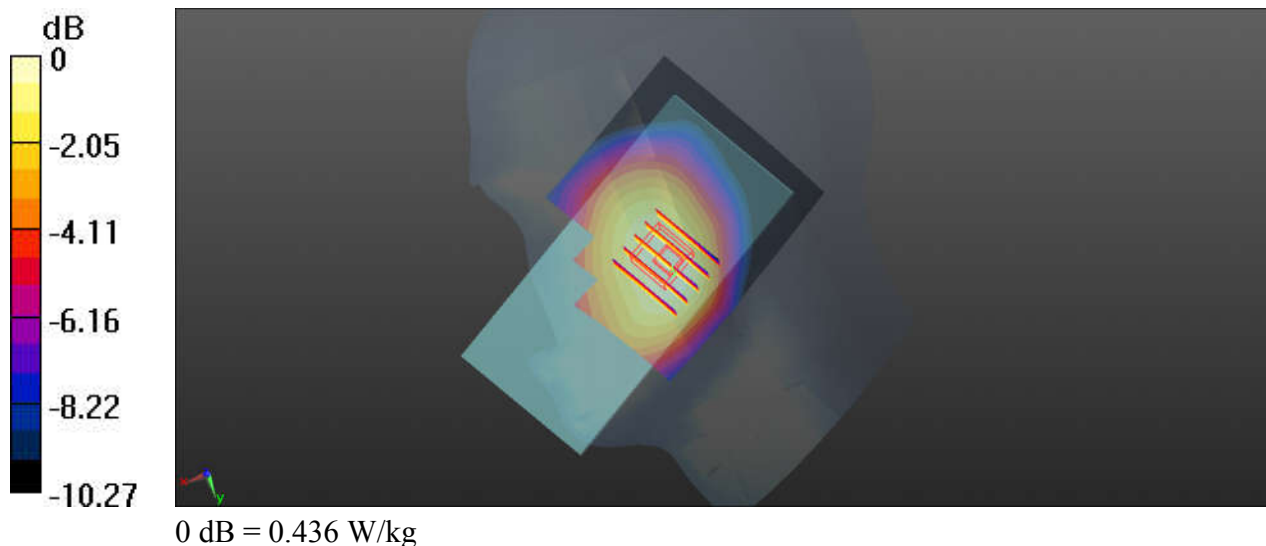

07_LTE Band 66_20M_QPSK_1RB_49Offset_Right Cheek_Ch132322

Communication System: UID 0, LTE (0); Frequency: 1745 MHz; Duty Cycle: 1:1
Medium: HSL_1750_201112 Medium parameters used: $f = 1745$ MHz; $\sigma = 1.401$ S/m; $\epsilon_r = 41.539$; $\rho = 1000$ kg/m³
Ambient Temperature : 23.5 °C; Liquid Temperature : 22.3 °C

DASY5 Configuration:

- Probe: ES3DV3 - SN3241; ConvF(5.22, 5.22, 5.22); Calibrated: 2020.05.14;
- Sensor-Surface: 3mm (Mechanical Surface Detection)
- Electronics: DAE4 Sn1437; Calibrated: 2019.11.19
- Phantom: SAM with CRP v4.0(Left); Type: QD000P40CC; Serial: TP:1576
- Measurement SW: DASY52, Version 52.8 (8); SEMCAD X Version 14.6.10 (7331)

Ch132322/Area Scan (71x121x1): Interpolated grid: dx=1.500 mm, dy=1.500 mm
Maximum value of SAR (interpolated) = 0.288 W/kg

Ch132322/Zoom Scan (5x5x7)/Cube 0: Measurement grid: dx=8mm, dy=8mm, dz=5mm
Reference Value = 3.495 V/m; Power Drift = 0.06 dB
Peak SAR (extrapolated) = 0.342 W/kg
SAR(1 g) = 0.236 W/kg; SAR(10 g) = 0.152 W/kg
Maximum value of SAR (measured) = 0.273 W/kg

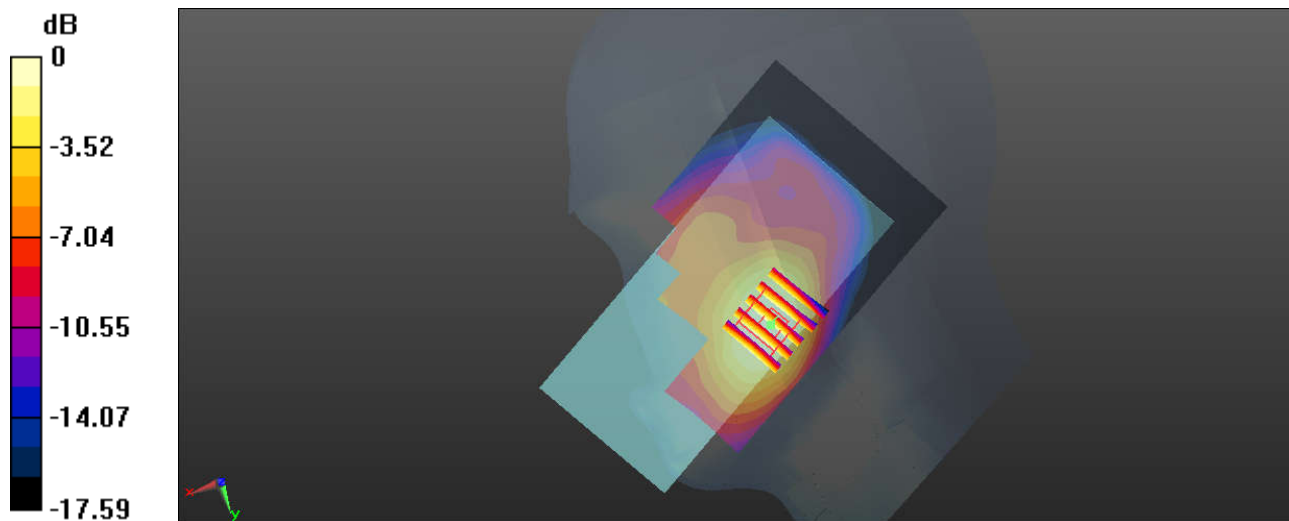

0 dB = 0.273 W/kg

08_LTE Band 2_20M_QPSK_1RB_49Offset_Left Cheek_Ch18900

Communication System: UID 0, LTE (0); Frequency: 1880 MHz; Duty Cycle: 1:1
Medium: HSL_1900_201112 Medium parameters used: $f = 1880$ MHz; $\sigma = 1.432$ S/m; $\epsilon_r = 39.215$; $\rho = 1000$ kg/m³
Ambient Temperature : 23.4 °C; Liquid Temperature : 22.5 °C

DASY5 Configuration:

- Probe: ES3DV3 - SN3241; ConvF(5.04, 5.04, 5.04); Calibrated: 2020.05.14;
- Sensor-Surface: 3mm (Mechanical Surface Detection)
- Electronics: DAE4 Sn1437; Calibrated: 2019.11.19
- Phantom: SAM with CRP v4.0(Left); Type: QD000P40CC; Serial: TP:1576
- Measurement SW: DASY52, Version 52.8 (8); SEMCAD X Version 14.6.10 (7331)

Ch18900/Area Scan (71x121x1): Interpolated grid: dx=1.500 mm, dy=1.500 mm
Maximum value of SAR (interpolated) = 0.263 W/kg

Ch18900/Zoom Scan (5x5x7)/Cube 0: Measurement grid: dx=8mm, dy=8mm, dz=5mm
Reference Value = 2.481 V/m; Power Drift = 0.02 dB
Peak SAR (extrapolated) = 0.339 W/kg
SAR(1 g) = 0.218 W/kg; SAR(10 g) = 0.137 W/kg
Maximum value of SAR (measured) = 0.257 W/kg

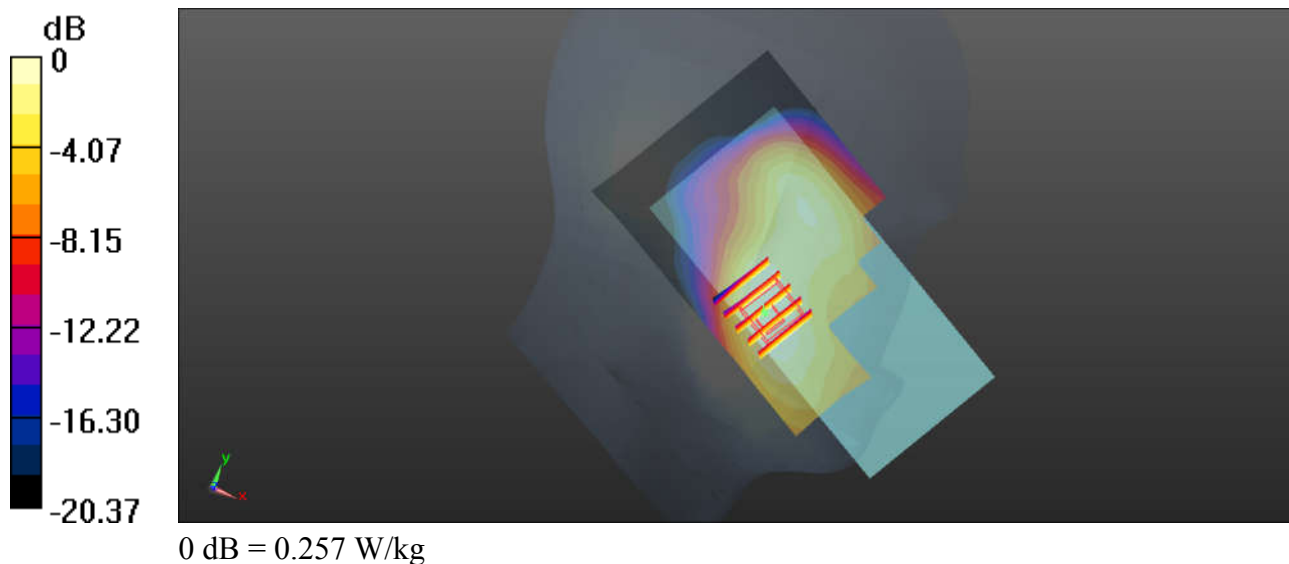

09_LTE Band 7_20M_QPSK_1RB_49Offset_Left Cheek_Ch21100

Communication System: UID 0, LTE (0); Frequency: 2535 MHz; Duty Cycle: 1:1
 Medium: HSL_2600_201113 Medium parameters used: $f = 2535 \text{ MHz}$; $\sigma = 1.978 \text{ S/m}$; $\epsilon_r = 38.292$; $\rho = 1000 \text{ kg/m}^3$
 Ambient Temperature : 23.2 °C ; Liquid Temperature : 22.3 °C

DASY5 Configuration:

- Probe: ES3DV3 - SN3241; ConvF(4.42, 4.42, 4.42); Calibrated: 2020.05.14;
- Sensor-Surface: 3mm (Mechanical Surface Detection)
- Electronics: DAE4 Sn1437; Calibrated: 2019.11.19
- Phantom: SAM with CRP v4.0(Left); Type: QD000P40CC; Serial: TP:1576
- Measurement SW: DASY52, Version 52.8 (8); SEMCAD X Version 14.6.10 (7331)

Ch21100/Area Scan (91x91x1): Interpolated grid: $dx=1.200 \text{ mm}$, $dy=1.200 \text{ mm}$
 Maximum value of SAR (interpolated) = 0.306 W/kg

Ch21100/Zoom Scan (7x7x7)/Cube 0: Measurement grid: $dx=5\text{mm}$, $dy=5\text{mm}$, $dz=5\text{mm}$
 Reference Value = 2.605 V/m; Power Drift = 0.08 dB
 Peak SAR (extrapolated) = 0.410 W/kg
SAR(1 g) = 0.218 W/kg; SAR(10 g) = 0.110 W/kg
 Maximum value of SAR (measured) = 0.280 W/kg

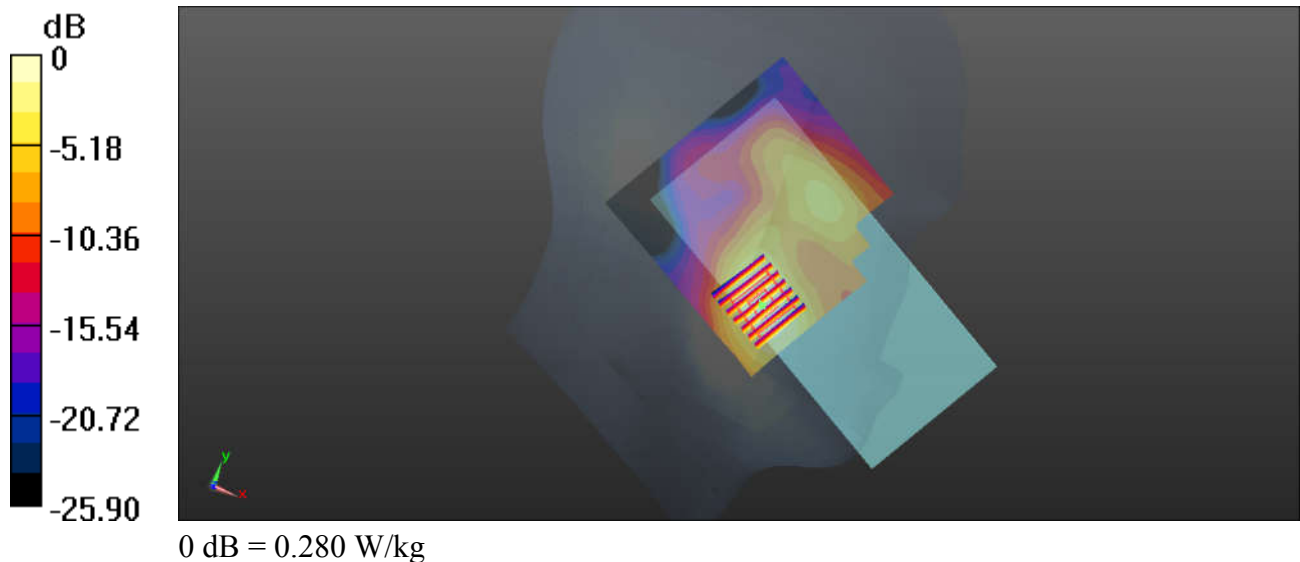

10_WLAN2.4GHz_802.11b 1Mbps_Left Cheek_Ch11

Communication System: UID 0, WIFI (0); Frequency: 2462 MHz; Duty Cycle: 1:1.007
Medium: HSL_2450_201118 Medium parameters used: $f = 2462$ MHz; $\sigma = 1.884$ S/m; $\epsilon_r = 38.072$; $\rho = 1000$ kg/m³
Ambient Temperature : 23.4 °C; Liquid Temperature : 22.7 °C

DASY5 Configuration:

- Probe: EX3DV4 - SN3826; ConvF(7.12, 7.12, 7.12); Calibrated: 2020.05.20;
- Sensor-Surface: 1.4mm (Mechanical Surface Detection)
- Electronics: DAE4 Sn1210; Calibrated: 2020.07.27
- Phantom: SAM2; Type: QD000P40CD; Serial: TP:1671
- Measurement SW: DASY52, Version 52.8 (8); SEMCAD X Version 14.6.10 (7331)

Ch11/Area Scan (91x91x1): Interpolated grid: dx=1.200 mm, dy=1.200 mm
Maximum value of SAR (interpolated) = 0.770 W/kg

Ch11/Zoom Scan (7x7x7)/Cube 0: Measurement grid: dx=5mm, dy=5mm, dz=5mm
Reference Value = 10.70 V/m; Power Drift = -0.11 dB
Peak SAR (extrapolated) = 1.07 W/kg
SAR(1 g) = 0.461 W/kg; SAR(10 g) = 0.223 W/kg
Maximum value of SAR (measured) = 0.705 W/kg

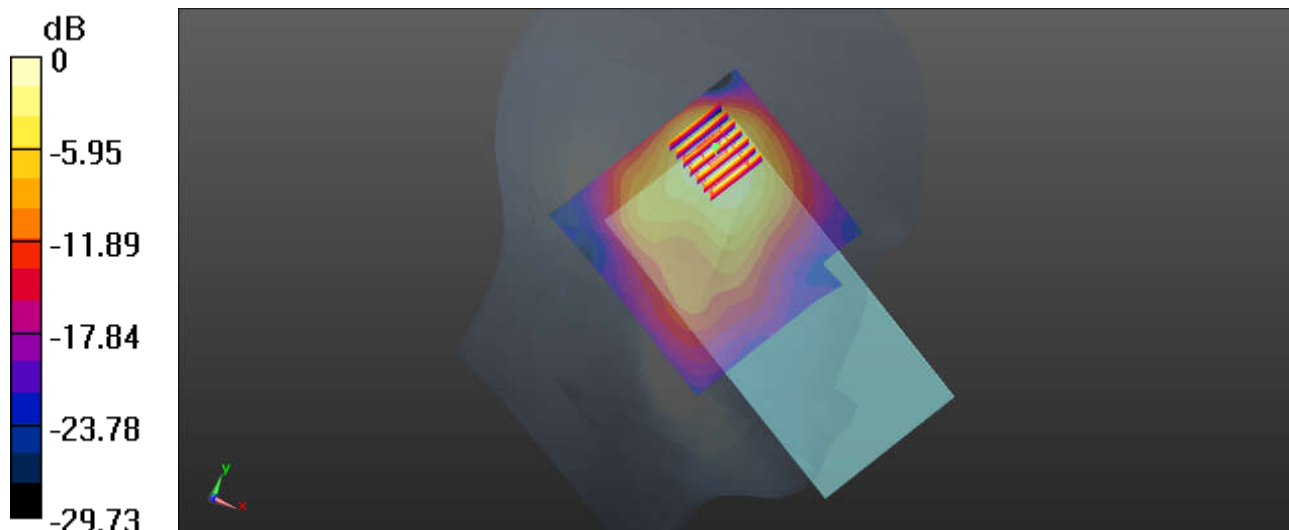

0 dB = 0.705 W/kg

11_WLAN5GHz_802.11n-HT40 MCS0_Left Cheek_Ch54

Communication System: UID 0, WIFI (0); Frequency: 5270 MHz; Duty Cycle: 1:1.038
Medium: HSL_5250_201119 Medium parameters used: $f = 5270$ MHz; $\sigma = 4.631$ S/m; $\epsilon_r = 36.171$; $\rho = 1000$ kg/m³
Ambient Temperature : 23.4 °C; Liquid Temperature : 22.8 °C

DASY5 Configuration:

- Probe: EX3DV4 - SN3826; ConvF(5.09, 5.09, 5.09); Calibrated: 2020.05.20;
- Sensor-Surface: 1.4mm (Mechanical Surface Detection)
- Electronics: DAE4 Sn1210; Calibrated: 2020.07.27
- Phantom: SAM2; Type: QD000P40CD; Serial: TP:1671
- Measurement SW: DASY52, Version 52.8 (8); SEMCAD X Version 14.6.10 (7331)

Ch54/Area Scan (101x81x1): Interpolated grid: dx=1.000 mm, dy=1.000 mm
Maximum value of SAR (interpolated) = 1.27 W/kg

Ch54/Zoom Scan (7x7x7)/Cube 0: Measurement grid: dx=4mm, dy=4mm, dz=1.4mm
Reference Value = 5.442 V/m; Power Drift = 0.16 dB
Peak SAR (extrapolated) = 2.35 W/kg
SAR(1 g) = 0.568 W/kg; SAR(10 g) = 0.172 W/kg
Maximum value of SAR (measured) = 1.41 W/kg

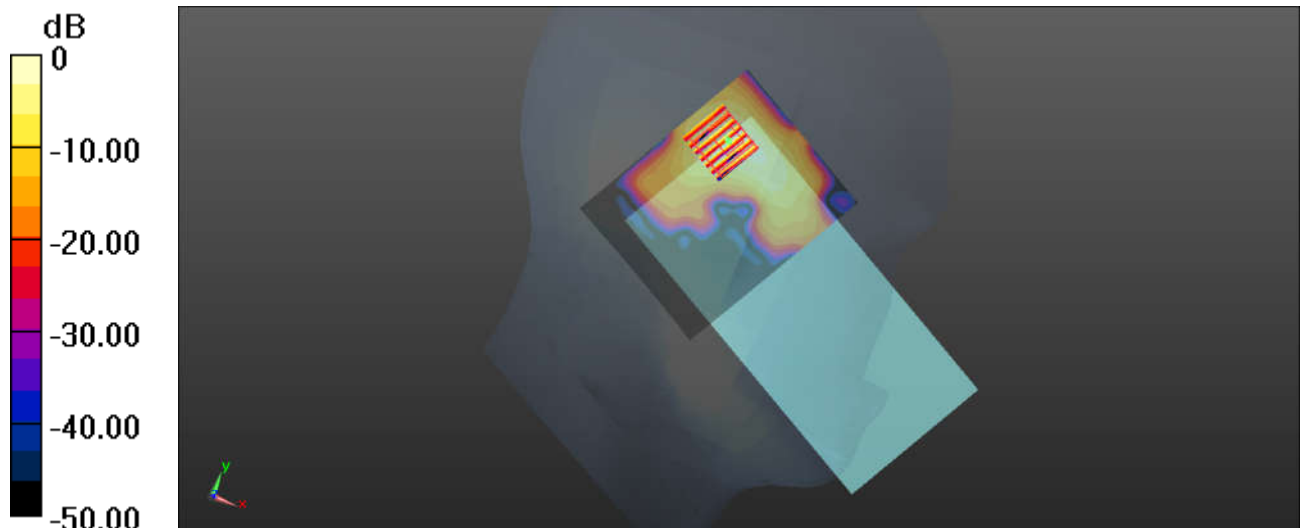

0 dB = 1.41 W/kg

12_WLAN5GHz_802.11ac-VHT80 MCS0_Left Cheek_Ch138

Communication System: UID 0, WIFI (0); Frequency: 5690 MHz; Duty Cycle: 1:1.078
Medium: HSL_5600_201120 Medium parameters used: $f = 5690$ MHz; $\sigma = 5.08$ S/m; $\epsilon_r = 35.672$; $\rho = 1000$ kg/m³
Ambient Temperature : 23.5 °C; Liquid Temperature : 22.6 °C

DASY5 Configuration:

- Probe: EX3DV4 - SN3826; ConvF(4.66, 4.66, 4.66); Calibrated: 2020.05.20;
- Sensor-Surface: 1.4mm (Mechanical Surface Detection)
- Electronics: DAE4 Sn1210; Calibrated: 2020.07.27
- Phantom: SAM2; Type: QD000P40CD; Serial: TP:1671
- Measurement SW: DASY52, Version 52.8 (8); SEMCAD X Version 14.6.10 (7331)

Ch138/Area Scan (101x91x1): Interpolated grid: dx=1.000 mm, dy=1.000 mm
Maximum value of SAR (interpolated) = 2.00 W/kg

Ch138/Zoom Scan (7x7x7)/Cube 0: Measurement grid: dx=4mm, dy=4mm, dz=1.4mm
Reference Value = 12.62 V/m; Power Drift = -0.09 dB
Peak SAR (extrapolated) = 3.53 W/kg
SAR(1 g) = 0.724 W/kg; SAR(10 g) = 0.231 W/kg
Maximum value of SAR (measured) = 1.94 W/kg

Ch138/Zoom Scan (7x7x7)/Cube 1: Measurement grid: dx=4mm, dy=4mm, dz=1.4mm
Reference Value = 12.62 V/m; Power Drift = -0.09 dB
Peak SAR (extrapolated) = 2.50 W/kg
SAR(1 g) = 0.581 W/kg; SAR(10 g) = 0.187 W/kg
Maximum value of SAR (measured) = 1.40 W/kg

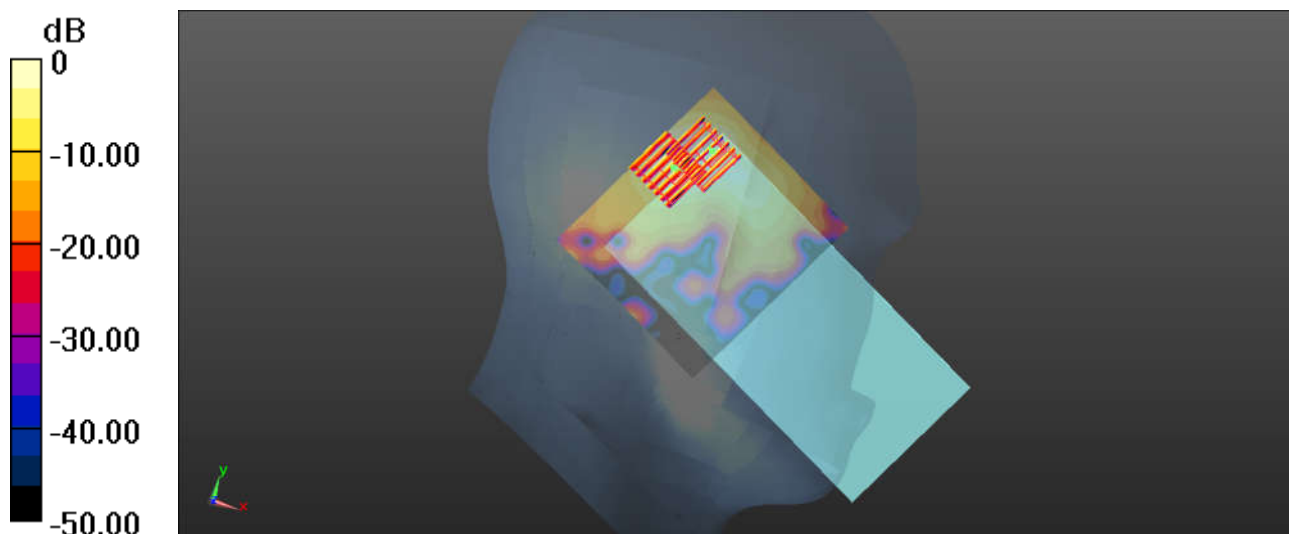

0 dB = 1.40 W/kg