

### 07\_LTE Band 2\_20M\_QPSK\_1RB\_49Offset\_Left Cheek\_Ch18900

Communication System: UID 0, LTE (0); Frequency: 1880 MHz; Duty Cycle: 1:1  
Medium: HSL\_1900\_201113 Medium parameters used:  $f = 1880$  MHz;  $\sigma = 1.436$  S/m;  $\epsilon_r = 39.231$ ;  
 $\rho = 1000$  kg/m<sup>3</sup>  
Ambient Temperature : 23.5 °C; Liquid Temperature : 22.6 °C

#### DASY5 Configuration:

- Probe: EX3DV4 - SN7576; ConvF(8.58, 8.58, 8.58); Calibrated: 2020.01.22
- Sensor-Surface: 1.4mm (Mechanical Surface Detection)
- Electronics: DAE3 Sn528; Calibrated: 2020.03.16
- Phantom: SAM (Front) with CRP v5.0; Type: QD000P40CD; Serial: TP:1795
- Measurement SW: DASY52, Version 52.8 (8); SEMCAD X Version 14.6.13 (7474)

**Ch18900/Area Scan (71x81x1):** Interpolated grid: dx=1.500 mm, dy=1.500 mm  
Maximum value of SAR (interpolated) = 0.313 W/kg

**Ch18900/Zoom Scan (6x5x7)/Cube 0:** Measurement grid: dx=8mm, dy=8mm, dz=5mm  
Reference Value = 3.418 V/m; Power Drift = -0.02 dB  
Peak SAR (extrapolated) = 0.365 W/kg  
**SAR(1 g) = 0.221 W/kg; SAR(10 g) = 0.138 W/kg**  
Maximum value of SAR (measured) = 0.308 W/kg

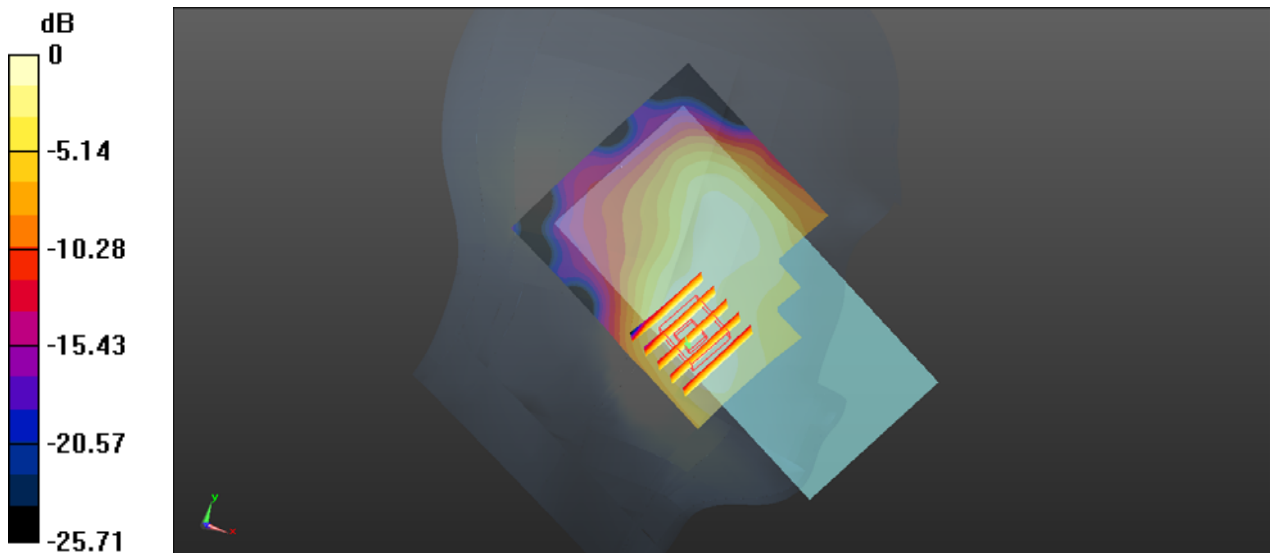

0 dB = 0.308 W/kg

### 08\_LTE Band 7\_20M\_QPSK\_1RB\_49Offset\_Left Cheek\_Ch21100

Communication System: UID 0, LTE (0); Frequency: 2535 MHz; Duty Cycle: 1:1  
Medium: HSL\_2600\_201114 Medium parameters used:  $f = 2535$  MHz;  $\sigma = 1.98$  S/m;  $\epsilon_r = 37.872$ ;  $\rho = 1000$  kg/m<sup>3</sup>  
Ambient Temperature : 23.5 °C; Liquid Temperature : 22.4 °C

#### DASY5 Configuration:

- Probe: EX3DV4 - SN7576; ConvF(7.47, 7.47, 7.47); Calibrated: 2020.01.22
- Sensor-Surface: 1.4mm (Mechanical Surface Detection)
- Electronics: DAE3 Sn528; Calibrated: 2020.03.16
- Phantom: SAM (Front) with CRP v5.0; Type: QD000P40CD; Serial: TP:1795
- Measurement SW: DASY52, Version 52.8 (8); SEMCAD X Version 14.6.13 (7474)

**Ch21100/Area Scan (81x91x1):** Interpolated grid: dx=1.200 mm, dy=1.200 mm  
Maximum value of SAR (interpolated) = 0.251 W/kg

**Ch21100/Zoom Scan (7x7x7)/Cube 0:** Measurement grid: dx=5mm, dy=5mm, dz=5mm  
Reference Value = 2.649 V/m; Power Drift = 0.11 dB  
Peak SAR (extrapolated) = 0.309 W/kg  
**SAR(1 g) = 0.196 W/kg; SAR(10 g) = 0.088 W/kg**  
Maximum value of SAR (measured) = 0.256 W/kg

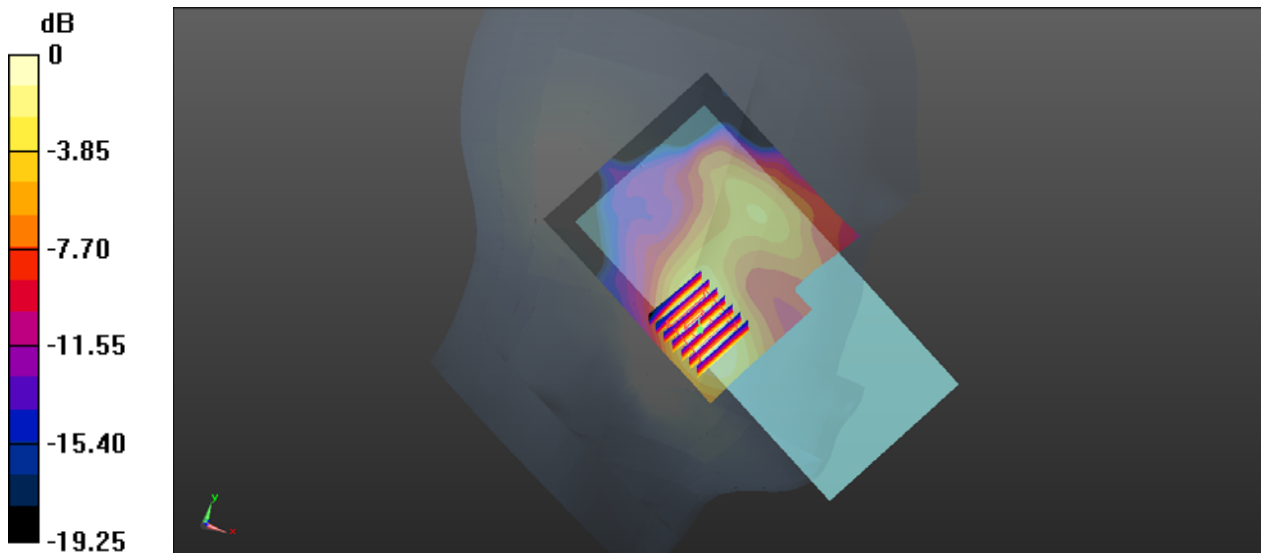

0 dB = 0.256 W/kg

### 09\_LTE Band 41\_20M\_QPSK\_1RB\_49Offset\_Left Cheek\_Ch40185

Communication System: UID 0, LTE (0); Frequency: 2549.5 MHz; Duty Cycle: 1:1.59  
Medium: HSL\_2600\_201114 Medium parameters used:  $f = 2549.5$  MHz;  $\sigma = 1.996$  S/m;  $\epsilon_r = 37.833$ ;  $\rho = 1000$  kg/m<sup>3</sup>  
Ambient Temperature : 23.5 °C; Liquid Temperature : 22.4 °C

#### DASY5 Configuration:

- Probe: EX3DV4 - SN7576; ConvF(7.47, 7.47, 7.47); Calibrated: 2020.01.22
- Sensor-Surface: 1.4mm (Mechanical Surface Detection)
- Electronics: DAE3 Sn528; Calibrated: 2020.03.16
- Phantom: SAM (Front) with CRP v5.0; Type: QD000P40CD; Serial: TP:1795
- Measurement SW: DASY52, Version 52.8 (8); SEMCAD X Version 14.6.13 (7474)

**Ch40185/Area Scan (81x91x1):** Interpolated grid: dx=1.200 mm, dy=1.200 mm  
Maximum value of SAR (interpolated) = 0.225 W/kg

**Ch40185/Zoom Scan (7x7x7)/Cube 0:** Measurement grid: dx=5mm, dy=5mm, dz=5mm  
Reference Value = 2.315 V/m; Power Drift = 0.14 dB  
Peak SAR (extrapolated) = 0.264 W/kg  
**SAR(1 g) = 0.140 W/kg; SAR(10 g) = 0.075 W/kg**  
Maximum value of SAR (measured) = 0.217 W/kg

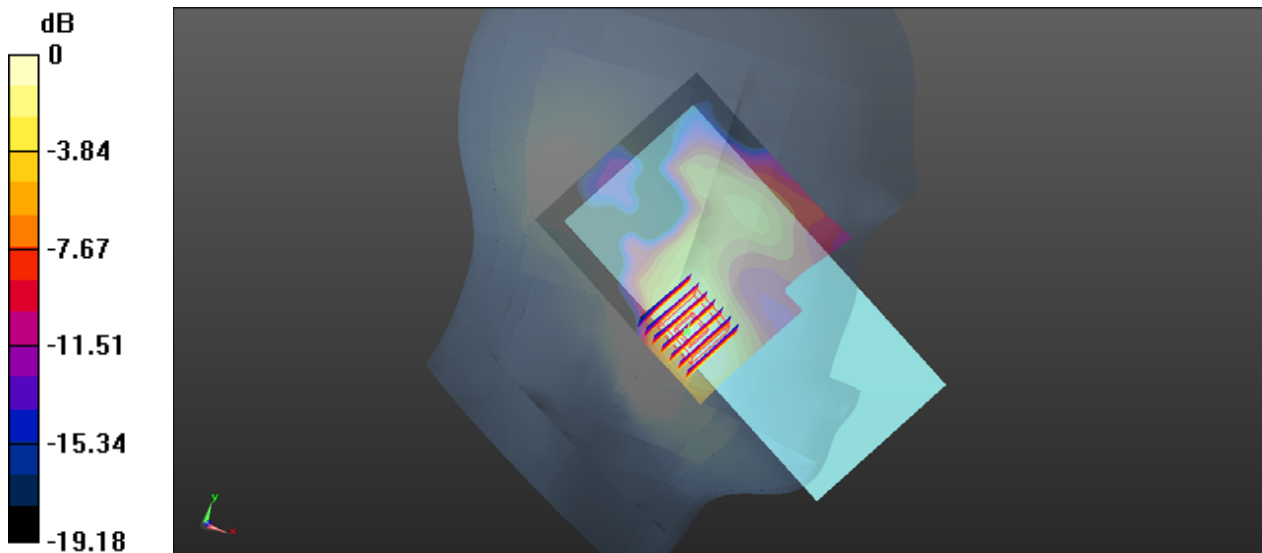

0 dB = 0.217 W/kg

### 10\_WLAN2.4GHz\_802.11b 1Mbps\_Left Cheek\_Ch6

Communication System: UID 0, WIFI (0); Frequency: 2437 MHz; Duty Cycle: 1:1.007  
Medium: HSL\_2450\_201114 Medium parameters used:  $f = 2437$  MHz;  $\sigma = 1.851$  S/m;  $\epsilon_r = 37.563$ ;  
 $\rho = 1000$  kg/m<sup>3</sup>  
Ambient Temperature : 23.4 °C; Liquid Temperature : 22.7 °C

#### DASY5 Configuration:

- Probe: EX3DV4 - SN7576; ConvF(7.76, 7.76, 7.76); Calibrated: 2020.01.22
- Sensor-Surface: 1.4mm (Mechanical Surface Detection)
- Electronics: DAE3 Sn528; Calibrated: 2020.03.16
- Phantom: SAM (Front) with CRP v5.0; Type: QD000P40CD; Serial: TP:1795
- Measurement SW: DASY52, Version 52.8 (8); SEMCAD X Version 14.6.13 (7474)

**Ch6/Area Scan (81x81x1):** Interpolated grid: dx=1.200 mm, dy=1.200 mm  
Maximum value of SAR (interpolated) = 1.39 W/kg

**Ch6/Zoom Scan (7x7x7)/Cube 0:** Measurement grid: dx=5mm, dy=5mm, dz=5mm  
Reference Value = 15.36 V/m; Power Drift = 0.10 dB  
Peak SAR (extrapolated) = 1.78 W/kg  
**SAR(1 g) = 0.802 W/kg; SAR(10 g) = 0.399 W/kg**  
Maximum value of SAR (measured) = 1.33 W/kg

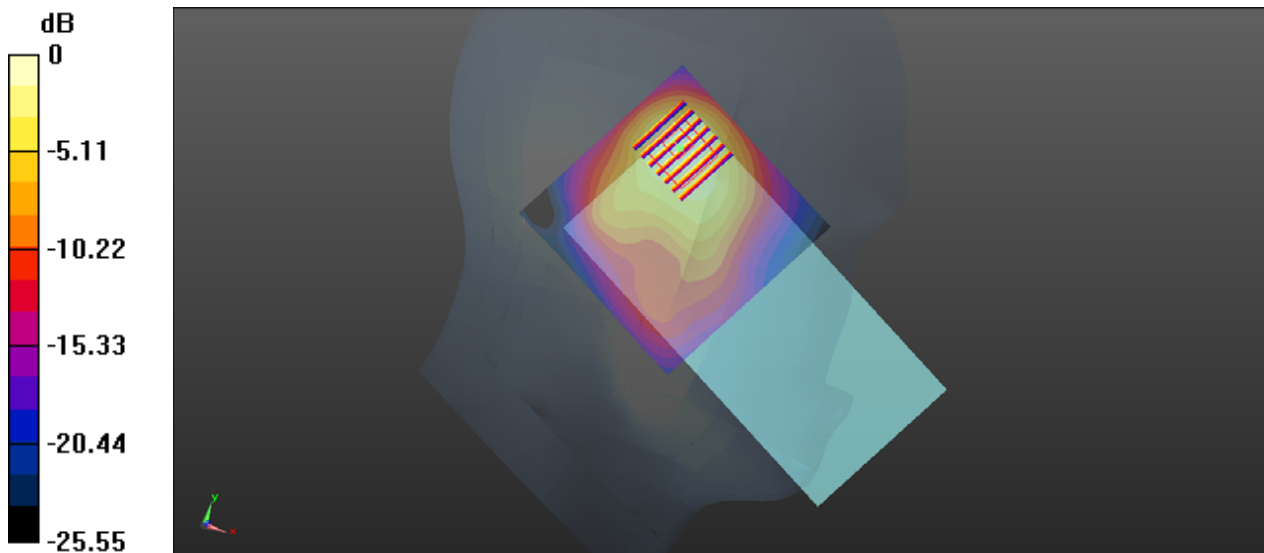

0 dB = 1.33 W/kg

## 11\_WLAN5GHz\_802.11n-HT40 MCS0\_Left Tilted\_Ch54

Communication System: UID 0, WIFI (0); Frequency: 5270 MHz; Duty Cycle: 1:1.038  
Medium: HSL\_5250\_201118 Medium parameters used:  $f = 5270$  MHz;  $\sigma = 4.639$  S/m;  $\epsilon_r = 36.713$ ;  
 $\rho = 1000$  kg/m<sup>3</sup>  
Ambient Temperature : 23.3 °C; Liquid Temperature : 22.5 °C

### DASY5 Configuration:

- Probe: EX3DV4 - SN7577; ConvF(5.4, 5.4, 5.4); Calibrated: 2020.09.30
- Sensor-Surface: 1.4mm (Mechanical Surface Detection)
- Electronics: DAE4 Sn715; Calibrated: 2020.07.27
- Phantom: Twin-SAM1(P1aP2a20); Type: QD 000 P40 CD; Serial: TP:1670
- Measurement SW: DASY52, Version 52.10 (3); SEMCAD X Version 14.6.13 (7474)

**Ch54/Area Scan (91x101x1):** Interpolated grid: dx=1.000 mm, dy=1.000 mm  
Maximum value of SAR (interpolated) = 1.34 W/kg

**Ch54/Zoom Scan (7x7x7)/Cube 0:** Measurement grid: dx=4mm, dy=4mm, dz=1.4mm  
Reference Value = 6.806 V/m; Power Drift = 0.09 dB  
Peak SAR (extrapolated) = 2.17 W/kg  
**SAR(1 g) = 0.531 W/kg; SAR(10 g) = 0.166 W/kg**  
Maximum value of SAR (measured) = 1.32 W/kg

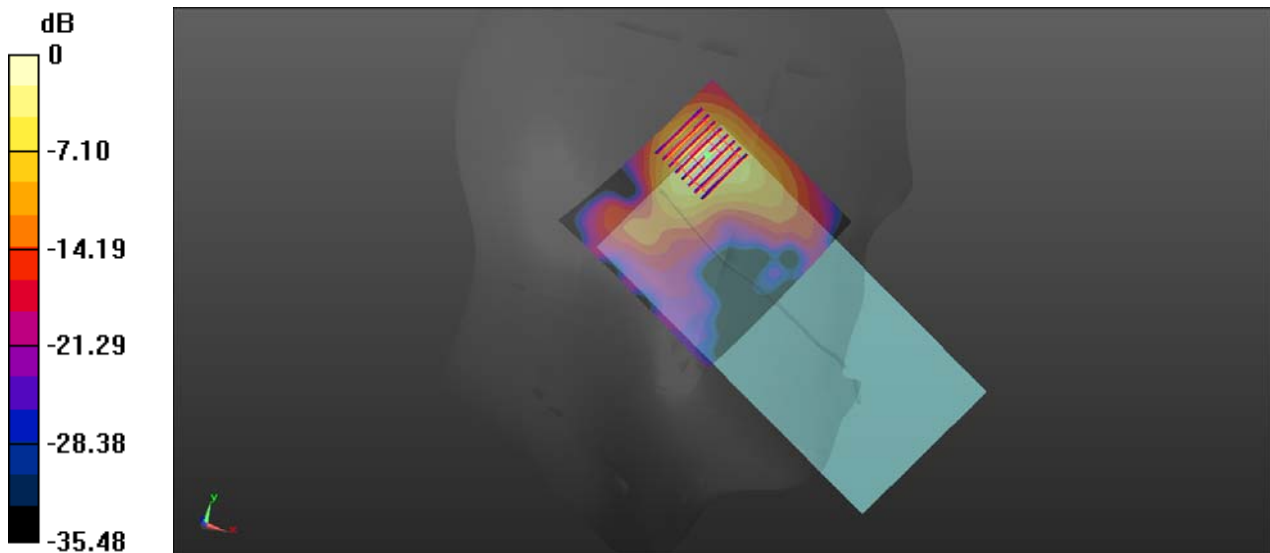

0 dB = 1.32 W/kg

## 12\_WLAN5GHz\_802.11ac-VHT80 MCS0\_Left Tilted\_Ch138

Communication System: UID 0, WIFI (0); Frequency: 5690 MHz; Duty Cycle: 1:1.078  
Medium: HSL\_5750\_201120 Medium parameters used:  $f = 5690$  MHz;  $\sigma = 4.945$  S/m;  $\epsilon_r = 35.64$ ;  $\rho = 1000$  kg/m<sup>3</sup>  
Ambient Temperature : 23.5 °C; Liquid Temperature : 22.5 °C

### DASY5 Configuration:

- Probe: EX3DV4 - SN7577; ConvF(5.02, 5.02, 5.02); Calibrated: 2020.09.30
- Sensor-Surface: 1.4mm (Mechanical Surface Detection)
- Electronics: DAE4 Sn715; Calibrated: 2020.07.27
- Phantom: Twin-SAM1(P1aP2a20); Type: QD 000 P40 CD; Serial: TP:1670
- Measurement SW: DASY52, Version 52.10 (3); SEMCAD X Version 14.6.13 (7474)

**Ch138/Area Scan (91x101x1):** Interpolated grid: dx=1.000 mm, dy=1.000 mm  
Maximum value of SAR (interpolated) = 1.73 W/kg

**Ch138/Zoom Scan (7x7x7)/Cube 0:** Measurement grid: dx=4mm, dy=4mm, dz=1.4mm  
Reference Value = 9.493 V/m; Power Drift = -0.14 dB  
Peak SAR (extrapolated) = 2.93 W/kg  
**SAR(1 g) = 0.701 W/kg; SAR(10 g) = 0.231 W/kg**  
Maximum value of SAR (measured) = 1.67 W/kg

**Ch138/Zoom Scan (7x7x7)/Cube 1:** Measurement grid: dx=4mm, dy=4mm, dz=1.4mm  
Reference Value = 9.493 V/m; Power Drift = -0.14 dB  
Peak SAR (extrapolated) = 2.91 W/kg  
**SAR(1 g) = 0.603 W/kg; SAR(10 g) = 0.214 W/kg**  
Maximum value of SAR (measured) = 1.69 W/kg

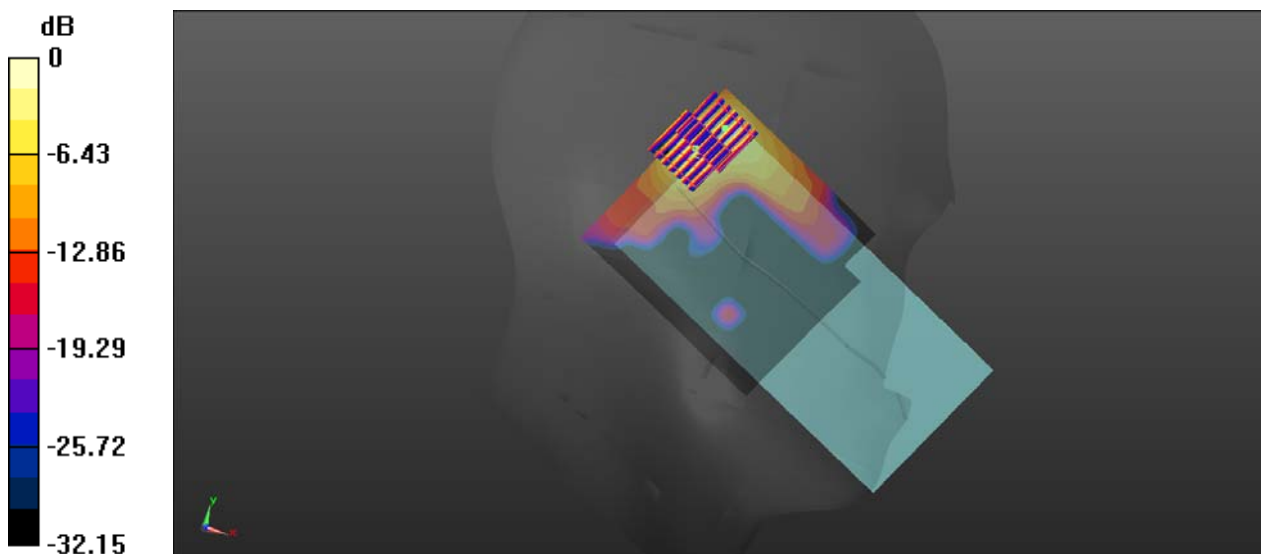

0 dB = 1.73 W/kg

### 13\_WLAN5GHz\_802.11ac-VHT80 MCS0\_Left Tilted\_Ch155

Communication System: UID 0, WIFI (0); Frequency: 5775 MHz; Duty Cycle: 1:1.078  
Medium: HSL\_5750\_201120 Medium parameters used:  $f = 5775$  MHz;  $\sigma = 5.034$  S/m;  $\epsilon_r = 35.54$ ;  $\rho = 1000$  kg/m<sup>3</sup>  
Ambient Temperature : 23.5 °C; Liquid Temperature : 22.5 °C

#### DASY5 Configuration:

- Probe: EX3DV4 - SN7577; ConvF(5.02, 5.02, 5.02); Calibrated: 2020.09.30
- Sensor-Surface: 1.4mm (Mechanical Surface Detection)
- Electronics: DAE4 Sn715; Calibrated: 2020.07.27
- Phantom: Twin-SAM1(P1aP2a20); Type: QD 000 P40 CD; Serial: TP:1670
- Measurement SW: DASY52, Version 52.10 (3); SEMCAD X Version 14.6.13 (7474)

**Ch155/Area Scan (91x101x1):** Interpolated grid: dx=1.000 mm, dy=1.000 mm  
Maximum value of SAR (interpolated) = 0.612 W/kg

**Ch155/Zoom Scan (7x7x7)/Cube 0:** Measurement grid: dx=4mm, dy=4mm, dz=1.4mm  
Reference Value = 7.188 V/m; Power Drift = -0.09 dB  
Peak SAR (extrapolated) = 1.01 W/kg  
**SAR(1 g) = 0.249 W/kg; SAR(10 g) = 0.080 W/kg**  
Maximum value of SAR (measured) = 0.600 W/kg

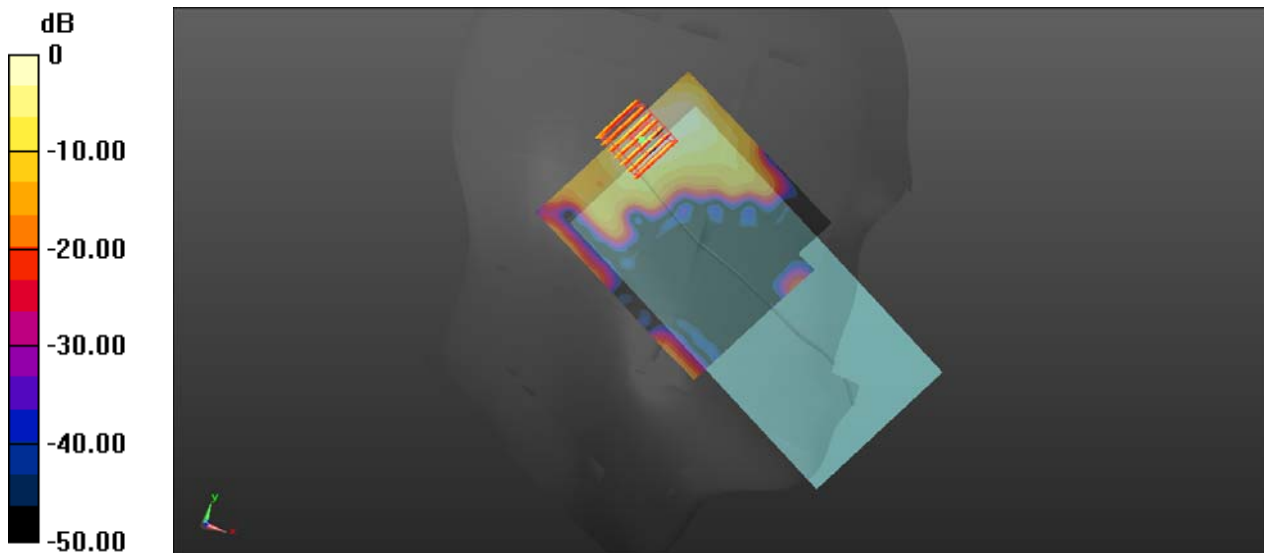

0 dB = 0.600 W/kg

### 14\_Bluetooth\_DH5 1Mbps\_Left Cheek\_Ch39

Communication System: UID 0, Bluetooth (0); Frequency: 2441 MHz; Duty Cycle: 1:1.293  
Medium: HSL\_2450\_201116 Medium parameters used:  $f = 2441$  MHz;  $\sigma = 1.719$  S/m;  $\epsilon_r = 40.81$ ;  $\rho = 1000$  kg/m<sup>3</sup>  
Ambient Temperature : 23.5 °C; Liquid Temperature : 22.6 °C

#### DASY5 Configuration:

- Probe: EX3DV4 - SN7577; ConvF(7.95, 7.95, 7.95); Calibrated: 2020.09.30
- Sensor-Surface: 1.4mm (Mechanical Surface Detection)
- Electronics: DAE4 Sn715; Calibrated: 2020.07.27
- Phantom: Twin-SAM1(P1aP2a20); Type: QD 000 P40 CD; Serial: TP:1670
- Measurement SW: DASY52, Version 52.10 (3); SEMCAD X Version 14.6.13 (7474)

**Ch39/Area Scan (81x151x1):** Interpolated grid: dx=1.200 mm, dy=1.200 mm  
Maximum value of SAR (interpolated) = 0.218 W/kg

**Ch39/Zoom Scan (8x8x7)/Cube 0:** Measurement grid: dx=5mm, dy=5mm, dz=5mm  
Reference Value = 5.077 V/m; Power Drift = 0.14 dB  
Peak SAR (extrapolated) = 0.258 W/kg  
**SAR(1 g) = 0.109 W/kg; SAR(10 g) = 0.054 W/kg**  
Maximum value of SAR (measured) = 0.183 W/kg

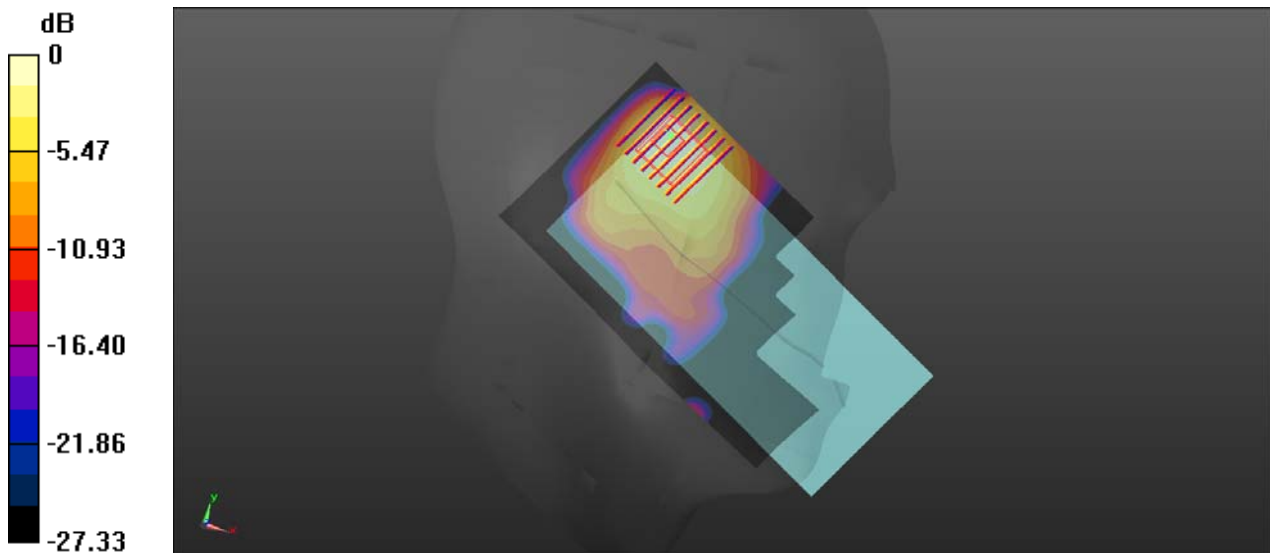

0 dB = 0.183 W/kg



### 15\_GSM850\_GPRS(2 Tx slots)\_Back\_5mm\_Ch251

Communication System: UID 0, GPRS/EDGE10 (0); Frequency: 848.8 MHz; Duty Cycle: 1:4.15  
Medium: HSL\_835\_201114 Medium parameters used:  $f = 849$  MHz;  $\sigma = 0.896$  S/m;  $\epsilon_r = 41.11$ ;  $\rho = 1000$  kg/m<sup>3</sup>

Ambient Temperature : 23.4 °C; Liquid Temperature : 22.5 °C

#### DASY5 Configuration:

- Probe: EX3DV4 - SN7577; ConvF(9.54, 9.54, 9.54); Calibrated: 2020.09.30
- Sensor-Surface: 1.4mm (Mechanical Surface Detection)
- Electronics: DAE4 Sn715; Calibrated: 2020.07.27
- Phantom: Twin-SAM1(P1aP2a20); Type: QD 000 P40 CD; Serial: TP:1670
- Measurement SW: DASY52, Version 52.10 (3); SEMCAD X Version 14.6.13 (7474)

**Ch251/Area Scan (71x71x1):** Interpolated grid: dx=1.500 mm, dy=1.500 mm

Maximum value of SAR (interpolated) = 1.38 W/kg

**Ch251/Zoom Scan (5x5x7)/Cube 0:** Measurement grid: dx=8mm, dy=8mm, dz=5mm

Reference Value = 20.58 V/m; Power Drift = 0.11 dB

Peak SAR (extrapolated) = 2.03 W/kg

**SAR(1 g) = 1.06 W/kg; SAR(10 g) = 0.598 W/kg**

Maximum value of SAR (measured) = 1.62 W/kg

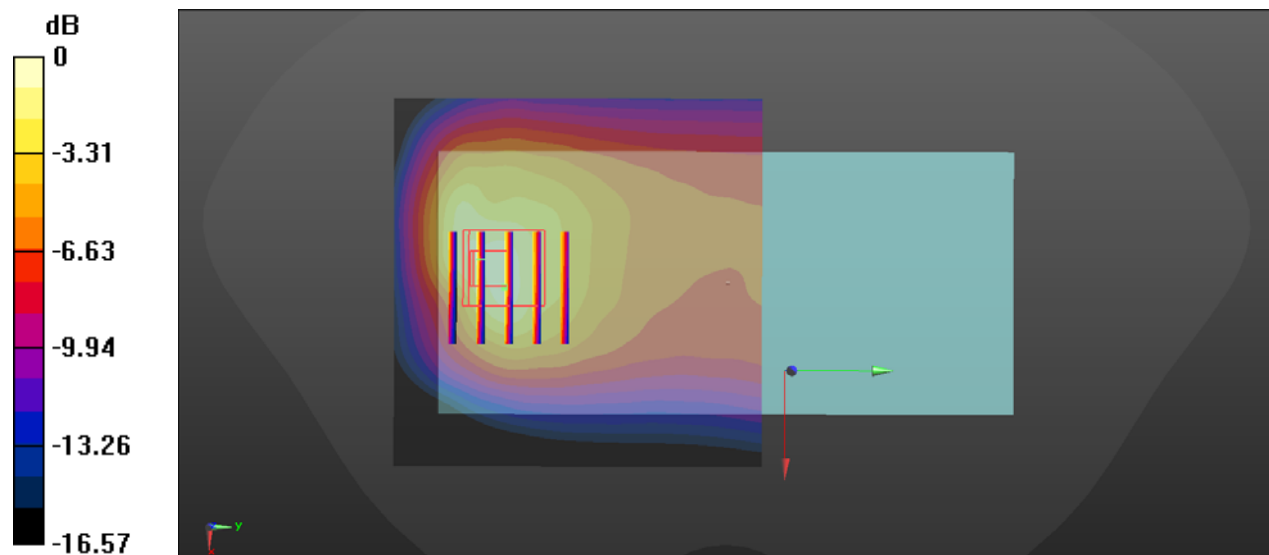

0 dB = 1.62 W/kg

## 16\_GSM1900\_GPRS(2 Tx slots)\_Bottom Side\_5mm\_Ch512

Communication System: UID 0, GPRS/EDGE10 (0); Frequency: 1850.2 MHz; Duty Cycle: 1:4.15  
 Medium: HSL\_1900\_201115 Medium parameters used:  $f = 1850.2$  MHz;  $\sigma = 1.357$  S/m;  $\epsilon_r = 39.509$ ;  $\rho = 1000$  kg/m<sup>3</sup>  
 Ambient Temperature : 23.6 °C; Liquid Temperature : 22.4 °C

### DASY5 Configuration:

- Probe: EX3DV4 - SN7577; ConvF(8.34, 8.34, 8.34); Calibrated: 2020.09.30
- Sensor-Surface: 1.4mm (Mechanical Surface Detection)
- Electronics: DAE4 Sn715; Calibrated: 2020.07.27
- Phantom: Twin-SAM1(P1aP2a20); Type: QD 000 P40 CD; Serial: TP:1670
- Measurement SW: DASY52, Version 52.10 (3); SEMCAD X Version 14.6.13 (7474)

**Ch512/Area Scan (41x71x1):** Interpolated grid: dx=1.500 mm, dy=1.500 mm  
 Maximum value of SAR (interpolated) = 1.43 W/kg

**Ch512/Zoom Scan (5x5x7)/Cube 0:** Measurement grid: dx=8mm, dy=8mm, dz=5mm  
 Reference Value = 0.5180 V/m; Power Drift = 0.14 dB  
 Peak SAR (extrapolated) = 2.13 W/kg  
**SAR(1 g) = 1.03 W/kg; SAR(10 g) = 0.505 W/kg**  
 Maximum value of SAR (measured) = 1.75 W/kg

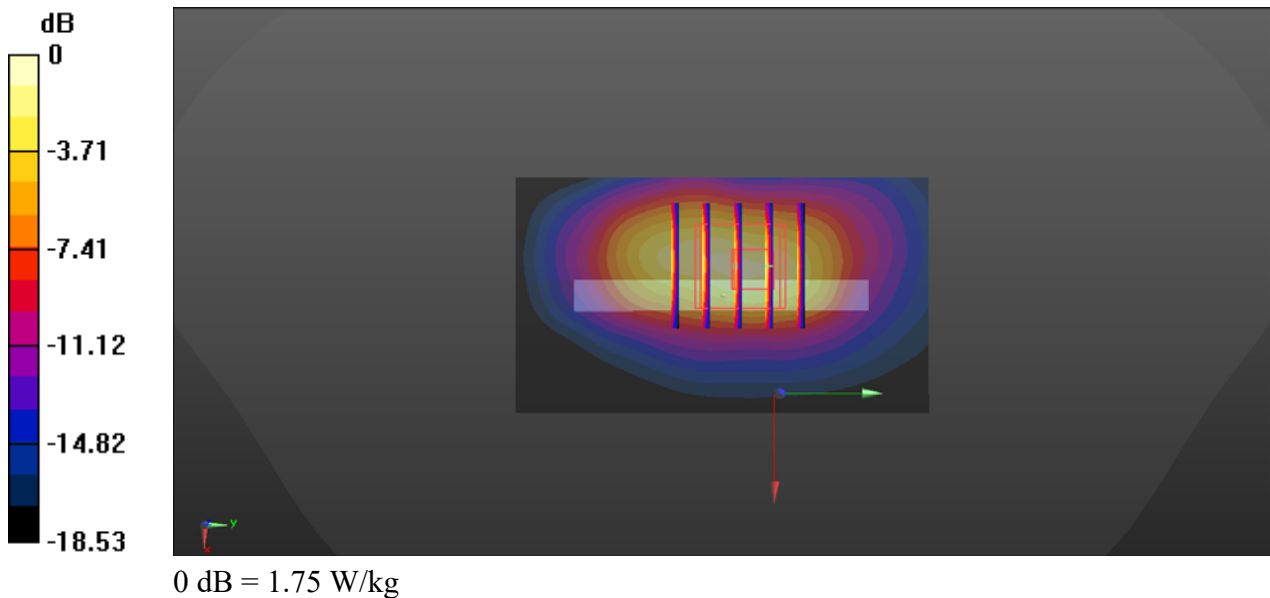

### 17\_WCDMA V\_RMC 12.2Kbps\_Back\_5mm\_Ch4233

Communication System: UID 0, UMTS (0); Frequency: 846.6 MHz; Duty Cycle: 1:1  
Medium: HSL\_835\_201114 Medium parameters used:  $f = 847$  MHz;  $\sigma = 0.894$  S/m;  $\epsilon_r = 41.133$ ;  $\rho = 1000$  kg/m<sup>3</sup>  
Ambient Temperature : 23.4 °C; Liquid Temperature : 22.5 °C

#### DASY5 Configuration:

- Probe: EX3DV4 - SN7577; ConvF(9.54, 9.54, 9.54); Calibrated: 2020.09.30
- Sensor-Surface: 1.4mm (Mechanical Surface Detection)
- Electronics: DAE4 Sn715; Calibrated: 2020.07.27
- Phantom: Twin-SAM1(P1aP2a20); Type: QD 000 P40 CD; Serial: TP:1670
- Measurement SW: DASY52, Version 52.10 (3); SEMCAD X Version 14.6.13 (7474)

**Ch4233/Area Scan (71x71x1):** Interpolated grid: dx=1.500 mm, dy=1.500 mm  
Maximum value of SAR (interpolated) = 1.58 W/kg

**Ch4233/Zoom Scan (5x5x7)/Cube 0:** Measurement grid: dx=8mm, dy=8mm, dz=5mm  
Reference Value = 20.25 V/m; Power Drift = -0.02 dB  
Peak SAR (extrapolated) = 1.79 W/kg  
**SAR(1 g) = 0.960 W/kg; SAR(10 g) = 0.539 W/kg**  
Maximum value of SAR (measured) = 1.42 W/kg

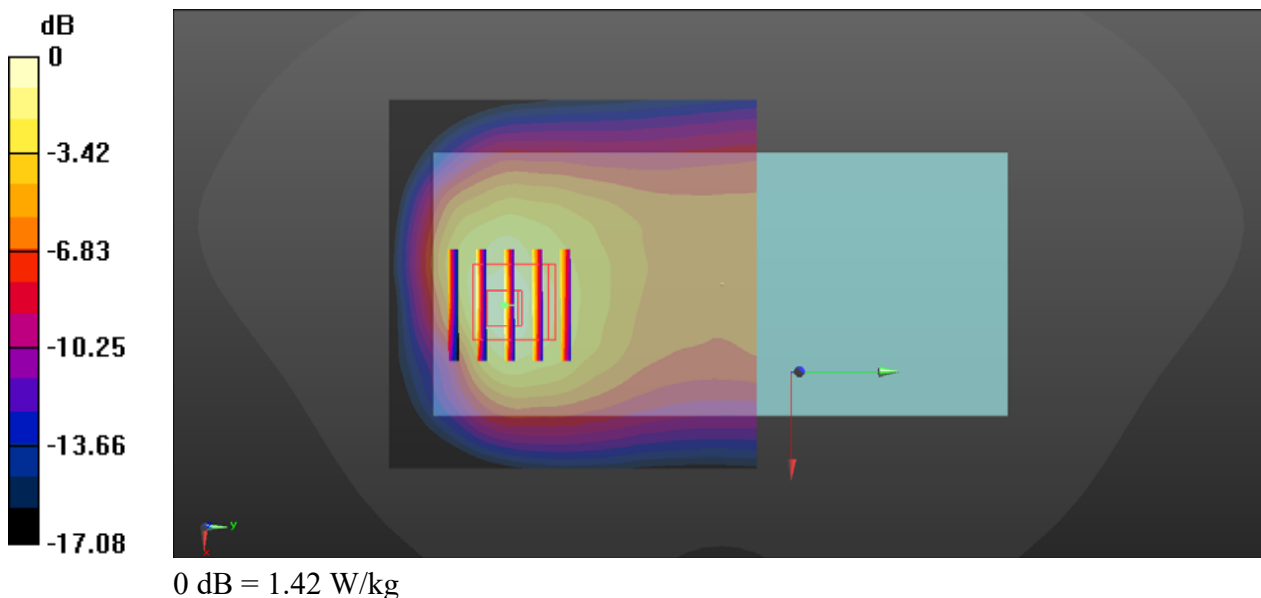

### 18\_WCDMA II\_RMC 12.2Kbps\_Back\_5mm\_Ch9262

Communication System: UID 0, UMTS (0); Frequency: 1852.4 MHz; Duty Cycle: 1:1  
Medium: HSL\_1900\_201115 Medium parameters used:  $f = 1852.4$  MHz;  $\sigma = 1.359$  S/m;  $\epsilon_r = 39.501$ ;  $\rho = 1000$  kg/m<sup>3</sup>  
Ambient Temperature : 23.6 °C; Liquid Temperature : 22.4 °C

#### DASY5 Configuration:

- Probe: EX3DV4 - SN7577; ConvF(8.34, 8.34, 8.34); Calibrated: 2020.09.30
- Sensor-Surface: 1.4mm (Mechanical Surface Detection)
- Electronics: DAE4 Sn715; Calibrated: 2020.07.27
- Phantom: Twin-SAM1(P1aP2a20); Type: QD 000 P40 CD; Serial: TP:1670
- Measurement SW: DASY52, Version 52.10 (3); SEMCAD X Version 14.6.13 (7474)

**Ch9262/Area Scan (71x71x1):** Interpolated grid: dx=1.500 mm, dy=1.500 mm  
Maximum value of SAR (interpolated) = 1.76 W/kg

**Ch9262/Zoom Scan (5x5x7)/Cube 0:** Measurement grid: dx=8mm, dy=8mm, dz=5mm  
Reference Value = 10.47 V/m; Power Drift = 0.06 dB  
Peak SAR (extrapolated) = 1.97 W/kg  
**SAR(1 g) = 0.981 W/kg; SAR(10 g) = 0.520 W/kg**  
Maximum value of SAR (measured) = 1.55 W/kg

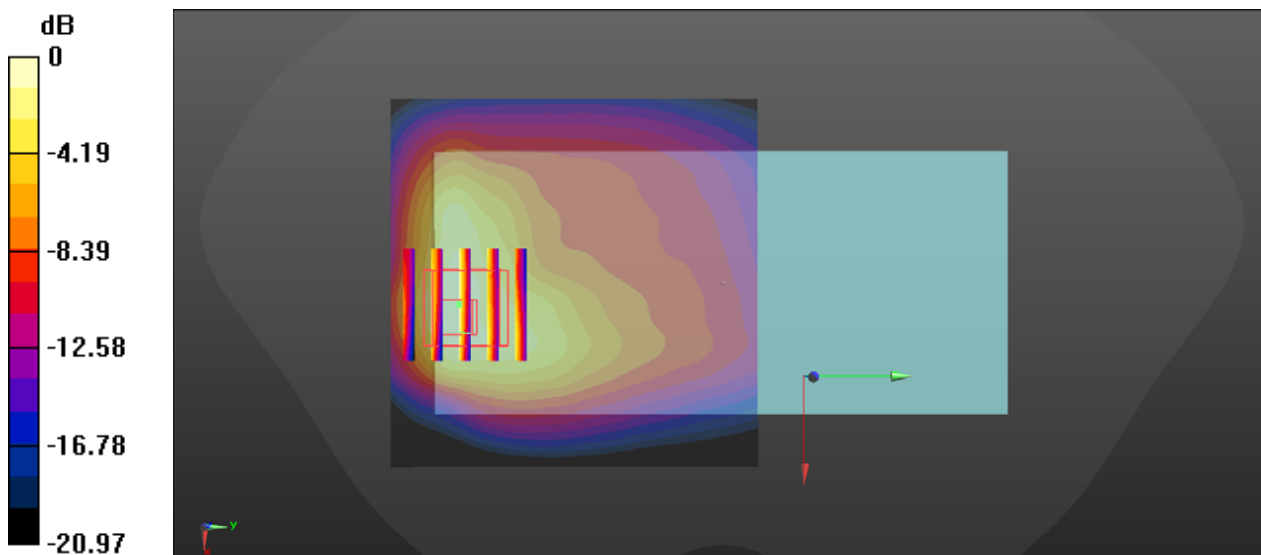

0 dB = 1.55 W/kg

### 19\_LTE Band 5\_10M\_QPSK\_1RB\_25Offset\_Back\_5mm\_Ch20525

Communication System: UID 0, LTE (0); Frequency: 836.5 MHz; Duty Cycle: 1:1  
Medium: HSL\_835\_201114 Medium parameters used:  $f = 836.5$  MHz;  $\sigma = 0.884$  S/m;  $\epsilon_r = 41.261$ ;  
 $\rho = 1000$  kg/m<sup>3</sup>  
Ambient Temperature : 23.4 °C; Liquid Temperature : 22.5 °C

#### DASY5 Configuration:

- Probe: EX3DV4 - SN7577; ConvF(9.54, 9.54, 9.54); Calibrated: 2020.09.30
- Sensor-Surface: 1.4mm (Mechanical Surface Detection)
- Electronics: DAE4 Sn715; Calibrated: 2020.07.27
- Phantom: Twin-SAM1(P1aP2a20); Type: QD 000 P40 CD; Serial: TP:1670
- Measurement SW: DASY52, Version 52.10 (3); SEMCAD X Version 14.6.13 (7474)

**Ch20525/Area Scan (71x71x1):** Interpolated grid: dx=1.500 mm, dy=1.500 mm  
Maximum value of SAR (interpolated) = 1.60 W/kg

**Ch20525/Zoom Scan (5x5x7)/Cube 0:** Measurement grid: dx=8mm, dy=8mm, dz=5mm  
Reference Value = 21.78 V/m; Power Drift = -0.08 dB  
Peak SAR (extrapolated) = 1.86 W/kg  
**SAR(1 g) = 0.998 W/kg; SAR(10 g) = 0.579 W/kg**  
Maximum value of SAR (measured) = 1.49 W/kg

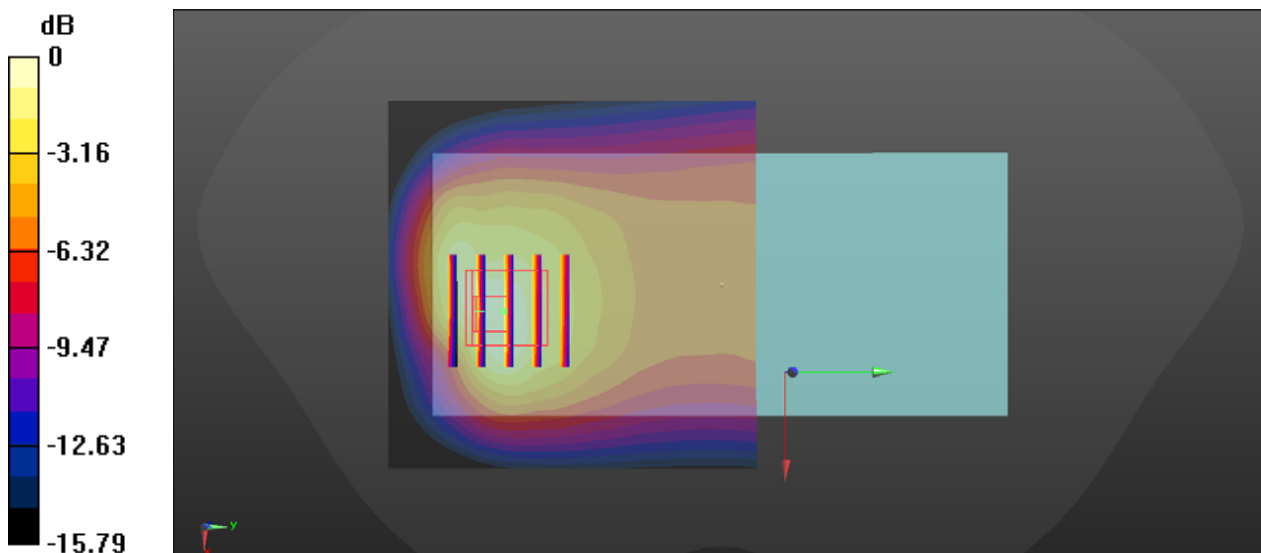

0 dB = 1.49 W/kg

## 20\_LTE Band 26\_15M\_QPSK\_1RB\_37Offset\_Back\_5mm\_Ch26865

Communication System: UID 0, LTE (0); Frequency: 831.5 MHz; Duty Cycle: 1:1  
Medium: HSL\_835\_201114 Medium parameters used:  $f = 831.5$  MHz;  $\sigma = 0.88$  S/m;  $\epsilon_r = 41.322$ ;  $\rho = 1000$  kg/m<sup>3</sup>  
Ambient Temperature : 23.4 °C; Liquid Temperature : 22.5 °C

### DASY5 Configuration:

- Probe: EX3DV4 - SN7577; ConvF(9.54, 9.54, 9.54); Calibrated: 2020.09.30
- Sensor-Surface: 1.4mm (Mechanical Surface Detection)
- Electronics: DAE4 Sn715; Calibrated: 2020.07.27
- Phantom: Twin-SAM1(P1aP2a20); Type: QD 000 P40 CD; Serial: TP:1670
- Measurement SW: DASY52, Version 52.10 (3); SEMCAD X Version 14.6.13 (7474)

**Ch26865/Area Scan (71x71x1):** Interpolated grid: dx=1.500 mm, dy=1.500 mm  
Maximum value of SAR (interpolated) = 1.18 W/kg

**Ch26865/Zoom Scan (5x5x7)/Cube 0:** Measurement grid: dx=8mm, dy=8mm, dz=5mm  
Reference Value = 22.15 V/m; Power Drift = 0.12 dB  
Peak SAR (extrapolated) = 1.80 W/kg  
**SAR(1 g) = 0.963 W/kg; SAR(10 g) = 0.557 W/kg**  
Maximum value of SAR (measured) = 1.45 W/kg

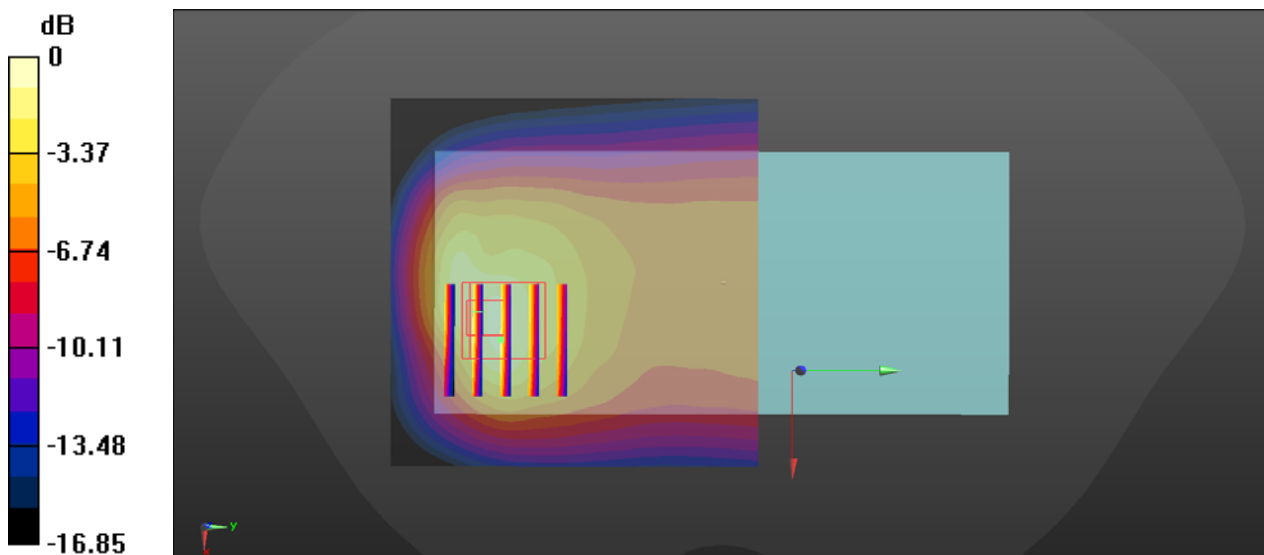

0 dB = 1.45 W/kg

## 21\_LTE Band 2\_20M\_QPSK\_50RB\_0Offset\_Bottom Side\_5mm\_Ch18700

Communication System: UID 0, LTE (0); Frequency: 1860 MHz; Duty Cycle: 1:1  
Medium: HSL\_1900\_201115 Medium parameters used:  $f = 1860$  MHz;  $\sigma = 1.366$  S/m;  $\epsilon_r = 39.475$ ;  
 $\rho = 1000$  kg/m<sup>3</sup>  
Ambient Temperature : 23.6 °C; Liquid Temperature : 22.4 °C

### DASY5 Configuration:

- Probe: EX3DV4 - SN7577; ConvF(8.34, 8.34, 8.34); Calibrated: 2020.09.30
- Sensor-Surface: 1.4mm (Mechanical Surface Detection)
- Electronics: DAE4 Sn715; Calibrated: 2020.07.27
- Phantom: Twin-SAM1(P1aP2a20); Type: QD 000 P40 CD; Serial: TP:1670
- Measurement SW: DASY52, Version 52.10 (3); SEMCAD X Version 14.6.13 (7474)

**Ch18700/Area Scan (41x71x1):** Interpolated grid: dx=1.500 mm, dy=1.500 mm  
Maximum value of SAR (interpolated) = 1.41 W/kg

**Ch18700/Zoom Scan (5x5x7)/Cube 0:** Measurement grid: dx=8mm, dy=8mm, dz=5mm  
Reference Value = 27.66 V/m; Power Drift = 0.14 dB  
Peak SAR (extrapolated) = 2.05 W/kg  
**SAR(1 g) = 1 W/kg; SAR(10 g) = 0.489 W/kg**  
Maximum value of SAR (measured) = 1.67 W/kg

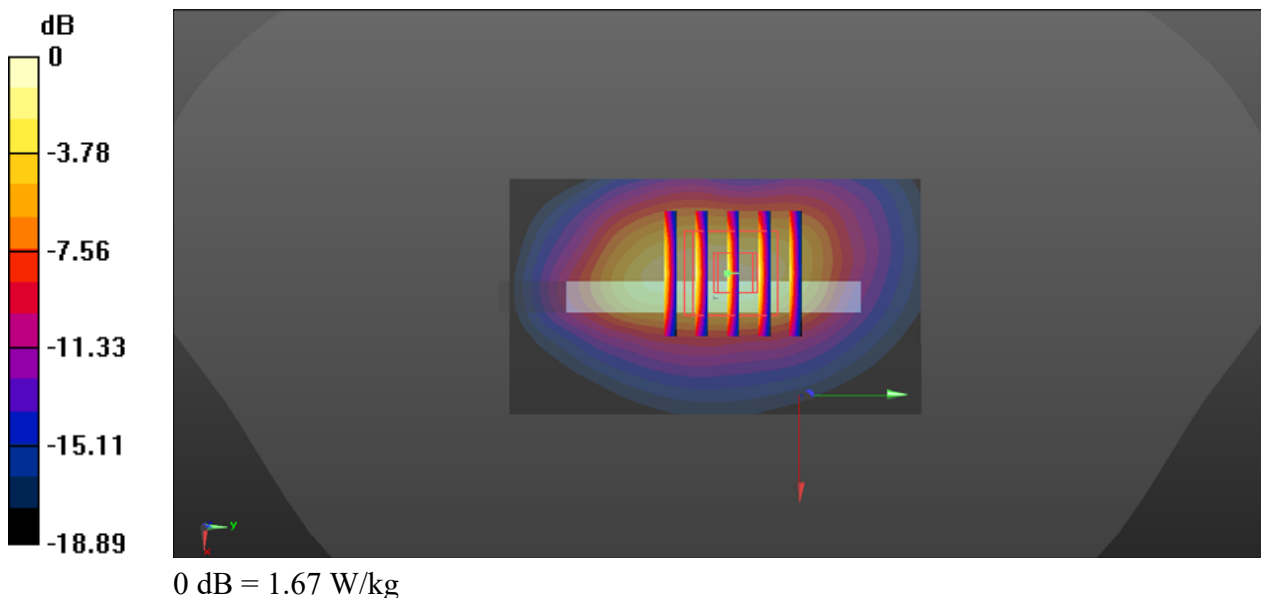

## 22\_LTE Band 7\_20M\_QPSK\_1RB\_49Offset\_Bottom Side\_5mm\_Ch20850

Communication System: UID 0, LTE (0); Frequency: 2510 MHz; Duty Cycle: 1:1  
Medium: HSL\_2600\_201117 Medium parameters used:  $f = 2510$  MHz;  $\sigma = 1.823$  S/m;  $\epsilon_r = 40.148$ ;  
 $\rho = 1000$  kg/m<sup>3</sup>  
Ambient Temperature : 23.6 °C; Liquid Temperature : 22.3 °C

### DASY5 Configuration:

- Probe: EX3DV4 - SN7577; ConvF(7.66, 7.66, 7.66); Calibrated: 2020.09.30
- Sensor-Surface: 1.4mm (Mechanical Surface Detection)
- Electronics: DAE4 Sn715; Calibrated: 2020.07.27
- Phantom: Twin-SAM1(P1aP2a20); Type: QD 000 P40 CD; Serial: TP:1670
- Measurement SW: DASY52, Version 52.10 (3); SEMCAD X Version 14.6.13 (7474)

**Ch20850/Area Scan (41x81x1):** Interpolated grid: dx=1.200 mm, dy=1.200 mm  
Maximum value of SAR (interpolated) = 2.04 W/kg

**Ch20850/Zoom Scan (7x7x7)/Cube 0:** Measurement grid: dx=5mm, dy=5mm, dz=5mm  
Reference Value = 21.87 V/m; Power Drift = 0.15 dB  
Peak SAR (extrapolated) = 2.95 W/kg  
**SAR(1 g) = 1.15 W/kg; SAR(10 g) = 0.457 W/kg**  
Maximum value of SAR (measured) = 2.23 W/kg

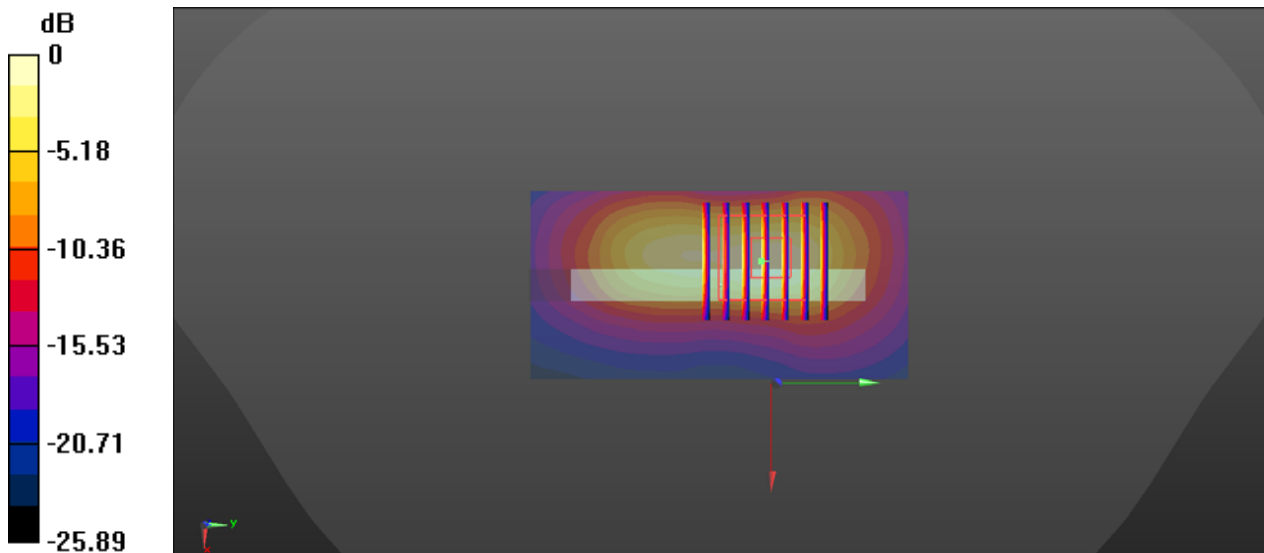

0 dB = 2.23 W/kg



### 23\_LTE Band 41\_20M\_QPSK\_1RB\_49Offset\_Bottom Side\_5mm\_Ch39750

Communication System: UID 0, LTE (0); Frequency: 2506 MHz; Duty Cycle: 1:1.59  
Medium: HSL\_2600\_201117 Medium parameters used:  $f = 2506$  MHz;  $\sigma = 1.818$  S/m;  $\epsilon_r = 40.162$ ;  
 $\rho = 1000$  kg/m<sup>3</sup>  
Ambient Temperature : 23.6 °C; Liquid Temperature : 22.3 °C

#### DASY5 Configuration:

- Probe: EX3DV4 - SN7577; ConvF(7.66, 7.66, 7.66); Calibrated: 2020.09.30
- Sensor-Surface: 1.4mm (Mechanical Surface Detection)
- Electronics: DAE4 Sn715; Calibrated: 2020.07.27
- Phantom: Twin-SAM1(P1aP2a20); Type: QD 000 P40 CD; Serial: TP:1670
- Measurement SW: DASY52, Version 52.10 (3); SEMCAD X Version 14.6.13 (7474)

**Ch39750/Area Scan (31x81x1):** Interpolated grid: dx=1.200 mm, dy=1.200 mm  
Maximum value of SAR (interpolated) = 2.12 W/kg

**Ch39750/Zoom Scan (7x7x7)/Cube 0:** Measurement grid: dx=5mm, dy=5mm, dz=5mm  
Reference Value = 22.70 V/m; Power Drift = 0.17 dB  
Peak SAR (extrapolated) = 2.74 W/kg  
**SAR(1 g) = 1.08 W/kg; SAR(10 g) = 0.433 W/kg**  
Maximum value of SAR (measured) = 2.07 W/kg

**Ch39750/Zoom Scan (7x7x7)/Cube 1:** Measurement grid: dx=5mm, dy=5mm, dz=5mm  
Reference Value = 22.70 V/m; Power Drift = 0.17 dB  
Peak SAR (extrapolated) = 2.44 W/kg  
**SAR(1 g) = 0.887 W/kg; SAR(10 g) = 0.367 W/kg**  
Maximum value of SAR (measured) = 1.80 W/kg

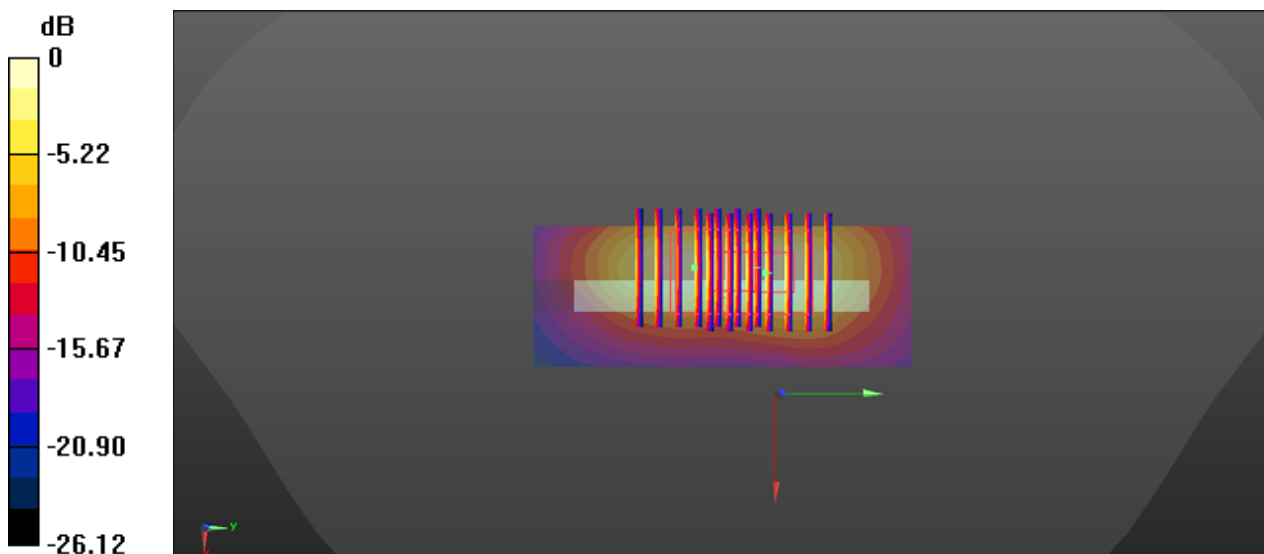

0 dB = 1.80 W/kg

## 24\_WLAN2.4GHz\_802.11b 1Mbps\_Back\_5mm\_Ch6

Communication System: UID 0, WIFI (0); Frequency: 2437 MHz; Duty Cycle: 1:1.007  
Medium: HSL\_2450\_201116 Medium parameters used:  $f = 2437$  MHz;  $\sigma = 1.851$  S/m;  $\epsilon_r = 37.563$ ;  
 $\rho = 1000$  kg/m<sup>3</sup>  
Ambient Temperature : 23.5 °C; Liquid Temperature : 22.6 °C

### DASY5 Configuration:

- Probe: EX3DV4 - SN7577; ConvF(7.95, 7.95, 7.95); Calibrated: 2020.09.30
- Sensor-Surface: 1.4mm (Mechanical Surface Detection)
- Electronics: DAE4 Sn715; Calibrated: 2020.07.27
- Phantom: Twin-SAM1(P1aP2a20); Type: QD 000 P40 CD; Serial: TP:1670
- Measurement SW: DASY52, Version 52.10 (3); SEMCAD X Version 14.6.13 (7474)

**Ch6/Area Scan (81x81x1):** Interpolated grid: dx=1.200 mm, dy=1.200 mm  
Maximum value of SAR (interpolated) = 1.37 W/kg

**Ch6/Zoom Scan (7x7x7)/Cube 0:** Measurement grid: dx=5mm, dy=5mm, dz=5mm  
Reference Value = 7.817 V/m; Power Drift = 0.15 dB  
Peak SAR (extrapolated) = 1.83 W/kg  
**SAR(1 g) = 0.743 W/kg; SAR(10 g) = 0.349 W/kg**  
Maximum value of SAR (measured) = 1.33 W/kg

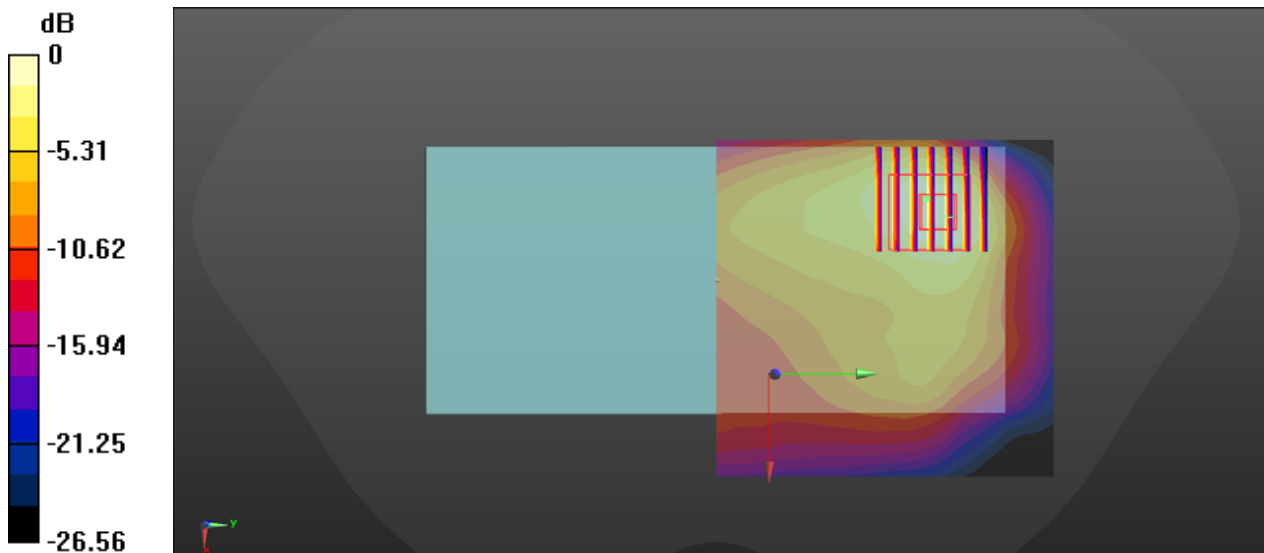

0 dB = 1.33 W/kg

## 25\_WLAN5GHz\_802.11n-HT40 MCS0\_Back\_5mm\_Ch46

Communication System: UID 0, WIFI (0); Frequency: 5230 MHz; Duty Cycle: 1:1.038  
 Medium: HSL\_5250\_201118 Medium parameters used:  $f = 5230 \text{ MHz}$ ;  $\sigma = 4.484 \text{ S/m}$ ;  $\epsilon_r = 36.273$ ;  
 $\rho = 1000 \text{ kg/m}^3$   
 Ambient Temperature : 23.3 °C; Liquid Temperature : 22.5 °C

### DASY5 Configuration:

- Probe: EX3DV4 - SN7577; ConvF(5.4, 5.4, 5.4); Calibrated: 2020.09.30
- Sensor-Surface: 1.4mm (Mechanical Surface Detection)
- Electronics: DAE4 Sn715; Calibrated: 2020.07.27
- Phantom: Twin-SAM1(P1aP2a20); Type: QD 000 P40 CD; Serial: TP:1670
- Measurement SW: DASY52, Version 52.10 (3); SEMCAD X Version 14.6.13 (7474)

**Ch46/Area Scan (101x101x1):** Interpolated grid:  $dx=1.000 \text{ mm}$ ,  $dy=1.000 \text{ mm}$   
 Maximum value of SAR (interpolated) = 1.37 W/kg

**Ch46/Zoom Scan (7x7x7)/Cube 0:** Measurement grid:  $dx=4\text{mm}$ ,  $dy=4\text{mm}$ ,  $dz=1.4\text{mm}$   
 Reference Value = 3.378 V/m; Power Drift = 0.09 dB  
 Peak SAR (extrapolated) = 2.36 W/kg  
**SAR(1 g) = 0.616 W/kg; SAR(10 g) = 0.180 W/kg**  
 Maximum value of SAR (measured) = 1.48 W/kg

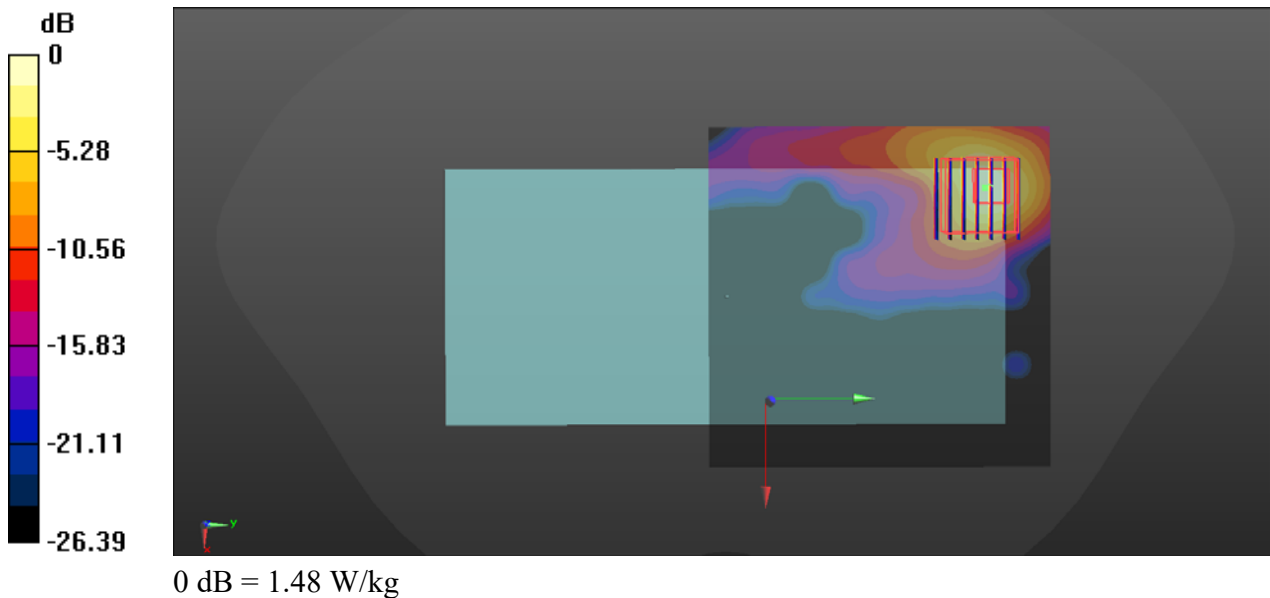

## 26\_WLAN5GHz\_802.11ac-VHT80 MCS0\_Back\_5mm\_Ch155

Communication System: UID 0, WIFI (0); Frequency: 5775 MHz; Duty Cycle: 1:1.078  
Medium: HSL\_5750\_201120 Medium parameters used:  $f = 5775$  MHz;  $\sigma = 5.034$  S/m;  $\epsilon_r = 35.54$ ;  $\rho = 1000$  kg/m<sup>3</sup>  
Ambient Temperature : 23.5 °C; Liquid Temperature : 22.5 °C

### DASY5 Configuration:

- Probe: EX3DV4 - SN7577; ConvF(5.02, 5.02, 5.02); Calibrated: 2020.09.30
- Sensor-Surface: 1.4mm (Mechanical Surface Detection)
- Electronics: DAE4 Sn715; Calibrated: 2020.07.27
- Phantom: Twin-SAM1(P1aP2a20); Type: QD 000 P40 CD; Serial: TP:1670
- Measurement SW: DASY52, Version 52.10 (3); SEMCAD X Version 14.6.13 (7474)

**Ch155/Area Scan (101x101x1):** Interpolated grid: dx=1.000 mm, dy=1.000 mm  
Maximum value of SAR (interpolated) = 1.08 W/kg

**Ch155/Zoom Scan (7x7x7)/Cube 0:** Measurement grid: dx=4mm, dy=4mm, dz=1.4mm  
Reference Value = 0.5530 V/m; Power Drift = 0.15 dB  
Peak SAR (extrapolated) = 1.87 W/kg  
**SAR(1 g) = 0.436 W/kg; SAR(10 g) = 0.131 W/kg**  
Maximum value of SAR (measured) = 1.10 W/kg

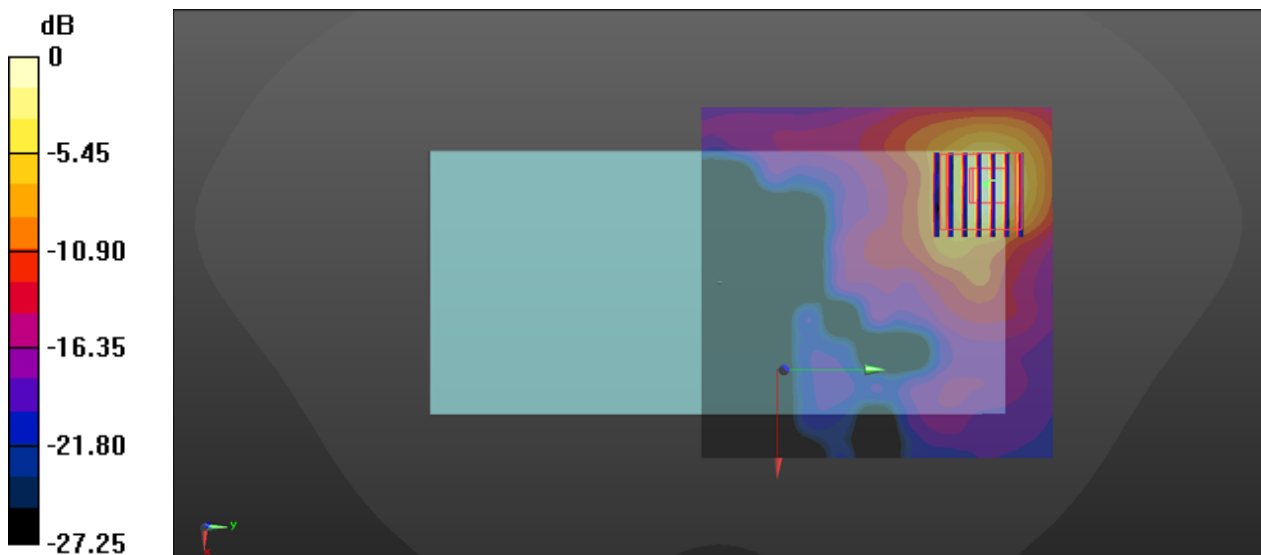

0 dB = 1.10 W/kg

## 27\_Bluetooth\_DH5 1Mbps\_Back\_5mm\_Ch39

Communication System: UID 0, Bluetooth (0); Frequency: 2441 MHz; Duty Cycle: 1:1.293  
Medium: HSL\_2450\_201116 Medium parameters used:  $f = 2441$  MHz;  $\sigma = 1.719$  S/m;  $\epsilon_r = 40.81$ ;  $\rho = 1000$  kg/m<sup>3</sup>  
Ambient Temperature : 23.5 °C; Liquid Temperature : 22.6 °C

### DASY5 Configuration:

- Probe: EX3DV4 - SN7577; ConvF(7.95, 7.95, 7.95); Calibrated: 2020.09.30
- Sensor-Surface: 1.4mm (Mechanical Surface Detection)
- Electronics: DAE4 Sn715; Calibrated: 2020.07.27
- Phantom: Twin-SAM1(P1aP2a20); Type: QD 000 P40 CD; Serial: TP:1670
- Measurement SW: DASY52, Version 52.10 (3); SEMCAD X Version 14.6.13 (7474)

**Ch39/Area Scan (81x151x1):** Interpolated grid: dx=1.200 mm, dy=1.200 mm  
Maximum value of SAR (interpolated) = 0.156 W/kg

**Ch39/Zoom Scan (7x7x7)/Cube 0:** Measurement grid: dx=5mm, dy=5mm, dz=5mm  
Reference Value = 2.594 V/m; Power Drift = 0.08 dB  
Peak SAR (extrapolated) = 0.209 W/kg  
**SAR(1 g) = 0.083 W/kg; SAR(10 g) = 0.038 W/kg**  
Maximum value of SAR (measured) = 0.153 W/kg

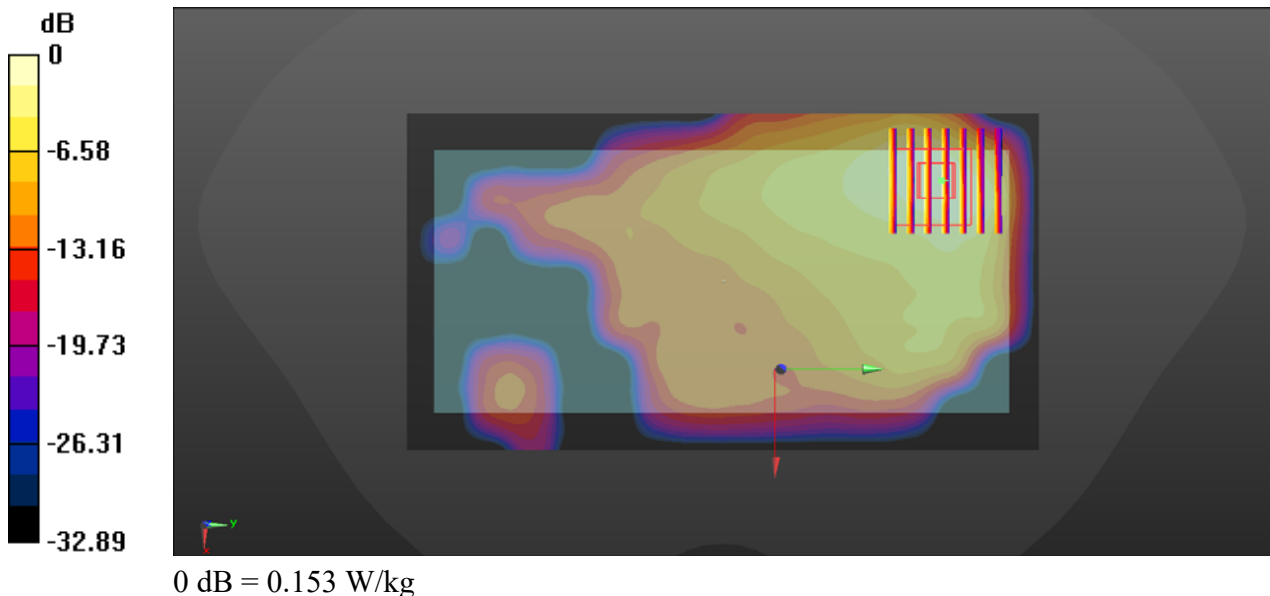

## 28\_GSM850\_GPRS(2 Tx slots)\_Back\_5mm\_Ch251

Communication System: UID 0, GPRS/EDGE10 (0); Frequency: 848.8 MHz; Duty Cycle: 1:4.15  
Medium: HSL\_835\_201114 Medium parameters used:  $f = 849$  MHz;  $\sigma = 0.896$  S/m;  $\epsilon_r = 41.11$ ;  $\rho = 1000$  kg/m<sup>3</sup>

Ambient Temperature : 23.4 °C; Liquid Temperature : 22.5 °C

### DASY5 Configuration:

- Probe: EX3DV4 - SN7577; ConvF(9.54, 9.54, 9.54); Calibrated: 2020.09.30
- Sensor-Surface: 1.4mm (Mechanical Surface Detection)
- Electronics: DAE4 Sn715; Calibrated: 2020.07.27
- Phantom: Twin-SAM1(P1aP2a20); Type: QD 000 P40 CD; Serial: TP:1670
- Measurement SW: DASY52, Version 52.10 (3); SEMCAD X Version 14.6.13 (7474)

**Ch251/Area Scan (71x71x1):** Interpolated grid: dx=1.500 mm, dy=1.500 mm

Maximum value of SAR (interpolated) = 1.38 W/kg

**Ch251/Zoom Scan (5x5x7)/Cube 0:** Measurement grid: dx=8mm, dy=8mm, dz=5mm

Reference Value = 20.58 V/m; Power Drift = 0.11 dB

Peak SAR (extrapolated) = 2.03 W/kg

**SAR(1 g) = 1.06 W/kg; SAR(10 g) = 0.598 W/kg**

Maximum value of SAR (measured) = 1.62 W/kg

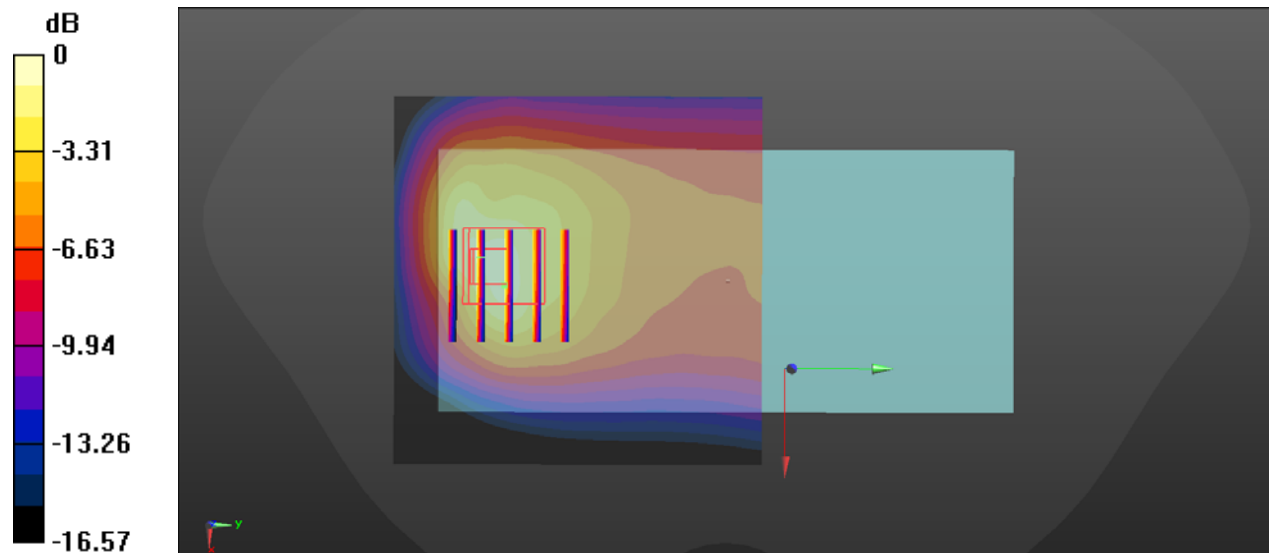

0 dB = 1.62 W/kg

## 29\_GSM1900\_GPRS(2 Tx slots)\_Back\_5mm\_Ch512

Communication System: UID 0, GPRS/EDGE10 (0); Frequency: 1850.2 MHz; Duty Cycle: 1:4.15  
Medium: HSL\_1900\_201115 Medium parameters used:  $f = 1850.2$  MHz;  $\sigma = 1.357$  S/m;  $\epsilon_r = 39.509$ ;  $\rho = 1000$  kg/m<sup>3</sup>  
Ambient Temperature : 23.6 °C; Liquid Temperature : 22.4 °C

### DASY5 Configuration:

- Probe: EX3DV4 - SN7577; ConvF(8.34, 8.34, 8.34); Calibrated: 2020.09.30
- Sensor-Surface: 1.4mm (Mechanical Surface Detection)
- Electronics: DAE4 Sn715; Calibrated: 2020.07.27
- Phantom: Twin-SAM1(P1aP2a20); Type: QD 000 P40 CD; Serial: TP:1670
- Measurement SW: DASY52, Version 52.10 (3); SEMCAD X Version 14.6.13 (7474)

**Ch512/Area Scan (71x71x1):** Interpolated grid: dx=1.500 mm, dy=1.500 mm  
Maximum value of SAR (interpolated) = 1.19 W/kg

**Ch512/Zoom Scan (5x5x7)/Cube 0:** Measurement grid: dx=8mm, dy=8mm, dz=5mm  
Reference Value = 7.246 V/m; Power Drift = 0.12 dB  
Peak SAR (extrapolated) = 1.59 W/kg  
**SAR(1 g) = 0.805 W/kg; SAR(10 g) = 0.436 W/kg**  
Maximum value of SAR (measured) = 1.25 W/kg

**Ch512/Zoom Scan (5x5x7)/Cube 1:** Measurement grid: dx=8mm, dy=8mm, dz=5mm  
Reference Value = 7.246 V/m; Power Drift = 0.12 dB  
Peak SAR (extrapolated) = 1.46 W/kg  
**SAR(1 g) = 0.780 W/kg; SAR(10 g) = 0.419 W/kg**  
Maximum value of SAR (measured) = 1.17 W/kg

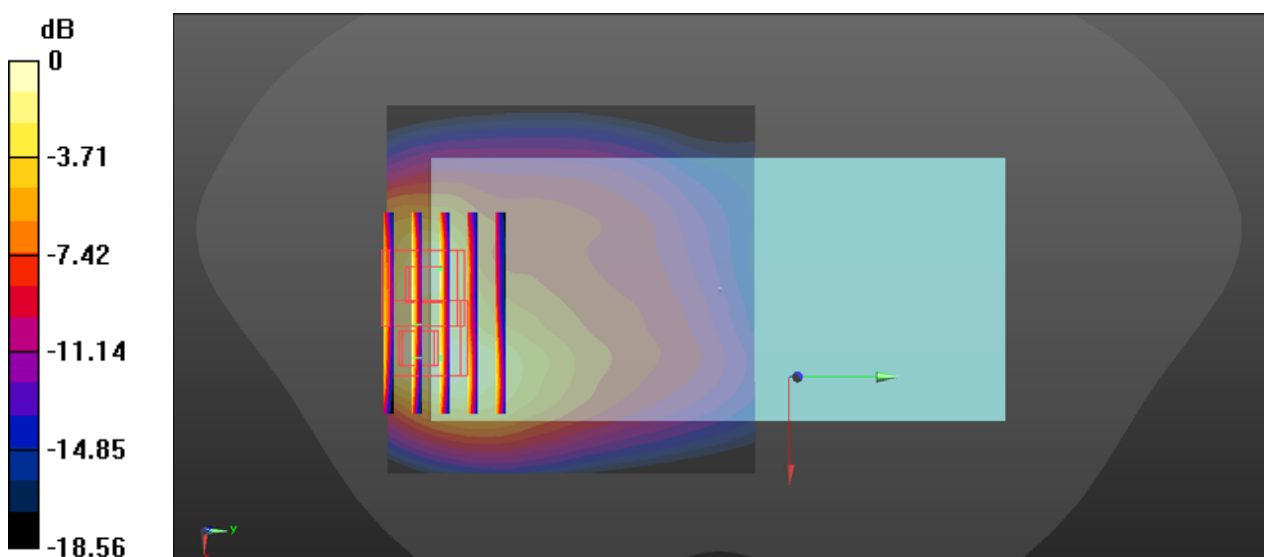

0 dB = 1.17 W/kg

### 30\_WCDMA V\_RMC 12.2Kbps\_Back\_5mm\_Ch4233\_Headset

Communication System: UID 0, UMTS (0); Frequency: 846.6 MHz; Duty Cycle: 1:1  
 Medium: HSL\_835\_201114 Medium parameters used:  $f = 847 \text{ MHz}$ ;  $\sigma = 0.894 \text{ S/m}$ ;  $\epsilon_r = 41.133$ ;  $\rho = 1000 \text{ kg/m}^3$   
 Ambient Temperature : 23.4 °C; Liquid Temperature : 22.5 °C

**DASY5 Configuration:**

- Probe: EX3DV4 - SN7577; ConvF(9.54, 9.54, 9.54); Calibrated: 2020.09.30
- Sensor-Surface: 1.4mm (Mechanical Surface Detection)
- Electronics: DAE4 Sn715; Calibrated: 2020.07.27
- Phantom: Twin-SAM1(P1aP2a20); Type: QD 000 P40 CD; Serial: TP:1670
- Measurement SW: DASY52, Version 52.10 (3); SEMCAD X Version 14.6.13 (7474)

**Ch4233/Area Scan (71x71x1):** Interpolated grid:  $dx=1.500 \text{ mm}$ ,  $dy=1.500 \text{ mm}$   
 Maximum value of SAR (interpolated) = 1.27 W/kg

**Ch4233/Zoom Scan (5x5x7)/Cube 0:** Measurement grid:  $dx=8\text{mm}$ ,  $dy=8\text{mm}$ ,  $dz=5\text{mm}$   
 Reference Value = 21.38 V/m; Power Drift = -0.07 dB  
 Peak SAR (extrapolated) = 1.88 W/kg  
**SAR(1 g) = 0.976 W/kg; SAR(10 g) = 0.546 W/kg**  
 Maximum value of SAR (measured) = 1.50 W/kg

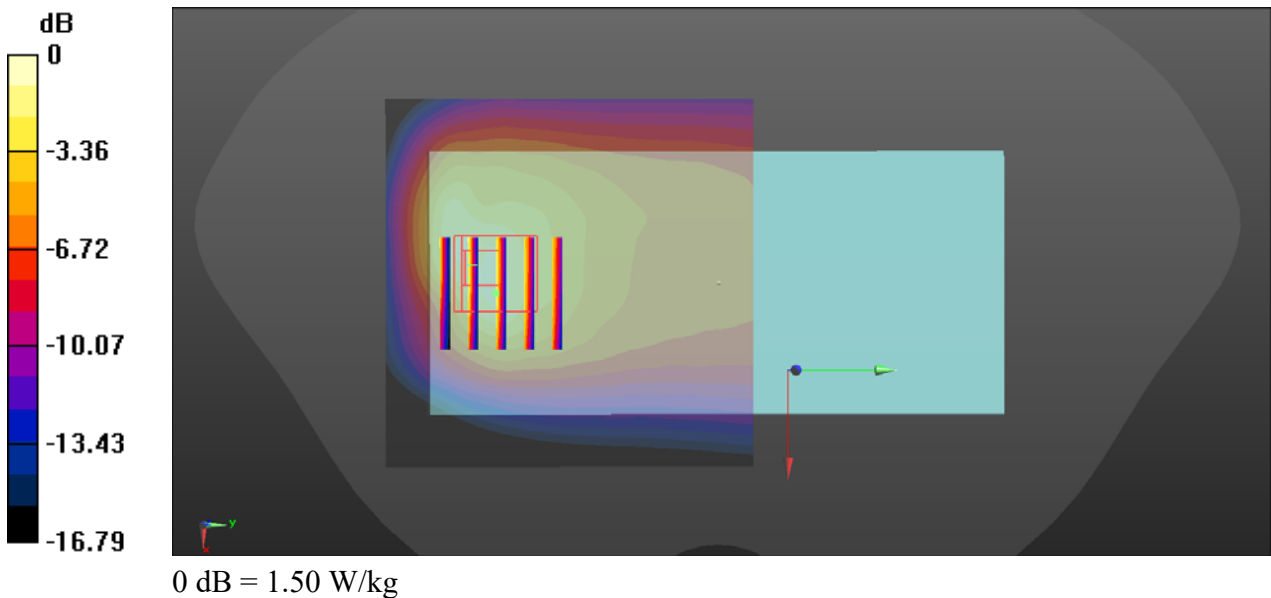



### 31\_WCDMA II\_RMC 12.2Kbps\_Back\_5mm\_Ch9262

Communication System: UID 0, UMTS (0); Frequency: 1852.4 MHz; Duty Cycle: 1:1  
Medium: HSL\_1900\_201115 Medium parameters used:  $f = 1852.4$  MHz;  $\sigma = 1.359$  S/m;  $\epsilon_r = 39.501$ ;  $\rho = 1000$  kg/m<sup>3</sup>  
Ambient Temperature : 23.6 °C; Liquid Temperature : 22.4 °C

#### DASY5 Configuration:

- Probe: EX3DV4 - SN7577; ConvF(8.34, 8.34, 8.34); Calibrated: 2020.09.30
- Sensor-Surface: 1.4mm (Mechanical Surface Detection)
- Electronics: DAE4 Sn715; Calibrated: 2020.07.27
- Phantom: Twin-SAM1(P1aP2a20); Type: QD 000 P40 CD; Serial: TP:1670
- Measurement SW: DASY52, Version 52.10 (3); SEMCAD X Version 14.6.13 (7474)

**Ch9262/Area Scan (71x71x1):** Interpolated grid: dx=1.500 mm, dy=1.500 mm  
Maximum value of SAR (interpolated) = 1.76 W/kg

**Ch9262/Zoom Scan (5x5x7)/Cube 0:** Measurement grid: dx=8mm, dy=8mm, dz=5mm  
Reference Value = 10.47 V/m; Power Drift = 0.06 dB  
Peak SAR (extrapolated) = 1.97 W/kg  
**SAR(1 g) = 0.981 W/kg; SAR(10 g) = 0.520 W/kg**  
Maximum value of SAR (measured) = 1.55 W/kg

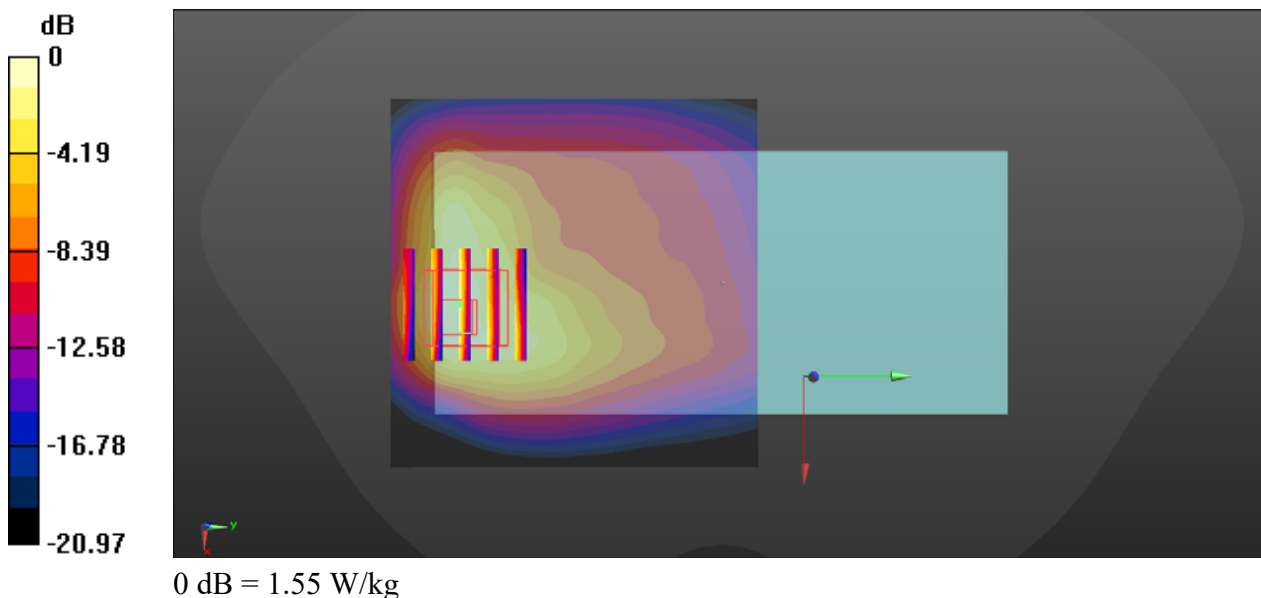

### 32\_LTE Band 5\_10M\_QPSK\_1RB\_25Offset\_Back\_5mm\_Ch20525

Communication System: UID 0, LTE (0); Frequency: 836.5 MHz; Duty Cycle: 1:1  
Medium: HSL\_835\_201114 Medium parameters used:  $f = 836.5$  MHz;  $\sigma = 0.884$  S/m;  $\epsilon_r = 41.261$ ;  
 $\rho = 1000$  kg/m<sup>3</sup>  
Ambient Temperature : 23.4 °C; Liquid Temperature : 22.5 °C

#### DASY5 Configuration:

- Probe: EX3DV4 - SN7577; ConvF(9.54, 9.54, 9.54); Calibrated: 2020.09.30
- Sensor-Surface: 1.4mm (Mechanical Surface Detection)
- Electronics: DAE4 Sn715; Calibrated: 2020.07.27
- Phantom: Twin-SAM1(P1aP2a20); Type: QD 000 P40 CD; Serial: TP:1670
- Measurement SW: DASY52, Version 52.10 (3); SEMCAD X Version 14.6.13 (7474)

**Ch20525/Area Scan (71x71x1):** Interpolated grid: dx=1.500 mm, dy=1.500 mm  
Maximum value of SAR (interpolated) = 1.60 W/kg

**Ch20525/Zoom Scan (5x5x7)/Cube 0:** Measurement grid: dx=8mm, dy=8mm, dz=5mm  
Reference Value = 21.78 V/m; Power Drift = -0.08 dB  
Peak SAR (extrapolated) = 1.86 W/kg  
**SAR(1 g) = 0.998 W/kg; SAR(10 g) = 0.579 W/kg**  
Maximum value of SAR (measured) = 1.49 W/kg

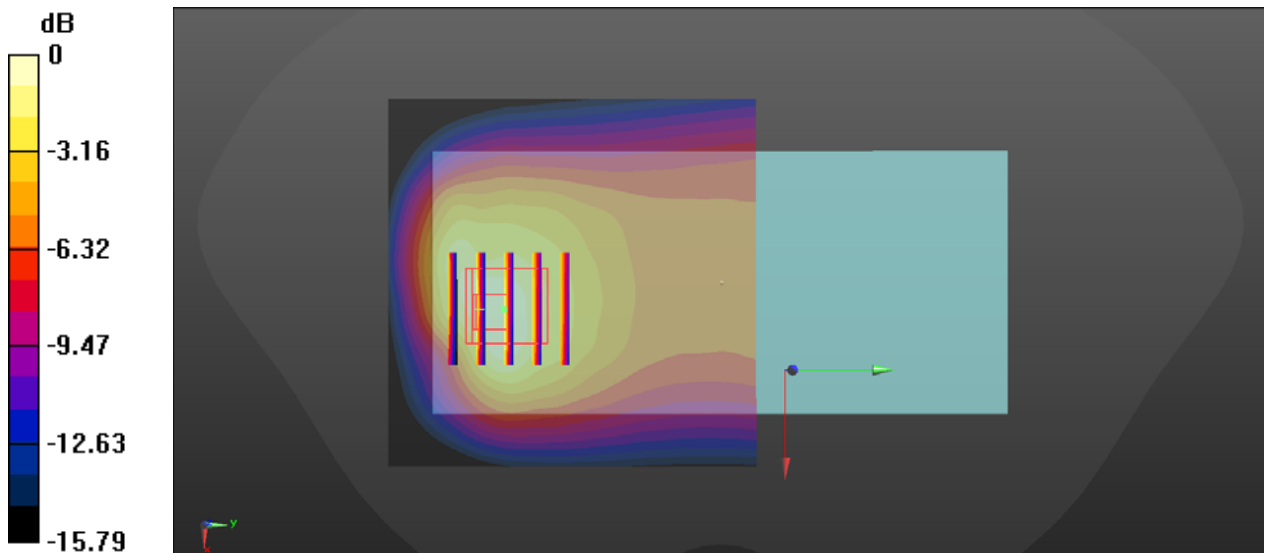

0 dB = 1.49 W/kg

### 33\_LTE Band 26\_15M\_QPSK\_1RB\_37Offset\_Back\_5mm\_Ch26865

Communication System: UID 0, LTE (0); Frequency: 831.5 MHz; Duty Cycle: 1:1  
Medium: HSL\_835\_201114 Medium parameters used:  $f = 831.5$  MHz;  $\sigma = 0.88$  S/m;  $\epsilon_r = 41.322$ ;  $\rho = 1000$  kg/m<sup>3</sup>  
Ambient Temperature : 23.4 °C; Liquid Temperature : 22.5 °C

#### DASY5 Configuration:

- Probe: EX3DV4 - SN7577; ConvF(9.54, 9.54, 9.54); Calibrated: 2020.09.30
- Sensor-Surface: 1.4mm (Mechanical Surface Detection)
- Electronics: DAE4 Sn715; Calibrated: 2020.07.27
- Phantom: Twin-SAM1(P1aP2a20); Type: QD 000 P40 CD; Serial: TP:1670
- Measurement SW: DASY52, Version 52.10 (3); SEMCAD X Version 14.6.13 (7474)

**Ch26865/Area Scan (71x71x1):** Interpolated grid: dx=1.500 mm, dy=1.500 mm  
Maximum value of SAR (interpolated) = 1.18 W/kg

**Ch26865/Zoom Scan (5x5x7)/Cube 0:** Measurement grid: dx=8mm, dy=8mm, dz=5mm  
Reference Value = 22.15 V/m; Power Drift = 0.12 dB  
Peak SAR (extrapolated) = 1.80 W/kg  
**SAR(1 g) = 0.963 W/kg; SAR(10 g) = 0.557 W/kg**  
Maximum value of SAR (measured) = 1.45 W/kg

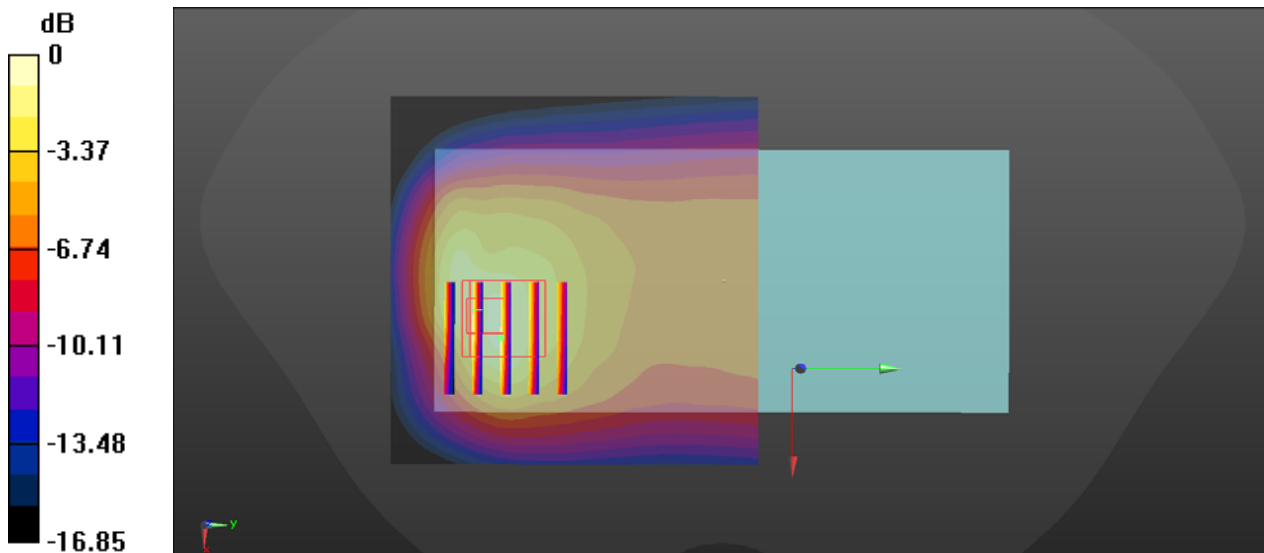

0 dB = 1.45 W/kg

### 34\_LTE Band 2\_20M\_QPSK\_50RB\_0Offset\_Back\_5mm\_Ch18700\_Headset

Communication System: UID 0, LTE (0); Frequency: 1860 MHz; Duty Cycle: 1:1  
Medium: HSL\_1900\_201115 Medium parameters used:  $f = 1860$  MHz;  $\sigma = 1.366$  S/m;  $\epsilon_r = 39.475$ ;  
 $\rho = 1000$  kg/m<sup>3</sup>  
Ambient Temperature : 23.6 °C; Liquid Temperature : 22.4 °C

#### DASY5 Configuration:

- Probe: EX3DV4 - SN7577; ConvF(8.34, 8.34, 8.34); Calibrated: 2020.09.30
- Sensor-Surface: 1.4mm (Mechanical Surface Detection)
- Electronics: DAE4 Sn715; Calibrated: 2020.07.27
- Phantom: Twin-SAM1(P1aP2a20); Type: QD 000 P40 CD; Serial: TP:1670
- Measurement SW: DASY52, Version 52.10 (3); SEMCAD X Version 14.6.13 (7474)

**Ch18700/Area Scan (71x71x1):** Interpolated grid: dx=1.500 mm, dy=1.500 mm  
Maximum value of SAR (interpolated) = 1.94 W/kg

**Ch18700/Zoom Scan (5x5x7)/Cube 0:** Measurement grid: dx=8mm, dy=8mm, dz=5mm  
Reference Value = 0.9090 V/m; Power Drift = 0.17 dB  
Peak SAR (extrapolated) = 2.09 W/kg  
**SAR(1 g) = 1.04 W/kg; SAR(10 g) = 0.546 W/kg**  
Maximum value of SAR (measured) = 1.56 W/kg

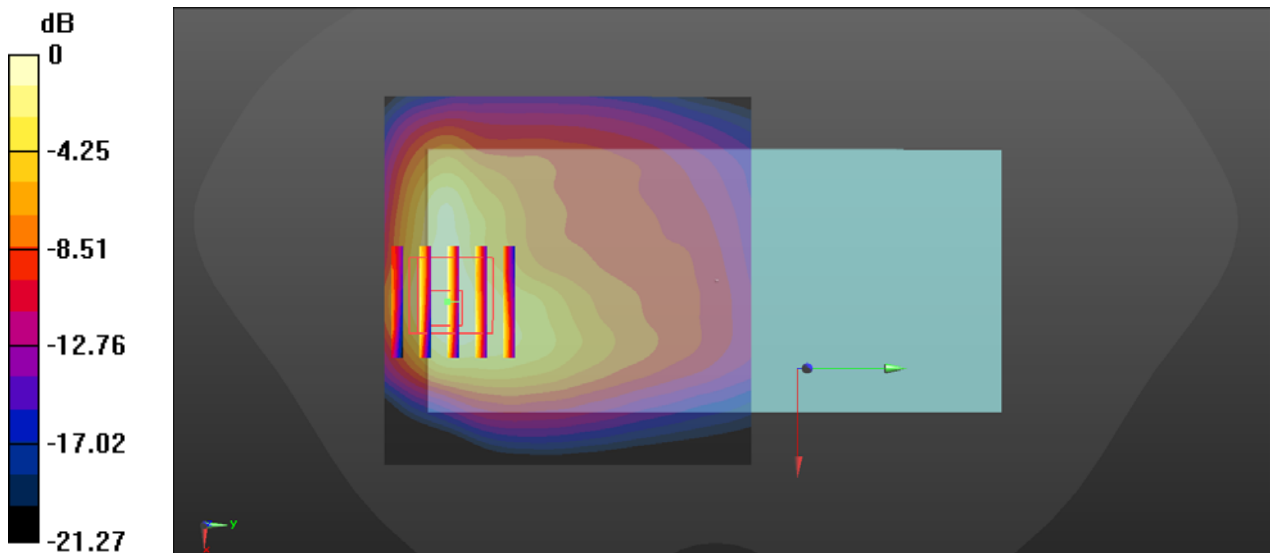

0 dB = 1.56 W/kg

### 35\_LTE Band 7\_20M\_QPSK\_1RB\_49Offset\_Back\_5mm\_Ch20850

Communication System: UID 0, LTE (0); Frequency: 2510 MHz; Duty Cycle: 1:1  
Medium: HSL\_2600\_201117 Medium parameters used:  $f = 2510$  MHz;  $\sigma = 1.823$  S/m;  $\epsilon_r = 40.148$ ;  
 $\rho = 1000$  kg/m<sup>3</sup>  
Ambient Temperature : 23.6 °C; Liquid Temperature : 22.3 °C

#### DASY5 Configuration:

- Probe: EX3DV4 - SN7577; ConvF(7.66, 7.66, 7.66); Calibrated: 2020.09.30
- Sensor-Surface: 1.4mm (Mechanical Surface Detection)
- Electronics: DAE4 Sn715; Calibrated: 2020.07.27
- Phantom: Twin-SAM1(P1aP2a20); Type: QD 000 P40 CD; Serial: TP:1670
- Measurement SW: DASY52, Version 52.10 (3); SEMCAD X Version 14.6.13 (7474)

**Ch20850/Area Scan (81x81x1):** Interpolated grid: dx=1.200 mm, dy=1.200 mm  
Maximum value of SAR (interpolated) = 1.70 W/kg

**Ch20850/Zoom Scan (8x8x7)/Cube 0:** Measurement grid: dx=5mm, dy=5mm, dz=5mm  
Reference Value = 3.814 V/m; Power Drift = 0.14 dB  
Peak SAR (extrapolated) = 2.35 W/kg  
**SAR(1 g) = 0.949 W/kg; SAR(10 g) = 0.393 W/kg**  
Maximum value of SAR (measured) = 1.77 W/kg

**Ch20850/Zoom Scan (8x8x7)/Cube 1:** Measurement grid: dx=5mm, dy=5mm, dz=5mm  
Reference Value = 3.814 V/m; Power Drift = 0.14 dB  
Peak SAR (extrapolated) = 2.24 W/kg  
**SAR(1 g) = 0.899 W/kg; SAR(10 g) = 0.384 W/kg**  
Maximum value of SAR (measured) = 1.68 W/kg

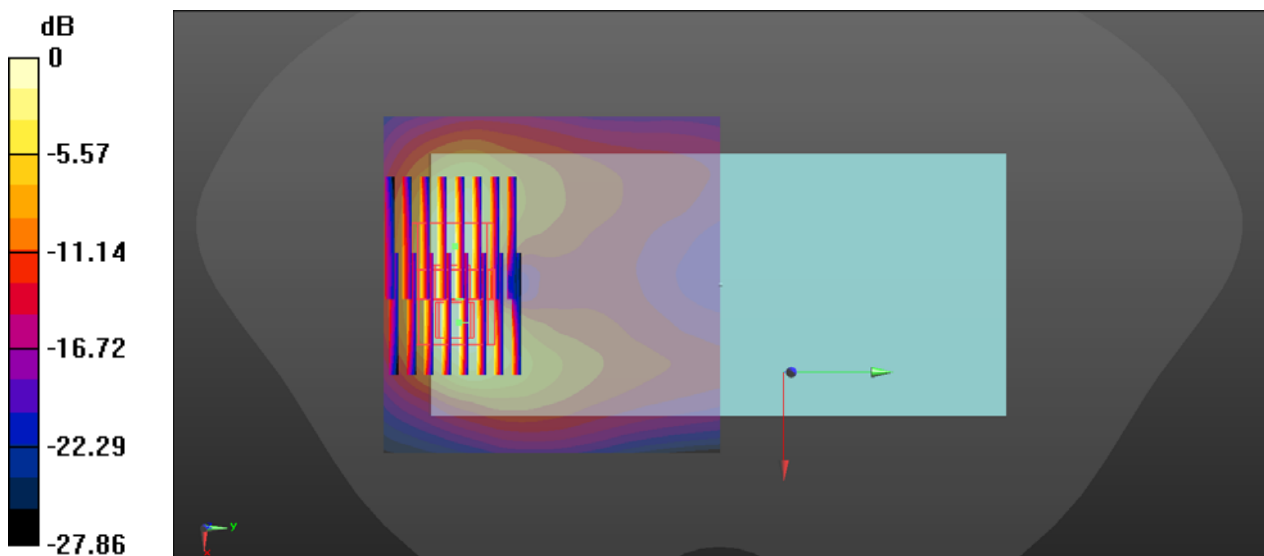

0 dB = 1.68 W/kg

### 36\_LTE Band 41\_20M\_QPSK\_1RB\_49Offset\_Back\_5mm\_Ch39750

Communication System: UID 0, LTE (0); Frequency: 2506 MHz; Duty Cycle: 1:1.59  
 Medium: HSL\_2600\_201117 Medium parameters used:  $f = 2506$  MHz;  $\sigma = 1.818$  S/m;  $\epsilon_r = 40.162$ ;  
 $\rho = 1000$  kg/m<sup>3</sup>  
 Ambient Temperature : 23.6 °C; Liquid Temperature : 22.3 °C

**DASY5 Configuration:**

- Probe: EX3DV4 - SN7577; ConvF(7.66, 7.66, 7.66); Calibrated: 2020.09.30
- Sensor-Surface: 1.4mm (Mechanical Surface Detection)
- Electronics: DAE4 Sn715; Calibrated: 2020.07.27
- Phantom: Twin-SAM1(P1aP2a20); Type: QD 000 P40 CD; Serial: TP:1670
- Measurement SW: DASY52, Version 52.10 (3); SEMCAD X Version 14.6.13 (7474)

**Ch39750/Area Scan (81x81x1):** Interpolated grid: dx=1.200 mm, dy=1.200 mm  
 Maximum value of SAR (interpolated) = 1.84 W/kg

**Ch39750/Zoom Scan (7x7x7)/Cube 0:** Measurement grid: dx=5mm, dy=5mm, dz=5mm  
 Reference Value = 4.140 V/m; Power Drift = -0.11 dB  
 Peak SAR (extrapolated) = 2.54 W/kg  
**SAR(1 g) = 1.05 W/kg; SAR(10 g) = 0.434 W/kg**  
 Maximum value of SAR (measured) = 1.95 W/kg

**Ch39750/Zoom Scan (7x7x7)/Cube 1:** Measurement grid: dx=5mm, dy=5mm, dz=5mm  
 Reference Value = 4.140 V/m; Power Drift = -0.11 dB  
 Peak SAR (extrapolated) = 2.35 W/kg  
**SAR(1 g) = 0.964 W/kg; SAR(10 g) = 0.414 W/kg**  
 Maximum value of SAR (measured) = 1.79 W/kg

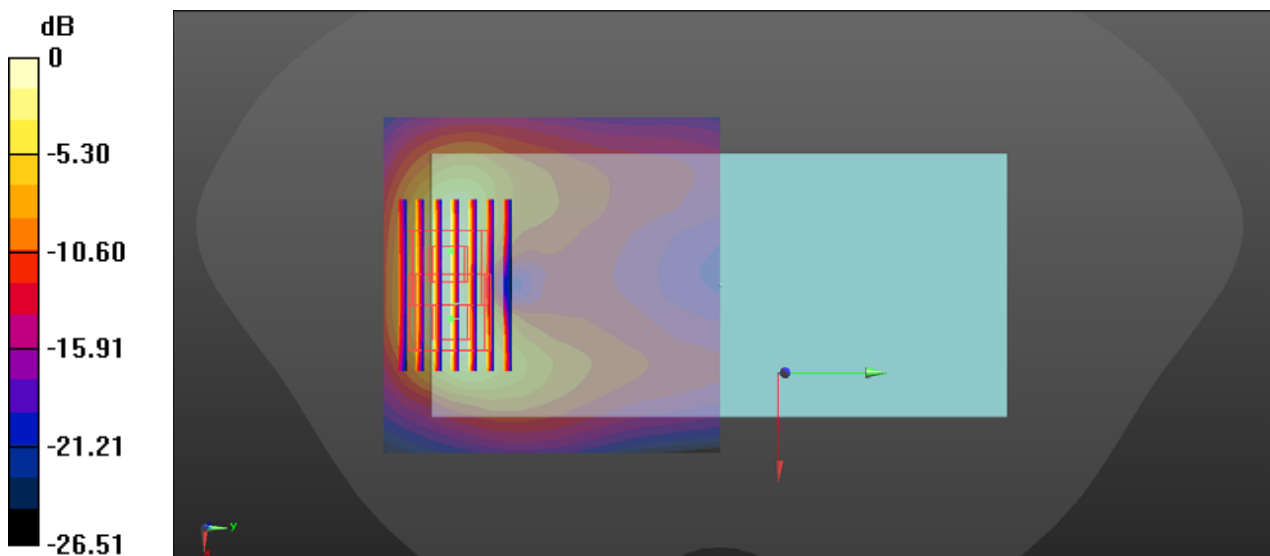

0 dB = 1.79 W/kg

### 37\_WLAN2.4GHz\_802.11b 1Mbps\_Back\_5mm\_Ch6

Communication System: UID 0, WIFI (0); Frequency: 2437 MHz; Duty Cycle: 1:1.007  
Medium: HSL\_2450\_201116 Medium parameters used:  $f = 2437$  MHz;  $\sigma = 1.851$  S/m;  $\epsilon_r = 37.563$ ;  
 $\rho = 1000$  kg/m<sup>3</sup>  
Ambient Temperature : 23.5 °C; Liquid Temperature : 22.6 °C

#### DASY5 Configuration:

- Probe: EX3DV4 - SN7577; ConvF(7.95, 7.95, 7.95); Calibrated: 2020.09.30
- Sensor-Surface: 1.4mm (Mechanical Surface Detection)
- Electronics: DAE4 Sn715; Calibrated: 2020.07.27
- Phantom: Twin-SAM1(P1aP2a20); Type: QD 000 P40 CD; Serial: TP:1670
- Measurement SW: DASY52, Version 52.10 (3); SEMCAD X Version 14.6.13 (7474)

**Ch6/Area Scan (81x81x1):** Interpolated grid: dx=1.200 mm, dy=1.200 mm  
Maximum value of SAR (interpolated) = 1.37 W/kg

**Ch6/Zoom Scan (7x7x7)/Cube 0:** Measurement grid: dx=5mm, dy=5mm, dz=5mm  
Reference Value = 7.817 V/m; Power Drift = 0.15 dB  
Peak SAR (extrapolated) = 1.83 W/kg  
**SAR(1 g) = 0.743 W/kg; SAR(10 g) = 0.349 W/kg**  
Maximum value of SAR (measured) = 1.33 W/kg

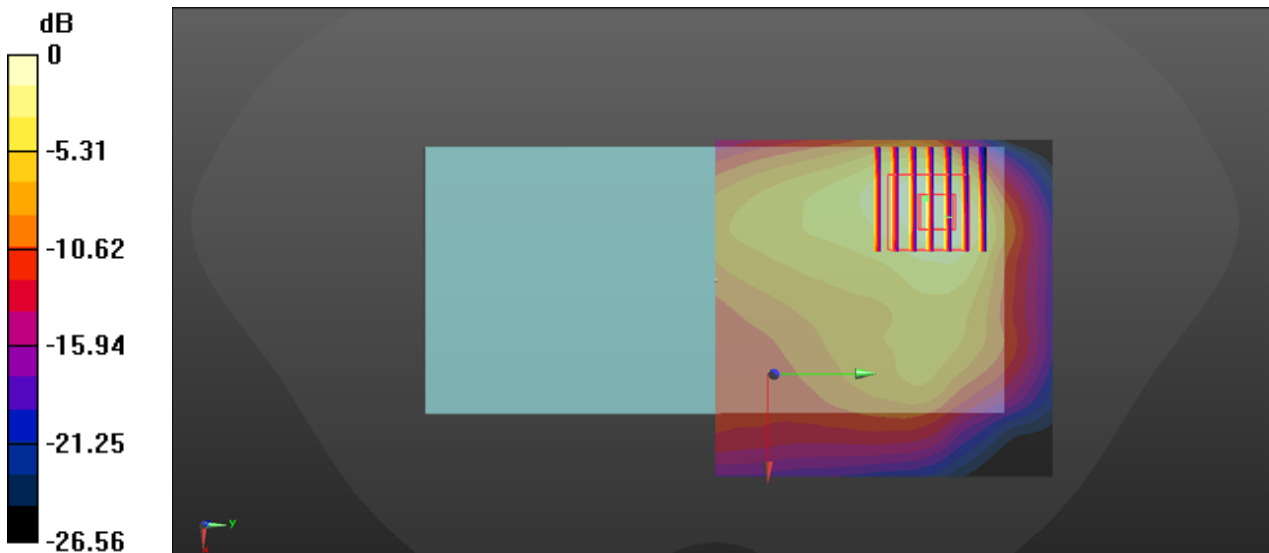

0 dB = 1.33 W/kg

### 38\_WLAN5GHz\_802.11n-HT40 MCS0\_Back\_5mm\_Ch54

Communication System: UID 0, WIFI (0); Frequency: 5270 MHz; Duty Cycle: 1:1.038  
Medium: HSL\_5250\_201118 Medium parameters used:  $f = 5270$  MHz;  $\sigma = 4.519$  S/m;  $\epsilon_r = 36.223$ ;  
 $\rho = 1000$  kg/m<sup>3</sup>  
Ambient Temperature : 23.3 °C; Liquid Temperature : 22.5 °C

#### DASY5 Configuration:

- Probe: EX3DV4 - SN7577; ConvF(5.4, 5.4, 5.4); Calibrated: 2020.09.30
- Sensor-Surface: 1.4mm (Mechanical Surface Detection)
- Electronics: DAE4 Sn715; Calibrated: 2020.07.27
- Phantom: Twin-SAM1(P1aP2a20); Type: QD 000 P40 CD; Serial: TP:1670
- Measurement SW: DASY52, Version 52.10 (3); SEMCAD X Version 14.6.13 (7474)

**Ch54/Area Scan (101x101x1):** Interpolated grid: dx=1.000 mm, dy=1.000 mm  
Maximum value of SAR (interpolated) = 1.63 W/kg

**Ch54/Zoom Scan (7x7x7)/Cube 0:** Measurement grid: dx=4mm, dy=4mm, dz=1.4mm  
Reference Value = 2.438 V/m; Power Drift = 0.14 dB  
Peak SAR (extrapolated) = 2.63 W/kg  
**SAR(1 g) = 0.669 W/kg; SAR(10 g) = 0.203 W/kg**  
Maximum value of SAR (measured) = 1.58 W/kg

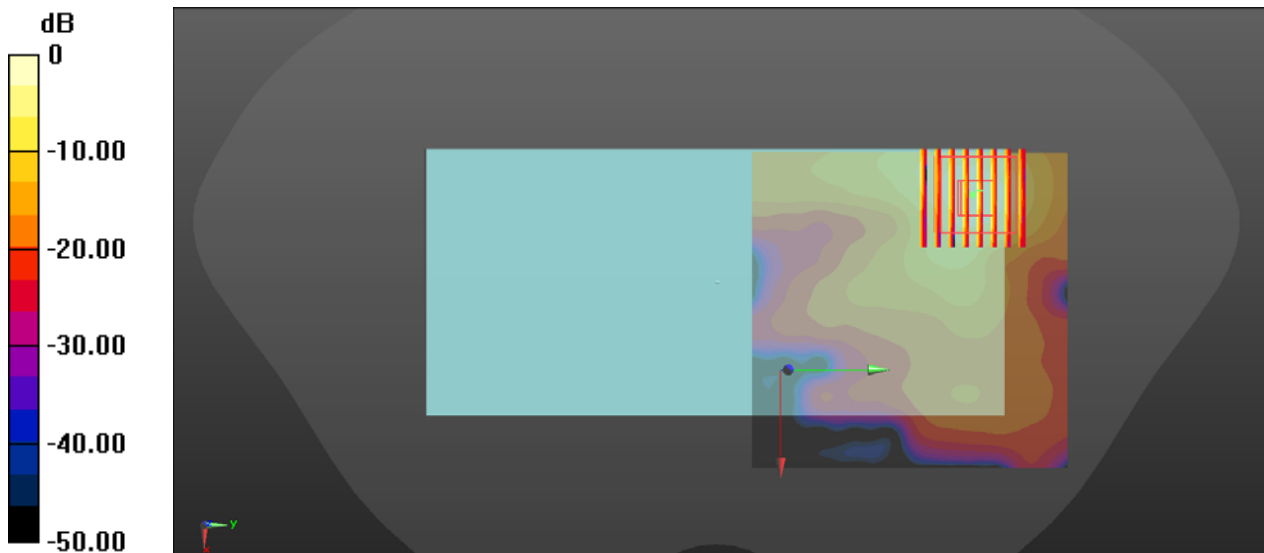

0 dB = 1.58 W/kg



### 39\_WLAN5GHz\_802.11ac-VHT80 MCS0\_Back\_5mm\_Ch122

Communication System: UID 0, WIFI (0); Frequency: 5610 MHz; Duty Cycle: 1:1.078  
 Medium: HSL\_5600\_201119 Medium parameters used:  $f = 5610 \text{ MHz}$ ;  $\sigma = 5.189 \text{ S/m}$ ;  $\epsilon_r = 35.839$ ;  
 $\rho = 1000 \text{ kg/m}^3$   
 Ambient Temperature : 23.4 °C; Liquid Temperature : 22.6 °C

**DASY5 Configuration:**

- Probe: EX3DV4 - SN7577; ConvF(4.79, 4.79, 4.79); Calibrated: 2020.09.30
- Sensor-Surface: 1.4mm (Mechanical Surface Detection)
- Electronics: DAE4 Sn715; Calibrated: 2020.07.27
- Phantom: Twin-SAM1(P1aP2a20); Type: QD 000 P40 CD; Serial: TP:1670
- Measurement SW: DASY52, Version 52.10 (3); SEMCAD X Version 14.6.13 (7474)

**Ch122/Area Scan (101x101x1):** Interpolated grid:  $dx=1.000 \text{ mm}$ ,  $dy=1.000 \text{ mm}$   
 Maximum value of SAR (interpolated) = 1.33 W/kg

**Ch122/Zoom Scan (7x7x7)/Cube 0:** Measurement grid:  $dx=4\text{mm}$ ,  $dy=4\text{mm}$ ,  $dz=1.4\text{mm}$   
 Reference Value = 1.092 V/m; Power Drift = 0.19 dB  
 Peak SAR (extrapolated) = 2.42 W/kg  
**SAR(1 g) = 0.586 W/kg; SAR(10 g) = 0.182 W/kg**  
 Maximum value of SAR (measured) = 1.43 W/kg

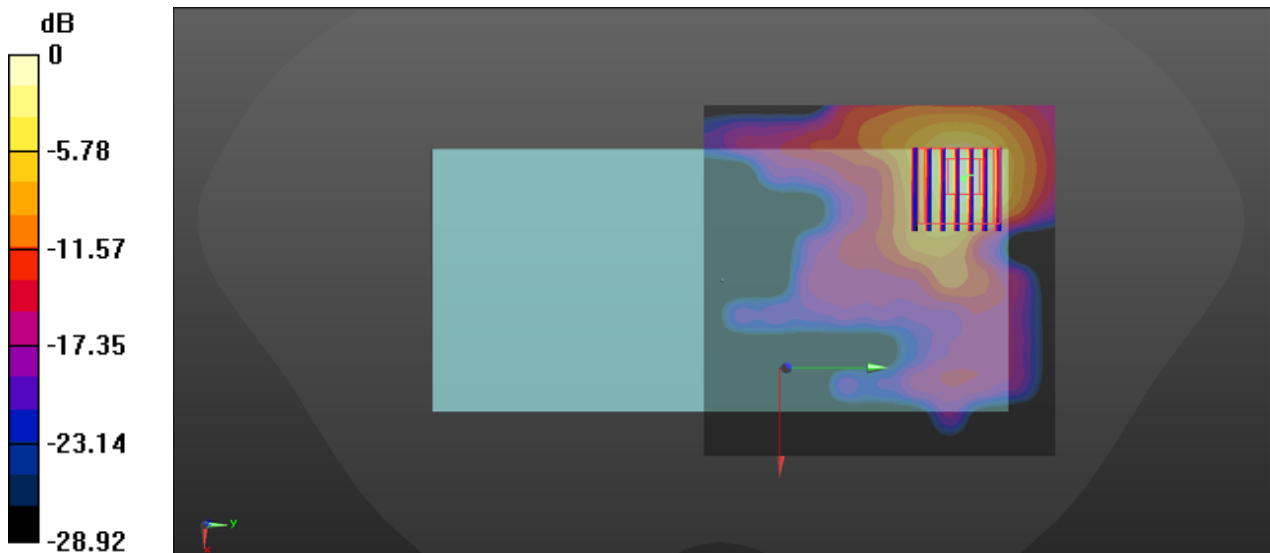

0 dB = 1.43 W/kg

### 40\_WLAN5GHz\_802.11ac-VHT80 MCS0\_Back\_5mm\_Ch155

Communication System: UID 0, WIFI (0); Frequency: 5775 MHz; Duty Cycle: 1:1.078  
Medium: HSL\_5750\_201120 Medium parameters used:  $f = 5775$  MHz;  $\sigma = 5.034$  S/m;  $\epsilon_r = 35.54$ ;  $\rho = 1000$  kg/m<sup>3</sup>  
Ambient Temperature : 23.5 °C; Liquid Temperature : 22.5 °C

#### DASY5 Configuration:

- Probe: EX3DV4 - SN7577; ConvF(5.02, 5.02, 5.02); Calibrated: 2020.09.30
- Sensor-Surface: 1.4mm (Mechanical Surface Detection)
- Electronics: DAE4 Sn715; Calibrated: 2020.07.27
- Phantom: Twin-SAM1(P1aP2a20); Type: QD 000 P40 CD; Serial: TP:1670
- Measurement SW: DASY52, Version 52.10 (3); SEMCAD X Version 14.6.13 (7474)

**Ch155/Area Scan (101x101x1):** Interpolated grid: dx=1.000 mm, dy=1.000 mm  
Maximum value of SAR (interpolated) = 1.08 W/kg

**Ch155/Zoom Scan (7x7x7)/Cube 0:** Measurement grid: dx=4mm, dy=4mm, dz=1.4mm  
Reference Value = 0.5530 V/m; Power Drift = 0.15 dB  
Peak SAR (extrapolated) = 1.87 W/kg  
**SAR(1 g) = 0.436 W/kg; SAR(10 g) = 0.131 W/kg**  
Maximum value of SAR (measured) = 1.10 W/kg

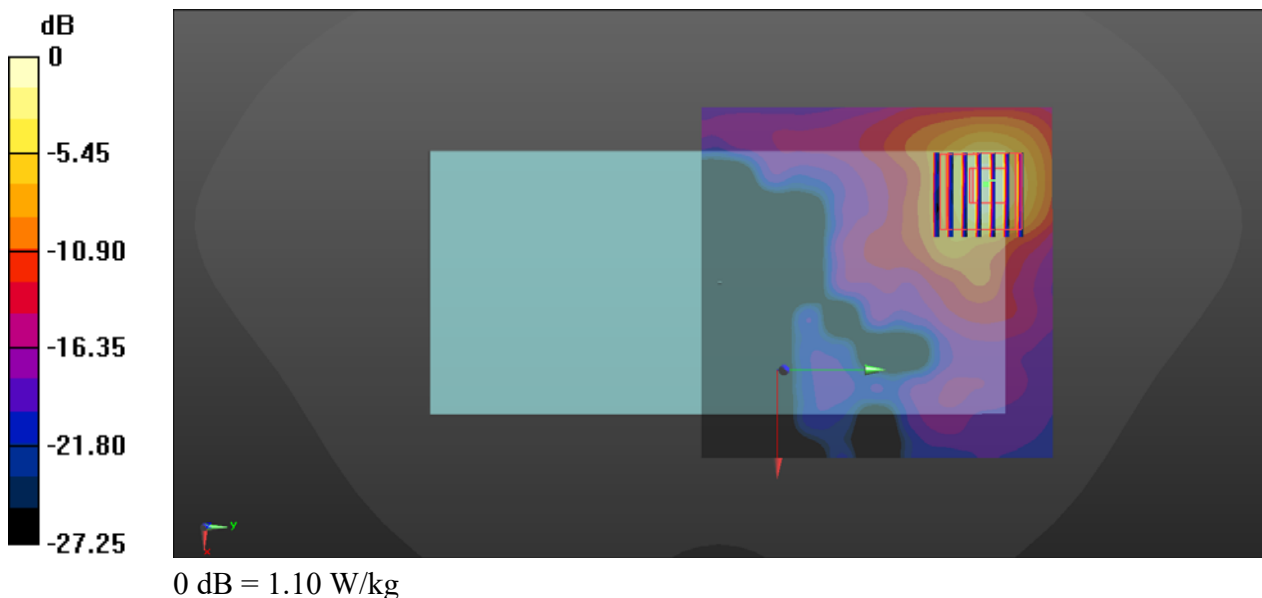

### 41\_Bluetooth\_DH5 1Mbps\_Back\_5mm\_Ch39

Communication System: UID 0, Bluetooth (0); Frequency: 2441 MHz; Duty Cycle: 1:1.293  
Medium: HSL\_2450\_201116 Medium parameters used:  $f = 2441 \text{ MHz}$ ;  $\sigma = 1.719 \text{ S/m}$ ;  $\epsilon_r = 40.81$ ;  $\rho = 1000 \text{ kg/m}^3$

Ambient Temperature : 23.5 °C; Liquid Temperature : 22.6 °C

#### DASY5 Configuration:

- Probe: EX3DV4 - SN7577; ConvF(7.95, 7.95, 7.95); Calibrated: 2020.09.30
- Sensor-Surface: 1.4mm (Mechanical Surface Detection)
- Electronics: DAE4 Sn715; Calibrated: 2020.07.27
- Phantom: Twin-SAM1(P1aP2a20); Type: QD 000 P40 CD; Serial: TP:1670
- Measurement SW: DASY52, Version 52.10 (3); SEMCAD X Version 14.6.13 (7474)

**Ch39/Area Scan (81x151x1):** Interpolated grid:  $dx=1.200 \text{ mm}$ ,  $dy=1.200 \text{ mm}$

Maximum value of SAR (interpolated) = 0.156 W/kg

**Ch39/Zoom Scan (7x7x7)/Cube 0:** Measurement grid:  $dx=5\text{mm}$ ,  $dy=5\text{mm}$ ,  $dz=5\text{mm}$

Reference Value = 2.594 V/m; Power Drift = 0.08 dB

Peak SAR (extrapolated) = 0.209 W/kg

**SAR(1 g) = 0.083 W/kg; SAR(10 g) = 0.038 W/kg**

Maximum value of SAR (measured) = 0.153 W/kg

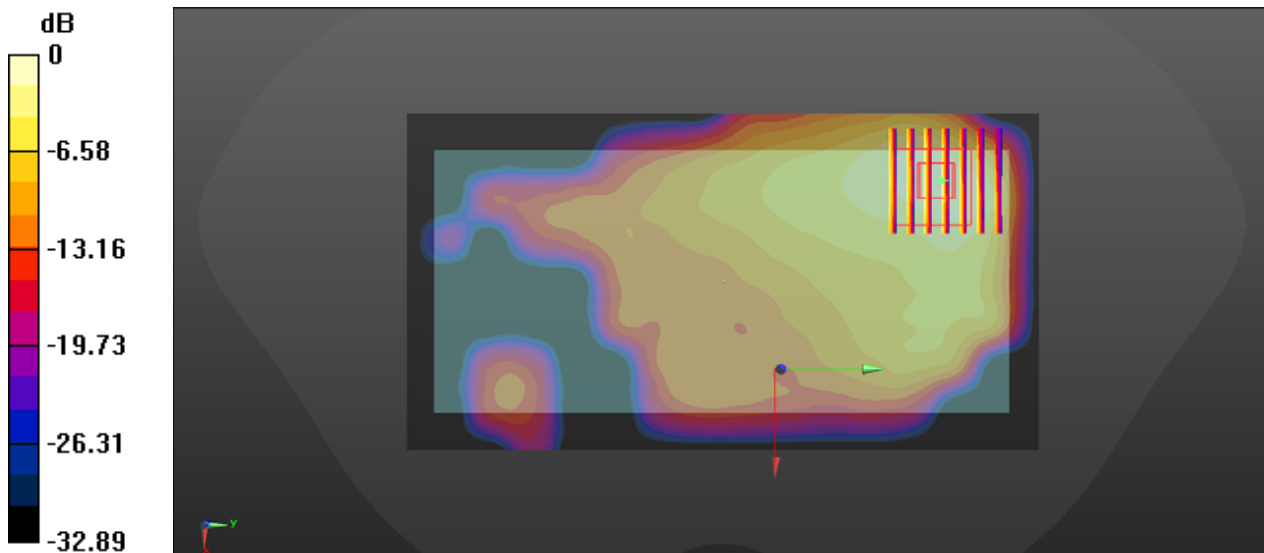

0 dB = 0.153 W/kg

## 42\_GSM850\_GPRS(2 Tx slots)\_Back\_0mm\_Ch251

Communication System: UID 0, GPRS/EDGE10 (0); Frequency: 848.8 MHz; Duty Cycle: 1:4.15  
Medium: HSL\_835\_201114 Medium parameters used:  $f = 849$  MHz;  $\sigma = 0.896$  S/m;  $\epsilon_r = 41.11$ ;  $\rho = 1000$  kg/m<sup>3</sup>

Ambient Temperature : 23.4 °C; Liquid Temperature : 22.5 °C

### DASY5 Configuration:

- Probe: EX3DV4 - SN7577; ConvF(9.54, 9.54, 9.54); Calibrated: 2020.09.30
- Sensor-Surface: 1.4mm (Mechanical Surface Detection)
- Electronics: DAE4 Sn715; Calibrated: 2020.07.27
- Phantom: Twin-SAM1(P1aP2a20); Type: QD 000 P40 CD; Serial: TP:1670
- Measurement SW: DASY52, Version 52.10 (3); SEMCAD X Version 14.6.13 (7474)

**Ch251/Area Scan (71x71x1):** Interpolated grid: dx=1.500 mm, dy=1.500 mm

Maximum value of SAR (interpolated) = 4.88 W/kg

**Ch251/Zoom Scan (5x5x7)/Cube 0:** Measurement grid: dx=8mm, dy=8mm, dz=5mm

Reference Value = 13.91 V/m; Power Drift = 0.04 dB

Peak SAR (extrapolated) = 15.6 W/kg

**SAR(1 g) = 4.47 W/kg; SAR(10 g) = 1.9 W/kg**

Maximum value of SAR (measured) = 10.8 W/kg

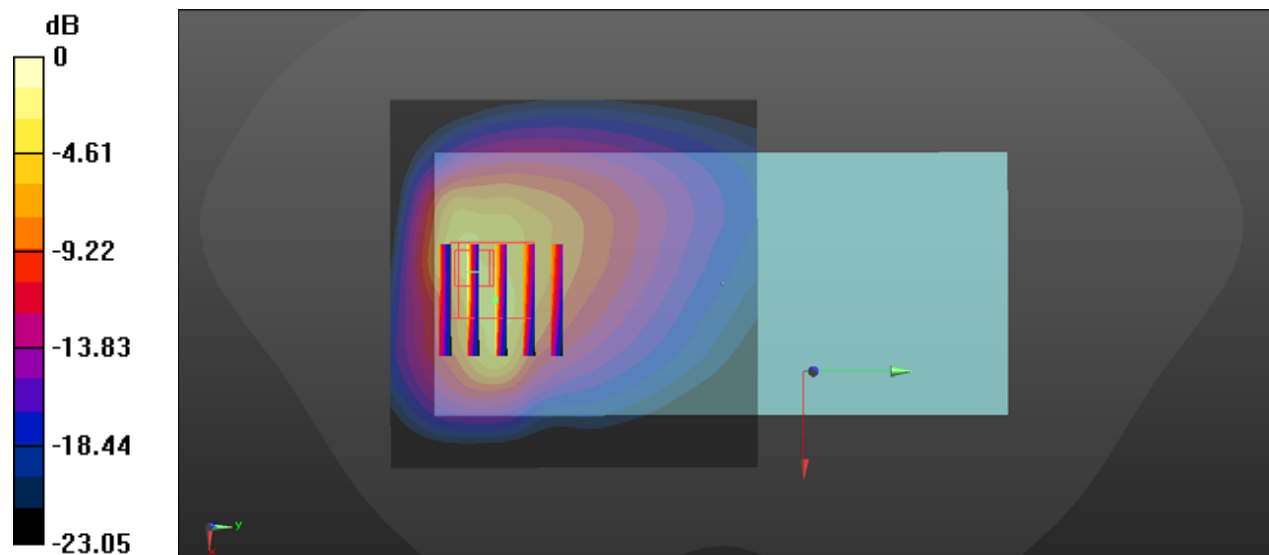

0 dB = 10.8 W/kg

### 43\_GSM1900\_GPRS(2 Tx slots)\_Bottom Side\_0mm\_Ch512

Communication System: UID 0, GPRS/EDGE10 (0); Frequency: 1850.2 MHz; Duty Cycle: 1:4.15  
Medium: HSL\_1900\_201115 Medium parameters used:  $f = 1850.2$  MHz;  $\sigma = 1.357$  S/m;  $\epsilon_r = 39.509$ ;  $\rho = 1000$  kg/m<sup>3</sup>  
Ambient Temperature : 23.6 °C; Liquid Temperature : 22.4 °C

#### DASY5 Configuration:

- Probe: EX3DV4 - SN7577; ConvF(8.34, 8.34, 8.34); Calibrated: 2020.09.30
- Sensor-Surface: 1.4mm (Mechanical Surface Detection)
- Electronics: DAE4 Sn715; Calibrated: 2020.07.27
- Phantom: Twin-SAM1(P1aP2a20); Type: QD 000 P40 CD; Serial: TP:1670
- Measurement SW: DASY52, Version 52.10 (3); SEMCAD X Version 14.6.13 (7474)

**Ch512/Area Scan (41x71x1):** Interpolated grid: dx=1.500 mm, dy=1.500 mm  
Maximum value of SAR (interpolated) = 9.81 W/kg

**Ch512/Zoom Scan (5x5x7)/Cube 0:** Measurement grid: dx=8mm, dy=8mm, dz=5mm  
Reference Value = 74.67 V/m; Power Drift = 0.08 dB  
Peak SAR (extrapolated) = 14.2 W/kg  
**SAR(1 g) = 5.18 W/kg; SAR(10 g) = 2.13 W/kg**  
Maximum value of SAR (measured) = 11.6 W/kg

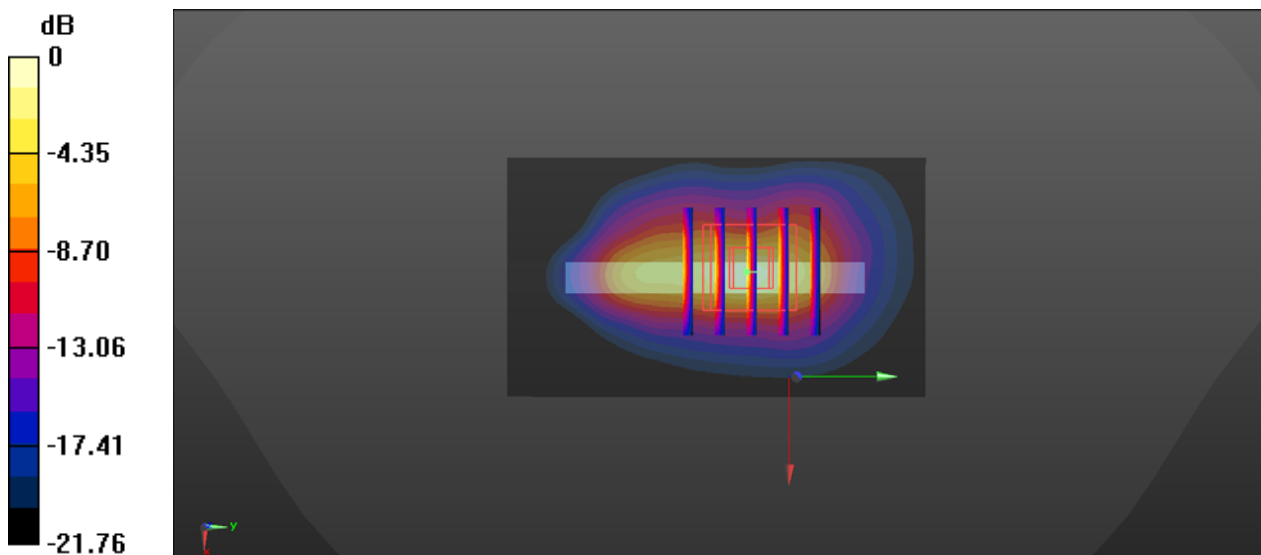

0 dB = 11.6 W/kg

### 44\_WCDMA V\_RMC 12.2Kbps\_Back\_0mm\_Ch4233

Communication System: UID 0, UMTS (0); Frequency: 846.6 MHz; Duty Cycle: 1:1  
 Medium: HSL\_835\_201114 Medium parameters used:  $f = 847 \text{ MHz}$ ;  $\sigma = 0.894 \text{ S/m}$ ;  $\epsilon_r = 41.133$ ;  $\rho = 1000 \text{ kg/m}^3$   
 Ambient Temperature : 23.4 °C; Liquid Temperature : 22.5 °C

**DASY5 Configuration:**

- Probe: EX3DV4 - SN7577; ConvF(9.54, 9.54, 9.54); Calibrated: 2020.09.30
- Sensor-Surface: 1.4mm (Mechanical Surface Detection)
- Electronics: DAE4 Sn715; Calibrated: 2020.07.27
- Phantom: Twin-SAM1(P1aP2a20); Type: QD 000 P40 CD; Serial: TP:1670
- Measurement SW: DASY52, Version 52.10 (3); SEMCAD X Version 14.6.13 (7474)

**Ch4233/Area Scan (71x71x1):** Interpolated grid:  $dx=1.500 \text{ mm}$ ,  $dy=1.500 \text{ mm}$   
 Maximum value of SAR (interpolated) = 10.1 W/kg

**Ch4233/Zoom Scan (5x5x7)/Cube 0:** Measurement grid:  $dx=8\text{mm}$ ,  $dy=8\text{mm}$ ,  $dz=5\text{mm}$   
 Reference Value = 14.62 V/m; Power Drift = 0.11 dB  
 Peak SAR (extrapolated) = 15.3 W/kg  
**SAR(1 g) = 4.9 W/kg; SAR(10 g) = 2.19 W/kg**  
 Maximum value of SAR (measured) = 8.38 W/kg

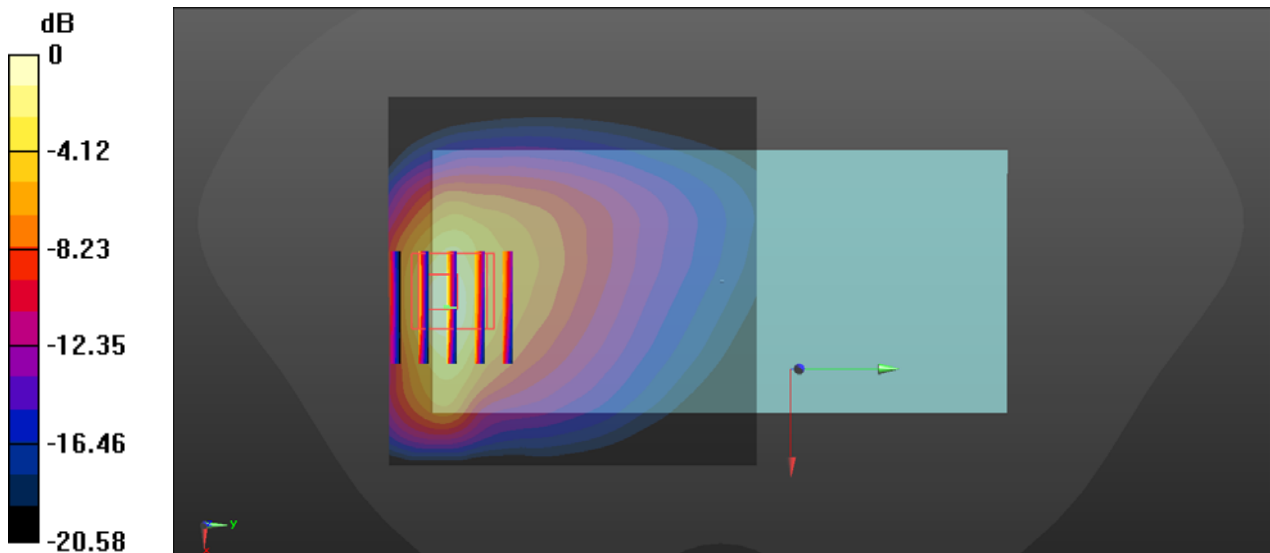

0 dB = 8.38 W/kg

### 45\_WCDMA II\_RMC 12.2Kbps\_Bottom Side\_0mm\_Ch9262

Communication System: UID 0, UMTS (0); Frequency: 1852.4 MHz; Duty Cycle: 1:1  
 Medium: HSL\_1900\_201115 Medium parameters used:  $f = 1852.4$  MHz;  $\sigma = 1.359$  S/m;  $\epsilon_r = 39.501$ ;  $\rho = 1000$  kg/m<sup>3</sup>  
 Ambient Temperature : 23.6 °C; Liquid Temperature : 22.4 °C

**DASY5 Configuration:**

- Probe: EX3DV4 - SN7577; ConvF(8.34, 8.34, 8.34); Calibrated: 2020.09.30
- Sensor-Surface: 1.4mm (Mechanical Surface Detection)
- Electronics: DAE4 Sn715; Calibrated: 2020.07.27
- Phantom: Twin-SAM1(P1aP2a20); Type: QD 000 P40 CD; Serial: TP:1670
- Measurement SW: DASY52, Version 52.10 (3); SEMCAD X Version 14.6.13 (7474)

**Ch9262/Area Scan (41x71x1):** Interpolated grid: dx=1.500 mm, dy=1.500 mm  
 Maximum value of SAR (interpolated) = 8.78 W/kg

**Ch9262/Zoom Scan (5x5x7)/Cube 0:** Measurement grid: dx=8mm, dy=8mm, dz=5mm  
 Reference Value = 72.42 V/m; Power Drift = 0.16 dB  
 Peak SAR (extrapolated) = 16.8 W/kg  
**SAR(1 g) = 6.18 W/kg; SAR(10 g) = 2.49 W/kg**  
 Maximum value of SAR (measured) = 13.6 W/kg

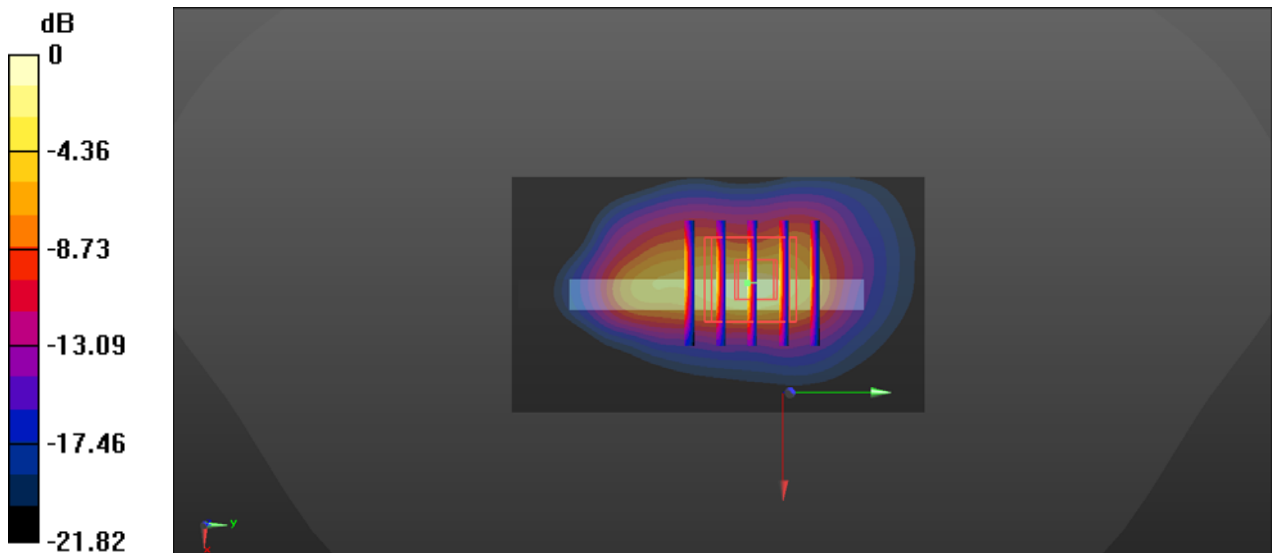

0 dB = 13.6 W/kg

### 46\_LTE Band 26\_15M\_QPSK\_1RB\_37Offset\_Back\_0mm\_Ch26965

Communication System: UID 0, LTE (0); Frequency: 841.5 MHz; Duty Cycle: 1:1  
Medium: HSL\_835\_201114 Medium parameters used:  $f = 841.5$  MHz;  $\sigma = 0.889$  S/m;  $\epsilon_r = 41.202$ ;  
 $\rho = 1000$  kg/m<sup>3</sup>  
Ambient Temperature : 23.4 °C; Liquid Temperature : 22.5 °C

#### DASY5 Configuration:

- Probe: EX3DV4 - SN7577; ConvF(9.54, 9.54, 9.54); Calibrated: 2020.09.30
- Sensor-Surface: 1.4mm (Mechanical Surface Detection)
- Electronics: DAE4 Sn715; Calibrated: 2020.07.27
- Phantom: Twin-SAM1(P1aP2a20); Type: QD 000 P40 CD; Serial: TP:1670
- Measurement SW: DASY52, Version 52.10 (3); SEMCAD X Version 14.6.13 (7474)

**Ch26965/Area Scan (71x71x1):** Interpolated grid: dx=1.500 mm, dy=1.500 mm  
Maximum value of SAR (interpolated) = 9.62 W/kg

**Ch26965/Zoom Scan (5x5x7)/Cube 0:** Measurement grid: dx=8mm, dy=8mm, dz=5mm  
Reference Value = 17.38 V/m; Power Drift = -0.03 dB  
Peak SAR (extrapolated) = 12.9 W/kg  
**SAR(1 g) = 4.4 W/kg; SAR(10 g) = 2.05 W/kg**  
Maximum value of SAR (measured) = 9.19 W/kg

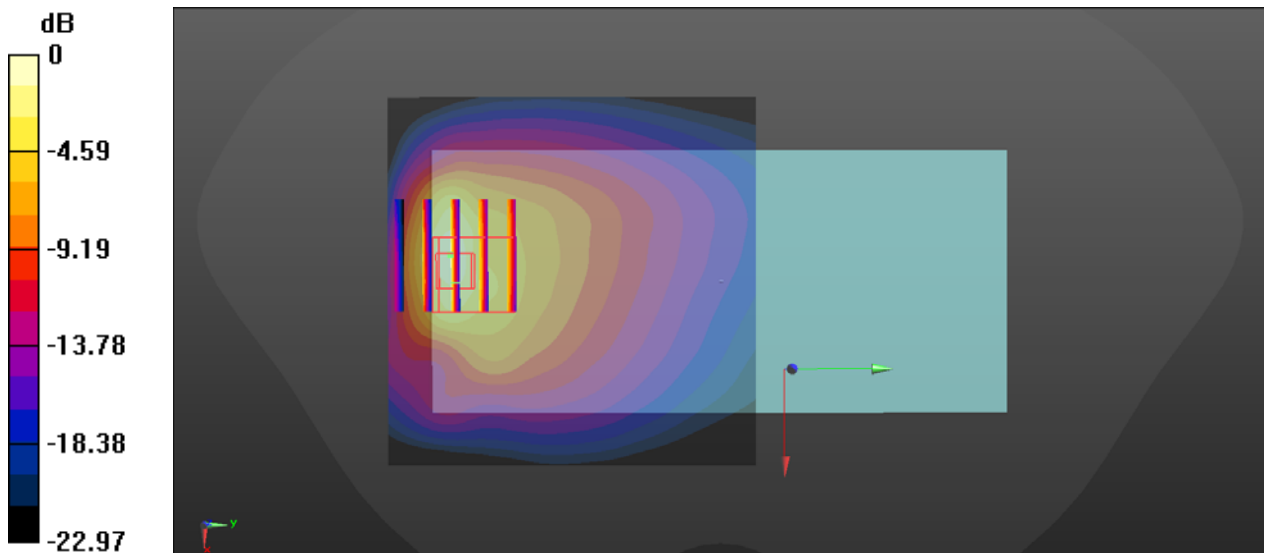

0 dB = 9.19 W/kg



### 47\_LTE Band 2\_20M\_QPSK\_50RB\_0Offset\_Bottom Side\_0mm\_Ch18700

Communication System: UID 0, LTE (0); Frequency: 1860 MHz; Duty Cycle: 1:1  
Medium: HSL\_1900\_201115 Medium parameters used:  $f = 1860$  MHz;  $\sigma = 1.366$  S/m;  $\epsilon_r = 39.475$ ;  
 $\rho = 1000$  kg/m<sup>3</sup>  
Ambient Temperature : 23.6 °C; Liquid Temperature : 22.4 °C

#### DASY5 Configuration:

- Probe: EX3DV4 - SN7577; ConvF(8.34, 8.34, 8.34); Calibrated: 2020.09.30
- Sensor-Surface: 1.4mm (Mechanical Surface Detection)
- Electronics: DAE4 Sn715; Calibrated: 2020.07.27
- Phantom: Twin-SAM1(P1aP2a20); Type: QD 000 P40 CD; Serial: TP:1670
- Measurement SW: DASY52, Version 52.10 (3); SEMCAD X Version 14.6.13 (7474)

**Ch18700/Area Scan (41x71x1):** Interpolated grid: dx=1.500 mm, dy=1.500 mm  
Maximum value of SAR (interpolated) = 14.5 W/kg

**Ch18700/Zoom Scan (5x5x7)/Cube 0:** Measurement grid: dx=8mm, dy=8mm, dz=5mm  
Reference Value = 1.082 V/m; Power Drift = 0.13 dB  
Peak SAR (extrapolated) = 18.3 W/kg  
**SAR(1 g) = 6.27 W/kg; SAR(10 g) = 2.45 W/kg**  
Maximum value of SAR (measured) = 14.7 W/kg

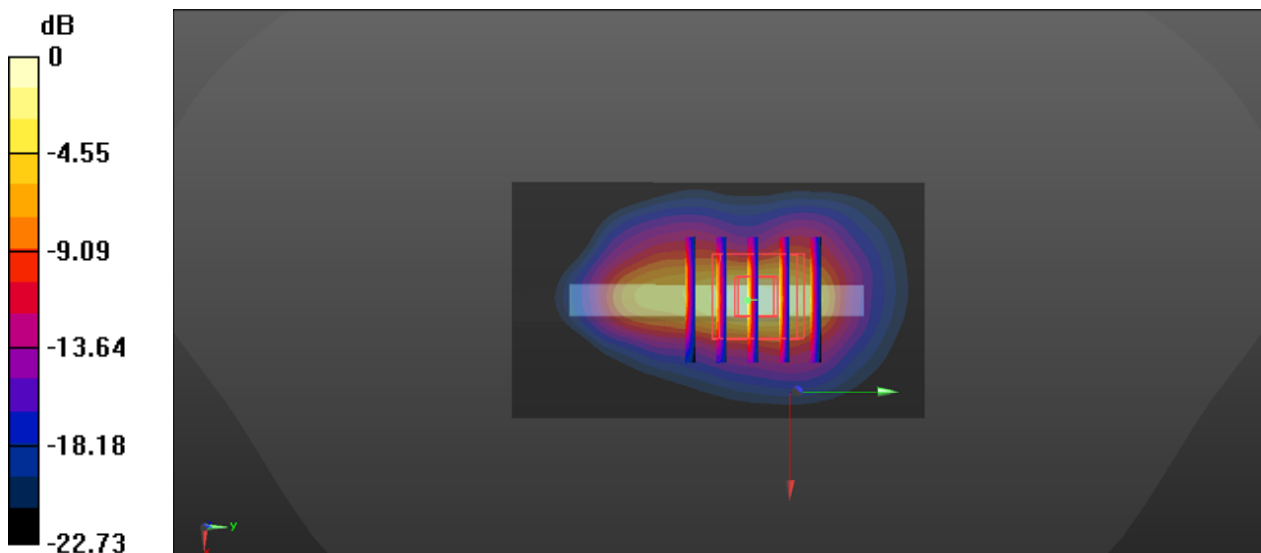

0 dB = 14.7 W/kg

### 48\_LTE Band 7\_20M\_QPSK\_1RB\_49Offset\_Back\_0mm\_Ch20850

Communication System: UID 0, LTE (0); Frequency: 2510 MHz; Duty Cycle: 1:1  
Medium: HSL\_2600\_201117 Medium parameters used:  $f = 2510$  MHz;  $\sigma = 1.823$  S/m;  $\epsilon_r = 40.148$ ;  
 $\rho = 1000$  kg/m<sup>3</sup>  
Ambient Temperature : 23.6 °C; Liquid Temperature : 22.3 °C

#### DASY5 Configuration:

- Probe: EX3DV4 - SN7577; ConvF(7.66, 7.66, 7.66); Calibrated: 2020.09.30
- Sensor-Surface: 1.4mm (Mechanical Surface Detection)
- Electronics: DAE4 Sn715; Calibrated: 2020.07.27
- Phantom: Twin-SAM1(P1aP2a20); Type: QD 000 P40 CD; Serial: TP:1670
- Measurement SW: DASY52, Version 52.10 (3); SEMCAD X Version 14.6.13 (7474)

**Ch20850/Area Scan (81x51x1):** Interpolated grid: dx=1.200 mm, dy=1.200 mm  
Maximum value of SAR (interpolated) = 15.5 W/kg

**Ch20850/Zoom Scan (7x7x7)/Cube 0:** Measurement grid: dx=5mm, dy=5mm, dz=5mm  
Reference Value = 1.865 V/m; Power Drift = 0.05 dB  
Peak SAR (extrapolated) = 20.8 W/kg  
**SAR(1 g) = 7.1 W/kg; SAR(10 g) = 2.4 W/kg**  
Maximum value of SAR (measured) = 14.6 W/kg

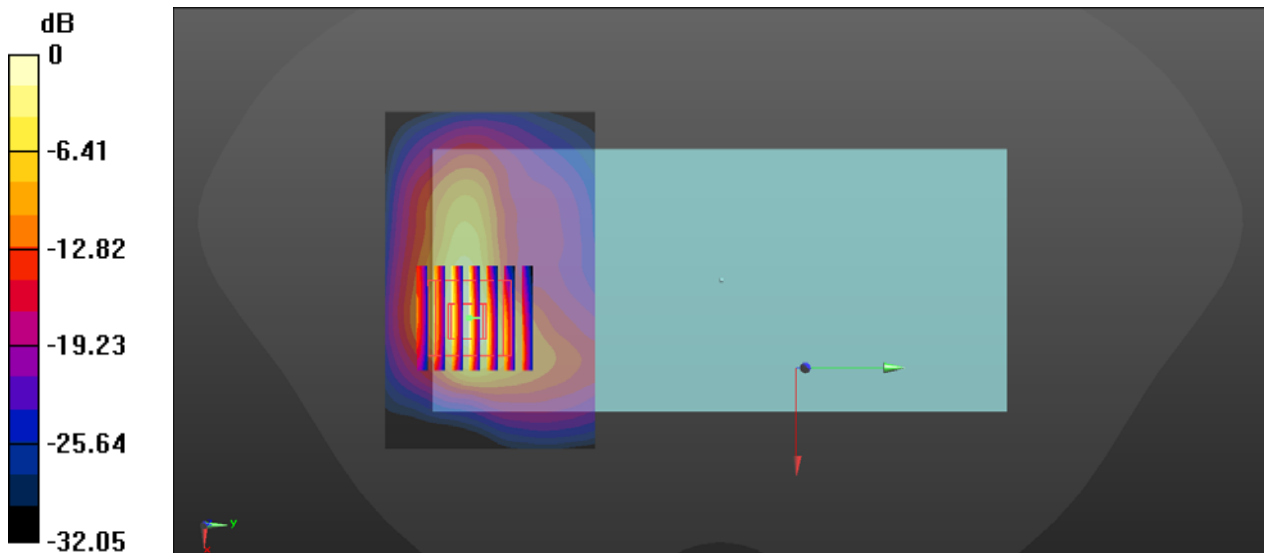

0 dB = 14.6 W/kg

### 49\_LTE Band 41\_20M\_QPSK\_1RB\_49Offset\_Back\_0mm\_Ch39750

Communication System: UID 0, LTE (0); Frequency: 2506 MHz; Duty Cycle: 1:1.59  
Medium: HSL\_2600\_201117 Medium parameters used:  $f = 2506$  MHz;  $\sigma = 1.818$  S/m;  $\epsilon_r = 40.162$ ;  
 $\rho = 1000$  kg/m<sup>3</sup>  
Ambient Temperature : 23.6 °C; Liquid Temperature : 22.3 °C

#### DASY5 Configuration:

- Probe: EX3DV4 - SN7577; ConvF(7.66, 7.66, 7.66); Calibrated: 2020.09.30
- Sensor-Surface: 1.4mm (Mechanical Surface Detection)
- Electronics: DAE4 Sn715; Calibrated: 2020.07.27
- Phantom: Twin-SAM1(P1aP2a20); Type: QD 000 P40 CD; Serial: TP:1670
- Measurement SW: DASY52, Version 52.10 (3); SEMCAD X Version 14.6.13 (7474)

**Ch39750/Area Scan (81x101x1):** Interpolated grid: dx=1.200 mm, dy=1.200 mm  
Maximum value of SAR (interpolated) = 11.7 W/kg

**Ch39750/Zoom Scan (7x7x7)/Cube 0:** Measurement grid: dx=5mm, dy=5mm, dz=5mm  
Reference Value = 1.826 V/m; Power Drift = 0.09 dB  
Peak SAR (extrapolated) = 20.1 W/kg  
**SAR(1 g) = 7.27 W/kg; SAR(10 g) = 2.51 W/kg**  
Maximum value of SAR (measured) = 15.0 W/kg

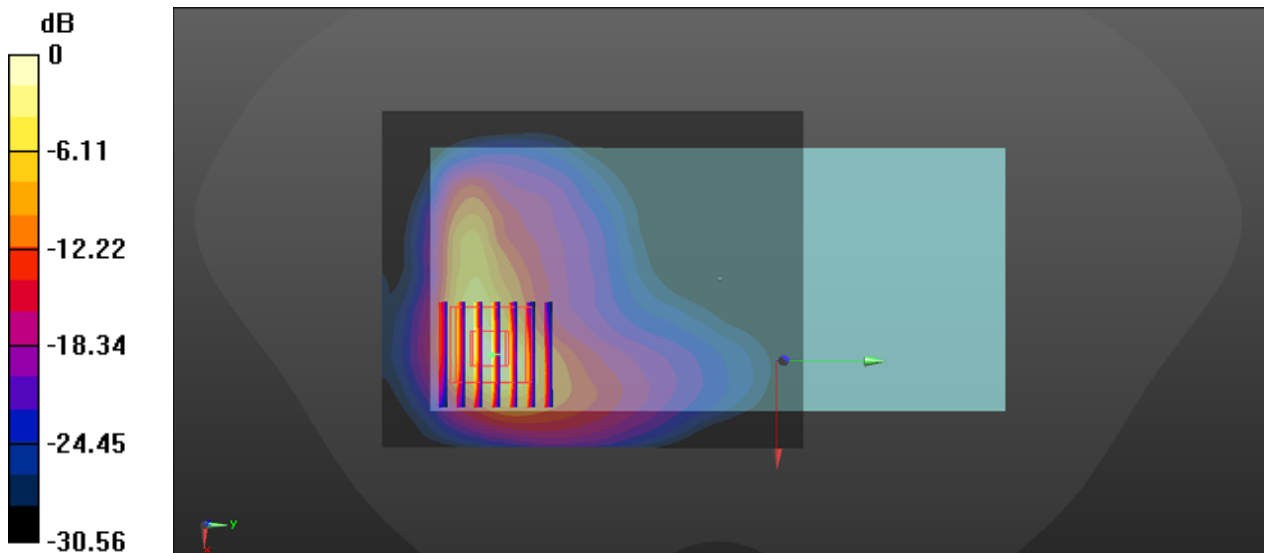

0 dB = 15.0 W/kg

### 50\_WLAN5GHz\_802.11n-HT40 MCS0\_Top Side\_0mm\_Ch54

Communication System: UID 0, WIFI (0); Frequency: 5270 MHz; Duty Cycle: 1:1.038  
Medium: HSL\_5250\_201118 Medium parameters used:  $f = 5270$  MHz;  $\sigma = 4.519$  S/m;  $\epsilon_r = 36.223$ ;  
 $\rho = 1000$  kg/m<sup>3</sup>  
Ambient Temperature : 23.3 °C; Liquid Temperature : 22.5 °C

#### DASY5 Configuration:

- Probe: EX3DV4 - SN7577; ConvF(5.4, 5.4, 5.4); Calibrated: 2020.09.30
- Sensor-Surface: 1.4mm (Mechanical Surface Detection)
- Electronics: DAE4 Sn715; Calibrated: 2020.07.27
- Phantom: Twin-SAM1(P1aP2a20); Type: QD 000 P40 CD; Serial: TP:1670
- Measurement SW: DASY52, Version 52.10 (3); SEMCAD X Version 14.6.13 (7474)

**Ch54/Area Scan (41x101x1):** Interpolated grid: dx=1.000 mm, dy=1.000 mm  
Maximum value of SAR (interpolated) = 8.69 W/kg

**Ch54/Zoom Scan (7x7x7)/Cube 0:** Measurement grid: dx=4mm, dy=4mm, dz=1.4mm  
Reference Value = 6.604 V/m; Power Drift = 0.13 dB  
Peak SAR (extrapolated) = 15.6 W/kg  
**SAR(1 g) = 2.77 W/kg; SAR(10 g) = 0.628 W/kg**  
Maximum value of SAR (measured) = 7.32 W/kg

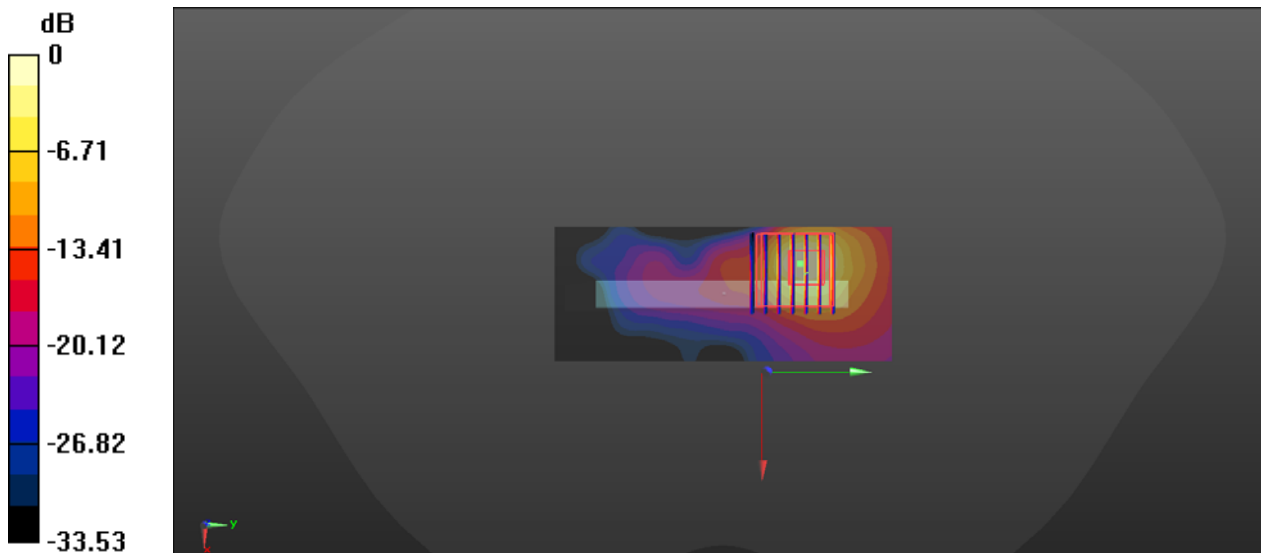

0 dB = 7.32 W/kg

### 51\_WLAN5GHz\_802.11ac-VHT80 MCS0\_Top Side\_0mm\_Ch122

Communication System: UID 0, WIFI (0); Frequency: 5610 MHz; Duty Cycle: 1:1.078  
Medium: HSL\_5600\_201119 Medium parameters used:  $f = 5610$  MHz;  $\sigma = 4.997$  S/m;  $\epsilon_r = 36.103$ ;  
 $\rho = 1000$  kg/m<sup>3</sup>  
Ambient Temperature : 23.4 °C; Liquid Temperature : 22.6 °C

#### DASY5 Configuration:

- Probe: EX3DV4 - SN7577; ConvF(4.79, 4.79, 4.79); Calibrated: 2020.09.30
- Sensor-Surface: 1.4mm (Mechanical Surface Detection)
- Electronics: DAE4 Sn715; Calibrated: 2020.07.27
- Phantom: Twin-SAM1(P1aP2a20); Type: QD 000 P40 CD; Serial: TP:1670
- Measurement SW: DASY52, Version 52.10 (3); SEMCAD X Version 14.6.13 (7474)

**Ch122/Area Scan (51x101x1):** Interpolated grid: dx=1.000 mm, dy=1.000 mm  
Maximum value of SAR (interpolated) = 16.5 W/kg

**Ch122/Zoom Scan (8x8x7)/Cube 0:** Measurement grid: dx=4mm, dy=4mm, dz=1.4mm  
Reference Value = 18.77 V/m; Power Drift = 0.06 dB  
Peak SAR (extrapolated) = 47.7 W/kg  
**SAR(1 g) = 6.03 W/kg; SAR(10 g) = 1.48 W/kg**  
Maximum value of SAR (measured) = 20.3 W/kg

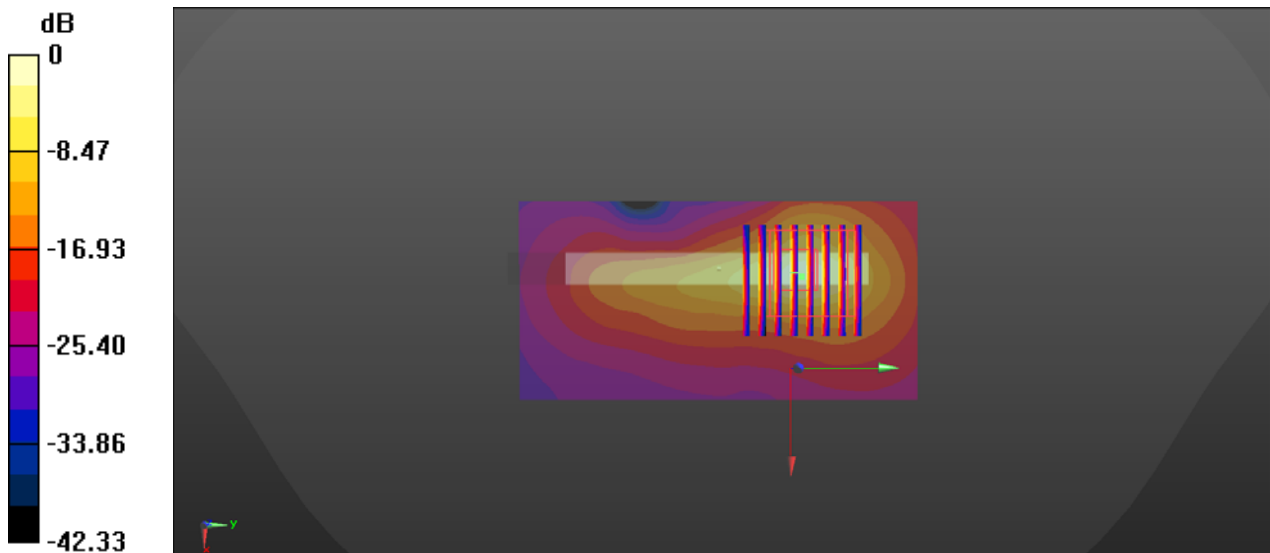

0 dB = 20.3 W/kg



**Appendix C. DASYS Calibration Certificate**

The DASYS calibration certificates are shown as follows.



In Collaboration with  
**s p e a g**  
CALIBRATION LABORATORY



中国认可  
国际互认  
校准  
CALIBRATION  
CNAS L0570

Add: No.51 Xueyuan Road, Haidian District, Beijing, 100191, China  
Tel: +86-10-62304633-2079 Fax: +86-10-62304633-2504  
E-mail: cttl@chinattl.com http://www.chinattl.cn

Client **Sporton**

Certificate No: **Z18-60533**

## CALIBRATION CERTIFICATE

Object **D835V2 - SN: 4d162**

Calibration Procedure(s) **FF-Z11-003-01**  
**Calibration Procedures for dipole validation kits**

Calibration date: **December 5, 2018**

This calibration Certificate documents the traceability to national standards, which realize the physical units of measurements(SI). The measurements and the uncertainties with confidence probability are given on the following pages and are part of the certificate.

All calibrations have been conducted in the closed laboratory facility: environment temperature(22±3)°C and humidity<70%.

Calibration Equipment used (M&TE critical for calibration)

Primary Standards	ID #	Cal Date(Calibrated by, Certificate No.)	Scheduled Calibration
Power Meter NRVD	102196	07-Mar-18 (CTTL, No.J18X01510)	Mar-19
Power sensor NRV-Z5	100596	07-Mar-18 (CTTL, No.J18X01510)	Mar-19
Reference Probe EX3DV4	SN 7514	27-Aug-18(SPEAG,No.EX3-7514_Aug18)	Aug-19
DAE4	SN 1555	20-Aug-18(SPEAG,No.DAE4-1555_Aug18)	Aug-19
Secondary Standards	ID #	Cal Date(Calibrated by, Certificate No.)	Scheduled Calibration
Signal Generator E4438C	MY49071430	23-Jan-18 (CTTL, No.J18X00560)	Jan-19
NetworkAnalyzer E5071C	MY46110673	24-Jan-18 (CTTL, No.J18X00561)	Jan-19

	Name	Function	Signature
Calibrated by:	Zhao Jing	SAR Test Engineer	
Reviewed by:	Lin Hao	SAR Test Engineer	
Approved by:	Qi Dianyuan	SAR Project Leader	

Issued: December 8, 2018

This calibration certificate shall not be reproduced except in full without written approval of the laboratory.



Add: No.51 Xueyuan Road, Haidian District, Beijing, 100191, China  
Tel: +86-10-62304633-2079 Fax: +86-10-62304633-2504  
E-mail: cttl@chinattl.com http://www.chinattl.cn

### Glossary:

TSL	tissue simulating liquid
ConvF	sensitivity in TSL / NORM <sub>x,y,z</sub>
N/A	not applicable or not measured

### Calibration is Performed According to the Following Standards:

- IEEE Std 1528-2013, "IEEE Recommended Practice for Determining the Peak Spatial-Averaged Specific Absorption Rate (SAR) in the Human Head from Wireless Communications Devices: Measurement Techniques", June 2013
- IEC 62209-1, "Measurement procedure for assessment of specific absorption rate of human exposure to radio frequency fields from hand-held and body-mounted wireless communication devices- Part 1: Device used next to the ear (Frequency range of 300MHz to 6GHz)", July 2016
- IEC 62209-2, "Procedure to measure the Specific Absorption Rate (SAR) For wireless communication devices used in close proximity to the human body (frequency range of 30MHz to 6GHz)", March 2010
- KDB865664, SAR Measurement Requirements for 100 MHz to 6 GHz

### Additional Documentation:

- DASY4/5 System Handbook

### Methods Applied and Interpretation of Parameters:

- Measurement Conditions:** Further details are available from the Validation Report at the end of the certificate. All figures stated in the certificate are valid at the frequency indicated.
- Antenna Parameters with TSL:** The dipole is mounted with the spacer to position its feed point exactly below the center marking of the flat phantom section, with the arms oriented parallel to the body axis.
- Feed Point Impedance and Return Loss:** These parameters are measured with the dipole positioned under the liquid filled phantom. The impedance stated is transformed from the measurement at the SMA connector to the feed point. The Return Loss ensures low reflected power. No uncertainty required.
- Electrical Delay:** One-way delay between the SMA connector and the antenna feed point. No uncertainty required.
- SAR measured:** SAR measured at the stated antenna input power.
- SAR normalized:** SAR as measured, normalized to an input power of 1 W at the antenna connector.
- SAR for nominal TSL parameters:** The measured TSL parameters are used to calculate the nominal SAR result.

The reported uncertainty of measurement is stated as the standard uncertainty of Measurement multiplied by the coverage factor  $k=2$ , which for a normal distribution Corresponds to a coverage probability of approximately 95%.





Add: No.51 Xueyuan Road, Haidian District, Beijing, 100191, China  
 Tel: +86-10-62304633-2079 Fax: +86-10-62304633-2504  
 E-mail: cttl@chinattl.com http://www.chinattl.cn

### Measurement Conditions

DASY system configuration, as far as not given on page 1.

DASY Version	DASY52	52.10.2.1495
Extrapolation	Advanced Extrapolation	
Phantom	Triple Flat Phantom 5.1C	
Distance Dipole Center - TSL	15 mm	with Spacer
Zoom Scan Resolution	dx, dy, dz = 5 mm	
Frequency	835 MHz ± 1 MHz	

### Head TSL parameters

The following parameters and calculations were applied.

	Temperature	Permittivity	Conductivity
Nominal Head TSL parameters	22.0 °C	41.5	0.90 mho/m
Measured Head TSL parameters	(22.0 ± 0.2) °C	42.7 ± 6 %	0.88 mho/m ± 6 %
Head TSL temperature change during test	<1.0 °C	----	----

### SAR result with Head TSL

SAR averaged over 1 cm <sup>3</sup> (1 g) of Head TSL	Condition	
SAR measured	250 mW input power	2.35 mW / g
SAR for nominal Head TSL parameters	normalized to 1W	9.61 mW / g ± 18.8 % (k=2)
SAR averaged over 10 cm <sup>3</sup> (10 g) of Head TSL	Condition	
SAR measured	250 mW input power	1.56 mW / g
SAR for nominal Head TSL parameters	normalized to 1W	6.35 mW / g ± 18.7 % (k=2)

### Body TSL parameters

The following parameters and calculations were applied.

	Temperature	Permittivity	Conductivity
Nominal Body TSL parameters	22.0 °C	55.2	0.97 mho/m
Measured Body TSL parameters	(22.0 ± 0.2) °C	53.7 ± 6 %	0.99 mho/m ± 6 %
Body TSL temperature change during test	<1.0 °C	----	----

### SAR result with Body TSL

SAR averaged over 1 cm <sup>3</sup> (1 g) of Body TSL	Condition	
SAR measured	250 mW input power	2.47 mW / g
SAR for nominal Body TSL parameters	normalized to 1W	9.70 mW / g ± 18.8 % (k=2)
SAR averaged over 10 cm <sup>3</sup> (10 g) of Body TSL	Condition	
SAR measured	250 mW input power	1.64 mW / g
SAR for nominal Body TSL parameters	normalized to 1W	6.47 mW / g ± 18.7 % (k=2)



Add: No.51 Xueyuan Road, Haidian District, Beijing, 100191, China  
 Tel: +86-10-62304633-2079 Fax: +86-10-62304633-2504  
 E-mail: cttl@chinattl.com http://www.chinattl.cn

**Appendix (Additional assessments outside the scope of CNAS L0570)**

**Antenna Parameters with Head TSL**

Impedance, transformed to feed point	52.6Ω- 2.56jΩ
Return Loss	- 28.9dB

**Antenna Parameters with Body TSL**

Impedance, transformed to feed point	47.2Ω- 6.92jΩ
Return Loss	- 22.3dB

**General Antenna Parameters and Design**

Electrical Delay (one direction)	1.306 ns
----------------------------------	----------

After long term use with 100W radiated power, only a slight warming of the dipole near the feedpoint can be measured.

The dipole is made of standard semirigid coaxial cable. The center conductor of the feeding line is directly connected to the second arm of the dipole. The antenna is therefore short-circuited for DC-signals. On some of the dipoles, small end caps are added to the dipole arms in order to improve matching when loaded according to the position as explained in the "Measurement Conditions" paragraph. The SAR data are not affected by this change. The overall dipole length is still according to the Standard. No excessive force must be applied to the dipole arms, because they might bend or the soldered connections near the feedpoint may be damaged.

**Additional EUT Data**

Manufactured by	SPEAG
-----------------	-------



Add: No.51 Xueyuan Road, Haidian District, Beijing, 100191, China  
Tel: +86-10-62304633-2079 Fax: +86-10-62304633-2504  
E-mail: cttl@chinattl.com http://www.chinattl.cn

**DASY5 Validation Report for Head TSL**

Date: 12.04.2018

Test Laboratory: CTTL, Beijing, China

**DUT: Dipole 835 MHz; Type: D835V2; Serial: D835V2 - SN: 4d162**

Communication System: UID 0, CW; Frequency: 835 MHz; Duty Cycle: 1:1

Medium parameters used:  $f = 835$  MHz;  $\sigma = 0.881$  S/m;  $\epsilon_r = 42.71$ ;  $\rho = 1000$  kg/m<sup>3</sup>

Phantom section: Right Section

DASY5 Configuration:

- Probe: EX3DV4 - SN7514; ConvF(9.09, 9.09, 9.09) @ 835 MHz; Calibrated: 8/27/2018
- Sensor-Surface: 1.4mm (Mechanical Surface Detection)
- Electronics: DAE4 Sn1555; Calibrated: 8/20/2018
- Phantom: MFP\_V5.1C ; Type: QD 000 P51CA; Serial: 1062
- Measurement SW: DASY52, Version 52.10 (2); SEMCAD X Version 14.6.12 (7450)

**Dipole Calibration/Zoom Scan (7x7x7) (7x7x7)/Cube 0:** Measurement grid: dx=5mm, dy=5mm, dz=5mm

Reference Value = 57.75 V/m; Power Drift = 0.03 dB

Peak SAR (extrapolated) = 3.50 W/kg

**SAR(1 g) = 2.35 W/kg; SAR(10 g) = 1.56 W/kg**

Maximum value of SAR (measured) = 3.11 W/kg

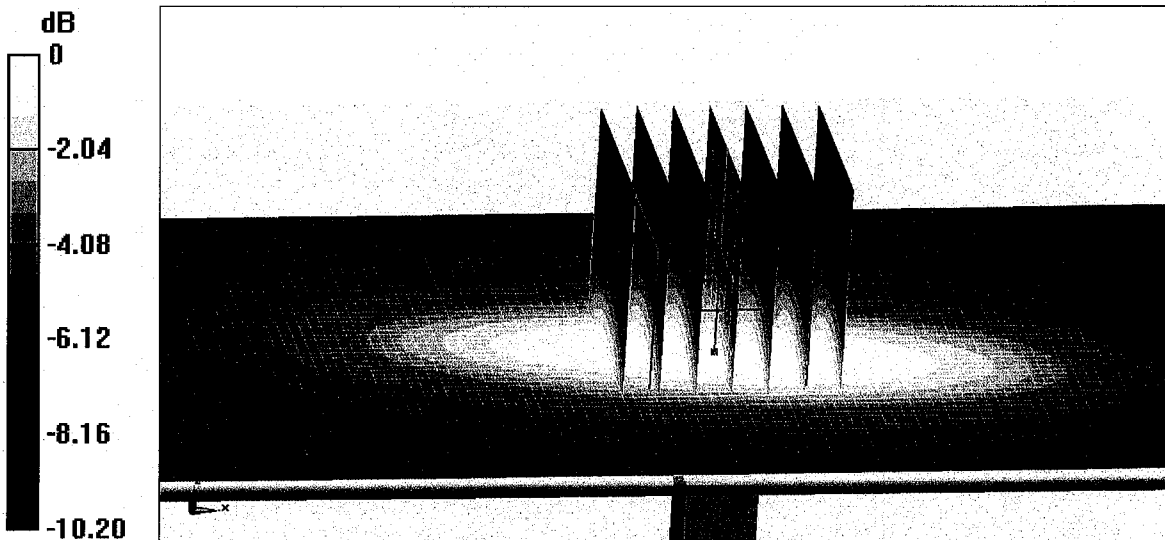

0 dB = 3.11 W/kg = 4.93 dBW/kg



Add: No.51 Xueyuan Road, Haidian District, Beijing, 100191, China  
Tel: +86-10-62304633-2079 Fax: +86-10-62304633-2504  
E-mail: cttl@chinattl.com http://www.chinattl.cn

### Impedance Measurement Plot for Head TSL

