



# FCC RF Test Report

**APPLICANT** : Motorola Mobility LLC  
**EQUIPMENT** : Mobile Cellular Phone  
**BRAND NAME** : Motorola  
**MODEL NAME** : XT2131-1, XT2131-4, XT2131-3, XT2131DL  
**FCC ID** : IHDT56ZL1  
**STANDARD** : 47 CFR Part 2, 27(L) , 27(M)  
**CLASSIFICATION** : PCS Licensed Transmitter Held to Ear (PCE)

The product was received on Jan. 29, 2021 and completely tested on Mar. 09, 2021. We, Sporton International (Shenzhen) Inc., would like to declare that the tested sample has been evaluated in accordance with the procedures given in ANSI C63.26-2015 and shown compliance with the applicable technical standards.

The test results in this report apply exclusively to the tested model / sample. Without written approval of Sporton International (Shenzhen) Inc., the test report shall not be reproduced except in full.

Reviewed by: Derreck Chen/Supervisor

Approved by: Eric Shih / Manager



**Sporton International (ShenZhen) Inc.**

1/F, 2/F, Bldg 5, Shiling Industrial Zone, Xinwei Village, Xili, Nanshan Shenzhen, 518055 People's Republic of China



TABLE OF CONTENTS

REVISION HISTORY ..... 3
SUMMARY OF TEST RESULT ..... 4
1 GENERAL DESCRIPTION ..... 5
1.1 Applicant ..... 5
1.2 Manufacturer ..... 5
1.3 Product Feature of Equipment Under Test ..... 5
1.4 Product Specification of Equipment Under Test ..... 6
1.5 Modification of EUT ..... 6
1.6 Maximum EIRP, Frequency Tolerance, and Emission Designator ..... 7
1.7 Testing Location ..... 11
1.8 Test Software ..... 11
1.9 Applicable Standards ..... 12
1.10 Specification of Accessory ..... 12
2 TEST CONFIGURATION OF EQUIPMENT UNDER TEST ..... 13
2.1 Test Mode ..... 13
2.2 Connection Diagram of Test System ..... 16
2.3 Support Unit used in test configuration and system ..... 16
2.4 Measurement Results Explanation Example ..... 16
2.5 Frequency List of Low/Middle/High Channels ..... 17
3 CONDUCTED TEST ITEMS ..... 24
3.1 Measuring Instruments ..... 24
3.2 Test Setup ..... 24
3.3 Test Result of Conducted Test ..... 24
3.4 Conducted Output Power and ERP/EIRP ..... 25
3.5 Peak-to-Average Ratio ..... 26
3.6 Occupied Bandwidth ..... 27
3.7 Conducted Band Edge ..... 28
3.8 Conducted Spurious Emission ..... 30
3.9 Frequency Stability ..... 31
4 RADIATED TEST ITEMS ..... 32
4.1 Measuring Instruments ..... 32
4.2 Test Setup ..... 32
4.3 Test Result of Radiated Test ..... 32
4.4 Radiated Spurious Emission ..... 33
5 LIST OF MEASURING EQUIPMENT ..... 34
6 UNCERTAINTY OF EVALUATION ..... 35
APPENDIX A. TEST RESULTS OF CONDUCTED TEST
APPENDIX B. TEST RESULTS OF RADIATED TEST
APPENDIX C. TEST SETUP PHOTOGRAPHS





### SUMMARY OF TEST RESULT

Report Section	FCC Rule	Description	Limit	Result	Remark
3.4	§2.1046	Conducted Output Power	Reporting Only	PASS	-
	§27.50(h)(2)	Equivalent Isotropic Radiated Power (Band 7) (Band 38) (Band 41)	EIRP < 2Watt	PASS	-
	§27.50(d)(4)	Equivalent Isotropic Radiated Power (Band 4) (Band 66)	EIRP < 1Watt	PASS	-
3.6	§2.1049	Occupied Bandwidth	Reporting Only	PASS	-
3.7	§2.1051 §27.53(h)	Conducted Band Edge Measurement (Band 4) (Band 66)	< 43+10log <sub>10</sub> (P[Watts])	PASS	-
	§27.53(m)(4)	Conducted Band Edge Measurement (Band 7) (Band 38) (Band 41)	§27.53(m)(4)		
3.8	§2.1051 §27.53(h)	Conducted Spurious Emission (Band 4) (Band 66)	< 43+10log <sub>10</sub> (P[Watts])	PASS	-
	§2.1051 §27.53(m)(4)	Conducted Spurious Emission (Band 7) (Band 38) (Band 41)	< 55+10log <sub>10</sub> (P[Watts])		
3.9	§2.1055 §27.54	Frequency Stability Temperature & Voltage	Within Authorized Band	PASS	-
4.4	§2.1053 §27.53(h)	Radiated Spurious Emission (Band 4) (Band 66)	< 43+10log <sub>10</sub> (P[Watts])	PASS	Under limit 26.03 dB at 10104.360 MHz
	§2.1053 §27.53(m)(4)	Radiated Spurious Emission (Band 7) (Band 38) (Band 41)	< 55+10log <sub>10</sub> (P[Watts])		

**Declaration of Conformity:**

The test results with all measurement uncertainty excluded are presented in accordance with the regulation limits or requirements declared by manufacturers.

**Comments and Explanations:**

The declared of product specification for EUT presented in the report are provided by the manufacturer, and the manufacturer takes all the responsibilities for the accuracy of product specification.



# 1 General Description

## 1.1 Applicant

Motorola Mobility LLC  
222 W,Merchandise Mart Plaza,Chicago,IL60654 USA

## 1.2 Manufacturer

Motorola Mobility LLC  
222 W,Merchandise Mart Plaza,Chicago,IL60654 USA

## 1.3 Product Feature of Equipment Under Test

Product Feature	
Equipment	Mobile Cellular Phone
Brand Name	Motorola
Model Name	XT2131-1, XT2131-4, XT2131-3, XT2131DL
FCC ID	IHDT56ZL1
EUT supports Radios application	CDMA/GSM/WCDMA/LTE/5G NR WLAN 2.4GHz 802.11b/g/n HT20 WLAN 5GHz 802.11a/n HT20/HT40 WLAN 5GHz 802.11ac VHT20/VHT40/VHT80 Bluetooth BR / EDR / LE FM Receiver / GNSS
IMEI Code	Conducted: 356611280012398 Radiation: 356611280016803
HW Version	DVT
SW Version	RRE31.37
EUT Stage	Production Unit



### 1.4 Product Specification of Equipment Under Test

Standards-related Product Specification	
<b>Tx Frequency</b>	LTE Band 4 : 1710 MHz ~ 1755 MHz LTE Band 7 : 2500 MHz ~ 2570 MHz LTE Band 38 : 2570 MHz ~ 2620 MHz LTE Band 41 : 2496 MHz ~ 2690 MHz LTE Band 66 : 1710 MHz ~ 1780 MHz
<b>Rx Frequency</b>	LTE Band 4 : 2110 MHz ~ 2155 MHz LTE Band 7 : 2620 MHz ~ 2690 MHz LTE Band 38 : 2570 MHz ~ 2620 MHz LTE Band 41 : 2496 MHz ~ 2690 MHz LTE Band 66 : 2110 MHz~ 2180 MHz
<b>Bandwidth</b>	LTE Band 4 : 1.4MHz / 3MHz / 5MHz / 10MHz / 15MHz / 20MHz LTE Band 7 : 5MHz/ 10MHz / 15MHz / 20MHz LTE Band 38 : 5MHz / 10MHz / 15MHz / 20MHz LTE Band 41 : 5MHz / 10MHz / 15MHz / 20MHz LTE Band 66 : 1.4MHz / 3MHz / 5MHz / 10MHz / 15MHz / 20MHz
<b>Maximum Output Power to Antenna</b>	<b>Top Antenna:</b> LTE Band 4 : 22.30 dBm LTE Band 66 : 22.39 dBm; LTE Band 66B_CA : 23.61dBm LTE Band 66C_CA : 23.13dBm <b>Bottom Antenna:</b> LTE Band 4 : 22.84 dBm LTE Band 7 : 22.71 dBm LTE Band 38 : 22.68 dBm LTE Band 41 : 26.28 dBm; LTE Band 41_CA : 23.54dBm LTE Band 66 : 22.91 dBm; LTE Band 66B_CA : 23.79dBm LTE Band 66C_CA : 23.33dBm
<b>Antenna Gain</b>	<b>Top Antenna:</b> LTE Band 4 : -4.9 dBi LTE Band 66 : -4.9 dBi <b>Bottom Antenna:</b> LTE Band 4 : -1.32 dBi LTE Band 7 : 0.6 dBi LTE Band 38 : 0.59 dBi LTE Band 41 : 0.59 dBi LTE Band 66 : -1.32 dBi
<b>Type of Modulation</b>	QPSK / 16QAM / 64QAM

**Note:**

1. The maximum ERP/EIRP is calculated from max output power and max antenna gain, only the maximum ERP/EIRP of Bottom Antenna is shown on the report.
2. LTE Band 41 supports HPUE.

### 1.5 Modification of EUT

No modifications are made to the EUT during all test items.



### 1.6 Maximum EIRP, Frequency Tolerance, and Emission Designator

LTE Band 4		QPSK			16QAM		
BW (MHz)	Frequency Range (MHz)	Emission Designator (99%OBW)	Frequency Tolerance (ppm)	Maximum EIRP(W)	Emission Designator (99%OBW)	Frequency Tolerance (ppm)	Maximum EIRP(W)
1.4	1710.7 ~ 1754.3	1M10G7D	-	0.1435	1M09W7D	-	0.1213
3	1711.5 ~ 1753.5	2M73G7D	-	0.1435	2M73W7D	-	0.1291
5	1712.5 ~ 1752.5	4M50G7D	-	0.1435	4M49W7D	-	0.1268
10	1715.0 ~ 1750.0	9M05G7D	0.0015	0.1432	9M01W7D	-	0.1183
15	1717.5 ~ 1747.5	13M4G7D	-	0.1419	13M4W7D	-	0.1227
20	1720.0 ~ 1745.0	17M9G7D	-	0.1442	17M9W7D	-	0.1227
LTE Band 4		64QAM					
BW (MHz)	Frequency Range (MHz)	Emission Designator (99%OBW)	Frequency Tolerance (ppm)		Maximum EIRP(W)		
1.4	1710.7 ~ 1754.3	1M09W7D	-		0.0948		
3	1711.5 ~ 1753.5	2M72W7D	-		0.1007		
5	1712.5 ~ 1752.5	4M50W7D	-		0.0944		
10	1715.0 ~ 1750.0	9M00W7D	-		0.0977		
15	1717.5 ~ 1747.5	13M4W7D	-		0.0942		
20	1720.0 ~ 1745.0	17M9W7D	-		0.0923		
LTE Band 66		QPSK			16QAM		
BW (MHz)	Frequency Range (MHz)	Emission Designator (99%OBW)	Frequency Tolerance (ppm)	Maximum EIRP(W)	Emission Designator (99%OBW)	Frequency Tolerance (ppm)	Maximum EIRP(W)
1.4	1710.7 ~ 1779.3	1M10G7D	-	0.1435	1M09W7D	-	0.1213
3	1711.5 ~ 1778.5	2M73G7D	-	0.1435	2M73W7D	-	0.1291
5	1712.5 ~ 1777.5	4M50G7D	-	0.1435	4M49W7D	-	0.1268
10	1715.0 ~ 1775.0	9M05G7D	0.0015	0.1432	9M01W7D	-	0.1183
15	1717.5 ~ 1772.5	13M4G7D	-	0.1419	13M4W7D	-	0.1227
20	1720.0 ~ 1770.0	17M9G7D	-	0.1442	17M9W7D	-	0.1227



LTE Band 66		64QAM					
BW (MHz)	Frequency Range (MHz)	Emission Designator (99%OBW)	Frequency Tolerance (ppm)	Maximum EIRP(W)			
1.4	1710.7 ~ 1779.3	1M09W7D	-	0.0948			
3	1711.5 ~ 1778.5	2M72W7D	-	0.1007			
5	1712.5 ~ 1777.5	4M52W7D	-	0.0944			
10	1715.0 ~ 1775.0	8M99W7D	-	0.0977			
15	1717.5 ~ 1772.5	13M4W7D	-	0.0942			
20	1720.0 ~ 1770.0	17M9W7D	-	0.0923			
LTE Band 7		QPSK			16QAM		
BW (MHz)	Frequency Range (MHz)	Emission Designator (99%OBW)	Frequency Tolerance (ppm)	Maximum EIRP(W)	Emission Designator (99%OBW)	Frequency Tolerance (ppm)	Maximum EIRP(W)
5	2502.5 ~ 2567.5	4M52G7D	-	0.2128	4M50W7D	-	0.1858
10	2505.0 ~ 2565.0	9M05G7D	0.0015	0.2133	9M03W7D	-	0.1824
15	2507.5 ~ 2562.5	13M4G7D	-	0.2094	13M5W7D	-	0.1706
20	2510.0 ~ 2560.0	17M9G7D	-	0.2143	17M9W7D	-	0.1782
LTE Band 7		64QAM					
BW (MHz)	Frequency Range (MHz)	Emission Designator (99%OBW)	Frequency Tolerance (ppm)	Maximum EIRP(W)			
5	2502.5 ~ 2567.5	4M51W7D	-	0.1517			
10	2505.0 ~ 2565.0	9M01W7D	-	0.1479			
15	2507.5 ~ 2562.5	13M5W7D	-	0.1406			
20	2510.0 ~ 2560.0	17M9W7D	-	0.1387			
LTE Band 38		QPSK			16QAM		
BW (MHz)	Frequency Range (MHz)	Emission Designator (99%OBW)	Frequency Tolerance (ppm)	Maximum EIRP(W)	Emission Designator (99%OBW)	Frequency Tolerance (ppm)	Maximum EIRP(W)
5	2572.5 ~ 2617.5	4M51G7D	-	0.4864	4M50W7D	-	0.3581
10	2575.0 ~ 2615.0	9M09G7D	0.0013	0.4831	9M07W7D	-	0.3532
15	2577.5 ~ 2612.5	13M6G7D	-	0.4808	13M5W7D	-	0.3436
20	2580.0 ~ 2610.0	17M9G7D	-	0.4864	18M0W7D	-	0.3428





LTE Band 38		64QAM					
BW (MHz)	Frequency Range (MHz)	Emission Designator (99%OBW)	Frequency Tolerance (ppm)	Maximum EIRP(W)			
5	2572.5 ~ 2617.5	4M51W7D	-	0.3508			
10	2575.0 ~ 2615.0	9M09W7D	-	0.3428			
15	2577.5 ~ 2612.5	13M5W7D	-	0.3342			
20	2580.0 ~ 2610.0	17M9W7D	-	0.3311			
LTE Band 41		QPSK			16QAM		
BW (MHz)	Frequency Range (MHz)	Emission Designator (99%OBW)	Frequency Tolerance (ppm)	Maximum EIRP(W)	Emission Designator (99%OBW)	Frequency Tolerance (ppm)	Maximum EIRP(W)
5	2498.5 ~ 2687.5	4M51G7D	-	0.4864	4M50W7D	-	0.3581
10	2501.0 ~ 2685.0	9M09G7D	0.0013	0.4831	9M07W7D	-	0.3532
15	2503.5 ~ 2682.5	13M6G7D	-	0.4808	13M5W7D	-	0.3436
20	2506.0 ~ 2680.0	17M9G7D	-	0.4864	18M0W7D	-	0.3428
LTE Band 41		64QAM					
BW (MHz)	Frequency Range (MHz)	Emission Designator (99%OBW)	Frequency Tolerance (ppm)	Maximum EIRP(W)			
5	2498.5 ~ 2687.5	4M51W7D	-	0.3508			
10	2501.0 ~ 2685.0	9M09W7D	-	0.3428			
15	2503.5 ~ 2682.5	13M5W7D	-	0.3342			
20	2506.0 ~ 2680.0	17M9W7D	-	0.3311			



LTE Band 41 CA	QPSK			16QAM		
BW (MHz)	Emission Designator (99%OBW)	Frequency Tolerance (ppm)	Maximum EIRP(W)	Emission Designator (99%OBW)	Frequency Tolerance (ppm)	Maximum EIRP(W)
20MHz+20MHz	37M8G7D	-	0.2588	38M0W7D	-	0.1452
LTE Band 41 CA	64QAM					
BW (MHz)	Emission Designator (99%OBW)		Frequency Tolerance (ppm)		Maximum EIRP(W)	
20MHz+20MHz	37M7W7D		-		0.1459	
LTE Band 66B_CA	QPSK			16QAM		
BW (MHz)	Emission Designator (99%OBW)	Frequency Tolerance (ppm)	Maximum EIRP(W)	Emission Designator (99%OBW)	Frequency Tolerance (ppm)	Maximum EIRP(W)
15MHz+5MHz	18M9G7D	-	0.1514	18M8W7D	-	0.1766
LTE Band 66B_CA	64QAM					
BW (MHz)	Emission Designator (99%OBW)		Frequency Tolerance (ppm)		Maximum EIRP(W)	
15MHz+5MHz	18M8W7D		-		0.1268	
LTE Band 66C_CA	QPSK			16QAM		
BW (MHz)	Emission Designator (99%OBW)	Frequency Tolerance (ppm)	Maximum EIRP(W)	Emission Designator (99%OBW)	Frequency Tolerance (ppm)	Maximum EIRP(W)
20MHz+20MHz	37M6G7D	-	0.1589	38M0W7D	-	0.1230
LTE Band 66C_CA	64QAM					
BW (MHz)	Emission Designator (99%OBW)		Frequency Tolerance (ppm)		Maximum EIRP(W)	
20MHz+20MHz	37M7W7D		-		0.1151	

Note:

1. LTE Band 66 overlaps the entire frequency range of LTE Band 4. Therefore, the test results provided in this report covers Band 66 as well as Band 4.
2. LTE Band 41 overlaps the entire frequency range of LTE Band 38. Therefore, the test results provided in this report covers Band 41 as well as Band 38.
3. The maximum EIRP for CA band is calculated from max output power of maximum Bandwidth combination and antenna gain, only the maximum EIRP is shown on the report.



### 1.7 Testing Location

Sporton International (Shenzhen) Inc. is accredited to ISO/IEC 17025:2017 by American Association for Laboratory Accreditation with Certificate Number 5145.01.

<b>Test Firm</b>	Sporton International (Shenzhen) Inc.		
<b>Test Site Location</b>	1/F, 2/F, Bldg 5, Shiling Industrial Zone, Xinwei Village, Xili, Nanshan, Shenzhen, 518055 People's Republic of China TEL: +86-755-86379589 FAX: +86-755-86379595		
<b>Test Site No.</b>	<b>Sporton Site No.</b>	<b>FCC Designation No.</b>	<b>FCC Test Firm Registration No.</b>
	TH01-SZ	CN1256	421272

<b>Test Firm</b>	Sporton International (Shenzhen) Inc.		
<b>Test Location Site</b>	101, 1st Floor, Block B, Building 1, No. 2, Tengfeng 4th Road, Fenghuang Community, Fuyong Street, Baoan District, Shenzhen City Guangdong Province China 518103 TEL: +86-755-33202398		
<b>Test Site No.</b>	<b>Sporton Site No.</b>	<b>FCC Designation No.</b>	<b>FCC Test Firm Registration No.</b>
	03CH04-SZ	CN1256	421272

### 1.8 Test Software

Item	Site	Manufacturer	Name	Version
1.	03CH04-SZ	AUDIX	E3	6.2009-8-24



### 1.9 Applicable Standards

According to the specifications of the manufacturer, the EUT must comply with the requirements of the following standards:

- 47 CFR Part 2, 27(L), 27(M)
- ANSI C63.26-2015
- FCC KDB 971168 D01 Power Meas License Digital Systems v03r01
- FCC KDB 412172 D01 Determining ERP and EIRP v01r01

**Remark:**

1. All test items were verified and recorded according to the standards and without any deviation during the test.
2. This EUT has also been tested and complied with the requirements of FCC Part 15, Subpart B, recorded in a separate test report.

### 1.10 Specification of Accessory

Specification of Accessory				
AC Adapter 1(US)	Brand Name	Motorola (Chenyang)	Model Name	MC-101
AC Adapter 2(US)	Brand Name	Motorola (Salcomp)	Model Name	MC-101
Battery	Brand Name	Motorola (ATL)	Model Name	MD50
USB Cable 1	Brand Name	Motorola (Saibao)	Model Name	SC18C24367
USB Cable 2	Brand Name	Motorola (Luxshare)	Model Name	SC18C24368



## 2 Test Configuration of Equipment Under Test

### 2.1 Test Mode

Antenna port conducted and radiated test items listed below are performed according to KDB 971168 D01 Power Meas License Digital Systems v03r01 with maximum output power.

Radiated measurements are performed by rotating the EUT in three different orthogonal test planes to find the maximum emission.

Test Items	Band	Bandwidth (MHz)						Modulation			RB #			Test Channel		
		1.4	3	5	10	15	20	QPSK	16QAM	64QAM	1	Half	Full	L	M	H
Max. Output Power	4	v	v	v	v	v	v	v	v	v	v	v	v	v	v	v
	7	-	-	v	v	v	v	v	v	v	v	v	v	v	v	v
	38	-	-	v	v	v	v	v	v	v	v	v	v	v	v	v
	41	-	-	v	v	v	v	v	v	v	v	v	v	v	v	v
	66	v	v	v	v	v	v	v	v	v	v	v	v	v	v	v
Peak-to-Average Ratio	7	-	-				v	v	v	v	v		v	v	v	v
	41	-	-				v	v	v	v	v		v	v	v	v
	66						v	v	v	v	v		v	v	v	v
26dB and 99% Bandwidth	7	-	-	v	v	v	v	v	v	v			v	v	v	v
	41	-	-	v	v	v	v	v	v	v			v	v	v	v
	66	v	v	v	v	v	v	v	v	v			v	v	v	v
Conducted Band Edge	7	-	-	v	v	v	v	v	v	v	v		v	v		v
	41	-	-	v	v	v	v	v	v	v	v		v	v		v
	66	v	v	v	v	v	v	v	v	v	v		v	v		v
Conducted Spurious Emission	7	-	-	v	v	v	v	v	v	v	v			v	v	v
	41	-	-	v	v	v	v	v	v	v	v			v	v	v
	66	v	v	v	v	v	v	v	v	v	v			v	v	v
Frequency Stability	7	-	-		v			v					v		v	
	41	-	-		v			v					v		v	
	66				v			v					v		v	
E.R.P / E.I.R.P	7	-	-	v	v	v	v	v	v	v	v			v	v	v
	41	-	-	v	v	v	v	v	v	v	v			v	v	v
	66	v	v	v	v	v	v	v	v	v	v			v	v	v
Radiated Spurious Emission	7	Worst Case													v	
	41	Worst Case													v	
	66	Worst Case													v	



<b>Note</b>	<ol style="list-style-type: none"> <li>The mark "v" means that this configuration is chosen for testing</li> <li>The mark "-" means that this bandwidth is not supported.</li> <li>The device is investigated from 30MHz to 10 times of fundamental signal for radiated spurious emission test under different RB size/offset and modulations in exploratory test. Subsequently, only the worst case emissions are reported.</li> </ol>
-------------	---

Test Items	Band	Bandwidth (MHz)										Modulation			RB #			Test Channel					
		20+20	20+15	15+20	20+10	10+20	20+5	5+20	15+15	15+10	10+15	QPSK	16QAM	64QAM	256QAM	1	Half	Full	L	M	H		
Max. Output Power	41C_CA	v	v	v	v	v	v	v	v	v	v	v	v	v		v	v	v	v	v	v		
26dB and 99% Bandwidth	41C_CA	v	v	v	v	v	v	v	v	v	v	v	v	v				v	v	v	v		
Conducted Band Edge	41C_CA	v	v	v	v	v	v	v	v	v	v	v	v	v		v		v	v		v		
E.I.R.P.	41C_CA	v	v	v	v	v	v	v	v	v	v	v	v	v		v					v		
Conducted Spurious Emission	41C_CA	v	v	v	v	v	v	v	v	v	v	v	v	v		v				v	v	v	
Radiated Spurious Emission	41C_CA	Worst Case																					v
<b>Note</b>	<ol style="list-style-type: none"> <li>The mark "v" means that this configuration is chosen for testing</li> <li>The mark "-" means that this bandwidth is not supported.</li> <li>The device is investigated from 30MHz to 10 times of fundamental signal for radiated spurious emission test under different RB size/offset and modulations in exploratory test. Subsequently, only the worst case emissions are reported.</li> </ol>																						

Test Items	Band	Bandwidth (MHz)										Modulation			RB #			Test Channel					
		20+20	20+15	15+20	20+10	10+20	20+5	5+20	15+15	15+10	10+15	QPSK	16QAM	64QAM	1	Half	Full	L	M	H			
Max. Output Power	66C_CA	v	v	v	v	v	v	v	v	v	v	v	v	v	v	v	v	v	v	v	v		
26dB and 99% Bandwidth	66C_CA	v	v	v	v	v	v	v	v	v	v	v	v	v				v		v			
Conducted Band Edge	66C_CA	v	v	v	v	v	v	v	v	v	v	v	v	v			v	v			v		
Conducted Spurious Emission	66C_CA	v	v	v	v	v	v	v	v	v	v	v	v	v					v	v	v		
E.I.R.P.	66C_CA	v	v	v	v	v	v	v	v	v	v	v	v	v					v	v	v		
Radiated Spurious Emission	66C_CA	Worst Case																					v
<b>Note</b>	<ol style="list-style-type: none"> <li>The mark "v" means that this configuration is chosen for testing</li> <li>The mark "-" means that this bandwidth is not supported.</li> <li>The device is investigated from 30MHz to 10 times of fundamental signal for radiated spurious emission test under</li> </ol>																						



different RB size/offset and modulations in exploratory test. Subsequently, only the worst case emissions are reported.

Test Items	Band	Bandwidth (MHz)						Modulation			RB #			Test Channel		
		5+5	5+10	5+15	10+10	10+5	15+5	QPSK	16QAM	64QAM	1	Half	Full	L	M	H
Max. Output Power	66B_CA	v	v	v	v	v	v	v	v	v	v	v	v	v	v	v
26dB and 99% Bandwidth	66B_CA	v	v	v	v	v	v	v	v	v			v	v	v	v
Conducted Band Edge	66B_CA	v	v	v	v	v	v	v	v	v	v		v	v		v
Conducted Spurious Emission	66B_CA	v	v	v	v	v	v	v	v	v	v			v	v	v
E.I.R.P.	66B_CA	v	v	v	v	v	v	v	v	v	v			v	v	v
Radiated Spurious Emission	66B_CA	Worst Case													v	
Note	1. The mark "v" means that this configuration is chosen for testing 2. The mark "-" means that this bandwidth is not supported. 3. The device is investigated from 30MHz to 10 times of fundamental signal for radiated spurious emission test under different RB size/offset and modulations in exploratory test. Subsequently, only the worst case emissions are reported.															

## 2.2 Connection Diagram of Test System

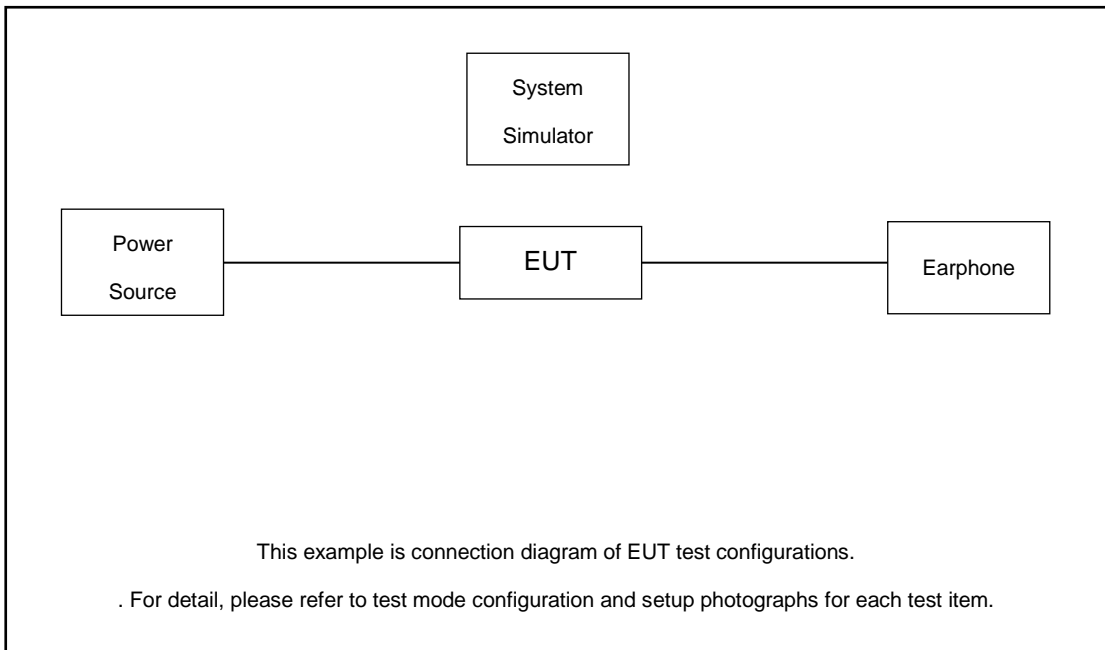

## 2.3 Support Unit used in test configuration and system

Item	Equipment	Trade Name	Model No.	FCC ID	Data Cable	Power Cord
1.	Power Supply	GWINSTEK	PSS-2002	N/A	N/A	Unshielded, 1.8 m
2.	LTE Base Station	Anritsu	MT8820C	N/A	N/A	Unshielded, 1.8 m
3.	Earphone	N/A	N/A	N/A	Unshielded, 1.2m	N/A

## 2.4 Measurement Results Explanation Example

### For all conducted test items:

The offset level is set in the spectrum analyzer to compensate the RF cable loss and attenuator factor between EUT conducted output port and spectrum analyzer. With the offset compensation, the spectrum analyzer reading level is exactly the EUT RF output level.

The spectrum analyzer offset is derived from RF cable loss and attenuator factor.

*Offset = RF cable loss + attenuator factor.*

Following shows an offset computation example with cable loss 5.0 dB and 10dB attenuator.

Example :

$$\begin{aligned} \text{Offset(dB)} &= \text{RF cable loss(dB)} + \text{attenuator factor(dB)} \\ &= 5.0 + 10 = 15.0 \text{ (dB)} \end{aligned}$$





### 2.5 Frequency List of Low/Middle/High Channels

LTE Band 4 Channel and Frequency List				
BW [MHz]	Channel/Frequency(MHz)	Lowest	Middle	Highest
20	Channel	20050	20175	20300
	Frequency	1720	1732.5	1745
15	Channel	20025	20175	20325
	Frequency	1717.5	1732.5	1747.5
10	Channel	20000	20175	20350
	Frequency	1715	1732.5	1750
5	Channel	19975	20175	20375
	Frequency	1712.5	1732.5	1752.5
3	Channel	19965	20175	20385
	Frequency	1711.5	1732.5	1753.5
1.4	Channel	19957	20175	20393
	Frequency	1710.7	1732.5	1754.3

LTE Band 7 Channel and Frequency List				
BW [MHz]	Channel/Frequency(MHz)	Lowest	Middle	Highest
20	Channel	20850	21100	21350
	Frequency	2510	2535	2560
15	Channel	20825	21100	21375
	Frequency	2507.5	2535	2562.5
10	Channel	20800	21100	21400
	Frequency	2505	2535	2565
5	Channel	20775	21100	21425
	Frequency	2502.5	2535	2567.5



LTE Band 38 Channel and Frequency List				
BW [MHz]	Channel/Frequency(MHz)	Lowest	Middle	Highest
20	Channel	37850	38000	38150
	Frequency	2580	2595	2610
15	Channel	37825	38000	38175
	Frequency	2577.5	2595	2612.5
10	Channel	37800	38000	38200
	Frequency	2575	2595	2615
5	Channel	37775	38000	38225
	Frequency	2572.5	2595	2617.5

LTE Band 41 Channel and Frequency List				
BW [MHz]	Channel/Frequency(MHz)	Lowest	Middle	Highest
20	Channel	39750	40620	41490
	Frequency	2506	2593	2680
15	Channel	39725	40620	41515
	Frequency	2503.5	2593	2682.5
10	Channel	39700	40620	41540
	Frequency	2501	2593	2685
5	Channel	39675	40620	41565
	Frequency	2498.5	2593	2687.5



LTE Band 66 Channel and Frequency List				
BW [MHz]	Channel/Frequency(MHz)	Lowest	Middle	Highest
20	Channel	132072	132322	132572
	Frequency	1720	1745	1770
15	Channel	132047	132322	132597
	Frequency	1717.5	1745	1772.5
10	Channel	132022	132322	132622
	Frequency	1715	1745	1775
5	Channel	131997	132322	132647
	Frequency	1712.5	1745	1777.5
3	Channel	131987	132322	132657
	Frequency	1711.5	1745	1778.5
1.4	Channel	131979	132322	132665
	Frequency	1710.7	1745	1779.3



LTE Band 41C_CA Channel and Frequency List					
BW [MHz]	Channel/Frequency(MHz)		Lowest	Middle	Highest
20 + 20	PCC	Channel	39750	40521	41292
		Frequency	2506.0	2583.1	2660.2
	SCC	Channel	39948	40719	41490
		Frequency	2525.8	2602.9	2680.0
20 + 15	PCC	Channel	39750	40546	41341
		Frequency	2506.0	2585.6	2665.1
	SCC	Channel	39921	40717	41512
		Frequency	2523.1	2602.7	2682.2
15 + 20	PCC	Channel	39728	40523	41319
		Frequency	2503.8	2593.3	2662.9
	SCC	Channel	39899	40694	41490
		Frequency	2520.9	2600.4	2680.0
20 + 10	PCC	Channel	39750	40571	41391
		Frequency	2506.0	2588.1	2670.1
	SCC	Channel	39894	40715	41535
		Frequency	2520.4	2602.5	2684.5
10 + 20	PCC	Channel	39705	40526	41346
		Frequency	2501.5	2583.6	2665.6
	SCC	Channel	39849	40670	41490
		Frequency	2515.9	2598.0	2680.0



LTE Band 41C_CA Channel and Frequency List					
20 + 5	PCC	Channel	39750	40595	41440
		Frequency	2506.0	2590.5	2675.0
	SCC	Channel	39867	40712	41557
		Frequency	2517.7	2602.2	2686.7
5 + 20	PCC	Channel	39683	40528	41373
		Frequency	2499.3	2583.8	2668.3
	SCC	Channel	39800	40645	41490
		Frequency	2511.0	2595.5	2680.0
15 + 15	PCC	Channel	39725	40545	41365
		Frequency	2503.5	2585.5	2667.5
	SCC	Channel	39875	40695	41515
		Frequency	2518.5	2600.5	2682.5
10 + 15	PCC	Channel	39703	40549	41395
		Frequency	2501.3	2585.9	2670.5
	SCC	Channel	39823	40669	41515
		Frequency	2513.3	2597.9	2682.5
15 + 10	PCC	Channel	39725	40571	41417
		Frequency	2503.5	2588.1	2672.7
	SCC	Channel	39845	40691	41537
		Frequency	2515.5	2600.1	2684.7



LTE Band 66C_CA Channel and Frequency List					
BW [MHz]	Channel/Frequency(MHz)		Lowest	Middle	Highest
10 + 15	PCC	Channel	132025	132351	132477
		Frequency	1715.3	1747.9	1760.5
	SCC	Channel	132145	132471	132597
		Frequency	1727.3	1759.9	1772.5
15 + 10	PCC	Channel	132047	132373	132499
		Frequency	1717.5	1750.1	1762.7
	SCC	Channel	132167	132493	132619
		Frequency	1729.5	1762.1	1774.7
10 + 20	PCC	Channel	132027	132328	132428
		Frequency	1715.5	1745.6	1755.6
	SCC	Channel	132171	132472	132572
		Frequency	1729.9	1760	1770
20 + 10	PCC	Channel	132072	132373	132473
		Frequency	1720	1750.1	1760.1
	SCC	Channel	132216	132517	132617
		Frequency	1734.4	1764.5	1774.5
15 + 15	PCC	Channel	132047	132347	132447
		Frequency	1717.5	1747.5	1757.5
	SCC	Channel	132197	132497	132597
		Frequency	1732.5	1762.5	1772.5
15 + 20	PCC	Channel	132050	132325	132401
		Frequency	1717.8	1745.3	1752.9
	SCC	Channel	132221	132496	132572
		Frequency	1734.9	1762.4	1770
20 + 15	PCC	Channel	132072	132348	132423
		Frequency	1720	1747.6	1755.1
	SCC	Channel	132243	132519	132594
		Frequency	1737.1	1764.7	1772.2
20 + 5	PCC	Channel	132072	132397	132522
		Frequency	1720	1752.5	1765
	SCC	Channel	132189	132514	132639
		Frequency	1731.7	1764.2	1776.7
5 + 20	PCC	Channel	132005	132330	132455
		Frequency	1713.3	1745.8	1758.3



	SCC	Channel	132122	132447	132572
		Frequency	1725	1757.5	1770
20 + 20	PCC	Channel	132072	132323	132374
		Frequency	1720	1745.1	1750.2
	SCC	Channel	132270	132521	132572
		Frequency	1739.8	1764.9	1770

LTE Band 66B_CA Channel and Frequency List					
BW [MHz]	Channel/Frequency(MHz)		Lowest	Middle	Highest
5 + 5	PCC	Channel	131997	132398	132599
		Frequency	1712.5	1752.6	1772.7
	SCC	Channel	132045	132446	132647
		Frequency	1717.3	1757.4	1777.5
5 + 10	PCC	Channel	132000	132375	132550
		Frequency	1712.8	1750.3	1767.8
	SCC	Channel	132072	132447	132622
		Frequency	1720	1757.5	1775
10 + 5	PCC	Channel	132022	132397	132572
		Frequency	1715	1752.5	1770
	SCC	Channel	132094	132469	132644
		Frequency	1722.2	1759.7	1777.2
5 + 15	PCC	Channel	132002	132353	132504
		Frequency	1713	1748.1	1763.2
	SCC	Channel	132095	132446	132597
		Frequency	1722.3	1757.4	1772.5
15 + 5	PCC	Channel	132047	132398	132549
		Frequency	1717.5	1752.6	1767.7
	SCC	Channel	132140	132491	132642
		Frequency	1726.8	1761.9	1777
10 + 10	PCC	Channel	132022	132373	132523
		Frequency	1715	1750.1	1765.1
	SCC	Channel	132121	132472	132622
		Frequency	1724.9	1760	1775

### 3 Conducted Test Items

#### 3.1 Measuring Instruments

See list of measuring instruments of this test report.

#### 3.2 Test Setup

##### 3.2.1 Conducted Output Power



##### 3.2.2 Peak-to-Average Ratio, Occupied Bandwidth ,Conducted Band-Edge and Conducted Spurious Emission



##### 3.2.3 Frequency Stability

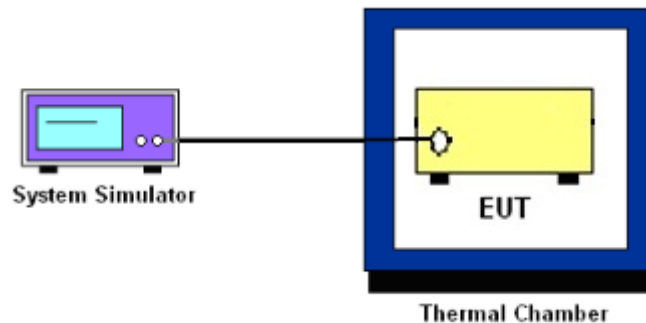

### 3.3 Test Result of Conducted Test

Please refer to Appendix A.





### 3.4 Conducted Output Power and EIRP

#### 3.4.1 Description of the Conducted Output Power Measurement and EIRP Measurement

A system simulator was used to establish communication with the EUT. Its parameters were set to force the EUT transmitting at maximum output power. The measured power in the radio frequency on the transmitter output terminals shall be reported.

The EIRP of mobile transmitters must not exceed 2 Watts for Band 7 and Band 38 and Band 41.

The EIRP of mobile transmitters must not exceed 1 Watts for LTE Band 4 and Band 66.

According to KDB 412172 D01 Power Approach,

$EIRP = P_T + G_T - L_C$ ,  $ERP = EIRP - 2.15$ , where

$P_T$  = transmitter output power in dBm

$G_T$  = gain of the transmitting antenna in dBi

$L_C$  = signal attenuation in the connecting cable between the transmitter and antenna in dB

#### 3.4.2 Test Procedures

1. The testing follows ANSI C63.26 Section 5.2
2. The transmitter output port was connected to the system simulator.
3. Set EUT at maximum power through the system simulator.
4. Select lowest, middle, and highest channels for each band and different modulation.
5. Measure and record the power level from the system simulator.



## **3.5 Peak-to-Average Ratio**

### **3.5.1 Description of the PAR Measurement**

Power Complementary Cumulative Distribution Function (CCDF) curves provide a means for characterizing the power peaks of a digitally modulated signal on a statistical basis. A CCDF curve depicts the probability of the peak signal amplitude exceeding the average power level. Most contemporary measurement instrumentation include the capability to produce CCDF curves for an input signal provided that the instrument's resolution bandwidth can be set wide enough to accommodate the entire input signal bandwidth. In measuring transmissions in this band using an average power technique, the peak-to-average ratio (PAR) of the transmission may not exceed 13 dB.

### **3.5.2 Test Procedures**

1. The testing follows ANSI C63.26 Section 5.2.3.4 (CCDF).
2. The EUT was connected to spectrum and system simulator via a power divider.
3. Set the CCDF (Complementary Cumulative Distribution Function) option in spectrum analyzer.
4. The highest RF powers were measured and recorded the maximum PAPR level associated with a probability of 0.1 %.
5. Record the deviation as Peak to Average Ratio.



### 3.6 Occupied Bandwidth

#### 3.6.1 Description of Occupied Bandwidth Measurement

The occupied bandwidth is the width of a frequency band such that, below the lower and above the upper frequency limits, the mean powers emitted are each equal to a specified percentage 0.5% of the total mean transmitted power.

The 26 dB emission bandwidth is defined as the frequency range between two points, one above and one below the carrier frequency, at which the spectral density of the emission is attenuated 26 dB below the maximum in-band spectral density of the modulated signal. Spectral density (power per unit bandwidth) is to be measured with a detector of resolution bandwidth equal to approximately 1.0% of the emission bandwidth.

#### 3.6.2 Test Procedures

1. The testing follows ANSI C63.26 Section 5.4
2. The EUT was connected to spectrum analyzer and system simulator via a power divider.
3. The spectrum analyzer center frequency is set to the nominal EUT channel center frequency. The span range for the spectrum analyzer shall be between two and five times the anticipated OBW.
4. The nominal resolution bandwidth (RBW) shall be in the range of 1 to 5 % of the anticipated OBW, and the VBW shall be at least 3 times the RBW.
5. Set the detection mode to peak, and the trace mode to max hold.
6. Determine the reference value: Set the EUT to transmit a modulated signal. Allow the trace to stabilize. Set the spectrum analyzer marker to the highest level of the displayed trace.  
(this is the reference value)
7. Determine the “-26 dB down amplitude” as equal to (Reference Value – X).
8. Place two markers, one at the lowest and the other at the highest frequency of the envelope of the spectral display such that each marker is at or slightly below the “-X dB down amplitude” determined in step 6. If a marker is below this “-X dB down amplitude” value it shall be placed as close as possible to this value. The OBW is the positive frequency difference between the two markers.
9. Use the 99 % power bandwidth function of the spectrum analyzer and report the measured bandwidth.



## 3.7 Conducted Band Edge

### 3.7.1 Description of Conducted Band Edge Measurement

27.53 (h)

For operations in the 1710 – 1755 MHz band, the FCC limit is  $43 + 10\log_{10}(P[\text{Watts}])$  dB below the transmitter power  $P(\text{Watts})$  in a 1 MHz bandwidth. However, in the 1MHz bands immediately outside and adjacent to the licensee's frequency block, a resolution bandwidth of at least one percent of the emission bandwidth of the fundamental emission of the transmitter may be employed.

27.53(m)(4)

For mobile digital stations, the attenuation factor shall be not less than  $40 + 10 \log (P)$  dB on all frequencies between the channel edge and 5 megahertz from the channel edge,  $43 + 10 \log (P)$  dB on all frequencies between 5 megahertz and X megahertz from the channel edge, and  $55 + 10 \log (P)$  dB on all frequencies more than X megahertz from the channel edge, where X is the greater of 6 megahertz or the actual emission bandwidth as defined in paragraph (m)(6) of this section. In addition, the attenuation factor shall not be less that  $43 + 10 \log (P)$  dB on all frequencies between 2490.5 MHz and 2496 MHz and  $55 + 10 \log (P)$  dB at or below 2490.5 MHz. Mobile Satellite Service licensees operating on frequencies below 2495 MHz may also submit a documented interference complaint against BRS licensees operating on channel BRS Channel 1 on the same terms and conditions as adjacent channel BRS or EBS licensees.



### 3.7.2 Test Procedures

1. The testing follows ANSI C63.26 section 5.7
2. The EUT was connected to spectrum analyzer and system simulator via a power divider.
3. The band edges of low and high channels for the highest RF powers were measured.
4. Set RBW  $\geq$  1% EBW in the 1MHz band immediately outside and adjacent to the band edge.
5. Beyond the 1 MHz band from the band edge, RBW=1MHz was used or a narrower RBW was used and the measured power was integrated over the full required measurement bandwidth of 1 MHz.
6. Set spectrum analyzer with RMS detector.
7. The RF fundamental frequency should be excluded against the limit line in the operating frequency band.
8. Checked that all the results comply with the emission limit line.

Example:

The limit line is derived from  $43 + 10\log(P)$ dB below the transmitter power P(Watts)

$$= P(W) - [43 + 10\log(P)] \text{ (dB)}$$

$$= [30 + 10\log(P)] \text{ (dBm)} - [43 + 10\log(P)] \text{ (dB)} = -13\text{dBm}.$$

9. For LTE Band 7, 38, 41, the other 40 dB, and 55 dB have additionally applied same calculation above.



### 3.8 Conducted Spurious Emission

#### 3.8.1 Description of Conducted Spurious Emission Measurement

The power of any emission outside of the authorized operating frequency ranges must be lower than the transmitter power (P) by a factor of at least  $43 + 10 \log (P)$  dB.

For Band 7,38,41:

The power of any emission outside of the authorized operating frequency ranges must be lower than the transmitter power (P) by a factor of at least  $55 + 10 \log (P)$  dB.

It is measured by means of a calibrated spectrum analyzer and scanned from 30 MHz up to a frequency including its 10<sup>th</sup> harmonic.

#### 3.8.2 Test Procedures

1. The testing follows ANSI C63.26 section 5.7
2. The EUT was connected to spectrum analyzer and system simulator via a power divider.
3. The RF output of EUT was connected to the spectrum analyzer by RF cable and attenuator. The path loss was compensated to the results for each measurement.
4. The middle channel for the highest RF power within the transmitting frequency was measured.
5. The conducted spurious emission for the whole frequency range was taken.
6. Make the measurement with the spectrum analyzer's RBW = 1MHz, VBW = 3MHz.
7. Set spectrum analyzer with RMS detector.
8. Taking the record of maximum spurious emission.
9. The RF fundamental frequency should be excluded against the limit line in the operating frequency band.
10. The limit line is derived from  $43 + 10\log(P)$ dB below the transmitter power P(Watts)  
=  $P(W) - [43 + 10\log(P)]$  (dB)  
=  $[30 + 10\log(P)]$  (dBm) -  $[43 + 10\log(P)]$  (dB)  
= -13dBm.
11. For Band 7, 38, 41  
The limit line is derived from  $55 + 10\log(P)$ dB below the transmitter power P(Watts)  
=  $P(W) - [55 + 10\log(P)]$  (dB)  
=  $[30 + 10\log(P)]$  (dBm) -  $[55 + 10\log(P)]$  (dB)  
= -25dBm.



## 3.9 Frequency Stability

### 3.9.1 Description of Frequency Stability Measurement

The frequency stability shall be measured by variation of ambient temperature and variation of primary supply voltage to ensure that the fundamental emission stays within the authorized frequency block. The frequency stability of the transmitter shall be maintained within  $\pm 0.00025\%$  ( $\pm 2.5\text{ppm}$ ) of the center frequency.

### 3.9.2 Test Procedures for Temperature Variation

1. The testing follows ANSI C63.26 section 5.6.4
2. The EUT was set up in the thermal chamber and connected with the system simulator.
3. With power OFF, the temperature was decreased to  $-30^{\circ}\text{C}$  and the EUT was stabilized before testing. Power was applied and the maximum change in frequency was recorded within one minute.
4. With power OFF, the temperature was raised in  $10^{\circ}\text{C}$  step up to  $50^{\circ}\text{C}$ . The EUT was stabilized at each step for at least half an hour. Power was applied and the maximum frequency change was recorded within one minute.

### 3.9.3 Test Procedures for Voltage Variation

1. The testing follows ANSI C63.26 section 5.6.5
2. The EUT was placed in a temperature chamber at  $20\pm 5^{\circ}\text{C}$  and connected with the system simulator.
3. The power supply voltage to the EUT was varied from 85% to 115% of the nominal value for other than hand carried battery equipment.
4. For hand carried, battery powered equipment, reduce the primary ac or dc supply voltage to the battery operating end point, which shall be specified by the manufacturer.
5. The variation in frequency was measured for the worst case.

## 4 Radiated Test Items

### 4.1 Measuring Instruments

See list of measuring instruments of this test report.

### 4.2 Test Setup

#### 4.2.1 For radiated test from 30MHz to 1GHz

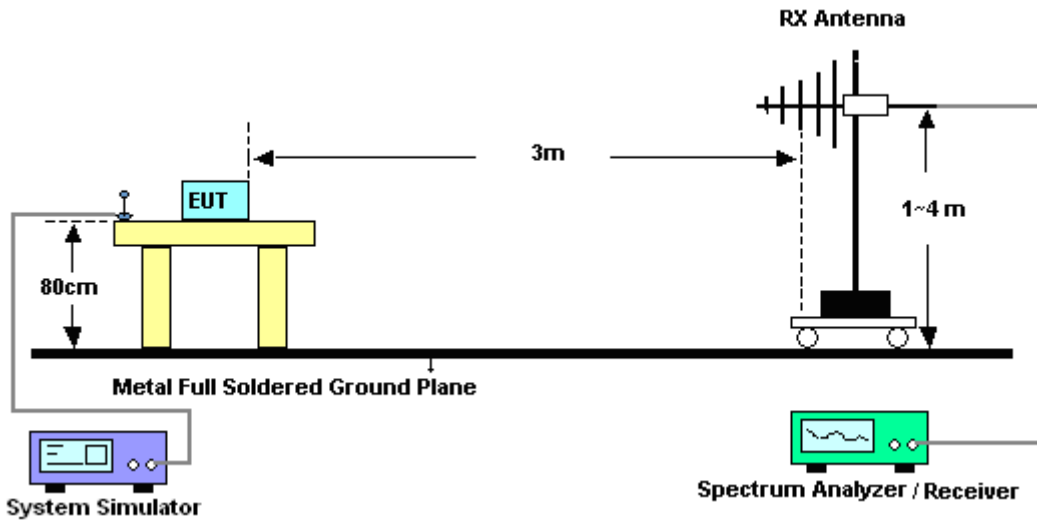

#### 4.2.2 For radiated test above 1GHz

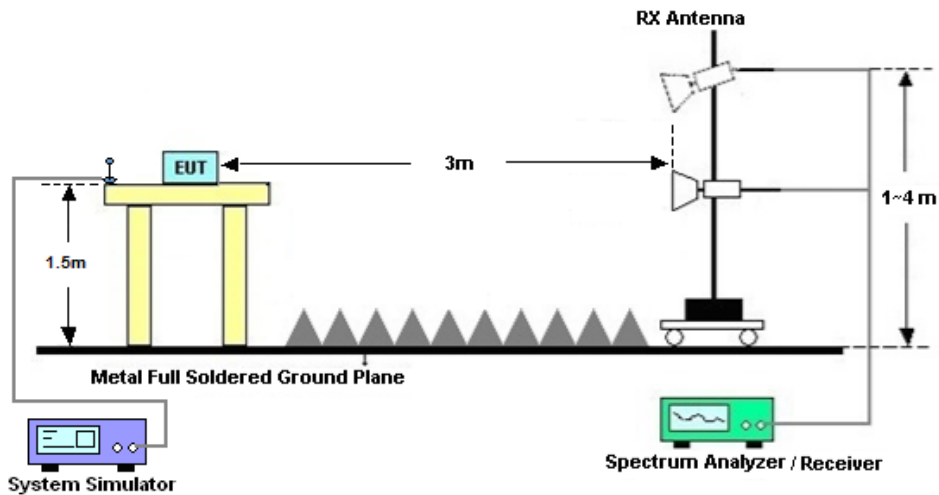

### 4.3 Test Result of Radiated Test

Please refer to Appendix B.





## 4.4 Radiated Spurious Emission

### 4.4.1 Description of Radiated Spurious Emission

The radiated spurious emission was measured by substitution method according to ANSI C63.26. The power of any emission outside of the authorized operating frequency ranges must be attenuated below the transmitter power (P) by a factor of at least  $43 + 10 \log (P)$  dB.

For Band 7, 38, 41

The power of any emission outside of the authorized operating frequency ranges must be attenuated below the transmitter power (P) by a factor of at least  $55 + 10 \log (P)$  dB.

The spectrum is scanned from 30 MHz up to a frequency including its 10th harmonic.

### 4.4.2 Test Procedures

1. The testing follows ANSI C63.26 Section 5.5
2. The EUT was placed on a turntable with 0.8 meter height for frequency below 1GHz and 1.5 meter height for frequency above 1GHz respectively above ground.
3. The EUT was set 3 meters from the receiving antenna mounted on the antenna tower.
4. The table was rotated 360 degrees to determine the position of the highest spurious emission.
5. The height of the receiving antenna is varied between 1m to 4m to search the maximum spurious emission for both horizontal and vertical polarizations.
6. During the measurement, the system simulator parameters were set to force the EUT transmitting at maximum output power.
7. Make the measurement with the spectrum analyzer's RBW = 1MHz, VBW = 3MHz, taking the record of maximum spurious emission.
8. A horn antenna was substituted in place of the EUT and was driven by a signal generator.
9. Tune the output power of signal generator to the same emission level with EUT maximum spurious emission.
10.  $EIRP (dBm) = S.G. Power - Tx Cable Loss + Tx Antenna Gain$
11.  $ERP (dBm) = EIRP - 2.15$
12. The RF fundamental frequency should be excluded against the limit line in the operating frequency band.

The limit line is derived from  $43 + 10\log(P)$ dB below the transmitter power P(Watts)  
 $= P(W) - [43 + 10\log(P)] (dB)$   
 $= [30 + 10\log(P)] (dBm) - [43 + 10\log(P)] (dB)$   
 $= -13dBm.$

13. For Band 7, 38, 41:

The limit line is derived from  $55 + 10\log(P)$ dB below the transmitter power P(Watts)



## 5 List of Measuring Equipment

Instrument	Manufacturer	Model No.	Serial No.	Characteristics	Calibration Date	Test Date	Due Date	Remark
Spectrum Analyzer	R&S	FSV40	101078	10Hz~40GHz	Apr. 17, 2020	Feb. 12, 2021~ Mar. 09, 2021	Apr. 16, 2021	Conducted (TH01-SZ)
Thermal Chamber	Ten Billion Hongzhangroup	LP-150U	H2014081803	-40~+150°C	Jul. 22, 2020	Feb. 12, 2021~ Mar. 09, 2021	Jul. 21, 2021	Conducted (TH01-SZ)
EXA Spectrum Analyzer	KEYSIGHT	N9010A	MY55150213	10Hz~44GHz	Jul. 21, 2020	Feb. 20, 2021	Jul. 20, 2021	Radiation (03CH04-SZ)
Bilog Antenna	TeseQ	CBL6111D	41909	30MHz~1GHz	Nov. 07, 2020	Feb. 20, 2021	Nov. 06, 2021	Radiation (03CH04-SZ)
Double Ridge Horn Antenna	SCHWARZBECK	BBHA9120D	9120D-1474	1GHz~18GHz	May 23, 2020	Feb. 20, 2021	May 22, 2021	Radiation (03CH04-SZ)
Horn Antenna	SCHWARZBECK	BBHA9170	9170#679	15GHz~40GHz	Jul. 26, 2020	Feb. 20, 2021	Jul. 25, 2021	Radiation (03CH04-SZ)
Amplifier	Burgeon	BPA-530	102211	0.01Hz ~3000MHz	Oct. 16, 2020	Feb. 20, 2021	Oct. 15, 2021	Radiation (03CH04-SZ)
HF Amplifier	MITEQ	AMF-7D-00 101800-30-1 0P-R	1943528	1GHz~18GHz	Oct. 17, 2020	Feb. 20, 2021	Oct. 16, 2021	Radiation (03CH04-SZ)
HF Amplifier	MITEQ	TTA1840-35 -HG	1871923	18GHz~40GHz	Jul. 21, 2020	Feb. 20, 2021	Jul. 20, 2021	Radiation (03CH04-SZ)
Amplifier	Agilent Technologies	83017A	MY53270156	500MHz~26.5GHz	Oct. 17, 2020	Feb. 20, 2021	Oct. 16, 2021	Radiation (03CH04-SZ)
AC Power Source	Chroma	61601	N/A	N/A	NCR	Feb. 20, 2021	NCR	Radiation (03CH04-SZ)
Turn Table	EM	EM1000	N/A	0~360 degree	NCR	Feb. 20, 2021	NCR	Radiation (03CH04-SZ)
Antenna Mast	EM	EM1000	N/A	1 m~4 m	NCR	Feb. 20, 2021	NCR	Radiation (03CH04-SZ)

NCR: No Calibration Required.



## 6 Uncertainty of Evaluation

The measurement uncertainties shown below were calculated in accordance with the requirements of ANSI 63.26-2015. All the measurement uncertainty value were shown with a coverage K=2 to indicate 95% level of confidence. The measurement data show herein meets or exceeds the CISPR measurement uncertainty values specified in CISPR 16-4-2 and can be compared directly to specified limit to determine compliance.

### Uncertainty of Radiated Emission Measurement (30 MHz ~ 1000 MHz)

Measuring Uncertainty for a Level of Confidence of 95% (U = 2Uc(y))	2.8dB
---	-------

### Uncertainty of Radiated Emission Measurement (1 GHz ~ 18 GHz)

Measuring Uncertainty for a Level of Confidence of 95% (U = 2Uc(y))	3.1dB
---	-------

### Uncertainty of Radiated Emission Measurement (18 GHz ~ 40 GHz)

Measuring Uncertainty for a Level of Confidence of 95% (U = 2Uc(y))	3.9dB
---	-------



# Appendix A. Test Results of Conducted Test

## Conducted Output Power(Average power)

Bottom antenna:

LTE Band 4						
BW [MHz]	Modulation	RB Size	RB Offset	Power Low Ch. / Freq.	Power Middle Ch. / Freq.	Power High Ch. / Freq.
Channel				20050	20175	20300
Frequency (MHz)				1720	1732.5	1745
20	QPSK	1	0	22.65	22.84	22.77
20	QPSK	1	49	22.55	22.69	22.63
20	QPSK	1	99	22.52	22.58	22.56
20	QPSK	50	0	21.64	21.84	21.73
20	QPSK	50	24	21.69	21.78	21.72
20	QPSK	50	50	21.65	21.71	21.68
20	QPSK	100	0	21.68	21.75	21.71
20	16QAM	1	0	21.93	22.13	22.00
20	16QAM	1	49	21.85	21.99	22.04
20	16QAM	1	99	21.82	21.93	22.01
20	16QAM	50	0	20.62	20.75	20.82
20	16QAM	50	24	20.74	20.72	20.80
20	16QAM	50	50	20.68	20.66	20.73
20	16QAM	100	0	20.68	20.71	20.77
20	64QAM	1	0	20.80	20.96	20.95
20	64QAM	1	49	20.78	20.93	20.84
20	64QAM	1	99	20.74	20.81	20.80
20	64QAM	50	0	19.66	19.78	19.83
20	64QAM	50	24	19.71	19.76	19.82
20	64QAM	50	50	19.67	19.65	19.74
20	64QAM	100	0	19.72	19.72	19.78
Channel				20025	20175	20325
Frequency (MHz)				1717.5	1732.5	1747.5
15	QPSK	1	0	22.52	22.79	22.76



15	QPSK	1	37	22.57	22.59	22.63
15	QPSK	1	74	22.45	22.61	22.63
15	QPSK	36	0	21.65	21.64	21.78
15	QPSK	36	20	21.71	21.78	21.80
15	QPSK	36	39	21.64	21.65	21.69
15	QPSK	75	0	21.64	21.69	21.75
15	16QAM	1	0	22.31	22.05	22.24
15	16QAM	1	37	21.88	22.23	22.15
15	16QAM	1	74	21.97	21.83	22.33
15	16QAM	36	0	20.59	20.75	20.92
15	16QAM	36	20	20.74	20.73	20.83
15	16QAM	36	39	20.60	20.70	20.80
15	16QAM	75	0	20.64	20.70	20.80
15	64QAM	1	0	20.55	20.67	20.54
15	64QAM	1	37	20.60	21.04	20.76
15	64QAM	1	74	20.86	20.94	20.77
15	64QAM	36	0	19.66	19.76	19.88
15	64QAM	36	20	19.76	19.72	19.80
15	64QAM	36	39	19.78	19.69	19.69
15	64QAM	75	0	19.64	19.75	19.81
Channel				20000	20175	20350
Frequency (MHz)				1715	1732.5	1750
10	QPSK	1	0	22.68	22.64	22.78
10	QPSK	1	25	22.58	22.80	22.70
10	QPSK	1	49	22.71	22.72	22.76
10	QPSK	25	0	21.84	21.85	21.84
10	QPSK	25	12	21.80	21.90	21.86
10	QPSK	25	25	21.75	21.79	21.82
10	QPSK	50	0	21.72	21.85	21.83
10	16QAM	1	0	22.19	21.93	21.93
10	16QAM	1	25	22.15	21.77	22.05
10	16QAM	1	49	22.03	22.21	21.80
10	16QAM	25	0	20.84	20.92	20.90
10	16QAM	25	12	20.80	20.93	20.77
10	16QAM	25	25	20.79	20.66	20.87
10	16QAM	50	0	20.82	20.78	20.87



10	64QAM	1	0	20.61	20.99	20.90
10	64QAM	1	25	20.91	20.92	20.68
10	64QAM	1	49	20.94	21.11	20.85
10	64QAM	25	0	19.87	19.93	19.91
10	64QAM	25	12	19.88	19.87	19.89
10	64QAM	25	25	19.79	19.88	19.88
10	64QAM	50	0	19.89	19.89	19.87
Channel				19975	20175	20375
Frequency (MHz)				1712.5	1732.5	1752.5
5	QPSK	1	0	22.77	22.79	22.74
5	QPSK	1	12	22.66	22.72	22.71
5	QPSK	1	24	22.71	22.70	22.62
5	QPSK	12	0	21.78	21.90	21.73
5	QPSK	12	7	21.78	21.94	21.87
5	QPSK	12	13	21.80	21.97	21.74
5	QPSK	25	0	21.77	21.84	21.83
5	16QAM	1	0	22.25	21.87	22.28
5	16QAM	1	12	22.14	21.83	22.21
5	16QAM	1	24	22.22	21.87	22.24
5	16QAM	12	0	20.81	20.80	20.88
5	16QAM	12	7	20.80	20.85	20.84
5	16QAM	12	13	20.72	20.86	20.81
5	16QAM	25	0	20.82	20.81	20.80
5	64QAM	1	0	20.78	21.18	20.89
5	64QAM	1	12	20.85	21.11	20.84
5	64QAM	1	24	21.23	21.21	20.75
5	64QAM	12	0	19.85	19.93	19.81
5	64QAM	12	7	19.78	19.91	19.83
5	64QAM	12	13	19.95	19.98	19.89
5	64QAM	25	0	19.77	19.82	19.80
Channel				19965	20175	20385
Frequency (MHz)				1711.5	1732.5	1753.5
3	QPSK	1	0	22.61	22.80	22.73
3	QPSK	1	8	22.67	22.78	22.70
3	QPSK	1	14	22.71	22.80	22.69
3	QPSK	8	0	21.87	21.92	21.72



3	QPSK	8	4	21.77	21.89	21.71
3	QPSK	8	7	21.73	21.91	21.74
3	QPSK	15	0	21.80	21.76	21.74
3	16QAM	1	0	21.94	22.40	22.28
3	16QAM	1	8	21.93	22.40	22.16
3	16QAM	1	14	21.99	21.91	22.22
3	16QAM	8	0	20.84	20.87	20.78
3	16QAM	8	4	20.86	20.91	20.74
3	16QAM	8	7	20.81	20.98	20.79
3	16QAM	15	0	20.83	20.92	20.82
3	64QAM	1	0	21.06	20.68	21.05
3	64QAM	1	8	20.81	21.03	20.69
3	64QAM	1	14	21.03	20.94	20.66
3	64QAM	8	0	19.79	19.87	19.88
3	64QAM	8	4	19.88	20.01	19.84
3	64QAM	8	7	19.78	19.86	19.83
3	64QAM	15	0	19.79	19.91	19.78
Channel				19957	20175	20393
Frequency (MHz)				1710.7	1732.5	1754.3
1.4	QPSK	1	0	22.61	22.73	22.52
1.4	QPSK	1	3	22.55	22.83	22.65
1.4	QPSK	1	5	22.49	22.73	22.57
1.4	QPSK	3	0	22.61	22.69	22.60
1.4	QPSK	3	1	22.59	22.70	22.64
1.4	QPSK	3	3	22.53	22.71	22.62
1.4	QPSK	6	0	21.07	21.12	21.16
1.4	16QAM	1	0	21.69	21.86	22.00
1.4	16QAM	1	3	21.51	21.95	21.86
1.4	16QAM	1	5	21.63	21.72	21.97
1.4	16QAM	3	0	21.77	21.80	21.68
1.4	16QAM	3	1	21.72	21.90	21.72
1.4	16QAM	3	3	21.67	21.76	21.48
1.4	16QAM	6	0	20.23	20.71	20.67
1.4	64QAM	1	0	20.02	20.00	20.41
1.4	64QAM	1	3	20.09	20.15	20.49
1.4	64QAM	1	5	20.09	20.36	20.25



---

1.4	64QAM	3	0	20.48	20.82	20.91
1.4	64QAM	3	1	20.51	20.91	20.92
1.4	64QAM	3	3	20.97	20.80	20.89
1.4	64QAM	6	0	19.65	19.97	19.59





LTE Band 7						
BW [MHz]	Modulation	RB Size	RB Offset	Power Low Ch. / Freq.	Power Middle Ch. / Freq.	Power High Ch. / Freq.
Channel				20850	21100	21350
Frequency (MHz)				2510	2535	2560
20	QPSK	1	0	22.24	22.38	22.57
20	QPSK	1	49	22.28	22.48	22.60
20	QPSK	1	99	22.36	22.58	22.71
20	QPSK	50	0	21.30	21.48	21.58
20	QPSK	50	24	21.39	21.50	21.63
20	QPSK	50	50	21.41	21.61	21.72
20	QPSK	100	0	21.41	21.53	21.64
20	16QAM	1	0	21.48	21.59	21.80
20	16QAM	1	49	21.49	21.73	21.82
20	16QAM	1	99	21.63	21.89	21.91
20	16QAM	50	0	20.29	20.50	20.57
20	16QAM	50	24	20.41	20.53	20.63
20	16QAM	50	50	20.44	20.64	20.72
20	16QAM	100	0	20.40	20.54	20.62
20	64QAM	1	0	20.44	20.51	20.61
20	64QAM	1	49	20.39	20.63	20.76
20	64QAM	1	99	20.48	20.76	20.82
20	64QAM	50	0	19.31	19.50	19.59
20	64QAM	50	24	19.44	19.54	19.64
20	64QAM	50	50	19.45	19.63	19.74
20	64QAM	100	0	19.41	19.53	19.06
Channel				20825	21100	21375
Frequency (MHz)				2507.5	2535	2562.5
15	QPSK	1	0	22.21	22.37	22.44
15	QPSK	1	37	22.22	22.41	22.57
15	QPSK	1	74	22.25	22.44	22.61
15	QPSK	36	0	21.30	21.51	21.61
15	QPSK	36	20	21.34	21.57	21.63
15	QPSK	36	39	21.39	21.72	21.71
15	QPSK	75	0	21.28	21.44	21.60



15	16QAM	1	0	21.24	21.47	21.39
15	16QAM	1	37	21.70	21.41	21.33
15	16QAM	1	74	21.72	21.63	21.49
15	16QAM	36	0	20.32	20.41	20.60
15	16QAM	36	20	20.38	20.55	20.71
15	16QAM	36	39	20.35	20.59	20.69
15	16QAM	75	0	20.31	20.53	20.59
15	64QAM	1	0	20.42	20.60	20.46
15	64QAM	1	37	20.49	20.50	20.64
15	64QAM	1	74	20.50	20.88	20.62
15	64QAM	36	0	19.34	19.41	19.57
15	64QAM	36	20	19.30	19.59	19.60
15	64QAM	36	39	19.31	19.60	19.66
15	64QAM	75	0	19.28	19.54	19.52
Channel				20800	21100	21400
Frequency (MHz)				2505	2535	2565
10	QPSK	1	0	22.27	22.69	22.68
10	QPSK	1	25	22.29	22.37	22.68
10	QPSK	1	49	22.34	22.52	22.48
10	QPSK	25	0	21.39	21.65	21.79
10	QPSK	25	12	21.51	21.70	21.86
10	QPSK	25	25	21.46	21.69	21.83
10	QPSK	50	0	21.41	21.64	21.78
10	16QAM	1	0	21.79	21.98	21.65
10	16QAM	1	25	21.90	21.81	21.75
10	16QAM	1	49	21.98	22.01	21.98
10	16QAM	25	0	20.53	20.57	20.83
10	16QAM	25	12	20.47	20.63	20.85
10	16QAM	25	25	20.51	20.70	20.93
10	16QAM	50	0	20.41	20.61	20.75
10	64QAM	1	0	20.81	20.72	20.94
10	64QAM	1	25	20.79	20.61	21.10
10	64QAM	1	49	20.71	21.07	21.04
10	64QAM	25	0	19.49	19.62	19.73
10	64QAM	25	12	19.44	19.65	19.76
10	64QAM	25	25	19.44	19.69	19.83



10	64QAM	50	0	19.44	19.63	19.69
Channel				20775	21100	21425
Frequency (MHz)				2502.5	2535	2567.5
5	QPSK	1	0	22.44	22.55	22.64
5	QPSK	1	12	22.47	22.64	22.56
5	QPSK	1	24	22.45	22.68	22.51
5	QPSK	12	0	21.46	21.51	21.70
5	QPSK	12	7	21.40	21.71	21.86
5	QPSK	12	13	21.47	21.66	21.88
5	QPSK	25	0	21.38	21.56	21.80
5	16QAM	1	0	21.60	21.74	21.98
5	16QAM	1	12	21.60	21.87	22.06
5	16QAM	1	24	21.64	21.82	22.09
5	16QAM	12	0	20.42	20.60	20.80
5	16QAM	12	7	20.48	20.80	20.89
5	16QAM	12	13	20.45	20.76	20.92
5	16QAM	25	0	20.39	20.63	20.82
5	64QAM	1	0	20.80	20.74	21.12
5	64QAM	1	12	20.77	20.79	21.18
5	64QAM	1	24	20.78	20.85	21.21
5	64QAM	12	0	19.56	19.58	19.81
5	64QAM	12	7	19.57	19.85	19.94
5	64QAM	12	13	19.52	19.74	19.98
5	64QAM	25	0	19.48	19.67	19.88



LTE Band 66						
BW [MHz]	Modulation	RB Size	RB Offset	Power Low Ch. / Freq.	Power Middle Ch. / Freq.	Power High Ch. / Freq.
Channel				132072	132322	132572
Frequency (MHz)				1720	1745	1770
20	QPSK	1	0	22.67	22.91	22.62
20	QPSK	1	49	22.49	22.85	22.45
20	QPSK	1	99	22.62	22.73	22.53
20	QPSK	50	0	21.66	21.77	21.60
20	QPSK	50	24	21.74	21.80	21.65
20	QPSK	50	50	21.72	21.76	21.58
20	QPSK	100	0	21.72	21.74	21.64
20	16QAM	1	0	21.95	21.73	22.21
20	16QAM	1	49	22.03	21.86	21.97
20	16QAM	1	99	22.09	21.80	21.79
20	16QAM	50	0	20.72	20.82	20.53
20	16QAM	50	24	20.71	20.78	20.64
20	16QAM	50	50	20.72	20.86	20.54
20	16QAM	100	0	20.80	20.81	20.58
20	64QAM	1	0	20.74	20.89	20.57
20	64QAM	1	49	20.90	20.97	20.55
20	64QAM	1	99	20.87	20.85	20.51
20	64QAM	50	0	19.65	19.84	19.76
20	64QAM	50	24	19.72	19.82	19.73
20	64QAM	50	50	19.71	19.77	19.65
20	64QAM	100	0	19.72	19.81	19.68
Channel				132047	132322	132597
Frequency (MHz)				1717.5	1745	1772.5
15	QPSK	1	0	22.62	22.81	22.62
15	QPSK	1	37	22.63	22.84	22.56
15	QPSK	1	74	22.65	22.74	22.45
15	QPSK	36	0	21.64	21.80	21.59
15	QPSK	36	20	21.71	21.91	21.62
15	QPSK	36	39	21.71	21.78	21.53
15	QPSK	75	0	21.69	21.76	21.58



15	16QAM	1	0	22.11	22.07	21.87
15	16QAM	1	37	22.10	22.21	21.73
15	16QAM	1	74	22.13	22.11	21.79
15	16QAM	36	0	20.74	20.95	20.56
15	16QAM	36	20	20.72	20.96	20.67
15	16QAM	36	39	20.71	20.78	20.59
15	16QAM	75	0	20.65	20.86	20.65
15	64QAM	1	0	20.78	20.93	20.82
15	64QAM	1	37	20.57	21.06	20.87
15	64QAM	1	74	20.75	21.05	20.71
15	64QAM	36	0	19.62	19.88	19.65
15	64QAM	36	20	19.67	19.97	19.70
15	64QAM	36	39	19.70	19.88	19.61
15	64QAM	75	0	19.72	19.74	19.56
Channel				132022	132322	132622
Frequency (MHz)				1715	1745	1775
10	QPSK	1	0	22.88	22.66	22.81
10	QPSK	1	25	22.72	22.78	22.53
10	QPSK	1	49	22.68	22.80	22.45
10	QPSK	25	0	21.78	21.91	21.66
10	QPSK	25	12	21.84	21.82	21.66
10	QPSK	25	25	21.72	21.89	21.69
10	QPSK	50	0	21.75	21.84	21.69
10	16QAM	1	0	21.81	21.84	21.75
10	16QAM	1	25	21.58	21.76	21.64
10	16QAM	1	49	22.05	21.90	21.74
10	16QAM	25	0	20.85	20.90	20.68
10	16QAM	25	12	20.85	20.99	20.71
10	16QAM	25	25	20.80	20.85	20.58
10	16QAM	50	0	20.78	20.98	20.67
10	64QAM	1	0	21.13	21.22	20.98
10	64QAM	1	25	21.03	20.95	20.87
10	64QAM	1	49	20.93	20.90	20.79
10	64QAM	25	0	19.85	19.88	19.78
10	64QAM	25	12	19.93	19.97	19.80
10	64QAM	25	25	19.74	19.93	19.68



10	64QAM	50	0	19.77	19.90	19.77
Channel				131997	132322	132647
Frequency (MHz)				1712.5	1745	1777.5
5	QPSK	1	0	22.73	22.87	22.56
5	QPSK	1	12	22.62	22.89	22.52
5	QPSK	1	24	22.67	22.80	22.43
5	QPSK	12	0	21.79	21.93	21.63
5	QPSK	12	7	21.79	21.92	21.58
5	QPSK	12	13	21.78	21.88	21.56
5	QPSK	25	0	21.80	21.89	21.66
5	16QAM	1	0	22.24	22.07	22.01
5	16QAM	1	12	22.16	22.06	21.90
5	16QAM	1	24	22.03	22.35	22.20
5	16QAM	12	0	20.80	20.90	20.60
5	16QAM	12	7	20.73	20.84	20.65
5	16QAM	12	13	20.79	20.90	20.60
5	16QAM	25	0	20.88	20.94	20.58
5	64QAM	1	0	21.07	20.72	20.77
5	64QAM	1	12	20.84	20.77	20.78
5	64QAM	1	24	20.67	21.02	20.84
5	64QAM	12	0	19.84	20.01	19.64
5	64QAM	12	7	19.87	19.94	19.78
5	64QAM	12	13	19.84	19.91	19.77
5	64QAM	25	0	19.79	19.99	19.64
Channel				131987	132322	132657
Frequency (MHz)				1711.5	1745	1778.5
3	QPSK	1	0	22.78	22.82	22.57
3	QPSK	1	8	22.76	22.89	22.57
3	QPSK	1	14	22.70	22.86	22.53
3	QPSK	8	0	21.77	21.92	21.62
3	QPSK	8	4	21.75	21.87	21.65
3	QPSK	8	7	21.75	21.94	21.57
3	QPSK	15	0	21.74	21.95	21.59
3	16QAM	1	0	22.04	22.43	22.09
3	16QAM	1	8	22.11	22.12	21.98
3	16QAM	1	14	21.95	22.11	22.03



3	16QAM	8	0	20.80	20.91	20.63
3	16QAM	8	4	20.90	21.09	20.65
3	16QAM	8	7	20.83	21.00	20.67
3	16QAM	15	0	20.78	20.80	20.61
3	64QAM	1	0	20.87	21.21	20.90
3	64QAM	1	8	20.93	21.35	20.96
3	64QAM	1	14	20.91	21.28	20.86
3	64QAM	8	0	19.88	19.92	19.78
3	64QAM	8	4	19.94	19.94	19.68
3	64QAM	8	7	19.76	19.96	19.71
3	64QAM	15	0	19.75	19.91	19.68
Channel				131979	132322	132665
Frequency (MHz)				1710.7	1745	1779.3
1.4	QPSK	1	0	22.56	22.75	22.43
1.4	QPSK	1	3	22.63	22.89	22.53
1.4	QPSK	1	5	22.51	22.81	22.45
1.4	QPSK	3	0	22.63	22.87	22.50
1.4	QPSK	3	1	22.56	22.87	22.44
1.4	QPSK	3	3	22.62	22.79	22.51
1.4	QPSK	6	0	21.63	21.82	21.52
1.4	16QAM	1	0	21.79	22.16	21.79
1.4	16QAM	1	3	21.86	22.12	21.76
1.4	16QAM	1	5	21.69	22.03	21.76
1.4	16QAM	3	0	21.64	21.93	21.62
1.4	16QAM	3	1	21.61	22.02	21.69
1.4	16QAM	3	3	21.70	21.90	21.66
1.4	16QAM	6	0	20.69	21.09	20.66
1.4	64QAM	1	0	20.60	20.66	20.61
1.4	64QAM	1	3	21.07	20.99	20.77
1.4	64QAM	1	5	20.88	20.66	20.64
1.4	64QAM	3	0	20.78	20.99	20.61
1.4	64QAM	3	1	20.83	21.09	20.95
1.4	64QAM	3	3	20.77	21.09	20.79
1.4	64QAM	6	0	19.64	19.86	19.61



LTE Band 38						
BW [MHz]	Modulation	RB Size	RB Offset	Power Low Ch. / Freq.	Power Middle Ch. / Freq.	Power High Ch. / Freq.
Channel				37850	38000	38150
Frequency (MHz)				2580	2595	2610
20	QPSK	1	0	22.44	22.26	22.49
20	QPSK	1	49	22.49	22.44	22.61
20	QPSK	1	99	22.64	22.48	22.68
20	QPSK	50	0	21.49	21.45	21.59
20	QPSK	50	24	21.53	21.41	21.66
20	QPSK	50	50	21.67	21.64	21.74
20	QPSK	100	0	21.58	21.56	21.62
20	16QAM	1	0	21.64	21.60	21.75
20	16QAM	1	49	21.69	21.55	21.73
20	16QAM	1	99	21.65	21.62	21.79
20	16QAM	50	0	20.62	20.48	20.61
20	16QAM	50	24	20.75	20.47	20.67
20	16QAM	50	50	20.74	20.62	20.76
20	16QAM	100	0	20.62	20.50	20.65
20	64QAM	1	0	20.29	20.13	20.44
20	64QAM	1	49	20.44	20.27	20.30
20	64QAM	1	99	20.21	20.18	20.28
20	64QAM	50	0	19.55	19.50	19.60
20	64QAM	50	24	19.71	19.39	19.72
20	64QAM	50	50	19.66	19.57	19.78
20	64QAM	100	0	19.61	19.53	19.60
Channel				37825	38000	38175
Frequency (MHz)				2577.5	2595	2612.5
15	QPSK	1	0	22.48	22.27	22.62
15	QPSK	1	37	22.45	22.36	22.61
15	QPSK	1	74	22.55	22.44	22.54
15	QPSK	36	0	21.61	21.42	21.53
15	QPSK	36	20	21.69	21.57	21.64
15	QPSK	36	39	21.59	21.48	21.67
15	QPSK	75	0	21.67	21.55	21.62





15	16QAM	1	0	21.73	21.60	21.78
15	16QAM	1	37	21.53	21.50	21.80
15	16QAM	1	74	21.72	21.69	21.83
15	16QAM	36	0	20.58	20.42	20.59
15	16QAM	36	20	20.66	20.46	20.72
15	16QAM	36	39	20.66	20.48	20.70
15	16QAM	75	0	20.61	20.50	20.63
15	64QAM	1	0	20.16	20.20	20.44
15	64QAM	1	37	20.53	20.06	20.30
15	64QAM	1	74	20.20	20.44	20.45
15	64QAM	36	0	19.59	19.31	19.68
15	64QAM	36	20	19.71	19.59	19.66
15	64QAM	36	39	19.68	19.54	19.75
15	64QAM	75	0	19.65	19.55	19.66
Channel				37800	38000	38200
Frequency (MHz)				2575	2595	2615
10	QPSK	1	0	22.49	22.35	22.35
10	QPSK	1	25	22.59	22.57	22.65
10	QPSK	1	49	22.62	22.47	22.51
10	QPSK	25	0	21.81	21.53	21.75
10	QPSK	25	12	21.80	21.59	21.84
10	QPSK	25	25	21.74	21.59	21.78
10	QPSK	50	0	21.82	21.61	21.72
10	16QAM	1	0	21.82	21.64	21.71
10	16QAM	1	25	21.82	21.53	21.97
10	16QAM	1	49	21.70	21.73	21.98
10	16QAM	25	0	20.68	20.57	20.80
10	16QAM	25	12	20.85	20.46	20.70
10	16QAM	25	25	20.65	20.59	20.93
10	16QAM	50	0	20.84	20.63	20.78
10	64QAM	1	0	20.69	20.46	20.66
10	64QAM	1	25	20.42	20.37	20.58
10	64QAM	1	49	20.69	20.54	20.79
10	64QAM	25	0	19.85	19.70	19.88
10	64QAM	25	12	19.67	19.63	19.85
10	64QAM	25	25	19.76	19.80	19.97



10	64QAM	50	0	19.85	19.74	19.80
Channel				37775	38000	38225
Frequency (MHz)				2572.5	2595	2617.5
5	QPSK	1	0	22.6	22.54	22.61
5	QPSK	1	12	22.63	22.53	22.65
5	QPSK	1	24	22.49	22.56	22.60
5	QPSK	12	0	21.78	21.54	21.80
5	QPSK	12	7	21.77	21.64	21.74
5	QPSK	12	13	21.77	21.66	21.80
5	QPSK	25	0	21.79	21.52	21.76
5	16QAM	1	0	21.89	21.65	21.80
5	16QAM	1	12	21.89	21.65	22.03
5	16QAM	1	24	21.9	21.72	21.94
5	16QAM	12	0	20.74	20.51	20.73
5	16QAM	12	7	20.75	20.6	20.77
5	16QAM	12	13	20.79	20.68	20.91
5	16QAM	25	0	20.8	20.66	20.69
5	64QAM	1	0	20.56	20.4	20.69
5	64QAM	1	12	20.53	20.37	20.49
5	64QAM	1	24	20.65	20.48	20.87
5	64QAM	12	0	19.74	19.62	19.83
5	64QAM	12	7	19.84	19.69	19.90
5	64QAM	12	13	19.88	19.67	19.87
5	64QAM	25	0	19.84	19.66	19.72



LTE Band 41						
BW [MHz]	Modulation	RB Size	RB Offset	Power Low Ch. / Freq.	Power Middle Ch. / Freq.	Power High Ch. / Freq.
Channel				39750	40620	41490
Frequency (MHz)				2506	2593	2680
20	QPSK	1	0	25.92	26.08	25.97
20	QPSK	1	49	25.95	26.10	25.95
20	QPSK	1	99	26.03	26.14	26.28
20	QPSK	50	0	24.33	24.46	24.36
20	QPSK	50	24	24.40	24.41	24.38
20	QPSK	50	50	24.48	24.49	24.60
20	QPSK	100	0	24.40	24.47	24.60
20	16QAM	1	0	24.53	24.73	24.63
20	16QAM	1	49	24.47	24.68	24.57
20	16QAM	1	99	24.52	24.76	24.61
20	16QAM	50	0	23.32	23.50	23.35
20	16QAM	50	24	23.43	23.53	23.38
20	16QAM	50	50	23.43	23.63	23.48
20	16QAM	100	0	23.43	23.51	23.38
20	64QAM	1	0	24.32	24.61	24.40
20	64QAM	1	49	24.35	24.50	24.50
20	64QAM	1	99	24.41	24.61	24.54
20	64QAM	50	0	23.26	23.44	23.28
20	64QAM	50	24	23.36	23.47	23.35
20	64QAM	50	50	23.33	23.58	23.41
20	64QAM	100	0	23.45	23.55	23.42
Channel				39725	40620	41515
Frequency (MHz)				2503.5	2593	2682.5
15	QPSK	1	0	25.96	26.20	25.98
15	QPSK	1	37	25.98	26.20	26.01
15	QPSK	1	74	25.96	26.23	26.11
15	QPSK	36	0	24.34	24.51	24.33
15	QPSK	36	20	24.34	24.50	24.34
15	QPSK	36	39	24.35	24.61	24.42
15	QPSK	75	0	24.37	24.51	24.35



15	16QAM	1	0	24.46	24.73	24.53
15	16QAM	1	37	24.46	24.71	24.51
15	16QAM	1	74	24.52	24.77	24.64
15	16QAM	36	0	23.33	23.45	23.28
15	16QAM	36	20	23.34	23.45	23.33
15	16QAM	36	39	23.34	23.56	23.41
15	16QAM	75	0	23.39	23.53	23.39
15	64QAM	1	0	24.33	24.60	24.47
15	64QAM	1	37	24.33	24.56	24.38
15	64QAM	1	74	24.33	24.65	24.44
15	64QAM	36	0	23.33	23.51	23.33
15	64QAM	36	20	23.36	23.52	23.35
15	64QAM	36	39	23.36	23.60	23.43
15	64QAM	75	0	23.41	23.52	23.36
Channel				39700	40620	41540
Frequency (MHz)				2501	2593	2685
10	QPSK	1	0	26.10	26.25	26.15
10	QPSK	1	25	26.08	26.24	26.19
10	QPSK	1	49	26.02	26.10	26.17
10	QPSK	25	0	24.44	24.57	24.45
10	QPSK	25	12	24.47	24.65	24.49
10	QPSK	25	25	24.48	24.75	24.53
10	QPSK	50	0	24.45	24.63	24.48
10	16QAM	1	0	24.64	24.84	24.69
10	16QAM	1	25	24.60	24.86	24.75
10	16QAM	1	49	24.64	24.89	24.68
10	16QAM	25	0	23.48	23.65	23.48
10	16QAM	25	12	23.48	23.66	23.50
10	16QAM	25	25	23.48	23.76	23.59
10	16QAM	50	0	23.49	23.65	23.52
10	64QAM	1	0	24.55	24.76	24.56
10	64QAM	1	25	24.45	24.74	24.57
10	64QAM	1	49	24.52	24.72	24.61
10	64QAM	25	0	23.46	23.58	23.44
10	64QAM	25	12	23.48	23.64	23.48
10	64QAM	25	25	23.43	23.71	23.52



10	64QAM	50	0	23.44	23.59	23.46
Channel				39675	40620	41565
Frequency (MHz)				2498.5	2593	2687.5
5	QPSK	1	0	26.12	26.25	26.18
5	QPSK	1	12	26.09	26.21	26.13
5	QPSK	1	24	26.11	26.28	26.14
5	QPSK	12	0	24.45	24.64	24.53
5	QPSK	12	7	24.48	24.75	24.55
5	QPSK	12	13	24.45	24.73	24.52
5	QPSK	25	0	24.46	24.63	24.51
5	16QAM	1	0	24.68	24.74	24.64
5	16QAM	1	12	24.69	24.89	24.70
5	16QAM	1	24	24.63	24.95	24.67
5	16QAM	12	0	23.51	23.68	23.54
5	16QAM	12	7	23.56	23.79	23.60
5	16QAM	12	13	23.53	23.74	23.56
5	16QAM	25	0	23.48	23.68	23.56
5	64QAM	1	0	24.53	24.68	24.59
5	64QAM	1	12	24.45	24.72	24.56
5	64QAM	1	24	24.54	24.86	24.56
5	64QAM	12	0	23.43	23.61	23.50
5	64QAM	12	7	23.48	23.74	23.57
5	64QAM	12	13	23.46	23.71	23.51
5	64QAM	25	0	23.42	23.64	23.51



CA_66B									
Combination 10MHz+10MHz (50RB+50RB)									
PCC Channel	SCC Channel	Modulation	PCC		SCC		Total RB Size	Target MPR Level (dB)	Measured Power (dBm)
			RB Size	RB offset	RB Size	RB offset			
13202 2	13212 1	QPSK	50	0	50	0	100	≤2	22.82
			1	0	1	49	2	≤8.5	14.33
			1	49	1	0	2	≤0	23.12
		16QAM	50	0	50	0	100	≤3	21.87
			1	0	1	49	2	≤8.5	14.57
			1	49	1	0	2	≤1	23.08
		64QAM	50	0	50	0	100	≤3	21.83
			1	0	1	49	2	≤8.5	14.53
			1	49	1	0	2	≤3	22.35
13237 3	13247 2	QPSK	50	0	50	0	100	≤2	22.81
			1	0	1	49	2	≤8.5	14.08
			1	49	1	0	2	≤0	23.04
		16QAM	50	0	50	0	100	≤3	21.76
			1	0	1	49	2	≤8.5	14.46
			1	49	1	0	2	≤1	23.79
		64QAM	50	0	50	0	100	≤3	21.61
			1	0	1	49	2	≤8.5	14.45
			1	49	1	0	2	≤3	21.82
13252 3	13262 2	QPSK	50	0	50	0	100	≤2	22.74
			1	0	1	49	2	≤8.5	14.04
			1	49	1	0	2	≤0	23.04
		16QAM	50	0	50	0	100	≤3	21.71
			1	0	1	49	2	≤8.5	14.43
			1	49	1	0	2	≤1	23.08
		64QAM	50	0	50	0	100	≤3	21.76
			1	0	1	49	2	≤8.5	14.41
			1	49	1	0	2	≤3	21.87



CA_66C									
Combination 20MHz+20MHz (100RB+100RB)									
PCC Channel	SCC Channel	Modulation	PCC		SCC		Total RB Size	Target MPR Level (dB)	Measured Power (dBm)
			RB Size	RB offset	RB Size	RB offset			
132072	132270	QPSK	100	0	100	0	200	≤2	23.33
			1	0	1	99	2	≤8.5	16.18
			1	99	1	0	2	≤0	22.66
		16QAM	100	0	100	0	200	≤3	21.88
			1	0	1	99	2	≤8.5	16.83
			1	99	1	0	2	≤1	22.22
		64QAM	100	0	100	0	200	≤3	21.93
			1	0	1	99	2	≤8.5	16.47
			1	99	1	0	2	≤3	21.46
132323	132521	QPSK	100	0	100	0	200	≤2	22.74
			1	0	1	99	2	≤8.5	16.29
			1	99	1	0	2	≤0	22.57
		16QAM	100	0	100	0	200	≤3	21.79
			1	0	1	99	2	≤8.5	16.73
			1	99	1	0	2	≤1	22.08
		64QAM	100	0	100	0	200	≤3	21.71
			1	0	1	99	2	≤8.5	16.47
			1	99	1	0	2	≤3	21.46
132374	132572	QPSK	100	0	100	0	200	≤2	22.81
			1	0	1	99	2	≤8.5	16.15
			1	99	1	0	2	≤0	22.64
		16QAM	100	0	100	0	200	≤3	21.91
			1	0	1	99	2	≤8.5	16.47
			1	99	1	0	2	≤1	22.10
		64QAM	100	0	100	0	200	≤3	21.71
			1	0	1	99	2	≤8.5	16.38
			1	99	1	0	2	≤3	21.34



CA_41C									
Combination 20MHz+20MHz (100RB+100RB)									
PCC Channel	SCC Channel	Modulation	PCC		SCC		Total RB Size	Target MPR Level (dB)	Measured Power (dBm)
			RB Size	RB offset	RB Size	RB offset			
39750	39948	QPSK	100	0	100	0	200	≤2	19.65
			1	0	1	99	2	≤8.5	14.85
			1	99	1	0	2	≤0	21.51
		16QAM	100	0	100	0	200	≤3	20.69
			1	0	1	99	2	≤8.5	15.40
			1	99	1	0	2	≤1	20.07
		64QAM	100	0	100	0	200	≤3	20.66
			1	0	1	99	2	≤8.5	14.93
			1	99	1	0	2	≤3	19.74
40521	40719	QPSK	100	0	100	0	200	≤2	21.76
			1	0	1	99	2	≤8.5	15.10
			1	99	1	0	2	≤0	21.85
		16QAM	100	0	100	0	200	≤3	20.79
			1	0	1	99	2	≤8.5	15.33
			1	99	1	0	2	≤1	20.34
		64QAM	100	0	100	0	200	≤3	20.80
			1	0	1	99	2	≤8.5	15.17
			1	99	1	0	2	≤3	19.96
41292	41490	QPSK	100	0	100	0	200	≤2	22.02
			1	0	1	99	2	≤8.5	15.25
			1	99	1	0	2	≤0	23.54
		16QAM	100	0	100	0	200	≤3	21.03
			1	0	1	99	2	≤8.5	15.73
			1	99	1	0	2	≤1	20.49
		64QAM	100	0	100	0	200	≤3	21.05
			1	0	1	99	2	≤8.5	15.33
			1	99	1	0	2	≤3	20.13





**EIRP**

LTE Band 7 (GT - LC = 0.60 dB) QPSK			
Bandwidth	5M		
Channel	20775	21100	21425
	(Low)	(Mid)	(High)
Frequency	2502.5	2535	2567.5
(MHz)			
Conducted Power (dBm)	22.45	22.68	22.51
Conducted Power (Watts)	0.1758	0.1854	0.1782
EIRP(dBm)	23.05	23.28	23.11
EIRP(Watts)	0.2018	0.2128	0.2046

LTE Band 7 (GT - LC = 0.60 dB) QPSK									
Bandwidth	10M			15M			20M		
Channel	20800	21100	21400	20825	21100	21375	20850	21100	21350
	(Low)	(Mid)	(High)	(Low)	(Mid)	(High)	(Low)	(Mid)	(High)
Frequency	2505	2535	2565	2507.5	2535	2562.5	2510	2535	2560
(MHz)									
Conducted Power (dBm)	22.27	22.69	22.68	22.25	22.44	22.61	22.36	22.58	22.71
Conducted Power (Watts)	0.1687	0.1858	0.1854	0.1679	0.1754	0.1824	0.1722	0.1811	0.1866
EIRP(dBm)	22.87	23.29	23.28	22.85	23.04	23.21	22.96	23.18	23.31
EIRP(Watts)	0.1936	0.2133	0.2128	0.1928	0.2014	0.2094	0.1977	0.2080	0.2143



LTE Band 7 (GT - LC = 0.60 dB) 16QAM			
Bandwidth	5M		
Channel	20775	21100	21425
	(Low)	(Mid)	(High)
Frequency	2502.5	2535	2567.5
(MHz)			
Conducted Power (dBm)	21.64	21.82	22.09
Conducted Power (Watts)	0.1459	0.1521	0.1618
EIRP(dBm)	22.24	22.42	22.69
EIRP(Watts)	0.1675	0.1746	0.1858

LTE Band 7 (GT - LC = 0.60 dB) 16QAM									
Bandwidth	10M			15M			20M		
Channel	20800	21100	21400	20825	21100	21375	20850	21100	21350
	(Low)	(Mid)	(High)	(Low)	(Mid)	(High)	(Low)	(Mid)	(High)
Frequency	2505	2535	2565	2507.5	2535	2562.5	2510	2535	2560
(MHz)									
Conducted Power (dBm)	21.98	22.01	21.98	21.72	21.63	21.49	21.63	21.89	21.91
Conducted Power (Watts)	0.1578	0.1589	0.1578	0.1486	0.1455	0.1409	0.1455	0.1545	0.1552
EIRP(dBm)	22.58	22.61	22.58	22.32	22.23	22.09	22.23	22.49	22.51
EIRP(Watts)	0.1811	0.1824	0.1811	0.1706	0.1671	0.1618	0.1671	0.1774	0.1782



LTE Band 7 (GT - LC = 0.60 dB) 64QAM			
Bandwidth	5M		
Channel	20775	21100	21425
	(Low)	(Mid)	(High)
Frequency (MHz)	2502.5	2535	2567.5
	Conducted Power (dBm)	20.78	20.85
Conducted Power (Watts)	0.1197	0.1216	0.1321
EIRP(dBm)	21.38	21.45	21.81
EIRP(Watts)	0.1374	0.1396	0.1517

LTE Band 7 (GT - LC = 0.60 dB) 64QAM									
Bandwidth	10M			15M			20M		
Channel	20800	21100	21400	20825	21100	21375	20850	21100	21350
	(Low)	(Mid)	(High)	(Low)	(Mid)	(High)	(Low)	(Mid)	(High)
Frequency (MHz)	2505	2535	2565	2507.5	2535	2562.5	2510	2535	2560
	Conducted Power (dBm)	20.79	20.61	21.10	20.50	20.88	20.62	20.48	20.76
Conducted Power (Watts)	0.1199	0.1151	0.1288	0.1122	0.1225	0.1153	0.1117	0.1191	0.1208
EIRP(dBm)	21.39	21.21	21.70	21.10	21.48	21.22	21.08	21.36	21.42
EIRP(Watts)	0.1377	0.1321	0.1479	0.1288	0.1406	0.1324	0.1282	0.1368	0.1387



LTE Band 41 (G <sub>T</sub> - L <sub>C</sub> = 0.59 dB) QPSK									
Bandwidth	5M			10M			15M		
Channel	39675	40620	41565	39700	40620	41540	39725	40620	41515
	(Low)	(Mid)	(High)	(Low)	(Mid)	(High)	(Low)	(Mid)	(High)
Frequency (MHz)	2498.5	2593	2687.5	2501	2593	2685	2503.5	2593	2682.5
Conducted Power (dBm)	26.11	26.28	26.14	26.10	26.25	26.15	25.96	26.23	26.11
Conducted Power (Watts)	0.4083	0.4246	0.4111	0.4074	0.4217	0.4121	0.3945	0.4198	0.4083
EIRP(dBm)	26.70	26.87	26.73	26.69	26.84	26.74	26.55	26.82	26.70
EIRP(Watts)	0.4677	0.4864	0.4710	0.4667	0.4831	0.4721	0.4519	0.4808	0.4677

LTE Band 41 (G <sub>T</sub> - L <sub>C</sub> = 0.59 dB) QPSK			
Bandwidth	20M		
Channel	39750	40620	41490
	(Low)	(Mid)	(High)
Frequency (MHz)	2506	2593	2680
Conducted Power (dBm)	26.03	26.14	26.28
Conducted Power (Watts)	0.4009	0.4111	0.4246
EIRP(dBm)	26.62	26.73	26.87
EIRP(Watts)	0.4592	0.4710	0.4864



LTE Band 41 (G <sub>T</sub> - L <sub>C</sub> = 0.59 dB) 16QAM									
Bandwidth	5M			10M			15M		
Channel	39675	40620	41565	39700	40620	41540	39725	40620	41515
	(Low)	(Mid)	(High)	(Low)	(Mid)	(High)	(Low)	(Mid)	(High)
Frequency (MHz)	2498.5	2593	2687.5	2501	2593	2685	2503.5	2593	2682.5
Conducted Power (dBm)	24.63	24.95	24.67	24.64	24.89	24.68	24.52	24.77	24.64
Conducted Power (Watts)	0.2904	0.3126	0.2931	0.2911	0.3083	0.2938	0.2831	0.2999	0.2911
EIRP(dBm)	25.22	25.54	25.26	25.23	25.48	25.27	25.11	25.36	25.23
EIRP(Watts)	0.3327	0.3581	0.3357	0.3334	0.3532	0.3365	0.3243	0.3436	0.3334

LTE Band 41 (G <sub>T</sub> - L <sub>C</sub> = 0.59 dB) 16QAM			
Bandwidth	20M		
Channel	39750	40620	41490
	(Low)	(Mid)	(High)
Frequency (MHz)	2506	2593	2680
Conducted Power (dBm)	24.52	24.76	24.61
Conducted Power (Watts)	0.2831	0.2992	0.2891
EIRP(dBm)	25.11	25.35	25.20
EIRP(Watts)	0.3243	0.3428	0.3311



LTE Band 41 (G <sub>T</sub> - L <sub>C</sub> = 0.59 dB) 64QAM									
Bandwidth	5M			10M			15M		
Channel	39675	40620	41565	39700	40620	41540	39725	40620	41515
	(Low)	(Mid)	(High)	(Low)	(Mid)	(High)	(Low)	(Mid)	(High)
Frequency (MHz)	2498.5	2593	2687.5	2501	2593	2685	2503.5	2593	2682.5
Conducted Power (dBm)	24.54	24.86	24.56	24.55	24.76	24.56	24.33	24.65	24.44
Conducted Power (Watts)	0.2844	0.3062	0.2858	0.2851	0.2992	0.2858	0.2710	0.2917	0.2780
EIRP(dBm)	25.13	25.45	25.15	25.14	25.35	25.15	24.92	25.24	25.03
EIRP(Watts)	0.3258	0.3508	0.3273	0.3266	0.3428	0.3273	0.3105	0.3342	0.3184

LTE Band 41 (G <sub>T</sub> - L <sub>C</sub> = 0.59 dB) 64QAM			
Bandwidth	20M		
Channel	39750	40620	41490
	(Low)	(Mid)	(High)
Frequency (MHz)	2506	2593	2680
Conducted Power (dBm)	24.41	24.61	24.54
Conducted Power (Watts)	0.2761	0.2891	0.2844
EIRP(dBm)	25.00	25.20	25.13
EIRP(Watts)	0.3162	0.3311	0.3258



LTE Band 66 (GT - LC = -1.32 dB) QPSK									
Bandwidth	1.4M			3M			5M		
Channel	131979	132322	132665	131987	132322	132657	131997	132322	132647
	(Low)	(Mid)	(High)	(Low)	(Mid)	(High)	(Low)	(Mid)	(High)
Frequency (MHz)	1710.7	1745	1779.3	1711.5	1745	1778.5	1712.5	1745	1777.5
Conducted Power (dBm)	22.63	22.89	22.53	22.76	22.89	22.57	22.62	22.89	22.52
Conducted Power (Watts)	0.1832	0.1945	0.1791	0.1888	0.1945	0.1807	0.1828	0.1945	0.1786
EIRP(dBm)	21.31	21.57	21.21	21.44	21.57	21.25	21.30	21.57	21.20
EIRP(Watts)	0.1352	0.1435	0.1321	0.1393	0.1435	0.1334	0.1349	0.1435	0.1318

LTE Band 66 (GT - LC = -1.32 dB) QPSK									
Bandwidth	10M			15M			20M		
Channel	132022	132322	132622	132047	132322	132597	132072	132322	132572
	(Low)	(Mid)	(High)	(Low)	(Mid)	(High)	(Low)	(Mid)	(Mid)
Frequency (MHz)	1715	1745	1775	1717.5	1745	1772.5	1720	1745	1770
Conducted Power (dBm)	22.88	22.66	22.81	22.63	22.84	22.56	22.67	22.91	22.62
Conducted Power (Watts)	0.1941	0.1845	0.1910	0.1832	0.1923	0.1803	0.1849	0.1954	0.1828
EIRP(dBm)	21.56	21.34	21.49	21.31	21.52	21.24	21.35	21.59	21.30
EIRP(Watts)	0.1432	0.1361	0.1409	0.1352	0.1419	0.1330	0.1365	0.1442	0.1349



LTE Band 66 (GT - LC = -1.32 dB) 16QAM									
Bandwidth	1.4M			3M			5M		
Channel	131979	132322	132665	131987	132322	132657	131997	132322	132647
	(Low)	(Mid)	(High)	(Low)	(Mid)	(High)	(Low)	(Mid)	(High)
Frequency (MHz)	1710.7	1745	1779.3	1711.5	1745	1778.5	1712.5	1745	1777.5
Conducted Power (dBm)	21.79	22.16	21.79	22.04	22.43	22.09	22.03	22.35	22.20
Conducted Power (Watts)	0.1510	0.1644	0.1510	0.1600	0.1750	0.1618	0.1596	0.1718	0.1660
EIRP(dBm)	20.47	20.84	20.47	20.72	21.11	20.77	20.71	21.03	20.88
EIRP(Watts)	0.1114	0.1213	0.1114	0.1180	0.1291	0.1194	0.1178	0.1268	0.1225

LTE Band 66 (GT - LC = -1.32 dB) 16QAM									
Bandwidth	10M			15M			20M		
Channel	132022	132322	132622	132047	132322	132597	132072	132322	132572
	(Low)	(Mid)	(High)	(Low)	(Mid)	(High)	(Low)	(Mid)	(Mid)
Frequency (MHz)	1715	1745	1775	1717.5	1745	1772.5	1720	1745	1770
Conducted Power (dBm)	22.05	21.90	21.74	22.10	22.21	21.73	21.95	21.73	22.21
Conducted Power (Watts)	0.1603	0.1549	0.1493	0.1622	0.1663	0.1489	0.1567	0.1489	0.1663
EIRP(dBm)	20.73	20.58	20.42	20.78	20.89	20.41	20.63	20.41	20.89
EIRP(Watts)	0.1183	0.1143	0.1102	0.1197	0.1227	0.1099	0.1156	0.1099	0.1227





LTE Band 66 (GT - LC = -1.32 dB) 64QAM									
Bandwidth	1.4M			3M			5M		
Channel	131979	132322	132665	131987	132322	132657	131997	132322	132647
	(Low)	(Mid)	(High)	(Low)	(Mid)	(High)	(Low)	(Mid)	(High)
Frequency (MHz)	1710.7	1745	1779.3	1711.5	1745	1778.5	1712.5	1745	1777.5
Conducted Power (dBm)	20.83	21.09	20.95	20.93	21.35	20.96	21.07	20.72	20.77
Conducted Power (Watts)	0.1211	0.1285	0.1245	0.1239	0.1365	0.1247	0.1279	0.1180	0.1194
EIRP(dBm)	19.51	19.77	19.63	19.61	20.03	19.64	19.75	19.40	19.45
EIRP(Watts)	0.0893	0.0948	0.0918	0.0914	0.1007	0.0920	0.0944	0.0871	0.0881

LTE Band 66 (GT - LC = -1.32 dB) 64QAM									
Bandwidth	10M			15M			20M		
Channel	132022	132322	132622	132047	132322	132597	132072	132322	132572
	(Low)	(Mid)	(High)	(Low)	(Mid)	(High)	(Low)	(Mid)	(Mid)
Frequency (MHz)	1715	1745	1775	1717.5	1745	1772.5	1720	1745	1770
Conducted Power (dBm)	21.13	21.22	20.98	20.57	21.06	20.87	20.90	20.97	20.55
Conducted Power (Watts)	0.1297	0.1324	0.1253	0.1140	0.1276	0.1222	0.1230	0.1250	0.1135
EIRP(dBm)	19.81	19.90	19.66	19.25	19.74	19.55	19.58	19.65	19.23
EIRP(Watts)	0.0957	0.0977	0.0925	0.0841	0.0942	0.0902	0.0908	0.0923	0.0838



**CA EIRP**

LTE Band 41 CA (GT - LC = 0.59 dB) QPSK			
Bandwidth	20M+20M		
Channel PCC	39750	40521	41292
	(Low)	(Mid)	(High)
Channel SCC	39948	40719	41490
	(Low)	(Mid)	(High)
Conducted Power (dBm)	21.51	21.85	23.54
Conducted Power (Watts)	0.1416	0.1531	0.2259
EIRP(dBm)	22.10	22.44	24.13
EIRP(Watts)	0.1622	0.1754	0.2588

LTE Band 41 CA (GT - LC = 0.59 dB) 16QAM			
Bandwidth	20M+20M		
Channel PCC	39750	40521	41292
	(Low)	(Mid)	(High)
Channel SCC	39948	40719	41490
	(Low)	(Mid)	(High)
Conducted Power (dBm)	20.69	20.79	21.03
Conducted Power (Watts)	0.1172	0.1199	0.1268
EIRP(dBm)	21.28	21.38	21.62
EIRP(Watts)	0.1343	0.1374	0.1452



LTE Band 41 CA (GT - LC = 0.59 dB) 64QAM			
Bandwidth	20M+20M		
Channel PCC	39750	40521	41292
	(Low)	(Mid)	(High)
Channel SCC	39948	40719	41490
	(Low)	(Mid)	(High)
Conducted Power (dBm)	20.66	20.80	21.05
Conducted Power (Watts)	0.1164	0.1202	0.1274
EIRP(dBm)	21.25	21.39	21.64
EIRP(Watts)	0.1334	0.1377	0.1459

LTE Band 66C_CA (GT - LC = --1.32 dB) QPSK			
Bandwidth	20M + 20M		
Channel PCC	132005	132330	132455
	(Low)	(Mid)	(High)
Channel SCC	132122	132447	132572
	(Low)	(Mid)	(High)
Conducted Power (dBm)	23.33	22.74	22.81
Conducted Power (Watts)	0.2153	0.1879	0.1910
EIRP(dBm)	22.01	21.42	21.49
EIRP(Watts)	0.1589	0.1387	0.1409



LTE Band 66C_CA (GT - LC = --1.32 dB) 16QAM			
Bandwidth	20M + 20M		
Channel PCC	132005	132330	132455
	(Low)	(Mid)	(High)
Channel SCC	132122	132447	132572
	(Low)	(Mid)	(High)
Conducted Power (dBm)	22.22	22.08	22.10
Conducted Power (Watts)	0.1667	0.1614	0.1622
EIRP(dBm)	20.90	20.76	20.78
EIRP(Watts)	0.1230	0.1191	0.1197

LTE Band 66C_CA (GT - LC = --1.32 dB) 64QAM			
Bandwidth	20M + 20M		
Channel PCC	132005	132330	132455
	(Low)	(Mid)	(High)
Channel SCC	132122	132447	132572
	(Low)	(Mid)	(High)
Conducted Power (dBm)	21.93	21.71	21.71
Conducted Power (Watts)	0.1560	0.1483	0.1483
EIRP(dBm)	20.61	20.39	20.39
EIRP(Watts)	0.1151	0.1094	0.1094



LTE Band 66B_CA (GT - LC = --1.32 dB) QPSK			
Bandwidth	10M + 10M		
Channel PCC	132022	132373	132523
	(Low)	(Mid)	(High)
Channel SCC	132121	132472	132622
	(Low)	(Mid)	(High)
Conducted Power (dBm)	23.12	23.04	23.04
Conducted Power (Watts)	0.2051	0.2014	0.2014
EIRP(dBm)	21.80	21.72	21.72
EIRP(Watts)	0.1514	0.1486	0.1486

LTE Band 66B_CA (GT - LC = --1.32 dB) 16QAM			
Bandwidth	10M + 10M		
Channel PCC	132022	132373	132523
	(Low)	(Mid)	(High)
Channel SCC	132121	132472	132622
	(Low)	(Mid)	(High)
Conducted Power (dBm)	23.08	23.79	23.08
Conducted Power (Watts)	0.2032	0.2393	0.2032
EIRP(dBm)	21.76	22.47	21.76
EIRP(Watts)	0.1500	0.1766	0.1500



LTE Band 66B_CA (GT - LC = --1.32 dB) 64QAM			
Bandwidth	10M + 10M		
Channel PCC	132022	132373	132523
	(Low)	(Mid)	(High)
Channel SCC	132121	132472	132622
	(Low)	(Mid)	(High)
Conducted Power (dBm)	22.35	21.82	21.87
Conducted Power (Watts)	0.1718	0.1521	0.1538
EIRP(dBm)	21.03	20.50	20.55
EIRP(Watts)	0.1268	0.1122	0.1135



### LTE Band 7

#### Peak-to-Average Ratio

Mode	LTE Band 7 / 20MHz				
Mod.	QPSK		16QAM		Limit: 13dB
RB Size	1RB	Full RB	1RB	Full RB	Result
Lowest CH	3.83	5.22	5.94	6.03	PASS
Middle CH	3.91	5.13	5.74	5.88	
Highest CH	3.45	5.10	4.81	5.94	
Mode	LTE Band 7 / 20MHz				
Mod.	64QAM				Limit: 13dB
RB Size	1RB	Full RB			Result
Lowest CH	7.80	6.49	-	-	PASS
Middle CH	7.62	6.52	-	-	
Highest CH	6.55	6.46	-	-	



LTE Band 7 / 20MHz / QPSK

Lowest Channel / 1RB

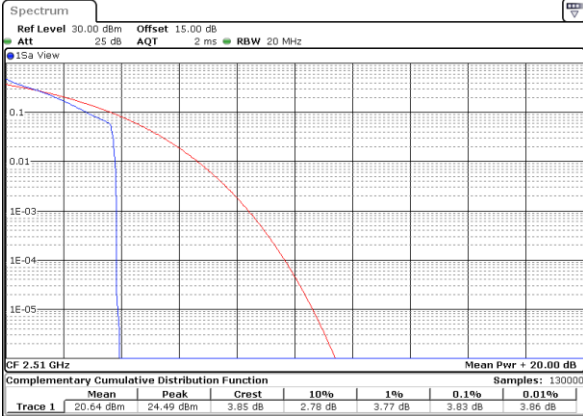

Date: 12.FEB.2021 15:56:55

Lowest Channel / Full RB

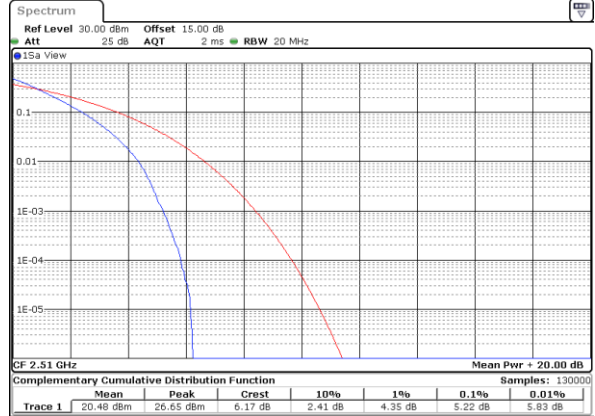

Date: 12.FEB.2021 15:57:13

Middle Channel / 1RB

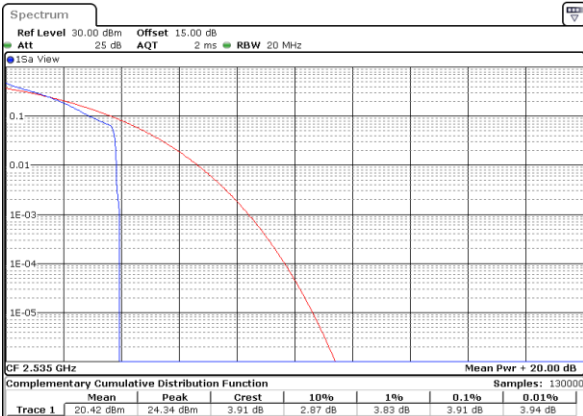

Date: 12.FEB.2021 15:57:27

Middle Channel / Full RB

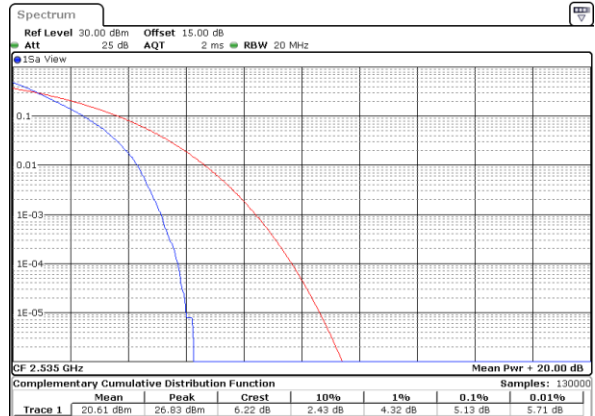

Date: 12.FEB.2021 15:57:38

Highest Channel / 1RB

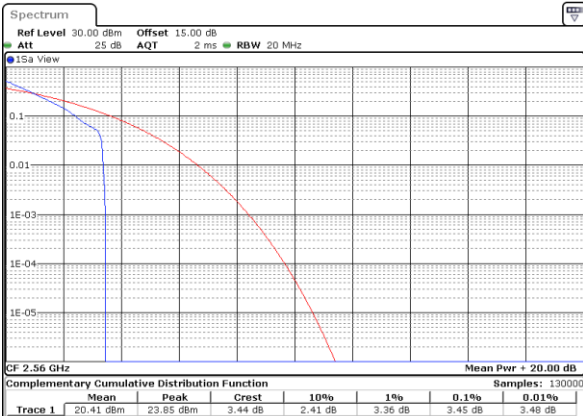

Date: 12.FEB.2021 15:57:48

Highest Channel / Full RB

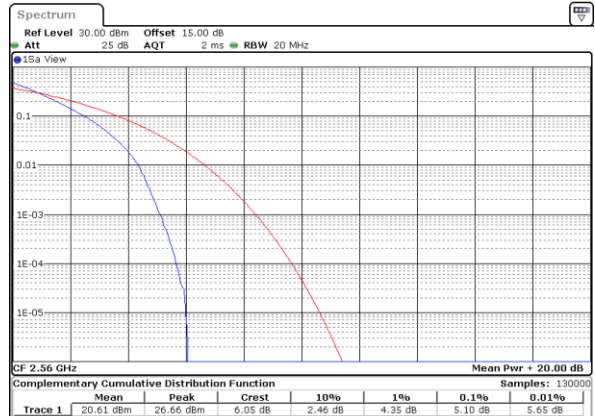

Date: 12.FEB.2021 15:58:06





LTE Band 7 / 20MHz / 16QAM

Lowest Channel / 1RB

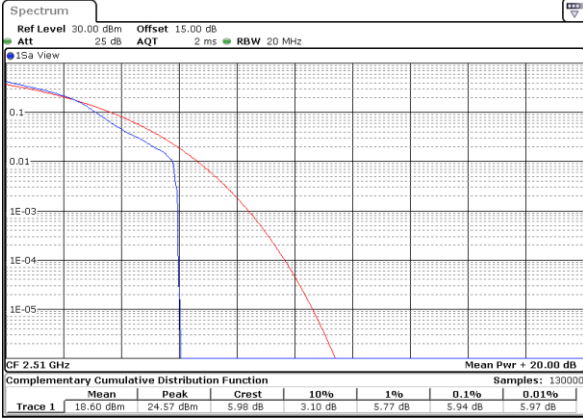

Date: 12.FEB.2021 15:51:04

Lowest Channel / Full RB

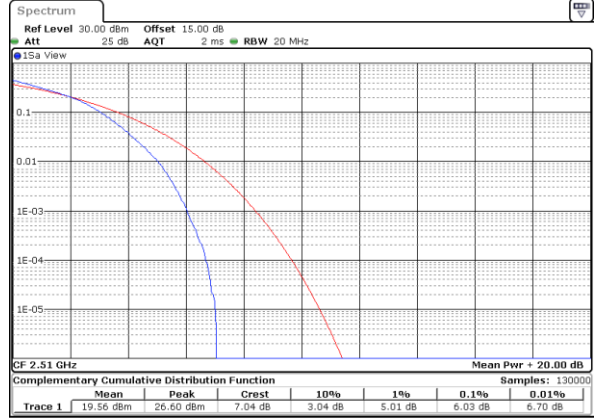

Date: 12.FEB.2021 15:51:14

Middle Channel / 1RB

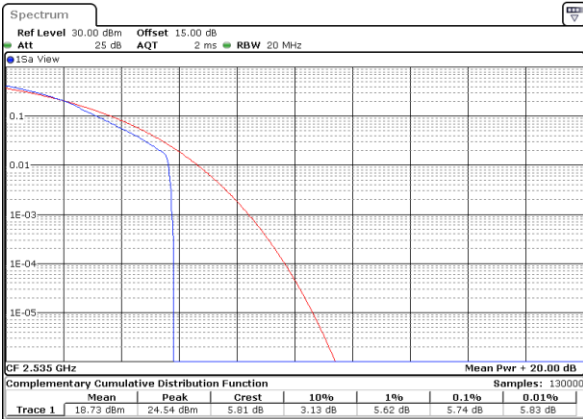

Date: 12.FEB.2021 15:51:26

Middle Channel / Full RB

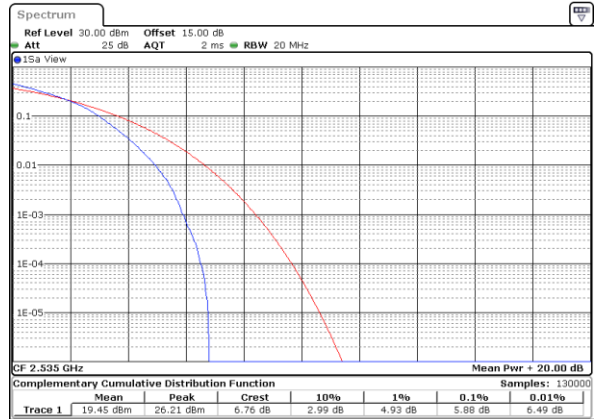

Date: 12.FEB.2021 15:51:47

Highest Channel / 1RB

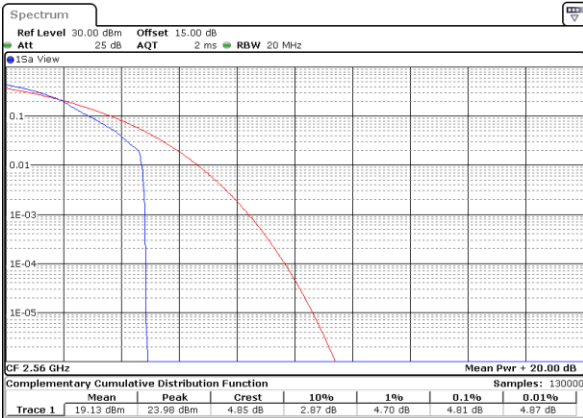

Date: 12.FEB.2021 15:54:04

Highest Channel / Full RB

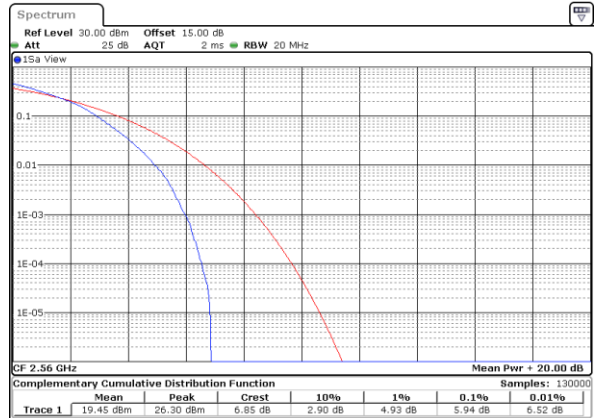

Date: 12.FEB.2021 15:55:35



LTE Band 7 / 20MHz / 64QAM

Lowest Channel / 1RB



Date: 12.FEB.2021 16:02:43

Lowest Channel / Full RB

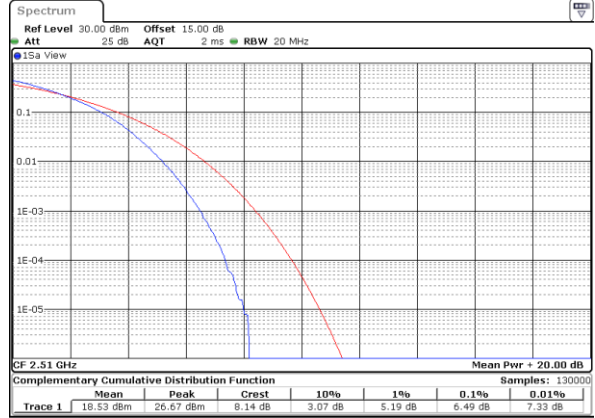

Date: 12.FEB.2021 16:03:07

Middle Channel / 1RB



Date: 12.FEB.2021 16:03:19

Middle Channel / Full RB

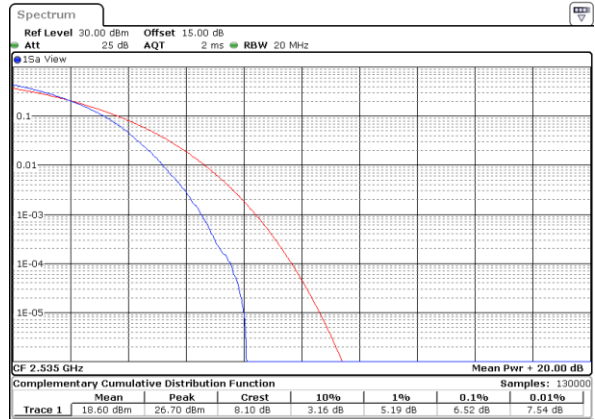

Date: 12.FEB.2021 16:03:40

Highest Channel / 1RB

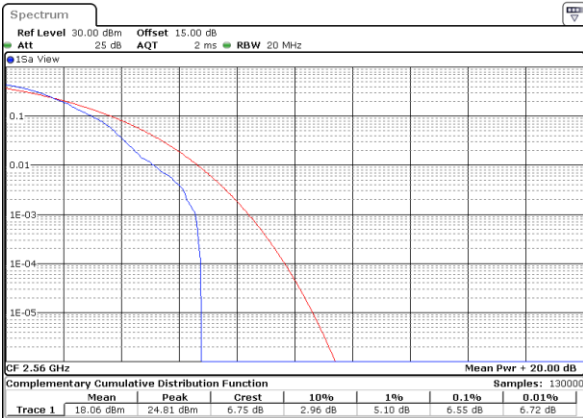

Date: 12.FEB.2021 16:04:16

Highest Channel / Full RB

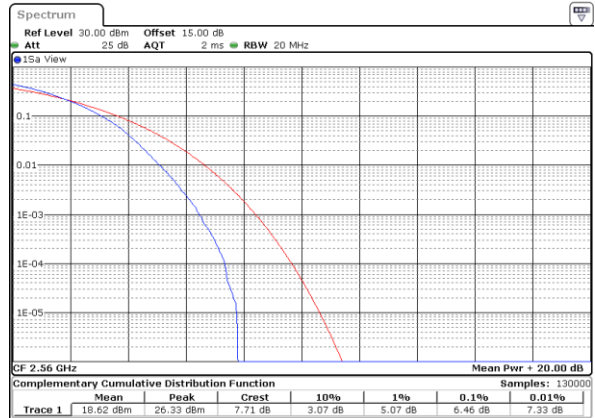

Date: 12.FEB.2021 16:04:35



26dB Bandwidth

Mode	LTE Band 7 : 26dB BW(MHz)											
BW	1.4MHz		3MHz		5MHz		10MHz		15MHz		20MHz	
Mod.	QPSK	16QAM	QPSK	16QAM	QPSK	16QAM	QPSK	16QAM	QPSK	16QAM	QPSK	16QAM
Lowest CH	-	-	-	-	4.99	4.96	9.83	9.85	14.36	14.36	18.82	18.98
Middle CH	-	-	-	-	4.94	4.90	9.87	9.83	14.36	14.60	18.90	18.86
Highest CH	-	-	-	-	4.90	4.89	9.95	9.85	14.18	14.39	19.02	19.26
Mode	LTE Band 7 : 26dB BW(MHz)											
BW	1.4MHz		3MHz		5MHz		10MHz		15MHz		20MHz	
Mod.	64QAM		64QAM		64QAM		64QAM		64QAM		64QAM	
Lowest CH	-	-	-	-	4.85	-	9.93	-	14.18	-	18.94	-
Middle CH	-	-	-	-	4.90	-	9.85	-	14.30	-	18.98	-
Highest CH	-	-	-	-	4.90	-	9.83	-	14.54	-	19.10	-



LTE Band 7

Lowest Channel / 5MHz / QPSK

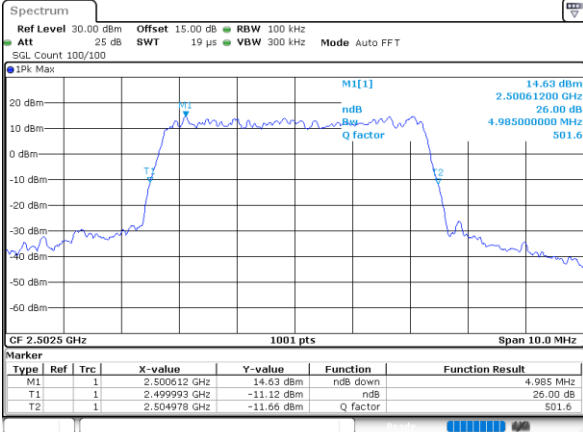

Date: 12.FEB.2021 14:12:27

Lowest Channel / 5MHz / 16QAM

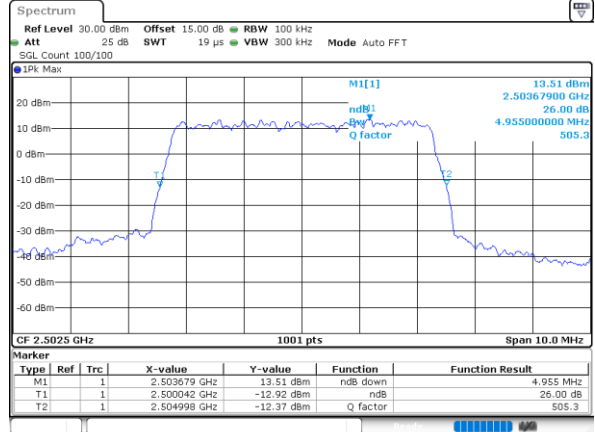

Date: 12.FEB.2021 14:12:37

Middle Channel / 5MHz / QPSK

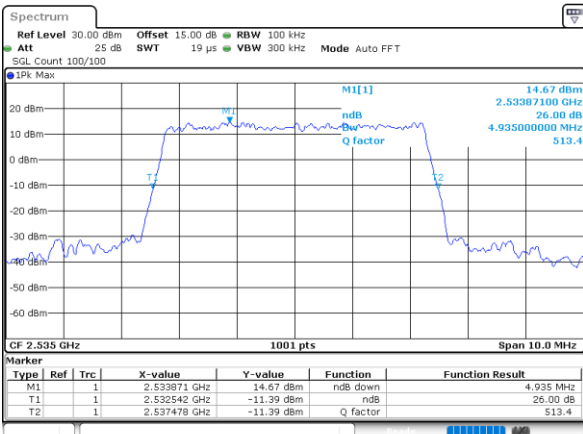

Date: 12.FEB.2021 14:20:37

Middle Channel / 5MHz / 16QAM

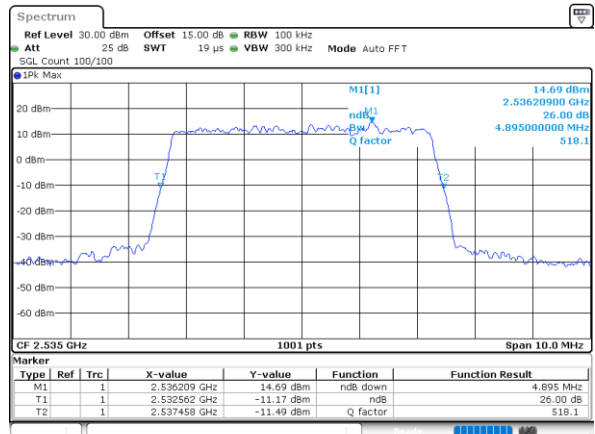

Date: 12.FEB.2021 14:20:48

Highest Channel / 5MHz / QPSK

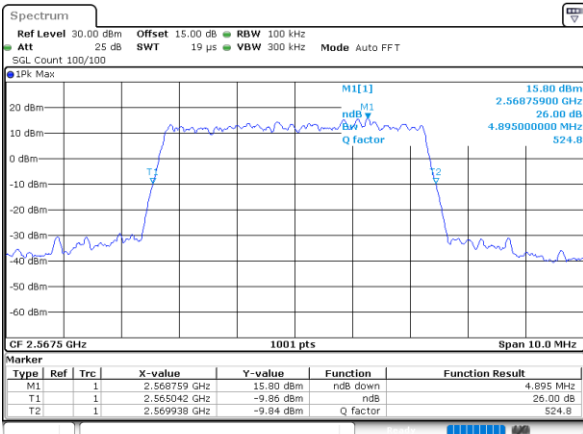

Date: 12.FEB.2021 14:23:07

Highest Channel / 5MHz / 16QAM

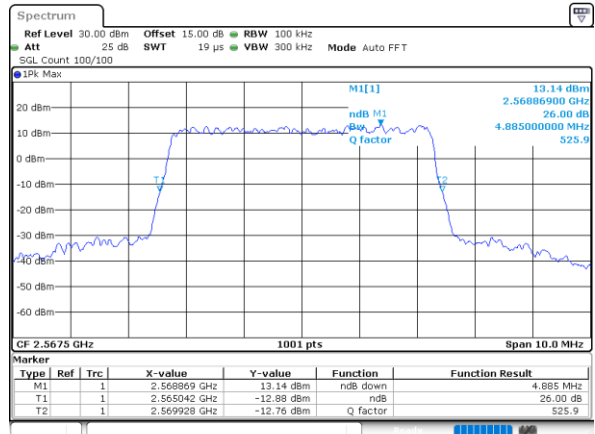

Date: 12.FEB.2021 14:23:18



LTE Band 7

Lowest Channel / 10MHz / QPSK

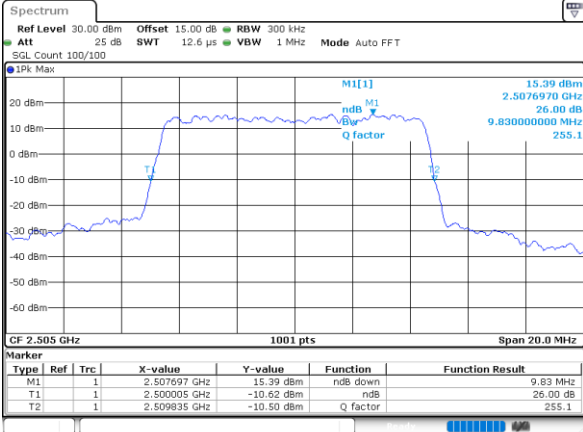

Date: 12.FEB.2021 14:39:29

Lowest Channel / 10MHz / 16QAM

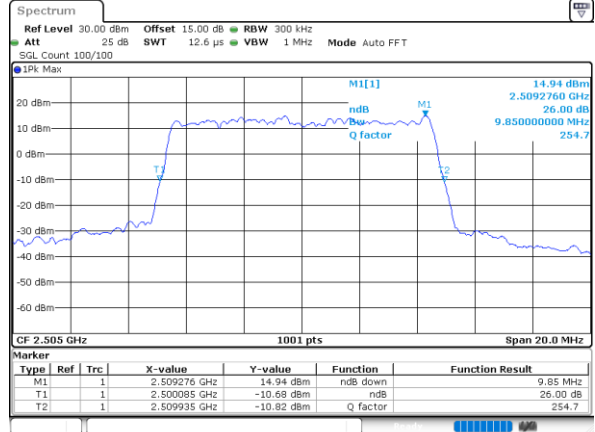

Date: 12.FEB.2021 14:39:40

Middle Channel / 10MHz / QPSK

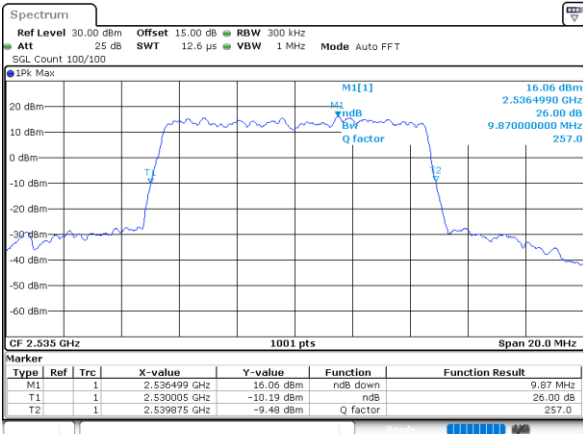

Date: 12.FEB.2021 14:44:55

Middle Channel / 10MHz / 16QAM

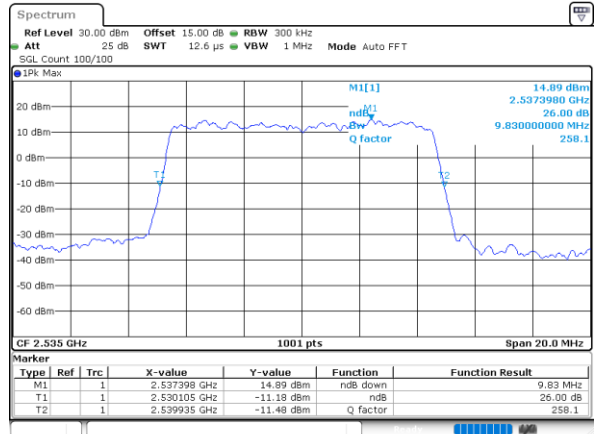

Date: 12.FEB.2021 14:45:06

Highest Channel / 10MHz / QPSK

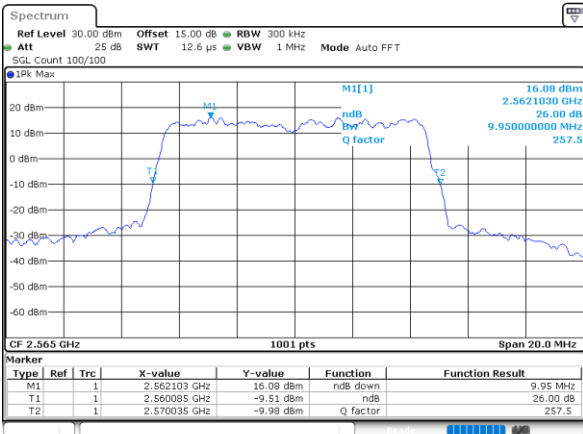

Date: 12.FEB.2021 14:47:25

Highest Channel / 10MHz / 16QAM

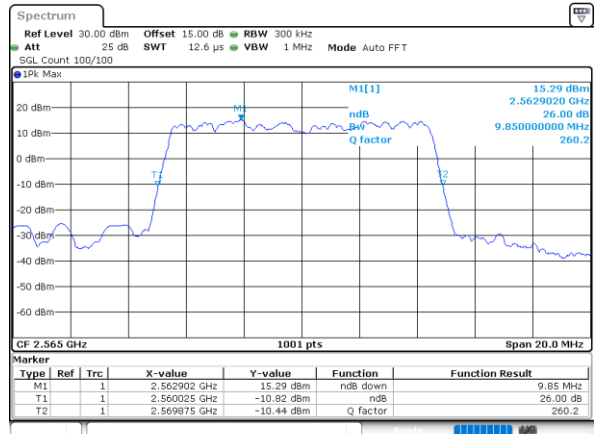

Date: 12.FEB.2021 14:47:36



LTE Band 7

Lowest Channel / 15MHz / QPSK

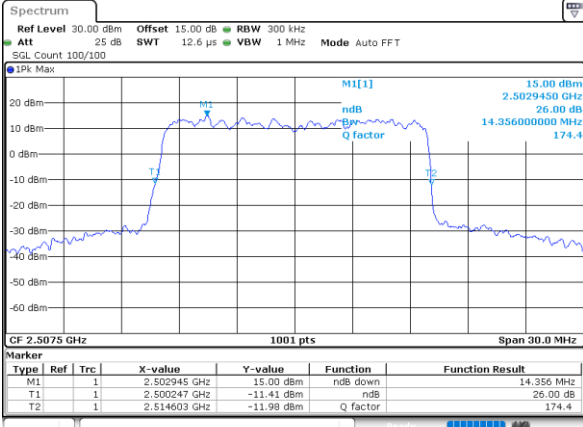

Date: 12.FEB.2021 14:59:49

Lowest Channel / 15MHz / 16QAM

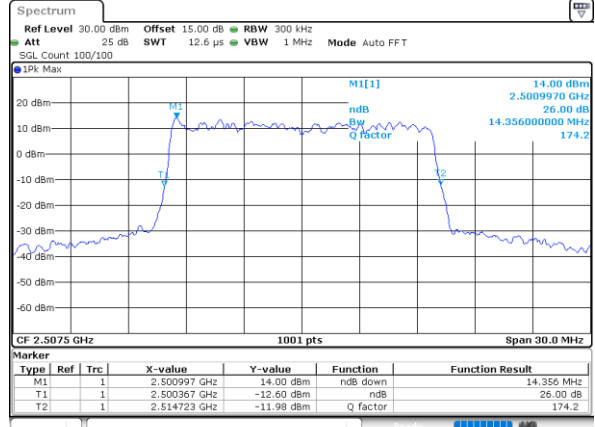

Date: 12.FEB.2021 15:00:00

Middle Channel / 15MHz / QPSK

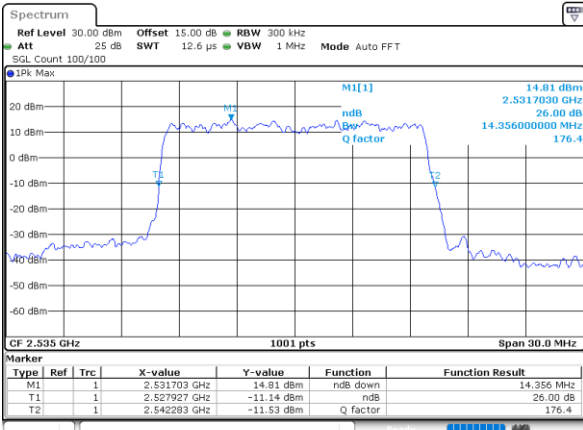

Date: 12.FEB.2021 15:05:16

Middle Channel / 15MHz / 16QAM

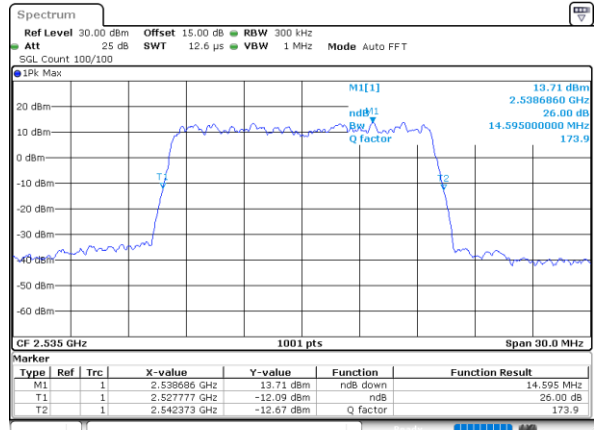

Date: 12.FEB.2021 15:05:27

Highest Channel / 15MHz / QPSK

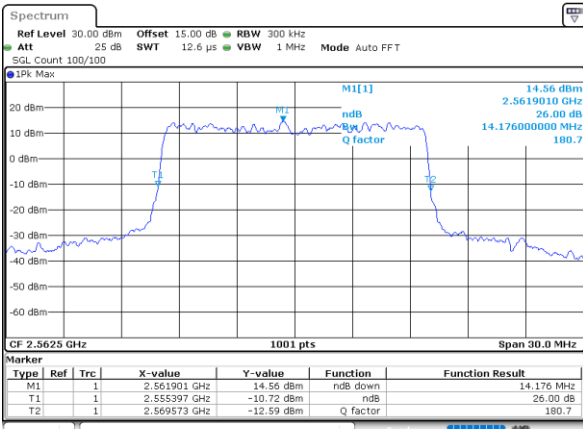

Date: 12.FEB.2021 15:08:31

Highest Channel / 15MHz / 16QAM

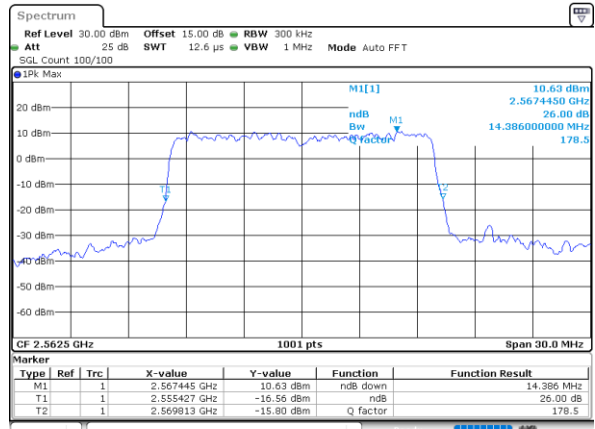

Date: 12.FEB.2021 15:08:41



LTE Band 7

Lowest Channel / 20MHz / QPSK

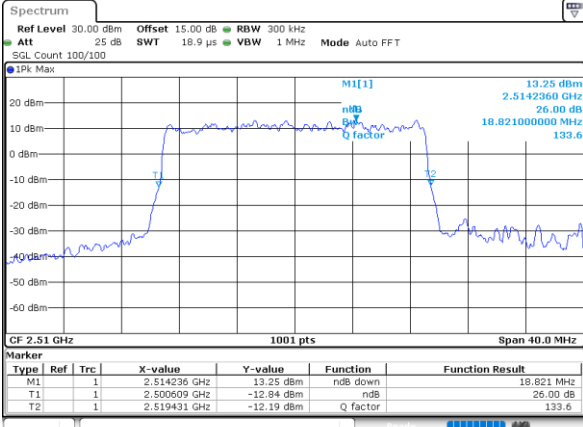

Date: 12.FEB.2021 15:20:52

Lowest Channel / 20MHz / 16QAM

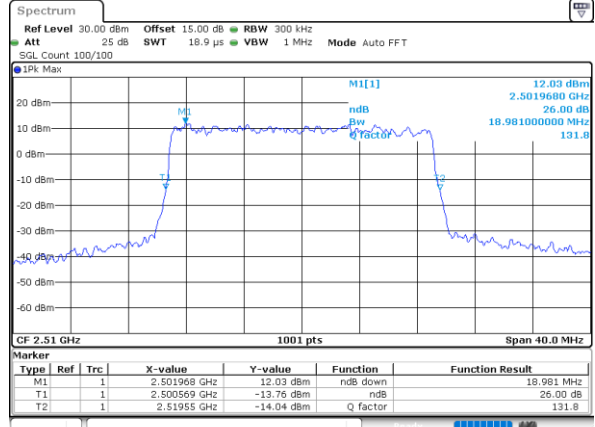

Date: 12.FEB.2021 15:21:03

Middle Channel / 20MHz / QPSK

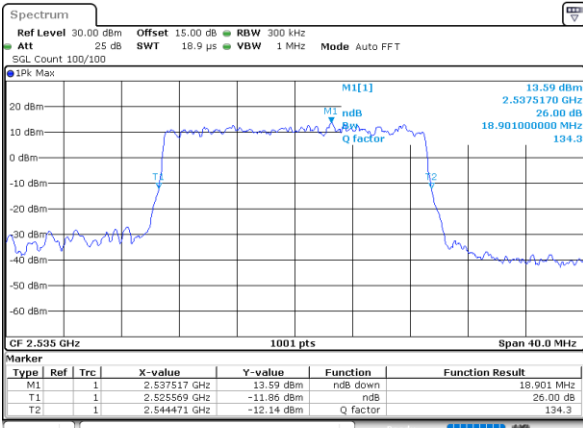

Date: 12.FEB.2021 15:28:28

Middle Channel / 20MHz / 16QAM

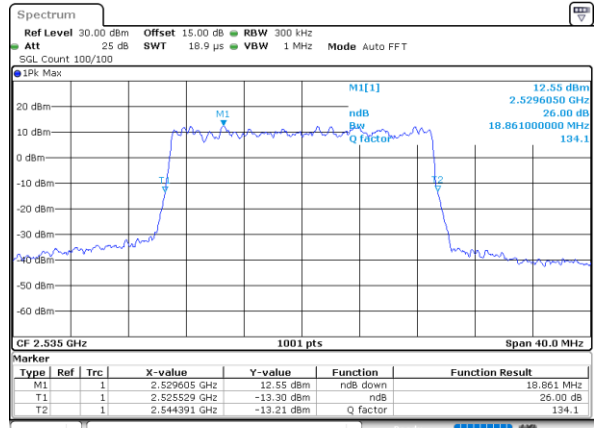

Date: 12.FEB.2021 15:28:39

Highest Channel / 20MHz / QPSK

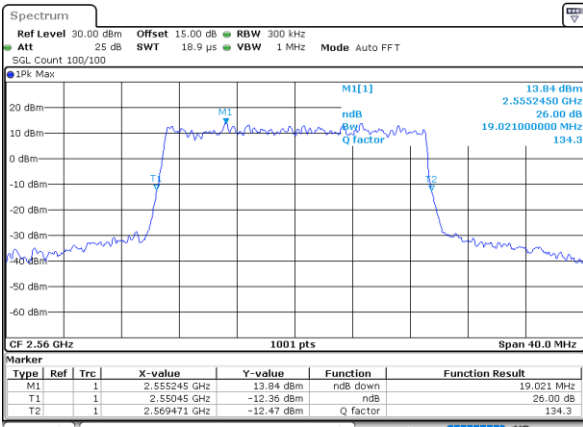

Date: 12.FEB.2021 15:30:58

Highest Channel / 20MHz / 16QAM

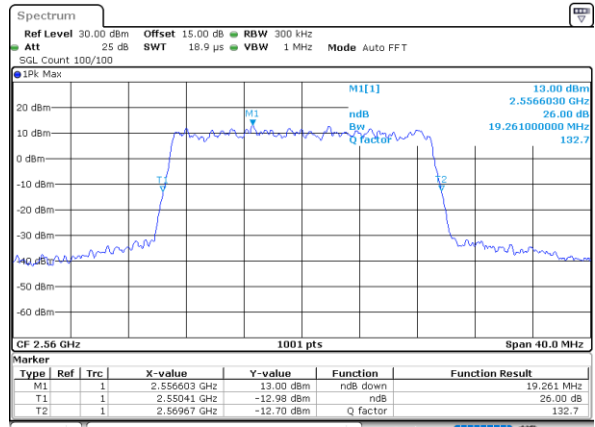

Date: 12.FEB.2021 15:31:09



LTE Band 7

Lowest Channel / 5MHz / 64QAM

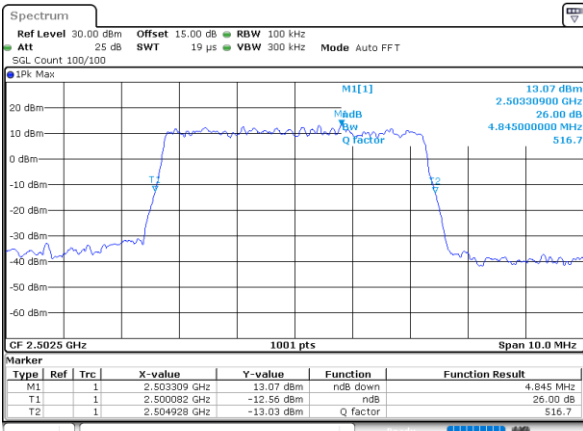

Date: 12.FEB.2021 14:32:13

Lowest Channel / 10MHz / 64QAM

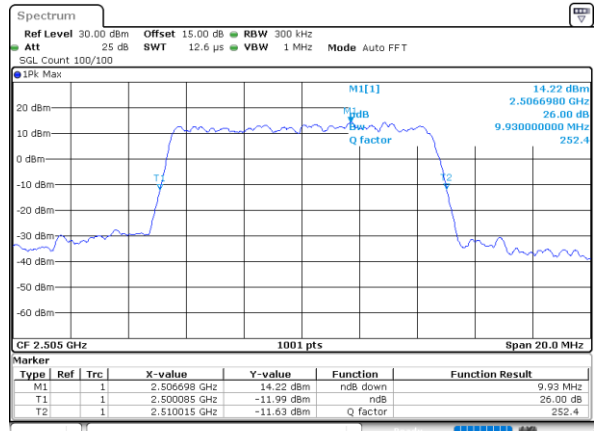

Date: 12.FEB.2021 14:52:57

Middle Channel / 5MHz / 64QAM

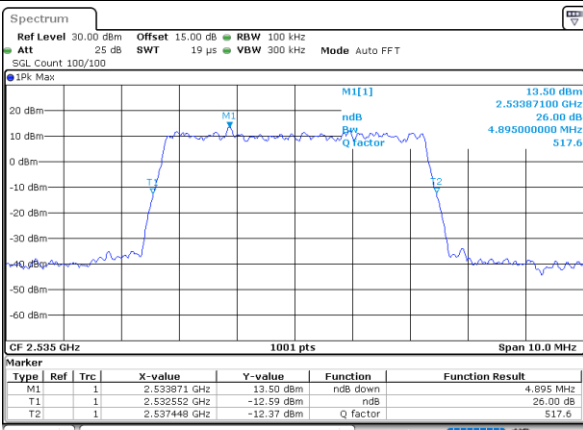

Date: 12.FEB.2021 14:34:56

Middle Channel / 10MHz / 64QAM

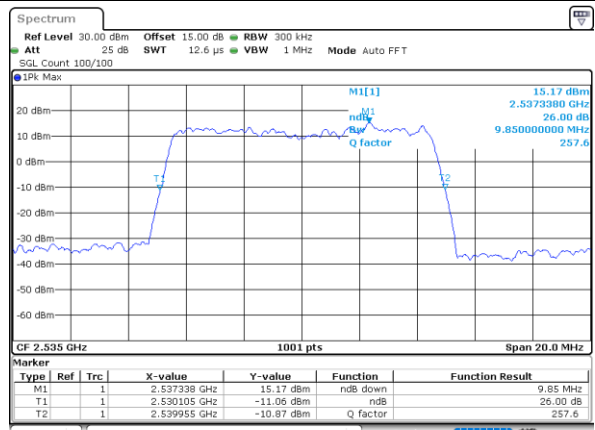

Date: 12.FEB.2021 14:55:40

Highest Channel / 5MHz / 64QAM

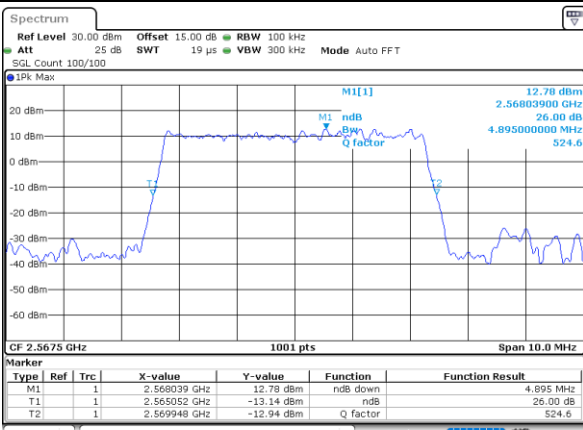

Date: 12.FEB.2021 14:36:11

Highest Channel / 10MHz / 64QAM

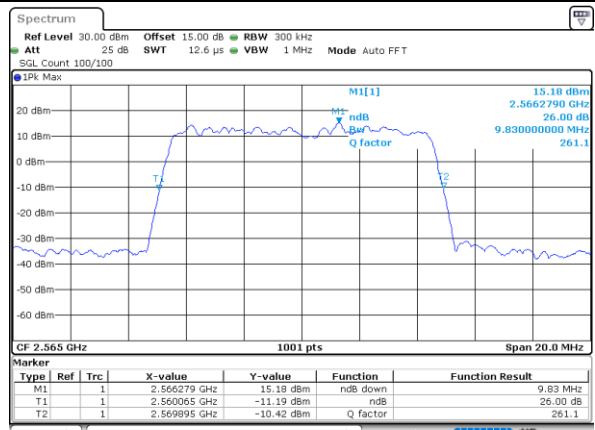

Date: 12.FEB.2021 14:56:55





LTE Band 7

Lowest Channel / 15MHz / 64QAM

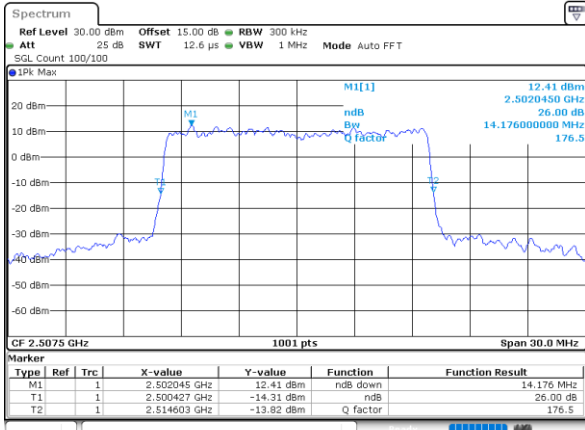

Date: 12.FEB.2021 15:13:46

Lowest Channel / 20MHz / 64QAM

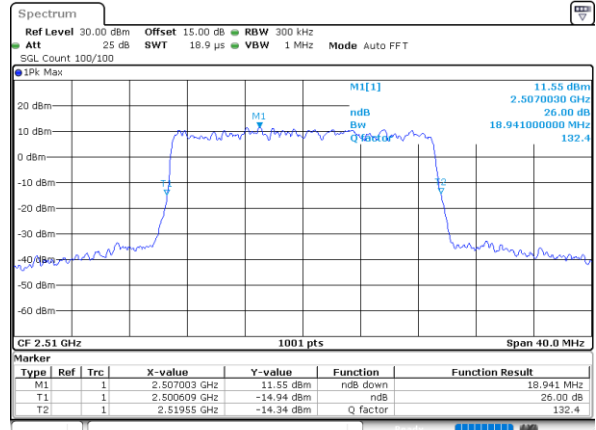

Date: 12.FEB.2021 15:13:53

Middle Channel / 15MHz / 64QAM

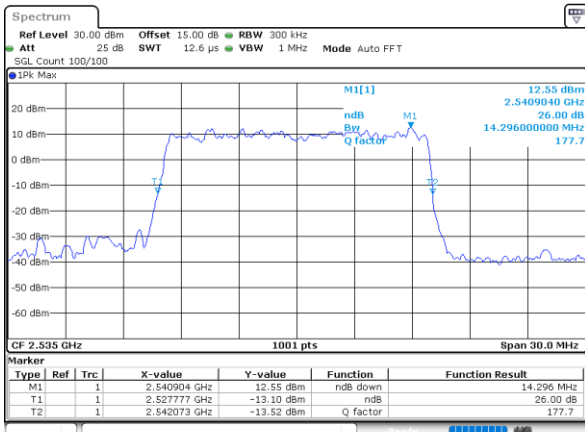

Date: 12.FEB.2021 15:16:43

Middle Channel / 20MHz / 64QAM

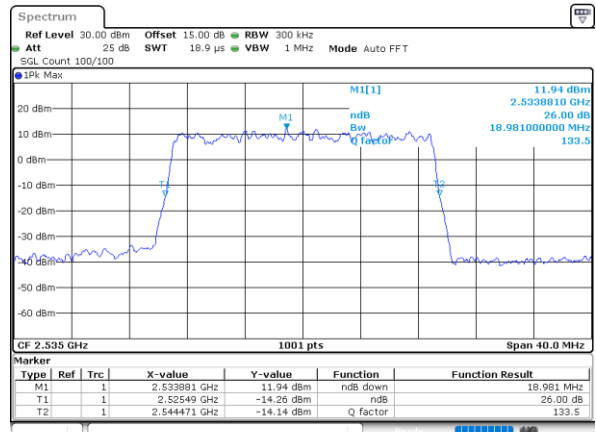

Date: 12.FEB.2021 15:13:57

Highest Channel / 15MHz / 64QAM

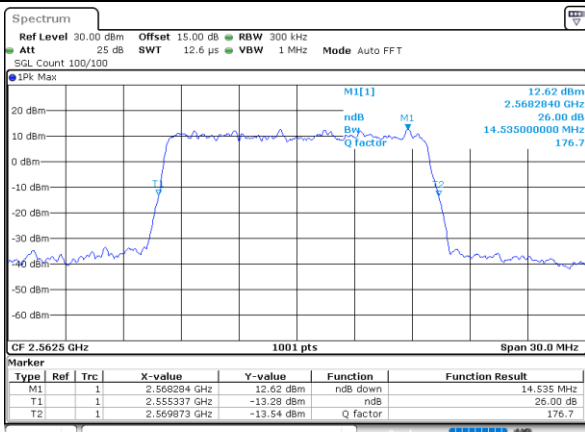

Date: 12.FEB.2021 15:17:58

Highest Channel / 20MHz / 64QAM

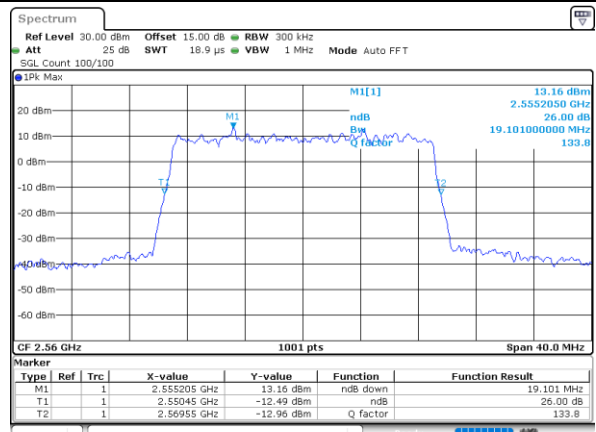

Date: 12.FEB.2021 15:14:53



Occupied Bandwidth

Mode	LTE Band 7 : 99%OBW(MHz)											
BW	1.4MHz		3MHz		5MHz		10MHz		15MHz		20MHz	
Mod.	QPSK	16QAM	QPSK	16QAM	QPSK	16QAM	QPSK	16QAM	QPSK	16QAM	QPSK	16QAM
Lowest CH	-	-	-	-	4.52	4.49	9.05	8.99	13.43	13.52	17.86	17.90
Middle CH	-	-	-	-	4.49	4.50	8.99	9.03	13.40	13.43	17.94	17.86
Highest CH	-	-	-	-	4.50	4.49	9.03	9.01	13.43	13.43	17.86	17.82
Mode	LTE Band 7 : 99%OBW(MHz)											
BW	1.4MHz		3MHz		5MHz		10MHz		15MHz		20MHz	
Mod.	64QAM		64QAM		64QAM		64QAM		64QAM		64QAM	
Lowest CH	-	-	-	-	4.50	-	9.01	-	13.49	-	17.82	-
Middle CH	-	-	-	-	4.48	-	9.01	-	13.40	-	17.90	-
Highest CH	-	-	-	-	4.51	-	9.01	-	13.49	-	17.86	-



LTE Band 7

Lowest Channel / 5MHz / QPSK

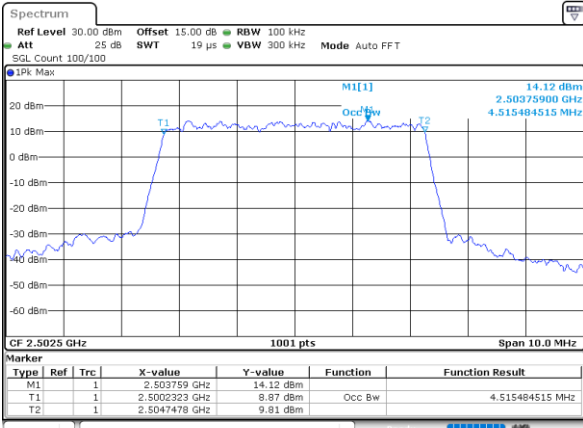

Date: 12.FEB.2021 14:12:05

Lowest Channel / 5MHz / 16QAM

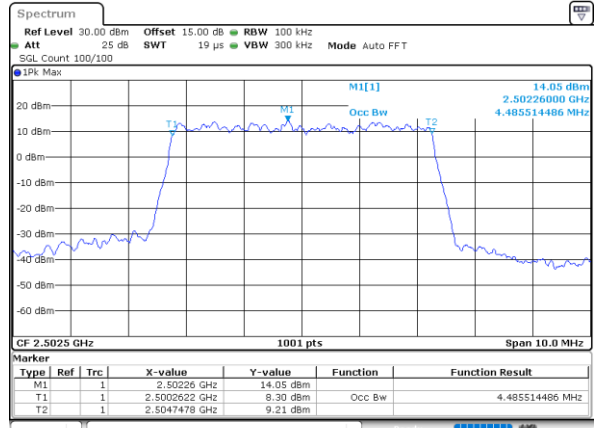

Date: 12.FEB.2021 14:12:16

Middle Channel / 5MHz / QPSK

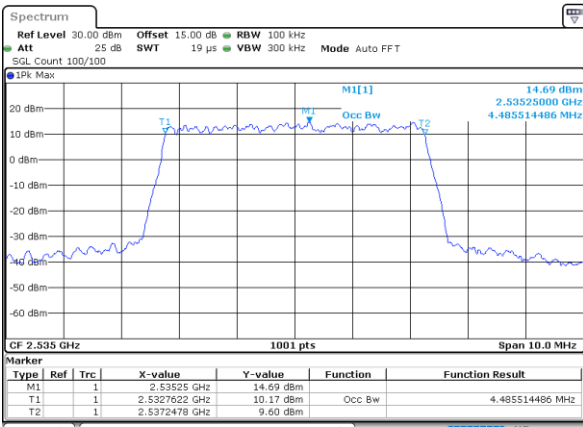

Date: 12.FEB.2021 14:17:02

Middle Channel / 5MHz / 16QAM

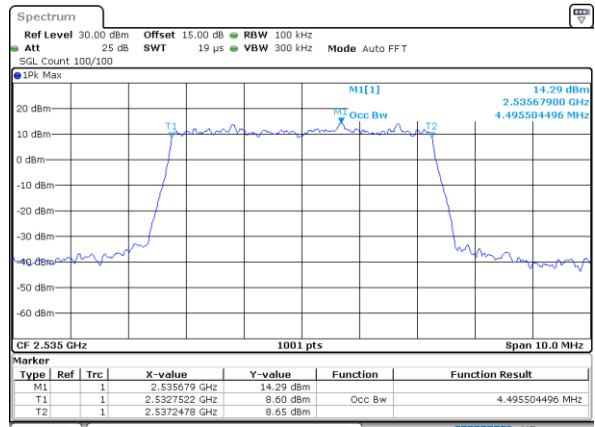

Date: 12.FEB.2021 14:17:43

Highest Channel / 5MHz / QPSK

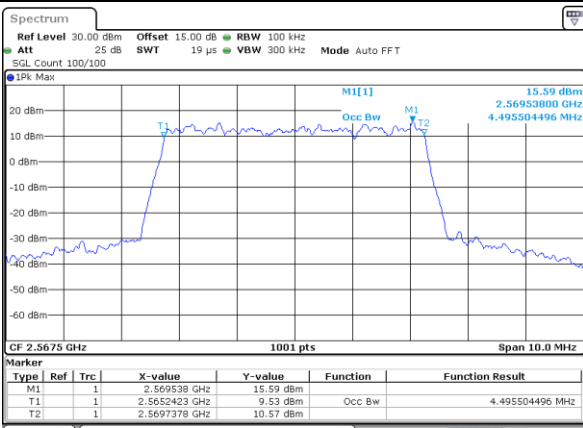

Date: 12.FEB.2021 14:22:46

Highest Channel / 5MHz / 16QAM

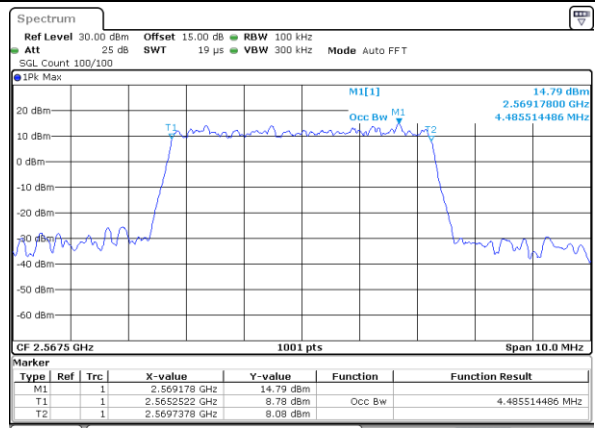

Date: 12.FEB.2021 14:22:56



LTE Band 7

Lowest Channel / 10MHz / QPSK

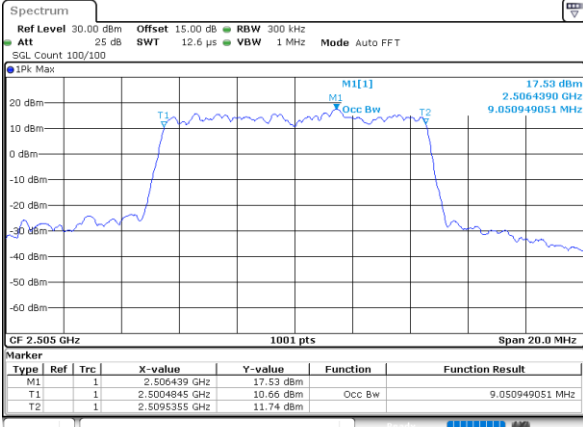

Date: 12.FEB.2021 14:39:07

Lowest Channel / 10MHz / 16QAM

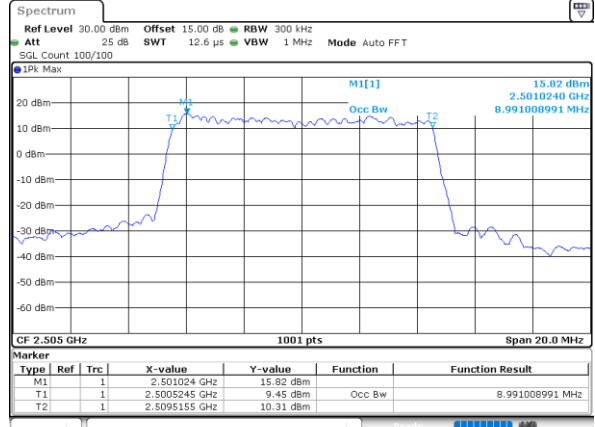

Date: 12.FEB.2021 14:39:18

Middle Channel / 10MHz / QPSK

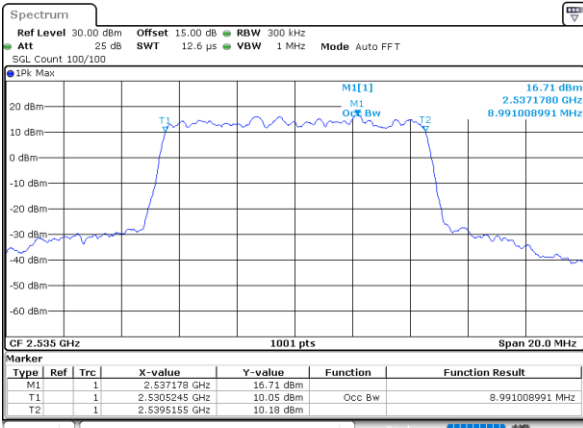

Date: 12.FEB.2021 14:44:04

Middle Channel / 10MHz / 16QAM

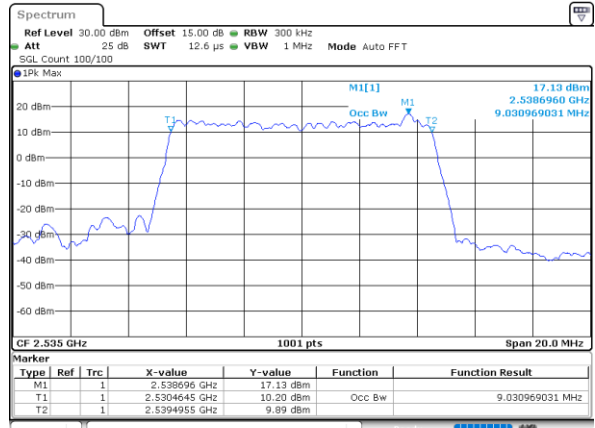

Date: 12.FEB.2021 14:44:45

Highest Channel / 10MHz / QPSK

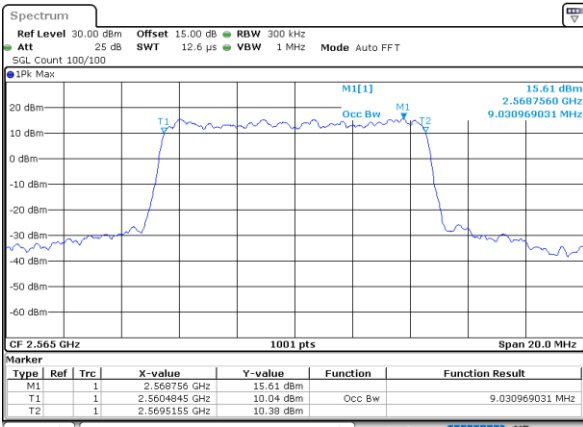

Date: 12.FEB.2021 14:47:04

Highest Channel / 10MHz / 16QAM

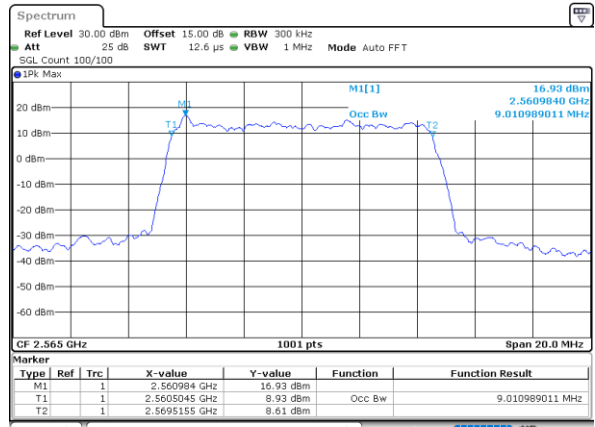

Date: 12.FEB.2021 14:47:15



LTE Band 7

Lowest Channel / 15MHz / QPSK

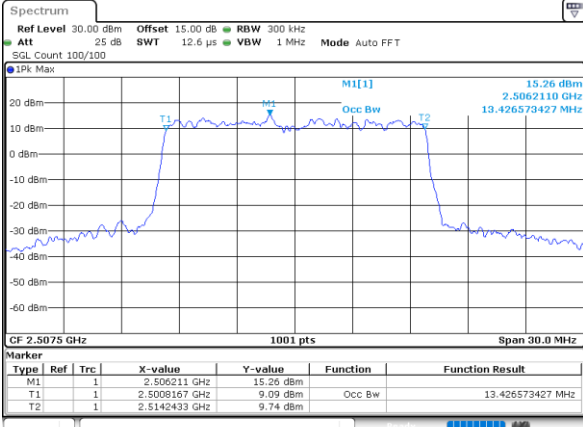

Date: 12.FEB.2021 14:59:27

Lowest Channel / 15MHz / 16QAM

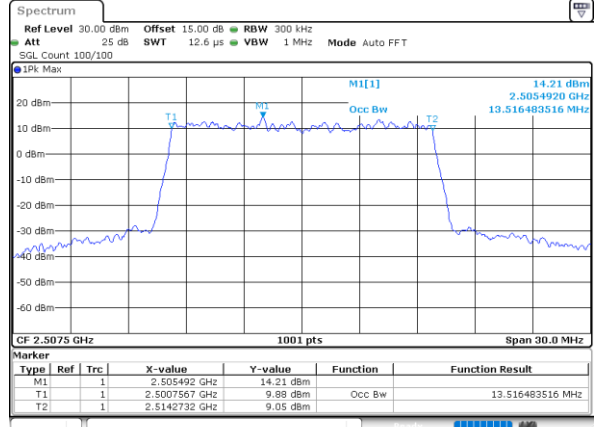

Date: 12.FEB.2021 14:59:38

Middle Channel / 15MHz / QPSK

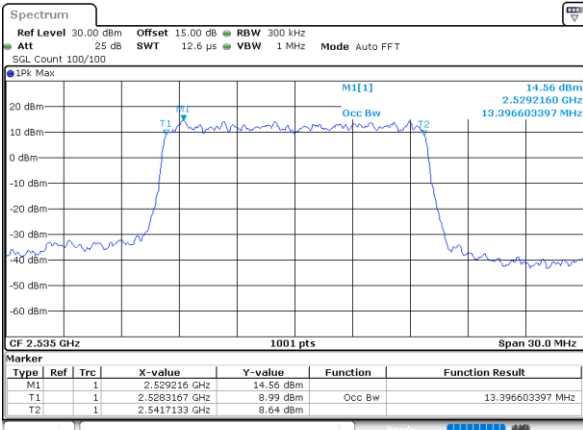

Date: 12.FEB.2021 15:04:54

Middle Channel / 15MHz / 16QAM

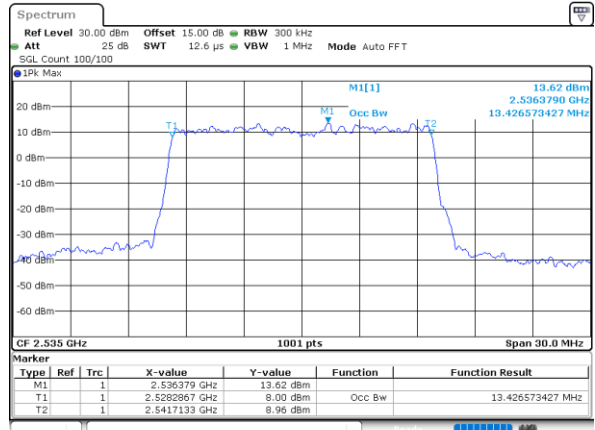

Date: 12.FEB.2021 15:05:05

Highest Channel / 15MHz / QPSK

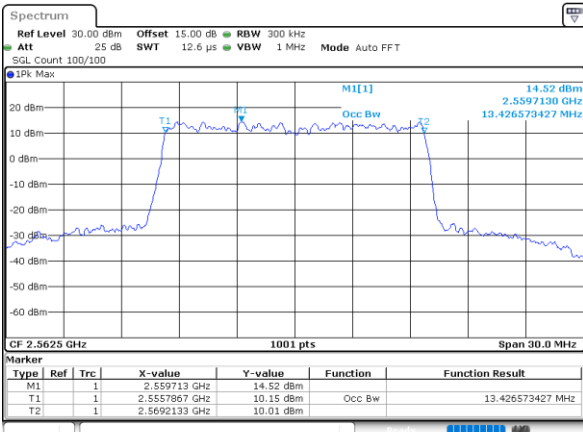

Date: 12.FEB.2021 15:08:09

Highest Channel / 15MHz / 16QAM

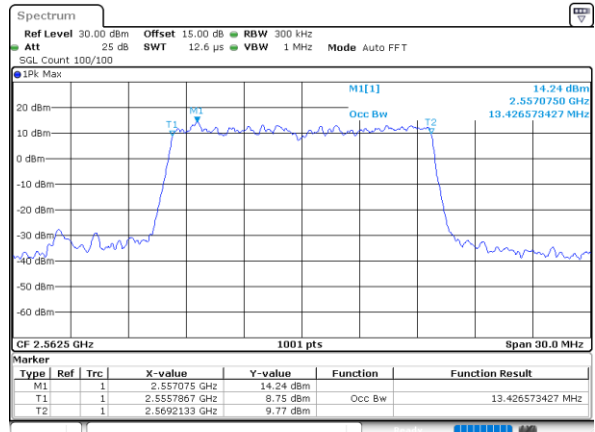

Date: 12.FEB.2021 15:08:20



LTE Band 7

Lowest Channel / 20MHz / QPSK

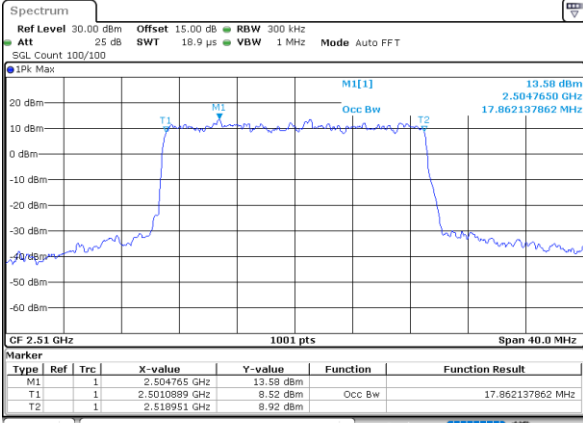

Date: 12.FEB.2021 15:20:30

Lowest Channel / 20MHz / 16QAM

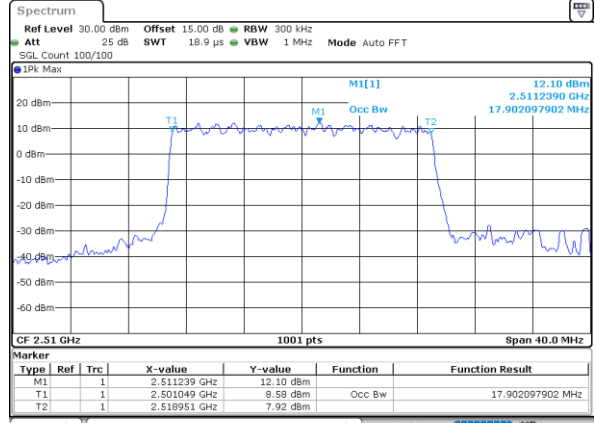

Date: 12.FEB.2021 15:20:41

Middle Channel / 20MHz / QPSK

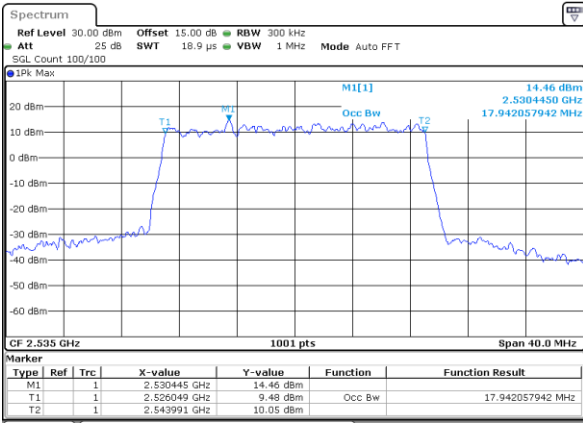

Date: 12.FEB.2021 15:28:06

Middle Channel / 20MHz / 16QAM

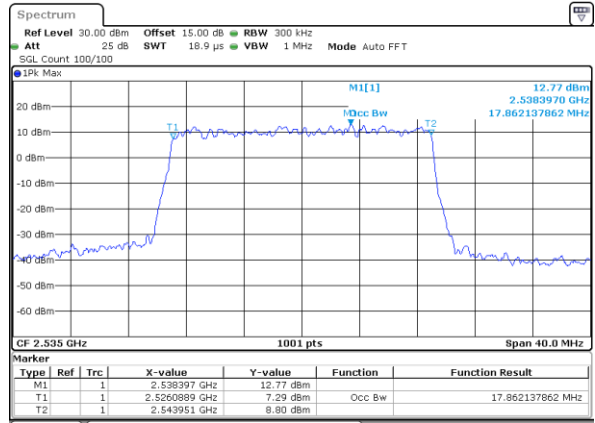

Date: 12.FEB.2021 15:28:17

Highest Channel / 20MHz / QPSK

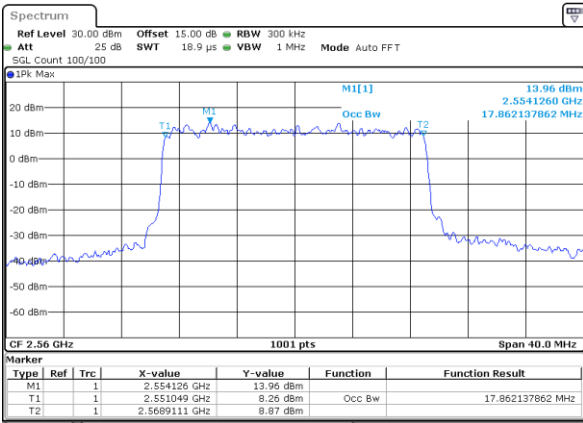

Date: 12.FEB.2021 15:30:36

Highest Channel / 20MHz / 16QAM

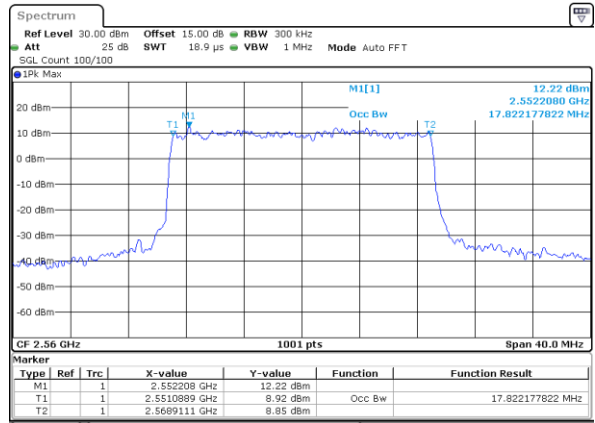

Date: 12.FEB.2021 15:30:47



LTE Band 7

Lowest Channel / 5MHz / 64QAM

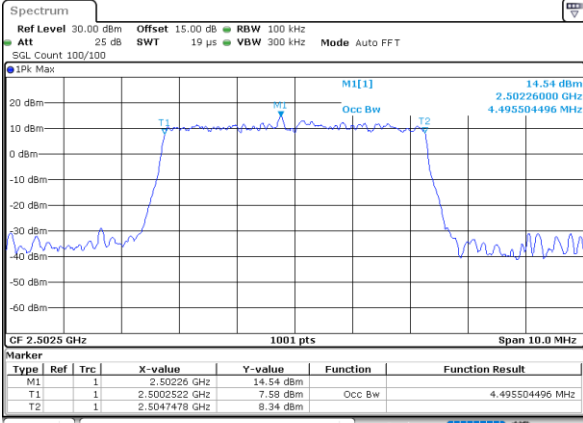

Date: 12.FEB.2021 14:32:02

Lowest Channel / 10MHz / 64QAM

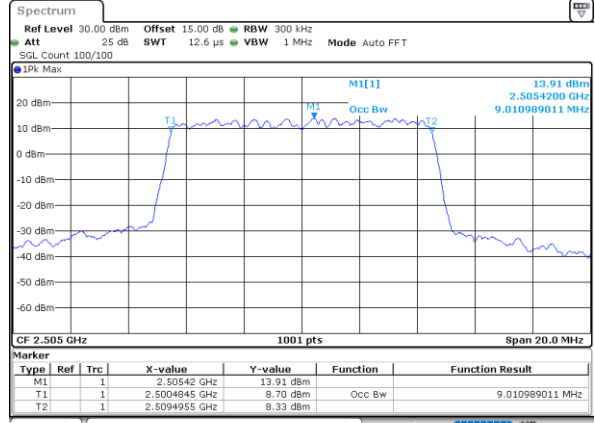

Date: 12.FEB.2021 14:52:46

Middle Channel / 5MHz / 64QAM

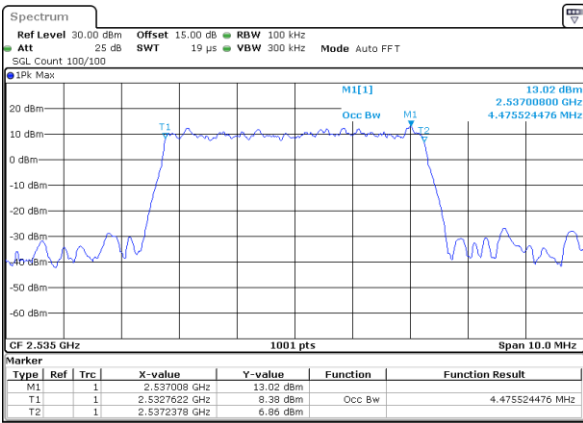

Date: 12.FEB.2021 14:34:46

Middle Channel / 10MHz / 64QAM

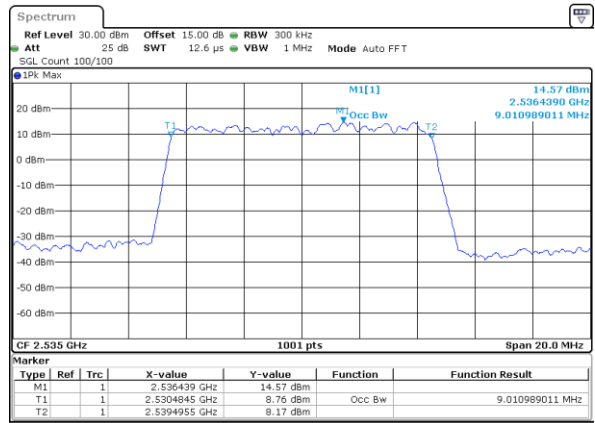

Date: 12.FEB.2021 14:55:29

Highest Channel / 5MHz / 64QAM

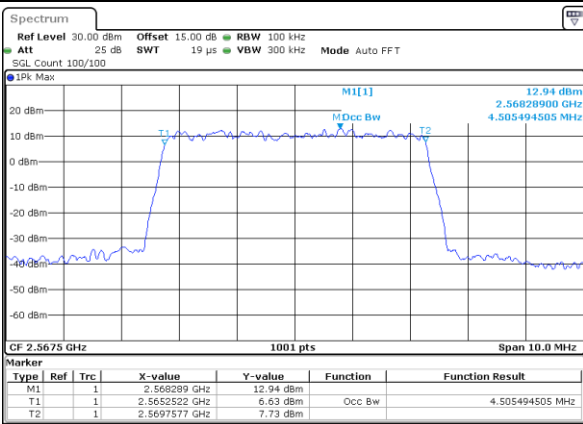

Date: 12.FEB.2021 14:36:01

Highest Channel / 10MHz / 64QAM

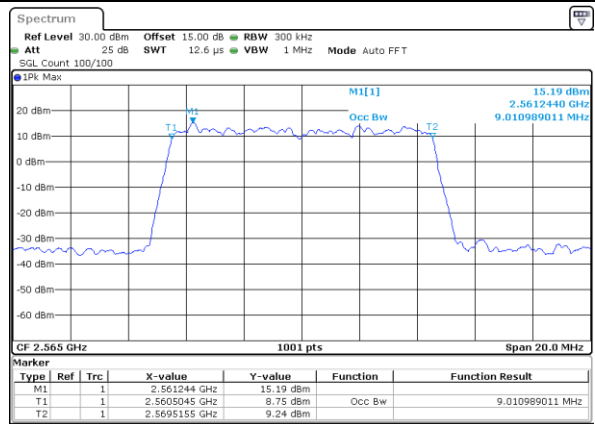

Date: 12.FEB.2021 14:56:44



LTE Band 7

Lowest Channel / 15MHz / 64QAM

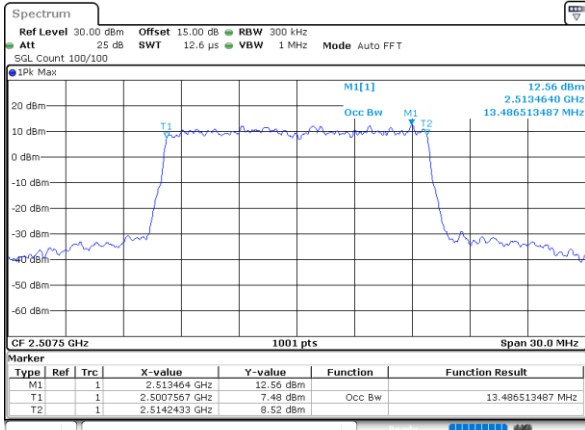

Date: 12.FEB.2021 15:13:35

Lowest Channel / 20MHz / 64QAM

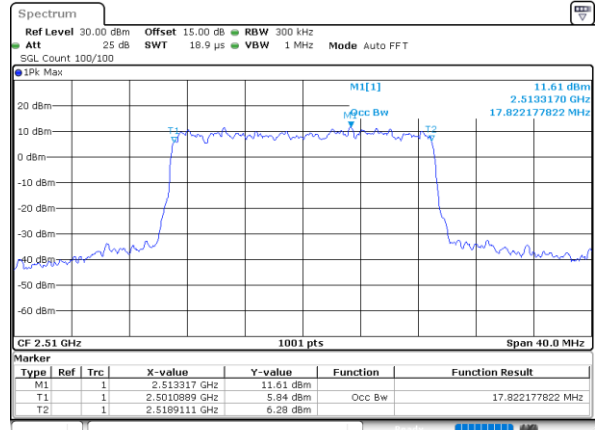

Date: 12.FEB.2021 15:13:42

Middle Channel / 15MHz / 64QAM

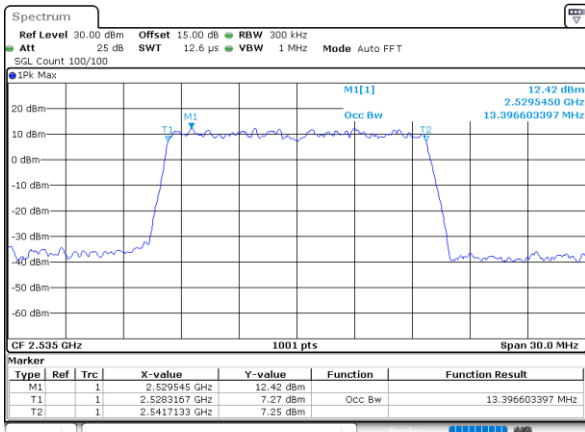

Date: 12.FEB.2021 15:16:32

Middle Channel / 20MHz / 64QAM

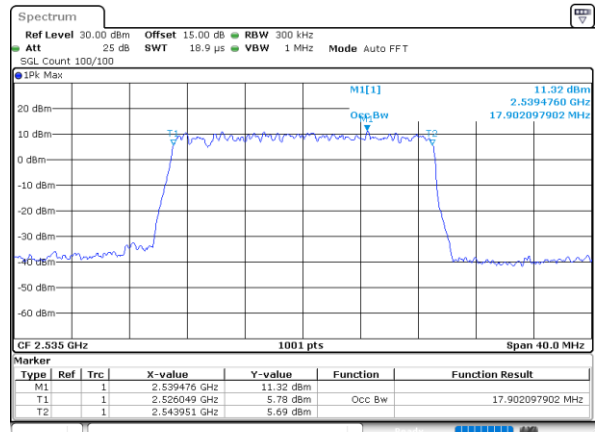

Date: 12.FEB.2021 15:13:26

Highest Channel / 15MHz / 64QAM

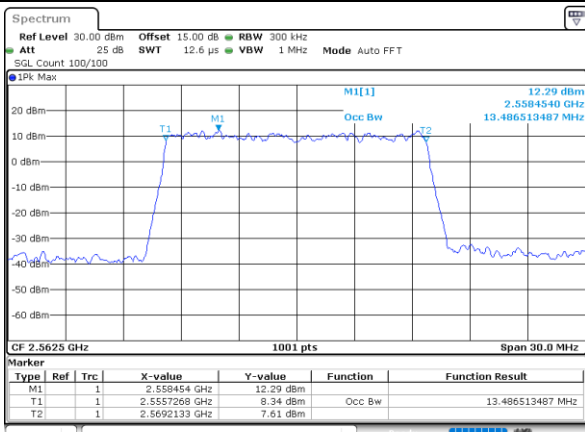

Date: 12.FEB.2021 15:17:47

Highest Channel / 20MHz / 64QAM

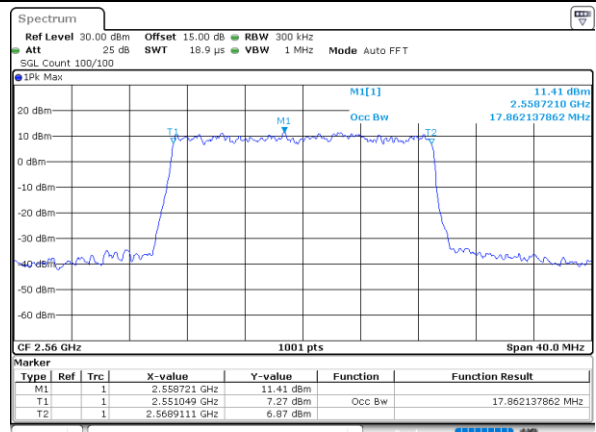

Date: 12.FEB.2021 16:11:26





# Conducted Band Edge

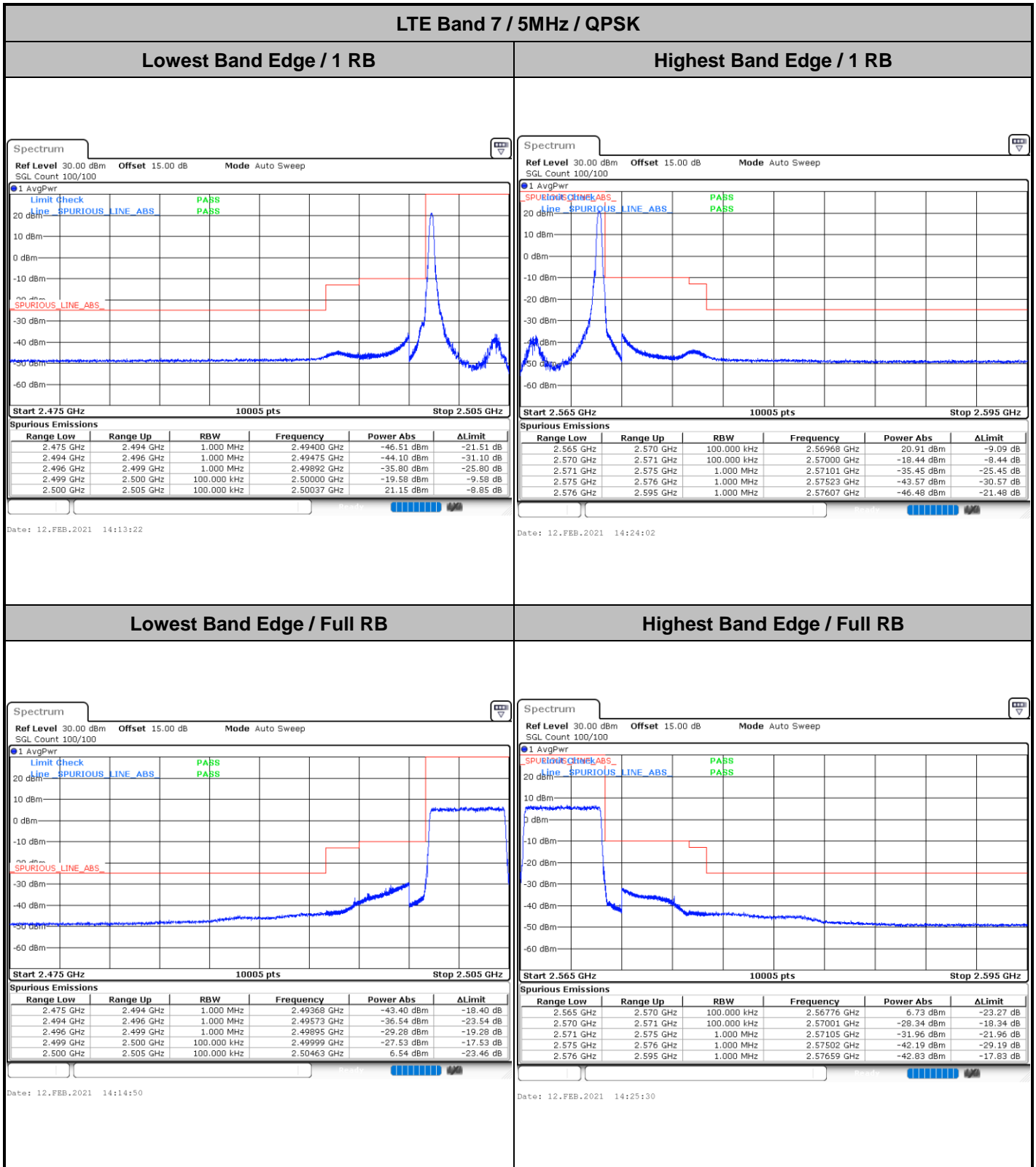



LTE Band 7 / 5MHz / 16QAM

Lowest Band Edge / 1 RB

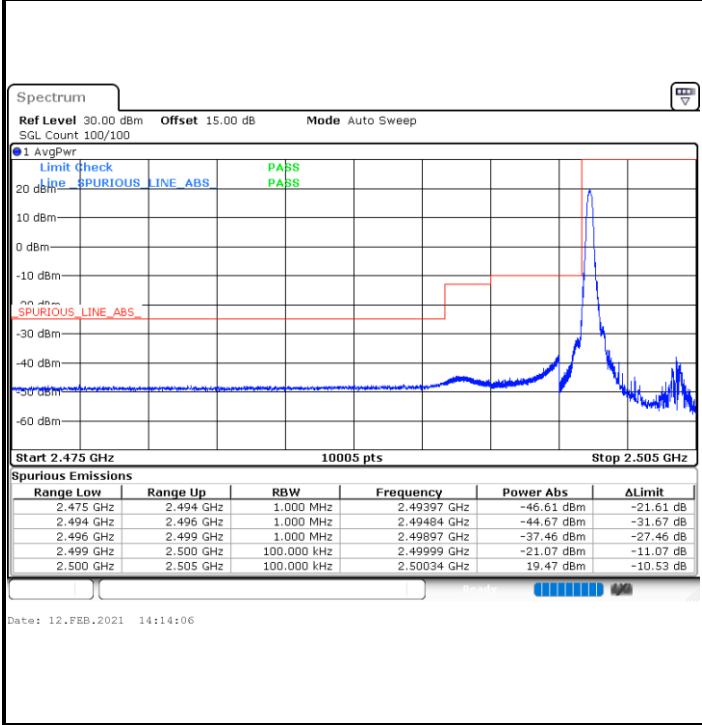

Highest Band Edge / 1 RB

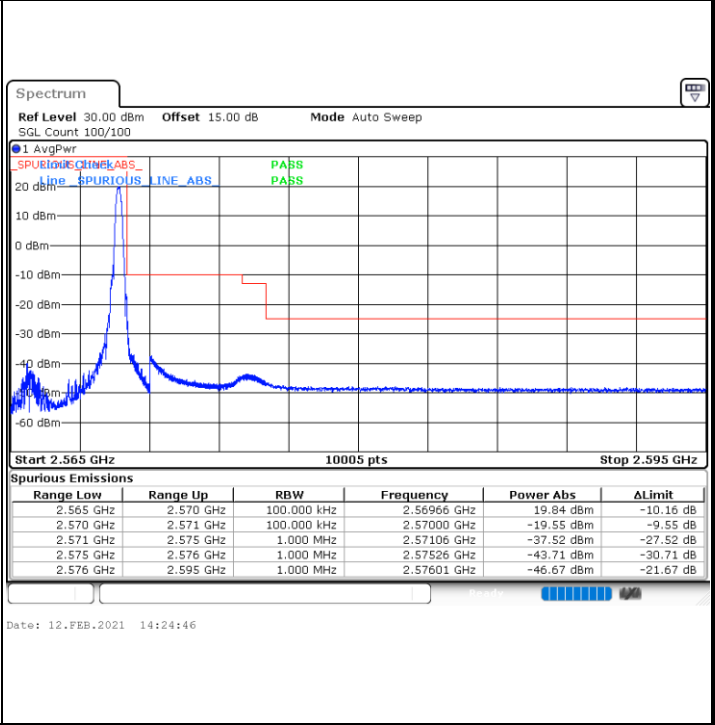

Lowest Band Edge / Full RB

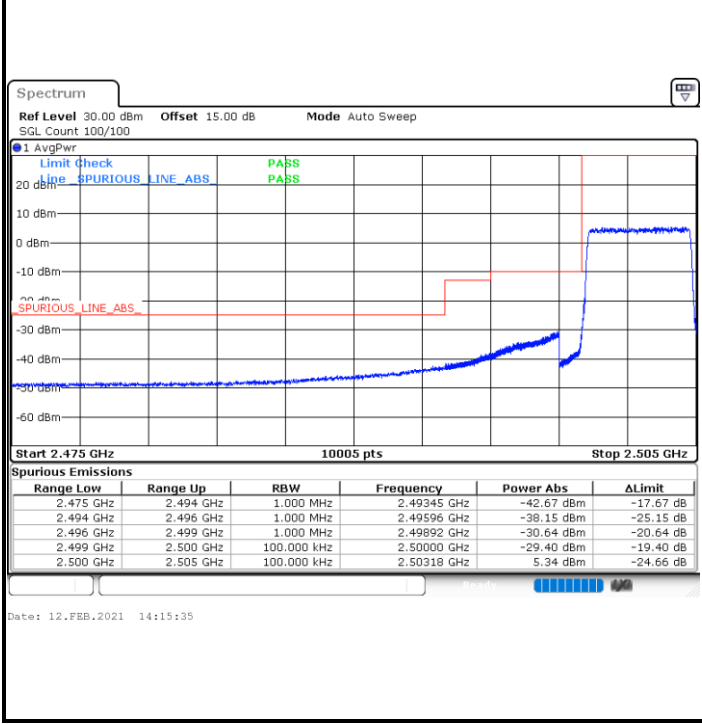

Highest Band Edge / Full RB

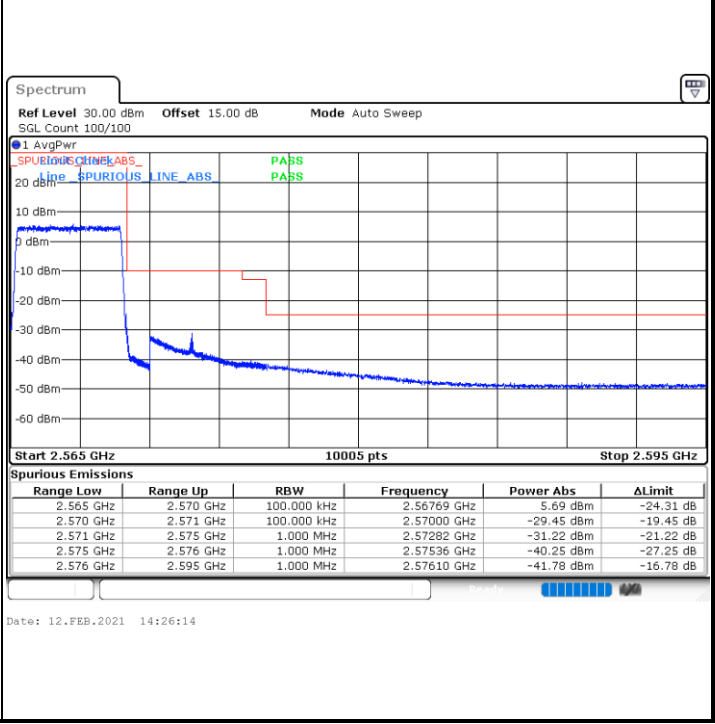



LTE Band 7 / 5MHz / 64QAM

