

# FCC SAR Test Report

APPLICANT : Motorola Mobility LLC  
EQUIPMENT : Mobile Cellular Phone  
BRAND NAME : Motorola  
MODEL NAME : XT2117-1, XT2117-2, XT2117-3, XT2117-4, XT2117DL  
FCC ID : IHDT56ZH1  
STANDARD : FCC 47 CFR Part 2 (2.1093)

We, Sporton International (ShenZhen) Inc, would like to declare that the tested sample has been evaluated in accordance with the procedures and had been in compliance with the applicable technical standards.

The test results in this report apply exclusively to the tested model / sample. Without written approval of Sporton International (ShenZhen) Inc., the test report shall not be reproduced except in full.

*Hank Huang*

Reviewed by: Hank Huang / Supervisor

*Johnny Chen*

Approved by: Johnny Chen / Manager



***Sporton International (ShenZhen) Inc.***

***1/F, 2/F, Bldg 5, Shiling Industrial Zone, Xinwei Village, Xili, Nanshan, Shenzhen, 518055  
People's Republic of China***



Table of Contents

1. Statement of Compliance ..... 4
2. Administration Data ..... 6
3. Guidance Applied ..... 6
4. Equipment Under Test (EUT) Information ..... 7
4.1 General Information ..... 7
4.2 General LTE SAR Test and Reporting Considerations ..... 9
5. Proximity Sensor Triggering Test ..... 12
5.1 Proximity sensor triggering distances(Per KDB616217§6.2) ..... 12
6. RF Exposure Limits ..... 23
6.1 Uncontrolled Environment ..... 23
6.2 Controlled Environment ..... 23
7. Specific Absorption Rate (SAR) ..... 24
7.1 Introduction ..... 24
7.2 SAR Definition ..... 24
8. System Description and Setup ..... 25
8.1 E-Field Probe ..... 26
8.2 Data Acquisition Electronics (DAE) ..... 26
8.3 Phantom ..... 27
8.4 Device Holder ..... 28
9. Measurement Procedures ..... 29
9.1 Spatial Peak SAR Evaluation ..... 29
9.2 Power Reference Measurement ..... 30
9.3 Area Scan ..... 30
9.4 Zoom Scan ..... 31
9.5 Volume Scan Procedures ..... 31
9.6 Power Drift Monitoring ..... 31
10. Test Equipment List ..... 32
11. System Verification ..... 34
11.1 Tissue Simulating Liquids ..... 34
11.2 Tissue Verification ..... 35
11.3 System Performance Check Results ..... 37
12. RF Exposure Positions ..... 39
12.1 Ear and handset reference point ..... 39
12.2 Definition of the cheek position ..... 40
12.3 Definition of the tilt position ..... 41
12.4 Body Worn Accessory ..... 42
12.5 Product Specific 10g SAR Exposure ..... 43
12.6 Wireless Router ..... 43
13. Conducted RF Output Power (Unit: dBm) ..... 44
14. Antenna Location ..... 58
15. SAR Test Results ..... 59
15.1 Head SAR ..... 62
15.2 Hotspot SAR ..... 68
15.3 Body Worn Accessory SAR ..... 77
15.4 Product Specific SAR ..... 86
15.5 Repeated SAR Measurement ..... 92
15.6 TDD LTE Band 41(HPUE) Linearity Data Analysis ..... 93
16. Simultaneous Transmission Analysis ..... 94
16.1 SPLSR and Volume SAR description ..... 95
16.2 Head Exposure Conditions ..... 96
16.3 Hotspot Exposure Conditions ..... 98
16.4 Body-Worn Accessory Exposure Conditions ..... 101
16.5 Product specific 10g SAR Exposure Conditions ..... 104
16.6 SPLSR Evaluation and Analysis ..... 107
16.7 Volume Scan Result ..... 123
17. Supplemental Tuner Tests Results ..... 124
17.1 Supplemental Tuner Head & Body SAR Results ..... 124
18. Uncertainty Assessment ..... 125
19. References ..... 126
Appendix A. Plots of System Performance Check
Appendix B. Plots of High SAR Measurement
Appendix C. DASy Calibration Certificate
Appendix D. Test Setup Photos



Appendix E. Conducted RF Output Power Table  
Appendix F. Supplemental Tuner SAR Results

### Revision History

REPORT NO.	VERSION	DESCRIPTION	ISSUED DATE
FA073102-04	Rev. 01	Initial issue of report.	Mar. 04, 2021
FA073102-04	Rev. 02	Updated power table on page 8.	Mar. 05, 2021



**1. Statement of Compliance**

The maximum results of Specific Absorption Rate (SAR) found during testing for **Motorola Mobility LLC, Mobile Cellular Phone, XT2117-1, XT2117-2, XT2117-3, XT2117-4, XT2117DL**, are as follows.

Highest 1g SAR Summary						
Equipment Class	Frequency Band		Head (Separation 0mm)	Hotspot (Separation 5mm)	Body-worn (Separation 5mm)	Highest Simultaneous Transmission 1g SAR (W/kg)
			1g SAR (W/kg)			
Licensed	GSM	GSM850	0.48	1.38	1.38	1.58
		GSM1900	<0.10	1.43	1.36	
	WCDMA	Band V	0.44	1.35	1.35	
		Band IV	0.16	1.38	1.38	
		Band II	0.17	1.42	1.42	
	CDMA	BC0	0.33	1.31	1.38	
		BC10	0.46	1.07	1.20	
		BC1	0.11	1.11	1.31	
	LTE	Band 71	0.40	1.00	1.00	
		Band 12/Band 17	0.38	0.91	0.91	
		Band 13	0.45	1.24	1.24	
		Band 14	0.27	0.96	0.96	
		Band 5	0.39	<b>1.44</b>	<b>1.44</b>	
		Band 26	0.36	1.26	1.26	
		Band 25/Band 2	0.12	1.34	1.34	
		Band 66/Band 4	0.13	<b>1.44</b>	1.36	
Band 7		0.69	1.31	1.27		
	Band 30	0.51	1.28	1.28		
	Band 41/Band 38	0.65	<b>1.44</b>	<b>1.44</b>		
DTS	WLAN	2.4GHz WLAN	<b>1.09</b>	1.15	1.15	1.56
NII		5GHz WLAN	0.11	1.19	1.38	1.58
DSS	Bluetooth	2.4GHz Bluetooth	0.11	<0.10	<0.10	1.52
Highest 10g SAR Summary						
Equipment Class	Frequency Band		Product Specific 10g SAR (W/kg) (Separation 0mm)		Highest Simultaneous Transmission 10g SAR (W/kg)	
Licensed	GSM	GSM850	1.53		3.81	
		GSM1900	2.19			
	WCDMA	Band V	2.55			
		Band IV	2.19			
		Band II	2.07			
	CDMA	BC0	2.54			
		BC1	2.25			
	LTE	Band 13	1.93			
		Band 5	2.59			
		Band 26	2.19			
		Band 25/Band 2	2.82			
		Band 66/Band 4	3.27			
		Band 7	2.25			
Band 30		2.16				
Band 41/Band 38		2.25				
DTS	WLAN	2.4GHz WLAN	2.01		3.81	
NII		5GHz WLAN	<b>3.51</b>		3.51	
Date of Testing:			2020/8/27~2020/10/19 & 2021/3/2~2021/3/4			



**Remark:** This device supports LTE B2 / B4 / B17 / B38 and B25 / B66 / B12 / B41. Since the supported frequency span for LTE B2 / B4 / B17 / B38 falls completely within the supports frequency span for LTE B25 / B66 / B12 / B41, both LTE bands have the same target power, and both LTE bands share the same transmission path; therefore, SAR was only assessed for LTE B25 / B66 / B12 / B41.

**Declaration of Conformity:**

The test results with all measurement uncertainty excluded are presented in accordance with the regulation limits or requirements declared by manufacturers.

**Comments and Explanations:**

The declared of product specification for EUT presented in the report are provided by the manufacturer, and the manufacturer takes all the responsibilities for the accuracy of product specification.

This device is in compliance with Specific Absorption Rate (SAR) for general population/uncontrolled exposure limits (1.6 W/kg for Partial-Body 1g SAR, 4.0 W/kg for Product Specific 10g SAR) specified in FCC 47 CFR part 2 (2.1093) and ANSI/IEEE C95.1-1992, and had been tested in accordance with the measurement methods and procedures specified in IEEE 1528-2013 and FCC KDB publications.



2. Administration Data

Sporton International (Shenzhen) Inc. is accredited to ISO/IEC 17025:2017 by American Association for Laboratory Accreditation with Certificate Number 5145.01.

Table with 3 columns: Test Firm, Test Site Location, and Test Site No. (with sub-columns for FCC Designation No. and FCC Test Firm Registration No.).

Table with 2 columns: Applicant Company Name and Address.

Table with 2 columns: Manufacturer Company Name and Address.

3. Guidance Applied

The Specific Absorption Rate (SAR) testing specification, method, and procedure for this device is in accordance with the following standards:

- List of standards including FCC 47 CFR Part 2 (2.1093), ANSI/IEEE C95.1-1992, IEEE 1528-2013, and various FCC KDB SAR measurement and reporting guidelines.



**4. Equipment Under Test (EUT) Information**

**4.1 General Information**

Product Feature & Specification	
Equipment Name	Mobile Cellular Phone
Brand Name	Motorola
Model Name	XT2117-1, XT2117-2, XT2117-3, XT2117-4, XT2117DL
FCC ID	IHDT56ZH1
IMEI Code	Original: 356891110020692 verify: 356891110020932
Wireless Technology and Frequency Range	GSM850: 824.2 MHz ~ 848.8 MHz GSM1900: 1850.2 MHz ~ 1909.8 MHz WCDMA Band II: 1852.4 MHz ~ 1907.6 MHz WCDMA Band IV: 1712.4 MHz ~ 1752.6 MHz WCDMA Band V: 826.4 MHz ~ 846.6 MHz CDMA2000 BC0: 824.7 MHz ~ 848.31 MHz CDMA 2000 BC1: 1851.25 MHz ~ 1908.75 MHz CDMA 2000 BC10: 817.9 MHz ~ 823.1 MHz LTE Band 2: 1850.7 MHz ~ 1909.3 MHz LTE Band 4: 1710.7 MHz ~ 1754.3 MHz LTE Band 5: 824.7 MHz ~ 848.3 MHz LTE Band 7: 2502.5 MHz ~ 2567.5 MHz LTE Band 12: 699.7 MHz ~ 715.3 MHz LTE Band 13: 779.5 MHz ~ 784.5 MHz LTE Band 14: 790.5 MHz ~ 795.5 MHz LTE Band 17: 706.5 MHz ~ 713.5 MHz LTE Band 25: 1850.7 MHz ~ 1914.3 MHz LTE Band 26: 814.7 MHz ~ 848.3 MHz LTE Band 30 : 2307.5 MHz ~ 2312.5 MHz LTE Band 38: 2572.5 MHz ~ 2617.5 MHz LTE Band 41: 2498.5 MHz ~ 2687.5 MHz LTE Band 66: 1710.7 MHz ~ 1779.3 MHz LTE Band 71: 665.5 MHz ~ 695.5 MHz WLAN 2.4GHz Band: 2412 MHz ~ 2462 MHz WLAN 5.2GHz Band: 5180 MHz ~ 5240 MHz WLAN 5.3GHz Band: 5260 MHz ~ 5320 MHz WLAN 5.5GHz Band: 5500 MHz ~ 5700 MHz WLAN 5.8GHz Band: 5745 MHz ~ 5825 MHz Bluetooth: 2402 MHz ~ 2480 MHz
Mode	GSM/GPRS/EGPRS RMC/AMR 12.2Kbps HSDPA HSUPA DC-HSDPA HSPA+(16QAM uplink is not supported) CDMA2000 : 1xRTT/1xEv-Do(Rev.0)/1xEv-Do(Rev.A) LTE: QPSK, 16QAM, 64QAM WLAN 2.4GHz 802.11b/g/n HT20 WLAN 5GHz 802.11a/n HT20/HT40 WLAN 5GHz 802.11ac VHT20/VHT40/VHT80 Bluetooth BR/EDR/LE
HW Version	DVT2
SW Version	QZB30.Q4-16
GSM / (E)GPRS Transfer mode	Class B – EUT cannot support Packet Switched and Circuit Switched Network simultaneously but can automatically switch between Packet and Circuit Switched Network.
EUT Stage	Identical Prototype
Remark:	1. 802.11n-HT40 is not supported in 2.4GHz WLAN. 2. WLAN operation in 5600 MHz ~ 5650 MHz is notched



3. This device supports VoIP in GPRS, EGPRS, CDMA, WCDMA and LTE (e.g. for 3rd-party VoIP), LTE supports VoLTE operation.
4. This device 2.4GHz WLAN support hotspot operation and Bluetooth support tethering applications.
5. This device 2.4GHz WLAN/5.2GHz WLAN/5.8GHz WLAN support hotspot operation, and 5.2GHz WLAN/5.8GHz WLAN supports WiFi Direct (GC/GO), and 5.3GHz / 5.5GHz supports WiFi Direct (GC only).
6. This device does not support DTM operation and supports GRPS/EGRPS mode up to multi-slot class 12.
7. This device supports HPUE for LTE band 41 with class 2 power level, so HPUE SAR has been performed.
8. The device implements Proximity sensors/receiver detect mechanism/hotspot trigger reduced power for the power management for SAR compliance at different exposure conditions (head, body-worn, hotspot, extremity).
9. The device will invoke corresponding work scenarios power level, which are provided in the operational description.
10. For Some WWAN bands, sensor on reduced power level higher than hotspot reduced power level, so front/back sensor on SAR can represent hotspot conservatively.
11. This device has two WWAN transmitter antennas. WWAN antenna 1 is located at the right of bottom edge of the device and WWAN antenna 2 is located at the left side of bottom edge of the device which can refer to antenna location chapter. WWAN antenna 1 frequency bands include GSM850/1900, WCDMA Band II/IV/V, CDMA2000 BC0/BC1/BC10, and LTE Band 2/4/5/12/13/14/17/25/26/66/71, WWAN antenna 2 frequency band include LTE Band 7/30/38/41.
12. This device implements antenna tuning techniques for several WWAN (cellular) operating modes and frequencies for the purpose of improving antenna efficiency over a broad range of frequencies. Specifically, these techniques are employed in the WCDMA, CDMA and LTE modes of WWAN antenna 1. In this report SAR was measured according to the normally required SAR configurations with the tuner active and worst tune state (auto tune) was used for SAR testing. The detail descriptions of the antenna tuner and supplemental data for additional information on section17.

**Change Note:**

1. This is a variant report for XT2117-1, XT2117-2, XT2117-3, XT2117-4, XT2117DL, for model change note, only updated the handheld reduced power level for LTE B2/B4/B25/B66 via software, the following table listed the detail maximum tune up power state between original application and this variant application. We perform full SAR testing for handheld SAR for those bands and other Bands leverage from original report which can be referred to Sporton Report Number FA073102.
2. For LTE B2 /B4 /B25 / B66, since the supported frequency span for LTE B2/B4 falls completely within the supports frequency span for B25 / B66, both LTE bands have the same target power, So handheld SAR was only assessed for LTE B25 / B66.

WWAN Bands	Full Power(dBm)		Handheld reduce power(dBm)	
	Original	Variant	Original	Variant
LTE band 2	24.00	24.00	19.00	20.50
LTE band 4	24.00	24.00	18.50	20.00
LTE band 25	24.00	24.00	19.00	20.50
LTE band 66	24.00	24.00	18.50	20.00





4.2 General LTE SAR Test and Reporting Considerations

Summarized necessary items addressed in KDB 941225 D05 v02r05																																																															
FCC ID	IHDT56ZH1																																																														
Equipment Name	Mobile Cellular Phone																																																														
Operating Frequency Range of each LTE transmission band	LTE Band 2: 1850.7 MHz ~ 1909.3 MHz LTE Band 4: 1710.7 MHz ~ 1754.3 MHz LTE Band 5: 824.7 MHz ~ 848.3 MHz LTE Band 7: 2502.5 MHz ~ 2567.5 MHz LTE Band 12: 699.7 MHz ~ 715.3 MHz LTE Band 13: 779.5 MHz ~ 784.5 MHz LTE Band 14: 790.5 MHz ~ 795.5 MHz LTE Band 17: 706.5 MHz ~ 713.5 MHz LTE Band 25: 1850.7 MHz ~ 1914.3 MHz LTE Band 26: 814.7 MHz ~ 848.3 MHz LTE Band 30 : 2307.5 MHz ~ 2312.5 MHz LTE Band 38: 2572.5 MHz ~ 2617.5 MHz LTE Band 41: 2498.5 MHz ~ 2687.5 MHz LTE Band 66: 1710.7 MHz ~ 1779.3 MHz LTE Band 71: 665.5 MHz ~ 695.5 MHz																																																														
Channel Bandwidth	LTE Band 2:1.4MHz, 3MHz, 5MHz, 10MHz, 15MHz, 20MHz LTE Band 4:1.4MHz, 3MHz, 5MHz, 10MHz, 15MHz, 20MHz LTE Band 5:1.4MHz, 3MHz, 5MHz, 10MHz LTE Band 7: 5MHz, 10MHz, 15MHz, 20MHz LTE Band 12:1.4MHz, 3MHz, 5MHz, 10MHz LTE Band 13: 5MHz, 10MHz LTE Band 14: 5MHz, 10MHz LTE Band 17: 5MHz, 10MHz LTE Band 25:1.4MHz, 3MHz, 5MHz, 10MHz, 15MHz, 20MHz LTE Band 26:1.4MHz, 3MHz, 5MHz, 10MHz, 15MHz LTE Band 30: 5MHz, 10MHz LTE Band 38: 5MHz, 10MHz, 15MHz, 20MHz LTE Band 41: 5MHz, 10MHz, 15MHz, 20MHz LTE Band 66:1.4MHz, 3MHz, 5MHz, 10MHz, 15MHz, 20MHz LTE Band 71: 5MHz, 10MHz, 15MHz, 20MHz																																																														
uplink modulations used	QPSK / 16QAM / 64QAM																																																														
LTE Voice / Data requirements	Voice and Data																																																														
LTE Release Version	R10, Cat13																																																														
CA Support	Supported, Uplink and Downlink																																																														
LTE MPR permanently built-in by design	<p align="center"><b>Table 6.2.3-1: Maximum Power Reduction (MPR) for Power Class 1, 2 and 3</b></p> <table border="1"> <thead> <tr> <th rowspan="2">Modulation</th> <th colspan="6">Channel bandwidth / Transmission bandwidth (N<sub>RB</sub>)</th> <th rowspan="2">MPR (dB)</th> </tr> <tr> <th>1.4 MHz</th> <th>3.0 MHz</th> <th>5 MHz</th> <th>10 MHz</th> <th>15 MHz</th> <th>20 MHz</th> </tr> </thead> <tbody> <tr> <td>QPSK</td> <td>&gt; 5</td> <td>&gt; 4</td> <td>&gt; 8</td> <td>&gt; 12</td> <td>&gt; 16</td> <td>&gt; 18</td> <td>≤ 1</td> </tr> <tr> <td>16 QAM</td> <td>≤ 5</td> <td>≤ 4</td> <td>≤ 8</td> <td>≤ 12</td> <td>≤ 16</td> <td>≤ 18</td> <td>≤ 1</td> </tr> <tr> <td>16 QAM</td> <td>&gt; 5</td> <td>&gt; 4</td> <td>&gt; 8</td> <td>&gt; 12</td> <td>&gt; 16</td> <td>&gt; 18</td> <td>≤ 2</td> </tr> <tr> <td>64 QAM</td> <td>≤ 5</td> <td>≤ 4</td> <td>≤ 8</td> <td>≤ 12</td> <td>≤ 16</td> <td>≤ 18</td> <td>≤ 2</td> </tr> <tr> <td>64 QAM</td> <td>&gt; 5</td> <td>&gt; 4</td> <td>&gt; 8</td> <td>&gt; 12</td> <td>&gt; 16</td> <td>&gt; 18</td> <td>≤ 3</td> </tr> <tr> <td>256 QAM</td> <td colspan="6" style="text-align: center;">≥ 1</td> <td>≤ 5</td> </tr> </tbody> </table>	Modulation	Channel bandwidth / Transmission bandwidth (N <sub>RB</sub> )						MPR (dB)	1.4 MHz	3.0 MHz	5 MHz	10 MHz	15 MHz	20 MHz	QPSK	> 5	> 4	> 8	> 12	> 16	> 18	≤ 1	16 QAM	≤ 5	≤ 4	≤ 8	≤ 12	≤ 16	≤ 18	≤ 1	16 QAM	> 5	> 4	> 8	> 12	> 16	> 18	≤ 2	64 QAM	≤ 5	≤ 4	≤ 8	≤ 12	≤ 16	≤ 18	≤ 2	64 QAM	> 5	> 4	> 8	> 12	> 16	> 18	≤ 3	256 QAM	≥ 1						≤ 5
Modulation	Channel bandwidth / Transmission bandwidth (N <sub>RB</sub> )						MPR (dB)																																																								
	1.4 MHz	3.0 MHz	5 MHz	10 MHz	15 MHz	20 MHz																																																									
QPSK	> 5	> 4	> 8	> 12	> 16	> 18	≤ 1																																																								
16 QAM	≤ 5	≤ 4	≤ 8	≤ 12	≤ 16	≤ 18	≤ 1																																																								
16 QAM	> 5	> 4	> 8	> 12	> 16	> 18	≤ 2																																																								
64 QAM	≤ 5	≤ 4	≤ 8	≤ 12	≤ 16	≤ 18	≤ 2																																																								
64 QAM	> 5	> 4	> 8	> 12	> 16	> 18	≤ 3																																																								
256 QAM	≥ 1						≤ 5																																																								
LTE A-MPR	In the base station simulator configuration, Network Setting value is set to NS_01 to disable A-MPR during SAR testing and the LTE SAR tests was transmitting on all TTI frames (Maximum TTI)																																																														
Spectrum plots for RB configuration	A properly configured base station simulator was used for the SAR and power measurement; therefore, spectrum plots for each RB allocation and offset configuration are not included in the SAR report.																																																														
Power reduction applied to satisfy SAR compliance	Yes, head/body-worn/ hotspot/extremity will trigger reduced power for some LTE bands, the detail please referred to section 13.																																																														
LTE Carrier Aggregation Combinations	Inter-Band and Intra-Band possible combinations and the detail power verification please referred to section 13.																																																														
LTE Carrier Aggregation Additional Information	1. This device supports LTE Carrier Aggregation (CA) in the uplink for 41C with two component carriers in the uplink. SAR Measurements and conducted powers were evaluated per FCC Guidance. 2. This device supports maximum of 2 carriers in the downlink and 2 carriers in the uplink. Additional following LTE Release features are not supported: Relay, HetNet, Enhanced MIMO, eICI, WiFi Offloading, MDH, eMBMA, Cross-Carrier Scheduling, Enhanced SC-FDMA.																																																														



Transmission (H, M, L) channel numbers and frequencies in each LTE band																
LTE Band 2																
	Bandwidth 1.4 MHz		Bandwidth 3 MHz		Bandwidth 5 MHz		Bandwidth 10 MHz		Bandwidth 15 MHz		Bandwidth 20 MHz					
	Ch. #	Freq. (MHz)	Ch. #	Freq. (MHz)	Ch. #	Freq. (MHz)	Ch. #	Freq. (MHz)	Ch. #	Freq. (MHz)	Ch. #	Freq. (MHz)				
L	18607	1850.7	18615	1851.5	18625	1852.5	18650	1855	18675	1857.5	18700	1860				
M	18900	1880	18900	1880	18900	1880	18900	1880	18900	1880	18900	1880				
H	19193	1909.3	19185	1908.5	19175	1907.5	19150	1905	19125	1902.5	19100	1900				
LTE Band 4																
	Bandwidth 1.4 MHz		Bandwidth 3 MHz		Bandwidth 5 MHz		Bandwidth 10 MHz		Bandwidth 15 MHz		Bandwidth 20 MHz					
	Ch. #	Freq. (MHz)	Ch. #	Freq. (MHz)	Ch. #	Freq. (MHz)	Ch. #	Freq. (MHz)	Ch. #	Freq. (MHz)	Ch. #	Freq. (MHz)				
L	19957	1710.7	19965	1711.5	19975	1712.5	20000	1715	20025	1717.5	20050	1720				
M	20175	1732.5	20175	1732.5	20175	1732.5	20175	1732.5	20175	1732.5	20175	1732.5				
H	20393	1754.3	20385	1753.5	20375	1752.5	20350	1750	20325	1747.5	20300	1745				
LTE Band 5																
	Bandwidth 1.4 MHz		Bandwidth 3 MHz		Bandwidth 5 MHz		Bandwidth 10 MHz		Bandwidth 15 MHz		Bandwidth 20 MHz					
	Ch. #	Freq. (MHz)	Ch. #	Freq. (MHz)	Ch. #	Freq. (MHz)	Ch. #	Freq. (MHz)	Ch. #	Freq. (MHz)	Ch. #	Freq. (MHz)				
L	20407	824.7	20415	825.5	20425	826.5	20450	829	20450	829	20450	829				
M	20525	836.5	20525	836.5	20525	836.5	20525	836.5	20525	836.5	20525	836.5				
H	20643	848.3	20635	847.5	20625	846.5	20600	844	20600	844	20600	844				
LTE Band 7																
	Bandwidth 5 MHz		Bandwidth 10 MHz		Bandwidth 15 MHz		Bandwidth 20 MHz		Bandwidth 15 MHz		Bandwidth 20 MHz					
	Ch. #	Freq. (MHz)	Ch. #	Freq. (MHz)	Ch. #	Freq. (MHz)	Ch. #	Freq. (MHz)	Ch. #	Freq. (MHz)	Ch. #	Freq. (MHz)				
L	20775	2502.5	20800	2505	20825	2507.5	20850	2510	20850	2510	20850	2510				
M	21100	2535	21100	2535	21100	2535	21100	2535	21100	2535	21100	2535				
H	21425	2567.5	21400	2565	21375	2562.5	21350	2560	21350	2560	21350	2560				
LTE Band 12																
	Bandwidth 1.4 MHz		Bandwidth 3 MHz		Bandwidth 5 MHz		Bandwidth 10 MHz		Bandwidth 15 MHz		Bandwidth 20 MHz					
	Ch. #	Freq. (MHz)	Ch. #	Freq. (MHz)	Ch. #	Freq. (MHz)	Ch. #	Freq. (MHz)	Ch. #	Freq. (MHz)	Ch. #	Freq. (MHz)				
L	23017	699.7	23025	700.5	23035	701.5	23060	704	23060	704	23060	704				
M	23095	707.5	23095	707.5	23095	707.5	23095	707.5	23095	707.5	23095	707.5				
H	23173	715.3	23165	714.5	23155	713.5	23130	711	23130	711	23130	711				
LTE Band 13																
	Bandwidth 5 MHz				Bandwidth 10 MHz				Bandwidth 15 MHz				Bandwidth 20 MHz			
	Channel #		Freq.(MHz)		Channel #		Freq.(MHz)		Channel #		Freq.(MHz)		Channel #		Freq.(MHz)	
L	23205		779.5		23230		782		23230		782		23230		782	
M	23230		782		23230		782		23230		782		23230		782	
H	23255		784.5		23230		782		23230		782		23230		782	
LTE Band 14																
	Bandwidth 5 MHz				Bandwidth 10 MHz				Bandwidth 15 MHz				Bandwidth 20 MHz			
	Channel #		Channel #		Channel #		Freq.(MHz)		Channel #		Freq.(MHz)		Channel #		Freq.(MHz)	
L	23305		790.5		23330		793		23330		793		23330		793	
M	23330		793		23330		793		23330		793		23330		793	
H	23355		795.5		23330		793		23330		793		23330		793	
LTE Band 17																
	Bandwidth 5 MHz				Bandwidth 10 MHz				Bandwidth 15 MHz				Bandwidth 20 MHz			
	Channel #		Freq.(MHz)		Channel #		Freq. (MHz)		Channel #		Freq. (MHz)		Channel #		Freq. (MHz)	
L	23755		706.5		23780		709		23780		709		23780		709	
M	23790		710		23790		710		23790		710		23790		710	
H	23825		713.5		23800		711		23800		711		23800		711	



LTE Band 25												
	Bandwidth 1.4 MHz		Bandwidth 3 MHz		Bandwidth 5 MHz		Bandwidth 10 MHz		Bandwidth 15 MHz		Bandwidth 20 MHz	
	Ch. #	Freq. (MHz)	Ch. #	Freq. (MHz)	Ch. #	Freq. (MHz)	Ch. #	Freq. (MHz)	Ch. #	Freq. (MHz)	Ch. #	Freq. (MHz)
L	26047	1850.7	26055	1851.5	26065	1852.5	26090	1855	26115	1857.5	26140	1860
M	26340	1880	26340	1880	26340	1880	26340	1880	26340	1880	26340	1880
H	26683	1914.3	26675	1913.5	26665	1912.5	26640	1910	26615	1907.5	26590	1905
LTE Band 26												
	Bandwidth 1.4 MHz		Bandwidth 3 MHz		Bandwidth 5 MHz		Bandwidth 10 MHz		Bandwidth 15 MHz			
	Ch. #	Freq. (MHz)	Ch. #	Freq. (MHz)	Ch. #	Freq. (MHz)	Ch. #	Freq. (MHz)	Ch. #	Freq. (MHz)	Ch. #	Freq. (MHz)
L	26697	814.7	26705	815.5	26715	816.5	26740	819	26765	821.5		
M	26865	831.5	26865	831.5	26865	831.5	26865	831.5	26865	831.5		
H	27033	848.3	27025	847.5	27015	846.5	26990	844	26965	841.5		
LTE Band 30												
	Bandwidth 5 MHz					Bandwidth 10 MHz						
	Channel #		Freq.(MHz)			Channel #		Freq.(MHz)				
L	27685		2307.5			27710		2310				
M	27710		2310									
H	27735		2312.5									
LTE Band 38												
	Bandwidth 5 MHz		Bandwidth 10 MHz		Bandwidth 15 MHz		Bandwidth 20 MHz					
	Ch. #	Freq. (MHz)	Ch. #	Freq. (MHz)	Ch. #	Freq. (MHz)	Ch. #	Freq. (MHz)	Ch. #	Freq. (MHz)	Ch. #	Freq. (MHz)
L	37775	2572.5	37800	2575	37825	2577.5	37850	2580				
M	38000	2595	38000	2595	38000	2595	38000	2595				
H	38225	2617.5	38200	2615	38175	2612.5	38150	2610				
LTE Band 41												
	Bandwidth 5 MHz		Bandwidth 10 MHz		Bandwidth 15 MHz		Bandwidth 20 MHz					
	Ch. #	Freq. (MHz)	Ch. #	Freq. (MHz)	Ch. #	Freq. (MHz)	Ch. #	Freq. (MHz)	Ch. #	Freq. (MHz)	Ch. #	Freq. (MHz)
L	39675	2498.5	39700	2501	39725	2503.5	39750	2506				
LM	40148	2545.8	40160	2547	40173	2548.3	40185	2549.5				
M	40620	2593	40620	2593	40620	2593	40620	2593				
HM	41093	2640.3	41080	2639	41068	2637.8	41055	2636.5				
H	41565	2687.5	41540	2685	41515	2682.5	41490	2680				
LTE Band 66												
	Bandwidth 1.4 MHz		Bandwidth 3 MHz		Bandwidth 5 MHz		Bandwidth 10 MHz		Bandwidth 15 MHz		Bandwidth 20 MHz	
	Ch. #	Freq. (MHz)	Ch. #	Freq. (MHz)	Ch. #	Freq. (MHz)	Ch. #	Freq. (MHz)	Ch. #	Freq. (MHz)	Ch. #	Freq. (MHz)
L	131979	1710.7	131987	1711.5	131997	1712.5	132022	1715	132047	1717.5	132072	1720
M	132322	1745	132322	1745	132322	1745	132322	1745	132322	1745	132322	1745
H	132665	1779.3	132657	1778.5	132647	1777.5	132622	1775	132597	1772.5	132572	1770
LTE Band 71												
	Bandwidth 5 MHz		Bandwidth 10 MHz		Bandwidth 15 MHz		Bandwidth 20 MHz					
	Ch. #	Freq. (MHz)	Ch. #	Freq. (MHz)	Ch. #	Freq. (MHz)	Ch. #	Freq. (MHz)	Ch. #	Freq. (MHz)	Ch. #	Freq. (MHz)
L	133147	665.5	133172	668	133197	670.5	133222	673				
M	133247	675.5	133272	678	133297	680.5	133322	683				
H	133447	695.5	133422	693	133397	690.5	133372	688				

## 5. Proximity Sensor Triggering Test

### 5.1 Proximity sensor triggering distances(Per KDB616217§6.2)

- Proximity sensor triggering distance testing was performed according to the procedures outlined in KDB 616217 D04 section 6.2, and EUT moving further away from the flat phantom and EUT moving toward the flat phantom were both assessed and the tissue-equivalent medium for highest frequency (5825MHz) and lowest (850MHz) frequency was used for proximity sensor triggering testing.
- Capacitive proximity sensor placed coincident with antenna elements at the bottom end of the phone are utilized to determine when the device comes in proximity of the user's body at the front or back or bottom or left side surface of the device. There is no need to do sensor coverage testing for the proximity sensor is designed to support sufficient detection range and sensitivity to cover regions of the sensors in all applicable directions since the proximity sensor entirely covers the antenna.
- When the proximity sensor is active, GSM1900, WCDMA band II/IV/V, CDMA BC1, LTE band 2/4/7/25/26/30/66/38/41/41HPUE and WLAN2.4GHz/WLAN5.2GHz/5.3GHz/5.5GHz/5.8GHz reduced power will be active for front/ back body worn SAR.
- P-sensor can detect handheld state, GSM1900, WCDMA band II/IV, CDMA BC1 and LTE B2/4/7/25/30/66/38/41/41HPUE for front/back/left/bottom sides of product specific 10g SAR condition reduced powers will be active for handheld SAR.
- The proximity sensors used to detect the proximity of the user's body at the front or back or bottom side surface of the device use a detection threshold distance. The data shown in the sections below shows the distance(s).
- For verification of compliance of power reduction scheme, additional SAR testing with EUT transmitting at full RF power at a conservative trigger distance was performed for body worn:  
Front: [18 mm](#)  
Back: [19 mm](#)
- For verification of compliance of power reduction scheme, additional SAR testing with EUT transmitting at full RF power at a conservative trigger distance was performed for handheld:  
For antenna 1  
Front: [15 mm](#)  
Back: [17 mm](#)  
Bottom side: [18 mm](#)  
  
For antenna 2  
Front: [7 mm](#)  
Back: [7 mm](#)  
Left side: [8 mm](#)  
Bottom side: [8 mm](#)

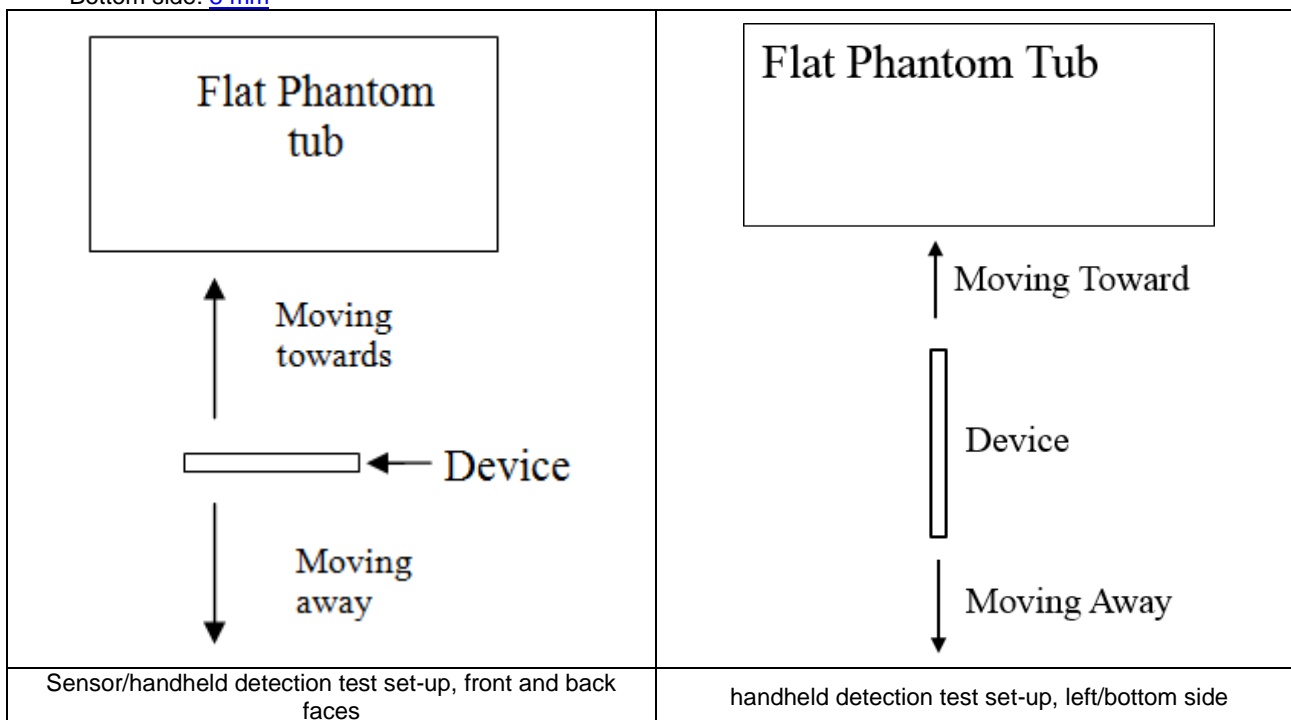

<P-Sensor>

Proximity Sensor Triggering Distance (mm)				
Position	Front		Back	
	Moving towards	Moving away	Moving towards	Moving away
Minimum	19	22	20	22

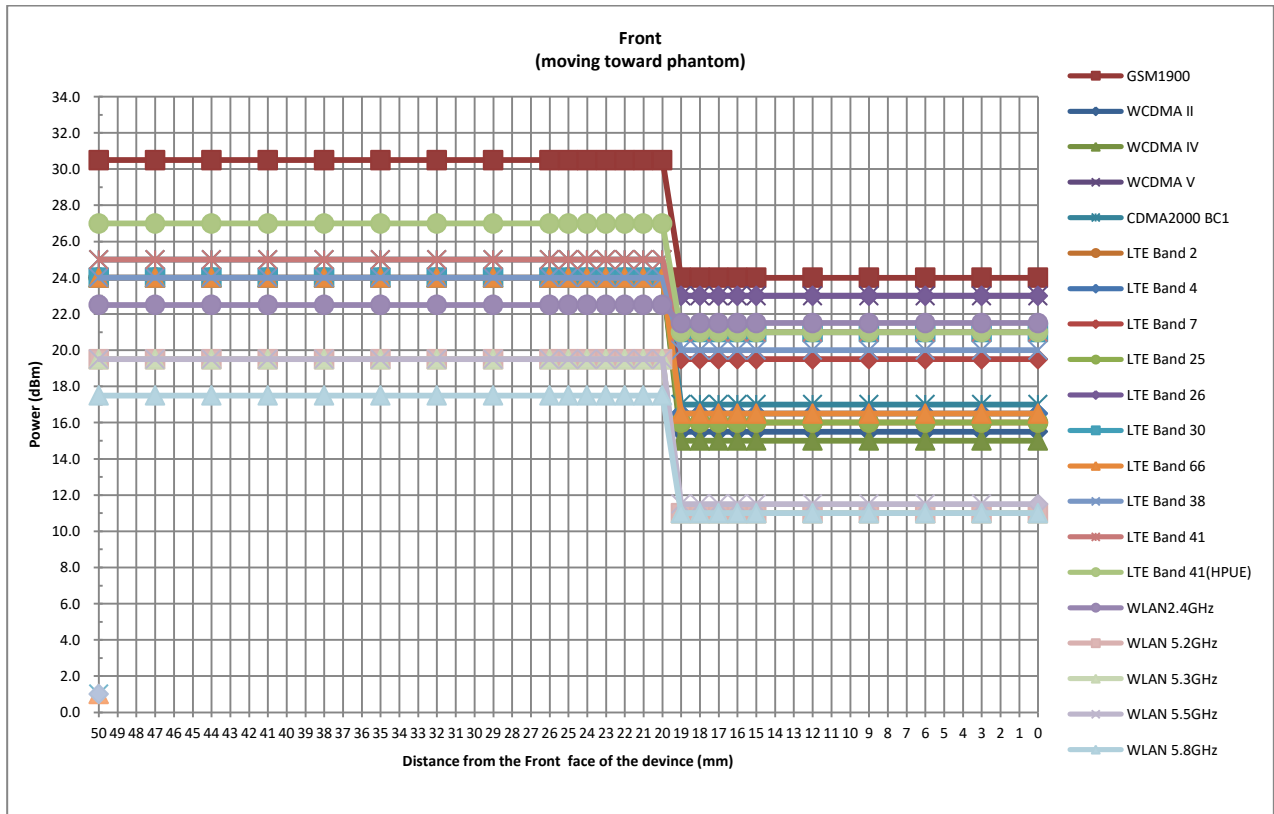

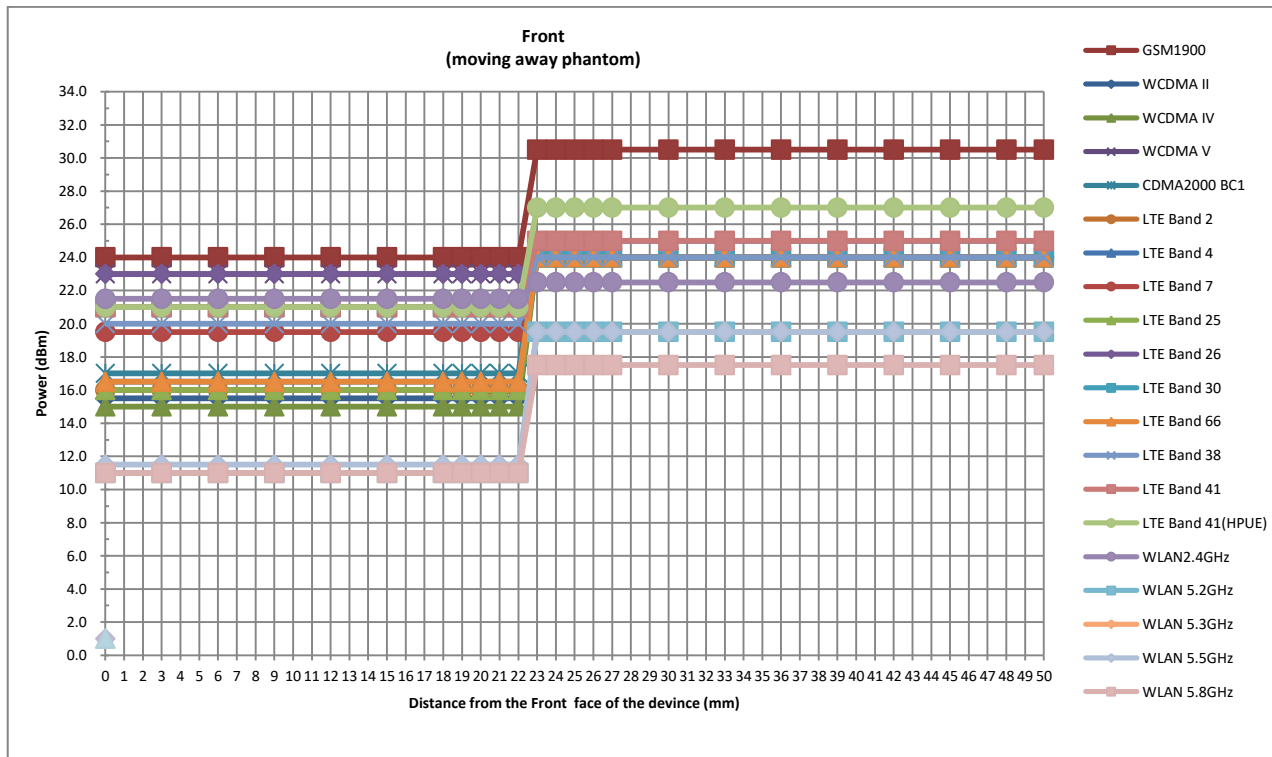

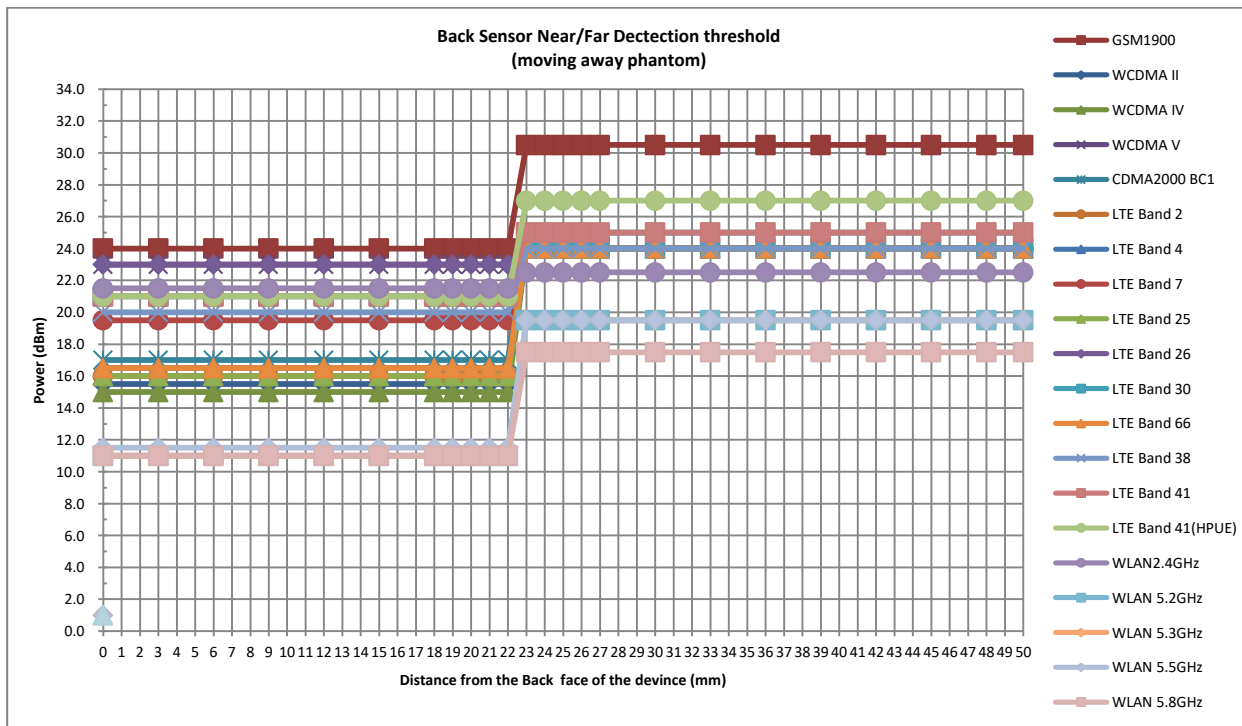
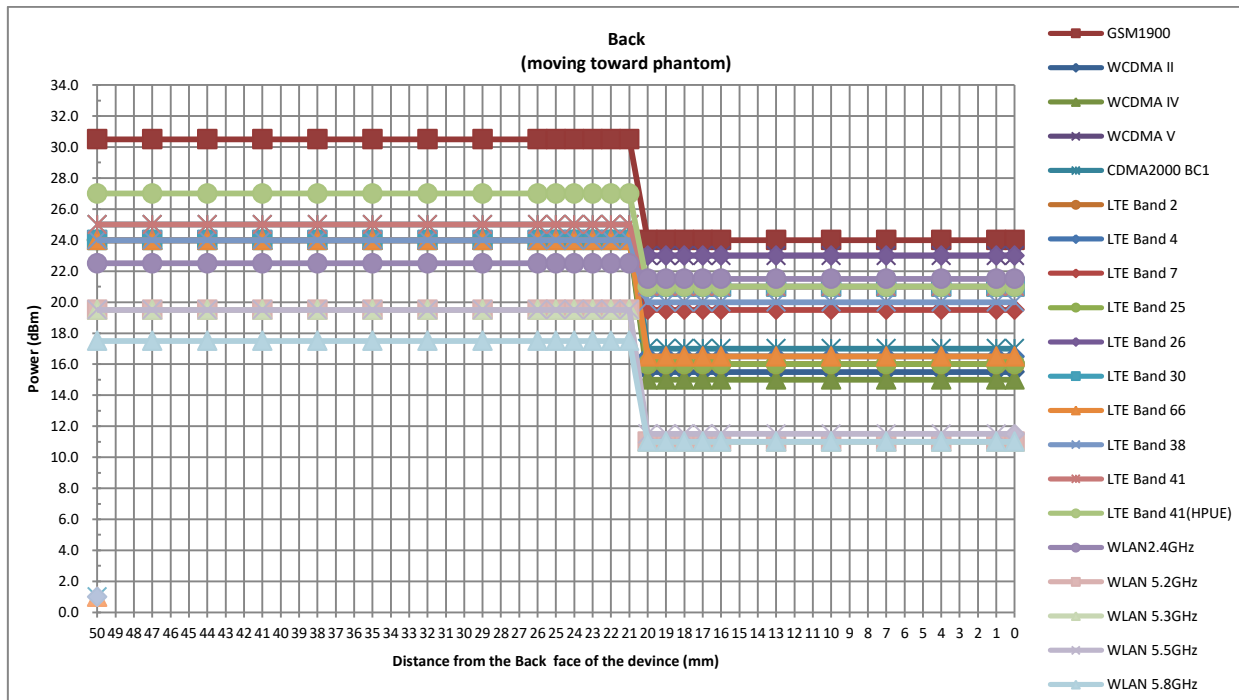

<Handheld for antenna 1>

Position	Front		Back		Bottom Side	
	Moving towards	Moving away	Moving towards	Moving away	Moving towards	Moving away
Minimum	16	16	18	18	19	19

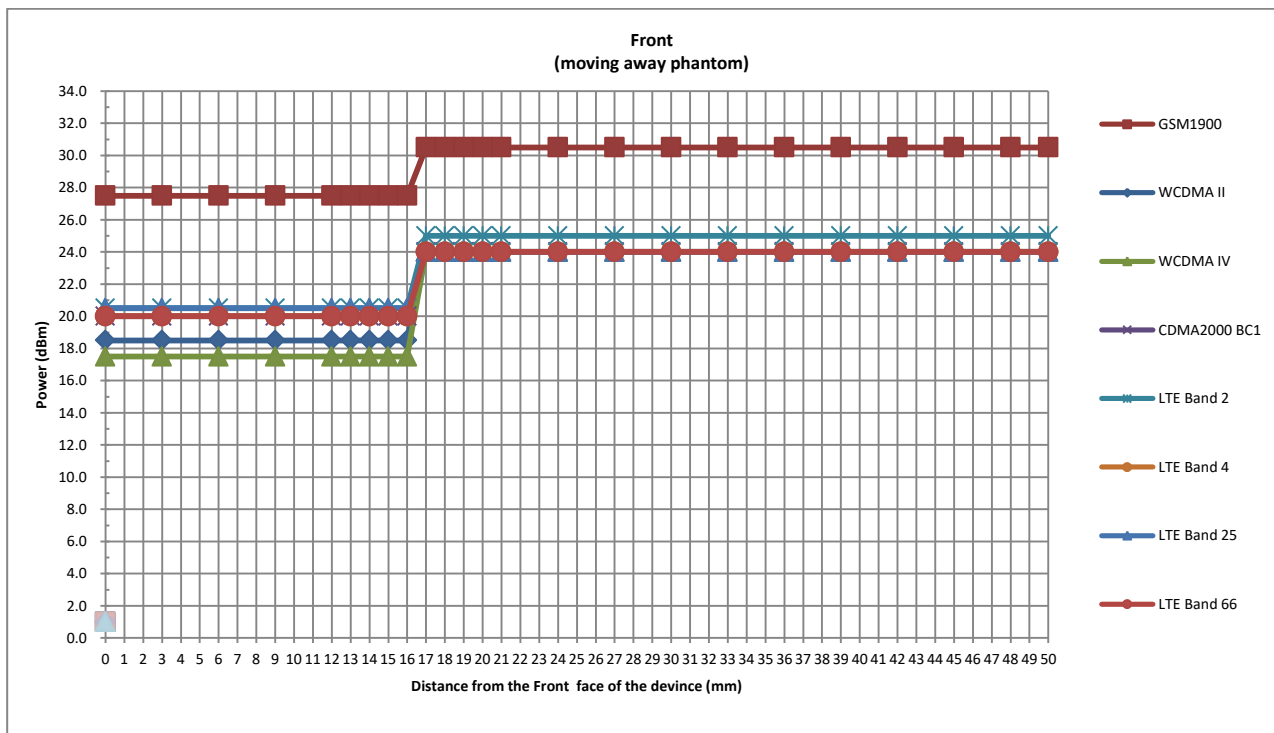
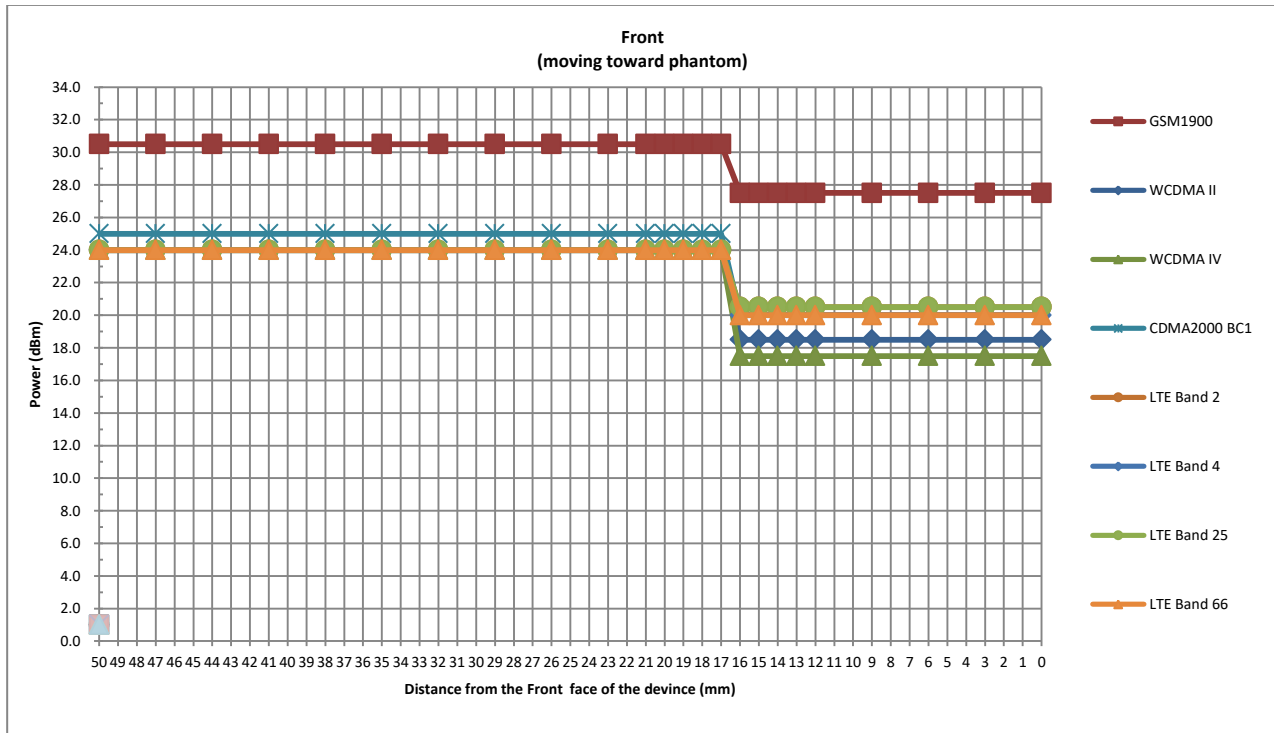



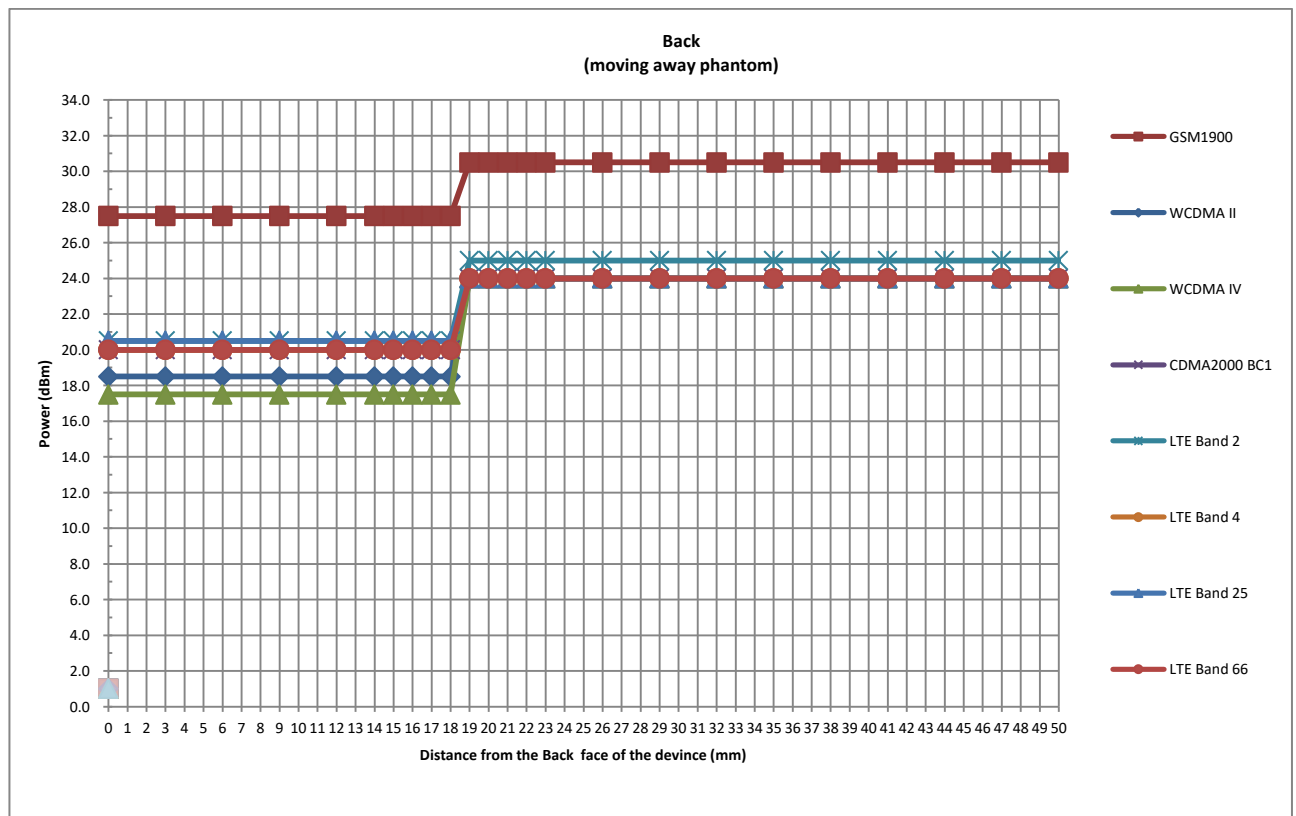
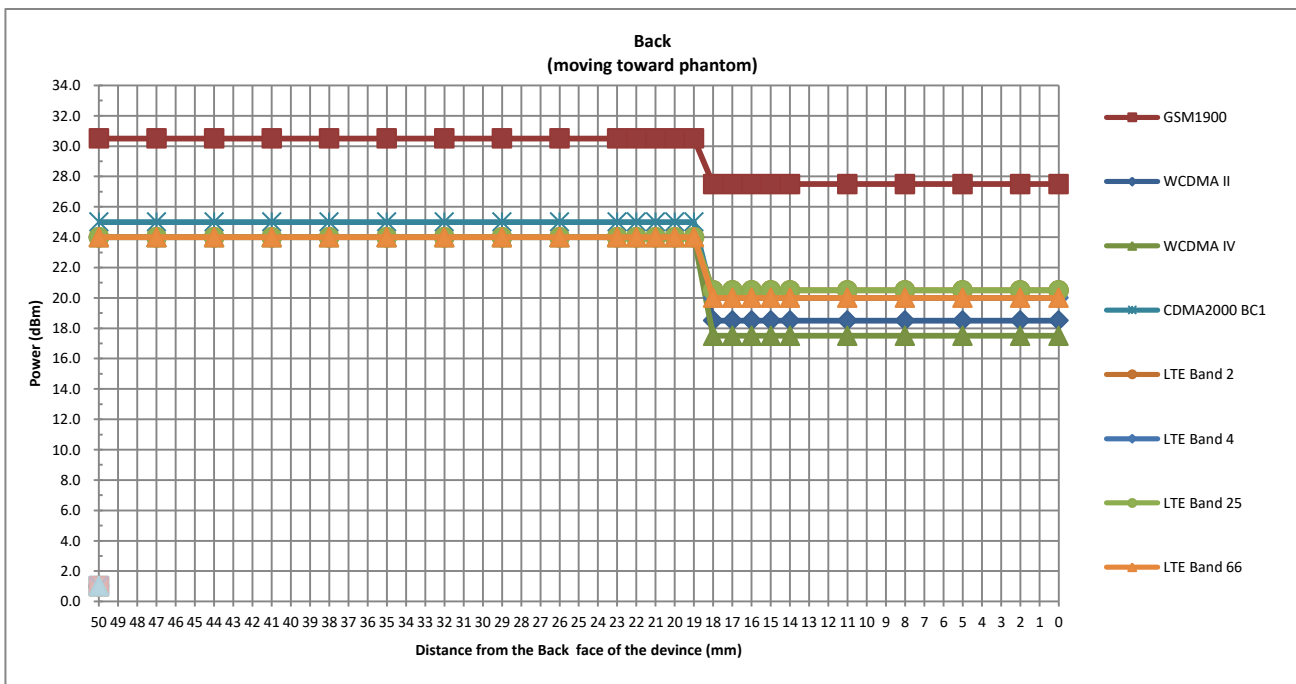

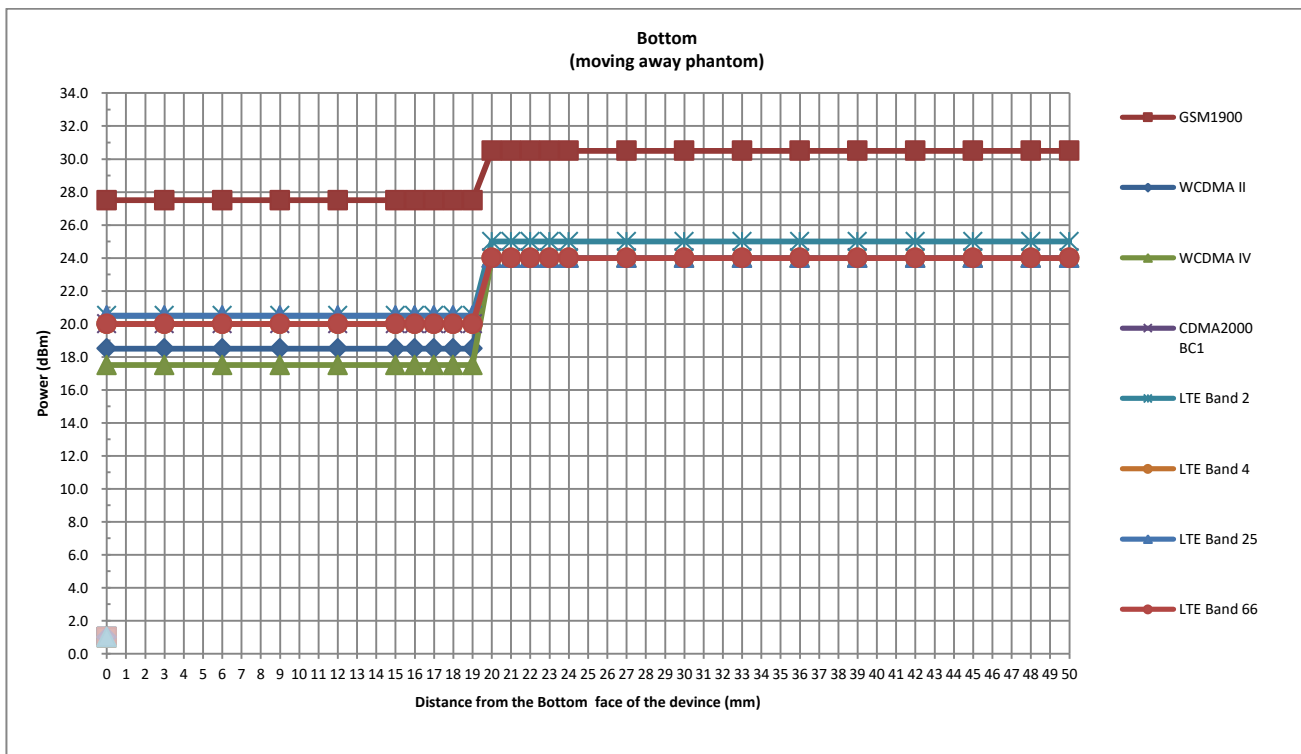
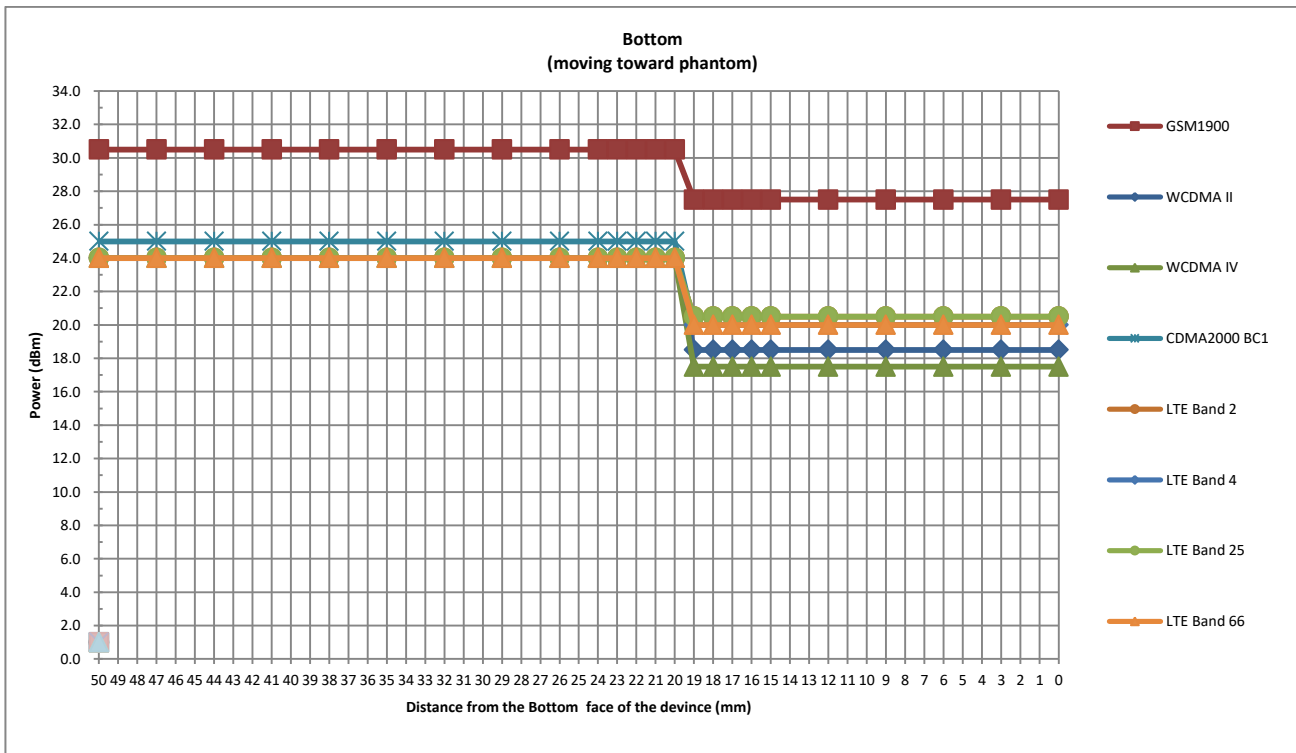



<Handheld for antenna 2>

Position	Front		Back		Bottom Side		Left Side	
	Moving towards	Moving away	Moving towards	Moving away	Moving towards	Moving away	Moving towards	Moving away
Minimum	8	11	8	12	9	10	9	14

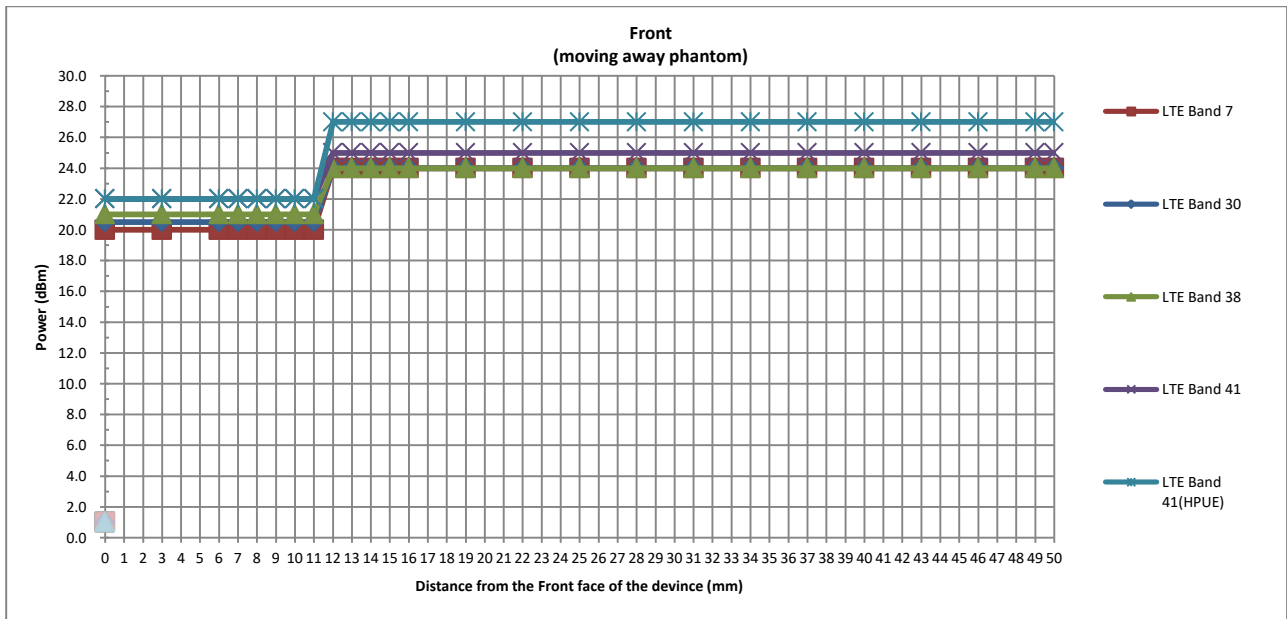
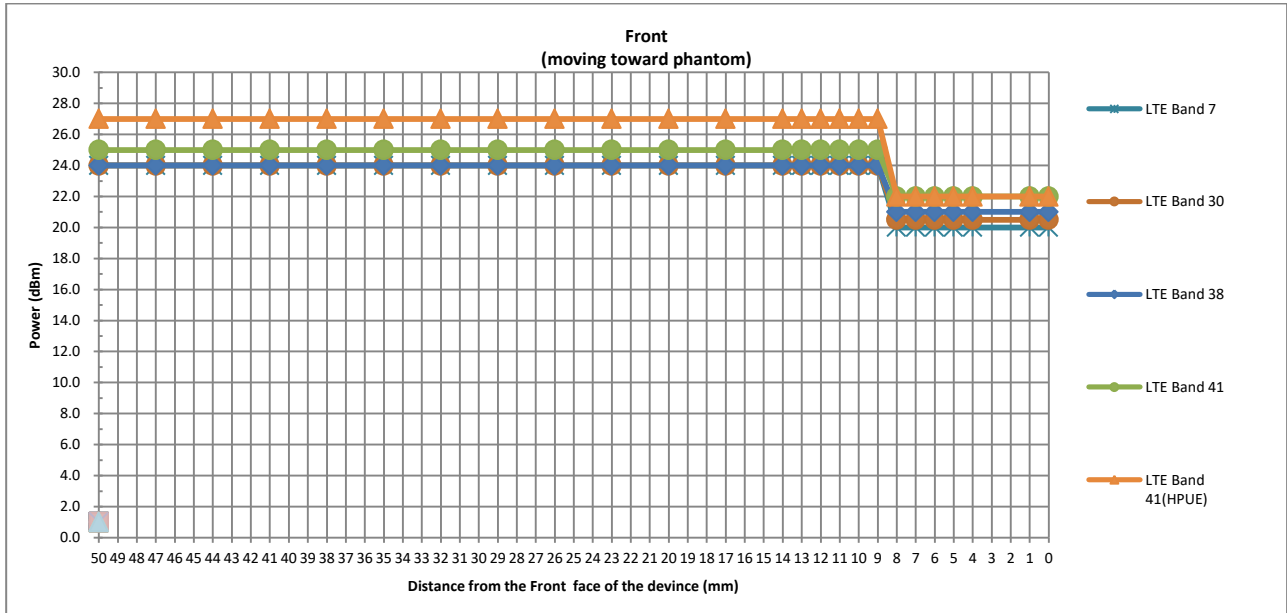

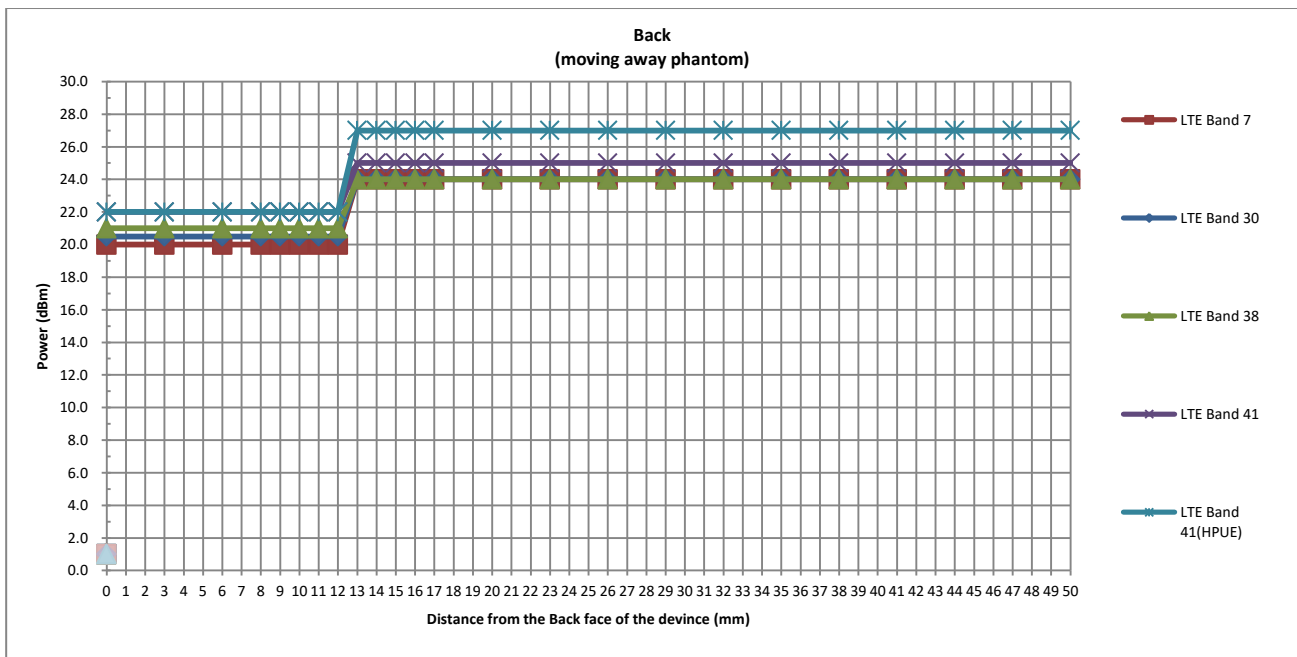
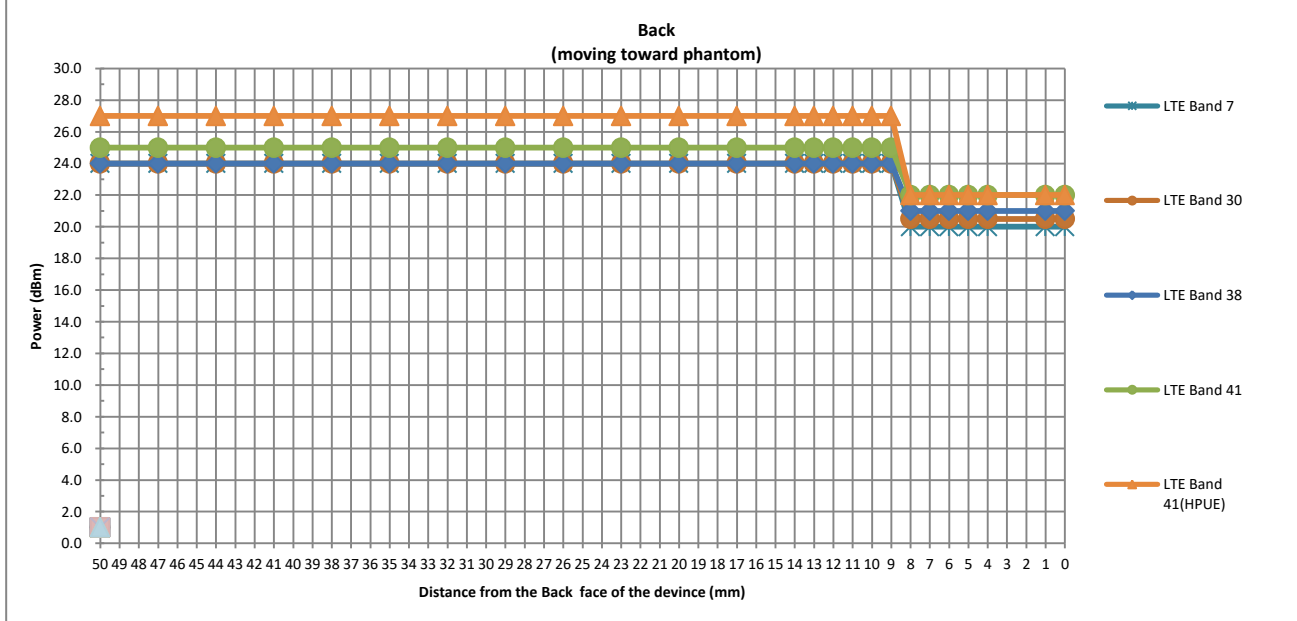

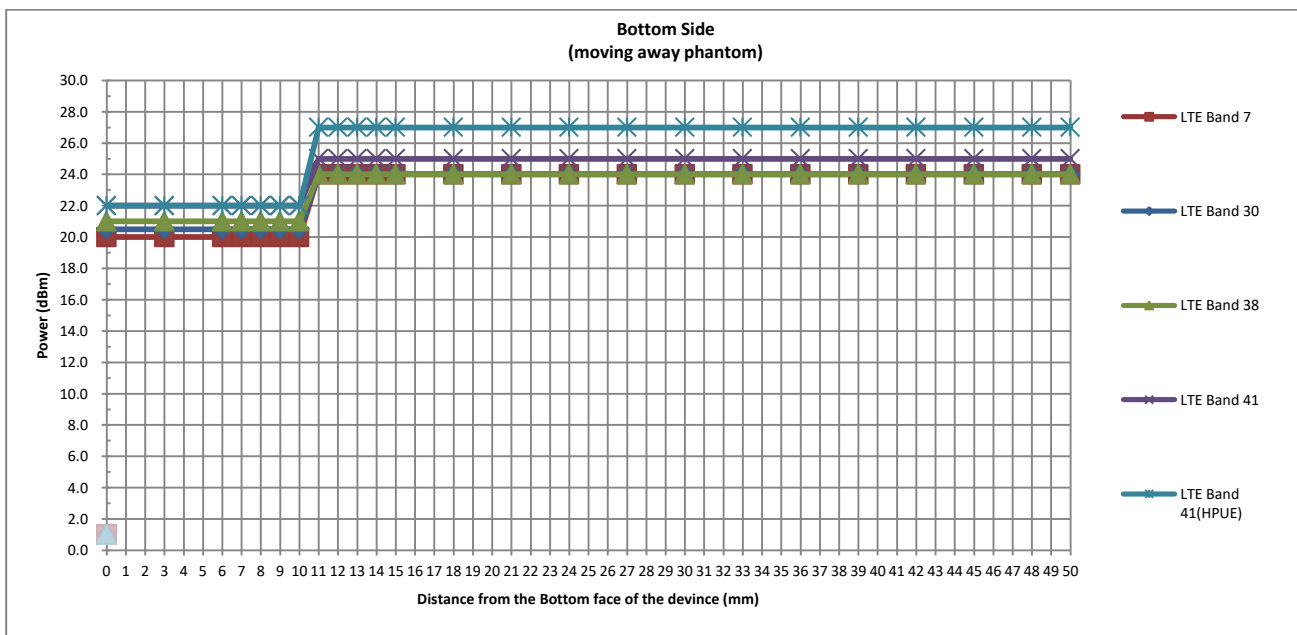
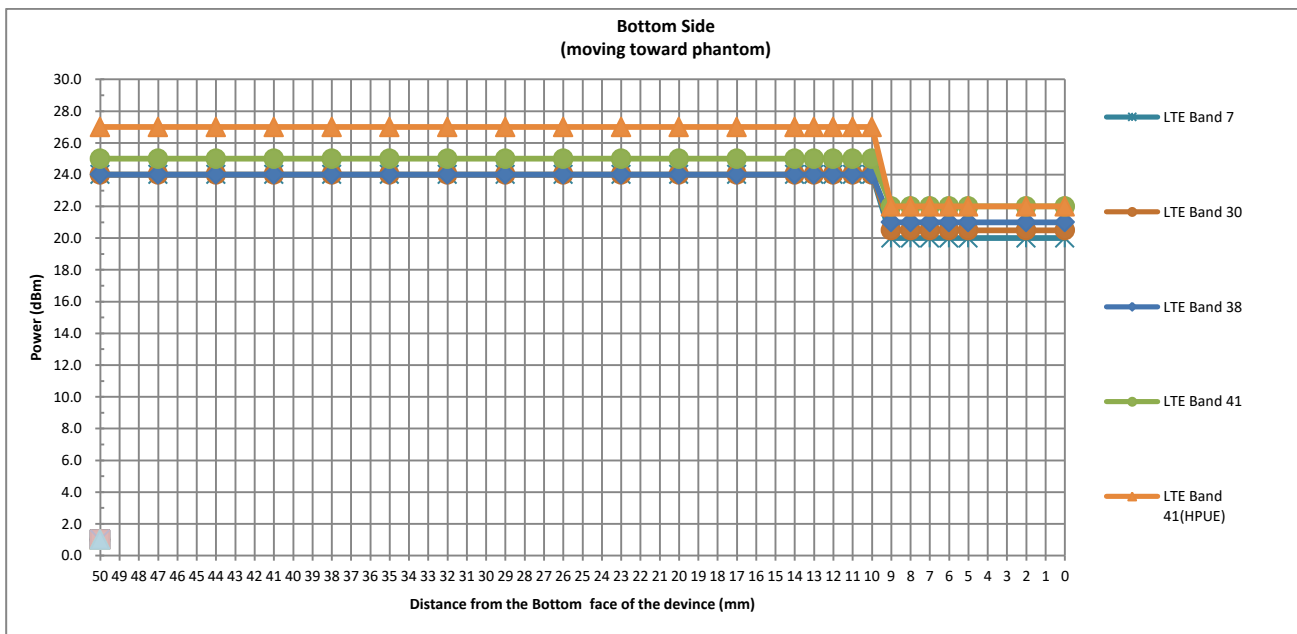

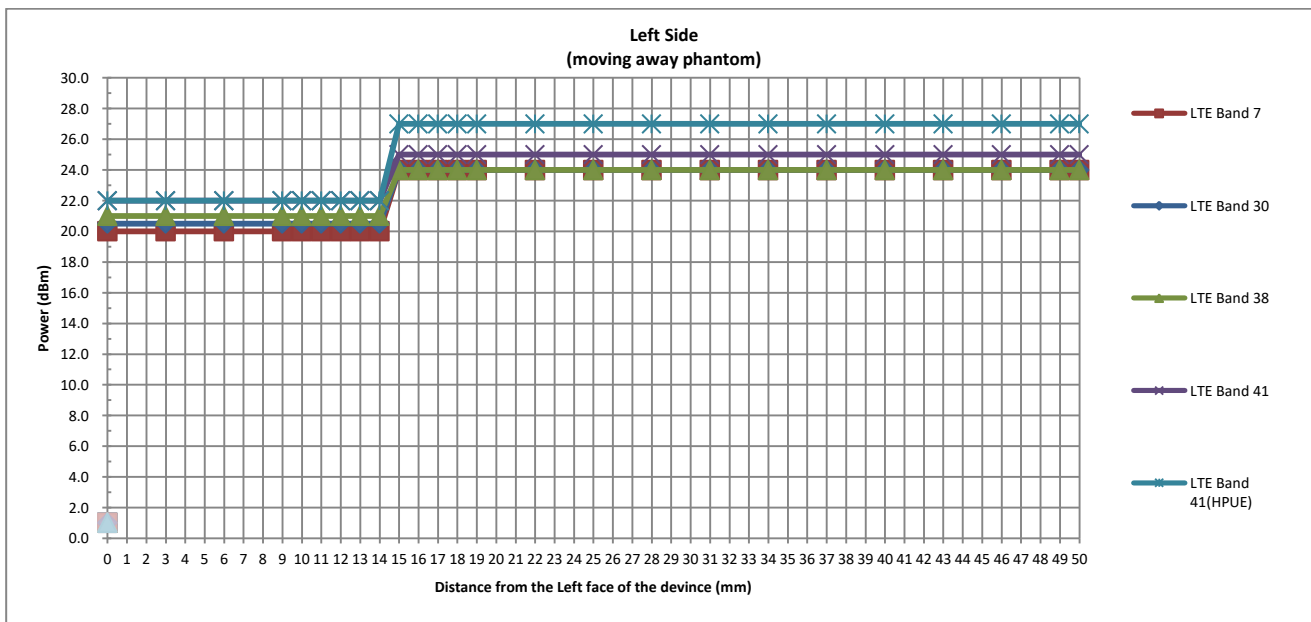
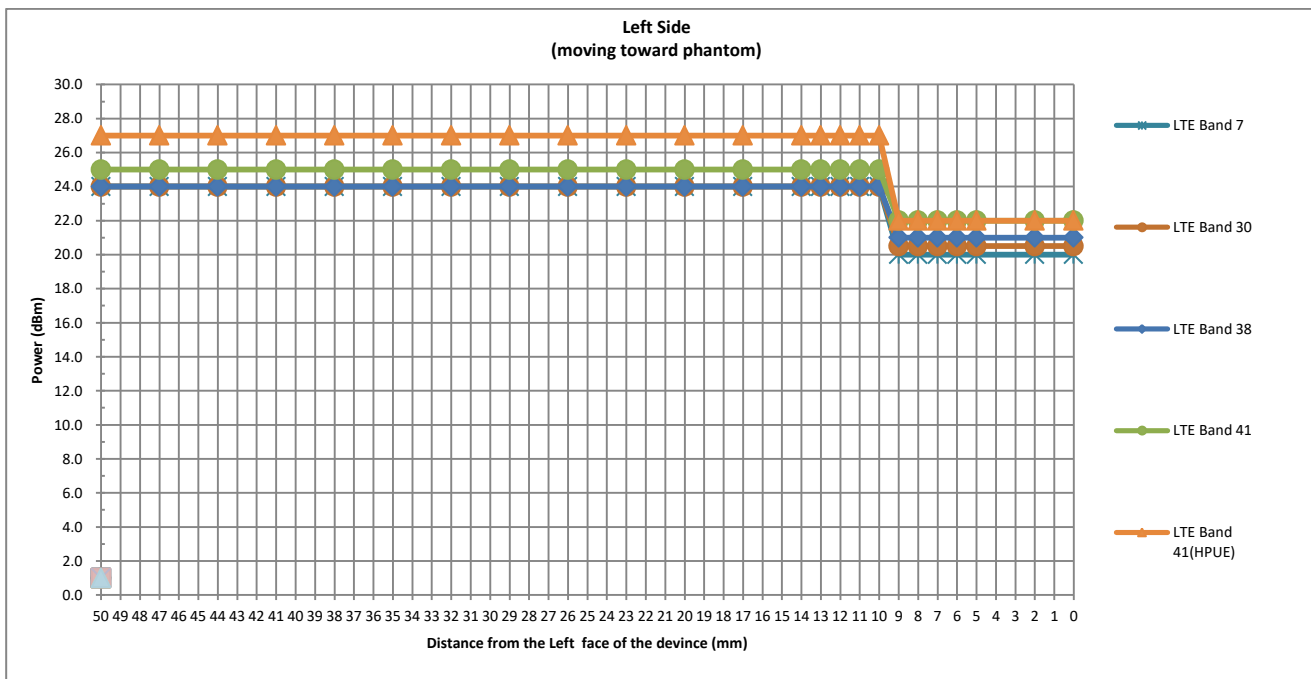



## 6. RF Exposure Limits

### 6.1 Uncontrolled Environment

Uncontrolled Environments are defined as locations where there is the exposure of individuals who have no knowledge or control of their exposure. The general population/uncontrolled exposure limits are applicable to situations in which the general public may be exposed or in which persons who are exposed as a consequence of their employment may not be made fully aware of the potential for exposure or cannot exercise control over their exposure. Members of the general public would come under this category when exposure is not employment-related; for example, in the case of a wireless transmitter that exposes persons in its vicinity.

### 6.2 Controlled Environment

Controlled Environments are defined as locations where there is exposure that may be incurred by persons who are aware of the potential for exposure, (i.e. as a result of employment or occupation). In general, occupational/controlled exposure limits are applicable to situations in which persons are exposed as a consequence of their employment, who have been made fully aware of the potential for exposure and can exercise control over their exposure. The exposure category is also applicable when the exposure is of a transient nature due to incidental passage through a location where the exposure levels may be higher than the general population/uncontrolled limits, but the exposed person is fully aware of the potential for exposure and can exercise control over his or her exposure by leaving the area or by some other appropriate means.

Limits for Occupational/Controlled Exposure (W/kg)

Whole-Body	Partial-Body	Hands, Wrists, Feet and Ankles
0.4	8.0	20.0

Limits for General Population/Uncontrolled Exposure (W/kg)

Whole-Body	Partial-Body	Hands, Wrists, Feet and Ankles
0.08	1.6	4.0

Whole-Body SAR is averaged over the entire body, partial-body SAR is averaged over any 1gram of tissue defined as a tissue volume in the shape of a cube. SAR for hands, wrists, feet and ankles is averaged over any 10 grams of tissue defined as a tissue volume in the shape of a cube.

## **7. Specific Absorption Rate (SAR)**

### **7.1 Introduction**

SAR is related to the rate at which energy is absorbed per unit mass in an object exposed to a radio field. The SAR distribution in a biological body is complicated and is usually carried out by experimental techniques or numerical modeling. The standard recommends limits for two tiers of groups, occupational/controlled and general population/uncontrolled, based on a person's awareness and ability to exercise control over his or her exposure. In general, occupational/controlled exposure limits are higher than the limits for general population/uncontrolled.

### **7.2 SAR Definition**

The SAR definition is the time derivative (rate) of the incremental energy (dW) absorbed by (dissipated in) an incremental mass (dm) contained in a volume element (dv) of a given density ( $\rho$ ). The equation description is as below:

$$\text{SAR} = \frac{d}{dt} \left( \frac{dW}{dm} \right) = \frac{d}{dt} \left( \frac{dW}{\rho dv} \right)$$

SAR is expressed in units of Watts per kilogram (W/kg)

$$\text{SAR} = \frac{\sigma |E|^2}{\rho}$$

Where:  $\sigma$  is the conductivity of the tissue,  $\rho$  is the mass density of the tissue and E is the RMS electrical field strength.



## **8. System Description and Setup**

The DASY system used for performing compliance tests consists of the following items:

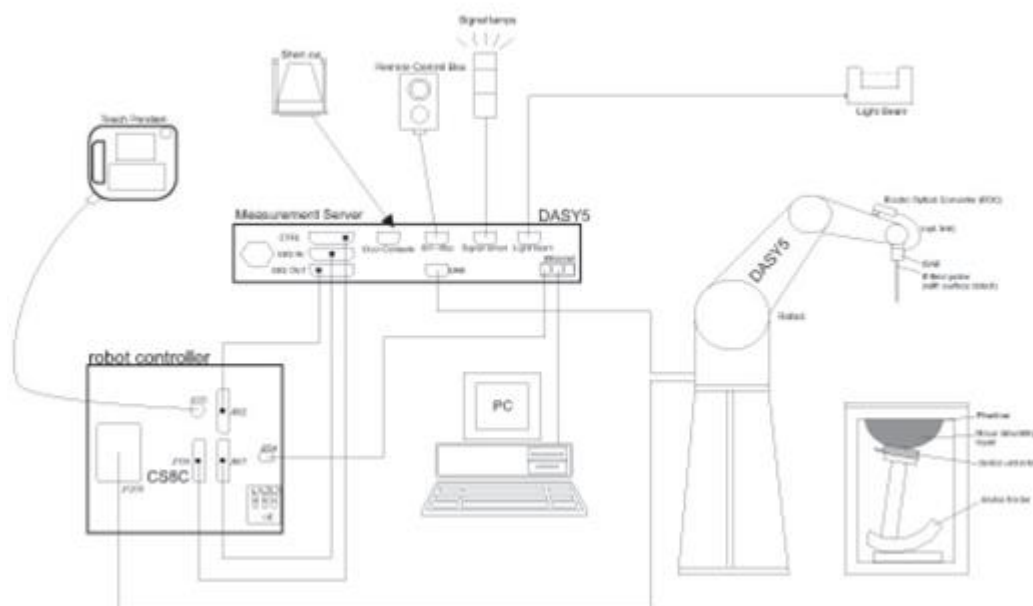

- A standard high precision 6-axis robot with controller, teach pendant and software. An arm extension for accommodating the data acquisition electronics (DAE).
- An isotropic Field probe optimized and calibrated for the targeted measurement.
- A data acquisition electronics (DAE) which performs the signal amplification, signal multiplexing, AD-conversion, offset measurements, mechanical surface detection, collision detection, etc. The unit is battery powered with standard or rechargeable batteries. The signal is optically transmitted to the EOC.
- The Electro-optical converter (EOC) performs the conversion from optical to electrical signals for the digital communication to the DAE. To use optical surface detection, a special version of the EOC is required. The EOC signal is transmitted to the measurement server.
- The function of the measurement server is to perform the time critical tasks such as signal filtering, control of the robot operation and fast movement interrupts.
- The Light Beam used is for probe alignment. This improves the (absolute) accuracy of the probe positioning.
- A computer running WinXP or Win7 and the DASY5 software.
- Remote control and teach pendant as well as additional circuitry for robot safety such as warning lamps, etc.
- The phantom, the device holder and other accessories according to the targeted measurement.

**8.1 E-Field Probe**

The SAR measurement is conducted with the dosimetric probe (manufactured by SPEAG).The probe is specially designed and calibrated for use in liquid with high permittivity. The dosimetric probe has special calibration in liquid at different frequency. This probe has a built in optical surface detection system to prevent from collision with phantom.

**<EX3DV4 Probe>**

<b>Construction</b>	Symmetric design with triangular core Built-in shielding against static charges PEEK enclosure material (resistant to organic solvents, e.g., DGBE)	
<b>Frequency</b>	10 MHz – >6 GHz Linearity: ±0.2 dB (30 MHz – 6 GHz)	
<b>Directivity</b>	±0.3 dB in TSL (rotation around probe axis) ±0.5 dB in TSL (rotation normal to probe axis)	
<b>Dynamic Range</b>	10 µW/g – >100 mW/g Linearity: ±0.2 dB (noise: typically <1 µW/g)	
<b>Dimensions</b>	Overall length: 337 mm (tip: 20 mm) Tip diameter: 2.5 mm (body: 12 mm) Typical distance from probe tip to dipole centers: 1 mm	

**8.2 Data Acquisition Electronics (DAE)**

The data acquisition electronics (DAE) consists of a highly sensitive electrometer-grade preamplifier with auto-zeroing, a channel and gain-switching multiplexer, a fast 16 bit AD-converter and a command decoder and control logic unit. Transmission to the measurement server is accomplished through an optical downlink for data and status information as well as an optical uplink for commands and the clock.

The input impedance of the DAE is 200 MOhm; the inputs are symmetrical and floating. Common mode rejection is above 80 dB.



**Photo of DAE**

**8.3 Phantom**

**<SAM Twin Phantom>**

<b>Shell Thickness</b>	2 ± 0.2 mm; Center ear point: 6 ± 0.2 mm	
<b>Filling Volume</b>	Approx. 25 liters	
<b>Dimensions</b>	Length: 1000 mm; Width: 500 mm; Height: adjustable feet	
<b>Measurement Areas</b>	Left Hand, Right Hand, Flat Phantom	

The bottom plate contains three pair of bolts for locking the device holder. The device holder positions are adjusted to the standard measurement positions in the three sections. A white cover is provided to tap the phantom during off-periods to prevent water evaporation and changes in the liquid parameters. On the phantom top, three reference markers are provided to identify the phantom position with respect to the robot.

**<ELI Phantom>**

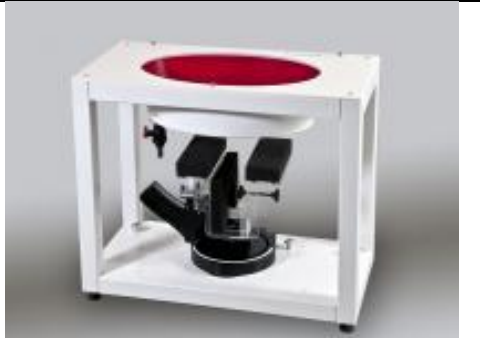
<b>Shell Thickness</b>	2 ± 0.2 mm (sagging: <1%)	
<b>Filling Volume</b>	Approx. 30 liters	
<b>Dimensions</b>	Major ellipse axis: 600 mm Minor axis: 400 mm	

The ELI phantom is intended for compliance testing of handheld and body-mounted wireless devices in the frequency range of 30 MHz to 6 GHz. ELI4 is fully compatible with standard and all known tissue simulating liquids.

## 8.4 Device Holder

### <Mounting Device for Hand-Held Transmitter>

In combination with the Twin SAM V5.0/V5.0c or ELI phantoms, the Mounting Device for Hand-Held Transmitters enables rotation of the mounted transmitter device to specified spherical coordinates. At the heads, the rotation axis is at the ear opening. Transmitter devices can be easily and accurately positioned according to IEC 62209-1, IEEE 1528, FCC, or other specifications. The device holder can be locked for positioning at different phantom sections (left head, right head, flat). And upgrade kit to Mounting Device to enable easy mounting of wider devices like big smart-phones, e-books, small tablets, etc. It holds devices with width up to 140 mm.



Mounting Device for Hand-Held Transmitters



Mounting Device Adaptor for Wide-Phones

### <Mounting Device for Laptops and other Body-Worn Transmitters>

The extension is lightweight and made of POM, acrylic glass and foam. It fits easily on the upper part of the mounting device in place of the phone positioned. The extension is fully compatible with the SAM Twin and ELI phantoms.



Mounting Device for Laptops



## **9. Measurement Procedures**

The measurement procedures are as follows:

### <Conducted power measurement>

- (a) For WWAN power measurement, use base station simulator to configure EUT WWAN transmission in conducted connection with RF cable, at maximum power in each supported wireless interface and frequency band.
- (b) Read the WWAN RF power level from the base station simulator.
- (c) For WLAN/BT power measurement, use engineering software to configure EUT WLAN/BT continuously transmission, at maximum RF power in each supported wireless interface and frequency band
- (d) Connect EUT RF port through RF cable to the power meter, and measure WLAN/BT output power

### <SAR measurement>

- (a) Use base station simulator to configure EUT WWAN transmission in radiated connection, and engineering software to configure EUT WLAN/BT continuously transmission, at maximum RF power, in the highest power channel.
- (b) Place the EUT in the positions as Appendix D demonstrates.
- (c) Set scan area, grid size and other setting on the DASY software.
- (d) Measure SAR results for the highest power channel on each testing position.
- (e) Find out the largest SAR result on these testing positions of each band
- (f) Measure SAR results for other channels in worst SAR testing position if the reported SAR of highest power channel is larger than 0.8 W/kg

According to the test standard, the recommended procedure for assessing the peak spatial-average SAR value consists of the following steps:

- (a) Power reference measurement
- (b) Area scan
- (c) Zoom scan
- (d) Power drift measurement

### **9.1 Spatial Peak SAR Evaluation**

The procedure for spatial peak SAR evaluation has been implemented according to the test standard. It can be conducted for 1g and 10g, as well as for user-specific masses. The DASY software includes all numerical procedures necessary to evaluate the spatial peak SAR value.

The base for the evaluation is a "cube" measurement. The measured volume must include the 1g and 10g cubes with the highest averaged SAR values. For that purpose, the center of the measured volume is aligned to the interpolated peak SAR value of a previously performed area scan.

The entire evaluation of the spatial peak values is performed within the post-processing engine (SEMCAD). The system always gives the maximum values for the 1g and 10g cubes. The algorithm to find the cube with highest averaged SAR is divided into the following stages:

- (a) Extraction of the measured data (grid and values) from the Zoom Scan
- (b) Calculation of the SAR value at every measurement point based on all stored data (A/D values and measurement parameters)
- (c) Generation of a high-resolution mesh within the measured volume
- (d) Interpolation of all measured values from the measurement grid to the high-resolution grid
- (e) Extrapolation of the entire 3-D field distribution to the phantom surface over the distance from sensor to surface
- (f) Calculation of the averaged SAR within masses of 1g and 10g

**9.2 Power Reference Measurement**

The Power Reference Measurement and Power Drift Measurements are for monitoring the power drift of the device under test in the batch process. The minimum distance of probe sensors to surface determines the closest measurement point to phantom surface. This distance cannot be smaller than the distance of sensor calibration points to probe tip as defined in the probe properties.

**9.3 Area Scan**

The area scan is used as a fast scan in two dimensions to find the area of high field values, before doing a fine measurement around the hot spot. The sophisticated interpolation routines implemented in DASY software can find the maximum found in the scanned area, within a range of the global maximum. The range (in dB0 is specified in the standards for compliance testing. For example, a 2 dB range is required in IEEE standard 1528 and IEC 62209 standards, whereby 3 dB is a requirement when compliance is assessed in accordance with the ARIB standard (Japan), if only one zoom scan follows the area scan, then only the absolute maximum will be taken as reference. For cases where multiple maximums are detected, the number of zoom scans has to be increased accordingly.

Area scan parameters extracted from FCC KDB 865664 D01v01r04 SAR measurement 100 MHz to 6 GHz.

	$\leq 3$ GHz	$> 3$ GHz
Maximum distance from closest measurement point (geometric center of probe sensors) to phantom surface	$5 \pm 1$ mm	$\frac{1}{2} \cdot \delta \cdot \ln(2) \pm 0.5$ mm
Maximum probe angle from probe axis to phantom surface normal at the measurement location	$30^\circ \pm 1^\circ$	$20^\circ \pm 1^\circ$
Maximum area scan spatial resolution: $\Delta x_{Area}, \Delta y_{Area}$	$\leq 2$ GHz: $\leq 15$ mm $2 - 3$ GHz: $\leq 12$ mm	$3 - 4$ GHz: $\leq 12$ mm $4 - 6$ GHz: $\leq 10$ mm
	When the x or y dimension of the test device, in the measurement plane orientation, is smaller than the above, the measurement resolution must be $\leq$ the corresponding x or y dimension of the test device with at least one measurement point on the test device.	

**9.4 Zoom Scan**

Zoom scans are used to assess the peak spatial SAR values within a cubic averaging volume containing 1 gram and 10 grams of simulated tissue. The zoom scan measures points (refer to table below) within a cube whose base faces are centered on the maxima found in a preceding area scan job within the same procedure. When the measurement is done, the zoom scan evaluates the averaged SAR for 1 gram and 10 grams and displays these values next to the job's label.

Zoom scan parameters extracted from FCC KDB 865664 D01v01r04 SAR measurement 100 MHz to 6 GHz.

		$\leq 3$ GHz	$> 3$ GHz
Maximum zoom scan spatial resolution: $\Delta x_{Zoom}$ , $\Delta y_{Zoom}$		$\leq 2$ GHz: $\leq 8$ mm 2 – 3 GHz: $\leq 5$ mm*	3 – 4 GHz: $\leq 5$ mm* 4 – 6 GHz: $\leq 4$ mm*
Maximum zoom scan spatial resolution, normal to phantom surface	uniform grid: $\Delta z_{Zoom}(n)$	$\leq 5$ mm	3 – 4 GHz: $\leq 4$ mm 4 – 5 GHz: $\leq 3$ mm 5 – 6 GHz: $\leq 2$ mm
	graded grid	$\Delta z_{Zoom}(1)$ : between 1 <sup>st</sup> two points closest to phantom surface	$\leq 4$ mm
		$\Delta z_{Zoom}(n>1)$ : between subsequent points	$\leq 1.5 \cdot \Delta z_{Zoom}(n-1)$
Minimum zoom scan volume	x, y, z	$\geq 30$ mm	3 – 4 GHz: $\geq 28$ mm 4 – 5 GHz: $\geq 25$ mm 5 – 6 GHz: $\geq 22$ mm
<p>Note: <math>\delta</math> is the penetration depth of a plane-wave at normal incidence to the tissue medium; see draft standard IEEE P1528-2011 for details.</p> <p>* When zoom scan is required and the <i>reported</i> SAR from the <i>area scan based 1-g SAR estimation</i> procedures of KDB 447498 is <math>\leq 1.4</math> W/kg, <math>\leq 8</math> mm, <math>\leq 7</math> mm and <math>\leq 5</math> mm zoom scan resolution may be applied, respectively, for 2 GHz to 3 GHz, 3 GHz to 4 GHz and 4 GHz to 6 GHz.</p>			

**9.5 Volume Scan Procedures**

The volume scan is used to assess overlapping SAR distributions for antennas transmitting in different frequency bands. It is equivalent to an oversized zoom scan used in standalone measurements. The measurement volume will be used to enclose all the simultaneous transmitting antennas. For antennas transmitting simultaneously in different frequency bands, the volume scan is measured separately in each frequency band. In order to sum correctly to compute the 1g aggregate SAR, the EUT remain in the same test position for all measurements and all volume scan use the same spatial resolution and grid spacing. When all volume scan were completed, the software, SEMCAD postprocessor can combine and subsequently superpose these measurement data to calculating the multiband SAR.

**9.6 Power Drift Monitoring**

All SAR testing is under the EUT install full charged battery and transmit maximum output power. In DASy measurement software, the power reference measurement and power drift measurement procedures are used for monitoring the power drift of EUT during SAR test. Both these procedures measure the field at a specified reference position before and after the SAR testing. The software will calculate the field difference in dB. If the power drifts more than 5%, the SAR will be retested.



**10. Test Equipment List**

Original:

Manufacturer	Name of Equipment	Type/Model	Serial Number	Calibration	
				Last Cal.	Due Date
SPEAG	750MHz System Validation Kit	D750V3	1099	Dec. 06, 2018	Dec. 05, 2021
SPEAG	835MHz System Validation Kit	D835V2	4d162	Dec. 05, 2018	Dec. 04, 2021
SPEAG	1750MHz System Validation Kit	D1750V2	1137	Jul. 30, 2018	Jul. 29, 2021
SPEAG	1900MHz System Validation Kit	D1900V2	5d182	Dec. 07, 2018	Dec. 06, 2021
SPEAG	2300MHz System Validation Kit	D2300V2	1056	Nov. 01, 2018	Oct. 31, 2021
SPEAG	2450MHz System Validation Kit	D2450V2	924	Apr. 15, 2019	Apr. 14, 2022
SPEAG	2600MHz System Validation Kit	D2600V2	1070	Dec. 07, 2018	Dec. 06, 2021
SPEAG	5000MHz System Validation Kit	D5GHzV2	1167	Aug. 03, 2018	Aug. 02, 2021
SPEAG	Data Acquisition Electronics	DAE4	1210	Jul. 27, 2020	Jul. 26, 2021
SPEAG	Data Acquisition Electronics	DAE3	528	Mar. 16, 2020	Mar. 15, 2021
SPEAG	Data Acquisition Electronics	DAE4	1226	May 15, 2020	May 14, 2021
SPEAG	Dosimetric E-Field Probe	EX3DV4	3819	Apr. 30, 2020	Apr. 29, 2021
SPEAG	Dosimetric E-Field Probe	EX3DV4	7576	Jan. 22, 2020	Jan. 21, 2021
SPEAG	Dosimetric E-Field Probe	EX3DV4	3826	May 20, 2020	May 19, 2021
SPEAG	SAM Twin Phantom	QD 000 P40 CD	TP-1671	NCR	NCR
SPEAG	SAM Twin Phantom	SAM V5.0	1795	NCR	NCR
SPEAG	SAM Twin Phantom	QD000P40CC	TP-1500	NCR	NCR
SPEAG	Phone Positioner	N/A	N/A	NCR	NCR
Anritsu	Radio communication analyzer	MT8820C	6201300653	Jul. 21, 2020	Jul. 20, 2021
Anritsu	Radio communication analyzer	MT8821C	6201588572	Dec. 26, 2019	Dec. 25, 2020
Agilent	Wireless Communication Test Set	E5515C	MY50267224	Jul. 21, 2020	Jul. 20, 2021
Agilent	Network Analyzer	E5071C	MY46523671	Oct. 17, 2019	Oct. 16, 2020
Agilent	Network Analyzer	E5071C	MY46523671	Oct. 15, 2020	Oct. 14, 2021
Speag	Dielectric Assessment KIT	DAK-3.5	1071	Oct. 28, 2019	Oct. 27, 2020
Agilent	Signal Generator	N5181A	MY50145381	Dec. 26, 2019	Dec. 25, 2020
Anritsu	Power Sensor	MA2411B	1306099	Jul. 21, 2020	Jul. 20, 2021
Anritsu	Power Meter	ML2495A	1349001	Jul. 21, 2020	Jul. 20, 2021
Anritsu	Power Sensor	MA2411B	1207253	Dec. 26, 2019	Dec. 25, 2020
Anritsu	Power Meter	ML2495A	1218010	Jul. 21, 2020	Jul. 20, 2021
R&S	CBT BLUETOOTH TESTER	CBT	100963	Dec. 26, 2019	Dec. 25, 2020
R&S	Spectrum Analyzer	FSP7	100818	Jul. 21, 2020	Jul. 20, 2021
LKM electronic	Hygrometer	1310	200505600	Jul. 30, 2020	Jul. 29, 2021
Anymetre	Thermo-Hygrometer	JR593	2015030904	Jul. 28, 2020	Jul. 27, 2021
AR	Amplifier	5S1G4	0333096	Note 1	
mini-circuits	Amplifier	ZVE-3W-83+	599201528	Note 1	
ARRA	Power Divider	A3200-2	N/A	Note 1	
PASTERNAK	Dual Directional Coupler	PE2214-10	N/A	Note 1	
Agilent	Dual Directional Coupler	778D	50422	Note 1	
MCL	Attenuator 1	BW-S10W5	N/A	Note 1	
Weinschel	Attenuator 2	3M-20	N/A	Note 1	
Zhongjilianhe	Attenuator 3	MVE2214-03	N/A	Note 1	





**Verify:**

Manufacturer	Name of Equipment	Type/Model	Serial Number	Calibration	
				Last Cal.	Due Date
SPEAG	1750MHz System Validation Kit	D1750V2	1090	Mar. 27, 2019	Mar. 26, 2022
SPEAG	1900MHz System Validation Kit	D1900V2	5d170	Mar. 26, 2019	Mar. 25, 2022
SPEAG	5000MHz System Validation Kit	D5GHzV2	1113	Sep. 24, 2019	Sep. 23, 2022
SPEAG	Data Acquisition Electronics	DAE4	690	Mar. 26, 2020	Mar. 25, 2021
SPEAG	Dosimetric E-Field Probe	EX3DV4	7592	May 22, 2020	May 21, 2021
SPEAG	SAM Twin Phantom	QD 000 P40 CB	TP-1697	NCR	NCR
SPEAG	Phone Positioner	N/A	N/A	NCR	NCR
Anritsu	Radio Communication Analyzer	MT8821C	6201432831	Apr. 14, 2020	Apr. 13, 2021
Agilent	Wireless Communication Test Set	E5515C	MY52102706	May 19, 2020	May 18, 2021
Agilent	ENA Series Network Analyzer	E5071C	MY46106933	Aug. 01, 2020	Jul. 31, 2021
SPEAG	Dielectric Probe Kit	DAK-3.5	1138	May 19, 2020	May 18, 2021
Anritsu	Vector Signal Generator	MG3710A	6201682672	Jan. 08, 2021	Jan. 07, 2022
Rohde & Schwarz	Power Meter	NRVD	102081	Aug. 13, 2020	Aug. 12, 2021
Rohde & Schwarz	Power Sensor	NRV-Z5	100538	Aug. 13, 2020	Aug. 12, 2021
Rohde & Schwarz	Power Sensor	NRV-Z5	100539	Aug. 13, 2020	Aug. 12, 2021
EXA	Spectrum Analyzer	FSV7	101631	Jan. 08, 2021	Jan. 07, 2022
Testo	Hygrometer	608-H1	1241332088	Jan. 08, 2021	Jan. 07, 2022
FLUKE	DIGITAC THERMOMETER	51II	97240029	Aug. 14, 2020	Aug. 13, 2021
ARRA	Power Divider	A3200-2	N/A	Note 1	
MCL	Attenuation1	BW-S10W5+	N/A	Note 1	
MCL	Attenuation2	BW-S10W5+	N/A	Note 1	
MCL	Attenuation3	BW-S10W5+	N/A	Note 1	
Agilent	Dual Directional Coupler	778D	20500	Note 1	
Agilent	Dual Directional Coupler	11691D	MY48151020	Note 1	
BONN	POWER AMPLIFIER	BLMA 0830-3	087193A	Note 1	
BONN	POWER AMPLIFIER	BLMA 2060-2	087193B	Note 1	

**Note:**

1. Prior to system verification and validation, the path loss from the signal generator to the system check source and the power meter, which includes the amplifier, cable, attenuator and directional coupler, was measured by the network analyzer. The reading of the power meter was offset by the path loss difference between the path to the power meter and the path to the system check source to monitor the actual power level fed to the system check
2. Referring to KDB 865664 D01v01r04, the dipole calibration interval can be extended to 3 years with justification. The dipoles are also not physically damaged, or repaired during the interval.
3. The justification data of dipole can be found in appendix C. The return loss is < -20dB, within 20% of prior calibration, the impedance is within 5 ohm of prior calibration.

## 11. System Verification

### 11.1 Tissue Simulating Liquids

For the measurement of the field distribution inside the SAM phantom with DASy, the phantom must be filled with around 25 liters of homogeneous body tissue simulating liquid. For head SAR testing, the liquid height from the ear reference point (ERP) of the phantom to the liquid top surface is larger than 15 cm, which is shown in Fig. 11.1. For body SAR testing, the liquid height from the center of the flat phantom to the liquid top surface is larger than 15 cm, which is shown in Fig. 11.2.

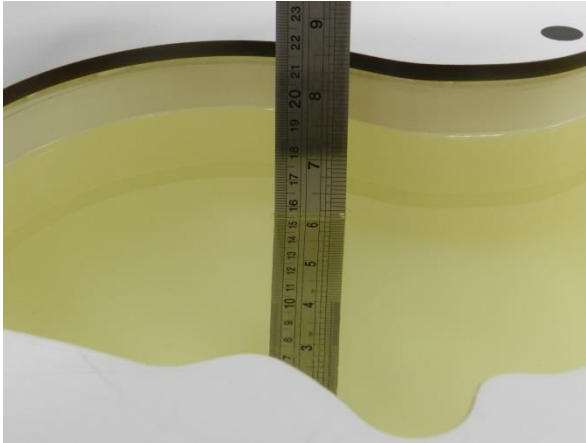

Fig 11.1 Photo of Liquid Height for Head SAR

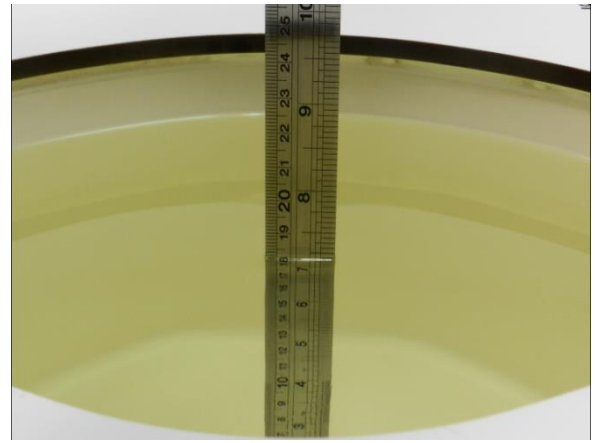

Fig 11.2 Photo of Liquid Height for Body SAR



**11.2 Tissue Verification**

The following tissue formulations are provided for reference only as some of the parameters have not been thoroughly verified. The composition of ingredients may be modified accordingly to achieve the desired target tissue parameters required for routine SAR evaluation.

Frequency (MHz)	Water (%)	Sugar (%)	Cellulose (%)	Salt (%)	Preventol (%)	DGBE (%)	Conductivity (σ)	Permittivity (ε <sub>r</sub> )
For Head								
750	41.1	57.0	0.2	1.4	0.2	0	0.89	41.9
835	40.3	57.9	0.2	1.4	0.2	0	0.90	41.5
1800, 1900, 2000	55.2	0	0	0.3	0	44.5	1.40	40.0
2450	55.0	0	0	0	0	45.0	1.80	39.2
2600	54.8	0	0	0.1	0	45.1	1.96	39.0

**Simulating Liquid for 5GHz, Manufactured by SPEAG**

Ingredients	(% by weight)
Water	64~78%
Mineral oil	11~18%
Emulsifiers	9~15%
Additives and Salt	2~3%

**<Tissue Dielectric Parameter Check Results>**

**Original:**

Frequency (MHz)	Tissue Type	Liquid Temp. (°C)	Conductivity (σ)	Permittivity (ε <sub>r</sub> )	Conductivity Target (σ)	Permittivity Target (ε <sub>r</sub> )	Delta (σ) (%)	Delta (ε <sub>r</sub> ) (%)	Limit (%)	Date
750	Head	22.4	0.886	41.532	0.89	41.90	-0.45	-0.88	±5	2020/8/28
750	Head	22.4	0.878	40.673	0.89	41.90	-1.35	-2.93	±5	2020/9/15
835	Head	22.5	0.913	40.859	0.90	41.50	1.44	-1.54	±5	2020/8/27
835	Head	22.5	0.914	41.826	0.90	41.50	1.56	0.79	±5	2020/9/17
1750	Head	22.4	1.373	41.392	1.37	40.10	0.22	3.22	±5	2020/9/1
1750	Head	22.4	1.406	41.525	1.37	40.10	2.63	3.55	±5	2020/9/18
1900	Head	22.6	1.455	40.068	1.40	40.00	3.93	0.17	±5	2020/8/31
1900	Head	22.6	1.439	40.038	1.40	40.00	2.79	0.09	±5	2020/9/21
2300	Head	22.5	1.664	38.851	1.67	39.50	-0.36	-1.64	±5	2020/9/4
2450	Head	22.4	1.820	39.753	1.80	39.20	1.11	1.41	±5	2020/9/14
2600	Head	22.8	2.050	38.344	1.96	39.00	4.59	-1.68	±5	2020/9/3
2600	Head	22.4	2.056	37.284	1.96	39.00	4.90	-4.40	±5	2020/9/19
5250	Head	22.5	4.597	36.241	4.71	35.95	-2.40	0.81	±5	2020/9/8
5250	Head	22.4	4.757	36.931	4.71	35.95	1.00	2.73	±5	2020/9/22
5250	Head	22.4	4.588	36.661	4.71	35.95	-2.59	1.98	±5	2020/9/25
5600	Head	22.6	4.954	35.793	5.07	35.50	-2.29	0.83	±5	2020/9/10
5600	Head	22.5	5.199	36.179	5.07	35.50	2.54	1.91	±5	2020/9/23
5600	Head	22.5	4.996	36.130	5.07	35.50	-1.46	1.77	±5	2020/9/26
5750	Head	22.7	5.119	35.497	5.22	35.35	-1.93	0.42	±5	2020/9/13
5750	Head	22.7	5.374	35.896	5.22	35.35	2.95	1.54	±5	2020/9/24
5750	Head	22.4	5.164	35.867	5.22	35.35	-1.07	1.46	±5	2020/9/27
5750	Head	22.5	5.119	35.497	5.22	35.35	-1.93	0.42	±5	2020/10/19



Verify:

Frequency (MHz)	Tissue Type	Liquid Temp. (°C)	Conductivity ( $\sigma$ )	Permittivity ( $\epsilon_r$ )	Conductivity Target ( $\sigma$ )	Permittivity Target ( $\epsilon_r$ )	Delta ( $\sigma$ ) (%)	Delta ( $\epsilon_r$ ) (%)	Limit (%)	Date
1750	Head	22.7	1.351	40.380	1.370	40.100	-1.39	0.70	±5	2021/3/2
1900	Head	22.9	1.464	40.080	1.400	40.000	4.57	0.20	±5	2021/3/3
5250	Head	22.6	4.604	36.049	4.710	35.900	-2.25	0.42	±5	2021/3/4

**11.3 System Performance Check Results**

Comparing to the original SAR value provided by SPEAG, the verification data should be within its specification of 10 %. Below table shows the target SAR and measured SAR after normalized to 1W input power. The table below indicates the system performance check can meet the variation criterion and the plots can be referred to Appendix A of this report.

**<1g SAR>**

Date	Frequency (MHz)	Tissue Type	Input Power (mW)	Dipole S/N	Probe S/N	DAE S/N	Measured 1g SAR (W/kg)	Targeted 1g SAR (W/kg)	Normalized 1g SAR (W/kg)	Deviation (%)
2020/8/28	750	Head	250	1099	3826	1210	2.21	8.52	8.84	3.76
2020/9/15	750	Head	250	1099	7576	528	2.10	8.52	8.4	-1.41
2020/8/27	835	Head	250	4d162	3826	1210	2.63	9.61	10.52	9.47
2020/9/17	835	Head	250	4d162	7576	528	2.47	9.61	9.88	2.81
2020/9/1	1750	Head	250	1137	3826	1210	9.39	36.50	37.56	2.90
2020/9/18	1750	Head	250	1137	7576	528	9.52	36.50	38.08	4.33
2020/8/31	1900	Head	250	5d182	3826	1210	10.50	39.60	42	6.06
2020/9/21	1900	Head	250	5d182	7576	528	10.20	39.60	40.8	3.03
2020/9/4	2300	Head	250	1056	3826	1210	11.80	49.90	47.2	-5.41
2020/9/14	2450	Head	250	924	3826	1210	13.20	52.10	52.8	1.34
2020/9/3	2600	Head	250	1070	3826	1210	14.20	58.10	56.8	-2.24
2020/9/19	2600	Head	250	1070	7576	528	15.40	58.10	61.6	6.02
2020/9/8	5250	Head	100	1167	3826	1210	7.42	77.00	74.2	-3.64
2020/9/22	5250	Head	100	1167	7576	528	7.50	77.00	75	-2.60
2020/9/25	5250	Head	100	1167	3819	1226	7.49	77.00	74.9	-2.73
2020/9/10	5600	Head	100	1167	3826	1210	7.96	80.80	79.6	-1.49
2020/9/23	5600	Head	100	1167	7576	528	7.70	80.80	77	-4.70
2020/9/26	5600	Head	100	1167	3819	1226	8.17	80.80	81.7	1.11
2020/9/13	5750	Head	100	1167	3826	1210	7.39	76.90	73.9	-3.90
2020/9/24	5750	Head	100	1167	7576	528	8.00	76.90	80	4.03
2020/9/27	5750	Head	100	1167	3819	1226	7.62	76.90	76.2	-0.91
2020/10/19	5750	Head	100	1167	3826	1210	7.37	76.90	73.7	-4.16

<10g SAR>

Original:

Date	Frequency (MHz)	Tissue Type	Input Power (mW)	Dipole S/N	Probe S/N	DAE S/N	Measured 10g SAR (W/kg)	Targeted 10g SAR (W/kg)	Normalized 10g SAR (W/kg)	Deviation (%)
2020/8/28	750	Head	250	1099	3826	1210	1.48	5.64	5.92	4.96
2020/9/15	750	Head	250	1099	7576	528	1.41	5.64	5.64	0.00
2020/8/27	835	Head	250	4d162	3826	1210	1.73	6.35	6.92	8.98
2020/9/17	835	Head	250	4d162	7576	528	1.63	6.35	6.52	2.68
2020/9/1	1750	Head	250	1137	3826	1210	4.99	19.50	19.96	2.36
2020/9/18	1750	Head	250	1137	7576	528	5.10	19.50	20.4	4.62
2020/8/31	1900	Head	250	5d182	3826	1210	5.34	20.70	21.36	3.19
2020/9/21	1900	Head	250	5d182	7576	528	5.26	20.70	21.04	1.64
2020/9/4	2300	Head	250	1056	3826	1210	5.52	23.80	22.08	-7.23
2020/9/14	2450	Head	250	924	3826	1210	5.84	23.90	23.36	-2.26
2020/9/3	2600	Head	250	1070	3826	1210	6.01	26.10	24	-8.05
2020/9/19	2600	Head	250	1070	7576	528	6.70	26.10	26.8	2.68
2020/9/8	5250	Head	100	1167	3826	1210	2.04	22.00	20.4	-7.27
2020/9/22	5250	Head	100	1167	7576	528	2.30	22.00	23	4.55
2020/9/25	5250	Head	100	1167	3819	1226	2.16	22.00	21.6	-1.82
2020/9/10	5600	Head	100	1167	3826	1210	2.16	23.20	21.6	-6.90
2020/9/23	5600	Head	100	1167	7576	528	2.40	23.20	24	3.45
2020/9/26	5600	Head	100	1167	3819	1226	2.35	23.20	23.5	1.29
2020/9/13	5750	Head	100	1167	3826	1210	2.03	21.60	20.3	-6.02
2020/9/24	5750	Head	100	1167	7576	528	2.20	21.60	22	1.85
2020/9/27	5750	Head	100	1167	3819	1226	2.19	21.60	21.9	1.39
2020/10/19	5750	Head	100	1167	3826	1210	2.02	21.60	20.2	-6.48

Verify:

Date	Frequency (MHz)	Tissue Type	Input Power (mW)	Dipole S/N	Probe S/N	DAE S/N	Measured 10g SAR (W/kg)	Targeted 10g SAR (W/kg)	Normalized 10g SAR (W/kg)	Deviation (%)
2021/3/2	1750	Head	250	1090	7592	690	4.56	19.20	18.24	-5.00
2021/3/3	1900	Head	250	5d170	7592	690	5.47	20.30	21.88	7.78
2021/3/4	5250	Head	100	1113	7592	690	2.29	23.10	22.90	-0.87

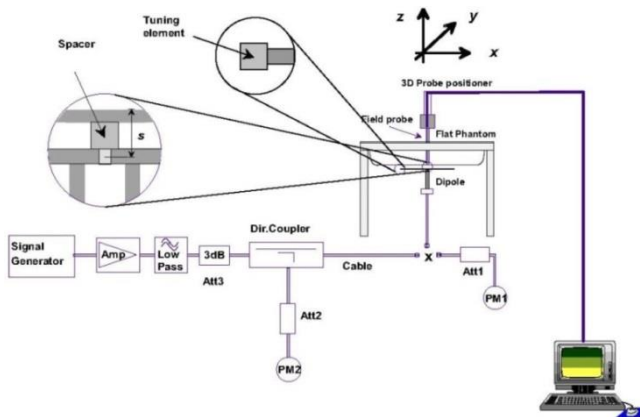

Fig 11.3.1 System Performance Check Setup



Fig 11.3.2 Setup Photo

## 12. RF Exposure Positions

### 12.1 Ear and handset reference point

Figure 12.1.1 shows the front, back, and side views of the SAM phantom. The center-of-mouth reference point is labeled “M,” the left ear reference point (ERP) is marked “LE,” and the right ERP is marked “RE.” Each ERP is 15 mm along the B-M (back-mouth) line behind the entrance-to-ear-canal (EEC) point, as shown in Figure 12.1.2 The Reference Plane is defined as passing through the two ear reference points and point M. The line N-F (neck-front), also called the reference pivoting line, is normal to the Reference Plane and perpendicular to both a line passing through RE and LE and the B-M line (see Figure 12.1.3). Both N-F and B-M lines should be marked on the exterior of the phantom shell to facilitate handset positioning. Posterior to the N-F line the ear shape is a flat surface with 6 mm thickness at each ERP, and forward of the N-F line the ear is truncated, as illustrated in Figure 12.1.2. The ear truncation is introduced to preclude the ear lobe from interfering with handset tilt, which could lead to unstable positioning at the cheek.

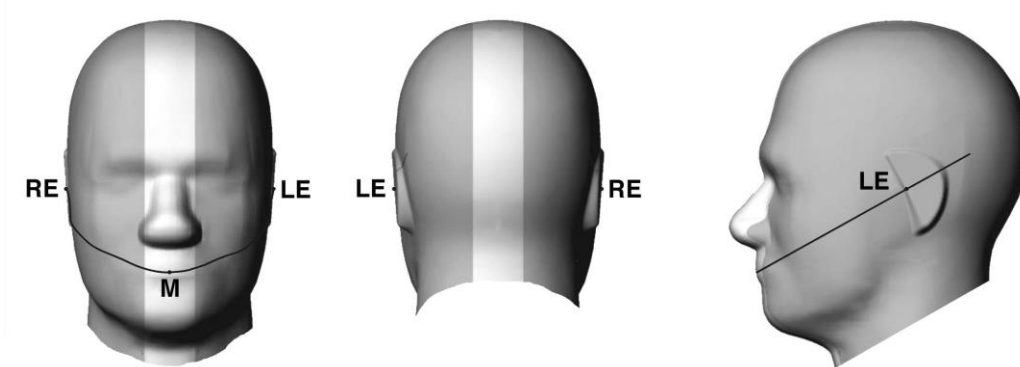

Fig 12.1.1 Front, back, and side views of SAM twin phantom

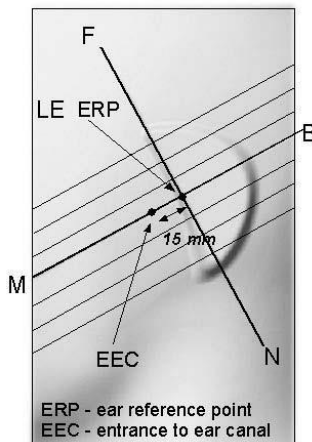

Fig 12.1.2 Close-up side view of phantom showing the ear region.

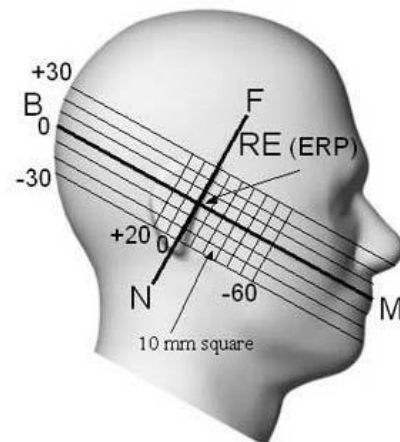

Fig 12.1.3 Side view of the phantom showing relevant markings and seven cross-sectional plane locations

## 12.2 Definition of the cheek position

1. Ready the handset for talk operation, if necessary. For example, for handsets with a cover piece (flip cover), open the cover. If the handset can transmit with the cover closed, both configurations must be tested.
2. Define two imaginary lines on the handset—the vertical centerline and the horizontal line. The vertical centerline passes through two points on the front side of the handset—the midpoint of the width  $w_t$  of the handset at the level of the acoustic output (point A in Figure 12.2.1 and Figure 12.2.2), and the midpoint of the width  $w_b$  of the bottom of the handset (point B). The horizontal line is perpendicular to the vertical centerline and passes through the center of the acoustic output (see Figure 12.2.1). The two lines intersect at point A. Note that for many handsets, point A coincides with the center of the acoustic output; however, the acoustic output may be located elsewhere on the horizontal line. Also note that the vertical centerline is not necessarily parallel to the front face of the handset (see Figure 12.2.2), especially for clamshell handsets, handsets with flip covers, and other irregularly-shaped handsets.
3. Position the handset close to the surface of the phantom such that point A is on the (virtual) extension of the line passing through points RE and LE on the phantom (see Figure 12.2.3), such that the plane defined by the vertical centerline and the horizontal line of the handset is approximately parallel to the sagittal plane of the phantom.
4. Translate the handset towards the phantom along the line passing through RE and LE until handset point A touches the pinna at the ERP.
5. While maintaining the handset in this plane, rotate it around the LE-RE line until the vertical centerline is in the plane normal to the plane containing B-M and N-F lines, i.e., the Reference Plane.
6. Rotate the handset around the vertical centerline until the handset (horizontal line) is parallel to the N-F line.
7. While maintaining the vertical centerline in the Reference Plane, keeping point A on the line passing through RE and LE, and maintaining the handset contact with the pinna, rotate the handset about the N-F line until any point on the handset is in contact with a phantom point below the pinna on the cheek. See Figure 12.2.3. The actual rotation angles should be documented in the test report.

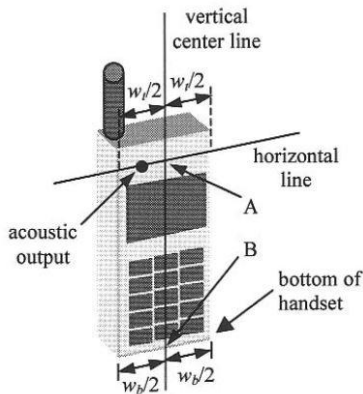

Fig 12.2.1 Handset vertical and horizontal reference lines—“fixed case”

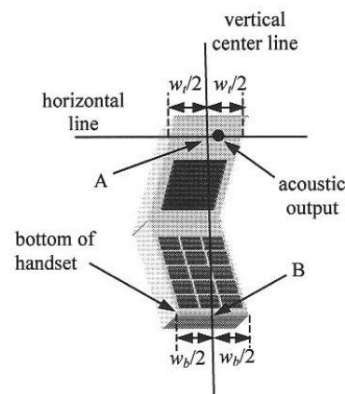

Fig 12.2.2 Handset vertical and horizontal reference lines—“clam-shell case”

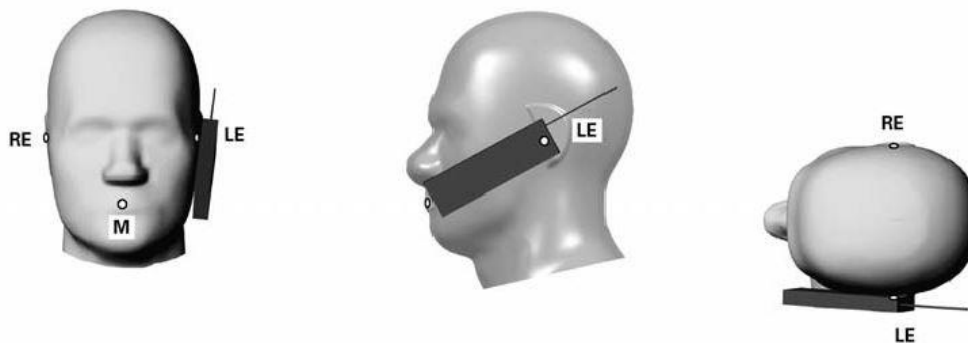
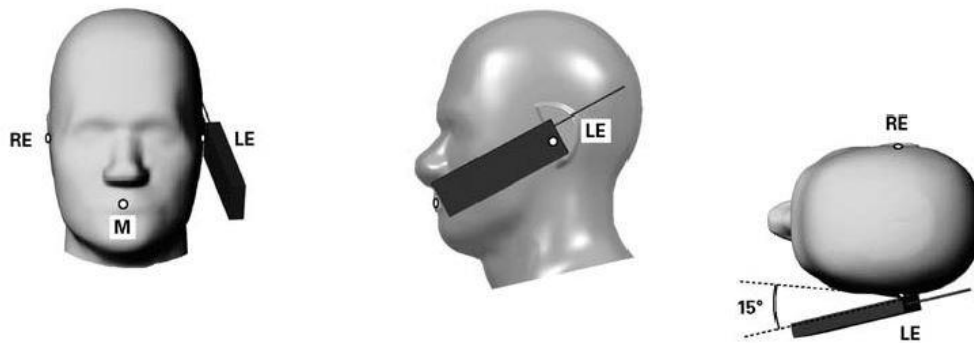

Fig 12.2.3 cheek or touch position. The reference points for the right ear (RE), left ear (LE), and mouth (M), which establish the Reference Plane for handset positioning, are indicated.



**12.3 Definition of the tilt position**

1. Ready the handset for talk operation, if necessary. For example, for handsets with a cover piece (flip cover), open the cover. If the handset can transmit with the cover closed, both configurations must be tested.
2. While maintaining the orientation of the handset, move the handset away from the pinna along the line passing through RE and LE far enough to allow a rotation of the handset away from the cheek by 15°.
3. Rotate the handset around the horizontal line by 15°.
4. While maintaining the orientation of the handset, move the handset towards the phantom on the line passing through RE and LE until any part of the handset touches the ear. The tilt position is obtained when the contact point is on the pinna. See Figure 12.3.1. If contact occurs at any location other than the pinna, e.g., the antenna at the back of the phantom head, the angle of the handset should be reduced. In this case, the tilt position is obtained if any point on the handset is in contact with the pinna and a second point



**Fig 12.3.1 Tilt position. The reference points for the right ear (RE), left ear (LE), and mouth (M), which define the Reference Plane for handset positioning, are indicated.**

## 12.4 Body Worn Accessory

Body-worn operating configurations are tested with the belt-clips and holsters attached to the device and positioned against a flat phantom in a normal use configuration (see Figure 12.4). Per KDB648474 D04v01r03, body-worn accessory exposure is typically related to voice mode operations when handsets are carried in body-worn accessories. The body-worn accessory procedures in FCC KDB 447498 D01v06 should be used to test for body-worn accessory SAR compliance, without a headset connected to it. This enables the test results for such configuration to be compatible with that required for hotspot mode when the body-worn accessory test separation distance is greater than or equal to that required for hotspot mode, when applicable. When the reported SAR for body-worn accessory, measured without a headset connected to the handset is  $> 1.2 \text{ W/kg}$ , the highest reported SAR configuration for that wireless mode and frequency band should be repeated for that body-worn accessory with a handset attached to the handset.

Accessories for body-worn operation configurations are divided into two categories: those that do not contain metallic components and those that do contain metallic components and those that do contain metallic components. When multiple accessories that do not contain metallic components are supplied with the device, the device is tested with only the accessory that dictates the closest spacing to the body. Then multiple accessories that contain metallic components are test with the device with each accessory. If multiple accessories share an identical metallic component (i.e. the same metallic belt-chip used with different holsters with no other metallic components) only the accessory that dictates the closest spacing to the body is tested.

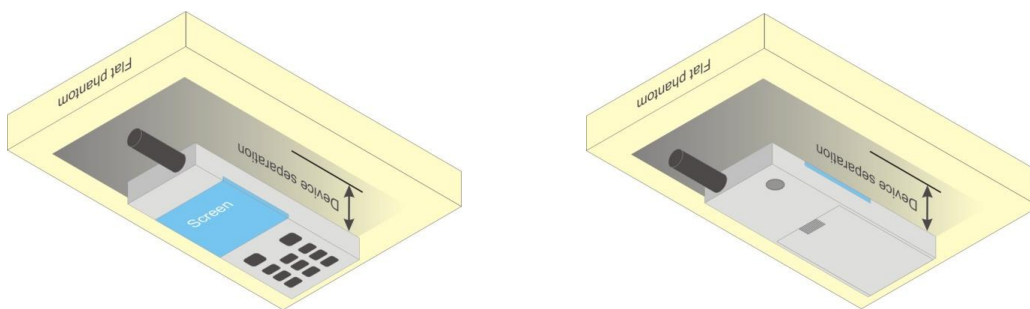

Fig 12.4 Body Worn Position



## **12.5 Product Specific 10g SAR Exposure**

For smart phones with a display diagonal dimension > 15.0 cm or an overall diagonal dimension > 16.0 cm that provide similar mobile web access and multimedia support found in mini-tablets or UMPC mini-tablets that support voice calls next to the ear, According to KDB648474 D04v01r03, the following phablet procedures should be applied to evaluate SAR compliance for each applicable wireless modes and frequency band. Devices marketed as phablets, regardless of form factors and operating characteristics must be tested as a phablet to determine SAR compliance

1. The normally required head and body-worn accessory SAR test procedures for handsets, including hotspot mode, must be applied.
2. The UMPC mini-tablet procedures must also be applied to test the SAR of all surfaces and edges with an antenna located at  $\leq 25$  mm from that surface or edge, in direct contact with a flat phantom, for 10-g extremity SAR according to the body-equivalent tissue dielectric parameters in KDB 865664 to address interactive hand use exposure conditions.6 The UMPC mini-tablet 1-g SAR at 5 mm is not required. When hotspot mode applies, 10-g extremity SAR is required only for the surfaces and edges with hotspot mode 1-g reported SAR > 1.2 W/kg.

## **12.6 Wireless Router**

Some battery-operated handsets have the capability to transmit and receive user through simultaneous transmission of WIFI simultaneously with a separate licensed transmitter. The FCC has provided guidance in FCC KDB Publication 941225 D06 v02r01 where SAR test considerations for handsets ( $L \times W \geq 9$  cm x 5 cm) are based on a composite test separation distance of 10mm from the front, back and edges of the device containing transmitting antennas within 2.5cm of their edges, determined from general mixed use conditions for this type of devices. Since the hotspot SAR results may overlap with the body-worn accessory SAR requirements, the more conservative configurations can be considered, thus excluding some body-worn accessory SAR tests.

When the user enables the personal wireless router functions for the handset, actual operations include simultaneous transmission of both the WIFI transmitter and another licensed transmitter. Both transmitters often do not transmit at the same transmitting frequency and thus cannot be evaluated for SAR under actual use conditions due to the limitations of the SAR assessment probes. Therefore, SAR must be evaluated for each frequency transmission and mode separately and spatially summed with the WIFI transmitter according to FCC KDB Publication 447498 D01v06 publication procedures. The "Portable Hotspot" feature on the handset was NOT activated during SAR assessments, to ensure the SAR measurements were evaluated for a single transmission frequency RF signal at a time.



### **13. Conducted RF Output Power (Unit: dBm)**

The detailed conducted power table can refer to Appendix E.

#### **<GSM Conducted Power>**

1. Per KDB 447498 D01v06, the maximum output power channel is used for SAR testing and for further SAR test reduction.
2. Per KDB 941225 D01v03r01, for SAR test reduction for GSM / GPRS / EDGE modes is determined by the source-based time-averaged output power including tune-up tolerance. The mode with highest specified time-averaged output power should be tested for SAR compliance in the applicable exposure conditions. For modes with the same specified maximum output power and tolerance, the higher number time-slot configuration should be tested. Therefore, the GPRS 2Tx slots for GSM850/GSM1900 are considered as the primary mode.
3. Other configurations of GSM / GPRS / EDGE are considered as secondary modes. The 3G SAR test reduction procedure is applied, when the maximum output power and tune-up tolerance specified for production units in a secondary mode is  $\leq \frac{1}{4}$  dB higher than the primary mode, SAR measurement is not required for the secondary mode.

#### **<WCDMA Conducted Power>**

1. The following tests were conducted according to the test requirements outlines in 3GPP TS 34.121 specification.
2. The procedures in KDB 941225 D01v03r01 are applied for 3GPP Rel. 6 HSPA to configure the device in the required sub-test mode(s) to determine SAR test exclusion.
3. For DC-HSDPA, the device was configured according to the H-Set 12, Fixed Reference Channel (FRC) configuration in Table C.8.1.12 of 3GPP TS 34.121-1, with the primary and the secondary serving HS-DSCH Cell enabled during the power measurement.

A summary of these settings are illustrated below:

#### **HSDPA Setup Configuration:**

- a. The EUT was connected to Base Station Agilent E5515C referred to the Setup Configuration.
- b. The RF path losses were compensated into the measurements.
- c. A call was established between EUT and Base Station with following setting:
  - i. Set Gain Factors ( $\beta_c$  and  $\beta_d$ ) and parameters were set according to each
  - ii. Specific sub-test in the following table, C10.1.4, quoted from the TS 34.121
  - iii. Set RMC 12.2Kbps + HSDPA mode.
  - iv. Set Cell Power = -86 dBm
  - v. Set HS-DSCH Configuration Type to FRC (H-set 1, QPSK)
  - vi. Select HSDPA Uplink Parameters
  - vii. Set Delta ACK, Delta NACK and Delta CQI = 8
  - viii. Set Ack-Nack Repetition Factor to 3
  - ix. Set CQI Feedback Cycle (k) to 4 ms
  - x. Set CQI Repetition Factor to 2
  - xi. Power Ctrl Mode = All Up bits
- d. The transmitted maximum output power was recorded.

Table C.10.1.4:  $\beta$  values for transmitter characteristics tests with HS-DPCCH

Sub-test	$\beta_c$	$\beta_d$	$\beta_d$ (SF)	$\beta_c/\beta_d$	$\beta_{HS}$ (Note 1, Note 2)	CM (dB) (Note 3)	MPR (dB) (Note 3)
1	2/15	15/15	64	2/15	4/15	0.0	0.0
2	12/15 (Note 4)	15/15 (Note 4)	64	12/15 (Note 4)	24/15	1.0	0.0
3	15/15	8/15	64	15/8	30/15	1.5	0.5
4	15/15	4/15	64	15/4	30/15	1.5	0.5

Note 1:  $\Delta_{ACK}$ ,  $\Delta_{NACK}$  and  $\Delta_{CQI} = 30/15$  with  $\beta_{HS} = 30/15 * \beta_c$ .

Note 2: For the HS-DPCCH power mask requirement test in clause 5.2C, 5.7A, and the Error Vector Magnitude (EVM) with HS-DPCCH test in clause 5.13.1A, and HSDPA EVM with phase discontinuity in clause 5.13.1AA,  $\Delta_{ACK}$  and  $\Delta_{NACK} = 30/15$  with  $\beta_{HS} = 30/15 * \beta_c$ , and  $\Delta_{CQI} = 24/15$  with  $\beta_{HS} = 24/15 * \beta_c$ .

Note 3: CM = 1 for  $\beta_c/\beta_d = 12/15$ ,  $\beta_{HS}/\beta_c = 24/15$ . For all other combinations of DPDCCH, DPCCH and HS-DPCCH the MPR is based on the relative CM difference. This is applicable for only UEs that support HSDPA in release 6 and later releases.

Note 4: For subtest 2 the  $\beta_c/\beta_d$  ratio of 12/15 for the TFC during the measurement period (TF1, TF0) is achieved by setting the signalled gain factors for the reference TFC (TF1, TF1) to  $\beta_c = 11/15$  and  $\beta_d = 15/15$ .

**Setup Configuration**

**HSUPA Setup Configuration:**

- a. The EUT was connected to Base Station Agilent E5515C referred to the Setup Configuration.
- b. The RF path losses were compensated into the measurements.
- c. A call was established between EUT and Base Station with following setting \* :
  - i. Call Configs = 5.2B, 5.9B, 5.10B, and 5.13.2B with QPSK
  - ii. Set the Gain Factors ( $\beta_c$  and  $\beta_d$ ) and parameters (AG Index) were set according to each specific sub-test in the following table, C11.1.3, quoted from the TS 34.121
  - iii. Set Cell Power = -86 dBm
  - iv. Set Channel Type = 12.2k + HSPA
  - v. Set UE Target Power
  - vi. Power Ctrl Mode= Alternating bits
  - vii. Set and observe the E-TFCI
  - viii. Confirm that E-TFCI is equal to the target E-TFCI of 75 for sub-test 1, and other subtest's E-TFCI
- d. The transmitted maximum output power was recorded.

**Table C.11.1.3:  $\beta$  values for transmitter characteristics tests with HS-DPCCH and E-DCH**

Sub-test	$\beta_c$	$\beta_d$	$\beta_d$ (SF)	$\beta_c/\beta_d$	$\beta_{HS}$ (Note1)	$\beta_{ec}$	$\beta_{ed}$ (Note 4) (Note 5)	$\beta_{ed}$ (SF)	$\beta_{ed}$ (Codes)	CM (dB) (Note 2)	MPR (dB) (Note 2) (Note 6)	AG Index (Note 5)	E-TFCI
1	11/15 (Note 3)	15/15 (Note 3)	64	11/15 (Note 3)	22/15	209/25	1309/225	4	1	1.0	0.0	20	75
2	6/15	15/15	64	6/15	12/15	12/15	94/75	4	1	3.0	2.0	12	67
3	15/15	9/15	64	15/9	30/15	30/15	$\beta_{ed1}$ : 47/15 $\beta_{ed2}$ : 47/15	4 4	2	2.0	1.0	15	92
4	2/15	15/15	64	2/15	4/15	2/15	56/75	4	1	3.0	2.0	17	71
5	15/15	0	-	-	5/15	5/15	47/15	4	1	1.0	0.0	12	67

Note 1: For sub-test 1 to 4,  $\Delta_{ACK}$ ,  $\Delta_{NACK}$  and  $\Delta_{CQI} = 30/15$  with  $\beta_{hs} = 30/15 * \beta_c$ . For sub-test 5,  $\Delta_{ACK}$ ,  $\Delta_{NACK}$  and  $\Delta_{CQI} = 5/15$  with  $\beta_{hs} = 5/15 * \beta_c$ .

Note 2: CM = 1 for  $\beta_c/\beta_d = 12/15$ ,  $\beta_{hs}/\beta_c = 24/15$ . For all other combinations of DPDCH, DPCCH, HS- DPCCH, E-DPDCH and E-DPCCH the MPR is based on the relative CM difference.

Note 3: For subtest 1 the  $\beta_c/\beta_d$  ratio of 11/15 for the TFC during the measurement period (TF1, TF0) is achieved by setting the signalled gain factors for the reference TFC (TF1, TF0) to  $\beta_c = 10/15$  and  $\beta_d = 15/15$ .

Note 4: In case of testing by UE using E-DPDCH Physical Layer category 1, Sub-test 3 is omitted according to TS25.306 Table 5.1g.

Note 5:  $\beta_{ed}$  can not be set directly; it is set by Absolute Grant Value.

Note 6: For subtests 2, 3 and 4, UE may perform E-DPDCH power scaling at max power which could results in slightly smaller MPR values.

**Setup Configuration**

**DC-HSDPA 3GPP release 8 Setup Configuration:**

- a. The EUT was connected to Base Station referred to the Setup Configuration below
- b. The RF path losses were compensated into the measurements.
- c. A call was established between EUT and Base Station with following setting:
  - i. Set RMC 12.2Kbps + HSDPA mode.
  - ii. Set Cell Power = -25 dBm
  - iii. Set HS-DSCH Configuration Type to FRC (H-set 12, QPSK)
  - iv. Select HSDPA Uplink Parameters
  - v. Set Gain Factors ( $\beta_c$  and  $\beta_d$ ) and parameters were set according to each Specific sub-test in the following table, C10.1.4, quoted from the TS 34.121
    - a). Subtest 1:  $\beta_c/\beta_d=2/15$
    - b). Subtest 2:  $\beta_c/\beta_d=12/15$
    - c). Subtest 3:  $\beta_c/\beta_d=15/8$
    - d). Subtest 4:  $\beta_c/\beta_d=15/4$
  - vi. Set Delta ACK, Delta NACK and Delta CQI = 8
  - vii. Set Ack-Nack Repetition Factor to 3
  - viii. Set CQI Feedback Cycle (k) to 4 ms
  - ix. Set CQI Repetition Factor to 2
  - x. Power Ctrl Mode = All Up bits
- d. The transmitted maximum output power was recorded.

The following tests were conducted according to the test requirements outlines in 3GPP TS 34.121 specification. A summary of these settings are illustrated below:

**C.8.1.12 Fixed Reference Channel Definition H-Set 12**

**Table C.8.1.12: Fixed Reference Channel H-Set 12**

Parameter	Unit	Value
Nominal Avg. Inf. Bit Rate	kbps	60
Inter-TTI Distance	TTI's	1
Number of HARQ Processes	Processes	6
Information Bit Payload ( $N_{INF}$ )	Bits	120
Number Code Blocks	Blocks	1
Binary Channel Bits Per TTI	Bits	960
Total Available SML's in UE	SML's	19200
Number of SML's per HARQ Proc.	SML's	3200
Coding Rate		0.15
Number of Physical Channel Codes	Codes	1
Modulation		QPSK
Note 1: The RMC is intended to be used for DC-HSDPA mode and both cells shall transmit with identical parameters as listed in the table. Note 2: Maximum number of transmission is limited to 1, i.e., retransmission is not allowed. The redundancy and constellation version 0 shall be used.		

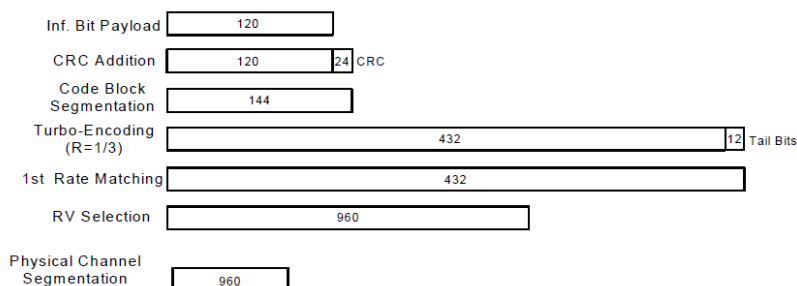

**Figure C.8.19: Coding rate for Fixed reference Channel H-Set 12 (QPSK)**

**Setup Configuration**



**<WCDMA Conducted Power>**

**General Note:**

1. Per KDB 941225 D01v03r01, for SAR testing is measured using a 12.2 kbps RMC with TPC bits configured to all "1's".
2. Per KDB 941225 D01v03r01, RMC 12.2kbps setting is used to evaluate SAR. The maximum output power and tune-up tolerance specified for production units in HSDPA / HSUPA / DC-HSDPA is  $\leq \frac{1}{4}$  dB higher than RMC 12.2Kbps or when the highest reported SAR of the RMC12.2Kbps is scaled by the ratio of specified maximum output power and tune-up tolerance of HSDPA / HSUPA / DC-HSDPA to RMC12.2Kbps and the adjusted SAR is  $\leq 1.2$  W/kg, SAR measurement is not required for HSDPA / HSUPA / DC-HSDPA, and according to the following RF output power, the output power results of the secondary modes (HSDPA / HSUPA / DC-HSDPA) are less than  $\frac{1}{4}$  dB higher than the primary modes; therefore, SAR measurement is not required for HSDPA / HSUPA / DC-HSDPA

**<CDMA2000 Conducted Power>**

**General Note:**

1. Per KDB 941225 D01v03r01, SAR for head exposure is measured in RC3 with the handset configured to transmit at full rate in SO55.
2. Per KDB 941225 D01v03r01, in Hotspot mode EUT is treated as data device and SAR is tested with Ev-Do Rev 0 (RTAP 153.6kbps) as the primary mode.
3. Per KDB 941225 D01v03r01, for Body-worn accessory SAR is measured in RC3 with the handset configured in TDSO/SO32 to transmit at full rate on FCH only with all other code channels disabled. The body-worn accessory procedures in KDB Publication 447498 are applied. The 3G SAR test reduction procedure is applied to the multiple code channel configuration (FCH+SCH), with FCH only as the primary mode.



**<LTE Conducted Power>**

**General Note:**

1. Anritsu MT8820C base station simulator was used to setup the connection with EUT; the frequency band, channel bandwidth, RB allocation configuration, modulation type are set in the base station simulator to configure EUT transmitting at maximum power and at different configurations which are requested to be reported to FCC, for conducted power measurement and SAR testing.
2. Per KDB 941225 D05v02r05, when a properly configured base station simulator is used for the SAR and power measurements, spectrum plots for each RB allocation and offset configuration is not required.
3. Per KDB 941225 D05v02r05, start with the largest channel bandwidth and measure SAR for QPSK with 1 RB allocation, using the RB offset and required test channel combination with the highest maximum output power for RB offsets at the upper edge, middle and lower edge of each required test channel.
4. Per KDB 941225 D05v02r05, 50% RB allocation for QPSK SAR testing follows 1RB QPSK allocation procedure.
5. Per KDB 941225 D05v02r05, for QPSK with 100% RB allocation, SAR is not required when the highest maximum output power for 100 % RB allocation is less than the highest maximum output power in 50% and 1 RB allocations and the highest reported SAR for 1 RB and 50% RB allocation are  $\leq 0.8$  W/kg. Otherwise, SAR is measured for the highest output power channel; and if the reported SAR is  $> 1.45$  W/kg, the remaining required test channels must also be tested.
6. Per KDB 941225 D05v02r05, 16QAM/64QAM output power for each RB allocation configuration is  $>$  not  $\frac{1}{2}$  dB higher than the same configuration in QPSK and the reported SAR for the QPSK configuration is  $\leq 1.45$  W/kg; Per KDB 941225 D05v02r05, 16QAM/64QAM SAR testing is not required.
7. Per KDB 941225 D05v02r05, smaller bandwidth output power for each RB allocation configuration is  $>$  not  $\frac{1}{2}$  dB higher than the same configuration in the largest supported bandwidth, and the reported SAR for the largest supported bandwidth is  $\leq 1.45$  W/kg; Per KDB 941225 D05v02r05, smaller bandwidth SAR testing is not required.
8. For LTE B4 / B5 / B12 / B17 / B38 / B71 the maximum bandwidth does not support three non-overlapping channels, per KDB 941225 D05v02r05, when a device supports overlapping channel assignment in a channel bandwidth configuration, the middle channel of the group of overlapping channels should be selected for testing.
9. LTE B17 / B2 / B4 / B38 SAR test was covered by B12 / B25 / B66 /B41; according to April 2015 TCB workshop, SAR test for overlapping LTE bands can be reduced if
  - a. the maximum output power, including tolerance, for the smaller band is  $\leq$  the larger band to qualify for the SAR test exclusion
  - b. the channel bandwidth and other operating parameters for the smaller band are fully supported by the larger band
10. According to 2017 TCB workshop, for 64 QAM and 16 QAM should be verified by checking the signal constellation with a call box to avoid incorrect maximum power levels due to MPR and other requirements associated with signal modulation, and the following figure is taken from the "Fundamental Measurement >> Modulation Analysis >> constellation" mode of the device connect to the MT8821C base station, therefore, the device 64QAM and 16QAM signal modulation are correct.

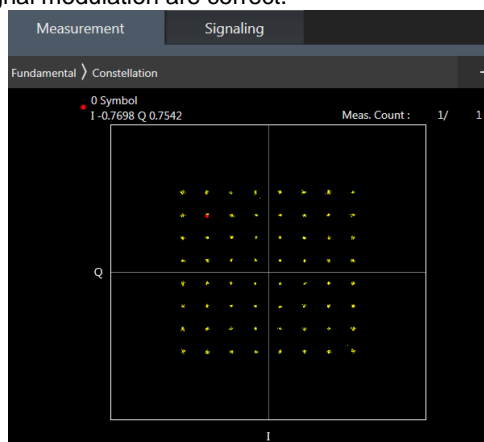

**64QAM**



**16QAM**



Special subframe (30720·T <sub>s</sub> ): Normal cyclic prefix in downlink (UpPTS)			
	Special subframe configuration	Normal cyclic prefix in uplink	Extended cyclic prefix in uplink
Uplink duty factor in one special subframe	0~4	7.13%	8.33%
	5~9	14.3%	16.7%

Special subframe(30720·T <sub>s</sub> ): Extended cyclic prefix in downlink (UpPTS)			
	Special subframe configuration	Normal cyclic prefix in uplink	Extended cyclic prefix in uplink
Uplink duty factor in one special subframe	0~3	7.13%	8.33%
	4~7	14.3%	16.7%

The highest duty factor is resulted from:

For LTE Band 41 Power class 2

- i. Uplink-downlink configuration: 1. In a half-frame consisted of 5 subframes, uplink operation is in 2 uplink subframes and 1 special subframe.
- ii. special subframe configuration: 5-9 for normal cyclic prefix in downlink, 4-7 for extended cyclic prefix in downlink
- iii. for special subframe with extended cyclic prefix in uplink, the total uplink duty factor in one half-frame is:  $(2+0.167)/5 = 43.3\%$
- iv. for special subframe with normal cyclic prefix in uplink, the total uplink duty factor in one half-frame is:  $(2+0.143)/5 = 42.9\%$
- v. For TDD LTE SAR measurement, the duty cycle 1:2.33 (42.9 %) was used perform testing and considering the theoretical duty cycle of 43.3% for extended cyclic prefix in the uplink, and the theoretical duty cycle of 42.9% for normal cyclic prefix in uplink, a scaling factor of extended cyclic prefix  $43.3\%/42.9\% = 1.009$  is applied to scale-up the measured SAR result. The scaled TDD LTE SAR = measured SAR (W/kg)\* Tune-up Scaling Factor\* scaling factor for extended cyclic prefix.

For LTE Band 41 Power class 3

- i. Uplink-downlink configuration: 0. In a half-frame consisted of 5 subframes, uplink operation is in 3 uplink subframes and 1 special subframe.
- ii. special subframe configuration: 5-9 for normal cyclic prefix in downlink, 4-7 for extended cyclic prefix in downlink
- iii. for special subframe with extended cyclic prefix in uplink, the total uplink duty factor in one half-frame is:  $(3+0.167)/5 = 63.3\%$
- iv. for special subframe with normal cyclic prefix in uplink, the total uplink duty factor in one half-frame is:  $(3+0.143)/5 = 62.9\%$
- v. For TDD LTE SAR measurement, the duty cycle 1:1.59 (62.9 %) was used perform testing and considering the theoretical duty cycle of 63.3% for extended cyclic prefix in the uplink, and the theoretical duty cycle of 62.9% for normal cyclic prefix in uplink, a scaling factor of extended cyclic prefix  $63.3\%/62.9\% = 1.006$  is applied to scale-up the measured SAR result. The scaled TDD LTE SAR = measured SAR (W/kg)\* Tune-up Scaling Factor\* scaling factor for extended cyclic prefix.

The device can adjust uplink/downlink configuration automatically according to the transmitting power class level, as followings:

LTE TDD Band	Power Class level	support uplink/downlink configuration
LTE Band 41	> 23	1,2,3,4,5
	=23	0,1,2,3,4,5,6
	< 23	0,1,2,3,4,5,6



<LTE Carrier Aggregation>

General Note:

1. This device supports Carrier Aggregation on downlink for inter and intra band. For the device supports bands and bandwidths and configurations are provided as follow table was according to 3GPP.
2. In applying the existing power measurement procedures of KDB 941225 D05A for DL CA SAR test exclusion, only the subset with the largest number of combinations of frequency bands and CCs in each row need combination, and for this device that all the configurations were choose to power measurement.
3. All permutations exist. No restrictions on Pcell & Scell combinations. Only LTE Band 29A is limited to Scell.

2CC Downlink Carrier Aggregation				
Number	Combination	4X4 MIMO	Restriction	Covered by Measurement Superset
1	CA_2C			
2	CA_2A-2A			
3	CA_2A-4A			
4	CA_2A-5A			
5	CA_2A-7A			
6	CA_2A-12A			
7	CA_2A-13A			
8	CA_2A-14A			
9	CA_2A-17A			
10	CA_2A-29A		B29 SCC Only	
11	CA_2A-30A			
12	CA_2A-66A			
13	CA_2A-71A			
14	CA_4A-4A			
15	CA_4A-5A			
16	CA_4A-7A			
17	CA_4A-12A			
18	CA_4A-13A			
19	CA_4A-17A			
20	CA_4A-29A		B29 SCC Only	
21	CA_4A-30A			
22	CA_4A-71A			
23	CA_5B			
24	CA_5A-7A			
25	CA_5A-30A			
26	CA_5A-66A			
27	CA_7C			
28	CA_7A-7A			
29	CA_7A-12A			
30	CA_7A-66A			
31	CA_12B			
32	CA_12A-30A			
33	CA_12A-66A			
34	CA_13A-66A			
35	CA_14A-30A			
36	CA_14A-66A			
37	CA_25A-25A			
38	CA_25A-26A			
39	CA_25A-41A			
40	CA_26A-41A			
41	CA_29A-30A		B29 SCC Only	
42	CA_29A-66A		B29 SCC Only	



43	CA_30A-66A			
44	CA_38C			
45	CA_41C			
46	CA_41A-41A			
47	CA_66B			
48	CA_66C			
49	CA_66A-66A			
50	CA_66A-71A			

**LTE Carrier Aggregation Conducted Power (Downlink)**

- i. According to KDB941225 D05A v01r02, Uplink maximum output power measurement with downlink carrier aggregation active should be measured, using the highest output channel measured without downlink carrier aggregation, to confirm that uplink maximum output power with downlink carrier aggregation active remains within the specified tune-up tolerance limits and not more than ¼ dB higher than the maximum output measured without downlink carrier aggregation active.
- ii. Uplink maximum output power with downlink carrier aggregation active does not show more than ¼ dB higher than the maximum output power without downlink carrier aggregation active, therefore SAR evaluation with downlink carrier aggregation active can be excluded.
- iii. The device supports downlink two carrier aggregation. For power measurement were control and acknowledge data is sent on uplink channels that operate identical to specifications when downlink carrier aggregation is inactive.
- iv. Selected highest measured power when downlink carrier aggregation is inactive for conducted power comparison with downlink carrier aggregation is active, to confirm that when downlink carrier aggregation is active uplink maximum output power remains within the specified tune-up tolerance limits and not more than ¼ dB higher than the maximum output power measured when downlink carrier aggregation inactive.
- v. For inter-band CA, the SCC selected highest bandwidth and near the middle of its transmission band. For SCC DL RB size and offset will base on the PCC corresponding RB allocation.
- vi. For non-contiguous intra-band CA, the SCC selected to provide maximum separation from the PCC and must remain fully within the downlink transmission band.
- vii. For Intra-band, contiguous CA, the downlink channels selected to perform the uplink power measurement must satisfy 3GPP channel spacing (5.4.1A of 3GPP TS 36.521 or equivalent) and channel bandwidth (5.4.2A) requirements.

$$\text{Nominal channel spacing} = \left\lceil \frac{BW_{\text{Channel}(1)} + BW_{\text{Channel}(2)} - 0.1|BW_{\text{Channel}(1)} - BW_{\text{Channel}(2)}|}{0.6} \right\rceil 0.3 \text{ [MHz]}$$

**LTE Carrier Aggregation Conducted Power (Uplink)**

1. This device supports uplink carrier aggregation for LTE CA\_41C with a maximum of two 20MHz component carriers. For intra band contiguous carrier aggregation scenarios, 3GPP 36.101 Table 6.2.2A-1 specifies that the aggregate maximum allowed output power is equivalent to the single carrier scenario. For the non-contiguously allocated resource blocks which the MPR level is determined by various RB separation and RB sizes requirement, and the allowed MPR levels, settings and the conducted powers are permanently implemented in this device per the 3GPP 36.36.101 section 6.2.3A.1.3 requirements.
2. According to FCC guidance, the output power with uplink CA active was measured for the high / middle / low channel configuration with the highest reported SAR for each exposure condition, the power was measured with wideband signal integration over both component carriers.
3. In applying the power measurement procedures of KDB 941225 D05A for DL CA to qualify for UL SAR test exclusion, power measurement is required only for the subset in each row with the largest combination of frequency bands and CCs
4. Maximum output power measurement is required for each UL CA configuration for the required test channels described in KDB 941225 D05. The required test channel should be associated with the UL PCC. For channels at the ends of a frequency band, the SCC and subsequent CCs are added to the side within the transmission band. Otherwise, the CCs should be added alternatively to either side of the PCC.

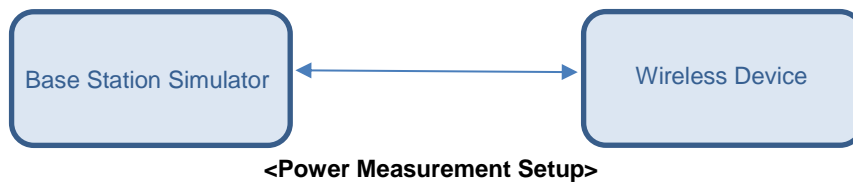

### <WLAN Conducted Power>

#### General Note:

1. Per KDB 248227 D01v02r02, SAR test reduction is determined according to 802.11 transmission mode configurations and certain exposure conditions with multiple test positions. In the 2.4 GHz band, separate SAR procedures are applied to DSSS and OFDM configurations to simplify DSSS test requirements. For OFDM, in both 2.4 and 5 GHz bands, an initial test configuration must be determined for each standalone and aggregated frequency band, according to the transmission mode configuration with the highest maximum output power specified for production units to perform SAR measurements. If the same highest maximum output power applies to different combinations of channel bandwidths, modulations and data rates, additional procedures are applied to determine which test configurations require SAR measurement. When applicable, an initial test position may be applied to reduce the number of SAR measurements required for next to the ear, UMPC mini-tablet or hotspot mode configurations with multiple test positions.
2. For 2.4 GHz 802.11b DSSS, either the initial test position procedure for multiple exposure test positions or the DSSS procedure for fixed exposure position is applied; these are mutually exclusive. For 2.4 GHz and 5 GHz OFDM configurations, the initial test configuration is applied to measure SAR using either the initial test position procedure for multiple exposure test position configurations or the initial test configuration procedures for fixed exposure test conditions. Based on the reported SAR of the measured configurations and maximum output power of the transmission mode configurations that are not included in the initial test configuration, the subsequent test configuration and initial test position procedures are applied to determine if SAR measurements are required for the remaining OFDM transmission configurations. In general, the number of test channels that require SAR measurement is minimized based on maximum output power measured for the test sample(s).
3. For OFDM transmission configurations in the 2.4 GHz and 5 GHz bands, When the same maximum power is specified for multiple transmission modes in a frequency band, the largest channel bandwidth, lowest order modulation, lowest data rate and lowest order 802.11a/g/n/ac mode is used for SAR measurement, on the highest measured output power channel for each frequency band.
4. DSSS and OFDM configurations are considered separately according to the required SAR procedures. SAR is measured in the initial test position using the 802.11 transmission mode configuration required by the DSSS procedure or initial test configuration and subsequent test configuration(s) according to the OFDM procedures.18 The initial test position procedure is described in the following:
  - a. When the reported SAR of the initial test position is  $\leq 0.4$  W/kg, further SAR measurement is not required for the other test positions in that exposure configuration and 802.11 transmission mode combinations within the frequency band or aggregated band.
  - b. When the reported SAR of the test position is  $> 0.4$  W/kg, SAR is repeated for the 802.11 transmission mode configuration tested in the initial test position to measure the subsequent next closet/smallest test separation distance and maximum coupling test position on the highest maximum output power channel, until the report SAR is  $\leq 0.8$  W/kg or all required test position are tested.
  - c. For all positions/configurations, when the reported SAR is  $> 0.8$  W/kg, SAR is measured for these test positions/configurations on the subsequent next highest measured output power channel(s) until the reported SAR is  $\leq 1.2$  W/kg or all required channels are tested.



**<2.4GHz Bluetooth>**

**General Note:**

1. For 2.4GHz Bluetooth SAR testing was selected 1Mbps, due to its highest average power.
2. The Bluetooth duty cycle is 77.03 % as following figure, according to 2016 Oct. TCB workshop for Bluetooth SAR scaling need further consideration and the theoretical duty cycle is 83.3%, therefore the actual duty cycle will be scaled up to the theoretical value of Bluetooth reported SAR calculation

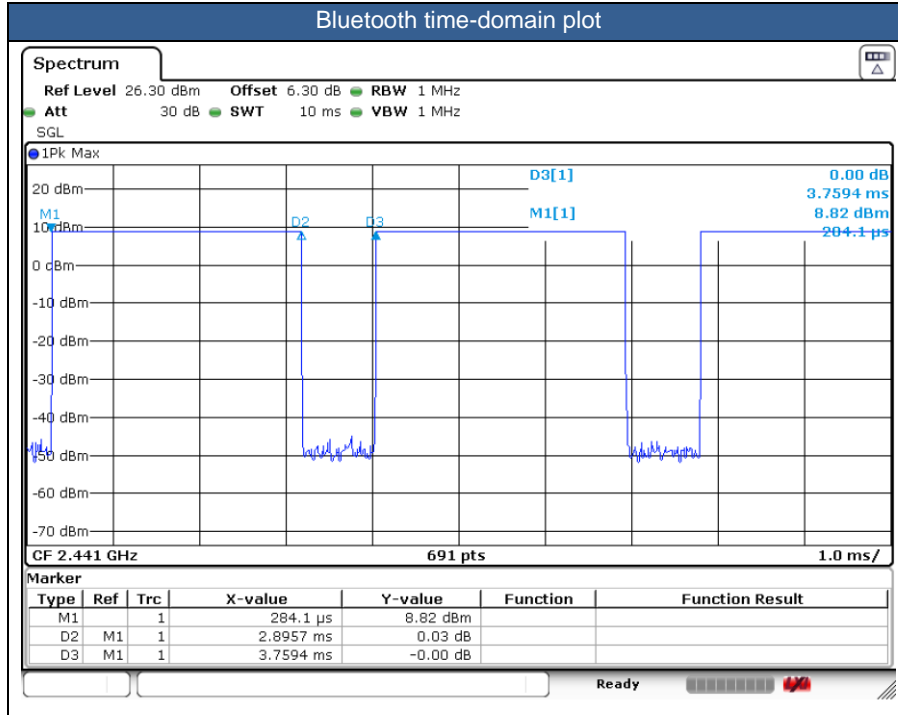



## **14. Antenna Location**

The detailed antenna location information can refer to SAR Test Setup Photos.



## **15. SAR Test Results**

### **General Note:**

1. Per KDB 447498 D01v06, the reported SAR is the measured SAR value adjusted for maximum tune-up tolerance.
  - a. Tune-up scaling Factor = tune-up limit power (mW) / EUT RF power (mW), where tune-up limit is the maximum rated power among all production units.
  - b. For SAR testing of WLAN signal with non-100% duty cycle, the measured SAR is scaled-up by the duty cycle scaling factor which is equal to "1/(duty cycle)"
  - c. For WWAN: Reported SAR(W/kg)= Measured SAR(W/kg)\*Tune-up Scaling Factor
  - d. For BT/WLAN: Reported SAR(W/kg)= Measured SAR(W/kg)\* Duty Cycle scaling factor \* Tune-up scaling factor
  - e. For TDD LTE SAR measurement, the duty cycle 1:1.59 (62.9 %) was used perform testing and considering the theoretical duty cycle of 63.3% for extended cyclic prefix in the uplink, and the theoretical duty cycle of 62.9% for normal cyclic prefix in uplink, a scaling factor of extended cyclic prefix 63.3%/62.9% = 1.006 is applied to scale-up the measured SAR result. The Reported TDD LTE SAR = measured SAR (W/kg)\* Tune-up Scaling Factor\* scaling factor for extended cyclic prefix.
2. Per KDB 447498 D01v06, for each exposure position, testing of other required channels within the operating mode of a frequency band is not required when the *reported* 1-g or 10-g SAR for the mid-band or highest output power channel is:
  - ≤ 0.8 W/kg or 2.0 W/kg, for 1-g or 10-g respectively, when the transmission band is ≤ 100 MHz
  - ≤ 0.6 W/kg or 1.5 W/kg, for 1-g or 10-g respectively, when the transmission band is between 100 MHz and 200 MHz
  - ≤ 0.4 W/kg or 1.0 W/kg, for 1-g or 10-g respectively, when the transmission band is ≥ 200 MHz
3. Per KDB 865664 D01v01r04, for each frequency band, repeated SAR measurement is required when the measured SAR is ≥ 0.8W/kg. Per KDB 865664 D01v01r04, if the extremity repeated SAR is necessary, the same procedures should be adapted for measurements according to extremity and occupational exposure limits by applying a factor of 2.5 for extremity exposure and a factor of 5 for occupational exposure to the corresponding SAR thresholds.
4. Pre KDB648474 D04v01r03, when the reported SAR for a body-worn accessory, measured without a headset connected to the handset, is > 1.2 W/kg, the highest reported SAR configuration for that wireless mode and frequency band should be repeated for that body-worn accessory with a headset attached to the handset. When headset SAR is less than or equal than without headset SAR, no need to verify the remaining channels for headset SAR.
5. The device implements Proximity sensors/receiver detect mechanism/hotspot trigger reduced power for the power management for SAR compliance at different exposure conditions (head, body-worn, hotspot, extremity).
6. The device will invoke corresponding work scenarios power level, which are provided in the operational description.
7. For Some WWAN bands, sensor on reduced power level higher than hotspot reduced power level, so front/back sensor on SAR can represent hotspot conservatively.
8. This device has two WWAN transmitter antennas. WWAN antenna 1 is located at the right of bottom edge of the device and WWAN antenna 2 is located at the left side of bottom edge of the device which can refer to antenna location chapter. WWAN antenna 1 frequency bands include GSM850/1900, WCDMA Band II/IV/V, CDMA2000 BC0/BC1/BC10, and LTE Band 2/4/5/12/13/14/17/25/26/66/71, WWAN antenna 2 frequency band include LTE Band 7/30/38/41.
9. Per KDB648474 D04v01r03, for smart phones with a display diagonal dimension > 15.0 cm or an overall diagonal dimension > 16.0 cm, when hotspot mode applies, 10-g extremity SAR is required only for the surfaces and edges with hotspot mode 1-g reported SAR > 1.2 W/kg, however, when power reduction applies to hotspot mode the measured SAR must be scaled to the maximum output power (for handheld on state, the maximum full power means reduced power), including tolerance, allowed for phablet modes to compare with the 1.2 W/kg SAR test reduction threshold.
  - a. For this device SAR for WWAN/WLAN transmitter scaled to maximum output power mode for product specific 10g SAR is higher than 1.2W/kg of GSM850/1900, WCDMA Band II/IV/V, CDMA BC0/ BC1, LTE Band 2/4/5/7/13/25/26/30/38/41/66, and WLAN 2.4GHz/WLAN 5.2/5.8GHz therefore product specific 10g SAR is necessary.
  - b. WLAN 5.3/5.5GHz tested the product specific 10g SAR since it has no hotspot mode.
  - c. When 10-g product specific 10g SAR is considered, SAR thresholds is specified in the procedures for SAR test reduction and exclusion should be multiplied by 2.5.
10. For verification of compliance of power reduction scheme, additional SAR testing with EUT transmitting at full RF power at a conservative trigger distance was performed for body worn:  
Front: [18 mm](#)  
Back: [19 mm](#)
11. For verification of compliance of power reduction scheme, additional SAR testing with EUT transmitting at full RF power at a conservative trigger distance was performed for handheld:  
For antenna 1  
Front: [15 mm](#)  
Back: [17 mm](#)  
Bottom side: [18 mm](#)



For antenna 2  
Front: [7 mm](#)  
Back: [7 mm](#)  
Left side: [8 mm](#)  
Bottom side: [8 mm](#)

**GSM Note:**

1. Per KDB 941225 D01v03r01, for SAR test reduction for GSM / GPRS / EDGE modes is determined by the source-based time-averaged output power including tune-up tolerance. The mode with highest specified time-averaged output power should be tested for SAR compliance in the applicable exposure conditions. For modes with the same specified maximum output power and tolerance, the higher number time-slot configuration should be tested. Therefore, the GPRS 2Tx slots for GSM850/GSM1900 are considered as the primary mode.
2. Other configurations of GSM / GPRS / EDGE are considered as secondary modes. The 3G SAR test reduction procedure is applied, when the maximum output power and tune-up tolerance specified for production units in a secondary mode is  $\leq$  ¼ dB higher than the primary mode, SAR measurement is not required for the secondary mode.

**WCDMA Note:**

1. Per KDB 941225 D01v03r01, for SAR testing is measured using a 12.2 kbps RMC with TPC bits configured to all "1's".
2. Per KDB 941225 D01v03r01, RMC 12.2kbps setting is used to evaluate SAR. The maximum output power and tune-up tolerance specified for production units in HSDPA / HSUPA / DC-HSDPA is  $\leq$  ¼ dB higher than RMC 12.2Kbps or when the highest reported SAR of the RMC12.2Kbps is scaled by the ratio of specified maximum output power and tune-up tolerance of HSDPA / HSUPA / DC-HSDPA to RMC12.2Kbps and the adjusted SAR is  $\leq$  1.2 W/kg, SAR measurement is not required for HSDPA / HSUPA / DC-HSDPA, and according to the following RF output power, the output power results of the secondary modes (HSDPA / HSUPA / DC-HSDPA) are less than ¼ dB higher than the primary modes; therefore, SAR measurement is not required for HSDPA / HSUPA / DC-HSDPA.

**CDMA Note:**

1. Per KDB 941225 D01v03r01, SAR for next to the ear head exposure is measured in RC3 with the handset configured to transmit at full rate in SO55.
2. Per KDB 941225 D01v03r01, in Hotspot mode EUT is treated as data device and SAR is tested with Ev-Do Rev 0 (RTAP 153.6kbps) as the primary mode.
3. Per KDB 941225 D01v03r01, for Body-worn accessory SAR is measured in RC3 with the handset configured in TDSO/SO32 to transmit at full rate on FCH only with all other code channels disabled. The body-worn accessory procedures in KDB Publication 447498 are applied. The 3G SAR test reduction procedure is applied to the multiple code channel configuration (FCH+SCH), with FCH only as the primary mode.

**LTE Note:**

1. Per KDB 941225 D05v02r05, start with the largest channel bandwidth and measure SAR for QPSK with 1 RB allocation, using the RB offset and required test channel combination with the highest maximum output power for RB offsets at the upper edge, middle and lower edge of each required test channel.
2. Per KDB 941225 D05v02r05, 50% RB allocation for QPSK SAR testing follows 1RB QPSK allocation procedure.
3. Per KDB 941225 D05v02r05, for QPSK with 100% RB allocation, SAR is not required when the highest maximum output power for 100 % RB allocation is less than the highest maximum output power in 50% and 1 RB allocations and the highest reported SAR for 1 RB and 50% RB allocation are  $\leq 0.8$  W/kg. Otherwise, SAR is measured for the highest output power channel; and if the reported SAR is  $> 1.45$  W/kg, the remaining required test channels must also be tested.
4. Per KDB 941225 D05v02r05, 16QAM/64QAM output power for each RB allocation configuration is  $>$  not  $\frac{1}{2}$  dB higher than the same configuration in QPSK and the reported SAR for the QPSK configuration is  $\leq 1.45$  W/kg; Per KDB 941225 D05v02r05, 16QAM/64QAM SAR testing is not required.
5. Per KDB 941225 D05v02r05, smaller bandwidth output power for each RB allocation configuration is  $>$  not  $\frac{1}{2}$  dB higher than the same configuration in the largest supported bandwidth, and the reported SAR for the largest supported bandwidth is  $\leq 1.45$  W/kg; Per KDB 941225 D05v02r05, smaller bandwidth SAR testing is not required.
6. This device supports HPUE for LTE band 41 with class 2 level, so HPUE SAR has been performed.
7. For LTE B4 / B5 / B12 / B17 / B38 / B71 the maximum bandwidth does not support three non-overlapping channels, per KDB 941225 D05v02r05, when a device supports overlapping channel assignment in a channel bandwidth configuration, the middle channel of the group of overlapping channels should be selected for testing.
8. LTE B2 / B4 / B17 / B38 SAR test was covered by LTE B25 / B66 / B12 / B41; according to April 2015 TCB workshop, SAR test for overlapping LTE bands can be reduced if
  - c. the maximum output power, including tolerance, for the smaller band is  $\leq$  the larger band to qualify for the SAR test exclusion
  - d. the channel bandwidth and other operating parameters for the smaller band are fully supported by the larger band

**WLAN Note:**

1. Per KDB 248227 D01v02r02, for 2.4GHz 802.11g/n SAR testing is not required when the highest reported SAR for DSSS is adjusted by the ratio of OFDM to DSSS specified maximum output power and the adjusted SAR is  $\leq 1.2$  W/kg.
2. Per KDB 248227 D01v02r02, U-NII-1 SAR testing is not required when the U-NII-2A band highest reported SAR for a test configuration is  $\leq 1.2$  W/kg, SAR is not required for U-NII-1 band.
3. When the reported SAR of the test position is  $> 0.4$  W/kg, SAR is repeated for the 802.11 transmission mode configuration tested in the initial test position to measure the subsequent next closet/smallest test separation distance and maximum coupling test position on the highest maximum output power channel, until the report SAR is  $\leq 0.8$  W/kg or all required test position are tested.
4. For all positions / configurations, when the reported SAR is  $> 0.8$  W/kg, SAR is measured for these test positions / configurations on the subsequent next highest measured output power channel(s) until the reported SAR is  $\leq 1.2$  W/kg or all required channels are tested.
5. During SAR testing the WLAN transmission was verified using a spectrum analyzer.



**15.1 Head SAR**

**<GSM SAR>**

Plot No.	Band	Mode	Test Position	Power Reduction	Ch.	Freq. (MHz)	Average Power (dBm)	Tune-Up Limit (dBm)	Tune-up Scaling Factor	Power Drift (dB)	Measured 1g SAR (W/kg)	Reported 1g SAR (W/kg)
	GSM850	GPRS 2 Tx slots	Right Cheek	Full	189	836.4	30.40	31.50	1.288	0.02	0.368	0.474
	GSM850	GPRS 2 Tx slots	Right Tilted	Full	189	836.4	30.40	31.50	1.288	0.07	0.187	0.241
	GSM850	GPRS 2 Tx slots	Left Cheek	Full	189	836.4	30.40	31.50	1.288	-0.1	0.325	0.419
	GSM850	GPRS 2 Tx slots	Left Tilted	Full	189	836.4	30.40	31.50	1.288	-0.16	0.172	0.222
	GSM850	GPRS 2 Tx slots	Right Cheek	Full	128	824.2	30.32	31.50	1.312	0.07	0.276	0.362
01	GSM850	GPRS 2 Tx slots	Right Cheek	Full	251	848.8	30.02	31.50	1.406	-0.1	0.340	<b>0.478</b>
	GSM1900	GPRS 2 Tx slots	Right Cheek	Full	661	1880	27.82	29.00	1.312	0.01	0.024	0.031
	GSM1900	GPRS 2 Tx slots	Right Tilted	Full	661	1880	27.82	29.00	1.312	0.02	0.018	0.023
	GSM1900	GPRS 2 Tx slots	Left Cheek	Full	661	1880	27.82	29.00	1.312	0.11	0.040	0.053
	GSM1900	GPRS 2 Tx slots	Left Tilted	Full	661	1880	27.82	29.00	1.312	0.04	0.020	0.027
	GSM1900	GPRS 2 Tx slots	Left Cheek	Full	512	1850.2	27.75	29.00	1.334	0.14	0.024	0.031
02	GSM1900	GPRS 2 Tx slots	Left Cheek	Full	810	1909.8	27.71	29.00	1.346	0.09	0.042	<b>0.056</b>

**<WCDMA SAR>**

Plot No.	Band	Mode	Test Position	Power Reduction	Ch.	Freq. (MHz)	Average Power (dBm)	Tune-Up Limit (dBm)	Tune-up Scaling Factor	Power Drift (dB)	Measured 1g SAR (W/kg)	Reported 1g SAR (W/kg)
03	WCDMA V	RMC 12.2Kbps	Right Cheek	Full	4233	846.6	23.29	24.00	1.178	-0.02	0.373	<b>0.439</b>
	WCDMA V	RMC 12.2Kbps	Right Tilted	Full	4233	846.6	23.29	24.00	1.178	0.12	0.177	0.208
	WCDMA V	RMC 12.2Kbps	Left Cheek	Full	4233	846.6	23.29	24.00	1.178	0.09	0.319	0.376
	WCDMA V	RMC 12.2Kbps	Left Tilted	Full	4233	846.6	23.29	24.00	1.178	0.11	0.166	0.195
	WCDMA V	RMC 12.2Kbps	Right Cheek	Full	4132	826.4	23.02	24.00	1.253	0.02	0.289	0.362
	WCDMA V	RMC 12.2Kbps	Right Cheek	Full	4182	836.4	23.03	24.00	1.250	-0.03	0.314	0.393
	WCDMA IV	RMC 12.2Kbps	Right Cheek	Full	1513	1752.6	22.79	24.00	1.321	0.11	0.106	0.140
	WCDMA IV	RMC 12.2Kbps	Right Tilted	Full	1513	1752.6	22.79	24.00	1.321	0.12	0.066	0.087
	WCDMA IV	RMC 12.2Kbps	Left Cheek	Full	1513	1752.6	22.79	24.00	1.321	0.13	0.108	0.143
	WCDMA IV	RMC 12.2Kbps	Left Tilted	Full	1513	1752.6	22.79	24.00	1.321	0.11	0.077	0.102
	WCDMA IV	RMC 12.2Kbps	Left Cheek	Full	1312	1712.4	22.75	24.00	1.334	0.09	0.084	0.112
04	WCDMA IV	RMC 12.2Kbps	Left Cheek	Full	1413	1732.6	22.58	24.00	1.387	-0.09	0.113	<b>0.157</b>
	WCDMA II	RMC 12.2Kbps	Right Cheek	Full	9400	1880	23.05	24.00	1.245	0.15	0.059	0.074
	WCDMA II	RMC 12.2Kbps	Right Tilted	Full	9400	1880	23.05	24.00	1.245	0.08	0.031	0.039
	WCDMA II	RMC 12.2Kbps	Left Cheek	Full	9400	1880	23.05	24.00	1.245	0.07	0.108	0.134
	WCDMA II	RMC 12.2Kbps	Left Tilted	Full	9400	1880	23.05	24.00	1.245	0.01	0.045	0.056
	WCDMA II	RMC 12.2Kbps	Left Cheek	Full	9262	1852.4	23.01	24.00	1.256	-0.14	0.073	0.092
05	WCDMA II	RMC 12.2Kbps	Left Cheek	Full	9538	1907.6	22.99	24.00	1.262	-0.02	0.136	<b>0.172</b>



<CDMA SAR>

Plot No.	Band	Mode	Test Position	Power Reduction	Ch.	Freq. (MHz)	Average Power (dBm)	Tune-Up Limit (dBm)	Tune-up Scaling Factor	Power Drift (dB)	Measured 1g SAR (W/kg)	Reported 1g SAR (W/kg)
06	CDMA2000 BC0	RC3 SO55	Right Cheek	Full	777	848.31	24.50	25.00	1.122	-0.17	0.297	<b>0.333</b>
	CDMA2000 BC0	RC3 SO55	Right Tilted	Full	777	848.31	24.50	25.00	1.122	-0.1	0.108	0.121
	CDMA2000 BC0	RC3 SO55	Left Cheek	Full	777	848.31	24.50	25.00	1.122	0.08	0.256	0.287
	CDMA2000 BC0	RC3 SO55	Left Tilted	Full	777	848.31	24.50	25.00	1.122	-0.03	0.119	0.134
	CDMA2000 BC0	RC3 SO55	Right Cheek	Full	1013	824.7	24.10	25.00	1.230	0.01	0.260	0.320
	CDMA2000 BC0	RC3 SO55	Right Cheek	Full	384	836.52	24.19	25.00	1.205	0.11	0.255	0.307
07	CDMA2000 BC10	RC3 SO55	Right Cheek	Full	580	820.5	24.11	25.00	1.227	-0.18	0.377	<b>0.463</b>
	CDMA2000 BC10	RC3 SO55	Right Tilted	Full	580	820.5	24.11	25.00	1.227	0.01	0.193	0.237
	CDMA2000 BC10	RC3 SO55	Left Cheek	Full	580	820.5	24.11	25.00	1.227	0.02	0.351	0.431
	CDMA2000 BC10	RC3 SO55	Left Tilted	Full	580	820.5	24.11	25.00	1.227	-0.14	0.207	0.254
	CDMA2000 BC10	RC3 SO55	Right Cheek	Full	476	817.9	23.65	25.00	1.365	0.08	0.316	0.431
	CDMA2000 BC10	RC3 SO55	Right Cheek	Full	684	823.1	24.02	25.00	1.253	0.11	0.308	0.386
	CDMA2000 BC1	RC3 SO55	Right Cheek	Full	600	1880	24.44	25.00	1.138	0.01	0.042	0.048
	CDMA2000 BC1	RC3 SO55	Right Tilted	Full	600	1880	24.44	25.00	1.138	-0.14	0.027	0.031
	CDMA2000 BC1	RC3 SO55	Left Cheek	Full	600	1880	24.44	25.00	1.138	0.09	0.076	0.086
	CDMA2000 BC1	RC3 SO55	Left Tilted	Full	600	1880	24.44	25.00	1.138	0.19	0.035	0.039
	CDMA2000 BC1	RC3 SO55	Left Cheek	Full	25	1851.25	24.23	25.00	1.194	0.15	0.057	0.067
08	CDMA2000 BC1	RC3 SO55	Left Cheek	Full	1175	1908.75	24.26	25.00	1.186	-0.07	0.093	<b>0.110</b>



<FDD LTE SAR>

Plot No.	Band	BW (MHz)	Modulation	RB Size	RB offset	Test Position	Power Reduction	Ch.	Freq. (MHz)	Average Power (dBm)	Tune-Up Limit (dBm)	Tune-up Scaling Factor	Power Drift (dB)	Measured 1g SAR (W/kg)	Reported 1g SAR (W/kg)
09	LTE Band 71	20M	QPSK	1	99	Right Cheek	Full	133322	683	22.70	24.00	1.349	-0.16	0.299	<b>0.403</b>
	LTE Band 71	20M	QPSK	1	99	Right Tilted	Full	133322	683	22.70	24.00	1.349	0.12	0.164	0.221
	LTE Band 71	20M	QPSK	1	99	Left Cheek	Full	133322	683	22.70	24.00	1.349	-0.03	0.277	0.374
	LTE Band 71	20M	QPSK	1	99	Left Tilted	Full	133322	683	22.70	24.00	1.349	0.09	0.138	0.186
	LTE Band 71	20M	QPSK	50	24	Right Cheek	Full	133322	683	21.65	23.00	1.365	0.02	0.149	0.203
	LTE Band 71	20M	QPSK	50	24	Right Tilted	Full	133322	683	21.65	23.00	1.365	0.09	0.078	0.106
	LTE Band 71	20M	QPSK	50	24	Left Cheek	Full	133322	683	21.65	23.00	1.365	-0.02	0.140	0.191
	LTE Band 71	20M	QPSK	50	24	Left Tilted	Full	133322	683	21.65	23.00	1.365	-0.04	0.071	0.096
10	LTE Band 12	10M	QPSK	1	0	Right Cheek	Full	23095	707.5	22.90	24.00	1.288	0.01	0.292	<b>0.376</b>
	LTE Band 12	10M	QPSK	1	0	Right Tilted	Full	23095	707.5	22.90	24.00	1.288	0.04	0.130	0.167
	LTE Band 12	10M	QPSK	1	0	Left Cheek	Full	23095	707.5	22.90	24.00	1.288	0.03	0.282	0.363
	LTE Band 12	10M	QPSK	1	0	Left Tilted	Full	23095	707.5	22.90	24.00	1.288	0.09	0.127	0.164
	LTE Band 12	10M	QPSK	25	0	Right Cheek	Full	23095	707.5	21.68	23.00	1.355	0.11	0.140	0.190
	LTE Band 12	10M	QPSK	25	0	Right Tilted	Full	23095	707.5	21.68	23.00	1.355	0.06	0.064	0.087
	LTE Band 12	10M	QPSK	25	0	Left Cheek	Full	23095	707.5	21.68	23.00	1.355	0.07	0.136	0.184
	LTE Band 12	10M	QPSK	25	0	Left Tilted	Full	23095	707.5	21.68	23.00	1.355	-0.12	0.066	0.089
11	LTE Band 13	10M	QPSK	1	0	Right Cheek	Full	23230	782	22.63	24.00	1.371	-0.12	0.325	<b>0.446</b>
	LTE Band 13	10M	QPSK	1	0	Right Tilted	Full	23230	782	22.63	24.00	1.371	0.11	0.124	0.170
	LTE Band 13	10M	QPSK	1	0	Left Cheek	Full	23230	782	22.63	24.00	1.371	0.09	0.292	0.400
	LTE Band 13	10M	QPSK	1	0	Left Tilted	Full	23230	782	22.63	24.00	1.371	0.03	0.128	0.175
	LTE Band 13	10M	QPSK	25	12	Right Cheek	Full	23230	782	21.48	23.00	1.419	-0.11	0.159	0.226
	LTE Band 13	10M	QPSK	25	12	Right Tilted	Full	23230	782	21.48	23.00	1.419	-0.09	0.066	0.094
	LTE Band 13	10M	QPSK	25	12	Left Cheek	Full	23230	782	21.48	23.00	1.419	0.12	0.138	0.196
	LTE Band 13	10M	QPSK	25	12	Left Tilted	Full	23230	782	21.48	23.00	1.419	0.15	0.068	0.096
12	LTE Band 14	10M	QPSK	1	49	Right Cheek	Full	23330	793	22.72	24.00	1.343	0.14	0.202	<b>0.271</b>
	LTE Band 14	10M	QPSK	1	49	Right Tilted	Full	23330	793	22.72	24.00	1.343	0.16	0.095	0.127
	LTE Band 14	10M	QPSK	1	49	Left Cheek	Full	23330	793	22.72	24.00	1.343	0.19	0.192	0.258
	LTE Band 14	10M	QPSK	1	49	Left Tilted	Full	23330	793	22.72	24.00	1.343	0.11	0.093	0.125
	LTE Band 14	10M	QPSK	25	12	Right Cheek	Full	23330	793	21.47	23.00	1.422	-0.06	0.136	0.193
	LTE Band 14	10M	QPSK	25	12	Right Tilted	Full	23330	793	21.47	23.00	1.422	0.04	0.059	0.084
	LTE Band 14	10M	QPSK	25	12	Left Cheek	Full	23330	793	21.47	23.00	1.422	0.14	0.125	0.178
	LTE Band 14	10M	QPSK	25	12	Left Tilted	Full	23330	793	21.47	23.00	1.422	-0.12	0.061	0.087
13	LTE Band 5	10M	QPSK	1	49	Right Cheek	Full	20525	836.5	23.11	24.00	1.227	-0.12	0.315	<b>0.387</b>
	LTE Band 5	10M	QPSK	1	49	Right Tilted	Full	20525	836.5	23.11	24.00	1.227	0.11	0.152	0.187
	LTE Band 5	10M	QPSK	1	49	Left Cheek	Full	20525	836.5	23.11	24.00	1.227	0.14	0.289	0.355
	LTE Band 5	10M	QPSK	1	49	Left Tilted	Full	20525	836.5	23.11	24.00	1.227	0.15	0.130	0.160
	LTE Band 5	10M	QPSK	25	25	Right Cheek	Full	20525	836.5	21.90	23.00	1.288	0.17	0.164	0.211
	LTE Band 5	10M	QPSK	25	25	Right Tilted	Full	20525	836.5	21.90	23.00	1.288	0.07	0.076	0.097
	LTE Band 5	10M	QPSK	25	25	Left Cheek	Full	20525	836.5	21.90	23.00	1.288	0.02	0.149	0.192
	LTE Band 5	10M	QPSK	25	25	Left Tilted	Full	20525	836.5	21.90	23.00	1.288	0.02	0.069	0.089





Plot No.	Band	BW (MHz)	Modulation	RB Size	RB offset	Test Position	Power Reduction	Ch.	Freq. (MHz)	Average Power (dBm)	Tune-Up Limit (dBm)	Tune-up Scaling Factor	Power Drift (dB)	Measured 1g SAR (W/kg)	Reported 1g SAR (W/kg)
	LTE Band 26	15M	QPSK	1	74	Right Cheek	Full	26865	831.5	23.08	24.00	1.236	0.02	0.277	0.342
	LTE Band 26	15M	QPSK	1	74	Right Tilted	Full	26865	831.5	23.08	24.00	1.236	0.13	0.079	0.098
	LTE Band 26	15M	QPSK	1	74	Left Cheek	Full	26865	831.5	23.08	24.00	1.236	0.11	0.172	0.213
	LTE Band 26	15M	QPSK	1	74	Left Tilted	Full	26865	831.5	23.08	24.00	1.236	0.14	0.071	0.088
14	LTE Band 26	15M	QPSK	1	74	Right Cheek	Full	26765	821.5	23.05	24.00	1.245	0.04	0.285	<b>0.355</b>
	LTE Band 26	15M	QPSK	1	74	Right Cheek	Full	26965	841.5	23.07	24.00	1.239	0.15	0.270	0.334
	LTE Band 26	15M	QPSK	36	0	Right Cheek	Full	26865	831.5	21.75	23.00	1.334	0.02	0.130	0.173
	LTE Band 26	15M	QPSK	36	0	Right Tilted	Full	26865	831.5	21.75	23.00	1.334	0.04	0.068	0.091
	LTE Band 26	15M	QPSK	36	0	Left Cheek	Full	26865	831.5	21.75	23.00	1.334	0.01	0.092	0.122
	LTE Band 26	15M	QPSK	36	0	Left Tilted	Full	26865	831.5	21.75	23.00	1.334	0.06	0.055	0.074
	LTE Band 25	20M	QPSK	1	0	Right Cheek	Full	26590	1905	22.93	24.00	1.279	0.02	0.049	0.063
	LTE Band 25	20M	QPSK	1	0	Right Tilted	Full	26590	1905	22.93	24.00	1.279	0.11	0.036	0.046
15	LTE Band 25	20M	QPSK	1	0	Left Cheek	Full	26590	1905	22.93	24.00	1.279	-0.13	0.096	<b>0.123</b>
	LTE Band 25	20M	QPSK	1	0	Left Tilted	Full	26590	1905	22.93	24.00	1.279	0.15	0.036	0.046
	LTE Band 25	20M	QPSK	1	0	Left Cheek	Full	26140	1860	22.80	24.00	1.318	0.02	0.062	0.081
	LTE Band 25	20M	QPSK	1	0	Left Cheek	Full	26340	1880	22.76	24.00	1.330	0.16	0.075	0.100
	LTE Band 25	20M	QPSK	50	0	Right Cheek	Full	26590	1905	21.86	23.00	1.300	0.15	0.031	0.041
	LTE Band 25	20M	QPSK	50	0	Right Tilted	Full	26590	1905	21.86	23.00	1.300	0.15	0.021	0.027
	LTE Band 25	20M	QPSK	50	0	Left Cheek	Full	26590	1905	21.86	23.00	1.300	0.13	0.061	0.079
	LTE Band 25	20M	QPSK	50	0	Left Tilted	Full	26590	1905	21.86	23.00	1.300	0.17	0.022	0.028
	LTE Band 66	20M	QPSK	1	99	Right Cheek	Full	132572	1770	23.36	24.00	1.159	0.04	0.089	0.103
	LTE Band 66	20M	QPSK	1	99	Right Tilted	Full	132572	1770	23.36	24.00	1.159	0.15	0.041	0.048
	LTE Band 66	20M	QPSK	1	99	Left Cheek	Full	132572	1770	23.36	24.00	1.159	0.16	0.090	0.105
	LTE Band 66	20M	QPSK	1	99	Left Tilted	Full	132572	1770	23.36	24.00	1.159	0.15	0.055	0.064
	LTE Band 66	20M	QPSK	1	99	Left Cheek	Full	132072	1720	22.73	24.00	1.340	0.13	0.087	0.116
16	LTE Band 66	20M	QPSK	1	99	Left Cheek	Full	132322	1745	23.08	24.00	1.236	-0.13	0.105	<b>0.130</b>
	LTE Band 66	20M	QPSK	50	50	Right Cheek	Full	132572	1770	22.08	23.00	1.236	0.11	0.047	0.058
	LTE Band 66	20M	QPSK	50	50	Right Tilted	Full	132572	1770	22.08	23.00	1.236	0.12	0.027	0.034
	LTE Band 66	20M	QPSK	50	50	Left Cheek	Full	132572	1770	22.08	23.00	1.236	0.16	0.059	0.073
	LTE Band 66	20M	QPSK	50	50	Left Tilted	Full	132572	1770	22.08	23.00	1.236	0.17	0.044	0.055
	LTE Band 7	20M	QPSK	1	99	Right Cheek	Full	21350	2560	23.46	24.00	1.132	0.05	0.300	0.340
	LTE Band 7	20M	QPSK	1	99	Right Tilted	Full	21350	2560	23.46	24.00	1.132	0.13	0.242	0.274
	LTE Band 7	20M	QPSK	1	99	Left Cheek	Full	21350	2560	23.46	24.00	1.132	0.11	0.430	0.487
	LTE Band 7	20M	QPSK	1	99	Left Tilted	Full	21350	2560	23.46	24.00	1.132	0.14	0.150	0.170
	LTE Band 7	20M	QPSK	1	99	Left Cheek	Full	20850	2510	23.06	24.00	1.242	0.16	0.539	0.669
17	LTE Band 7	20M	QPSK	1	99	Left Cheek	Full	21100	2535	23.25	24.00	1.189	0.12	0.579	<b>0.688</b>
	LTE Band 7	20M	QPSK	50	50	Right Cheek	Full	21350	2560	22.42	23.00	1.143	0.05	0.223	0.255
	LTE Band 7	20M	QPSK	50	50	Right Tilted	Full	21350	2560	22.42	23.00	1.143	0.15	0.176	0.201
	LTE Band 7	20M	QPSK	50	50	Left Cheek	Full	21350	2560	22.42	23.00	1.143	0.03	0.319	0.365
	LTE Band 7	20M	QPSK	50	50	Left Tilted	Full	21350	2560	22.42	23.00	1.143	0.04	0.111	0.127
	LTE Band 30	10M	QPSK	1	0	Right Cheek	Full	27710	2310	22.92	24.00	1.282	0.12	0.240	0.308
	LTE Band 30	10M	QPSK	1	0	Right Tilted	Full	27710	2310	22.92	24.00	1.282	0.06	0.218	0.280
18	LTE Band 30	10M	QPSK	1	0	Left Cheek	Full	27710	2310	22.92	24.00	1.282	0.15	0.401	<b>0.514</b>
	LTE Band 30	10M	QPSK	1	0	Left Tilted	Full	27710	2310	22.92	24.00	1.282	0.07	0.160	0.205
	LTE Band 30	10M	QPSK	25	25	Right Cheek	Full	27710	2310	21.79	23.00	1.321	0.04	0.151	0.200
	LTE Band 30	10M	QPSK	25	25	Right Tilted	Full	27710	2310	21.79	23.00	1.321	0.13	0.132	0.174
	LTE Band 30	10M	QPSK	25	25	Left Cheek	Full	27710	2310	21.79	23.00	1.321	-0.09	0.248	0.328
	LTE Band 30	10M	QPSK	25	25	Left Tilted	Full	27710	2310	21.79	23.00	1.321	0.1	0.097	0.128



<TDD LTE SAR>

Plot No.	Band	BW (MHz)	Modulation	RB Size	RB offset	Test Position	Power Reduction	Ch.	Freq. (MHz)	Average Power (dBm)	Tune-Up Limit (dBm)	Tune-up Scaling Factor	Duty Cycle %	Duty Cycle Scaling Factor	Power Drift (dB)	Measured 1g SAR (W/kg)	Reported 1g SAR (W/kg)
	LTE Band 41	20M	QPSK	1	49	Right Cheek	Full	41490	2680	24.02	25.00	1.253	62.9	1.006	0.02	0.277	0.349
	LTE Band 41	20M	QPSK	1	49	Right Tilted	Full	41490	2680	24.02	25.00	1.253	62.9	1.006	0.04	0.267	0.337
	LTE Band 41	20M	QPSK	1	49	Left Cheek	Full	41490	2680	24.02	25.00	1.253	62.9	1.006	0.11	0.477	0.601
	LTE Band 41C	20M	QPSK	1	49	Left Cheek	Full	39750(pcc)+39948(scc)	2506(pcc)+2525.8(scc)	23.73	25.00	1.340	62.9	1.006	-0.04	0.376	0.507
	LTE Band 41C	20M	QPSK	1	49	Left Cheek	Full	40185(pcc)+39987(scc)	2549.5(pcc)+2529.7(scc)	23.31	25.00	1.476	62.9	1.006	0.07	0.339	0.503
	LTE Band 41C	20M	QPSK	1	49	Left Cheek	Full	40620(pcc)+40422(scc)	2593(pcc)+2573.2(scc)	23.21	25.00	1.510	62.9	1.006	0.09	0.359	0.545
	LTE Band 41C	20M	QPSK	1	49	Left Cheek	Full	41055(pcc)+40857(scc)	2636.5(pcc)+2616.7(scc)	23.18	25.00	1.521	62.9	1.006	0.07	0.389	0.595
	LTE Band 41C	20M	QPSK	1	49	Left Cheek	Full	41490(pcc)+41292(scc)	2682(pcc)+2660.2(scc)	23.25	25.00	1.496	62.9	1.006	0.02	0.395	0.595
19	LTE Band 41-HPUE	20M	QPSK	1	49	Left Cheek	Full	41490	2680	25.61	27.00	1.377	42.9	1.009	0.04	0.468	<b>0.650</b>
	LTE Band 41	20M	QPSK	1	49	Left Tilted	Full	41490	2680	24.02	25.00	1.253	62.9	1.006	0.01	0.157	0.198
	LTE Band 41	20M	QPSK	1	49	Left Cheek	Full	39750	2506	23.81	25.00	1.315	62.9	1.006	-0.07	0.358	0.474
	LTE Band 41	20M	QPSK	1	49	Left Cheek	Full	40185	2549.5	23.92	25.00	1.282	62.9	1.006	-0.13	0.387	0.499
	LTE Band 41	20M	QPSK	1	49	Left Cheek	Full	40620	2593	23.66	25.00	1.361	62.9	1.006	-0.17	0.384	0.526
	LTE Band 41	20M	QPSK	1	49	Left Cheek	Full	41055	2636.5	23.82	25.00	1.312	62.9	1.006	-0.03	0.429	0.566
	LTE Band 41	20M	QPSK	50	24	Right Cheek	Full	41490	2680	23.06	24.00	1.242	62.9	1.006	0.08	0.183	0.229
	LTE Band 41	20M	QPSK	50	24	Right Tilted	Full	41490	2680	23.06	24.00	1.242	62.9	1.006	0.04	0.175	0.219
	LTE Band 41	20M	QPSK	50	24	Left Cheek	Full	41490	2680	23.06	24.00	1.242	62.9	1.006	0.03	0.279	0.348
	LTE Band 41	20M	QPSK	50	24	Left Tilted	Full	41490	2680	23.06	24.00	1.242	62.9	1.006	-0.02	0.104	0.130
	LTE Band 41	20M	QPSK	100	0	Left Cheek	Full	41490	2680	23.02	24.00	1.253	62.9	1.006	0.11	0.224	0.282



<Bluetooth SAR>

Plot No.	Band	Mode	Test Position	Ch.	Freq. (MHz)	Average Power (dBm)	Tune-Up Limit (dBm)	Tune-up Scaling Factor	Duty Cycle %	Duty Cycle Scaling Factor	Power Drift (dB)	Measured 1g SAR (W/kg)	Reported 1g SAR (W/kg)
	Bluetooth	DH5 1Mbps	Right Cheek	39	2441	9.31	10.00	1.172	77.03	1.081	-0.02	0.034	0.043
	Bluetooth	DH5 1Mbps	Right Tilted	39	2441	9.31	10.00	1.172	77.03	1.081	0.07	0.040	0.051
	Bluetooth	DH5 1Mbps	Left Cheek	39	2441	9.31	10.00	1.172	77.03	1.081	0.03	0.078	0.099
	Bluetooth	DH5 1Mbps	Left Tilted	39	2441	9.31	10.00	1.172	77.03	1.081	-0.18	0.062	0.079
20	Bluetooth	DH5 1Mbps	Left Cheek	0	2402	8.32	10.00	1.473	77.03	1.081	-0.02	0.071	<b>0.113</b>
	Bluetooth	DH5 1Mbps	Left Cheek	78	2480	9.19	10.00	1.205	77.03	1.081	-0.04	0.069	0.090

<WLAN2.4G SAR>

Plot No.	Band	Mode	Test Position	Power Reduction	Ch.	Freq. (MHz)	Average Power (dBm)	Tune-Up Limit (dBm)	Tune-up Scaling Factor	Duty Cycle %	Duty Cycle Scaling Factor	Power Drift (dB)	Measured 1g SAR (W/kg)	Reported 1g SAR (W/kg)
	WLAN2.4GHz	802.11b 1Mbps	Right Cheek	Reduced	11	2462	18.31	20.00	1.476	100	1.000	0.06	0.370	0.546
	WLAN2.4GHz	802.11b 1Mbps	Right Tilted	Reduced	11	2462	18.31	20.00	1.476	100	1.000	0.06	0.397	0.586
21	WLAN2.4GHz	802.11b 1Mbps	Left Cheek	Reduced	11	2462	18.31	20.00	1.476	100	1.000	0.05	0.740	<b>1.092</b>
	WLAN2.4GHz	802.11b 1Mbps	Left Tilted	Reduced	11	2462	18.31	20.00	1.476	100	1.000	-0.03	0.721	1.064
	WLAN2.4GHz	802.11b 1Mbps	Left Tilted	Reduced	1	2412	18.26	20.00	1.493	100	1.000	0.15	0.726	1.084
	WLAN2.4GHz	802.11b 1Mbps	Left Tilted	Reduced	6	2437	18.21	20.00	1.510	100	1.000	-0.03	0.556	0.840
	WLAN2.4GHz	802.11b 1Mbps	Left Cheek	Reduced	1	2412	18.26	20.00	1.493	100	1.000	0.07	0.730	1.090
	WLAN2.4GHz	802.11b 1Mbps	Left Cheek	Reduced	6	2437	18.21	20.00	1.510	100	1.000	-0.07	0.689	1.040

<WLAN5G SAR>

Plot No.	Band	Mode	Test Position	Power Reduction	Ch.	Freq. (MHz)	Average Power (dBm)	Tune-Up Limit (dBm)	Tune-up Scaling Factor	Duty Cycle %	Duty Cycle Scaling Factor	Power Drift (dB)	Measured 1g SAR (W/kg)	Reported 1g SAR (W/kg)
	WLAN5.3GHz	802.11a 6Mbps	Right Cheek	Full	60	5300	17.91	19.50	1.444	98.28	1.018	-0.19	0.044	0.065
	WLAN5.3GHz	802.11a 6Mbps	Right Tilted	Full	60	5300	17.91	19.50	1.444	98.28	1.018	-0.03	0.068	0.100
	WLAN5.3GHz	802.11a 6Mbps	Left Cheek	Full	60	5300	17.91	19.50	1.444	98.28	1.018	-0.14	0.059	0.087
22	WLAN5.3GHz	802.11a 6Mbps	Left Tilted	Full	60	5300	17.91	19.50	1.444	98.28	1.018	0.13	0.076	<b>0.112</b>
	WLAN5.3GHz	802.11a 6Mbps	Left Tilted	Full	52	5260	17.80	19.50	1.481	98.28	1.018	0.09	0.063	0.095
	WLAN5.3GHz	802.11a 6Mbps	Left Tilted	Full	56	5280	17.84	19.50	1.467	98.28	1.018	-0.08	0.065	0.097
	WLAN5.3GHz	802.11a 6Mbps	Left Tilted	Full	64	5320	17.86	19.50	1.460	98.28	1.018	0.02	0.068	0.101
	WLAN5.5GHz	802.11a 6Mbps	Right Cheek	Full	132	5660	18.17	19.50	1.360	98.28	1.018	0.09	0.025	0.035
	WLAN5.5GHz	802.11a 6Mbps	Right Tilted	Full	132	5660	18.17	19.50	1.360	98.28	1.018	0.06	0.026	0.036
	WLAN5.5GHz	802.11a 6Mbps	Left Cheek	Full	132	5660	18.17	19.50	1.360	98.28	1.018	0.02	0.063	0.087
	WLAN5.5GHz	802.11a 6Mbps	Left Tilted	Full	132	5660	18.17	19.50	1.360	98.28	1.018	-0.09	0.062	0.086
	WLAN5.5GHz	802.11a 6Mbps	Left Cheek	Full	100	5500	17.91	19.50	1.444	98.28	1.018	-0.06	0.044	0.065
	WLAN5.5GHz	802.11a 6Mbps	Left Cheek	Full	116	5580	17.94	19.50	1.434	98.28	1.018	0.11	0.044	0.064
23	WLAN5.5GHz	802.11a 6Mbps	Left Cheek	Full	140	5700	18.10	19.50	1.382	98.28	1.018	0.09	0.064	<b>0.090</b>
	WLAN5.8GHz	802.11a 6Mbps	Right Cheek	Full	149	5745	15.87	17.50	1.457	98.28	1.018	0.03	0.017	0.026
	WLAN5.8GHz	802.11a 6Mbps	Right Tilted	Full	149	5745	15.87	17.50	1.457	98.28	1.018	0.02	0.021	0.032
	WLAN5.8GHz	802.11a 6Mbps	Left Cheek	Full	149	5745	15.87	17.50	1.457	98.28	1.018	0.09	0.019	0.028
	WLAN5.8GHz	802.11a 6Mbps	Left Tilted	Full	149	5745	15.87	17.50	1.457	98.28	1.018	0.11	0.023	0.034
	WLAN5.8GHz	802.11a 6Mbps	Left Tilted	Full	157	5785	15.44	16.50	1.278	98.28	1.018	-0.06	0.028	0.037
24	WLAN5.8GHz	802.11a 6Mbps	Left Tilted	Full	165	5825	15.24	16.50	1.338	98.28	1.018	-0.03	0.029	<b>0.039</b>



15.2 Hotspot SAR

<GSM SAR>

Plot No.	Band	Mode	Test Position	Gap (mm)	Power Reduction	Ch.	Freq. (MHz)	Average Power (dBm)	Tune-Up Limit (dBm)	Tune-up Scaling Factor	Power Drift (dB)	Measured 1g SAR (W/kg)	Reported 1g SAR (W/kg)
	GSM850	GPRS 2 Tx slots	Front	5mm	Full	189	836.4	30.40	31.50	1.288	0.14	0.985	1.269
	GSM850	GPRS 2 Tx slots	Front	5mm	Full	128	824.2	30.32	31.50	1.312	0.12	0.857	1.125
	GSM850	GPRS 2 Tx slots	Front	5mm	Full	251	848.8	30.02	31.50	1.406	0.03	0.901	1.267
25	GSM850	GPRS 2 Tx slots	Back	5mm	Full	189	836.4	30.40	31.50	1.288	-0.15	1.070	1.378
	GSM850	GPRS 2 Tx slots	Back	5mm	Full	128	824.2	30.32	31.50	1.312	-0.16	0.884	1.160
	GSM850	GPRS 2 Tx slots	Back	5mm	Full	251	848.8	30.02	31.50	1.406	-0.07	0.969	1.362
	GSM850	GPRS 2 Tx slots	Left Side	5mm	Full	189	836.4	30.40	31.50	1.288	0.02	0.290	0.374
	GSM850	GPRS 2 Tx slots	Right Side	5mm	Full	189	836.4	30.40	31.50	1.288	0.14	0.518	0.667
	GSM850	GPRS 2 Tx slots	Bottom Side	5mm	Full	189	836.4	30.40	31.50	1.288	0.15	0.813	1.047
	GSM850	GPRS 2 Tx slots	Bottom Side	5mm	Full	128	824.2	30.32	31.50	1.312	-0.04	0.603	0.791
	GSM850	GPRS 2 Tx slots	Bottom Side	5mm	Full	251	848.8	30.02	31.50	1.406	0.02	0.689	0.969
	GSM1900	GPRS 2 Tx slots	Front	5mm	Reduced	661	1880	21.05	22.50	1.396	-0.18	0.972	1.357
	GSM1900	GPRS 2 Tx slots	Front	5mm	Reduced	512	1850.2	20.98	22.50	1.419	0.02	0.947	1.344
	GSM1900	GPRS 2 Tx slots	Front	5mm	Reduced	810	1909.8	20.94	22.50	1.432	-0.19	0.920	1.318
	GSM1900	GPRS 2 Tx slots	Back	5mm	Reduced	661	1880	21.05	22.50	1.396	-0.09	0.905	1.264
	GSM1900	GPRS 2 Tx slots	Back	5mm	Reduced	512	1850.2	20.98	22.50	1.419	-0.07	0.812	1.152
	GSM1900	GPRS 2 Tx slots	Back	5mm	Reduced	810	1909.8	20.94	22.50	1.432	-0.03	0.828	1.186
	GSM1900	GPRS 2 Tx slots	Left Side	5mm	Reduced	661	1880	20.15	21.00	1.216	0.01	0.019	0.024
	GSM1900	GPRS 2 Tx slots	Right Side	5mm	Reduced	661	1880	20.15	21.00	1.216	0.06	0.014	0.017
	GSM1900	GPRS 2 Tx slots	Bottom Side	5mm	Reduced	661	1880	20.15	21.00	1.216	-0.04	1.170	1.423
	GSM1900	GPRS 2 Tx slots	Bottom Side	5mm	Reduced	512	1850.2	19.71	21.00	1.346	-0.04	1.050	1.413
26	GSM1900	GPRS 2 Tx slots	Bottom Side	5mm	Reduced	810	1909.8	19.77	21.00	1.327	-0.05	1.080	1.434



<WCDMA SAR>

Plot No.	Band	Mode	Test Position	Gap (mm)	Power Reduction	Ch.	Freq. (MHz)	Average Power (dBm)	Tune-Up Limit (dBm)	Tune-up Scaling Factor	Power Drift (dB)	Measured 1g SAR (W/kg)	Reported 1g SAR (W/kg)
	WCDMA V	RMC 12.2Kbps	Front	5mm	Reduced	4233	846.6	22.15	23.00	1.216	-0.05	1.070	1.301
	WCDMA V	RMC 12.2Kbps	Front	5mm	Reduced	4132	826.4	21.88	23.00	1.294	-0.02	0.823	1.065
	WCDMA V	RMC 12.2Kbps	Front	5mm	Reduced	4182	836.4	21.89	23.00	1.291	-0.05	0.923	1.192
27	WCDMA V	RMC 12.2Kbps	Back	5mm	Reduced	4233	846.6	22.15	23.00	1.216	-0.13	1.110	1.350
	WCDMA V	RMC 12.2Kbps	Back	5mm	Reduced	4132	826.4	21.88	23.00	1.294	-0.04	0.836	1.082
	WCDMA V	RMC 12.2Kbps	Back	5mm	Reduced	4182	836.4	21.89	23.00	1.291	-0.07	0.985	1.272
	WCDMA V	RMC 12.2Kbps	Left Side	5mm	Reduced	4233	846.6	22.15	23.00	1.216	-0.04	0.290	0.353
	WCDMA V	RMC 12.2Kbps	Right Side	5mm	Reduced	4233	846.6	22.15	23.00	1.216	-0.05	0.486	0.591
	WCDMA V	RMC 12.2Kbps	Bottom Side	5mm	Reduced	4233	846.6	22.15	23.00	1.216	-0.03	1.000	1.216
	WCDMA V	RMC 12.2Kbps	Bottom Side	5mm	Reduced	4182	836.4	21.89	23.00	1.291	0.03	0.838	1.082
	WCDMA V	RMC 12.2Kbps	Bottom Side	5mm	Reduced	4132	826.4	21.88	23.00	1.294	-0.06	0.810	1.048
28	WCDMA IV	RMC 12.2Kbps	Front	5mm	Reduced	1513	1752.6	14.09	15.50	1.384	-0.09	1.000	1.384
	WCDMA IV	RMC 12.2Kbps	Front	5mm	Reduced	1312	1712.4	14.05	15.50	1.396	-0.09	0.839	1.172
	WCDMA IV	RMC 12.2Kbps	Front	5mm	Reduced	1413	1732.6	13.88	15.50	1.452	-0.08	0.923	1.340
	WCDMA IV	RMC 12.2Kbps	Back	5mm	Reduced	1513	1752.6	14.09	15.50	1.384	-0.06	0.884	1.223
	WCDMA IV	RMC 12.2Kbps	Back	5mm	Reduced	1312	1712.4	14.05	15.50	1.396	0.01	0.689	0.962
	WCDMA IV	RMC 12.2Kbps	Back	5mm	Reduced	1413	1732.6	13.88	15.50	1.452	0.06	0.783	1.137
	WCDMA IV	RMC 12.2Kbps	Left Side	5mm	Reduced	1513	1752.6	12.63	14.00	1.371	-0.04	0.021	0.029
	WCDMA IV	RMC 12.2Kbps	Right Side	5mm	Reduced	1513	1752.6	12.63	14.00	1.371	-0.04	0.017	0.023
	WCDMA IV	RMC 12.2Kbps	Bottom Side	5mm	Reduced	1513	1752.6	12.63	14.00	1.371	0.06	0.743	1.019
	WCDMA IV	RMC 12.2Kbps	Bottom Side	5mm	Reduced	1312	1712.4	12.59	14.00	1.384	-0.05	0.717	0.992
	WCDMA IV	RMC 12.2Kbps	Bottom Side	5mm	Reduced	1413	1732.6	12.42	14.00	1.439	0.03	0.679	0.977
	WCDMA II	RMC 12.2Kbps	Front	5mm	Reduced	9400	1880	14.45	15.50	1.274	0.05	1.082	1.378
	WCDMA II	RMC 12.2Kbps	Front	5mm	Reduced	9262	1852.4	14.31	15.50	1.315	0.03	0.894	1.176
29	WCDMA II	RMC 12.2Kbps	Front	5mm	Reduced	9538	1907.6	14.42	15.50	1.282	-0.07	1.110	1.423
	WCDMA II	RMC 12.2Kbps	Back	5mm	Reduced	9400	1880	14.45	15.50	1.274	0.1	1.040	1.324
	WCDMA II	RMC 12.2Kbps	Back	5mm	Reduced	9262	1852.4	14.31	15.50	1.315	0.02	0.880	1.157
	WCDMA II	RMC 12.2Kbps	Back	5mm	Reduced	9538	1907.6	14.42	15.50	1.282	-0.05	1.070	1.372
	WCDMA II	RMC 12.2Kbps	Left Side	5mm	Reduced	9400	1880	12.70	14.00	1.349	0.04	0.013	0.018
	WCDMA II	RMC 12.2Kbps	Right Side	5mm	Reduced	9400	1880	12.70	14.00	1.349	0.01	0.010	0.013
	WCDMA II	RMC 12.2Kbps	Bottom Side	5mm	Reduced	9400	1880	12.70	14.00	1.349	-0.05	0.740	0.998
	WCDMA II	RMC 12.2Kbps	Bottom Side	5mm	Reduced	9262	1852.4	12.66	14.00	1.361	0.02	0.583	0.794
	WCDMA II	RMC 12.2Kbps	Bottom Side	5mm	Reduced	9538	1907.6	12.64	14.00	1.368	-0.05	0.940	1.286



<CDMA SAR>

Plot No.	Band	Mode	Test Position	Gap (mm)	Power Reduction	Ch.	Freq. (MHz)	Average Power (dBm)	Tune-Up Limit (dBm)	Tune-up Scaling Factor	Power Drift (dB)	Measured 1g SAR (W/kg)	Reported 1g SAR (W/kg)
	CDMA2000 BC0	RTAP 153.6Kbps	Front	5mm	Full	777	848.31	24.25	25.00	1.189	-0.19	1.020	1.212
	CDMA2000 BC0	RTAP 153.6Kbps	Front	5mm	Full	1013	824.7	23.85	25.00	1.303	-0.06	0.813	1.059
	CDMA2000 BC0	RTAP 153.6Kbps	Front	5mm	Full	384	836.52	23.94	25.00	1.276	-0.02	0.783	0.999
30	CDMA2000 BC0	RTAP 153.6Kbps	Back	5mm	Full	777	848.31	24.25	25.00	1.189	-0.19	1.100	1.307
	CDMA2000 BC0	RTAP 153.6Kbps	Back	5mm	Full	1013	824.7	23.85	25.00	1.303	-0.03	0.814	1.061
	CDMA2000 BC0	RTAP 153.6Kbps	Back	5mm	Full	384	836.52	23.94	25.00	1.276	-0.06	0.784	1.001
	CDMA2000 BC0	RTAP 153.6Kbps	Left Side	5mm	Full	777	848.31	24.25	25.00	1.189	0.08	0.233	0.277
	CDMA2000 BC0	RTAP 153.6Kbps	Right Side	5mm	Full	777	848.31	24.25	25.00	1.189	0.09	0.436	0.518
	CDMA2000 BC0	RTAP 153.6Kbps	Bottom Side	5mm	Full	777	848.31	24.25	25.00	1.189	-0.03	0.854	1.015
	CDMA2000 BC0	RTAP 153.6Kbps	Bottom Side	5mm	Full	1013	824.7	23.85	25.00	1.303	-0.07	0.729	0.950
	CDMA2000 BC0	RTAP 153.6Kbps	Bottom Side	5mm	Full	384	836.52	23.94	25.00	1.276	-0.07	0.761	0.971
	CDMA2000 BC10	RTAP 153.6Kbps	Front	5mm	Full	580	820.5	24.14	25.00	1.219	-0.05	0.811	0.989
	CDMA2000 BC10	RTAP 153.6Kbps	Front	5mm	Full	476	817.9	24.12	25.00	1.225	-0.05	0.725	0.888
	CDMA2000 BC10	RTAP 153.6Kbps	Front	5mm	Full	684	823.1	24.08	25.00	1.236	0.07	0.799	0.988
31	CDMA2000 BC10	RTAP 153.6Kbps	Back	5mm	Full	580	820.5	24.14	25.00	1.219	0.04	0.877	1.069
	CDMA2000 BC10	RTAP 153.6Kbps	Back	5mm	Full	476	817.9	24.12	25.00	1.225	0.19	0.865	1.059
	CDMA2000 BC10	RTAP 153.6Kbps	Back	5mm	Full	684	823.1	24.08	25.00	1.236	-0.12	0.706	0.873
	CDMA2000 BC10	RTAP 153.6Kbps	Left Side	5mm	Full	580	820.5	24.14	25.00	1.219	-0.08	0.315	0.384
	CDMA2000 BC10	RTAP 153.6Kbps	Right Side	5mm	Full	580	820.5	24.14	25.00	1.219	0.16	0.494	0.602
	CDMA2000 BC10	RTAP 153.6Kbps	Bottom Side	5mm	Full	580	820.5	24.14	25.00	1.219	0.03	0.676	0.824
	CDMA2000 BC10	RTAP 153.6Kbps	Bottom Side	5mm	Full	476	817.9	24.12	25.00	1.225	0.06	0.660	0.808
	CDMA2000 BC10	RTAP 153.6Kbps	Bottom Side	5mm	Full	684	823.1	24.08	25.00	1.236	0.04	0.709	0.876
	CDMA2000 BC1	RTAP 153.6Kbps	Front	5mm	Reduced	600	1880	14.04	15.50	1.400	-0.03	0.505	0.707
	CDMA2000 BC1	RTAP 153.6Kbps	Back	5mm	Reduced	600	1880	14.04	15.50	1.400	-0.01	0.418	0.585
	CDMA2000 BC1	RTAP 153.6Kbps	Left Side	5mm	Reduced	600	1880	14.04	15.50	1.400	0.02	0.015	0.021
	CDMA2000 BC1	RTAP 153.6Kbps	Right Side	5mm	Reduced	600	1880	14.04	15.50	1.400	0.06	0.014	0.020
32	CDMA2000 BC1	RTAP 153.6Kbps	Bottom Side	5mm	Reduced	600	1880	14.04	15.50	1.400	-0.01	0.795	1.113
	CDMA2000 BC1	RTAP 153.6Kbps	Bottom Side	5mm	Reduced	25	1851.25	13.95	15.50	1.429	0.01	0.574	0.820
	CDMA2000 BC1	RTAP 153.6Kbps	Bottom Side	5mm	Reduced	1175	1908.75	13.92	15.50	1.439	-0.05	0.665	0.957



<FDD LTE SAR>

Plot No.	Band	BW (MHz)	Modulation	RB Size	RB offset	Test Position	Gap (mm)	Power Reduction	Ch.	Freq. (MHz)	Average Power (dBm)	Tune-Up Limit (dBm)	Tune-up Scaling Factor	Power Drift (dB)	Measured 1g SAR (W/kg)	Reported 1g SAR (W/kg)
	LTE Band 71	20M	QPSK	1	99	Front	5mm	Full	133322	683	22.70	24.00	1.349	-0.05	0.607	0.819
33	LTE Band 71	20M	QPSK	1	99	Back	5mm	Full	133322	683	22.70	24.00	1.349	0.07	0.741	1.000
	LTE Band 71	20M	QPSK	1	99	Left Side	5mm	Full	133322	683	22.70	24.00	1.349	0.12	0.412	0.556
	LTE Band 71	20M	QPSK	1	99	Right Side	5mm	Full	133322	683	22.70	24.00	1.349	-0.01	0.526	0.710
	LTE Band 71	20M	QPSK	1	99	Bottom Side	5mm	Full	133322	683	22.70	24.00	1.349	-0.02	0.485	0.654
	LTE Band 71	20M	QPSK	50	24	Front	5mm	Full	133322	683	21.65	23.00	1.365	-0.02	0.344	0.469
	LTE Band 71	20M	QPSK	50	24	Back	5mm	Full	133322	683	21.65	23.00	1.365	0.14	0.384	0.524
	LTE Band 71	20M	QPSK	50	24	Left Side	5mm	Full	133322	683	21.65	23.00	1.365	-0.08	0.226	0.308
	LTE Band 71	20M	QPSK	50	24	Right Side	5mm	Full	133322	683	21.65	23.00	1.365	-0.09	0.278	0.379
	LTE Band 71	20M	QPSK	50	24	Bottom Side	5mm	Full	133322	683	21.65	23.00	1.365	-0.08	0.257	0.351
	LTE Band 71	20M	QPSK	100	0	Front	5mm	Full	133322	683	21.64	23.00	1.368	-0.17	0.327	0.447
	LTE Band 71	20M	QPSK	100	0	Back	5mm	Full	133322	683	21.64	23.00	1.368	-0.16	0.393	0.538
	LTE Band 12	10M	QPSK	1	0	Front	5mm	Full	23095	707.5	22.90	24.00	1.288	0.02	0.634	0.817
34	LTE Band 12	10M	QPSK	1	0	Back	5mm	Full	23095	707.5	22.90	24.00	1.288	-0.1	0.707	0.911
	LTE Band 12	10M	QPSK	1	0	Left Side	5mm	Full	23095	707.5	22.90	24.00	1.288	0.05	0.467	0.602
	LTE Band 12	10M	QPSK	1	0	Right Side	5mm	Full	23095	707.5	22.90	24.00	1.288	0.02	0.554	0.714
	LTE Band 12	10M	QPSK	1	0	Bottom Side	5mm	Full	23095	707.5	22.90	24.00	1.288	0.01	0.516	0.665
	LTE Band 12	10M	QPSK	25	0	Front	5mm	Full	23095	707.5	21.68	23.00	1.355	0.08	0.330	0.447
	LTE Band 12	10M	QPSK	25	0	Back	5mm	Full	23095	707.5	21.68	23.00	1.355	0.03	0.394	0.534
	LTE Band 12	10M	QPSK	25	0	Left Side	5mm	Full	23095	707.5	21.68	23.00	1.355	0.05	0.240	0.325
	LTE Band 12	10M	QPSK	25	0	Right Side	5mm	Full	23095	707.5	21.68	23.00	1.355	0.06	0.294	0.398
	LTE Band 12	10M	QPSK	25	0	Bottom Side	5mm	Full	23095	707.5	21.68	23.00	1.355	0.1	0.270	0.366
	LTE Band 12	10M	QPSK	50	0	Front	5mm	Full	23095	707.5	21.51	23.00	1.409	0.02	0.312	0.440
	LTE Band 12	10M	QPSK	50	0	Back	5mm	Full	23095	707.5	21.51	23.00	1.409	0.05	0.375	0.528
	LTE Band 13	10M	QPSK	1	0	Front	5mm	Full	23230	782	22.63	24.00	1.371	-0.13	0.848	1.163
35	LTE Band 13	10M	QPSK	1	0	Back	5mm	Full	23230	782	22.63	24.00	1.371	0.09	0.904	1.239
	LTE Band 13	10M	QPSK	1	0	Left Side	5mm	Full	23230	782	22.63	24.00	1.371	0.04	0.331	0.454
	LTE Band 13	10M	QPSK	1	0	Right Side	5mm	Full	23230	782	22.63	24.00	1.371	0.05	0.495	0.679
	LTE Band 13	10M	QPSK	1	0	Bottom Side	5mm	Full	23230	782	22.63	24.00	1.371	0.06	0.714	0.979
	LTE Band 13	10M	QPSK	25	12	Front	5mm	Full	23230	782	21.48	23.00	1.419	-0.09	0.455	0.646
	LTE Band 13	10M	QPSK	25	12	Back	5mm	Full	23230	782	21.48	23.00	1.419	-0.04	0.483	0.685
	LTE Band 13	10M	QPSK	25	12	Left Side	5mm	Full	23230	782	21.48	23.00	1.419	-0.06	0.159	0.226
	LTE Band 13	10M	QPSK	25	12	Right Side	5mm	Full	23230	782	21.48	23.00	1.419	0.05	0.249	0.353
	LTE Band 13	10M	QPSK	25	12	Bottom Side	5mm	Full	23230	782	21.48	23.00	1.419	0.06	0.393	0.558
	LTE Band 13	10M	QPSK	50	0	Front	5mm	Full	23230	782	21.44	23.00	1.432	-0.06	0.471	0.675
	LTE Band 13	10M	QPSK	50	0	Back	5mm	Full	23230	782	21.44	23.00	1.432	-0.01	0.496	0.710
	LTE Band 13	10M	QPSK	50	0	Bottom Side	5mm	Full	23230	782	21.44	23.00	1.432	0.06	0.410	0.587



Plot No.	Band	BW (MHz)	Modulation	RB Size	RB offset	Test Position	Gap (mm)	Power Reduction	Ch.	Freq. (MHz)	Average Power (dBm)	Tune-Up Limit (dBm)	Tune-up Scaling Factor	Power Drift (dB)	Measured 1g SAR (W/kg)	Reported 1g SAR (W/kg)
36	LTE Band 14	10M	QPSK	1	49	Front	5mm	Full	23330	793	22.72	24.00	1.343	-0.06	0.689	0.925
	LTE Band 14	10M	QPSK	1	49	Back	5mm	Full	23330	793	22.72	24.00	1.343	-0.12	0.718	<b>0.964</b>
	LTE Band 14	10M	QPSK	1	49	Left Side	5mm	Full	23330	793	22.72	24.00	1.343	0.09	0.200	0.269
	LTE Band 14	10M	QPSK	1	49	Right Side	5mm	Full	23330	793	22.72	24.00	1.343	0.06	0.352	0.473
	LTE Band 14	10M	QPSK	1	49	Bottom Side	5mm	Full	23330	793	22.72	24.00	1.343	-0.12	0.610	0.819
	LTE Band 14	10M	QPSK	25	12	Front	5mm	Full	23330	793	21.47	23.00	1.422	-0.02	0.486	0.691
	LTE Band 14	10M	QPSK	25	12	Back	5mm	Full	23330	793	21.47	23.00	1.422	-0.05	0.493	0.701
	LTE Band 14	10M	QPSK	25	12	Left Side	5mm	Full	23330	793	21.47	23.00	1.422	0.17	0.136	0.193
	LTE Band 14	10M	QPSK	25	12	Right Side	5mm	Full	23330	793	21.47	23.00	1.422	0.05	0.217	0.309
	LTE Band 14	10M	QPSK	25	12	Bottom Side	5mm	Full	23330	793	21.47	23.00	1.422	0.12	0.439	0.624
	LTE Band 14	10M	QPSK	50	0	Front	5mm	Full	23330	793	21.54	23.00	1.400	-0.05	0.488	0.683
	LTE Band 14	10M	QPSK	50	0	Back	5mm	Full	23330	793	21.54	23.00	1.400	-0.1	0.496	0.694
LTE Band 14	10M	QPSK	50	0	Bottom Side	5mm	Full	23330	793	21.54	23.00	1.400	0.02	0.448	0.627	
37	LTE Band 5	10M	QPSK	1	49	Front	5mm	Full	20525	836.5	23.11	24.00	1.227	-0.12	1.050	1.289
	LTE Band 5	10M	QPSK	1	49	Back	5mm	Full	20525	836.5	23.11	24.00	1.227	-0.12	1.170	<b>1.436</b>
	LTE Band 5	10M	QPSK	1	49	Left Side	5mm	Full	20525	836.5	23.11	24.00	1.227	0.15	0.356	0.437
	LTE Band 5	10M	QPSK	1	49	Right Side	5mm	Full	20525	836.5	23.11	24.00	1.227	0.02	0.446	0.547
	LTE Band 5	10M	QPSK	1	49	Bottom Side	5mm	Full	20525	836.5	23.11	24.00	1.227	-0.09	1.160	1.424
	LTE Band 5	10M	QPSK	25	25	Front	5mm	Full	20525	836.5	21.90	23.00	1.288	-0.11	0.635	0.818
	LTE Band 5	10M	QPSK	25	25	Back	5mm	Full	20525	836.5	21.90	23.00	1.288	-0.03	0.677	0.872
	LTE Band 5	10M	QPSK	25	25	Left Side	5mm	Full	20525	836.5	21.90	23.00	1.288	0.13	0.211	0.272
	LTE Band 5	10M	QPSK	25	25	Right Side	5mm	Full	20525	836.5	21.90	23.00	1.288	0.04	0.242	0.312
	LTE Band 5	10M	QPSK	25	25	Bottom Side	5mm	Full	20525	836.5	21.90	23.00	1.288	-0.19	0.630	0.812
	LTE Band 5	10M	QPSK	50	0	Front	5mm	Full	20525	836.5	21.88	23.00	1.294	-0.18	0.611	0.791
	LTE Band 5	10M	QPSK	50	0	Back	5mm	Full	20525	836.5	21.88	23.00	1.294	-0.06	0.659	0.853
LTE Band 5	10M	QPSK	50	0	Bottom Side	5mm	Full	20525	836.5	21.88	23.00	1.294	-0.06	0.592	0.766	
38	LTE Band 26	15M	QPSK	1	74	Front	5mm	Reduced	26865	831.5	22.09	23.00	1.233	-0.12	1.020	<b>1.258</b>
	LTE Band 26	15M	QPSK	1	74	Back	5mm	Reduced	26865	831.5	22.09	23.00	1.233	-0.07	0.841	1.037
	LTE Band 26	15M	QPSK	1	74	Left Side	5mm	Reduced	26865	831.5	22.09	23.00	1.233	-0.02	0.177	0.218
	LTE Band 26	15M	QPSK	1	74	Right Side	5mm	Reduced	26865	831.5	22.09	23.00	1.233	0.04	0.210	0.259
	LTE Band 26	15M	QPSK	1	74	Bottom Side	5mm	Reduced	26865	831.5	22.09	23.00	1.233	-0.07	0.708	0.873
	LTE Band 26	15M	QPSK	1	74	Bottom Side	5mm	Reduced	26765	821.5	21.96	23.00	1.271	-0.02	0.723	0.919
	LTE Band 26	15M	QPSK	1	74	Bottom Side	5mm	Reduced	26965	841.5	22.06	23.00	1.242	-0.15	0.920	1.142
	LTE Band 26	15M	QPSK	1	74	Front	5mm	Reduced	26765	821.5	21.96	23.00	1.271	-0.03	0.836	1.062
	LTE Band 26	15M	QPSK	1	74	Front	5mm	Reduced	26965	841.5	22.06	23.00	1.242	-0.03	1.000	1.242
	LTE Band 26	15M	QPSK	1	74	Back	5mm	Reduced	26765	821.5	21.96	23.00	1.271	-0.06	0.721	0.916
	LTE Band 26	15M	QPSK	1	74	Back	5mm	Reduced	26965	841.5	22.06	23.00	1.242	-0.15	0.899	1.116
	LTE Band 26	15M	QPSK	36	0	Front	5mm	Reduced	26865	831.5	21.84	23.00	1.306	-0.05	0.555	0.725
	LTE Band 26	15M	QPSK	36	0	Back	5mm	Reduced	26865	831.5	21.84	23.00	1.306	-0.05	0.425	0.555
	LTE Band 26	15M	QPSK	36	0	Left Side	5mm	Reduced	26865	831.5	21.84	23.00	1.306	-0.06	0.127	0.166
	LTE Band 26	15M	QPSK	36	0	Right Side	5mm	Reduced	26865	831.5	21.84	23.00	1.306	-0.08	0.132	0.172
	LTE Band 26	15M	QPSK	36	0	Bottom Side	5mm	Reduced	26865	831.5	21.84	23.00	1.306	0.05	0.328	0.428
	LTE Band 26	15M	QPSK	75	0	Front	5mm	Reduced	26865	831.5	21.68	23.00	1.355	-0.08	0.546	0.740
	LTE Band 26	15M	QPSK	75	0	Back	5mm	Reduced	26865	831.5	21.68	23.00	1.355	-0.02	0.427	0.579
	LTE Band 26	15M	QPSK	75	0	Bottom Side	5mm	Reduced	26865	831.5	21.68	23.00	1.355	-0.04	0.370	0.501





Plot No.	Band	BW (MHz)	Modulation	RB Size	RB offset	Test Position	Gap (mm)	Power Reduction	Ch.	Freq. (MHz)	Average Power (dBm)	Tune-Up Limit (dBm)	Tune-up Scaling Factor	Power Drift (dB)	Measured 1g SAR (W/kg)	Reported 1g SAR (W/kg)
	LTE Band 25	20M	QPSK	1	0	Front	5mm	Reduced	26590	1905	14.83	16.00	1.309	-0.15	0.921	1.206
	LTE Band 25	20M	QPSK	1	0	Front	5mm	Reduced	26140	1860	14.37	16.00	1.455	-0.05	0.871	1.268
	LTE Band 25	20M	QPSK	1	0	Front	5mm	Reduced	26340	1880	14.36	16.00	1.459	-0.1	0.886	1.293
	LTE Band 25	20M	QPSK	1	0	Back	5mm	Reduced	26590	1905	14.83	16.00	1.309	-0.13	0.861	1.127
	LTE Band 25	20M	QPSK	1	0	Back	5mm	Reduced	26140	1860	14.37	16.00	1.455	-0.02	0.822	1.196
	LTE Band 25	20M	QPSK	1	0	Back	5mm	Reduced	26340	1880	14.36	16.00	1.459	-0.03	0.843	1.230
	LTE Band 25	20M	QPSK	1	0	Left Side	5mm	Reduced	26590	1905	12.70	13.50	1.202	0.05	0.016	0.019
	LTE Band 25	20M	QPSK	1	0	Right Side	5mm	Reduced	26590	1905	12.70	13.50	1.202	0.01	0.016	0.019
	LTE Band 25	20M	QPSK	1	0	Bottom Side	5mm	Reduced	26590	1905	12.70	13.50	1.202	-0.07	0.876	1.053
	LTE Band 25	20M	QPSK	1	0	Bottom Side	5mm	Reduced	26140	1860	12.45	13.50	1.274	-0.09	0.800	1.019
	LTE Band 25	20M	QPSK	1	0	Bottom Side	5mm	Reduced	26340	1880	12.32	13.50	1.312	-0.03	0.926	1.215
	LTE Band 25	20M	QPSK	50	0	Front	5mm	Reduced	26590	1905	14.51	16.00	1.409	-0.01	0.938	1.322
	LTE Band 25	20M	QPSK	50	0	Front	5mm	Reduced	26140	1860	14.47	16.00	1.422	-0.13	0.872	1.240
39	LTE Band 25	20M	QPSK	50	0	Front	5mm	Reduced	26340	1880	14.34	16.00	1.466	-0.08	0.914	1.340
	LTE Band 25	20M	QPSK	50	0	Back	5mm	Reduced	26590	1905	14.51	16.00	1.409	-0.06	0.870	1.226
	LTE Band 25	20M	QPSK	50	0	Back	5mm	Reduced	26140	1860	14.47	16.00	1.422	-0.08	0.813	1.156
	LTE Band 25	20M	QPSK	50	0	Back	5mm	Reduced	26340	1880	14.34	16.00	1.466	-0.04	0.859	1.259
	LTE Band 25	20M	QPSK	50	0	Left Side	5mm	Reduced	26590	1905	12.54	13.50	1.247	0.03	0.016	0.019
	LTE Band 25	20M	QPSK	50	0	Right Side	5mm	Reduced	26590	1905	12.54	13.50	1.247	0.06	0.015	0.019
	LTE Band 25	20M	QPSK	50	0	Bottom Side	5mm	Reduced	26590	1905	12.54	13.50	1.247	-0.14	0.883	1.101
	LTE Band 25	20M	QPSK	50	0	Bottom Side	5mm	Reduced	26140	1860	12.49	13.50	1.262	0.09	0.839	1.059
	LTE Band 25	20M	QPSK	50	0	Bottom Side	5mm	Reduced	26340	1880	12.33	13.50	1.309	-0.11	0.941	1.232
	LTE Band 25	20M	QPSK	100	0	Front	5mm	Reduced	26590	1905	14.51	16.00	1.409	-0.07	0.922	1.299
	LTE Band 25	20M	QPSK	100	0	Back	5mm	Reduced	26590	1905	14.51	16.00	1.409	-0.04	0.882	1.243
	LTE Band 25	20M	QPSK	100	0	Bottom Side	5mm	Reduced	26590	1905	12.47	13.50	1.268	0.01	0.941	1.193
	LTE Band 66	20M	QPSK	1	99	Front	5mm	Reduced	132572	1770	15.96	16.50	1.132	-0.07	1.200	1.359
	LTE Band 66	20M	QPSK	1	99	Front	5mm	Reduced	132072	1720	15.32	16.50	1.312	0.06	1.000	1.312
	LTE Band 66	20M	QPSK	1	99	Front	5mm	Reduced	132322	1745	15.73	16.50	1.194	0.01	1.120	1.337
	LTE Band 66	20M	QPSK	1	99	Back	5mm	Reduced	132572	1770	15.96	16.50	1.132	-0.06	1.180	1.336
	LTE Band 66	20M	QPSK	1	99	Back	5mm	Reduced	132072	1720	15.32	16.50	1.312	0.05	0.966	1.268
	LTE Band 66	20M	QPSK	1	99	Back	5mm	Reduced	132322	1745	15.73	16.50	1.194	0.03	1.110	1.325
	LTE Band 66	20M	QPSK	1	99	Left Side	5mm	Reduced	132572	1770	14.09	14.50	1.099	-0.07	0.028	0.031
	LTE Band 66	20M	QPSK	1	99	Right Side	5mm	Reduced	132572	1770	14.09	14.50	1.099	-0.08	0.023	0.025
	LTE Band 66	20M	QPSK	1	99	Bottom Side	5mm	Reduced	132572	1770	14.09	14.50	1.099	-0.03	1.280	1.407
	LTE Band 66	20M	QPSK	1	99	Bottom Side	5mm	Reduced	132072	1720	13.61	14.50	1.227	0.11	1.170	1.436
40	LTE Band 66	20M	QPSK	1	99	Bottom Side	5mm	Reduced	132322	1745	14.06	14.50	1.107	-0.02	1.300	1.439
	LTE Band 66	20M	QPSK	50	50	Front	5mm	Reduced	132572	1770	15.81	16.50	1.172	-0.01	0.970	1.137
	LTE Band 66	20M	QPSK	50	50	Front	5mm	Reduced	132072	1720	15.28	16.50	1.324	-0.13	0.851	1.127
	LTE Band 66	20M	QPSK	50	50	Front	5mm	Reduced	132322	1745	15.65	16.50	1.216	-0.08	0.964	1.172
	LTE Band 66	20M	QPSK	50	50	Back	5mm	Reduced	132572	1770	15.81	16.50	1.172	-0.05	0.965	1.131
	LTE Band 66	20M	QPSK	50	50	Back	5mm	Reduced	132072	1720	15.28	16.50	1.324	-0.08	0.794	1.052
	LTE Band 66	20M	QPSK	50	50	Back	5mm	Reduced	132322	1745	15.65	16.50	1.216	-0.04	0.948	1.153
	LTE Band 66	20M	QPSK	50	50	Left Side	5mm	Reduced	132572	1770	13.68	14.50	1.208	0.03	0.025	0.031
	LTE Band 66	20M	QPSK	50	50	Right Side	5mm	Reduced	132572	1770	13.68	14.50	1.208	0.06	0.022	0.027
	LTE Band 66	20M	QPSK	50	50	Bottom Side	5mm	Reduced	132572	1770	13.68	14.50	1.208	-0.14	1.180	1.425
	LTE Band 66	20M	QPSK	50	50	Bottom Side	5mm	Reduced	132072	1720	12.98	14.50	1.419	0.09	0.964	1.368
	LTE Band 66	20M	QPSK	50	50	Bottom Side	5mm	Reduced	132322	1745	13.55	14.50	1.245	-0.11	1.150	1.431
	LTE Band 66	20M	QPSK	100	0	Front	5mm	Reduced	132572	1770	15.77	16.50	1.183	0.03	0.993	1.175
	LTE Band 66	20M	QPSK	100	0	Back	5mm	Reduced	132572	1770	15.77	16.50	1.183	-0.03	0.968	1.145
	LTE Band 66	20M	QPSK	100	0	Bottom Side	5mm	Reduced	132572	1770	13.82	14.50	1.169	0.05	1.230	1.438



Plot No.	Band	BW (MHz)	Modulation	RB Size	RB offset	Test Position	Gap (mm)	Power Reduction	Ch.	Freq. (MHz)	Average Power (dBm)	Tune-Up Limit (dBm)	Tune-up Scaling Factor	Power Drift (dB)	Measured 1g SAR (W/kg)	Reported 1g SAR (W/kg)
	LTE Band 7	20M	QPSK	1	99	Front	5mm	Reduced	21350	2560	19.22	19.50	1.067	-0.11	0.974	1.039
	LTE Band 7	20M	QPSK	1	99	Front	5mm	Reduced	20850	2510	18.93	19.50	1.140	0.03	0.954	1.088
	LTE Band 7	20M	QPSK	1	99	Front	5mm	Reduced	21100	2535	18.97	19.50	1.130	0.05	1.030	1.164
	LTE Band 7	20M	QPSK	1	99	Back	5mm	Reduced	21350	2560	19.22	19.50	1.067	-0.16	1.050	1.120
	LTE Band 7	20M	QPSK	1	99	Back	5mm	Reduced	20850	2510	18.93	19.50	1.140	-0.19	1.010	1.152
	LTE Band 7	20M	QPSK	1	99	Back	5mm	Reduced	21100	2535	18.97	19.50	1.130	-0.14	1.120	1.265
	LTE Band 7	20M	QPSK	1	99	Left Side	5mm	Reduced	21350	2560	19.22	19.50	1.067	-0.09	0.823	0.878
	LTE Band 7	20M	QPSK	1	99	Left Side	5mm	Reduced	20850	2510	18.93	19.50	1.140	-0.16	0.859	0.979
	LTE Band 7	20M	QPSK	1	99	Left Side	5mm	Reduced	21100	2535	18.97	19.50	1.130	-0.11	0.872	0.985
	LTE Band 7	20M	QPSK	1	99	Right Side	5mm	Reduced	21350	2560	19.22	19.50	1.067	0.02	0.154	0.164
	LTE Band 7	20M	QPSK	1	99	Bottom Side	5mm	Reduced	21350	2560	19.22	19.50	1.067	0.18	1.080	1.152
41	LTE Band 7	20M	QPSK	1	99	Bottom Side	5mm	Reduced	20850	2510	18.93	19.50	1.140	-0.03	1.150	1.311
	LTE Band 7	20M	QPSK	1	99	Bottom Side	5mm	Reduced	21100	2535	18.97	19.50	1.130	0.05	1.140	1.288
	LTE Band 7	20M	QPSK	50	50	Front	5mm	Reduced	21350	2560	19.15	19.50	1.084	-0.02	0.920	0.997
	LTE Band 7	20M	QPSK	50	50	Front	5mm	Reduced	20850	2510	19.02	19.50	1.117	0.03	0.901	1.006
	LTE Band 7	20M	QPSK	50	50	Front	5mm	Reduced	21100	2535	19.07	19.50	1.104	0.06	0.929	1.026
	LTE Band 7	20M	QPSK	50	50	Back	5mm	Reduced	21350	2560	19.15	19.50	1.084	-0.11	1.000	1.084
	LTE Band 7	20M	QPSK	50	50	Back	5mm	Reduced	20850	2510	19.02	19.50	1.117	-0.12	0.961	1.073
	LTE Band 7	20M	QPSK	50	50	Back	5mm	Reduced	21100	2535	19.07	19.50	1.104	-0.17	1.020	1.126
	LTE Band 7	20M	QPSK	50	50	Left Side	5mm	Reduced	21350	2560	19.15	19.50	1.084	-0.13	0.764	0.828
	LTE Band 7	20M	QPSK	50	50	Left Side	5mm	Reduced	20850	2510	19.02	19.50	1.117	-0.15	0.818	0.914
	LTE Band 7	20M	QPSK	50	50	Left Side	5mm	Reduced	21100	2535	19.07	19.50	1.104	-0.19	0.834	0.921
	LTE Band 7	20M	QPSK	50	50	Right Side	5mm	Reduced	21350	2560	19.15	19.50	1.084	0.03	0.149	0.162
	LTE Band 7	20M	QPSK	50	50	Bottom Side	5mm	Reduced	21350	2560	19.15	19.50	1.084	0.07	1.090	1.181
	LTE Band 7	20M	QPSK	50	50	Bottom Side	5mm	Reduced	20850	2510	19.02	19.50	1.117	0.05	1.010	1.128
	LTE Band 7	20M	QPSK	50	50	Bottom Side	5mm	Reduced	21100	2535	19.07	19.50	1.104	0.12	1.080	1.192
	LTE Band 7	20M	QPSK	100	0	Front	5mm	Reduced	21350	2560	19.09	19.50	1.099	0.04	0.912	1.002
	LTE Band 7	20M	QPSK	100	0	Back	5mm	Reduced	21350	2560	19.09	19.50	1.099	-0.17	1.020	1.121
	LTE Band 7	20M	QPSK	100	0	Left Side	5mm	Reduced	21350	2560	19.09	19.50	1.099	0.05	0.788	0.866
	LTE Band 7	20M	QPSK	100	0	Bottom Side	5mm	Reduced	21350	2560	19.09	19.50	1.099	0.1	1.090	1.198
	LTE Band 30	10M	QPSK	1	0	Front	5mm	Reduced	27710	2310	20.26	21.00	1.186	0.05	0.899	1.066
	LTE Band 30	10M	QPSK	1	0	Back	5mm	Reduced	27710	2310	20.26	21.00	1.186	0.12	0.948	1.124
	LTE Band 30	10M	QPSK	1	0	Left Side	5mm	Reduced	27710	2310	20.26	21.00	1.186	0.06	0.758	0.899
	LTE Band 30	10M	QPSK	1	0	Right Side	5mm	Reduced	27710	2310	20.26	21.00	1.186	0.14	0.090	0.107
	LTE Band 30	10M	QPSK	1	0	Bottom Side	5mm	Reduced	27710	2310	20.26	21.00	1.186	0.12	0.785	0.931
	LTE Band 30	10M	QPSK	25	25	Front	5mm	Reduced	27710	2310	20.10	21.00	1.230	0.01	0.922	1.134
42	LTE Band 30	10M	QPSK	25	25	Back	5mm	Reduced	27710	2310	20.10	21.00	1.230	-0.12	1.040	1.279
	LTE Band 30	10M	QPSK	25	25	Left Side	5mm	Reduced	27710	2310	20.10	21.00	1.230	0.02	0.754	0.928
	LTE Band 30	10M	QPSK	25	25	Right Side	5mm	Reduced	27710	2310	20.10	21.00	1.230	0.03	0.091	0.112
	LTE Band 30	10M	QPSK	25	25	Bottom Side	5mm	Reduced	27710	2310	20.10	21.00	1.230	0.09	0.803	0.988
	LTE Band 30	10M	QPSK	50	0	Front	5mm	Reduced	27710	2310	20.01	21.00	1.256	0.07	0.899	1.129
	LTE Band 30	10M	QPSK	50	0	Back	5mm	Reduced	27710	2310	20.01	21.00	1.256	-0.02	0.955	1.200
	LTE Band 30	10M	QPSK	50	0	Left Side	5mm	Reduced	27710	2310	20.01	21.00	1.256	0.04	0.747	0.938
	LTE Band 30	10M	QPSK	50	0	Bottom Side	5mm	Reduced	27710	2310	20.01	21.00	1.256	0.06	0.774	0.972



<TDD LTE SAR>

Plot No.	Band	BW (MHz)	Modulation	RB Size	RB offset	Test Position	Gap (mm)	Power Reduction	Ch.	Freq. (MHz)	Average Power (dBm)	Tune-Up Limit (dBm)	Tune-up Scaling Factor	Duty Cycle %	Duty Cycle Scaling Factor	Power Drift (dB)	Measured 1g SAR (W/kg)	Reported 1g SAR (W/kg)
	LTE Band 41	20M	QPSK	1	49	Front	5mm	Reduced	41490	2680	19.93	21.00	1.279	62.9	1.006	0.11	0.865	1.113
	LTE Band 41	20M	QPSK	1	49	Back	5mm	Reduced	41490	2680	19.93	21.00	1.279	62.9	1.006	-0.18	1.020	1.313
	LTE Band 41	20M	QPSK	1	49	Left Side	5mm	Reduced	41490	2680	19.93	21.00	1.279	62.9	1.006	-0.17	0.756	0.973
	LTE Band 41	20M	QPSK	1	49	Right Side	5mm	Reduced	41490	2680	19.93	21.00	1.279	62.9	1.006	0.02	0.098	0.126
	LTE Band 41	20M	QPSK	1	49	Bottom Side	5mm	Reduced	41490	2680	19.93	21.00	1.279	62.9	1.006	0.15	0.836	1.076
	LTE Band 41	20M	QPSK	1	49	Front	5mm	Reduced	39750	2506	19.58	21.00	1.387	62.9	1.006	-0.13	0.728	1.016
	LTE Band 41	20M	QPSK	1	49	Front	5mm	Reduced	40185	2549.5	19.73	21.00	1.340	62.9	1.006	-0.05	0.773	1.042
	LTE Band 41	20M	QPSK	1	49	Front	5mm	Reduced	40620	2593	19.50	21.00	1.413	62.9	1.006	-0.03	0.806	1.145
	LTE Band 41	20M	QPSK	1	49	Front	5mm	Reduced	41055	2636.5	19.59	21.00	1.384	62.9	1.006	0.16	0.869	1.210
	LTE Band 41	20M	QPSK	1	49	Back	5mm	Reduced	39750	2506	19.58	21.00	1.387	62.9	1.006	-0.11	0.774	1.080
	LTE Band 41	20M	QPSK	1	49	Back	5mm	Reduced	40185	2549.5	19.73	21.00	1.340	62.9	1.006	-0.13	0.838	1.129
	LTE Band 41	20M	QPSK	1	49	Back	5mm	Reduced	40620	2593	19.50	21.00	1.413	62.9	1.006	-0.13	0.891	1.266
	LTE Band 41	20M	QPSK	1	49	Back	5mm	Reduced	41055	2636.5	19.59	21.00	1.384	62.9	1.006	-0.19	0.975	1.357
	LTE Band 41	20M	QPSK	1	49	Left Side	5mm	Reduced	39750	2506	19.58	21.00	1.387	62.9	1.006	0.05	0.671	0.936
	LTE Band 41	20M	QPSK	1	49	Left Side	5mm	Reduced	40185	2549.5	19.73	21.00	1.340	62.9	1.006	0.02	0.720	0.970
	LTE Band 41	20M	QPSK	1	49	Left Side	5mm	Reduced	40620	2593	19.50	21.00	1.413	62.9	1.006	0.07	0.710	1.009
	LTE Band 41	20M	QPSK	1	49	Left Side	5mm	Reduced	41055	2636.5	19.59	21.00	1.384	62.9	1.006	-0.11	0.750	1.044
	LTE Band 41	20M	QPSK	1	49	Bottom Side	5mm	Reduced	39750	2506	19.58	21.00	1.387	62.9	1.006	0.01	0.696	0.971
	LTE Band 41	20M	QPSK	1	49	Bottom Side	5mm	Reduced	40185	2549.5	19.73	21.00	1.340	62.9	1.006	-0.02	0.682	0.919
	LTE Band 41	20M	QPSK	1	49	Bottom Side	5mm	Reduced	40620	2593	19.50	21.00	1.413	62.9	1.006	-0.12	0.724	1.029
	LTE Band 41	20M	QPSK	1	49	Bottom Side	5mm	Reduced	41055	2636.5	19.59	21.00	1.384	62.9	1.006	-0.11	0.784	1.091
	LTE Band 41	20M	QPSK	50	24	Front	5mm	Reduced	41490	2680	19.85	21.00	1.303	62.9	1.006	0.09	0.949	1.244
	LTE Band 41	20M	QPSK	50	24	Front	5mm	Reduced	39750	2506	19.58	21.00	1.387	62.9	1.006	0.08	0.768	1.071
	LTE Band 41	20M	QPSK	50	24	Front	5mm	Reduced	40185	2549.5	19.80	21.00	1.318	62.9	1.006	-0.08	0.800	1.061
	LTE Band 41	20M	QPSK	50	24	Front	5mm	Reduced	40620	2593	19.55	21.00	1.396	62.9	1.006	-0.02	0.820	1.152
	LTE Band 41	20M	QPSK	50	24	Front	5mm	Reduced	41055	2636.5	19.60	21.00	1.380	62.9	1.006	0.13	0.896	1.244
	LTE Band 41	20M	QPSK	50	24	Back	5mm	Reduced	41490	2680	19.85	21.00	1.303	62.9	1.006	-0.04	1.070	1.403
	LTE Band 41	20M	QPSK	50	24	Back	5mm	Reduced	39750	2506	19.58	21.00	1.387	62.9	1.006	-0.02	0.797	1.112
	LTE Band 41	20M	QPSK	50	24	Back	5mm	Reduced	40185	2549.5	19.80	21.00	1.318	62.9	1.006	-0.02	0.875	1.160
	LTE Band 41	20M	QPSK	50	24	Back	5mm	Reduced	40620	2593	19.55	21.00	1.396	62.9	1.006	-0.1	0.924	1.298
	LTE Band 41	20M	QPSK	50	24	Back	5mm	Reduced	41055	2636.5	19.60	21.00	1.380	62.9	1.006	-0.18	1.030	1.430
	LTE Band 41	20M	QPSK	50	24	Left Side	5mm	Reduced	41490	2680	19.85	21.00	1.303	62.9	1.006	-0.02	0.773	1.013
	LTE Band 41	20M	QPSK	50	24	Left Side	5mm	Reduced	39750	2506	19.58	21.00	1.387	62.9	1.006	-0.06	0.603	0.841
	LTE Band 41	20M	QPSK	50	24	Left Side	5mm	Reduced	40185	2549.5	19.80	21.00	1.318	62.9	1.006	-0.03	0.652	0.865
	LTE Band 41	20M	QPSK	50	24	Left Side	5mm	Reduced	40620	2593	19.55	21.00	1.396	62.9	1.006	0.09	0.647	0.909
	LTE Band 41	20M	QPSK	50	24	Left Side	5mm	Reduced	41055	2636.5	19.60	21.00	1.380	62.9	1.006	-0.05	0.718	0.997
	LTE Band 41	20M	QPSK	50	24	Right Side	5mm	Reduced	41490	2680	19.85	21.00	1.303	62.9	1.006	0.01	0.101	0.132
	LTE Band 41	20M	QPSK	50	24	Bottom Side	5mm	Reduced	41490	2680	19.85	21.00	1.303	62.9	1.006	-0.02	0.807	1.058
	LTE Band 41	20M	QPSK	50	24	Bottom Side	5mm	Reduced	39750	2506	19.58	21.00	1.387	62.9	1.006	0.04	0.688	0.960
	LTE Band 41	20M	QPSK	50	24	Bottom Side	5mm	Reduced	40185	2549.5	19.80	21.00	1.318	62.9	1.006	0.01	0.717	0.951
	LTE Band 41	20M	QPSK	50	24	Bottom Side	5mm	Reduced	40620	2593	19.55	21.00	1.396	62.9	1.006	0.08	0.742	1.042
	LTE Band 41	20M	QPSK	50	24	Bottom Side	5mm	Reduced	41055	2636.5	19.60	21.00	1.380	62.9	1.006	0.06	0.799	1.110
	LTE Band 41	20M	QPSK	100	0	Front	5mm	Reduced	41490	2680	19.90	21.00	1.288	62.9	1.006	0.16	0.977	1.266
43	LTE Band 41	20M	QPSK	100	0	Back	5mm	Reduced	41490	2680	19.90	21.00	1.288	62.9	1.006	-0.02	1.110	1.439
	LTE Band 41-HPUE	20M	QPSK	100	0	Back	5mm	Reduced	41490	2680	19.54	21.00	1.400	42.9	1.009	-0.03	0.696	0.983
	LTE Band 41C	20M	QPSK	100	0	Back	5mm	Reduced	39750(pcc)+39948(scc)	2506(pcc)+2525.8(scc)	19.83	21.00	1.309	62.9	1.006	0.03	0.767	1.010
	LTE Band 41C	20M	QPSK	100	0	Back	5mm	Reduced	40185(pcc)+39987(scc)	2549.5(pcc)+2529.7(scc)	19.69	21.00	1.352	62.9	1.006	0.05	0.676	0.919
	LTE Band 41C	20M	QPSK	100	0	Back	5mm	Reduced	40620(pcc)+40422(scc)	2593(pcc)+2573.2(scc)	19.42	21.00	1.439	62.9	1.006	0.08	0.609	0.881
	LTE Band 41C	20M	QPSK	100	0	Back	5mm	Reduced	41055(pcc)+40857(scc)	2636.5(pcc)+2616.7(scc)	19.5	21.00	1.413	62.9	1.006	0.04	0.659	0.936
	LTE Band 41C	20M	QPSK	100	0	Back	5mm	Reduced	41490(pcc)+41292(scc)	2682(pcc)+2660.2(scc)	19.56	21.00	1.393	62.9	1.006	0.01	0.779	1.092
	LTE Band 41	20M	QPSK	100	0	Left Side	5mm	Reduced	41490	2680	19.90	21.00	1.288	62.9	1.006	-0.03	0.770	0.998
	LTE Band 41	20M	QPSK	100	0	Bottom Side	5mm	Reduced	41490	2680	19.90	21.00	1.288	62.9	1.006	-0.01	0.814	1.055



<Bluetooth SAR>

Plot No.	Band	Mode	Test Position	Gap (mm)	Power Reduction	Ch.	Freq. (MHz)	Average Power (dBm)	Tune-Up Limit (dBm)	Tune-up Scaling Factor	Duty Cycle %	Duty Cycle Scaling Factor	Power Drift (dB)	Measured 1g SAR (W/kg)	Reported 1g SAR (W/kg)
	Bluetooth	DH5 1Mbps	Front	5mm	Full	39	2441	9.31	10.00	1.172	77.03	1.081	0.01	0.033	0.041
	Bluetooth	DH5 1Mbps	Back	5mm	Full	39	2441	9.31	10.00	1.172	77.03	1.081	0.02	0.055	0.069
	Bluetooth	DH5 1Mbps	Back	5mm	Full	0	2402	8.32	10.00	1.473	77.03	1.081	0.14	0.050	0.079
	Bluetooth	DH5 1Mbps	Back	5mm	Full	78	2480	9.19	10.00	1.205	77.03	1.081	0.09	0.048	0.063
	Bluetooth	DH5 1Mbps	Left Side	5mm	Full	39	2441	9.31	10.00	1.172	77.03	1.081	-0.14	0.012	0.015
	Bluetooth	DH5 1Mbps	Right Side	5mm	Full	39	2441	9.31	10.00	1.172	77.03	1.081	0.12	0.028	0.035
	Bluetooth	DH5 1Mbps	Top Side	5mm	Full	39	2441	9.31	10.00	1.172	77.03	1.081	0.13	0.059	0.075
44	Bluetooth	DH5 1Mbps	Top Side	5mm	Full	0	2402	8.32	10.00	1.473	77.03	1.081	-0.03	0.056	0.089
	Bluetooth	DH5 1Mbps	Top Side	5mm	Full	78	2480	9.19	10.00	1.205	77.03	1.081	0.11	0.055	0.072

<WLAN2.4G SAR>

Plot No.	Band	Mode	Test Position	Gap (mm)	Power Reduction	Ch.	Freq. (MHz)	Average Power (dBm)	Tune-Up Limit (dBm)	Tune-up Scaling Factor	Duty Cycle %	Duty Cycle Scaling Factor	Power Drift (dB)	Measured 1g SAR (W/kg)	Reported 1g SAR (W/kg)
	WLAN2.4GHz	802.11b 1Mbps	Front	5mm	Reduced	11	2462	20.12	21.50	1.374	100	1.000	0.04	0.541	0.743
45	WLAN2.4GHz	802.11b 1Mbps	Back	5mm	Reduced	11	2462	20.12	21.50	1.374	100	1.000	0.02	0.839	1.153
	WLAN2.4GHz	802.11b 1Mbps	Back	5mm	Reduced	1	2412	20.09	21.50	1.384	100	1.000	0.18	0.778	1.076
	WLAN2.4GHz	802.11b 1Mbps	Back	5mm	Reduced	6	2437	20.05	21.50	1.396	100	1.000	0.15	0.787	1.099
	WLAN2.4GHz	802.11b 1Mbps	Left Side	5mm	Reduced	11	2462	19.64	21.00	1.368	100	1.000	0.11	0.171	0.234
	WLAN2.4GHz	802.11b 1Mbps	Right Side	5mm	Reduced	11	2462	19.64	21.00	1.368	100	1.000	0.14	0.396	0.542
	WLAN2.4GHz	802.11b 1Mbps	Top Side	5mm	Reduced	11	2462	19.64	21.00	1.368	100	1.000	-0.09	0.719	0.983
	WLAN2.4GHz	802.11b 1Mbps	Top Side	5mm	Reduced	1	2412	19.49	21.00	1.416	100	1.000	0.16	0.753	1.066
	WLAN2.4GHz	802.11b 1Mbps	Top Side	5mm	Reduced	6	2437	19.28	21.00	1.486	100	1.000	0.12	0.707	1.051

<WLAN5G SAR>

Plot No.	Band	Mode	Test Position	Gap (mm)	Power Reduction	Ch.	Freq. (MHz)	Average Power (dBm)	Tune-Up Limit (dBm)	Tune-up Scaling Factor	Duty Cycle %	Duty Cycle Scaling Factor	Power Drift (dB)	Measured 1g SAR (W/kg)	Reported 1g SAR (W/kg)
	WLAN5.2GHz	802.11a 6Mbps	Front	5mm	Reduced	36	5180	9.69	11.00	1.352	98.28	1.018	0.09	0.001	0.001
	WLAN5.2GHz	802.11a 6Mbps	Back	5mm	Reduced	36	5180	9.69	11.00	1.352	98.28	1.018	0.07	0.838	1.153
	WLAN5.2GHz	802.11a 6Mbps	Left Side	5mm	Reduced	36	5180	9.69	11.00	1.352	98.28	1.018	0.04	0.000	0.001
	WLAN5.2GHz	802.11a 6Mbps	Right Side	5mm	Reduced	36	5180	9.69	11.00	1.352	98.28	1.018	0.03	0.090	0.124
	WLAN5.2GHz	802.11a 6Mbps	Top Side	5mm	Reduced	36	5180	9.69	11.00	1.352	98.28	1.018	0.01	0.030	0.041
46	WLAN5.2GHz	802.11a 6Mbps	Back	5mm	Reduced	40	5200	9.56	11.00	1.393	98.28	1.018	-0.12	0.814	1.154
	WLAN5.2GHz	802.11a 6Mbps	Back	5mm	Reduced	44	5220	9.66	11.00	1.361	98.28	1.018	0.12	0.817	1.132
	WLAN5.2GHz	802.11a 6Mbps	Back	5mm	Reduced	48	5240	9.53	11.00	1.403	98.28	1.018	0.09	0.765	1.092
	WLAN5.8GHz	802.11a 6Mbps	Front	5mm	Reduced	149	5745	9.69	11.00	1.354	98.28	1.018	0.03	0.006	0.008
	WLAN5.8GHz	802.11a 6Mbps	Back	5mm	Reduced	149	5745	9.69	11.00	1.354	98.28	1.018	-0.02	0.855	1.178
	WLAN5.8GHz	802.11a 6Mbps	Left Side	5mm	Reduced	149	5745	9.69	11.00	1.354	98.28	1.018	-0.12	0.001	0.001
	WLAN5.8GHz	802.11a 6Mbps	Right Side	5mm	Reduced	149	5745	9.69	11.00	1.354	98.28	1.018	0.1	0.097	0.134
	WLAN5.8GHz	802.11a 6Mbps	Top Side	5mm	Reduced	149	5745	9.69	11.00	1.354	98.28	1.018	-0.02	0.030	0.041
47	WLAN5.8GHz	802.11a 6Mbps	Back	5mm	Reduced	157	5785	8.73	10.00	1.341	98.28	1.018	-0.05	0.873	1.192
	WLAN5.8GHz	802.11a 6Mbps	Back	5mm	Reduced	165	5825	8.89	10.00	1.293	98.28	1.018	0.01	0.894	1.176



**15.3 Body Worn Accessory SAR**

**<GSM SAR>**

Plot No.	Band	Mode	Test Position	Gap (mm)	Headset	Power Reduction	Ch.	Freq. (MHz)	Average Power (dBm)	Tune-Up Limit (dBm)	Tune-up Scaling Factor	Power Drift (dB)	Measured 1g SAR (W/kg)	Reported 1g SAR (W/kg)
	GSM850	GPRS 2 Tx slots	Front	5mm	-	Full	189	836.4	30.40	31.50	1.288	0.11	0.985	1.269
	GSM850	GPRS 2 Tx slots	Front	5mm	-	Full	128	824.2	30.32	31.50	1.312	0.13	0.857	1.125
	GSM850	GPRS 2 Tx slots	Front	5mm	-	Full	251	848.8	30.02	31.50	1.406	0.12	0.901	1.267
48	GSM850	GPRS 2 Tx slots	Back	5mm	-	Full	189	836.4	30.40	31.50	1.288	-0.15	1.070	<b>1.378</b>
	GSM850	GPRS 2 Tx slots	Back	5mm	-	Full	128	824.2	30.32	31.50	1.312	-0.16	0.884	1.160
	GSM850	GPRS 2 Tx slots	Back	5mm	-	Full	251	848.8	30.02	31.50	1.406	-0.07	0.969	1.362
	GSM850	GPRS 2 Tx slots	Front	5mm	Headset	Full	189	836.4	30.40	31.50	1.288	0.11	0.955	1.230
	GSM850	GPRS 2 Tx slots	Back	5mm	Headset	Full	189	836.4	30.40	31.50	1.288	0.15	0.992	1.278
49	GSM1900	GPRS 2 Tx slots	Front	5mm	-	Reduced	661	1880	21.05	22.50	1.396	-0.08	0.972	<b>1.357</b>
	GSM1900	GPRS 2 Tx slots	Front	5mm	-	Reduced	512	1850.2	20.98	22.50	1.419	0.02	0.947	1.344
	GSM1900	GPRS 2 Tx slots	Front	5mm	-	Reduced	810	1909.8	20.94	22.50	1.432	-0.19	0.920	1.318
	GSM1900	GPRS 2 Tx slots	Back	5mm	-	Reduced	661	1880	21.05	22.50	1.396	-0.09	0.905	1.264
	GSM1900	GPRS 2 Tx slots	Back	5mm	-	Reduced	512	1850.2	20.98	22.50	1.419	-0.07	0.812	1.152
	GSM1900	GPRS 2 Tx slots	Back	5mm	-	Reduced	810	1909.8	20.94	22.50	1.432	-0.03	0.828	1.186
	GSM1900	GPRS 2 Tx slots	Front	5mm	Headset	Reduced	661	1880	21.05	22.50	1.396	-0.02	0.970	1.354
	GSM1900	GPRS 2 Tx slots	Back	5mm	Headset	Reduced	661	1880	21.05	22.50	1.396	-0.09	0.880	1.229
	GSM1900	GPRS 2 Tx slots	Front	18mm	-	Full	661	1880	27.82	29.00	1.312	-0.07	0.605	0.794
	GSM1900	GPRS 2 Tx slots	Back	19mm	-	Full	661	1880	27.82	29.00	1.312	0.18	0.510	0.669



<WCDMA SAR>

Plot No.	Band	Mode	Test Position	Gap (mm)	Headset	Power Reduction	Ch.	Freq. (MHz)	Average Power (dBm)	Tune-Up Limit (dBm)	Tune-up Scaling Factor	Power Drift (dB)	Measured 1g SAR (W/kg)	Reported 1g SAR (W/kg)
	WCDMA V	RMC 12.2Kbps	Front	5mm	-	Reduced	4233	846.6	22.15	23.00	1.216	-0.05	1.070	1.301
	WCDMA V	RMC 12.2Kbps	Front	5mm	-	Reduced	4132	826.4	21.88	23.00	1.294	-0.02	0.823	1.065
	WCDMA V	RMC 12.2Kbps	Front	5mm	-	Reduced	4182	836.4	21.89	23.00	1.291	-0.05	0.923	1.192
50	WCDMA V	RMC 12.2Kbps	Back	5mm	-	Reduced	4233	846.6	22.15	23.00	1.216	-0.13	1.110	1.350
	WCDMA V	RMC 12.2Kbps	Back	5mm	-	Reduced	4132	826.4	21.88	23.00	1.294	-0.04	0.836	1.082
	WCDMA V	RMC 12.2Kbps	Back	5mm	-	Reduced	4182	836.4	21.89	23.00	1.291	-0.07	0.985	1.272
	WCDMA V	RMC 12.2Kbps	Back	5mm	Headset	Reduced	4233	846.6	22.15	23.00	1.216	-0.18	1.100	1.338
	WCDMA V	RMC 12.2Kbps	Front	5mm	Headset	Reduced	4233	846.6	22.15	23.00	1.216	-0.05	0.980	1.192
	WCDMA V	RMC 12.2Kbps	Front	18mm	-	Full	4233	846.6	23.29	24.00	1.178	-0.14	0.350	0.412
	WCDMA V	RMC 12.2Kbps	Back	19mm	-	Full	4233	846.6	23.29	24.00	1.178	-0.04	0.295	0.347
51	WCDMA IV	RMC 12.2Kbps	Front	5mm	-	Reduced	1513	1752.6	14.09	15.50	1.384	-0.09	1.000	1.384
	WCDMA IV	RMC 12.2Kbps	Front	5mm	-	Reduced	1312	1712.4	14.05	15.50	1.396	-0.07	0.839	1.172
	WCDMA IV	RMC 12.2Kbps	Front	5mm	-	Reduced	1413	1732.6	13.88	15.50	1.452	-0.08	0.923	1.340
	WCDMA IV	RMC 12.2Kbps	Back	5mm	-	Reduced	1513	1752.6	14.09	15.50	1.384	-0.06	0.884	1.223
	WCDMA IV	RMC 12.2Kbps	Back	5mm	-	Reduced	1312	1712.4	14.05	15.50	1.396	-0.05	0.689	0.962
	WCDMA IV	RMC 12.2Kbps	Back	5mm	-	Reduced	1413	1732.6	13.88	15.50	1.452	-0.14	0.783	1.137
	WCDMA IV	RMC 12.2Kbps	Front	5mm	Headset	Reduced	1513	1752.6	14.09	15.50	1.384	-0.14	0.945	1.307
	WCDMA IV	RMC 12.2Kbps	Back	5mm	Headset	Reduced	1513	1752.6	14.09	15.50	1.384	-0.06	0.810	1.121
	WCDMA IV	RMC 12.2Kbps	Front	18mm	-	Full	1513	1752.6	22.79	24.00	1.321	-0.01	0.953	1.259
	WCDMA IV	RMC 12.2Kbps	Back	19mm	-	Full	1513	1752.6	22.79	24.00	1.321	0.11	0.893	1.180
	WCDMA II	RMC 12.2Kbps	Front	5mm	-	Reduced	9400	1880	14.45	15.50	1.274	0.05	1.082	1.378
	WCDMA II	RMC 12.2Kbps	Front	5mm	-	Reduced	9262	1852.4	14.31	15.50	1.315	0.03	0.894	1.176
52	WCDMA II	RMC 12.2Kbps	Front	5mm	-	Reduced	9538	1907.6	14.42	15.50	1.282	-0.07	1.110	1.423
	WCDMA II	RMC 12.2Kbps	Back	5mm	-	Reduced	9400	1880	14.45	15.50	1.274	0.1	1.040	1.324
	WCDMA II	RMC 12.2Kbps	Back	5mm	-	Reduced	9262	1852.4	14.31	15.50	1.315	0.02	0.880	1.157
	WCDMA II	RMC 12.2Kbps	Back	5mm	-	Reduced	9538	1907.6	14.42	15.50	1.282	-0.05	1.070	1.372
	WCDMA II	RMC 12.2Kbps	Front	5mm	Headset	Reduced	9538	1907.6	14.42	15.50	1.282	-0.14	0.971	1.245
	WCDMA II	RMC 12.2Kbps	Back	5mm	Headset	Reduced	9538	1907.6	14.42	15.50	1.282	-0.05	0.952	1.221
	WCDMA II	RMC 12.2Kbps	Front	18mm	-	Full	9538	1907.6	22.99	24.00	1.262	-0.14	0.838	1.057
	WCDMA II	RMC 12.2Kbps	Back	19mm	-	Full	9538	1907.6	22.99	24.00	1.262	-0.08	0.979	1.235



<CDMA SAR>

Plot No.	Band	Mode	Test Position	Gap (mm)	Headset	Power Reduction	Ch.	Freq. (MHz)	Average Power (dBm)	Tune-Up Limit (dBm)	Tune-up Scaling Factor	Power Drift (dB)	Measured 1g SAR (W/kg)	Reported 1g SAR (W/kg)
	CDMA2000 BC0	RC3 SO32(F+SCH)	Front	5mm	-	Full	777	848.31	24.53	25.00	1.114	0.14	1.030	1.148
	CDMA2000 BC0	RC3 SO32(F+SCH)	Front	5mm	-	Full	1013	824.7	24.14	25.00	1.219	0.12	1.000	1.219
	CDMA2000 BC0	RC3 SO32(F+SCH)	Front	5mm	-	Full	384	836.52	24.24	25.00	1.191	0.11	0.988	1.177
	CDMA2000 BC0	RC3 SO32(F+SCH)	Back	5mm	-	Full	777	848.31	24.53	25.00	1.114	0.15	1.040	1.159
53	CDMA2000 BC0	RC3 SO32(F+SCH)	Back	5mm	-	Full	1013	824.7	24.14	25.00	1.219	-0.01	1.130	1.377
	CDMA2000 BC0	RC3 SO32(F+SCH)	Back	5mm	-	Full	384	836.52	24.24	25.00	1.191	0.13	1.040	1.239
	CDMA2000 BC0	RC3 SO32(F+SCH)	Front	5mm	Headset	Full	1013	824.7	24.14	25.00	1.219	0.12	0.910	1.109
	CDMA2000 BC0	RC3 SO32(F+SCH)	Back	5mm	Headset	Full	1013	824.7	24.14	25.00	1.219	0.14	1.090	1.329
	CDMA2000 BC10	RC3 SO32(F+SCH)	Front	5mm	-	Full	580	820.5	24.27	25.00	1.183	0.02	0.962	1.138
	CDMA2000 BC10	RC3 SO32(F+SCH)	Front	5mm	-	Full	476	817.9	24.25	25.00	1.189	0.03	0.925	1.099
	CDMA2000 BC10	RC3 SO32(F+SCH)	Front	5mm	-	Full	684	823.1	24.18	25.00	1.208	0.04	0.950	1.147
54	CDMA2000 BC10	RC3 SO32(F+SCH)	Back	5mm	-	Full	580	820.5	24.27	25.00	1.183	0.1	1.010	1.195
	CDMA2000 BC10	RC3 SO32(F+SCH)	Back	5mm	-	Full	476	817.9	24.25	25.00	1.189	0.13	0.938	1.115
	CDMA2000 BC10	RC3 SO32(F+SCH)	Back	5mm	-	Full	684	823.1	24.18	25.00	1.208	0.14	0.930	1.123
55	CDMA2000 BC1	RC3 SO32(F+SCH)	Front	5mm	-	Reduced	600	1880	16.39	17.00	1.151	-0.14	1.140	1.312
	CDMA2000 BC1	RC3 SO32(F+SCH)	Front	5mm	-	Reduced	25	1851.25	16.31	17.00	1.172	0.08	0.959	1.124
	CDMA2000 BC1	RC3 SO32(F+SCH)	Front	5mm	-	Reduced	1175	1908.75	16.22	17.00	1.197	-0.17	1.040	1.245
	CDMA2000 BC1	RC3 SO32(F+SCH)	Back	5mm	-	Reduced	600	1880	16.39	17.00	1.151	-0.09	1.110	1.277
	CDMA2000 BC1	RC3 SO32(F+SCH)	Back	5mm	-	Reduced	25	1851.25	16.31	17.00	1.172	-0.03	0.941	1.103
	CDMA2000 BC1	RC3 SO32(F+SCH)	Back	5mm	-	Reduced	1175	1908.75	16.22	17.00	1.197	-0.07	0.996	1.192
	CDMA2000 BC1	RC3 SO32(F+SCH)	Front	5mm	Headset	Reduced	600	1880	16.39	17.00	1.151	-0.01	1.110	1.277
	CDMA2000 BC1	RC3 SO32(F+SCH)	Back	5mm	Headset	Reduced	600	1880	16.39	17.00	1.151	-0.09	1.010	1.162
	CDMA2000 BC1	RC3 SO32(F+SCH)	Front	18mm	-	Full	600	1880	24.52	25.00	1.117	-0.15	0.714	0.797
	CDMA2000 BC1	RC3 SO32(F+SCH)	Back	19mm	-	Full	600	1880	24.52	25.00	1.117	-0.03	0.788	0.880



<FDD LTE SAR>

Plot No.	Band	BW (MHz)	Modulation	RB Size	RB offset	Test Position	Gap (mm)	Headset	Power Reduction	Ch.	Freq. (MHz)	Average Power (dBm)	Tune-Up Limit (dBm)	Tune-up Scaling Factor	Power Drift (dB)	Measured 1g SAR (W/kg)	Reported 1g SAR (W/kg)
	LTE Band 71	20M	QPSK	1	99	Front	5mm	-	Full	133322	683	22.70	24.00	1.349	-0.05	0.607	0.819
56	LTE Band 71	20M	QPSK	1	99	Back	5mm	-	Full	133322	683	22.70	24.00	1.349	0.07	0.741	1.000
	LTE Band 71	20M	QPSK	50	24	Front	5mm	-	Full	133322	683	21.65	23.00	1.365	-0.02	0.344	0.469
	LTE Band 71	20M	QPSK	50	24	Back	5mm	-	Full	133322	683	21.65	23.00	1.365	0.14	0.384	0.524
	LTE Band 71	20M	QPSK	100	0	Front	5mm	-	Full	133322	683	21.64	23.00	1.368	-0.17	0.327	0.447
	LTE Band 71	20M	QPSK	100	0	Back	5mm	-	Full	133322	683	21.64	23.00	1.368	-0.16	0.393	0.538
	LTE Band 12	10M	QPSK	1	0	Front	5mm	-	Full	23095	707.5	22.90	24.00	1.288	0.02	0.634	0.817
57	LTE Band 12	10M	QPSK	1	0	Back	5mm	-	Full	23095	707.5	22.90	24.00	1.288	-0.1	0.707	0.911
	LTE Band 12	10M	QPSK	25	0	Front	5mm	-	Full	23095	707.5	21.68	23.00	1.355	0.08	0.330	0.447
	LTE Band 12	10M	QPSK	25	0	Back	5mm	-	Full	23095	707.5	21.68	23.00	1.355	0.03	0.394	0.534
	LTE Band 12	10M	QPSK	50	0	Front	5mm	-	Full	23095	707.5	21.51	23.00	1.409	0.02	0.312	0.440
	LTE Band 12	10M	QPSK	50	0	Back	5mm	-	Full	23095	707.5	21.51	23.00	1.409	0.05	0.375	0.528
	LTE Band 13	10M	QPSK	1	0	Front	5mm	-	Full	23230	782	22.63	24.00	1.371	-0.13	0.848	1.163
58	LTE Band 13	10M	QPSK	1	0	Back	5mm	-	Full	23230	782	22.63	24.00	1.371	0.09	0.904	1.239
	LTE Band 13	10M	QPSK	1	0	Back	5mm	Headset	Full	23230	782	22.63	24.00	1.371	-0.02	0.900	1.234
	LTE Band 13	10M	QPSK	25	12	Front	5mm	-	Full	23230	782	21.48	23.00	1.419	-0.09	0.455	0.646
	LTE Band 13	10M	QPSK	25	12	Back	5mm	-	Full	23230	782	21.48	23.00	1.419	-0.04	0.483	0.685
	LTE Band 13	10M	QPSK	50	0	Front	5mm	-	Full	23230	782	21.44	23.00	1.432	-0.06	0.471	0.675
	LTE Band 13	10M	QPSK	50	0	Back	5mm	-	Full	23230	782	21.44	23.00	1.432	-0.01	0.496	0.710
	LTE Band 14	10M	QPSK	1	49	Front	5mm	-	Full	23330	793	22.72	24.00	1.343	-0.06	0.689	0.925
59	LTE Band 14	10M	QPSK	1	49	Back	5mm	-	Full	23330	793	22.72	24.00	1.343	-0.12	0.718	0.964
	LTE Band 14	10M	QPSK	25	12	Front	5mm	-	Full	23330	793	21.47	23.00	1.422	-0.02	0.486	0.691
	LTE Band 14	10M	QPSK	25	12	Back	5mm	-	Full	23330	793	21.47	23.00	1.422	-0.05	0.493	0.701
	LTE Band 14	10M	QPSK	50	0	Front	5mm	-	Full	23330	793	21.54	23.00	1.400	-0.05	0.488	0.683
	LTE Band 14	10M	QPSK	50	0	Back	5mm	-	Full	23330	793	21.54	23.00	1.400	-0.1	0.496	0.694
	LTE Band 5	10M	QPSK	1	49	Front	5mm	-	Full	20525	836.5	23.11	24.00	1.227	-0.12	1.050	1.289
60	LTE Band 5	10M	QPSK	1	49	Back	5mm	-	Full	20525	836.5	23.11	24.00	1.227	-0.12	1.170	1.436
	LTE Band 5	10M	QPSK	1	49	Back	5mm	Headset	Full	20525	836.5	23.11	24.00	1.227	0.05	1.060	1.301
	LTE Band 5	10M	QPSK	1	49	Front	5mm	Headset	Full	20525	836.5	23.11	24.00	1.227	-0.12	0.980	1.203
	LTE Band 5	10M	QPSK	25	25	Front	5mm	-	Full	20525	836.5	21.90	23.00	1.288	-0.11	0.635	0.818
	LTE Band 5	10M	QPSK	25	25	Back	5mm	-	Full	20525	836.5	21.90	23.00	1.288	-0.03	0.677	0.872
	LTE Band 5	10M	QPSK	50	0	Front	5mm	-	Full	20525	836.5	21.88	23.00	1.294	-0.18	0.611	0.791
	LTE Band 5	10M	QPSK	50	0	Back	5mm	-	Full	20525	836.5	21.88	23.00	1.294	-0.06	0.659	0.853





Plot No.	Band	BW (MHz)	Modulation	RB Size	RB offset	Test Position	Gap (mm)	Headset	Power Reduction	Ch.	Freq. (MHz)	Average Power (dBm)	Tune-Up Limit (dBm)	Tune-up Scaling Factor	Power Drift (dB)	Measured 1g SAR (W/kg)	Reported 1g SAR (W/kg)
61	LTE Band 26	15M	QPSK	1	74	Front	5mm	-	Reduced	26865	831.5	22.09	23.00	1.233	-0.12	1.020	<b>1.258</b>
	LTE Band 26	15M	QPSK	1	74	Back	5mm	-	Reduced	26865	831.5	22.09	23.00	1.233	-0.07	0.841	1.037
	LTE Band 26	15M	QPSK	1	74	Front	5mm	-	Reduced	26765	821.5	21.96	23.00	1.271	-0.03	0.836	1.062
	LTE Band 26	15M	QPSK	1	74	Front	5mm	-	Reduced	26965	841.5	22.06	23.00	1.242	-0.03	1.000	1.242
	LTE Band 26	15M	QPSK	1	74	Back	5mm	-	Reduced	26765	821.5	21.96	23.00	1.271	-0.06	0.721	0.916
	LTE Band 26	15M	QPSK	1	74	Back	5mm	-	Reduced	26965	841.5	22.06	23.00	1.242	-0.15	0.899	1.116
	LTE Band 26	15M	QPSK	1	74	Front	5mm	Headset	Reduced	26865	831.5	22.09	23.00	1.233	-0.12	0.970	1.196
	LTE Band 26	15M	QPSK	1	74	Front	18mm	-	Full	26865	831.5	23.08	24.00	1.236	0.02	0.205	0.253
	LTE Band 26	15M	QPSK	1	74	Back	19mm	-	Full	26865	831.5	23.08	24.00	1.236	-0.01	0.162	0.200
	LTE Band 26	15M	QPSK	36	0	Front	5mm	-	Reduced	26865	831.5	21.84	23.00	1.306	-0.05	0.555	0.725
	LTE Band 26	15M	QPSK	36	0	Back	5mm	-	Reduced	26865	831.5	21.84	23.00	1.306	-0.05	0.425	0.555
	LTE Band 26	15M	QPSK	75	0	Front	5mm	-	Reduced	26865	831.5	21.68	23.00	1.355	-0.08	0.546	0.740
	LTE Band 26	15M	QPSK	75	0	Back	5mm	-	Reduced	26865	831.5	21.68	23.00	1.355	-0.02	0.427	0.579
	LTE Band 25	20M	QPSK	1	0	Front	5mm	-	Reduced	26590	1905	14.83	16.00	1.309	-0.15	0.921	1.206
	LTE Band 25	20M	QPSK	1	0	Front	5mm	-	Reduced	26140	1860	14.37	16.00	1.455	-0.05	0.871	1.268
	LTE Band 25	20M	QPSK	1	0	Front	5mm	-	Reduced	26340	1880	14.36	16.00	1.459	-0.1	0.886	1.293
	LTE Band 25	20M	QPSK	1	0	Back	5mm	-	Reduced	26590	1905	14.83	16.00	1.309	-0.13	0.861	1.127
	LTE Band 25	20M	QPSK	1	0	Back	5mm	-	Reduced	26140	1860	14.37	16.00	1.455	-0.02	0.822	1.196
	LTE Band 25	20M	QPSK	1	0	Back	5mm	-	Reduced	26340	1880	14.36	16.00	1.459	-0.03	0.843	1.230
	LTE Band 25	20M	QPSK	1	0	Front	5mm	Headset	Reduced	26340	1880	14.36	16.00	1.459	-0.1	0.842	1.228
	LTE Band 25	20M	QPSK	1	0	Back	5mm	Headset	Reduced	26340	1880	14.36	16.00	1.459	-0.03	0.813	1.186
	LTE Band 25	20M	QPSK	1	0	Front	18mm	-	Full	26590	1905	22.93	24.00	1.279	-0.13	0.700	0.896
	LTE Band 25	20M	QPSK	1	0	Back	19mm	-	Full	26590	1905	22.93	24.00	1.279	-0.11	0.733	0.938
	LTE Band 25	20M	QPSK	50	0	Front	5mm	-	Reduced	26590	1905	14.51	16.00	1.409	-0.01	0.938	1.322
	LTE Band 25	20M	QPSK	50	0	Front	5mm	-	Reduced	26140	1860	14.47	16.00	1.422	-0.13	0.872	1.240
62	LTE Band 25	20M	QPSK	50	0	Front	5mm	-	Reduced	26340	1880	14.34	16.00	1.466	-0.08	0.914	<b>1.340</b>
	LTE Band 25	20M	QPSK	50	0	Back	5mm	-	Reduced	26590	1905	14.51	16.00	1.409	-0.06	0.870	1.226
	LTE Band 25	20M	QPSK	50	0	Back	5mm	-	Reduced	26140	1860	14.47	16.00	1.422	-0.08	0.813	1.156
	LTE Band 25	20M	QPSK	50	0	Back	5mm	-	Reduced	26340	1880	14.34	16.00	1.466	-0.04	0.859	1.259
	LTE Band 25	20M	QPSK	50	0	Front	5mm	Headset	Reduced	26340	1880	14.34	16.00	1.466	0.02	0.840	1.231
	LTE Band 25	20M	QPSK	50	0	Back	5mm	Headset	Reduced	26340	1880	14.34	16.00	1.466	-0.04	0.812	1.190
	LTE Band 25	20M	QPSK	100	0	Front	5mm	-	Reduced	26590	1905	14.51	16.00	1.409	-0.07	0.922	1.299
	LTE Band 25	20M	QPSK	100	0	Back	5mm	-	Reduced	26590	1905	14.51	16.00	1.409	-0.04	0.882	1.243
	LTE Band 25	20M	QPSK	100	0	Front	5mm	Headset	Reduced	26590	1905	14.51	16.00	1.409	-0.07	0.899	1.267
	LTE Band 25	20M	QPSK	100	0	Back	5mm	Headset	Reduced	26590	1905	14.51	16.00	1.409	-0.04	0.871	1.227



Plot No.	Band	BW (MHz)	Modulation	RB Size	RB offset	Test Position	Gap (mm)	Headset	Power Reduction	Ch.	Freq. (MHz)	Average Power (dBm)	Tune-Up Limit (dBm)	Tune-up Scaling Factor	Power Drift (dB)	Measured 1g SAR (W/kg)	Reported 1g SAR (W/kg)
63	LTE Band 66	20M	QPSK	1	99	Front	5mm	-	Reduced	132572	1770	15.96	16.50	1.132	-0.07	1.200	<b>1.359</b>
	LTE Band 66	20M	QPSK	1	99	Front	5mm	-	Reduced	132072	1720	15.32	16.50	1.312	0.05	1.000	1.312
	LTE Band 66	20M	QPSK	1	99	Front	5mm	-	Reduced	132322	1745	15.73	16.50	1.194	-0.16	1.120	1.337
	LTE Band 66	20M	QPSK	1	99	Back	5mm	-	Reduced	132572	1770	15.96	16.50	1.132	-0.19	1.180	1.336
	LTE Band 66	20M	QPSK	1	99	Back	5mm	-	Reduced	132072	1720	15.32	16.50	1.312	-0.14	0.966	1.268
	LTE Band 66	20M	QPSK	1	99	Back	5mm	-	Reduced	132322	1745	15.73	16.50	1.194	0.12	1.110	1.325
	LTE Band 66	20M	QPSK	1	99	Front	5mm	Headset	Reduced	132572	1770	15.96	16.50	1.132	0.19	1.100	1.246
	LTE Band 66	20M	QPSK	1	99	Back	5mm	Headset	Reduced	132572	1770	15.96	16.50	1.132	-0.19	1.010	1.144
	LTE Band 66	20M	QPSK	1	99	Front	18mm	-	Full	132572	1770	23.36	24.00	1.159	0.11	0.729	0.845
	LTE Band 66	20M	QPSK	1	99	Back	19mm	-	Full	132572	1770	23.36	24.00	1.159	0.13	0.791	0.917
	LTE Band 66	20M	QPSK	50	50	Front	5mm	-	Reduced	132572	1770	15.81	16.50	1.172	-0.07	0.970	1.137
	LTE Band 66	20M	QPSK	50	50	Front	5mm	-	Reduced	132072	1720	15.28	16.50	1.324	0.03	0.851	1.127
	LTE Band 66	20M	QPSK	50	50	Front	5mm	-	Reduced	132322	1745	15.65	16.50	1.216	0.05	0.964	1.172
	LTE Band 66	20M	QPSK	50	50	Back	5mm	-	Reduced	132572	1770	15.81	16.50	1.172	-0.16	0.965	1.131
	LTE Band 66	20M	QPSK	50	50	Back	5mm	-	Reduced	132072	1720	15.28	16.50	1.324	-0.19	0.794	1.052
	LTE Band 66	20M	QPSK	50	50	Back	5mm	-	Reduced	132322	1745	15.65	16.50	1.216	-0.14	0.948	1.153
	LTE Band 66	20M	QPSK	100	0	Front	5mm	-	Reduced	132572	1770	15.77	16.50	1.183	-0.12	0.993	1.175
	LTE Band 66	20M	QPSK	100	0	Back	5mm	-	Reduced	132572	1770	15.77	16.50	1.183	-0.11	0.968	1.145
	LTE Band 7	20M	QPSK	1	99	Front	5mm	-	Reduced	21350	2560	19.22	19.50	1.067	-0.07	0.974	1.039
	LTE Band 7	20M	QPSK	1	99	Front	5mm	-	Reduced	20850	2510	18.93	19.50	1.140	0.03	0.954	1.088
	LTE Band 7	20M	QPSK	1	99	Front	5mm	-	Reduced	21100	2535	18.97	19.50	1.130	0.05	1.030	1.164
	LTE Band 7	20M	QPSK	1	99	Back	5mm	-	Reduced	21350	2560	19.22	19.50	1.067	-0.16	1.050	1.120
	LTE Band 7	20M	QPSK	1	99	Back	5mm	-	Reduced	20850	2510	18.93	19.50	1.140	-0.19	1.010	1.152
64	LTE Band 7	20M	QPSK	1	99	Back	5mm	-	Reduced	21100	2535	18.97	19.50	1.130	-0.14	1.120	<b>1.265</b>
	LTE Band 7	20M	QPSK	1	99	Back	5mm	Headset	Reduced	21100	2535	18.97	19.50	1.130	-0.12	1.060	1.198
	LTE Band 7	20M	QPSK	1	99	Front	18mm	-	Full	21350	2560	23.46	24.00	1.132	-0.12	0.273	0.309
	LTE Band 7	20M	QPSK	1	99	Back	19mm	-	Full	21350	2560	23.46	24.00	1.132	-0.11	0.266	0.301
	LTE Band 7	20M	QPSK	50	50	Front	5mm	-	Reduced	21350	2560	19.15	19.50	1.084	-0.02	0.920	0.997
	LTE Band 7	20M	QPSK	50	50	Front	5mm	-	Reduced	20850	2510	19.02	19.50	1.117	0.03	0.901	1.006
	LTE Band 7	20M	QPSK	50	50	Front	5mm	-	Reduced	21100	2535	19.07	19.50	1.104	0.06	0.929	1.026
	LTE Band 7	20M	QPSK	50	50	Back	5mm	-	Reduced	21350	2560	19.15	19.50	1.084	-0.11	1.000	1.084
	LTE Band 7	20M	QPSK	50	50	Back	5mm	-	Reduced	20850	2510	19.02	19.50	1.117	-0.12	0.961	1.073
	LTE Band 7	20M	QPSK	50	50	Back	5mm	-	Reduced	21100	2535	19.07	19.50	1.104	-0.17	1.020	1.126
	LTE Band 7	20M	QPSK	100	0	Front	5mm	-	Reduced	21350	2560	19.09	19.50	1.099	0.04	0.912	1.002
	LTE Band 7	20M	QPSK	100	0	Back	5mm	-	Reduced	21350	2560	19.09	19.50	1.099	-0.17	1.020	1.121
	LTE Band 30	10M	QPSK	1	0	Front	5mm	-	Reduced	27710	2310	20.26	21.00	1.186	0.01	0.899	1.066
	LTE Band 30	10M	QPSK	1	0	Back	5mm	-	Reduced	27710	2310	20.26	21.00	1.186	0.02	0.948	1.124
	LTE Band 30	10M	QPSK	1	0	Front	18mm	-	Full	27710	2310	22.92	24.00	1.282	0.04	0.246	0.315
	LTE Band 30	10M	QPSK	1	0	Back	19mm	-	Full	27710	2310	22.92	24.00	1.282	0.05	0.234	0.300
	LTE Band 30	10M	QPSK	25	25	Front	5mm	-	Reduced	27710	2310	20.10	21.00	1.230	0.05	0.922	1.134
65	LTE Band 30	10M	QPSK	25	25	Back	5mm	-	Reduced	27710	2310	20.10	21.00	1.230	-0.12	1.040	<b>1.279</b>
	LTE Band 30	10M	QPSK	25	25	Back	5mm	Headset	Reduced	27710	2310	20.10	21.00	1.230	-0.12	0.980	1.206
	LTE Band 30	10M	QPSK	50	0	Front	5mm	-	Reduced	27710	2310	20.01	21.00	1.256	0.14	0.899	1.129
	LTE Band 30	10M	QPSK	50	0	Back	5mm	-	Reduced	27710	2310	20.01	21.00	1.256	0.11	0.955	1.200
	LTE Band 30	10M	QPSK	50	0	Back	5mm	Headset	Reduced	27710	2310	20.01	21.00	1.256	0.11	0.914	1.148



<TDD LTE SAR>

Plot No.	Band	BW (MHz)	Modulation	RB Size	RB offset	Test Position	Gap (mm)	Headset	Power Reduction	Ch.	Freq. (MHz)	Average Power (dBm)	Tune-Up Limit (dBm)	Tune-up Scaling Factor	Duty Cycle %	Duty Cycle Scaling Factor	Power Drift (dB)	Measured 1g SAR (W/kg)	Reported 1g SAR (W/kg)
	LTE Band 41	20M	QPSK	1	49	Front	5mm	-	Reduced	41490	2680	19.93	21.00	1.279	62.9	1.006	0.11	0.865	1.113
	LTE Band 41	20M	QPSK	1	49	Back	5mm	-	Reduced	41490	2680	19.93	21.00	1.279	62.9	1.006	-0.18	1.020	1.313
	LTE Band 41	20M	QPSK	1	49	Front	5mm	-	Reduced	39750	2506	19.58	21.00	1.387	62.9	1.006	-0.13	0.728	1.016
	LTE Band 41	20M	QPSK	1	49	Front	5mm	-	Reduced	40185	2549.5	19.73	21.00	1.340	62.9	1.006	-0.05	0.773	1.042
	LTE Band 41	20M	QPSK	1	49	Front	5mm	-	Reduced	40620	2593	19.50	21.00	1.413	62.9	1.006	-0.03	0.806	1.145
	LTE Band 41	20M	QPSK	1	49	Front	5mm	-	Reduced	41055	2636.5	19.59	21.00	1.384	62.9	1.006	0.16	0.869	1.210
	LTE Band 41	20M	QPSK	1	49	Back	5mm	-	Reduced	39750	2506	19.58	21.00	1.387	62.9	1.006	-0.11	0.774	1.080
	LTE Band 41	20M	QPSK	1	49	Back	5mm	-	Reduced	40185	2549.5	19.73	21.00	1.340	62.9	1.006	-0.13	0.838	1.129
	LTE Band 41	20M	QPSK	1	49	Back	5mm	-	Reduced	40620	2593	19.50	21.00	1.413	62.9	1.006	-0.13	0.891	1.266
	LTE Band 41	20M	QPSK	1	49	Back	5mm	-	Reduced	41055	2636.5	19.59	21.00	1.384	62.9	1.006	-0.19	0.975	1.357
	LTE Band 41	20M	QPSK	1	49	Front	18mm	-	Full	41490	2680	24.02	25.00	1.253	62.9	1.006	0.04	0.277	0.349
	LTE Band 41	20M	QPSK	1	49	Back	19mm	-	Full	41490	2680	24.02	25.00	1.253	62.9	1.006	-0.08	0.257	0.324
	LTE Band 41	20M	QPSK	50	24	Front	5mm	-	Reduced	41490	2680	19.85	21.00	1.303	62.9	1.006	0.09	0.949	1.244
	LTE Band 41	20M	QPSK	50	24	Front	5mm	-	Reduced	39750	2506	19.58	21.00	1.387	62.9	1.006	0.08	0.768	1.071
	LTE Band 41	20M	QPSK	50	24	Front	5mm	-	Reduced	40185	2549.5	19.80	21.00	1.318	62.9	1.006	-0.08	0.800	1.061
	LTE Band 41	20M	QPSK	50	24	Front	5mm	-	Reduced	40620	2593	19.55	21.00	1.396	62.9	1.006	-0.02	0.820	1.152
	LTE Band 41	20M	QPSK	50	24	Front	5mm	-	Reduced	41055	2636.5	19.60	21.00	1.380	62.9	1.006	0.13	0.896	1.244
	LTE Band 41	20M	QPSK	50	24	Back	5mm	-	Reduced	41490	2680	19.85	21.00	1.303	62.9	1.006	-0.04	1.070	1.403
	LTE Band 41	20M	QPSK	50	24	Back	5mm	-	Reduced	39750	2506	19.58	21.00	1.387	62.9	1.006	-0.02	0.797	1.112
	LTE Band 41	20M	QPSK	50	24	Back	5mm	-	Reduced	40185	2549.5	19.80	21.00	1.318	62.9	1.006	-0.02	0.875	1.160
	LTE Band 41	20M	QPSK	50	24	Back	5mm	-	Reduced	40620	2593	19.55	21.00	1.396	62.9	1.006	-0.1	0.924	1.298
	LTE Band 41	20M	QPSK	50	24	Back	5mm	-	Reduced	41055	2636.5	19.60	21.00	1.380	62.9	1.006	-0.18	1.030	1.430
	LTE Band 41	20M	QPSK	100	0	Front	5mm	-	Reduced	41490	2680	19.90	21.00	1.288	62.9	1.006	0.16	0.977	1.266
66	LTE Band 41	20M	QPSK	100	0	Back	5mm	-	Reduced	41490	2680	19.90	21.00	1.288	62.9	1.006	-0.02	1.110	1.439
	LTE Band 41-HPUE	20M	QPSK	100	0	Back	5mm	-	Reduced	41490	2680	19.54	21.00	1.400	42.9	1.009	-0.03	0.696	0.983
	LTE Band 41C	20M	QPSK	100	0	Back	5mm		Reduced	39750(pcc)+39948(scc)	2506(pcc)+2525.8(scc)	19.83	21.00	1.309	62.9	1.006	0.03	0.767	1.010
	LTE Band 41C	20M	QPSK	100	0	Back	5mm		Reduced	40185(pcc)+39987(scc)	2549.5(pcc)+2529.7(scc)	19.69	21.00	1.352	62.9	1.006	0.05	0.676	0.919
	LTE Band 41C	20M	QPSK	100	0	Back	5mm		Reduced	40620(pcc)+40422(scc)	2593(pcc)+2573.2(scc)	19.42	21.00	1.439	62.9	1.006	0.08	0.609	0.881
	LTE Band 41C	20M	QPSK	100	0	Back	5mm		Reduced	41055(pcc)+40857(scc)	2636.5(pcc)+2616.7(scc)	19.5	21.00	1.413	62.9	1.006	0.04	0.659	0.936
	LTE Band 41C	20M	QPSK	100	0	Back	5mm		Reduced	41490(pcc)+41292(scc)	2682(pcc)+2660.2(scc)	19.56	21.00	1.393	62.9	1.006	0.01	0.779	1.092
	LTE Band 41	20M	QPSK	100	0	Back	5mm	Headset	Reduced	41490	2680	19.90	21.00	1.288	62.9	1.006	0.08	1.080	1.400
	LTE Band 41	20M	QPSK	100	0	Front	5mm	Headset	Reduced	41490	2680	19.90	21.00	1.288	62.9	1.006	0.16	0.940	1.218



<Bluetooth SAR>

Plot No.	Band	Mode	Test Position	Gap (mm)	Power Reduction	Ch.	Freq. (MHz)	Average Power (dBm)	Tune-Up Limit (dBm)	Tune-up Scaling Factor	Duty Cycle %	Duty Cycle Scaling Factor	Power Drift (dB)	Measured 1g SAR (W/kg)	Reported 1g SAR (W/kg)
	Bluetooth	DH5 1Mbps	Front	5mm	Full	39	2441	9.31	10.00	1.172	77.03	1.081	0.01	0.033	0.041
	Bluetooth	DH5 1Mbps	Back	5mm	Full	39	2441	9.31	10.00	1.172	77.03	1.081	0.02	0.055	0.069
67	Bluetooth	DH5 1Mbps	Back	5mm	Full	0	2402	8.32	10.00	1.473	77.03	1.081	0.14	0.050	0.079
	Bluetooth	DH5 1Mbps	Back	5mm	Full	78	2480	9.19	10.00	1.205	77.03	1.081	0.09	0.048	0.063

<WLAN2.4G SAR>

Plot No.	Band	Mode	Test Position	Gap (mm)	Power Reduction	Ch.	Freq. (MHz)	Average Power (dBm)	Tune-Up Limit (dBm)	Tune-up Scaling Factor	Duty Cycle %	Duty Cycle Scaling Factor	Power Drift (dB)	Measured 1g SAR (W/kg)	Reported 1g SAR (W/kg)
	WLAN2.4GHz	802.11b 1Mbps	Front	5mm	Reduced	11	2462	20.12	21.50	1.374	100	1.000	0.04	0.541	0.743
68	WLAN2.4GHz	802.11b 1Mbps	Back	5mm	Reduced	11	2462	20.12	21.50	1.374	100	1.000	0.02	0.839	1.153
	WLAN2.4GHz	802.11b 1Mbps	Back	5mm	Reduced	1	2412	20.09	21.50	1.384	100	1.000	0.18	0.778	1.076
	WLAN2.4GHz	802.11b 1Mbps	Back	5mm	Reduced	6	2437	20.05	21.50	1.396	100	1.000	0.15	0.787	1.099
	WLAN2.4GHz	802.11b 1Mbps	Front	18mm	Full	11	2462	21.11	22.50	1.377	100	1.000	0.11	0.111	0.153
	WLAN2.4GHz	802.11b 1Mbps	Back	19mm	Full	11	2462	21.11	22.50	1.377	100	1.000	0.12	0.164	0.226



<WLAN5G SAR>

Plot No.	Band	Mode	Test Position	Gap (mm)	Power Reduction	Ch.	Freq. (MHz)	Average Power (dBm)	Tune-Up Limit (dBm)	Tune-up Scaling Factor	Duty Cycle %	Duty Cycle Scaling Factor	Power Drift (dB)	Measured 1g SAR (W/kg)	Reported 1g SAR (W/kg)
	WLAN5.2GHz	802.11a 6Mbps	Front	5mm	Reduced	36	5180	9.69	11.00	1.352	98.28	1.018	0.09	0.001	0.001
	WLAN5.2GHz	802.11a 6Mbps	Back	5mm	Reduced	36	5180	9.69	11.00	1.352	98.28	1.018	0.07	0.838	1.153
	WLAN5.2GHz	802.11a 6Mbps	Back	5mm	Reduced	40	5200	9.56	11.00	1.393	98.28	1.018	-0.12	0.814	1.154
	WLAN5.2GHz	802.11a 6Mbps	Back	5mm	Reduced	44	5220	9.66	11.00	1.361	98.28	1.018	0.12	0.817	1.132
	WLAN5.2GHz	802.11a 6Mbps	Back	5mm	Reduced	48	5240	9.53	11.00	1.403	98.28	1.018	0.09	0.765	1.092
	WLAN5.3GHz	802.11a 6Mbps	Front	5mm	Reduced	60	5300	9.55	11.00	1.396	98.28	1.018	0.13	0.000	0.000
	WLAN5.3GHz	802.11a 6Mbps	Back	5mm	Reduced	60	5300	9.55	11.00	1.396	98.28	1.018	0.14	0.648	0.921
	WLAN5.3GHz	802.11a 6Mbps	Back	5mm	Reduced	52	5260	9.17	11.00	1.524	98.28	1.018	0.03	0.671	1.041
	WLAN5.3GHz	802.11a 6Mbps	Back	5mm	Reduced	56	5280	9.22	11.00	1.507	98.28	1.018	-0.05	0.671	1.029
	WLAN5.3GHz	802.11a 6Mbps	Back	5mm	Reduced	64	5320	9.41	11.00	1.442	98.28	1.018	0.12	0.650	0.954
	WLAN5.3GHz	802.11a 6Mbps	Front	18mm	Full	60	5300	17.91	19.50	1.442	98.28	1.018	0.15	0.009	0.013
	WLAN5.3GHz	802.11a 6Mbps	Back	19mm	Full	56	5280	17.84	19.50	1.466	98.28	1.018	0.02	0.907	1.353
	WLAN5.3GHz	802.11a 6Mbps	Back	19mm	Full	52	5260	17.80	19.50	1.479	98.28	1.018	0.02	0.894	1.346
	WLAN5.3GHz	802.11a 6Mbps	Back	19mm	Full	60	5300	17.91	19.50	1.442	98.28	1.018	0.12	0.919	1.349
69	WLAN5.3GHz	802.11a 6Mbps	Back	19mm	Full	64	5320	17.86	19.50	1.459	98.28	1.018	0.13	0.927	1.377
	WLAN5.5GHz	802.11a 6Mbps	Front	5mm	Reduced	140	5700	10.11	11.50	1.377	98.28	1.018	0.04	0.023	0.032
	WLAN5.5GHz	802.11a 6Mbps	Back	5mm	Reduced	140	5700	10.11	11.50	1.377	98.28	1.018	-0.05	0.726	1.018
	WLAN5.5GHz	802.11a 6Mbps	Back	5mm	Reduced	100	5500	9.99	11.50	1.416	98.28	1.018	0.12	0.824	1.188
	WLAN5.5GHz	802.11a 6Mbps	Back	5mm	Reduced	116	5580	10.06	11.50	1.393	98.28	1.018	0.15	0.767	1.088
	WLAN5.5GHz	802.11a 6Mbps	Back	5mm	Reduced	132	5660	10.09	11.50	1.384	98.28	1.018	0.02	0.833	1.173
	WLAN5.5GHz	802.11a 6Mbps	Front	18mm	Full	140	5700	18.10	19.50	1.382	98.28	1.018	-0.04	0.014	0.020
	WLAN5.5GHz	802.11a 6Mbps	Back	19mm	Full	100	5500	17.91	19.50	1.444	98.28	1.018	0.13	0.851	1.251
	WLAN5.5GHz	802.11a 6Mbps	Back	19mm	Full	116	5580	17.94	19.50	1.434	98.28	1.018	-0.04	0.891	1.300
70	WLAN5.5GHz	802.11a 6Mbps	Back	19mm	Full	132	5660	18.17	19.50	1.360	98.28	1.018	0.02	0.984	1.362
	WLAN5.5GHz	802.11a 6Mbps	Back	19mm	Full	140	5700	18.10	19.50	1.382	98.28	1.018	0.11	0.904	1.272
	WLAN5.8GHz	802.11a 6Mbps	Front	5mm	Reduced	149	5745	9.69	11.00	1.354	98.28	1.018	0.03	0.006	0.008
	WLAN5.8GHz	802.11a 6Mbps	Back	5mm	Reduced	149	5745	9.69	11.00	1.354	98.28	1.018	-0.02	0.855	1.178
	WLAN5.8GHz	802.11a 6Mbps	Back	5mm	Reduced	157	5785	8.73	10.00	1.341	98.28	1.018	-0.05	0.873	1.192
	WLAN5.8GHz	802.11a 6Mbps	Back	5mm	Reduced	165	5825	8.89	10.00	1.293	98.28	1.018	0.01	0.894	1.176
	WLAN5.8GHz	802.11a 6Mbps	Front	18mm	Full	149	5745	15.87	17.50	1.457	98.28	1.018	0.05	0.009	0.014
71	WLAN5.8GHz	802.11a 6Mbps	Back	19mm	Full	149	5745	15.87	17.50	1.457	98.28	1.018	0.06	0.886	1.314
	WLAN5.8GHz	802.11a 6Mbps	Back	19mm	Full	157	5785	15.44	16.50	1.278	98.28	1.018	-0.04	0.921	1.198
	WLAN5.8GHz	802.11a 6Mbps	Back	19mm	Full	165	5825	15.24	16.50	1.338	98.28	1.018	0.02	0.935	1.274



**15.4 Product Specific SAR**

**<GSM SAR>**

Plot No.	Band	Mode	Test Position	Gap (mm)	Power Reduction	Ch.	Freq. (MHz)	Average Power (dBm)	Tune-Up Limit (dBm)	Tune-up Scaling Factor	Power Drift (dB)	Measured 10g SAR (W/kg)	Reported 10g SAR (W/kg)
	GSM850	GPRS 2 Tx slots	Front	0mm	Full	189	836.4	30.40	31.50	1.288	-0.05	1.120	1.443
72	GSM850	GPRS 2 Tx slots	Back	0mm	Full	189	836.4	30.40	31.50	1.288	0.15	1.190	<b>1.533</b>
	GSM850	GPRS 2 Tx slots	Back	0mm	Full	128	824.2	30.32	31.50	1.312	-0.01	0.882	1.157
	GSM850	GPRS 2 Tx slots	Back	0mm	Full	251	848.8	30.02	31.50	1.406	-0.05	1.010	1.420
73	GSM1900	GPRS 2 Tx slots	Front	0mm	Reduced	661	1880	24.41	26.00	1.442	0.03	1.520	<b>2.192</b>
	GSM1900	GPRS 2 Tx slots	Front	0mm	Reduced	512	1850.2	24.33	26.00	1.469	0.05	1.470	2.159
	GSM1900	GPRS 2 Tx slots	Front	0mm	Reduced	810	1909.8	24.39	26.00	1.449	-0.01	1.190	1.724
	GSM1900	GPRS 2 Tx slots	Back	0mm	Reduced	661	1880	24.41	26.00	1.442	0.03	1.390	2.005
	GSM1900	GPRS 2 Tx slots	Back	0mm	Reduced	512	1850.2	24.33	26.00	1.469	0.04	1.400	2.056
	GSM1900	GPRS 2 Tx slots	Back	0mm	Reduced	810	1909.8	24.39	26.00	1.449	-0.01	1.140	1.652
	GSM1900	GPRS 2 Tx slots	Bottom Side	0mm	Reduced	661	1880	24.41	26.00	1.442	-0.11	0.832	1.200
	GSM1900	GPRS 2 Tx slots	Front	15mm	Full	661	1880	27.82	29.00	1.312	0.03	0.520	0.682
	GSM1900	GPRS 2 Tx slots	Back	17mm	Full	512	1850.2	27.75	29.00	1.334	0.09	0.420	0.560
	GSM1900	GPRS 2 Tx slots	Bottom Side	18mm	Full	661	1880	27.82	29.00	1.312	0.02	0.720	0.945

**<WCDMA SAR>**

Plot No.	Band	Mode	Test Position	Gap (mm)	Power Reduction	Ch.	Freq. (MHz)	Average Power (dBm)	Tune-Up Limit (dBm)	Tune-up Scaling Factor	Power Drift (dB)	Measured 10g SAR (W/kg)	Reported 10g SAR (W/kg)
	WCDMA V	RMC 12.2Kbps	Front	0mm	Full	4233	846.6	23.29	24.00	1.178	-0.07	2.120	2.497
	WCDMA V	RMC 12.2Kbps	Front	0mm	Full	4132	826.4	23.02	24.00	1.253	-0.04	1.980	2.481
74	WCDMA V	RMC 12.2Kbps	Front	0mm	Full	4182	836.4	23.03	24.00	1.250	-0.07	2.040	<b>2.551</b>
	WCDMA V	RMC 12.2Kbps	Back	0mm	Full	4233	846.6	23.29	24.00	1.178	-0.04	1.620	1.908
	WCDMA V	RMC 12.2Kbps	Bottom Side	0mm	Full	4233	846.6	23.29	24.00	1.178	-0.03	1.590	1.872
	WCDMA IV	RMC 12.2Kbps	Front	0mm	Reduced	1513	1752.6	16.15	17.50	1.365	0.02	1.570	2.142
75	WCDMA IV	RMC 12.2Kbps	Front	0mm	Reduced	1312	1712.4	16.12	17.50	1.374	0.03	1.590	<b>2.185</b>
	WCDMA IV	RMC 12.2Kbps	Front	0mm	Reduced	1413	1732.6	16.01	17.50	1.409	-0.02	1.520	2.142
	WCDMA IV	RMC 12.2Kbps	Back	0mm	Reduced	1513	1752.6	16.15	17.50	1.365	0.05	1.530	2.088
	WCDMA IV	RMC 12.2Kbps	Back	0mm	Reduced	1312	1712.4	16.12	17.50	1.374	0.01	1.560	2.144
	WCDMA IV	RMC 12.2Kbps	Back	0mm	Reduced	1413	1732.6	16.01	17.50	1.409	-0.14	1.490	2.100
	WCDMA IV	RMC 12.2Kbps	Bottom Side	0mm	Reduced	1513	1752.6	16.15	17.50	1.365	0.04	1.430	1.951
	WCDMA IV	RMC 12.2Kbps	Front	15mm	Full	1312	1712.4	22.75	24.00	1.334	-0.11	0.911	1.215
	WCDMA IV	RMC 12.2Kbps	Back	17mm	Full	1312	1712.4	22.75	24.00	1.334	-0.18	0.737	0.983
	WCDMA IV	RMC 12.2Kbps	Bottom Side	18mm	Full	1312	1712.4	22.75	24.00	1.334	0.04	1.050	1.400
76	WCDMA II	RMC 12.2Kbps	Front	0mm	Reduced	9538	1907.6	17.51	18.50	1.256	-0.02	1.650	<b>2.072</b>
	WCDMA II	RMC 12.2Kbps	Front	0mm	Reduced	9400	1880	17.47	18.50	1.268	0.03	1.420	1.800
	WCDMA II	RMC 12.2Kbps	Front	0mm	Reduced	9262	1852.4	17.46	18.50	1.271	0.05	1.610	2.046
	WCDMA II	RMC 12.2Kbps	Back	0mm	Reduced	9538	1907.6	17.51	18.50	1.256	0.04	1.560	1.959
	WCDMA II	RMC 12.2Kbps	Bottom Side	0mm	Reduced	9400	1880	17.47	18.50	1.268	-0.11	1.270	1.610
	WCDMA II	RMC 12.2Kbps	Front	15mm	Full	9538	1907.6	22.99	24.00	1.262	0.03	0.827	1.044
	WCDMA II	RMC 12.2Kbps	Back	17mm	Full	9538	1907.6	22.99	24.00	1.262	-0.05	0.667	0.842
	WCDMA II	RMC 12.2Kbps	Bottom Side	18mm	Full	9538	1907.6	22.99	24.00	1.262	-0.01	1.150	1.451



<CDMA SAR>

Plot No.	Band	Mode	Test Position	Gap (mm)	Power Reduction	Ch.	Freq. (MHz)	Average Power (dBm)	Tune-Up Limit (dBm)	Tune-up Scaling Factor	Power Drift (dB)	Measured 10g SAR (W/kg)	Reported 10g SAR (W/kg)
	CDMA2000 BC0	RTAP 153.6Kbps	Front	0mm	Full	777	848.31	24.25	25.00	1.189	0.15	1.760	2.092
77	CDMA2000 BC0	RTAP 153.6Kbps	Front	0mm	Full	1013	824.7	23.85	25.00	1.303	0.17	1.950	2.541
	CDMA2000 BC0	RTAP 153.6Kbps	Front	0mm	Full	384	836.52	23.94	25.00	1.276	0.09	1.600	2.042
	CDMA2000 BC0	RTAP 153.6Kbps	Back	0mm	Full	777	848.31	24.25	25.00	1.189	0.1	1.450	1.723
	CDMA2000 BC1	RTAP 153.6Kbps	Front	0mm	Reduced	600	1880	19.07	20.00	1.239	0.06	1.760	2.180
78	CDMA2000 BC1	RTAP 153.6Kbps	Front	0mm	Reduced	25	1851.25	19.04	20.00	1.247	-0.02	1.800	2.245
	CDMA2000 BC1	RTAP 153.6Kbps	Front	0mm	Reduced	1175	1908.75	18.97	20.00	1.268	-0.08	1.770	2.244
	CDMA2000 BC1	RTAP 153.6Kbps	Back	0mm	Reduced	600	1880	19.07	20.00	1.239	-0.09	1.660	2.056
	CDMA2000 BC1	RTAP 153.6Kbps	Back	0mm	Reduced	25	1851.25	19.04	20.00	1.247	-0.15	1.680	2.096
	CDMA2000 BC1	RTAP 153.6Kbps	Back	0mm	Reduced	1175	1908.75	18.97	20.00	1.268	-0.19	1.640	2.079
	CDMA2000 BC1	RTAP 153.6Kbps	Bottom Side	0mm	Reduced	600	1880	19.07	20.00	1.239	-0.12	1.480	1.833
	CDMA2000 BC1	RTAP 153.6Kbps	Front	15mm	Full	25	1851.25	23.72	25.00	1.343	0.01	0.599	0.804
	CDMA2000 BC1	RTAP 153.6Kbps	Back	17mm	Full	25	1851.25	23.72	25.00	1.343	-0.07	0.499	0.670
	CDMA2000 BC1	RTAP 153.6Kbps	Bottom Side	18mm	Full	25	1851.25	23.72	25.00	1.343	-0.07	0.925	1.242

<FDD LTE SAR>

Plot No.	Band	BW (MHz)	Modulation	RB Size	RB offset	Test Position	Gap (mm)	Power Reduction	Ch.	Freq. (MHz)	Average Power (dBm)	Tune-Up Limit (dBm)	Tune-up Scaling Factor	Power Drift (dB)	Measured 10g SAR (W/kg)	Reported 10g SAR (W/kg)
79	LTE Band 13	10M	QPSK	1	0	Back	0mm	Full	23230	782	22.63	24.00	1.371	0.11	1.410	1.933
	LTE Band 13	10M	QPSK	25	12	Back	0mm	Full	23230	782	21.48	23.00	1.419	-0.03	0.718	1.019
	LTE Band 13	10M	QPSK	50	0	Back	0mm	Full	23230	782	21.44	23.00	1.432	-0.05	0.667	0.955
80	LTE Band 5	10M	QPSK	1	49	Front	0mm	Full	20525	836.5	23.11	24.00	1.227	-0.11	2.110	2.590
	LTE Band 5	10M	QPSK	1	49	Back	0mm	Full	20525	836.5	23.11	24.00	1.227	-0.09	1.580	1.939
	LTE Band 5	10M	QPSK	1	49	Bottom Side	0mm	Full	20525	836.5	23.11	24.00	1.227	-0.06	1.570	1.927
	LTE Band 5	10M	QPSK	25	25	Front	0mm	Full	20525	836.5	21.90	23.00	1.288	0.09	0.973	1.253
	LTE Band 5	10M	QPSK	25	25	Back	0mm	Full	20525	836.5	21.90	23.00	1.288	0.02	0.837	1.078
	LTE Band 5	10M	QPSK	25	25	Bottom Side	0mm	Full	20525	836.5	21.90	23.00	1.288	0.03	0.721	0.929
	LTE Band 5	10M	QPSK	50	0	Front	0mm	Full	20525	836.5	21.88	23.00	1.294	0.03	0.943	1.220
	LTE Band 26	15M	QPSK	1	74	Front	0mm	Full	26865	831.5	23.08	24.00	1.236	0.07	1.760	2.175
	LTE Band 26	15M	QPSK	1	74	Back	0mm	Full	26865	831.5	23.08	24.00	1.236	0.09	1.460	1.804
	LTE Band 26	15M	QPSK	1	74	Bottom Side	0mm	Full	26865	831.5	23.08	24.00	1.236	-0.1	1.100	1.360
81	LTE Band 26	15M	QPSK	1	74	Front	0mm	Full	26765	821.5	23.05	24.00	1.245	0.1	1.760	2.190
	LTE Band 26	15M	QPSK	1	74	Front	0mm	Full	26965	841.5	23.07	24.00	1.239	-0.03	1.750	2.168
	LTE Band 26	15M	QPSK	36	0	Front	0mm	Full	26865	831.5	21.75	23.00	1.334	0.05	0.978	1.304
	LTE Band 26	15M	QPSK	36	0	Back	0mm	Full	26865	831.5	21.75	23.00	1.334	0.12	0.664	0.885
	LTE Band 26	15M	QPSK	36	0	Bottom Side	0mm	Full	26865	831.5	21.75	23.00	1.334	0.08	0.630	0.840
	LTE Band 26	15M	QPSK	75	0	Front	0mm	Full	26865	831.5	21.68	23.00	1.355	0.07	0.871	1.180



Plot No.	Band	BW (MHz)	Modulation	RB Size	RB offset	Test Position	Gap (mm)	Power Reduction	Ch.	Freq. (MHz)	Average Power (dBm)	Tune-Up Limit (dBm)	Tune-up Scaling Factor	Power Drift (dB)	Measured 10g SAR (W/kg)	Reported 10g SAR (W/kg)
	LTE Band 25	20M	QPSK	1	0	Front	0mm	Reduced	26340	1880	19.94	20.50	1.138	0.01	1.940	2.207
82	LTE Band 25	20M	QPSK	1	0	Front	0mm	Reduced	26140	1860	19.69	20.50	1.205	0.01	2.340	<b>2.820</b>
	LTE Band 25	20M	QPSK	1	0	Front	0mm	Reduced	26590	1905	19.77	20.50	1.183	0.03	2.130	2.520
	LTE Band 25	20M	QPSK	50	0	Front	0mm	Reduced	26340	1880	19.80	20.50	1.175	0.01	1.940	2.279
	LTE Band 25	20M	QPSK	50	0	Front	0mm	Reduced	26140	1860	19.69	20.50	1.205	-0.05	2.290	2.760
	LTE Band 25	20M	QPSK	50	0	Front	0mm	Reduced	26590	1905	19.73	20.50	1.194	0.05	2.100	2.507
	LTE Band 25	20M	QPSK	100	0	Front	0mm	Reduced	26340	1880	19.79	20.50	1.178	0.08	2.080	2.449
	LTE Band 25	20M	QPSK	1	0	Back	0mm	Reduced	26340	1880	19.94	20.50	1.138	-0.02	1.920	2.184
	LTE Band 25	20M	QPSK	1	0	Back	0mm	Reduced	26140	1860	19.69	20.50	1.205	0.03	2.100	2.531
	LTE Band 25	20M	QPSK	1	0	Back	0mm	Reduced	26590	1905	19.77	20.50	1.183	0.04	1.900	2.248
	LTE Band 25	20M	QPSK	50	0	Back	0mm	Reduced	26340	1880	19.80	20.50	1.175	0.09	1.800	2.115
	LTE Band 25	20M	QPSK	50	0	Back	0mm	Reduced	26140	1860	19.69	20.50	1.205	0.05	2.040	2.458
	LTE Band 25	20M	QPSK	50	0	Back	0mm	Reduced	26590	1905	19.73	20.50	1.194	0.04	1.760	2.101
	LTE Band 25	20M	QPSK	100	0	Back	0mm	Reduced	26340	1880	19.79	20.50	1.178	-0.04	1.800	2.120
	LTE Band 25	20M	QPSK	1	0	Bottom Side	0mm	Reduced	26340	1880	19.94	20.50	1.138	0.07	1.435	1.632
	LTE Band 25	20M	QPSK	50	0	Bottom Side	0mm	Reduced	26340	1880	19.80	20.50	1.175	0.08	1.468	1.725
	LTE Band 25	20M	QPSK	1	0	Front	15mm	Full	26590	1905	22.93	24.00	1.279	-0.08	0.822	1.052
	LTE Band 25	20M	QPSK	1	0	Back	17mm	Full	26590	1905	22.93	24.00	1.279	-0.07	0.754	0.965
	LTE Band 25	20M	QPSK	1	0	Bottom Side	18mm	Full	26590	1905	22.93	24.00	1.279	0.11	1.250	1.599
83	LTE Band 66	20M	QPSK	1	0	Front	0mm	Reduced	132322	1745	19.22	20.00	1.197	-0.01	2.730	<b>3.267</b>
	LTE Band 66	20M	QPSK	1	0	Front	0mm	Reduced	132072	1720	19.03	20.00	1.250	0.05	2.580	3.226
	LTE Band 66	20M	QPSK	1	0	Front	0mm	Reduced	132572	1770	19.19	20.00	1.205	0.04	2.690	3.242
	LTE Band 66	20M	QPSK	50	0	Front	0mm	Reduced	132322	1745	19.01	20.00	1.256	0.01	2.420	3.040
	LTE Band 66	20M	QPSK	50	0	Front	0mm	Reduced	132072	1720	18.96	20.00	1.271	0.07	2.540	3.227
	LTE Band 66	20M	QPSK	50	0	Front	0mm	Reduced	132572	1770	18.88	20.00	1.294	-0.08	2.440	3.158
	LTE Band 66	20M	QPSK	100	0	Front	0mm	Reduced	132322	1745	18.93	20.00	1.279	-0.03	2.510	3.211
	LTE Band 66	20M	QPSK	1	0	Back	0mm	Reduced	132322	1745	19.22	20.00	1.197	-0.05	2.130	2.549
	LTE Band 66	20M	QPSK	1	0	Back	0mm	Reduced	132072	1720	19.03	20.00	1.250	0.05	2.520	3.151
	LTE Band 66	20M	QPSK	1	0	Back	0mm	Reduced	132572	1770	19.19	20.00	1.205	0.01	2.470	2.976
	LTE Band 66	20M	QPSK	50	0	Back	0mm	Reduced	132322	1745	19.01	20.00	1.256	0.04	2.230	2.801
	LTE Band 66	20M	QPSK	50	0	Back	0mm	Reduced	132072	1720	18.96	20.00	1.271	-0.02	2.330	2.960
	LTE Band 66	20M	QPSK	50	0	Back	0mm	Reduced	132572	1770	18.88	20.00	1.294	0.03	2.220	2.873
	LTE Band 66	20M	QPSK	100	0	Back	0mm	Reduced	132322	1745	18.93	20.00	1.279	0.05	2.260	2.891
	LTE Band 66	20M	QPSK	1	0	Bottom Side	0mm	Reduced	132322	1745	19.22	20.00	1.197	0.07	2.350	2.812
	LTE Band 66	20M	QPSK	1	0	Bottom Side	0mm	Reduced	132072	1720	19.03	20.00	1.250	-0.08	2.310	2.888
	LTE Band 66	20M	QPSK	1	0	Bottom Side	0mm	Reduced	132572	1770	19.19	20.00	1.205	0.06	2.020	2.434
	LTE Band 66	20M	QPSK	50	0	Bottom Side	0mm	Reduced	132322	1745	19.01	20.00	1.256	0.08	2.100	2.638
	LTE Band 66	20M	QPSK	50	0	Bottom Side	0mm	Reduced	132072	1720	18.96	20.00	1.271	0.03	2.170	2.757
	LTE Band 66	20M	QPSK	50	0	Bottom Side	0mm	Reduced	132572	1770	18.88	20.00	1.294	0.01	1.770	2.291
	LTE Band 66	20M	QPSK	100	0	Bottom Side	0mm	Reduced	132322	1745	18.93	20.00	1.279	-0.01	1.910	2.444
	LTE Band 66	20M	QPSK	1	99	Front	15mm	Full	132572	1770	23.36	24.00	1.159	-0.08	0.674	0.781
	LTE Band 66	20M	QPSK	1	99	Back	17mm	Full	132572	1770	23.36	24.00	1.159	-0.06	0.587	0.680
	LTE Band 66	20M	QPSK	1	99	Bottom Side	18mm	Full	132572	1770	23.36	24.00	1.159	-0.08	1.040	1.205





Plot No.	Band	BW (MHz)	Modulation	RB Size	RB offset	Test Position	Gap (mm)	Power Reduction	Ch.	Freq. (MHz)	Average Power (dBm)	Tune-Up Limit (dBm)	Tune-up Scaling Factor	Power Drift (dB)	Measured 10g SAR (W/kg)	Reported 10g SAR (W/kg)
	LTE Band 7	20M	QPSK	1	99	Front	0mm	Reduced	21350	2560	19.52	20.00	1.117	-0.15	1.820	2.033
	LTE Band 7	20M	QPSK	1	99	Front	0mm	Reduced	20850	2510	19.27	20.00	1.183	-0.19	1.850	2.189
	LTE Band 7	20M	QPSK	1	99	Front	0mm	Reduced	21100	2535	19.42	20.00	1.143	0.03	1.870	2.137
	LTE Band 7	20M	QPSK	1	99	Back	0mm	Reduced	21350	2560	19.52	20.00	1.117	0.07	1.900	2.122
	LTE Band 7	20M	QPSK	1	99	Back	0mm	Reduced	20850	2510	19.27	20.00	1.183	0.05	1.900	2.248
	LTE Band 7	20M	QPSK	1	99	Back	0mm	Reduced	21100	2535	19.42	20.00	1.143	0.03	1.920	2.194
	LTE Band 7	20M	QPSK	1	99	Bottom Side	0mm	Reduced	21350	2560	19.52	20.00	1.117	0.07	1.540	1.720
	LTE Band 7	20M	QPSK	1	99	Left Side	0mm	Reduced	21350	2560	19.52	20.00	1.117	-0.15	1.490	1.664
	LTE Band 7	20M	QPSK	1	99	Front	7mm	Full	21350	2560	23.46	24.00	1.132	0.05	0.683	0.773
	LTE Band 7	20M	QPSK	1	99	Back	7mm	Full	21350	2560	23.46	24.00	1.132	-0.08	0.714	0.809
	LTE Band 7	20M	QPSK	1	99	Bottom Side	8mm	Full	21350	2560	23.46	24.00	1.132	-0.05	0.423	0.479
	LTE Band 7	20M	QPSK	1	99	Left Side	8mm	Full	21350	2560	23.46	24.00	1.132	-0.05	0.458	0.519
	LTE Band 7	20M	QPSK	50	50	Front	0mm	Reduced	21350	2560	19.17	20.00	1.211	0.04	1.720	2.082
	LTE Band 7	20M	QPSK	50	50	Front	0mm	Reduced	20850	2510	19.15	20.00	1.216	-0.1	1.830	2.226
	LTE Band 7	20M	QPSK	50	50	Front	0mm	Reduced	21100	2535	19.10	20.00	1.230	0.12	1.760	2.165
	LTE Band 7	20M	QPSK	50	50	Back	0mm	Reduced	21350	2560	19.17	20.00	1.211	0.03	1.810	2.191
84	LTE Band 7	20M	QPSK	50	50	Back	0mm	Reduced	20850	2510	19.15	20.00	1.216	-0.06	1.850	2.250
	LTE Band 7	20M	QPSK	50	50	Back	0mm	Reduced	21100	2535	19.10	20.00	1.230	-0.11	1.790	2.202
	LTE Band 7	20M	QPSK	50	50	Bottom Side	0mm	Reduced	21350	2560	19.17	20.00	1.211	-0.12	1.550	1.876
	LTE Band 7	20M	QPSK	50	50	Left Side	0mm	Reduced	21350	2560	19.17	20.00	1.211	-0.15	1.460	1.767
	LTE Band 7	20M	QPSK	100	0	Front	0mm	Reduced	21350	2560	19.15	20.00	1.216	0.11	1.710	2.080
	LTE Band 7	20M	QPSK	100	0	Back	0mm	Reduced	21350	2560	19.15	20.00	1.216	0.13	1.840	2.238
	LTE Band 7	20M	QPSK	100	0	Bottom Side	0mm	Reduced	21350	2560	19.15	20.00	1.216	0.12	1.780	2.165
	LTE Band 30	10M	QPSK	1	0	Front	0mm	Reduced	27710	2310	19.57	20.50	1.239	0.11	1.600	1.982
	LTE Band 30	10M	QPSK	1	0	Back	0mm	Reduced	27710	2310	19.57	20.50	1.239	0.12	1.610	1.994
	LTE Band 30	10M	QPSK	1	0	Left Side	0mm	Reduced	27710	2310	19.57	20.50	1.239	0.04	1.450	1.796
	LTE Band 30	10M	QPSK	1	0	Bottom Side	0mm	Reduced	27710	2310	19.57	20.50	1.239	0.09	1.210	1.499
	LTE Band 30	10M	QPSK	1	0	Front	7mm	Full	27710	2310	22.92	24.00	1.282	-0.04	0.400	0.513
	LTE Band 30	10M	QPSK	1	0	Back	7mm	Full	27710	2310	22.92	24.00	1.282	0.1	0.671	0.860
	LTE Band 30	10M	QPSK	1	0	Bottom Side	8mm	Full	27710	2310	22.92	24.00	1.282	0.11	0.389	0.499
	LTE Band 30	10M	QPSK	1	0	Left Side	8mm	Full	27710	2310	22.92	24.00	1.282	0.11	0.427	0.548
	LTE Band 30	10M	QPSK	25	25	Front	0mm	Reduced	27710	2310	19.35	20.50	1.303	0.03	1.640	2.137
85	LTE Band 30	10M	QPSK	25	25	Back	0mm	Reduced	27710	2310	19.35	20.50	1.303	0.11	1.660	2.163
	LTE Band 30	10M	QPSK	25	25	Left Side	0mm	Reduced	27710	2310	19.35	20.50	1.303	0.15	1.450	1.890
	LTE Band 30	10M	QPSK	25	25	Bottom Side	0mm	Reduced	27710	2310	19.35	20.50	1.303	-0.01	1.280	1.668
	LTE Band 30	10M	QPSK	50	0	Front	0mm	Reduced	27710	2310	19.32	20.50	1.312	0.11	1.570	2.060
	LTE Band 30	10M	QPSK	50	0	Back	0mm	Reduced	27710	2310	19.32	20.50	1.312	-0.18	1.640	2.152



<TDD LTE SAR>

Plot No.	Band	BW (MHz)	Modulation	RB Size	RB offset	Test Position	Gap (mm)	Power Reduction	Ch.	Freq. (MHz)	Average Power (dBm)	Tune-Up Limit (dBm)	Tune-up Scaling Factor	Duty Cycle %	Duty Cycle Scaling Factor	Power Drift (dB)	Measured 10g SAR (W/kg)	Reported 10g SAR (W/kg)
	LTE Band 41	20M	QPSK	1	49	Front	0mm	Reduced	41490	2680	21.08	22.00	1.236	62.9	1.006	0.11	1.450	1.803
	LTE Band 41	20M	QPSK	1	49	Back	0mm	Reduced	41490	2680	21.08	22.00	1.236	62.9	1.006	0.09	1.480	1.840
	LTE Band 41	20M	QPSK	1	49	Bottom Side	0mm	Reduced	41490	2680	21.08	22.00	1.236	62.9	1.006	0.04	0.791	0.984
	LTE Band 41	20M	QPSK	1	49	Left Side	0mm	Reduced	41490	2680	21.08	22.00	1.236	62.9	1.006	0.03	1.300	1.616
	LTE Band 41	20M	QPSK	1	49	Back	0mm	Reduced	39750	2506	20.63	22.00	1.371	62.9	1.006	0.04	1.520	2.096
	LTE Band 41	20M	QPSK	1	49	Back	0mm	Reduced	40185	2549.5	20.68	22.00	1.355	62.9	1.006	0.1	1.540	2.100
	LTE Band 41	20M	QPSK	1	49	Back	0mm	Reduced	40620	2593	20.75	22.00	1.334	62.9	1.006	0.12	1.560	2.093
	LTE Band 41	20M	QPSK	1	49	Back	0mm	Reduced	41055	2636.5	20.91	22.00	1.285	62.9	1.006	0.12	1.500	1.939
	LTE Band 41	20M	QPSK	1	49	Front	7mm	Full	41490	2680	24.02	25.00	1.253	62.9	1.006	0.11	0.630	0.794
	LTE Band 41	20M	QPSK	1	49	Back	7mm	Full	41490	2680	24.02	25.00	1.253	62.9	1.006	-0.08	0.676	0.852
	LTE Band 41	20M	QPSK	1	49	Bottom Side	8mm	Full	41490	2680	24.02	25.00	1.253	62.9	1.006	0.11	0.477	0.601
	LTE Band 41	20M	QPSK	1	49	Left Side	8mm	Full	41490	2680	24.02	25.00	1.253	62.9	1.006	0.11	0.290	0.366
	LTE Band 41	20M	QPSK	50	24	Front	0mm	Reduced	41490	2680	20.91	22.00	1.285	62.9	1.006	0.12	1.490	1.927
	LTE Band 41	20M	QPSK	50	24	Back	0mm	Reduced	41490	2680	20.91	22.00	1.285	62.9	1.006	0.13	1.520	1.965
	LTE Band 41	20M	QPSK	50	24	Back	0mm	Reduced	39750	2506	20.59	22.00	1.384	62.9	1.006	0.14	1.540	2.143
86	LTE Band 41	20M	QPSK	50	24	Back	0mm	Reduced	40185	2549.5	20.40	22.00	1.445	62.9	1.006	-0.08	1.550	2.254
	LTE Band 41-HPUE	20M	QPSK	50	24	Back	0mm	Reduced	40185	2549.5	20.64	22.00	1.368	42.9	1.009	0.12	1.120	1.546
	LTE Band 41C	20M	QPSK	50	24	Back	0mm	Reduced	39750(pcc)+39948(scc)	2506(pcc)+2525.8(scc)	20.54	22.00	1.400	62.9	1.006	0.12	1.550	2.182
	LTE Band 41C	20M	QPSK	50	24	Back	0mm	Reduced	40185(pcc)+39987(scc)	2549.5(pcc)+2529.7(scc)	20.21	22.00	1.510	62.9	1.006	0.14	1.480	2.248
	LTE Band 41C	20M	QPSK	50	24	Back	0mm	Reduced	40620(pcc)+40422(scc)	2593(pcc)+2573.2(scc)	20.57	22.00	1.390	62.9	1.006	0.13	1.170	1.636
	LTE Band 41C	20M	QPSK	50	24	Back	0mm	Reduced	41055(pcc)+40857(scc)	2636.5(pcc)+2616.7(scc)	20.23	22.00	1.503	62.9	1.006	0.15	1.160	1.754
	LTE Band 41C	20M	QPSK	50	24	Back	0mm	Reduced	41490(pcc)+41292(scc)	2682(pcc)+2660.2(scc)	20.46	22.00	1.426	62.9	1.006	0.16	1.270	1.821
	LTE Band 41	20M	QPSK	50	24	Back	0mm	Reduced	40620	2593	20.60	22.00	1.380	62.9	1.006	0.03	1.530	2.125
	LTE Band 41	20M	QPSK	50	24	Back	0mm	Reduced	41055	2636.5	20.81	22.00	1.315	62.9	1.006	0.02	1.550	2.051
	LTE Band 41	20M	QPSK	50	24	Left Side	0mm	Reduced	41490	2680	20.91	22.00	1.285	62.9	1.006	0.01	1.440	1.862
	LTE Band 41	20M	QPSK	50	24	Bottom Side	0mm	Reduced	41490	2680	20.91	22.00	1.285	62.9	1.006	0.05	0.826	1.068
	LTE Band 41	20M	QPSK	100	0	Front	0mm	Reduced	41490	2680	20.85	22.00	1.303	62.9	1.006	0.12	1.570	2.058
	LTE Band 41	20M	QPSK	100	0	Back	0mm	Reduced	41490	2680	20.85	22.00	1.303	62.9	1.006	0.1	1.650	2.163



<WLAN2.4G SAR>

Plot No.	Band	Mode	Test Position	Gap (mm)	Power Reduction	Ch.	Freq. (MHz)	Average Power (dBm)	Tune-Up Limit (dBm)	Tune-up Scaling Factor	Duty Cycle %	Duty Cycle Scaling Factor	Power Drift (dB)	Measured 10g SAR (W/kg)	Reported 10g SAR (W/kg)
	WLAN2.4GHz	802.11b 1Mbps	Back	0mm	Full	11	2462	21.11	22.50	1.377	100	1.000	-0.1	1.130	1.556
	WLAN2.4GHz	802.11b 1Mbps	Top Side	0mm	Full	11	2462	21.11	22.50	1.377	100	1.000	-0.05	1.170	1.611
	WLAN2.4GHz	802.11b 1Mbps	Top Side	0mm	Full	1	2412	21.07	22.50	1.390	100	1.000	0.02	1.310	1.821
87	WLAN2.4GHz	802.11b 1Mbps	Top Side	0mm	Full	6	2437	20.94	22.50	1.432	100	1.000	0.05	1.400	<b>2.005</b>

<WLAN5G SAR>

Plot No.	Band	Mode	Test Position	Gap (mm)	Power Reduction	Ch.	Freq. (MHz)	Average Power (dBm)	Tune-Up Limit (dBm)	Tune-up Scaling Factor	Duty Cycle %	Duty Cycle Scaling Factor	Power Drift (dB)	Measured 10g SAR (W/kg)	Reported 10g SAR (W/kg)
	WLAN5.2GHz	802.11a 6Mbps	Back	0mm	Full	36	5180	17.22	19.00	1.507	98.28	1.018	0.03	2.210	3.390
88	WLAN5.2GHz	802.11a 6Mbps	Back	0mm	Full	40	5200	17.97	19.50	1.424	98.28	1.018	0.07	2.420	<b>3.508</b>
	WLAN5.2GHz	802.11a 6Mbps	Back	0mm	Full	44	5220	17.90	19.50	1.447	98.28	1.018	0.12	2.310	3.403
	WLAN5.2GHz	802.11a 6Mbps	Back	0mm	Full	48	5240	17.87	19.50	1.457	98.28	1.018	0.11	2.240	3.322
	WLAN5.3GHz	802.11a 6Mbps	Front	0mm	Full	60	5300	17.91	19.50	1.444	98.28	1.018	0.12	0.056	0.082
	WLAN5.3GHz	802.11a 6Mbps	Back	0mm	Full	60	5300	17.91	19.50	1.444	98.28	1.018	0.11	2.120	3.116
	WLAN5.3GHz	802.11a 6Mbps	Left Side	0mm	Full	60	5300	17.91	19.50	1.444	98.28	1.018	0.13	0.013	0.020
	WLAN5.3GHz	802.11a 6Mbps	Right Side	0mm	Full	60	5300	17.91	19.50	1.444	98.28	1.018	0.15	0.489	0.719
	WLAN5.3GHz	802.11a 6Mbps	Top Side	0mm	Full	60	5300	17.91	19.50	1.444	98.28	1.018	-0.12	0.083	0.122
	WLAN5.3GHz	802.11a 6Mbps	Back	0mm	Full	52	5260	17.80	19.50	1.481	98.28	1.018	0.09	2.060	3.105
89	WLAN5.3GHz	802.11a 6Mbps	Back	0mm	Full	56	5280	17.84	19.50	1.467	98.28	1.018	0.01	2.320	<b>3.465</b>
	WLAN5.3GHz	802.11a 6Mbps	Back	0mm	Full	64	5320	17.86	19.50	1.460	98.28	1.018	0.06	2.040	3.033
	WLAN5.5GHz	802.11a 6Mbps	Front	0mm	Full	132	5660	18.17	19.50	1.360	98.28	1.018	0.03	0.058	0.080
	WLAN5.5GHz	802.11a 6Mbps	Back	0mm	Full	132	5660	18.17	19.50	1.360	98.28	1.018	-0.05	2.190	3.031
	WLAN5.5GHz	802.11a 6Mbps	Left Side	0mm	Full	132	5660	18.17	19.50	1.360	98.28	1.018	0.01	0.027	0.037
	WLAN5.5GHz	802.11a 6Mbps	Right Side	0mm	Full	132	5660	18.17	19.50	1.360	98.28	1.018	0.02	0.575	0.796
	WLAN5.5GHz	802.11a 6Mbps	Top Side	0mm	Full	132	5660	18.17	19.50	1.360	98.28	1.018	0.05	0.068	0.094
90	WLAN5.5GHz	802.11a 6Mbps	Back	0mm	Full	100	5500	17.91	19.50	1.444	98.28	1.018	0.08	2.120	<b>3.116</b>
	WLAN5.5GHz	802.11a 6Mbps	Back	0mm	Full	116	5580	17.94	19.50	1.434	98.28	1.018	0.04	2.120	3.094
	WLAN5.5GHz	802.11a 6Mbps	Back	0mm	Full	140	5700	18.10	19.50	1.382	98.28	1.018	0.08	1.970	2.771
91	WLAN5.8GHz	802.11a 6Mbps	Back	0mm	Full	149	5745	15.87	17.50	1.457	98.28	1.018	0.05	1.740	<b>2.581</b>
	WLAN5.8GHz	802.11a 6Mbps	Back	0mm	Full	157	5785	15.44	16.50	1.278	98.28	1.018	0.01	1.620	2.107
	WLAN5.8GHz	802.11a 6Mbps	Back	0mm	Full	165	5825	15.24	16.50	1.338	98.28	1.018	-0.04	1.490	2.030



15.5 Repeated SAR Measurement

<1g>

No.	Band	BW (MHz)	Modulation	RB Size	RB offset	Mode	Test Position	Gap (mm)	Power Reduction	Ch.	Freq. (MHz)	Average Power (dBm)	Tune-Up Limit (dBm)	Tune-up Scaling Factor	Duty Cycle %	Duty Cycle Scaling Factor	Power Drift (dB)	Measured 1g SAR (W/kg)	Ratio	Reported 1g SAR (W/kg)
1st	GSM1900	-	-	-	-	GPRS 2 Tx slots	Bottom Side	5mm	Reduced	661	1880	20.15	21.00	1.216	-	-	-0.04	1.170	1	1.423
2nd	GSM1900	-	-	-	-	GPRS 2 Tx slots	Bottom Side	5mm	Reduced	661	1880	20.15	21.00	1.216	-	-	-0.04	1.160	1.009	1.411
1st	LTE Band 13	10M	QPSK	1	0	-	Back	5mm	Full	23230	782	22.63	24.00	1.371	-	-	0.09	0.904	1	1.239
2nd	LTE Band 13	10M	QPSK	1	0	-	Back	5mm	Full	23230	782	22.63	24.00	1.371	-	-	0.02	0.843	1.072	1.156
1st	LTE Band 5	10M	QPSK	1	49	-	Back	5mm	Full	20525	836.5	23.11	24.00	1.227	-	-	-0.12	1.170	1	1.436
2nd	LTE Band 5	10M	QPSK	1	49	-	Back	5mm	Full	20525	836.5	23.11	24.00	1.227	-	-	-0.07	1.040	1.125	1.277
1st	LTE Band 66	20M	QPSK	1	99	-	Bottom Side	5mm	Reduced	132322	1745	14.06	14.50	1.107	-	-	-0.02	1.300	1	1.439
2nd	LTE Band 66	20M	QPSK	1	99	-	Bottom Side	5mm	Reduced	132322	1745	14.06	14.50	1.107	-	-	0.14	1.280	1.016	1.416
1st	LTE Band 7	20M	QPSK	1	99	-	Bottom Side	5mm	Reduced	20850	2510	18.93	19.50	1.140	-	-	-0.03	1.150	1	1.311
2nd	LTE Band 7	20M	QPSK	1	99	-	Bottom Side	5mm	Reduced	20850	2510	18.93	19.50	1.140	-	-	0.02	0.961	1.197	1.096
1st	LTE Band 30	10M	QPSK	25	25	-	Back	5mm	Reduced	27710	2310	20.10	21.00	1.230	-	-	-0.12	1.040	1	1.279
2nd	LTE Band 30	10M	QPSK	25	25	-	Back	5mm	Reduced	27710	2310	20.10	21.00	1.230	-	-	0.12	0.975	1.067	1.200
1st	WLAN2.4GHz	-	-	-	-	802.11b 1Mbps	Back	5mm	Reduced	11	2462	20.12	21.50	1.374	100	1.000	0.02	0.839	1	1.153
2nd	WLAN2.4GHz	-	-	-	-	802.11b 1Mbps	Back	5mm	Reduced	11	2462	20.12	21.50	1.374	100	1.000	0.01	0.837	1.002	1.150
1st	WLAN5.8GHz	-	-	-	-	802.11a 6Mbps	Back	5mm	Reduced	165	5825	8.89	10.00	1.293	98.28	1.018	0.01	0.894	1	1.176
2nd	WLAN5.8GHz	-	-	-	-	802.11a 6Mbps	Back	5mm	Reduced	165	5825	8.89	10.00	1.293	98.28	1.018	0.05	0.804	1.112	1.058

<10g>

No.	Band	BW (MHz)	Modulation	RB Size	RB offset	Mode	Test Position	Gap (mm)	Power Reduction	Ch.	Freq. (MHz)	Average Power (dBm)	Tune-Up Limit (dBm)	Tune-up Scaling Factor	Duty Cycle %	Duty Cycle Scaling Factor	Power Drift (dB)	Measured 10g SAR (W/kg)	Ratio	Reported 10g SAR (W/kg)
1st	WCDMA V					RMC 12.2Kbps	Front	0mm	Full	4233	846.6	23.29	24.00	1.178	-	-	-0.07	2.120	1	2.497
2nd	WCDMA V					RMC 12.2Kbps	Front	0mm	Full	4233	846.6	23.29	24.00	1.178	-	-	-0.18	2.080	1.019	2.449
1st	LTE Band 25	20M	QPSK	1	0		Front	0mm	Reduced	26140	1860	19.69	20.50	1.205	-	-	0.01	2.340	1	2.820
2nd	LTE Band 25	20M	QPSK	1	0		Front	0mm	Reduced	26140	1860	19.69	20.50	1.205	-	-	-0.11	2.290	1.022	2.760
1st	LTE Band 66	20M	QPSK	1	0		Front	0mm	Reduced	132322	1745	19.22	20.00	1.197	-	-	-0.01	2.730	1	3.267
2nd	LTE Band 66	20M	QPSK	1	0		Front	0mm	Reduced	132322	1745	19.22	20.00	1.197	-	-	0.09	2.680	1.019	3.207
1st	WLAN5.2GHz					802.11a 6Mbps	Back	0mm	Full	40	5200	17.97	19.50	1.424	98.28	1.018	0.07	2.420	1	3.508
2nd	WLAN5.2GHz					802.11a 6Mbps	Back	0mm	Full	40	5200	17.97	19.50	1.424	98.28	1.018	0.02	2.340	1.034	3.392

General Note:

1. Per KDB 865664 D01v01r04, for each frequency band, repeated SAR measurement is required only when the measured SAR is  $\geq 0.8W/kg$ .
2. Per KDB 865664 D01v01r04, if the ratio among the repeated measurement is  $\leq 1.2$  and the measured SAR  $< 1.45W/kg$ , only one repeated measurement is required.
3. Per KDB 865664 D01v01r04, if the extremity repeated SAR is necessary, the same procedures should be adapted for measurements according to extremity and occupational exposure limits by applying a factor of 2.5 for extremity exposure and a factor of 5 for occupational exposure to the corresponding SAR thresholds.
4. The ratio is the difference in percentage between original and repeated *measured SAR*.
5. All measurement SAR result is scaled-up to account for tune-up tolerance and is compliant.



15.6 TDD LTE Band 41(HPUE) Linearity Data Analysis

Table with 3 columns: Parameter, LTE Band 41 (Power Class 3), and LTE Band 41 (Power Class 2). Rows include Maximum Tune up Power, Reported 1g SAR, Duty Cycle, Frame Averaged, Linearity SAR, and % deviation from expected linearity for Head, Hotspot/Body-worn, and Extremity.

General Note:

- 1. The device can adjust uplink/downlink configuration automatically according to the transmitting power class level for LTE band 41.
2. According to TCB Workshop May 2017, Rel. 14 has introduced HPUE Power Class 2 for Band 41. HPUE Power Class 2 does not support uplink downlink configurations 0 and 6.
3. Power class 3 is expected to be the dominant use configuration; therefore, SAR should be tested as normally required.
4. Power class 2 is tested using the highest SAR test configuration in power class 3 of each LTE configuration and exposure condition combination, according to the highest time averaged power for all applicable uplink-downlink configurations in power class 2.
5. Separate SAR testing for Power Class 2 is not required when - the reported SAR vs. output power can be linearly scaled with < 10% - discrepancy between power classes and all reported 1g SAR are < 1.4 W/kg (The same procedures should be adapted for measurements according to extremity limits by applying a factor of 2.5 for extremity exposure.)

**16. Simultaneous Transmission Analysis**

No.	Simultaneous Transmission Configurations	Portable Handset			
		Head	Body-worn	Hotspot	Product specific 10g SAR
1.	GSM Voice + WLAN2.4GHz	Yes	Yes		Yes
2.	GPRS/EDGE + WLAN2.4GHz	Yes	Yes	Yes	Yes
3.	WCDMA + WLAN2.4GHz	Yes	Yes	Yes	Yes
4.	CDMA + WLAN2.4GHz	Yes	Yes	Yes	Yes
5.	LTE + WLAN2.4GHz	Yes	Yes	Yes	Yes
6.	GSM Voice + WLAN5.3/5.5GHz	Yes	Yes		Yes
7.	GPRS/EDGE + WLAN5.3/5.5GHz	Yes	Yes		Yes
8.	WCDMA + WLAN5.3/5.5GHz	Yes	Yes		Yes
9.	CDMA + WLAN5.3/5.5GHz	Yes	Yes		Yes
10.	LTE + WLAN5.3/5.5GHz	Yes	Yes		Yes
11.	GSM Voice + WLAN5.2/5.8GHz	Yes	Yes		Yes
12.	GPRS/EDGE + WLAN5.2/5.8GHz	Yes	Yes	Yes	Yes
13.	WCDMA + WLAN5.2/5.8GHz	Yes	Yes	Yes	Yes
14.	CDMA + WLAN5.2/5.8GHz	Yes	Yes	Yes	Yes
15.	LTE + WLAN5.2/5.8GHz	Yes	Yes	Yes	Yes
16.	GSM Voice + WLAN5.3/5.5GHz+Bluetooth	Yes	Yes		Yes
17.	GPRS/EDGE + WLAN5.3/5.5GHz+Bluetooth	Yes	Yes		Yes
18.	WCDMA + WLAN5.3/5.5GHz+Bluetooth	Yes	Yes		Yes
19.	CDMA + WLAN5.3/5.5GHz+Bluetooth	Yes	Yes		Yes
20.	LTE + WLAN5.3/5.5GHz+Bluetooth	Yes	Yes		Yes
21.	GSM Voice + WLAN5.2/5.8GHz+Bluetooth	Yes	Yes		Yes
22.	GPRS/EDGE + WLAN5.2/5.8GHz+Bluetooth	Yes	Yes	Yes	Yes
23.	WCDMA + WLAN5.2/5.8GHz+Bluetooth	Yes	Yes	Yes	Yes
24.	CDMA + WLAN5.2/5.8GHz+Bluetooth	Yes	Yes	Yes	Yes
25.	LTE + WLAN5.2/5.8GHz+Bluetooth	Yes	Yes	Yes	Yes
26.	WLAN5.2/5.8GHz+ Bluetooth	Yes	Yes	Yes	Yes
27.	WLAN5.3/5.5GHz + Bluetooth	Yes	Yes	Yes	Yes
28.	GSM Voice + Bluetooth	Yes	Yes		Yes
29.	GPRS/EDGE + Bluetooth	Yes	Yes	Yes	Yes
30.	WCDMA + Bluetooth	Yes	Yes	Yes	Yes
31.	CDMA + Bluetooth	Yes	Yes	Yes	Yes
32.	LTE + Bluetooth	Yes	Yes	Yes	Yes

**General Note:**

- This device supports VoIP in GPRS, EGPRS, WCDMA, CDMA and LTE (e.g. for 3rd-party VoIP), LTE supports VoLTE operation.
- EUT will choose each GSM, CDMA, WCDMA and LTE according to the network signal condition; therefore, they will not operate simultaneously at any moment.
- This device 2.4GHz WLAN support hotspot operation and Bluetooth support tethering applications.
- This device 2.4GHz WLAN/ 5.2GHz WLAN/5.8GHz WLAN support hotspot operation, and 5.2GHz WLAN/5.8GHz WLAN supports WLAN Direct (GC/GO), and 5.3GHz / 5.5GHz supports WLAN Direct (GC only).
- EUT will choose either WLAN 2.4GHz or WLAN 5GHz according to the network signal condition; therefore, 2.4GHz WLAN and 5GHz WLAN will not operate simultaneously at any moment though they have independent antenna.
- WLAN 2.4GHz and Bluetooth share the same antenna so can't transmit simultaneously.
- According to the EUT character, WLAN 5GHz and Bluetooth can transmit simultaneously. WWAN+WLAN5GHz+Bluetooth can represent WWAN+WLAN5GHz or WWAN+ Bluetooth, So no need to do co-located analysis separately.
- Choose the worst zoom scan SAR of WLAN correspondingly for co-located with WWAN analysis.
- The reported SAR summation is calculated based on the same configuration and test position.
- Per KDB 447498 D01v06, simultaneous transmission SAR is compliant if,
  - 1g Scalar SAR summation < 1.6W/kg and 10g Scalar SAR summation < 4.0W/kg.
  - $SPLSR = (SAR1 + SAR2)^{1.5} / (\text{min. separation distance, mm})$ , and the peak separation distance is determined from the square root of  $[(x1-x2)^2 + (y1-y2)^2 + (z1-z2)^2]$ , where (x1, y1, z1) and (x2, y2, z2) are the coordinates of the extrapolated peak SAR locations in the zoom scan.
  - If  $SPLSR \leq 0.04$  for 1g SAR and  $SPLSR \leq 0.10$  for 10g SAR, simultaneously transmission SAR measurement is not necessary.
  - Simultaneously transmission SAR measurement, and the reported multi-band 1g SAR < 1.6W/kg and 10g SAR < 4.0W/kg.
  - The SPLSR calculated results please refer to section 16.6.
  - If  $SPLSR > 0.04$  for 1g SAR and  $SPLSR > 0.10$  for 10g SAR, volume scan measurement is required, volume

scan measured SAR please refer to 16.7.

### **16.1 SPLSR and Volume SAR description**

1. Per KDB 447498 D01v06, simultaneous transmission SAR is compliant if,
  - vii) 1g Scalar SAR summation < 1.6W/kg and 10g Scalar SAR summation < 4.0W/kg.
  - viii)  $SPLSR = (SAR1 + SAR2)^{1.5} / (\min. \text{ separation distance, mm})$ , and the peak separation distance is determined from the square root of  $[(x1-x2)^2 + (y1-y2)^2 + (z1-z2)^2]$ , where (x1, y1, z1) and (x2, y2, z2) are the coordinates of the extrapolated peak SAR locations in the zoom scan.
  - ix) If  $SPLSR \leq 0.04$  for 1g SAR and  $SPLSR \leq 0.10$  for 10g SAR , simultaneously transmission SAR measurement is not necessary.
  - x) Simultaneously transmission SAR measurement, and the reported multi-band 1g SAR < 1.6W/kg and 10g SAR < 4.0W/kg.
  - xi) The SPLSR calculated results please refer to section 16.6.
  - xii) If  $SPLSR > 0.04$  for 1g SAR and  $SPLSR > 0.10$  for 10g SAR, volume scan measurement is required, volume scan measured SAR please refer to 16.7.
2. Section 16.6 SPLSR results are complied with  $SPLSR \leq 0.04$  for 1g SAR and  $SPLSR \leq 0.10$  for 10g SAR.
3. Section 16.7 Volume SAR test results are complied with 10g SAR < 4.0W/kg.
4. Volume scan procedure followed with KDB865664D01,the detail volume SAR plots can refer to Appendix B.
5. The following table shading with yellow color means the co-locate SAR need to perform SPLSR analysis and can refer the case number for detail traced to section 16.6.
6. The following table shading with light green color means the co-locate SAR need to perform Volume scan and can refer the case number for detail traced to section 16.7.



16.2 Head Exposure Conditions

WWAN Band	Exposure Position	1	2	4	6	1+2	SPLSR	Case No	1+6	1+4+6
		WWAN	2.4GHz WLAN Ant 1	5GHz WLAN Ant 1	Bluetooth Ant 1	Summed			Summed	Summed
		1g SAR (W/kg)	1g SAR (W/kg)	1g SAR (W/kg)	1g SAR (W/kg)	1g SAR (W/kg)			1g SAR (W/kg)	1g SAR (W/kg)
GSM	GSM850	Right Cheek	0.478	0.546	0.065	0.043	1.02		0.52	0.59
		Right Tilted	0.241	0.586	0.100	0.051	0.83		0.29	0.39
		Left Cheek	0.419	1.092	0.090	0.113	1.51		0.53	0.62
		Left Tilted	0.222	1.084	0.112	0.079	1.31		0.30	0.41
	GSM1900	Right Cheek	0.031	0.546	0.065	0.043	0.58		0.07	0.14
		Right Tilted	0.023	0.586	0.100	0.051	0.61		0.07	0.17
		Left Cheek	0.056	1.092	0.090	0.113	1.15		0.17	0.26
		Left Tilted	0.027	1.084	0.112	0.079	1.11		0.11	0.22
WCDMA	WCDMA II	Right Cheek	0.074	0.546	0.065	0.043	0.62		0.12	0.18
		Right Tilted	0.039	0.586	0.100	0.051	0.63		0.09	0.19
		Left Cheek	0.172	1.092	0.090	0.113	1.26		0.29	0.38
		Left Tilted	0.056	1.084	0.112	0.079	1.14		0.14	0.25
	WCDMA IV	Right Cheek	0.140	0.546	0.065	0.043	0.69		0.18	0.25
		Right Tilted	0.087	0.586	0.100	0.051	0.67		0.14	0.24
		Left Cheek	0.157	1.092	0.090	0.113	1.25		0.27	0.36
		Left Tilted	0.102	1.084	0.112	0.079	1.19		0.18	0.29
	WCDMA V	Right Cheek	0.439	0.546	0.065	0.043	0.99		0.48	0.55
		Right Tilted	0.208	0.586	0.100	0.051	0.79		0.26	0.36
		Left Cheek	0.376	1.092	0.090	0.113	1.47		0.49	0.58
		Left Tilted	0.195	1.084	0.112	0.079	1.28		0.27	0.39
CDMA	CDMA2000 BC0	Right Cheek	0.333	0.546	0.065	0.043	0.88		0.38	0.44
		Right Tilted	0.121	0.586	0.100	0.051	0.71		0.17	0.27
		Left Cheek	0.287	1.092	0.090	0.113	1.38		0.40	0.49
		Left Tilted	0.134	1.084	0.112	0.079	1.22		0.21	0.33
	CDMA2000 BC1	Right Cheek	0.048	0.546	0.065	0.043	0.59		0.09	0.16
		Right Tilted	0.031	0.586	0.100	0.051	0.62		0.08	0.18
		Left Cheek	0.110	1.092	0.090	0.113	1.20		0.22	0.31
		Left Tilted	0.039	1.084	0.112	0.079	1.12		0.12	0.23
	CDMA2000 BC10	Right Cheek	0.463	0.546	0.065	0.043	1.01		0.51	0.57
		Right Tilted	0.237	0.586	0.100	0.051	0.82		0.29	0.39
		Left Cheek	0.431	1.092	0.090	0.113	1.52		0.54	0.63
		Left Tilted	0.254	1.084	0.112	0.079	1.34		0.33	0.45
LTE	LTE Band 5	Right Cheek	0.387	0.546	0.065	0.043	0.93		0.43	0.50
		Right Tilted	0.187	0.586	0.100	0.051	0.77		0.24	0.34
		Left Cheek	0.355	1.092	0.090	0.113	1.45		0.47	0.56
		Left Tilted	0.160	1.084	0.112	0.079	1.24		0.24	0.35
	LTE Band 71	Right Cheek	0.403	0.546	0.065	0.043	0.95		0.45	0.51
		Right Tilted	0.221	0.586	0.100	0.051	0.81		0.27	0.37
		Left Cheek	0.374	1.092	0.090	0.113	1.47		0.49	0.58
		Left Tilted	0.186	1.084	0.112	0.079	1.27		0.27	0.38
	LTE Band 12	Right Cheek	0.376	0.546	0.065	0.043	0.92		0.42	0.48
		Right Tilted	0.167	0.586	0.100	0.051	0.75		0.22	0.32
		Left Cheek	0.363	1.092	0.090	0.113	1.46		0.48	0.57
		Left Tilted	0.164	1.084	0.112	0.079	1.25		0.24	0.36
	LTE Band 13	Right Cheek	0.446	0.546	0.065	0.043	0.99		0.49	0.55
		Right Tilted	0.170	0.586	0.100	0.051	0.76		0.22	0.32
		Left Cheek	0.400	1.092	0.090	0.113	1.49		0.51	0.60
		Left Tilted	0.175	1.084	0.112	0.079	1.26		0.25	0.37





WWAN Band	Exposure Position	1	2	4	6	1+2 Summed 1g SAR (W/kg)	SPLSR	Case No	1+6 Summed 1g SAR (W/kg)	1+4+6 Summed 1g SAR (W/kg)	
		WWAN	2.4GHz WLAN Ant 1	5GHz WLAN Ant 1	Bluetooth Ant 1						
		1g SAR (W/kg)	1g SAR (W/kg)	1g SAR (W/kg)	1g SAR (W/kg)						
LTE	LTE Band 14	Right Cheek	0.271	0.546	0.065	0.043	0.82			0.31	0.38
		Right Tilted	0.127	0.586	0.100	0.051	0.71			0.18	0.28
		Left Cheek	0.258	1.092	0.090	0.113	1.35			0.37	0.46
		Left Tilted	0.125	1.084	0.112	0.079	1.21			0.20	0.32
	LTE Band 26	Right Cheek	0.504	0.546	0.065	0.043	1.05			0.55	0.61
		Right Tilted	0.098	0.586	0.100	0.051	0.68			0.15	0.25
		Left Cheek	0.213	1.092	0.090	0.113	1.31			0.33	0.42
		Left Tilted	0.088	1.084	0.112	0.079	1.17			0.17	0.28
	LTE Band 25	Right Cheek	0.063	0.546	0.065	0.043	0.61			0.11	0.17
		Right Tilted	0.046	0.586	0.100	0.051	0.63			0.10	0.20
		Left Cheek	0.123	1.092	0.090	0.113	1.22			0.24	0.33
		Left Tilted	0.046	1.084	0.112	0.079	1.13			0.13	0.24
	LTE Band 66	Right Cheek	0.103	0.546	0.065	0.043	0.65			0.15	0.21
		Right Tilted	0.048	0.586	0.100	0.051	0.63			0.10	0.20
		Left Cheek	0.130	1.092	0.090	0.113	1.22			0.24	0.33
		Left Tilted	0.064	1.084	0.112	0.079	1.15			0.14	0.26
	LTE Band 7	Right Cheek	0.340	0.546	0.065	0.043	0.89			0.38	0.45
		Right Tilted	0.274	0.586	0.100	0.051	0.86			0.33	0.43
		Left Cheek	0.688	1.092	0.090	0.113	1.78	0.03	#01	0.80	0.89
		Left Tilted	0.170	1.084	0.112	0.079	1.25			0.25	0.36
	LTE Band 30	Right Cheek	0.308	0.546	0.065	0.043	0.85			0.35	0.42
		Right Tilted	0.280	0.586	0.100	0.051	0.87			0.33	0.43
		Left Cheek	0.514	1.092	0.090	0.113	1.61	0.02	#02	0.63	0.72
		Left Tilted	0.205	1.084	0.112	0.079	1.29			0.28	0.40
LTE Band 41	Right Cheek	0.349	0.546	0.065	0.043	0.90			0.39	0.46	
	Right Tilted	0.337	0.586	0.100	0.051	0.92			0.39	0.49	
	Left Cheek	0.601	1.092	0.090	0.113	1.69	0.03	#03	0.71	0.80	
	Left Tilted	0.198	1.084	0.112	0.079	1.28			0.28	0.39	



16.3 Hotspot Exposure Conditions

WWAN Band	Exposure Position	1	2	4	6	1+2 Summed 1g SAR (W/kg)	SPLSR	Case No	1+6 Summed 1g SAR (W/kg)	1+4+6 Summed 1g SAR (W/kg)	SPLSR	Case No	
		WWAN	2.4GHz WLAN Ant 1	5GHz WLAN Ant 1	Bluetooth Ant 1								
		1g SAR (W/kg)	1g SAR (W/kg)	1g SAR (W/kg)	1g SAR (W/kg)								
GSM	GSM850	Front	1.269	0.743	0.008	0.041	2.01	0.02	#04	1.31	1.32		
		Back	1.378	1.153	1.192	0.079	2.53	0.03	#20	1.46	2.65	0.04	#45
		Left side	0.374	0.234	0.001	0.015	0.61			0.39	0.39		
		Right side	0.667	0.542	0.134	0.035	1.21			0.70	0.84		
		Top side		1.066	0.041	0.089	1.07			0.09	0.13		
		Bottom side	1.047				1.05			1.05	1.05		
	GSM1900	Front	1.357	0.743	0.008	0.041	2.10	0.02	#05	1.40	1.41		
		Back	1.264	1.153	1.192	0.079	2.42	0.03	#21	1.34	2.54	0.04	#46
		Left side	0.024	0.234	0.001	0.015	0.26			0.04	0.04		
		Right side	0.017	0.542	0.134	0.035	0.56			0.05	0.19		
		Top side		1.066	0.041	0.089	1.07			0.09	0.13		
		Bottom side	1.434				1.43			1.43	1.43		
WCDMA	WCDMA II	Front	1.423	0.743	0.008	0.041	2.17	0.02	#06	1.46	1.47		
		Back	1.372	1.153	1.192	0.079	2.53	0.03	#22	1.45	2.64	0.04	#47
		Left side	0.018	0.234	0.001	0.015	0.25			0.03	0.03		
		Right side	0.013	0.542	0.134	0.035	0.56			0.05	0.18		
		Top side		1.066	0.041	0.089	1.07			0.09	0.13		
		Bottom side	1.286				1.29			1.29	1.29		
	WCDMA IV	Front	1.384	0.743	0.008	0.041	2.13	0.02	#07	1.43	1.43		
		Back	1.223	1.153	1.192	0.079	2.38	0.02	#23	1.30	2.49	0.04	#48
		Left side	0.029	0.234	0.001	0.015	0.26			0.04	0.05		
		Right side	0.023	0.542	0.134	0.035	0.57			0.06	0.19		
		Top side		1.066	0.041	0.089	1.07			0.09	0.13		
		Bottom side	1.019				1.02			1.02	1.02		
	WCDMA V	Front	1.301	0.743	0.008	0.041	2.04	0.02	#08	1.34	1.35		
		Back	1.350	1.153	1.192	0.079	2.50	0.03	#24	1.43	2.62	0.04	#49
		Left side	0.353	0.234	0.001	0.015	0.59			0.37	0.37		
		Right side	0.591	0.542	0.134	0.035	1.13			0.63	0.76		
		Top side		1.066	0.041	0.089	1.07			0.09	0.13		
		Bottom side	1.216				1.22			1.22	1.22		
CDMA	CDMA2000 BC0	Front	1.212	0.743	0.008	0.041	1.96	0.02	#09	1.25	1.26		
		Back	1.307	1.153	1.192	0.079	2.46	0.03	#25	1.39	2.58	0.04	#50
		Left side	0.277	0.234	0.001	0.015	0.51			0.29	0.29		
		Right side	0.518	0.542	0.134	0.035	1.06			0.55	0.69		
		Top side		1.066	0.041	0.089	1.07			0.09	0.13		
		Bottom side	1.015				1.02			1.02	1.02		
	CDMA2000 BC1	Front	0.707	0.743	0.008	0.041	1.45			0.75	0.76		
		Back	0.585	1.153	1.192	0.079	1.74	0.02	#26	0.66	1.86	0.04	#51
		Left side	0.021	0.234	0.001	0.015	0.26			0.04	0.04		
		Right side	0.020	0.542	0.134	0.035	0.56			0.06	0.19		
		Top side		1.066	0.041	0.089	1.07			0.09	0.13		
		Bottom side	1.113				1.11			1.11	1.11		
	CDMA2000 BC10	Front	0.989	0.743	0.008	0.041	1.73	0.01	#10	1.03	1.04		
		Back	1.069	1.153	1.192	0.079	2.22	0.02	#27	1.15	2.34	0.04	#52
		Left side	0.384	0.234	0.001	0.015	0.62			0.40	0.40		
		Right side	0.602	0.542	0.134	0.035	1.14			0.64	0.77		
		Top side		1.066	0.041	0.089	1.07			0.09	0.13		
		Bottom side	0.876				0.88			0.88	0.88		



WWAN Band	Exposure Position	1	2	4	6	1+2 Summed 1g SAR (W/kg)	SPLSR	Case No	1+6 Summed 1g SAR (W/kg)	1+4+6 Summed 1g SAR (W/kg)	SPLSR	Case No	
		WWAN	2.4GHz WLAN Ant 1	5GHz WLAN Ant 1	Bluetooth Ant 1								
		1g SAR (W/kg)	1g SAR (W/kg)	1g SAR (W/kg)	1g SAR (W/kg)								
LTE	LTE Band 5	Front	1.289	0.743	0.008	0.041	2.03	0.02	#11	1.33	1.34		
		Back	1.436	1.153	1.192	0.079	2.59	0.03	#28	1.52	2.71	0.04	#53
		Left side	0.437	0.234	0.001	0.015	0.67			0.45	0.45		
		Right side	0.547	0.542	0.134	0.035	1.09			0.58	0.72		
		Top side		1.066	0.041	0.089	1.07			0.09	0.13		
		Bottom side	1.424				1.42			1.42	1.42		
	LTE Band 71	Front	0.819	0.743	0.008	0.041	1.56			0.86	0.87		
		Back	1.000	1.153	1.192	0.079	2.15	0.02	#29	1.08	2.27	0.04	#54
		Left side	0.556	0.234	0.001	0.015	0.79			0.57	0.57		
		Right side	0.710	0.542	0.134	0.035	1.25			0.75	0.88		
		Top side		1.066	0.041	0.089	1.07			0.09	0.13		
		Bottom side	0.654				0.65			0.65	0.65		
	LTE Band 12	Front	0.817	0.743	0.008	0.041	1.56			0.86	0.87		
		Back	0.911	1.153	1.192	0.079	2.06	0.02	#30	0.99	2.18	0.04	#55
		Left side	0.602	0.234	0.001	0.015	0.84			0.62	0.62		
		Right side	0.714	0.542	0.134	0.035	1.26			0.75	0.88		
		Top side		1.066	0.041	0.089	1.07			0.09	0.13		
		Bottom side	0.665				0.67			0.67	0.67		
	LTE Band 13	Front	1.163	0.743	0.008	0.041	1.91	0.02	#12	1.20	1.21		
		Back	1.239	1.153	1.192	0.079	2.39	0.02	#31	1.32	2.51	0.04	#56
		Left side	0.454	0.234	0.001	0.015	0.69			0.47	0.47		
		Right side	0.679	0.542	0.134	0.035	1.22			0.71	0.85		
		Top side		1.066	0.041	0.089	1.07			0.09	0.13		
		Bottom side	0.979				0.98			0.98	0.98		
	LTE Band 14	Front	0.925	0.743	0.008	0.041	1.67	0.01	#13	0.97	0.97		
		Back	0.964	1.153	1.192	0.079	2.12	0.02	#32	1.04	2.24	0.04	#57
		Left side	0.269	0.234	0.001	0.015	0.50			0.28	0.29		
		Right side	0.473	0.542	0.134	0.035	1.02			0.51	0.64		
		Top side		1.066	0.041	0.089	1.07			0.09	0.13		
		Bottom side	0.819				0.82			0.82	0.82		
	LTE Band 26	Front	1.295	0.743	0.008	0.041	2.04	0.02	#14	1.34	1.34		
		Back	1.126	1.153	1.192	0.079	2.28	0.02	#33	1.21	2.40	0.04	#58
		Left side	0.218	0.234	0.001	0.015	0.45			0.23	0.23		
		Right side	0.259	0.542	0.134	0.035	0.80			0.29	0.43		
		Top side		1.066	0.041	0.089	1.07			0.09	0.13		
		Bottom side	1.147				1.15			1.15	1.15		
	LTE Band 25	Front	1.340	0.743	0.008	0.041	2.08	0.02	#15	1.38	1.39		
		Back	1.259	1.153	1.192	0.079	2.41	0.02	#34	1.34	2.53	0.04	#59
		Left side	0.019	0.234	0.001	0.015	0.25			0.03	0.04		
		Right side	0.019	0.542	0.134	0.035	0.56			0.05	0.19		
		Top side		1.066	0.041	0.089	1.07			0.09	0.13		
		Bottom side	1.232				1.23			1.23	1.23		
LTE Band 66	Front	1.359	0.743	0.008	0.041	2.10	0.02	#16	1.40	1.41			
	Back	1.336	1.153	1.192	0.079	2.49	0.03	#35	1.42	2.61	0.04	#60	
	Left side	0.031	0.234	0.001	0.015	0.27			0.05	0.05			
	Right side	0.027	0.542	0.134	0.035	0.57			0.06	0.20			
	Top side		1.066	0.041	0.089	1.07			0.09	0.13			
	Bottom side	1.439				1.44			1.44	1.44			



WWAN Band	Exposure Position	1	2	4	6	1+2 Summed 1g SAR (W/kg)	SPLSR	Case No	1+6 Summed 1g SAR (W/kg)	1+4+6 Summed 1g SAR (W/kg)	SPLSR	Case No	
		WWAN	2.4GHz WLAN Ant 1	5GHz WLAN Ant 1	Bluetooth Ant 1								
		1g SAR (W/kg)	1g SAR (W/kg)	1g SAR (W/kg)	1g SAR (W/kg)								
LTE	LTE Band 7	Front	1.164	0.743	0.008	0.041	1.91	0.02	#17	1.21	1.21		
		Back	1.265	1.153	1.192	0.079	2.42	0.03	#36	1.34	2.54	0.04	#61
		Left side	0.985	0.234	0.001	0.015	1.22			1.00	1.00		
		Right side	0.164	0.542	0.134	0.035	0.71			0.20	0.33		
		Top side		1.066	0.041	0.089	1.07			0.09	0.13		
		Bottom side	1.311				1.31			1.31	1.31		
	LTE Band 30	Front	1.134	0.743	0.008	0.041	1.88	0.02	#18	1.18	1.18		
		Back	1.279	1.153	1.192	0.079	2.43	0.03	#37	1.36	2.55	0.04	#62
		Left side	0.938	0.234	0.001	0.015	1.17			0.95	0.95		
		Right side	0.112	0.542	0.134	0.035	0.65			0.15	0.28		
		Top side		1.066	0.041	0.089	1.07			0.09	0.13		
		Bottom side	0.988				0.99			0.99	0.99		
	LTE Band 41	Front	1.266	0.743	0.008	0.041	2.01	0.02	#19	1.31	1.32		
		Back	1.439	1.153	1.192	0.079	2.59	0.03	#38	1.52	2.71	0.04	#63
		Left side	1.044	0.234	0.001	0.015	1.28			1.06	1.06		
		Right side	0.132	0.542	0.134	0.035	0.67			0.17	0.30		
		Top side		1.066	0.041	0.089	1.07			0.09	0.13		
		Bottom side	1.110				1.11			1.11	1.11		



16.4 Body-Worn Accessory Exposure Conditions

WWAN Band	Exposure Position	1	2	4	6	1+2 Summed 1g SAR (W/kg)	SPLSR	Case No	1+6 Summed 1g SAR (W/kg)	1+4+6 Summed 1g SAR (W/kg)	SPLSR	Case No	
		WWAN	2.4GHz WLAN Ant 1	5GHz WLAN Ant 1	Bluetooth Ant 1								
		1g SAR (W/kg)	1g SAR (W/kg)	1g SAR (W/kg)	1g SAR (W/kg)								
GSM	GSM850	Front	1.269	0.743	0.032	0.041	2.01	0.02	#04	1.31	1.34		
		Back	1.378	1.153	1.192	0.079	2.53	0.03	#20	1.46	2.65	0.04	#64
		Front with Headset	1.230				1.23			1.23	1.23		
		Back with Headset	1.278				1.28			1.28	1.28		
	GSM1900	Front	1.357	0.743	0.032	0.041	2.10	0.02	#05	1.40	1.43		
		Back	1.264	1.153	1.192	0.079	2.42	0.03	#21	1.34	2.54	0.04	#65
		Front with Headset	1.354				1.35			1.35	1.35		
		Back with Headset	1.229				1.23			1.23	1.23		
WCDMA	WCDMA II	Front	1.423	0.743	0.032	0.041	2.17	0.02	#06	1.46	1.50		
		Back	1.372	1.153	1.192	0.079	2.53	0.03	#22	1.45	2.64	0.04	#66
		Front with Headset	1.245				1.25			1.25	1.25		
		Back with Headset	1.221				1.22			1.22	1.22		
	WCDMA IV	Front	1.384	0.743	0.032	0.041	2.13	0.02	#07	1.43	1.46		
		Back	1.223	1.153	1.192	0.079	2.38	0.02	#23	1.30	2.49	0.04	#67
		Front with Headset	1.307				1.31			1.31	1.31		
		Back with Headset	1.121				1.12			1.12	1.12		
	WCDMA V	Front	1.301	0.743	0.032	0.041	2.04	0.02	#08	1.34	1.37		
		Back	1.350	1.153	1.192	0.079	2.50	0.03	#24	1.43	2.62	0.04	#68
		Front with Headset	1.192				1.19			1.19	1.19		
		Back with Headset	1.338				1.34			1.34	1.34		
CDMA	CDMA2000 BC0	Front	1.219	0.743	0.032	0.041	1.96	0.02	#39	1.26	1.29		
		Back	1.377	1.153	1.192	0.079	2.53	0.03	#42	1.46	2.65	0.04	#69
		Front with Headset	1.109				1.11			1.11	1.11		
		Back with Headset	1.329				1.33			1.33	1.33		
	CDMA2000 BC1	Front	1.312	0.743	0.032	0.041	2.06	0.02	#40	1.35	1.39		
		Back	1.277	1.153	1.192	0.079	2.43	0.03	#43	1.36	2.55	0.04	#70
		Front with Headset	1.277				1.28			1.28	1.28		
		Back with Headset	1.162				1.16			1.16	1.16		
	CDMA2000 BC10	Front	1.147	0.743	0.032	0.041	1.89	0.02	#41	1.19	1.22		
		Back	1.195	1.153	1.192	0.079	2.35	0.02	#44	1.27	2.47	0.04	#71
		Front with Headset					0.00			0.00	0.00		
		Back with Headset					0.00			0.00	0.00		
LTE	LTE Band 5	Front	1.289	0.743	0.032	0.041	2.03	0.02	#11	1.33	1.36		
		Back	1.436	1.153	1.192	0.079	2.59	0.03	#28	1.52	2.71	0.04	#72
		Front with Headset	1.203				1.20			1.20	1.20		
		Back with Headset	1.301				1.30			1.30	1.30		
	LTE Band 71	Front	0.819	0.743	0.032	0.041	1.56			0.86	0.89		
		Back	1.000	1.153	1.192	0.079	2.15	0.02	#29	1.08	2.27	0.04	#73
		Front with Headset					0.00			0.00	0.00		
		Back with Headset					0.00			0.00	0.00		
	LTE Band 12	Front	0.817	0.743	0.032	0.041	1.56			0.86	0.89		
		Back	0.911	1.153	1.192	0.079	2.06	0.02	#30	0.99	2.18	0.04	#74
		Front with Headset					0.00			0.00	0.00		
		Back with Headset					0.00			0.00	0.00		
	LTE Band 13	Front	1.163	0.743	0.032	0.041	1.91	0.02	#12	1.20	1.24		
Back		1.239	1.153	1.192	0.079	2.39	0.02	#31	1.32	2.51	0.04	#75	
Front with Headset						0.00			0.00	0.00			
Back with Headset		1.234				1.23			1.23	1.23			



WWAN Band	Exposure Position	1	2	4	6	1+2 Summed 1g SAR (W/kg)	SPLSR	Case No	1+6 Summed 1g SAR (W/kg)	1+4+6 Summed 1g SAR (W/kg)	SPLSR	Case No	
		WWAN	2.4GHz WLAN Ant 1	5GHz WLAN Ant 1	Bluetooth Ant 1								
		1g SAR (W/kg)	1g SAR (W/kg)	1g SAR (W/kg)	1g SAR (W/kg)								
LTE	LTE Band 14	Front	0.925	0.743	0.032	0.041	1.67	0.01	#13	0.97	1.00		
		Back	0.964	1.153	1.192	0.079	2.12	0.02	#32	1.04	2.24	0.04	#76
		Front with Headset					0.00			0.00	0.00		
		Back with Headset					0.00			0.00	0.00		
	LTE Band 26	Front	1.295	0.743	0.032	0.041	2.04	0.02	#14	1.34	1.37		
		Back	1.126	1.153	1.192	0.079	2.28	0.02	#33	1.21	2.40	0.04	#77
		Front with Headset	1.196				1.20			1.20	1.20		
		Back with Headset					0.00			0.00	0.00		
	LTE Band 25	Front	1.340	0.743	0.032	0.041	2.08	0.02	#15	1.38	1.41		
		Back	1.259	1.153	1.192	0.079	2.41	0.02	#34	1.34	2.53	0.04	#78
		Front with Headset	1.267				1.27			1.27	1.27		
		Back with Headset	1.227				1.23			1.23	1.23		
	LTE Band 66	Front	1.359	0.743	0.032	0.041	2.10	0.02	#16	1.40	1.43		
		Back	1.336	1.153	1.192	0.079	2.49	0.03	#35	1.42	2.61	0.04	#79
		Front with Headset	1.246				1.25			1.25	1.25		
		Back with Headset	1.144				1.14			1.14	1.14		
	LTE Band 7	Front	1.164	0.743	0.032	0.041	1.91	0.02	#17	1.21	1.24		
		Back	1.265	1.153	1.192	0.079	2.42	0.03	#36	1.34	2.54	0.04	#80
		Front with Headset					0.00			0.00	0.00		
		Back with Headset	1.198				1.20			1.20	1.20		
	LTE Band 30	Front	1.134	0.743	0.032	0.041	1.88	0.02	#18	1.18	1.21		
		Back	1.279	1.153	1.192	0.079	2.43	0.03	#37	1.36	2.55	0.04	#81
		Front with Headset					0.00			0.00	0.00		
		Back with Headset	1.206				1.21			1.21	1.21		
LTE Band 41	Front	1.266	0.743	0.032	0.041	2.01	0.02	#19	1.31	1.34			
	Back	1.439	1.153	1.192	0.079	2.59	0.03	#38	1.52	2.71	0.04	#82	
	Front with Headset	1.218				1.22			1.22	1.22			
	Back with Headset	1.400				1.40			1.40	1.40			



WWAN Band		Exposure Position	1	2	4	1+2 Summed 1g SAR (W/kg)	1+4 Summed 1g SAR (W/kg)	SPLSR	Case No
			WWAN 1g SAR (W/kg)	2.4GHz WLAN Ant 1 1g SAR (W/kg)	5GHz WLAN Ant 1 1g SAR (W/kg)				
GSM	GSM1900	Front at 18mm	0.794	0.153	0.020	0.95	0.81		
		Back at 19mm	0.669	0.226	1.377	0.90	<b>2.05</b>	<b>0.02</b>	<b>#83</b>
WCDMA	WCDMA II	Front at 18mm	1.057	0.153	0.020	1.21	1.08		
		Back at 19mm	1.235	0.226	1.377	1.46	<b>2.61</b>	<b>0.03</b>	<b>#84</b>
	WCDMA IV	Front at 18mm	1.259	0.153	0.020	1.41	1.28		
		Back at 19mm	1.180	0.226	1.377	1.41	<b>2.56</b>	<b>0.03</b>	<b>#85</b>
	WCDMA V	Front at 18mm	0.412	0.153	0.020	0.57	0.43		
		Back at 19mm	0.347	0.226	1.377	0.57	<b>1.72</b>	<b>0.04</b>	<b>#86</b>
CDMA	CDMA2000 BC1	Front at 18mm	0.797	0.153	0.020	0.95	0.82		
		Back at 19mm	0.880	0.226	1.377	1.11	<b>2.26</b>	<b>0.03</b>	<b>#87</b>
LTE	LTE Band 26	Front at 18mm	0.253	0.153	0.020	0.41	0.27		
		Back at 19mm	0.200	0.226	1.377	0.43	<b>1.58</b>		
	LTE Band 25	Front at 18mm	0.896	0.153	0.020	1.05	0.92		
		Back at 19mm	0.938	0.226	1.377	1.16	<b>2.32</b>	<b>0.03</b>	<b>#89</b>
	LTE Band 66	Front at 18mm	0.845	0.153	0.020	1.00	0.87		
		Back at 19mm	0.917	0.226	1.377	1.14	<b>2.29</b>	<b>0.03</b>	<b>#90</b>
	LTE Band 7	Front at 18mm	0.309	0.153	0.020	0.46	0.33		
		Back at 19mm	0.301	0.226	1.377	0.53	<b>1.68</b>	<b>0.02</b>	<b>#91</b>
	LTE Band 30	Front at 18mm	0.315	0.153	0.020	0.47	0.34		
		Back at 19mm	0.300	0.226	1.377	0.53	<b>1.68</b>	<b>0.02</b>	<b>#92</b>
	LTE Band 41	Front at 18mm	0.349	0.153	0.020	0.50	0.37		
		Back at 19mm	0.324	0.226	1.377	0.55	<b>1.70</b>	<b>0.02</b>	<b>#93</b>



**16.5 Product specific 10g SAR Exposure Conditions**

**Remark:**

1. For Bluetooth Product specific 10g stand-alone SAR is not required for a transmitter or antenna, due to 1g hotspot SAR is <1.2W/kg.
2. If SPLSR ≤ 0.10 for 10g SAR, simultaneously transmission SAR measurement is not necessary.

WWAN Band	Exposure Position	1	2	4	1+2 Summed 10g SAR (W/kg)	1+4 Summed 10g SAR (W/kg)	SPLSR	Case No	
		WWAN 10g SAR (W/kg)	2.4GHz WLAN Ant 1 10g SAR (W/kg)	5GHz WLAN Ant 1 10g SAR (W/kg)					
GSM	GSM850	Front	1.443		0.082	1.44	1.53		
		Back	1.533	1.556	3.508	3.09	5.04	0.09	#104
		Left side			0.037	0.00	0.04		
		Right side			0.796	0.00	0.80		
		Top side		2.005	0.122	2.01	0.12		
		Bottom side				0.00	0.00		
	GSM1900	Front	2.192		0.082	2.19	2.27		
		Back	2.056	1.556	3.508	3.61	5.56	0.10	#105
		Left side			0.037	0.00	0.04		
		Right side			0.796	0.00	0.80		
		Top side		2.005	0.122	2.01	0.12		
		Bottom side	1.200			1.20	1.20		
WCDMA	WCDMA II	Front	2.072		0.082	2.07	2.15		
		Back	1.959	1.556	3.508	3.52	5.47	0.10	#106
		Left side			0.037	0.00	0.04		
		Right side			0.796	0.00	0.80		
		Top side		2.005	0.122	2.01	0.12		
		Bottom side	1.610			1.61	1.61		
	WCDMA IV	Front	2.185		0.082	2.19	2.27		
		Back	2.144	1.556	3.508	3.70	5.65	0.10	#107
		Left side			0.037	0.00	0.04		
		Right side			0.796	0.00	0.80		
		Top side		2.005	0.122	2.01	0.12		
		Bottom side	1.951			1.95	1.95		
	WCDMA V	Front	2.551		0.082	2.55	2.63		
		Back	1.908	1.556	3.508	3.46	5.42	0.10	#108
		Left side			0.037	0.00	0.04		
		Right side			0.796	0.00	0.80		
		Top side		2.005	0.122	2.01	0.12		
		Bottom side	1.872			1.87	1.87		





WWAN Band	Exposure Position	1	2	4	1+2 Summed 10g SAR (W/kg)	1+4 Summed 10g SAR (W/kg)	SPLSR	Case No	
		WWAN 10g SAR (W/kg)	2.4GHz WLAN Ant 1 10g SAR (W/kg)	5GHz WLAN Ant 1 10g SAR (W/kg)					
CDMA	CDMA2000 BC0	Front	2.541		0.082	2.54	2.62		
		Back	1.723	1.556	3.508	3.28	5.23	0.09	#109
		Left side			0.037	0.00	0.04		
		Right side			0.796	0.00	0.80		
		Top side		2.005	0.122	2.01	0.12		
		Bottom side				0.00	0.00		
	CDMA2000 BC1	Front	2.245		0.082	2.25	2.33		
		Back	2.096	1.556	3.508	3.65	5.60	0.10	#110
		Left side			0.037	0.00	0.04		
		Right side			0.796	0.00	0.80		
		Top side		2.005	0.122	2.01	0.12		
		Bottom side	1.833			1.83	1.83		
	CDMA2000 BC10	Front			0.082	0.00	0.08		
		Back		1.556	3.508	1.56	3.51		
		Left side			0.037	0.00	0.04		
		Right side			0.796	0.00	0.80		
		Top side		2.005	0.122	2.01	0.12		
		Bottom side				0.00	0.00		
LTE	LTE Band 5	Front	2.590		0.082	2.59	2.67		
		Back	1.939	1.556	3.508	3.50	5.45	0.09	#111
		Left side			0.037	0.00	0.04		
		Right side			0.796	0.00	0.80		
		Top side		2.005	0.122	2.01	0.12		
		Bottom side	1.927			1.93	1.93		
	LTE Band 71	Front			0.082	0.00	0.08		
		Back		1.556	3.508	1.56	3.51		
		Left side			0.037	0.00	0.04		
		Right side			0.796	0.00	0.80		
		Top side		2.005	0.122	2.01	0.12		
		Bottom side				0.00	0.00		
	LTE Band 12	Front			0.082	0.00	0.08		
		Back		1.556	3.508	1.56	3.51		
		Left side			0.037	0.00	0.04		
		Right side			0.796	0.00	0.80		
		Top side		2.005	0.122	2.01	0.12		
		Bottom side				0.00	0.00		



WWAN Band	Exposure Position	1	2	4	1+2 Summed 10g SAR (W/kg)	SPLSR	Case No	1+4 Summed 10g SAR (W/kg)	SPLSR	Case No	
		WWAN	2.4GHz WLAN Ant 1	5GHz WLAN Ant 1							
		10g SAR (W/kg)	10g SAR (W/kg)	10g SAR (W/kg)							
LTE	LTE Band 13	Front		0.082	0.00			0.08			
		Back	1.933	1.556	3.508	3.49			5.44	0.10	#112
		Left side			0.037	0.00			0.04		
		Right side			0.796	0.00			0.80		
		Top side		2.005	0.122	2.01			0.12		
		Bottom side				0.00			0.00		
	LTE Band 14	Front			0.082	0.00			0.08		
		Back		1.556	3.508	1.56			3.51		
		Left side			0.037	0.00			0.04		
		Right side			0.796	0.00			0.80		
		Top side		2.005	0.122	2.01			0.12		
		Bottom side				0.00			0.00		
	LTE Band 26	Front	2.249		0.082	2.25			2.33		
		Back	1.804	1.556	3.508	3.36			5.31	0.09	#113
		Left side			0.037	0.00			0.04		
		Right side			0.796	0.00			0.80		
		Top side		2.005	0.122	2.01			0.12		
		Bottom side	1.360			1.36			1.36		
	LTE Band 25	Front	2.820		0.082	2.82			2.90		
		Back	2.531	1.556	3.508	4.09	0.05	#121	6.04	-	#122
		Left side			0.037	0.00			0.04		
		Right side			0.796	0.00			0.80		
		Top side		2.005	0.122	2.01			0.12		
		Bottom side	1.725			1.73			1.73		
	LTE Band 66	Front	3.267		0.082	3.27			3.35		
		Back	3.151	1.556	3.508	4.71	0.07	#123	6.66	-	#124
		Left side			0.037	0.00			0.04		
		Right side			0.796	0.00			0.80		
		Top side		2.005	0.122	2.01			0.12		
		Bottom side	2.888			2.89			2.89		
	LTE Band 7	Front	2.226		0.082	2.23			2.31		
		Back	2.250	1.556	3.508	3.81			5.76	0.10	#116
		Left side	1.767		0.037	1.77			1.80		
		Right side			0.796	0.00			0.80		
		Top side		2.005	0.122	2.01			0.12		
		Bottom side	2.165			2.17			2.17		
	LTE Band 30	Front	2.137		0.082	2.14			2.22		
		Back	2.163	1.556	3.508	3.72			5.67	0.10	#117
		Left side	1.890		0.037	1.89			1.93		
		Right side			0.796	0.00			0.80		
		Top side		2.005	0.122	2.01			0.12		
		Bottom side	1.668			1.67			1.67		
	LTE Band 41	Front	2.058		0.082	2.06			2.14		
		Back	2.254	1.556	3.508	3.81			5.76	0.10	#118
		Left side	1.862		0.037	1.86			1.90		
		Right side			0.796	0.00			0.80		
		Top side		2.005	0.122	2.01			0.12		
		Bottom side	1.068			1.07			1.07		

**16.6 SPLSR Evaluation and Analysis**

**General Note:**

1. When standalone SAR is measured for both antennas in the pair, the peak location separation distance is computed by the square root of  $[(x1-x2)^2 + (y1-y2)^2 + (z1-z2)^2]$ , where  $(x1, y1, z1)$  and  $(x2, y2, z2)$  are the coordinates in the area scans or extrapolated peak SAR locations in the zoom scans, as appropriate.
2.  $SPLSR = (SAR1 + SAR2)1.5 / (\text{min. separation distance, mm})$ . If  $SPLSR \leq 0.04$  for 1g SAR and  $SPLSR \leq 0.10$  for 10g SAR, simultaneously transmission SAR measurement is not necessary.

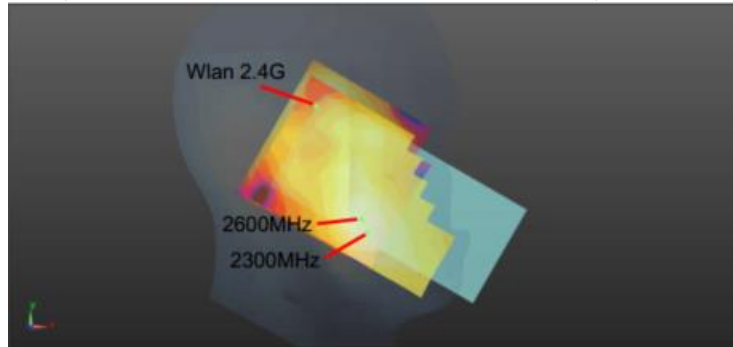

**WWAN+WLAN2.4G Head**

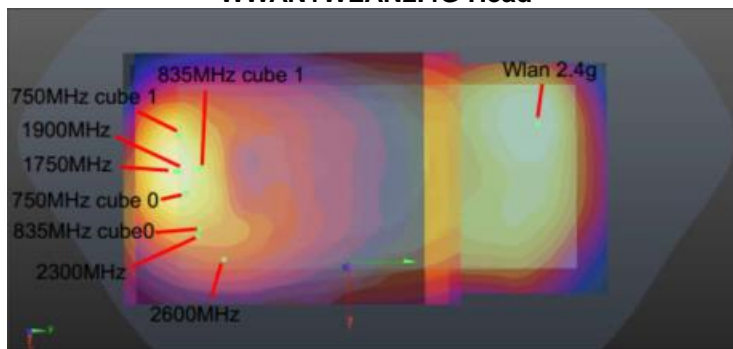

**WWAN (5mm)+2.4G(5mm) Back**

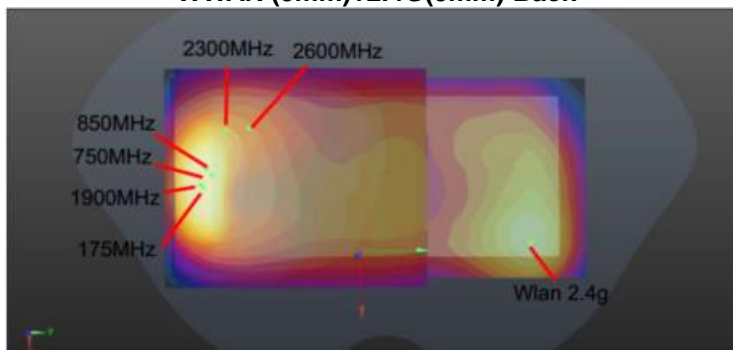

**WWAN(5mm)+2.4G(5mm) Front**

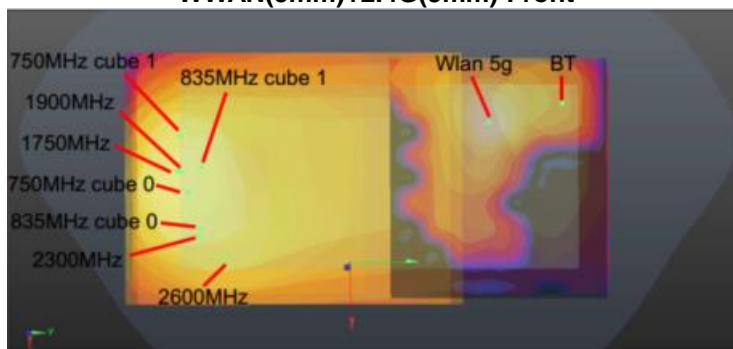

**WWAN(5mm)+5G(5mm)+BT(5mm) Back**

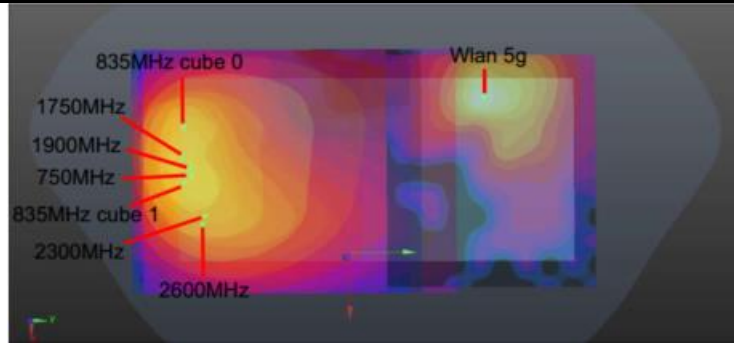

WWAN(0mm)+5G(0mm) Back

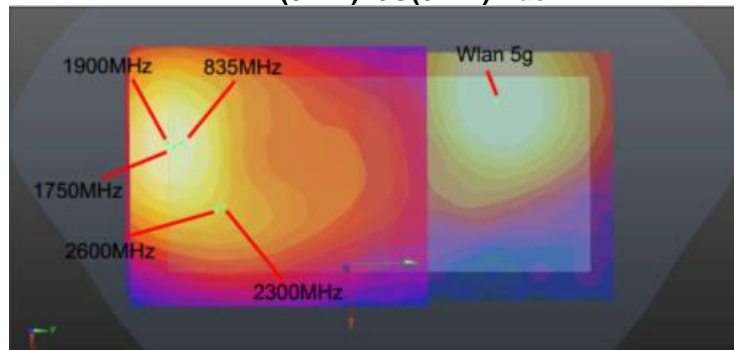

WWAN(19mm)+5G(19mm) Back

Head (wwan+2.4G)											
Case	Band	Position	SAR (W/kg)	Gap (mm)	SAR peak location (m)			3D distance (mm)	Summed SAR (W/kg)	SPLSR Results	Simultaneous SAR
					X	Y	Z				
Case 1	LTE Band 7	Left Cheek	0.688	0	0.0586	0.253	-0.176	86.2	1.78	0.03	Not required
	WLAN2.4GHz		1.092	0	0.0264	0.333	-0.175				
Case 2	LTE Band 30	Left Cheek	0.514	0	0.0629	0.244	-0.174	96.2	1.61	0.02	Not required
	WLAN2.4GHz		1.092	0	0.0264	0.333	-0.175				
Case 3	LTE Band 41	Left Cheek	0.601	0	0.0581	0.255	-0.176	84.2	1.69	0.03	Not required
	WLAN2.4GHz		1.092	0	0.0264	0.333	-0.175				
Front 5mm (wwan+2.4G)											
Case	Band	Position	SAR (W/kg)	Gap (mm)	SAR peak location (m)			3D distance (mm)	Summed SAR (W/kg)	SPLSR Results	Simultaneous SAR
					X	Y	Z				
Case 4	GSM850	Front	1.269	5	-0.0215	-0.093	-0.205	166.5	2.01	0.02	Not required
	WLAN2.4GHz		0.743	5	0.0142	0.0696	-0.207				
Case 5	GSM1900	Front	1.357	5	-0.008	-0.0795	-0.207	150.7	2.10	0.02	Not required
	WLAN2.4GHz		0.743	5	0.0142	0.0696	-0.207				
Case 6	WCDMA II	Front	1.423	5	-0.014	-0.088	-0.207	160.1	2.17	0.02	Not required
	WLAN2.4GHz		0.743	5	0.0142	0.0696	-0.207				



Case	Band	Position	SAR (W/kg)	Gap (mm)	SAR peak location (m)			3D distance (mm)	Summed SAR (W/kg)	SPLSR Results	Simultaneous SAR
					X	Y	Z				
Case 7	WCDMA IV	Front	1.384	5	-0.011	-0.085	-0.207	156.6	2.13	0.02	Not required
	WLAN2.4GHz		0.743	5	0.0142	0.0696	-0.207				
Case 8	WCDMA V	Front	1.301	5	-0.0205	-0.0835	-0.208	157.0	2.04	0.02	Not required
	WLAN2.4GHz		0.743	5	0.0142	0.0696	-0.207				
Case 9	CDMA2000 BC0	Front	1.212	5	-0.0215	-0.082	-0.205	155.8	1.96	0.02	Not required
	WLAN2.4GHz		0.743	5	0.0142	0.0696	-0.207				
Case 10	CDMA2000 BC10	Front	0.989	5	-0.023	-0.082	-0.205	156.1	1.73	0.01	Not required
	WLAN2.4GHz		0.743	5	0.0142	0.0696	-0.207				
Case 11	LTE Band 5	Front	1.289	5	-0.011	-0.0835	-0.208	155.2	2.03	0.02	Not required
	WLAN2.4GHz		0.743	5	0.0142	0.0696	-0.207				
Case 12	LTE Band 13	Front	1.163	5	-0.0185	-0.0825	-0.208	155.6	1.91	0.02	Not required
	WLAN2.4GHz		0.743	5	0.0142	0.0696	-0.207				
Case 13	LTE Band 14	Front	0.925	5	-0.0135	-0.087	-0.208	159.0	1.67	0.01	Not required
	WLAN2.4GHz		0.743	5	0.0142	0.0696	-0.207				
Case 14	LTE Band 26	Front	1.295	5	-0.023	-0.082	-0.208	156.1	2.04	0.02	Not required
	WLAN2.4GHz		0.743	5	0.0142	0.0696	-0.207				
Case 15	LTE Band 25	Front	1.340	5	-0.011	-0.0865	-0.207	158.1	2.08	0.02	Not required
	WLAN2.4GHz		0.743	5	0.0142	0.0696	-0.207				
Case 16	LTE Band 66	Front	1.359	5	-0.0125	-0.0865	-0.207	158.4	2.10	0.02	Not required
	WLAN2.4GHz		0.743	5	0.0142	0.0696	-0.207				
Case 17	LTE Band 7	Front	1.164	5	-0.0446	-0.0666	-0.208	148.4	1.91	0.02	Not required
	WLAN2.4GHz		0.743	5	0.0142	0.0696	-0.207				



Case	Band	Position	SAR (W/kg)	Gap (mm)	SAR peak location (m)			3D distance (mm)	Summed SAR (W/kg)	SPLSR Results	Simultaneous SAR
					X	Y	Z				
Case 18	LTE Band 30	Front	1.134	5	-0.0398	-0.0806	-0.208	159.6	1.88	0.02	Not required
	WLAN2.4GHz		0.743	5	0.0142	0.0696	-0.207				
Case 19	LTE Band 41	Front	1.266	5	-0.041	-0.0698	-0.208	149.9	2.01	0.02	Not required
	WLAN2.4GHz		0.743	5	0.0142	0.0696	-0.207				
<b>Back 5mm (wwan+2.4G)</b>											
Case 20	GSM850	Back	1.378	5	-0.003	-0.0805	-0.208	152.2	2.53	0.03	Not required
	WLAN2.4GHz		1.153	5	-0.0398	0.0672	-0.208				
	GSM850	Back	1.114	5	-0.0335	-0.082	-0.208	149.3	2.27	0.02	Not required
	WLAN2.4GHz		1.153	5	-0.0398	0.0672	-0.208				
Case 21	GSM1900	Back	1.264	5	-0.0185	-0.081	-0.207	149.7	2.42	0.03	Not required
	WLAN2.4GHz		1.153	5	-0.0398	0.0672	-0.208				
Case 22	WCDMA II	Back	1.372	5	-0.0215	-0.0805	-0.207	148.8	2.53	0.03	Not required
	WLAN2.4GHz		1.153	5	-0.0398	0.0672	-0.208				
Case 23	WCDMA IV	Back	1.223	5	-0.02	-0.0835	-0.207	152.0	2.38	0.02	Not required
	WLAN2.4GHz		1.153	5	-0.0398	0.0672	-0.208				
Case 24	WCDMA V	Back	1.35	5	-0.0015	-0.0805	-0.207	152.6	2.50	0.03	Not required
	WLAN2.4GHz		1.153	5	-0.0398	0.0672	-0.208				
Case 25	CDMA2000 BC0	Back	1.307	5	-0.0125	-0.0725	-0.205	142.4	2.46	0.03	Not required
	WLAN2.4GHz		1.153	5	-0.0398	0.0672	-0.208				
Case 26	CDMA2000 BC1	Back	0.585	5	-0.011	-0.081	-0.207	151.0	1.74	0.02	Not required
	WLAN2.4GHz		1.153	5	-0.0398	0.0672	-0.208				
Case 27	CDMA2000 BC10	Back	1.069	5	0.004	-0.0735	-0.208	147.4	2.22	0.02	Not required
	WLAN2.4GHz		1.153	5	-0.0398	0.0672	-0.208				
	CDMA2000 BC10	Back	0.831	5	-0.0055	-0.0655	-0.208	137.1	1.98	0.02	Not required
	WLAN2.4GHz		1.153	5	-0.0398	0.0672	-0.208				



Case	Band	Position	SAR (W/kg)	Gap (mm)	SAR peak location (m)			3D distance (mm)	Summed SAR (W/kg)	SPLSR Results	Simultaneous SAR
					X	Y	Z				
Case 28	LTE Band 5	Back	1.436	5	-0.011	-0.0805	-0.208	150.5	2.59	0.03	Not required
	WLAN2.4GHz		1.153	5	-0.0398	0.0672	-0.208				
	LTE Band 5	Back	1.096	5	-0.019	-0.09	-0.208	158.6	2.25	0.02	Not required
	WLAN2.4GHz		1.153	5	-0.0398	0.0672	-0.208				
Case 29	LTE Band 71	Back	1	5	0.001	-0.0715	-0.208	144.6	2.15	0.02	Not required
	WLAN2.4GHz		1.153	5	-0.0398	0.0672	-0.208				
Case 30	LTE Band 12	Back	0.911	5	-0.011	-0.0715	-0.208	141.7	2.06	0.02	Not required
	WLAN2.4GHz		1.153	5	-0.0398	0.0672	-0.208				
Case 31	LTE Band 13	Back	1.239	5	-0.003	-0.079	-0.208	150.8	2.39	0.02	Not required
	WLAN2.4GHz		1.153	5	-0.0398	0.0672	-0.208				
	LTE Band 13	Back	0.99	5	-0.035	-0.082	-0.208	149.3	2.14	0.02	Not required
	WLAN2.4GHz		1.153	5	-0.0398	0.0672	-0.208				
Case 32	LTE Band 14	Back	0.964	5	-0.0045	-0.0805	-0.208	151.9	2.12	0.02	Not required
	WLAN2.4GHz		1.153	5	-0.0398	0.0672	-0.208				
Case 33	LTE Band 26	Back	1.126	5	-0.0125	-0.0805	-0.208	150.2	2.28	0.02	Not required
	WLAN2.4GHz		1.153	5	-0.0398	0.0672	-0.208				
Case 34	LTE Band 25	Back	1.259	5	-0.02	-0.082	-0.207	150.5	2.41	0.02	Not required
	WLAN2.4GHz		1.153	5	-0.0398	0.0672	-0.208				
Case 35	LTE Band 66	Back	1.336	5	-0.02	-0.082	-0.207	150.5	2.49	0.03	Not required
	WLAN2.4GHz		1.153	5	-0.0398	0.0672	-0.208				
Case 36	LTE Band 7	Back	1.265	5	0.0106	-0.0724	-0.207	148.4	2.42	0.03	Not required
	WLAN2.4GHz		1.153	5	-0.0398	0.0672	-0.208				
Case 37	LTE Band 30	Back	1.279	5	0.012	-0.0744	-0.207	150.8	2.43	0.03	Not required
	WLAN2.4GHz		1.153	5	-0.0398	0.0672	-0.208				



Case	Band	Position	SAR (W/kg)	Gap (mm)	SAR peak location (m)			3D distance (mm)	Summed SAR (W/kg)	SPLSR Results	Simultaneous SAR
					X	Y	Z				
Case 38	LTE Band 41	Back	1.439	5	0.0166	-0.0636	-0.207	142.4	2.59	0.03	Not required
	WLAN2.4GHz		1.153	5	-0.0398	0.0672	-0.208				
<b>Front 5mm (wwan+2.4G)</b>											
Case 39	CDMA2000 BC0	Front	1.219	5	-0.023	-0.082	-0.206	156.1	1.96	0.02	Not required
	WLAN2.4GHz		0.743	5	0.0142	0.0696	-0.207				
Case 40	CDMA2000 BC1	Front	1.312	5	-0.014	-0.0835	-0.207	155.7	2.06	0.02	Not required
	WLAN2.4GHz		0.743	5	0.0142	0.0696	-0.207				
Case 41	CDMA2000 BC10	Front	1.147	5	-0.023	-0.082	-0.205	156.1	1.89	0.02	Not required
	WLAN2.4GHz		0.743	5	0.0142	0.0696	-0.207				
<b>Back 5mm (wwan+2.4G)</b>											
Case 42	CDMA2000 BC0	Back	1.377	5	0.004	-0.0735	-0.208	147.4	2.53	0.03	Not required
	WLAN2.4GHz		1.153	5	-0.0398	0.0672	-0.208				
	CDMA2000 BC0	Back	1.098	5	-0.0055	-0.0655	-0.208	137.1	2.25	0.02	Not required
	WLAN2.4GHz		1.153	5	-0.0398	0.0672	-0.208				
Case 43	CDMA2000 BC1	Back	1.277	5	-0.0185	-0.079	-0.207	147.7	2.43	0.03	Not required
	WLAN2.4GHz		1.153	5	-0.0398	0.0672	-0.208				
Case 44	CDMA2000 BC10	Back	1.195	5	-0.0045	-0.0805	-0.206	151.9	2.35	0.02	Not required
	WLAN2.4GHz		1.153	5	-0.0398	0.0672	-0.208				
	CDMA2000 BC10	Back	1.004	5	-0.011	-0.0755	-0.206	145.6	2.16	0.02	Not required
	WLAN2.4GHz		1.153	5	-0.0398	0.0672	-0.208				
<b>Back 5mm (wwan+5G+BT)</b>											
Case 45	GSM850	Back	1.378	5	-0.003	-0.0805	-0.208	131.1	2.57	0.03	Not required
	WLAN 5GHz		1.192	5	-0.044	0.044	-0.208				
	GSM850	Back	1.378	5	-0.003	-0.0805	-0.208	165.0	1.46	0.01	Not required
	BT		0.079	5	-0.0482	0.0782	-0.208				
	GSM850	Back	1.114	5	-0.0335	-0.082	-0.208	126.4	2.31	0.03	Not required
	WLAN 5GHz		1.192	5	-0.044	0.044	-0.208				
	GSM850	Back	1.114	5	-0.0335	-0.082	-0.208	160.9	1.19	0.01	Not required
	BT		0.079	5	-0.0482	0.0782	-0.208				
WLAN 5GHz	Back	1.192	5	-0.044	0.044	-0.208	34.5	1.27	0.04	Not required	
BT		0.079	5	-0.0482	0.0782	-0.208					





Case	Band	Position	SAR (W/kg)	Gap (mm)	SAR peak location (m)			3D distance (mm)	Summed SAR (W/kg)	SPLSR Results	Simultaneous SAR
					X	Y	Z				
Case 46	GSM1900	Back	1.264	5	-0.0185	-0.081	-0.207	127.6	2.46	0.03	Not required
	WLAN 5GHz		1.192	5	-0.044	0.044	-0.208				
	GSM1900	Back	1.264	5	-0.0185	-0.081	-0.207	161.9	1.34	0.01	Not required
	BT		0.079	5	-0.0482	0.0782	-0.208				
	WLAN 5GHz	Back	1.192	5	-0.044	0.044	-0.208	34.5	1.27	0.04	Not required
	BT		0.079	5	-0.0482	0.0782	-0.208				
Case 47	WCDMA II	Back	1.372	5	-0.0215	-0.0805	-0.207	126.5	2.56	0.03	Not required
	WLAN 5GHz		1.192	5	-0.044	0.044	-0.208				
	WCDMA II	Back	1.372	5	-0.0215	-0.0805	-0.207	160.9	1.45	0.01	Not required
	BT		0.079	5	-0.0482	0.0782	-0.208				
	WLAN 5GHz	Back	1.192	5	-0.044	0.044	-0.208	34.5	1.27	0.04	Not required
	BT		0.079	5	-0.0482	0.0782	-0.208				
Case 48	WCDMA IV	Back	1.223	5	-0.02	-0.0835	-0.207	129.7	2.42	0.03	Not required
	WLAN 5GHz		1.192	5	-0.044	0.044	-0.208				
	WCDMA IV	Back	1.223	5	-0.02	-0.0835	-0.207	164.1	1.30	0.01	Not required
	BT		0.079	5	-0.0482	0.0782	-0.208				
	WLAN 5GHz	Back	1.192	5	-0.044	0.044	-0.208	34.5	1.27	0.04	Not required
	BT		0.079	5	-0.0482	0.0782	-0.208				
Case 49	WCDMA V	Back	1.35	5	-0.0015	-0.0805	-0.207	131.6	2.54	0.03	Not required
	WLAN 5GHz		1.192	5	-0.044	0.044	-0.208				
	WCDMA V	Back	1.35	5	-0.0015	-0.0805	-0.207	165.4	1.43	0.01	Not required
	BT		0.079	5	-0.0482	0.0782	-0.208				
	WLAN 5GHz	Back	1.192	5	-0.044	0.044	-0.208	34.5	1.27	0.04	Not required
	BT		0.079	5	-0.0482	0.0782	-0.208				
Case 50	CDMA2000 BC0	Back	1.307	5	-0.0125	-0.0725	-0.205	120.7	2.50	0.03	Not required
	WLAN 5GHz		1.192	5	-0.044	0.044	-0.208				
	CDMA2000 BC0	Back	1.307	5	-0.0125	-0.0725	-0.205	154.9	1.39	0.01	Not required
	BT		0.079	5	-0.0482	0.0782	-0.208				
	WLAN 5GHz	Back	1.192	5	-0.044	0.044	-0.208	34.5	1.27	0.04	Not required
	BT		0.079	5	-0.0482	0.0782	-0.208				
Case 51	CDMA2000 BC1	Back	0.585	5	-0.011	-0.081	-0.207	129.3	1.78	0.02	Not required
	WLAN 5GHz		1.192	5	-0.044	0.044	-0.208				
	CDMA2000 BC1	Back	0.585	5	-0.011	-0.081	-0.207	163.5	0.66	0.00	Not required
	BT		0.079	5	-0.0482	0.0782	-0.208				
	WLAN 5GHz	Back	1.192	5	-0.044	0.044	-0.208	34.5	1.27	0.04	Not required
	BT		0.079	5	-0.0482	0.0782	-0.208				



	Band	Position	SAR (W/kg)	Gap (mm)	SAR peak location (m)			3D distance (mm)	Summed SAR (W/kg)	SPLSR Results	Simultaneous SAR
					X	Y	Z				
Case 52	CDMA2000 BC10	Back	1.069	5	0.004	-0.0735	-0.208	126.9	2.26	0.03	Not required
	WLAN 5GHz		1.192	5	-0.044	0.044	-0.208				
	CDMA2000 BC10	Back	1.069	5	0.004	-0.0735	-0.208	160.4	1.15	0.01	Not required
	BT		0.079	5	-0.0482	0.0782	-0.208				
	CDMA2000 BC10	Back	0.831	5	-0.0055	-0.0655	-0.208	116.1	2.02	0.02	Not required
	WLAN 5GHz		1.192	5	-0.044	0.044	-0.208				
	CDMA2000 BC10	Back	0.831	5	-0.0055	-0.0655	-0.208	149.9	0.91	0.01	Not required
	BT		0.079	5	-0.0482	0.0782	-0.208				
WLAN 5GHz	Back	1.192	5	-0.044	0.044	-0.208	34.5	1.27	0.04	Not required	
BT		0.079	5	-0.0482	0.0782	-0.208					
Case 53	LTE Band 5	Back	1.436	5	-0.011	-0.0805	-0.208	128.8	2.63	0.03	Not required
	WLAN 5GHz		1.192	5	-0.044	0.044	-0.208				
	LTE Band 5	Back	1.436	5	-0.011	-0.0805	-0.208	163.0	1.52	0.01	Not required
	BT		0.079	5	-0.0482	0.0782	-0.208				
	LTE Band 5	Back	1.096	5	-0.019	-0.09	-0.208	136.3	2.29	0.03	Not required
	WLAN 5GHz		1.192	5	-0.044	0.044	-0.208				
	LTE Band 5	Back	1.096	5	-0.019	-0.09	-0.208	170.7	1.18	0.01	Not required
	BT		0.079	5	-0.0482	0.0782	-0.208				
WLAN 5GHz	Back	1.192	5	-0.044	0.044	-0.208	34.5	1.27	0.04	Not required	
BT		0.079	5	-0.0482	0.0782	-0.208					
Case 54	LTE Band 71	Back	1.000	5	0.001	-0.0715	-0.208	124.0	2.19	0.03	Not required
	WLAN 5GHz		1.192	5	-0.044	0.044	-0.208				
	LTE Band 71	Back	1.000	5	0.001	-0.0715	-0.208	157.6	1.08	0.01	Not required
	BT		0.079	5	-0.0482	0.0782	-0.208				
	WLAN 5GHz	Back	1.192	5	-0.044	0.044	-0.208	34.5	1.27	0.04	Not required
	BT		0.079	5	-0.0482	0.0782	-0.208				
Case 55	LTE Band 12	Back	0.911	5	-0.011	-0.0715	-0.208	120.1	2.10	0.03	Not required
	WLAN 5GHz		1.192	5	-0.044	0.044	-0.208				
	LTE Band 12	Back	0.911	5	-0.011	-0.0715	-0.208	154.3	0.99	0.01	Not required
	BT		0.079	5	-0.0482	0.0782	-0.208				
	WLAN 5GHz	Back	1.192	5	-0.044	0.044	-0.208	34.5	1.27	0.04	Not required
BT	0.079		5	-0.0482	0.0782	-0.208					
Case 56	LTE Band 13	Back	1.239	5	-0.003	-0.079	-0.208	129.7	2.43	0.03	Not required
	WLAN 5GHz		1.192	5	-0.044	0.044	-0.208				
	LTE Band 13	Back	1.239	5	-0.003	-0.079	-0.208	163.6	1.32	0.01	Not required
	BT		0.079	5	-0.0482	0.0782	-0.208				
	LTE Band 13	Back	0.990	5	-0.035	-0.082	-0.208	126.3	2.18	0.03	Not required
	WLAN 5GHz		1.192	5	-0.044	0.044	-0.208				
	LTE Band 13	Back	0.990	5	-0.035	-0.082	-0.208	160.7	1.07	0.01	Not required
	BT		0.079	5	-0.0482	0.0782	-0.208				
WLAN 5GHz	Back	1.192	5	-0.044	0.044	-0.208	34.5	1.27	0.04	Not required	
BT		0.079	5	-0.0482	0.0782	-0.208					



Case	Band	Position	SAR (W/kg)	Gap (mm)	SAR peak location (m)			3D distance (mm)	Summed SAR (W/kg)	SPLSR Results	Simultaneous SAR
					X	Y	Z				
Case 57	LTE Band 14	Back	0.964	5	-0.0045	-0.0805	-0.208	130.6	2.16	0.02	Not required
	WLAN 5GHz		1.192	5	-0.044	0.044	-0.208				
	LTE Band 14	Back	0.964	5	-0.0045	-0.0805	-0.208	164.6	1.04	0.01	Not required
	BT		0.079	5	-0.0482	0.0782	-0.208				
	WLAN 5GHz	Back	1.192	5	-0.044	0.044	-0.208	34.5	1.27	0.04	Not required
	BT		0.079	5	-0.0482	0.0782	-0.208				
Case 58	LTE Band 26	Back	1.126	5	-0.0125	-0.0805	-0.208	128.4	2.32	0.03	Not required
	WLAN 5GHz		1.192	5	-0.044	0.044	-0.208				
	LTE Band 26	Back	1.126	5	-0.0125	-0.0805	-0.208	162.7	1.21	0.01	Not required
	BT		0.079	5	-0.0482	0.0782	-0.208				
	WLAN 5GHz	Back	1.192	5	-0.044	0.044	-0.208	34.5	1.27	0.04	Not required
	BT		0.079	5	-0.0482	0.0782	-0.208				
Case 59	LTE Band 25	Back	1.259	5	-0.02	-0.082	-0.207	128.3	2.45	0.03	Not required
	WLAN 5GHz		1.192	5	-0.044	0.044	-0.208				
	LTE Band 25	Back	1.259	5	-0.02	-0.082	-0.207	162.7	1.34	0.01	Not required
	BT		0.079	5	-0.0482	0.0782	-0.208				
	WLAN 5GHz	Back	1.192	5	-0.044	0.044	-0.208	34.5	1.27	0.04	Not required
	BT		0.079	5	-0.0482	0.0782	-0.208				
Case 60	LTE Band 66	Back	1.336	5	-0.02	-0.082	-0.207	128.3	2.53	0.03	Not required
	WLAN 5GHz		1.192	5	-0.044	0.044	-0.208				
	LTE Band 66	Back	1.336	5	-0.02	-0.082	-0.207	162.7	1.42	0.01	Not required
	BT		0.079	5	-0.0482	0.0782	-0.208				
	WLAN 5GHz	Back	1.192	5	-0.044	0.044	-0.208	34.5	1.27	0.04	Not required
	BT		0.079	5	-0.0482	0.0782	-0.208				
Case 61	LTE Band 7	Back	1.265	5	0.0106	-0.0724	-0.207	128.6	2.46	0.03	Not required
	WLAN 5GHz		1.192	5	-0.044	0.044	-0.208				
	LTE Band 7	Back	1.265	5	0.0106	-0.0724	-0.207	161.7	1.34	0.01	Not required
	BT		0.079	5	-0.0482	0.0782	-0.208				
	WLAN 5GHz	Back	1.192	5	-0.044	0.044	-0.208	34.5	1.27	0.04	Not required
	BT		0.079	5	-0.0482	0.0782	-0.208				
Case 62	LTE Band 30	Back	1.279	5	0.012	-0.0744	-0.207	131.0	2.47	0.03	Not required
	WLAN 5GHz		1.192	5	-0.044	0.044	-0.208				
	LTE Band 30	Back	1.279	5	0.012	-0.0744	-0.207	164.0	1.36	0.01	Not required
	BT		0.079	5	-0.0482	0.0782	-0.208				
	WLAN 5GHz	Back	1.192	5	-0.044	0.044	-0.208	34.5	1.27	0.04	Not required
	BT		0.079	5	-0.0482	0.0782	-0.208				



Case	Band	Position	SAR (W/kg)	Gap (mm)	SAR peak location (m)			3D distance (mm)	Summed SAR (W/kg)	SPLSR Results	Simultaneous SAR
					X	Y	Z				
Case 63	LTE Band 41	Back	1.439	5	0.0166	-0.0636	-0.207	123.5	2.63	0.03	Not required
	WLAN 5GHz		1.192	5	-0.044	0.044	-0.208				
	LTE Band 41	Back	1.439	5	0.0166	-0.0636	-0.207	155.9	1.52	0.01	Not required
	BT		0.079	5	-0.0482	0.0782	-0.208				
	WLAN 5GHz	Back	1.192	5	-0.044	0.044	-0.208	34.5	1.27	0.04	Not required
	BT		0.079	5	-0.0482	0.0782	-0.208				
Back 5mm (wwan+5G+BT)											
Case 64	GSM850	Back	1.378	5	-0.003	-0.0805	-0.208	131.1	2.57	0.03	Not required
	WLAN 5GHz		1.192	5	-0.044	0.044	-0.208				
	GSM850	Back	1.378	5	-0.0335	-0.082	-0.208	159.5	1.46	0.01	Not required
	BT		0.079	5	-0.0482	0.0768	-0.208				
	GSM850	Back	1.378	5	-0.0335	-0.082	-0.208	126.4	2.57	0.03	Not required
	WLAN 5GHz		1.192	5	-0.044	0.044	-0.208				
	GSM850	Back	1.378	5	-0.0335	-0.082	-0.208	159.5	1.46	0.01	Not required
	BT		0.079	5	-0.0482	0.0768	-0.208				
	WLAN 5GHz	Back	1.192	5	-0.044	0.044	-0.208	33.1	1.27	0.04	Not required
	BT		0.079	5	-0.0482	0.0768	-0.208				
Case 65	GSM1900	Back	1.264	5	-0.0185	-0.081	-0.207	127.6	2.46	0.03	Not required
	WLAN 5GHz		1.192	5	-0.044	0.044	-0.208				
	GSM1900	Back	1.264	5	-0.0185	-0.081	-0.207	160.6	1.34	0.01	Not required
	BT		0.079	5	-0.0482	0.0768	-0.208				
	WLAN 5GHz	Back	1.192	5	-0.044	0.044	-0.208	33.1	1.27	0.04	Not required
	BT		0.079	5	-0.0482	0.0768	-0.208				
Case 66	WCDMA II	Back	1.372	5	-0.0215	-0.0805	-0.207	126.5	2.56	0.03	Not required
	WLAN 5GHz		1.192	5	-0.044	0.044	-0.208				
	WCDMA II	Back	1.372	5	-0.0215	-0.0805	-0.207	159.6	1.45	0.01	Not required
	BT		0.079	5	-0.0482	0.0768	-0.208				
	WLAN 5GHz	Back	1.192	5	-0.044	0.044	-0.208	33.1	1.27	0.04	Not required
	BT		0.079	5	-0.0482	0.0768	-0.208				
Case 67	WCDMA IV	Back	1.223	5	-0.02	-0.0835	-0.207	129.7	2.42	0.03	Not required
	WLAN 5GHz		1.192	5	-0.044	0.044	-0.208				
	WCDMA IV	Back	1.223	5	-0.02	-0.0835	-0.207	162.8	1.30	0.01	Not required
	BT		0.079	5	-0.0482	0.0768	-0.208				
	WLAN 5GHz	Back	1.192	5	-0.044	0.044	-0.208	33.1	1.27	0.04	Not required
	BT		0.079	5	-0.0482	0.0768	-0.208				



Case	Band	Position	SAR (W/kg)	Gap (mm)	SAR peak location (m)			3D distance (mm)	Summed SAR (W/kg)	SPLSR Results	Simultaneous SAR
					X	Y	Z				
Case 68	WCDMA V	Back	1.35	5	-0.0015	-0.0805	-0.207	131.6	2.54	0.03	Not required
	WLAN 5GHz		1.192	5	-0.044	0.044	-0.208				
	WCDMA V	Back	1.35	5	-0.0015	-0.0805	-0.207	164.1	1.43	0.01	Not required
	BT		0.079	5	-0.0482	0.0768	-0.208				
	WLAN 5GHz	Back	1.192	5	-0.044	0.044	-0.208	33.1	1.27	0.04	Not required
	BT		0.079	5	-0.0482	0.0768	-0.208				
Case 69	CDMA2000 BC0	Back	1.377	5	0.004	-0.0735	-0.208	126.9	2.57	0.03	Not required
	WLAN 5GHz		1.192	5	-0.044	0.044	-0.208				
	CDMA2000 BC0	Back	1.377	5	0.004	-0.0735	-0.208	159.1	1.46	0.01	Not required
	BT		0.079	5	-0.0482	0.0768	-0.208				
	CDMA2000 BC0	Back	1.098	5	-0.0055	-0.0655	-0.208	116.1	2.29	0.03	Not required
	WLAN 5GHz		1.192	5	-0.044	0.044	-0.208				
	CDMA2000 BC0	Back	1.098	5	-0.0055	-0.0655	-0.208	148.6	1.18	0.01	Not required
	BT		0.079	5	-0.0482	0.0768	-0.208				
	WLAN 5GHz	Back	1.192	5	-0.044	0.044	-0.208	33.1	1.27	0.04	Not required
	BT		0.079	5	-0.0482	0.0768	-0.208				
Case 70	CDMA2000 BC1	Back	1.277	5	-0.0185	-0.079	-0.207	125.6	2.47	0.03	Not required
	WLAN 5GHz		1.192	5	-0.044	0.044	-0.208				
	CDMA2000 BC1	Back	1.277	5	-0.0185	-0.079	-0.207	158.6	1.36	0.01	Not required
	BT		0.079	5	-0.0482	0.0768	-0.208				
	WLAN 5GHz	Back	1.192	5	-0.044	0.044	-0.208	33.1	1.27	0.04	Not required
	BT		0.079	5	-0.0482	0.0768	-0.208				
Case 71	CDMA2000 BC10	Back	1.195	5	-0.0045	-0.0805	-0.206	130.6	2.39	0.03	Not required
	WLAN 5GHz		1.192	5	-0.044	0.044	-0.208				
	CDMA2000 BC10	Back	1.195	5	-0.0045	-0.0805	-0.206	163.3	1.27	0.01	Not required
	BT		0.079	5	-0.0482	0.0768	-0.208				
	CDMA2000 BC10	Back	1.004	5	-0.011	-0.0755	-0.206	124.0	2.20	0.03	Not required
	WLAN 5GHz		1.192	5	-0.044	0.044	-0.208				
	CDMA2000 BC10	Back	1.004	5	-0.011	-0.0755	-0.206	156.8	1.08	0.01	Not required
	BT		0.079	5	-0.0482	0.0768	-0.208				
	WLAN 5GHz	Back	1.192	5	-0.044	0.044	-0.208	33.1	1.27	0.04	Not required
	BT		0.079	5	-0.0482	0.0768	-0.208				
Case 72	LTE Band 5	Back	1.436	5	-0.011	-0.0805	-0.208	128.8	2.63	0.03	Not required
	WLAN 5GHz		1.192	5	-0.044	0.044	-0.208				
	LTE Band 5	Back	1.436	5	-0.011	-0.0805	-0.208	161.6	1.52	0.01	Not required
	BT		0.079	5	-0.0482	0.0768	-0.208				
	LTE Band 5	Back	1.096	5	-0.019	-0.09	-0.208	136.3	2.29	0.03	Not required
	WLAN 5GHz		1.192	5	-0.044	0.044	-0.208				
	LTE Band 5	Back	1.096	5	-0.019	-0.09	-0.208	169.3	1.18	0.01	Not required
	BT		0.079	5	-0.0482	0.0768	-0.208				
	WLAN 5GHz	Back	1.192	5	-0.044	0.044	-0.208	33.1	1.27	0.04	Not required
	BT		0.079	5	-0.0482	0.0768	-0.208				

Case	Band	Position	SAR (W/kg)	Gap (mm)	SAR peak location (m)			3D distance (mm)	Summed SAR (W/kg)	SPLSR Results	Simultaneous SAR
					X	Y	Z				
Case 73	LTE Band 71	Back	1.000	5	0.001	-0.0715	-0.208	124.0	2.19	0.03	Not required
	WLAN 5GHz		1.192	5	-0.044	0.044	-0.208				
	LTE Band 71	Back	1.000	5	0.001	-0.0715	-0.208	156.2	1.08	0.01	Not required
	BT		0.079	5	-0.0482	0.0768	-0.208				
	WLAN 5GHz	Back	1.192	5	-0.044	0.044	-0.208	33.1	1.27	0.04	Not required
	BT		0.079	5	-0.0482	0.0768	-0.208				
Case 74	LTE Band 12	Back	0.911	5	-0.011	-0.0715	-0.208	120.1	2.10	0.03	Not required
	WLAN 5GHz		1.192	5	-0.044	0.044	-0.208				
	LTE Band 12	Back	0.911	5	-0.011	-0.0715	-0.208	152.9	0.99	0.01	Not required
	BT		0.079	5	-0.0482	0.0768	-0.208				
	WLAN 5GHz	Back	1.192	5	-0.044	0.044	-0.208	33.1	1.27	0.04	Not required
	BT		0.079	5	-0.0482	0.0768	-0.208				
Case 75	LTE Band 13	Back	1.239	5	-0.003	-0.079	-0.208	129.7	2.43	0.03	Not required
	WLAN 5GHz		1.192	5	-0.044	0.044	-0.208				
	LTE Band 13	Back	1.239	5	-0.003	-0.079	-0.208	162.2	1.32	0.01	Not required
	BT		0.079	5	-0.0482	0.0768	-0.208				
	LTE Band 13	Back	0.990	5	-0.035	-0.082	-0.208	126.3	2.18	0.03	Not required
	WLAN 5GHz		1.192	5	-0.044	0.044	-0.208				
	LTE Band 13	Back	0.990	5	-0.035	-0.082	-0.208	159.3	1.07	0.01	Not required
	BT		0.079	5	-0.0482	0.0768	-0.208				
WLAN 5GHz	Back	1.192	5	-0.044	0.044	-0.208	33.1	1.27	0.04	Not required	
BT		0.079	5	-0.0482	0.0768	-0.208					
Case 76	LTE Band 14	Back	0.964	5	-0.0045	-0.0805	-0.208	130.6	2.16	0.02	Not required
	WLAN 5GHz		1.192	5	-0.044	0.044	-0.208				
	LTE Band 14	Back	0.964	5	-0.0045	-0.0805	-0.208	163.3	1.04	0.01	Not required
	BT		0.079	5	-0.0482	0.0768	-0.208				
	WLAN 5GHz	Back	1.192	5	-0.044	0.044	-0.208	33.1	1.27	0.04	Not required
	BT		0.079	5	-0.0482	0.0768	-0.208				
Case 77	LTE Band 26	Back	1.126	5	-0.0125	-0.0805	-0.208	128.4	2.32	0.03	Not required
	WLAN 5GHz		1.192	5	-0.044	0.044	-0.208				
	LTE Band 26	Back	1.126	5	-0.0125	-0.0805	-0.208	161.3	1.21	0.01	Not required
	BT		0.079	5	-0.0482	0.0768	-0.208				
	WLAN 5GHz	Back	1.192	5	-0.044	0.044	-0.208	33.1	1.27	0.04	Not required
	BT		0.079	5	-0.0482	0.0768	-0.208				



Case	Band	Position	SAR (W/kg)	Gap (mm)	SAR peak location (m)			3D distance (mm)	Summed SAR (W/kg)	SPLSR Results	Simultaneous SAR
					X	Y	Z				
Case 78	LTE Band 25	Back	1.259	5	-0.02	-0.082	-0.207	128.3	2.45	0.03	Not required
	WLAN 5GHz		1.192	5	-0.044	0.044	-0.208				
	LTE Band 25	Back	1.259	5	-0.02	-0.082	-0.207	161.3	1.34	0.01	Not required
	BT		0.079	5	-0.0482	0.0768	-0.208				
	WLAN 5GHz	Back	1.192	5	-0.044	0.044	-0.208	33.1	1.27	0.04	Not required
	BT		0.079	5	-0.0482	0.0768	-0.208				
Case 79	LTE Band 66	Back	1.336	5	-0.02	-0.082	-0.207	128.3	2.53	0.03	Not required
	WLAN 5GHz		1.192	5	-0.044	0.044	-0.208				
	LTE Band 66	Back	1.336	5	-0.02	-0.082	-0.207	161.3	1.42	0.01	Not required
	BT		0.079	5	-0.0482	0.0768	-0.208				
	WLAN 5GHz	Back	1.192	5	-0.044	0.044	-0.208	33.1	1.27	0.04	Not required
	BT		0.079	5	-0.0482	0.0768	-0.208				
Case 80	LTE Band 7	Back	1.265	5	0.0106	-0.0724	-0.207	128.6	2.46	0.03	Not required
	WLAN 5GHz		1.192	5	-0.044	0.044	-0.208				
	LTE Band 7	Back	1.265	5	0.0106	-0.0724	-0.207	160.4	1.34	0.01	Not required
	BT		0.079	5	-0.0482	0.0768	-0.208				
	WLAN 5GHz	Back	1.192	5	-0.044	0.044	-0.208	33.1	1.27	0.04	Not required
	BT		0.079	5	-0.0482	0.0768	-0.208				
Case 81	LTE Band 30	Back	1.279	5	0.012	-0.0744	-0.207	131.0	2.47	0.03	Not required
	WLAN 5GHz		1.192	5	-0.044	0.044	-0.208				
	LTE Band 30	Back	1.279	5	0.012	-0.0744	-0.207	162.7	1.36	0.01	Not required
	BT		0.079	5	-0.0482	0.0768	-0.208				
	WLAN 5GHz	Back	1.192	5	-0.044	0.044	-0.208	33.1	1.27	0.04	Not required
	BT		0.079	5	-0.0482	0.0768	-0.208				
Case 82	LTE Band 41	Back	1.439	5	0.0166	-0.0636	-0.207	123.5	2.63	0.03	Not required
	WLAN 5GHz		1.192	5	-0.044	0.044	-0.208				
	LTE Band 41	Back	1.439	5	0.0166	-0.0636	-0.207	154.6	1.52	0.01	Not required
	BT		0.079	5	-0.0482	0.0768	-0.208				
	WLAN 5GHz	Back	1.192	5	-0.044	0.044	-0.208	33.1	1.27	0.04	Not required
	BT		0.079	5	-0.0482	0.0768	-0.208				



Back 19mm (wwan+5G)											
Case	Band	Position	SAR (W/kg)	Gap (mm)	SAR peak location (m)			3D distance (mm)	Summed SAR (W/kg)	SPLSR Results	Simultaneous SAR
					X	Y	Z				
Case 83	GSM1900	Back	0.669	19	-0.0197	-0.0844	-0.207	135.6	2.05	0.02	Not required
	WLAN5GHz		1.377	19	-0.049	0.048	-0.208				
Case 84	WCDMA II	Back	1.235	19	-0.0305	-0.085	-0.207	134.3	2.61	0.03	Not required
	WLAN5GHz		1.377	19	-0.049	0.048	-0.208				
Case 85	WCDMA IV	Back	1.18	19	-0.029	-0.082	-0.207	131.5	2.56	0.03	Not required
	WLAN5GHz		1.377	19	-0.049	0.048	-0.208				
Case 86	WCDMA V	Back	0.347	19	-0.0245	0.0035	-0.21	50.8	1.72	0.04	Not required
	WLAN5GHz		1.377	19	-0.049	0.048	-0.208				
Case 87	CDMA2000 BC1	Back	0.88	19	-0.0245	-0.082	-0.207	132.3	2.26	0.03	Not required
	WLAN5GHz		1.377	19	-0.049	0.048	-0.208				
Case 89	LTE Band 25	Back	0.938	19	-0.0305	-0.079	-0.207	128.3	2.32	0.03	Not required
	WLAN5GHz		1.377	19	-0.049	0.048	-0.208				
Case 90	LTE Band 66	Back	0.917	19	-0.02	-0.0805	-0.207	131.7	2.29	0.03	Not required
	WLAN5GHz		1.377	19	-0.049	0.048	-0.208				
Case 91	LTE Band 7	Back	0.301	19	-0.0038	-0.0648	-0.208	121.5	1.68	0.02	Not required
	WLAN5GHz		1.377	19	-0.049	0.048	-0.208				
Case 92	LTE Band 30	Back	0.3	19	8.74E-11	-0.0674	-0.207	125.4	1.68	0.02	Not required
	WLAN5GHz		1.377	19	-0.049	0.048	-0.208				
Case 93	LTE Band 41	Back	0.324	19	0.0142	-0.0592	-0.207	124.4	1.70	0.02	Not required
	WLAN5GHz		1.377	19	-0.049	0.048	-0.208				



Back 0mm (wwan+5G)											
Case	Band	Position	SAR (W/kg)	Gap (mm)	SAR peak location (m)			3D distance (mm)	Summed SAR (W/kg)	SPLSR Results	Simultaneous SAR
					X	Y	Z				
Case 104	GSM850	Back	1.533	0	-0.0365	-0.082	-0.205	130.7	5.04	0.09	Not required
	WLAN5GHz		3.508	0	-0.05	0.048	-0.208				
	GSM850	Back	1.353	0	-0.0285	-0.082	-0.205	131.8	4.86	0.08	Not required
	WLAN5GHz		3.508	0	-0.05	0.048	-0.208				
Case 105	GSM1900	Back	2.056	0	-0.023	-0.075	-0.208	125.9	5.56	0.10	Not required
	WLAN5GHz		3.508	0	-0.05	0.048	-0.208				
Case 106	WCDMA II	Back	1.959	0	-0.0305	-0.0765	-0.208	126.0	5.47	0.10	Not required
	WLAN5GHz		3.508	0	-0.05	0.048	-0.208				
Case 107	WCDMA IV	Back	2.144	0	-0.0245	-0.0775	-0.208	128.1	5.65	0.10	Not required
	WLAN5GHz		3.508	0	-0.05	0.048	-0.208				
Case 108	WCDMA V	Back	1.908	0	-0.0365	-0.0835	-0.209	132.2	5.42	0.10	Not required
	WLAN5GHz		3.508	0	-0.05	0.048	-0.208				
	WCDMA V	Back	1.743	0	-0.03	-0.0835	-0.209	133.0	5.25	0.09	Not required
	WLAN5GHz		3.508	0	-0.05	0.048	-0.208				
Case 109	CDMA2000 BC0	Back	1.723	0	-0.0365	-0.082	-0.205	130.7	5.23	0.09	Not required
	WLAN5GHz		3.508	0	-0.05	0.048	-0.208				
	CDMA2000 BC0	Back	1.545	0	-0.0285	-0.082	-0.205	131.8	5.05	0.09	Not required
	WLAN5GHz		3.508	0	-0.05	0.048	-0.208				
Case 110	CDMA2000 BC1	Back	2.096	0	-0.028	-0.0765	-0.208	126.4	5.60	0.10	Not required
	WLAN5GHz		3.508	0	-0.05	0.048	-0.208				
Case 111	LTE Band 5	Back	1.939	0	-0.0285	-0.093	-0.207	142.6	5.45	0.09	Not required
	WLAN5GHz		3.508	0	-0.05	0.048	-0.208				
	LTE Band 5	Back	0.069	0	0.0035	-0.088	-0.207	146.1	3.58	0.05	Not required
	WLAN5GHz		3.508	0	-0.05	0.048	-0.208				
Case 112	LTE Band 13	Back	1.933	0	-0.0315	-0.079	-0.208	128.3	5.44	0.10	Not required
	WLAN5GHz		3.508	0	-0.05	0.048	-0.208				



Case No	Band	Position	SAR (W/kg)	Gap (mm)	SAR peak location (m)			3D distance (mm)	Summed SAR (W/kg)	SPLSR Results	Simultaneous SAR
					X	Y	Z				
Case 113	LTE Band 26	Back	1.804	0	-0.0365	-0.082	-0.205	130.7	5.31	0.09	Not required
	WLAN5GHz		3.508	0	-0.05	0.048	-0.208				
	LTE Band 26	Back	1.557	0	-0.0285	-0.082	-0.205	131.8	5.07	0.09	Not required
	WLAN5GHz		3.508	0	-0.05	0.048	-0.208				
Case 116	LTE Band 7	Back	2.25	0	0.0022	-0.0732	-0.208	132.0	5.76	0.10	Not required
	WLAN5GHz		3.508	0	-0.05	0.048	-0.208				
Case 117	LTE Band 30	Back	2.163	0	0.0022	-0.0732	-0.208	132.0	5.67	0.10	Not required
	WLAN5GHz		3.508	0	-0.05	0.048	-0.208				
Case 118	LTE Band 41	Back	2.254	0	0.0058	-0.0756	-0.208	135.6	5.76	0.10	Not required
	WLAN5GHz		3.508	0	-0.05	0.048	-0.208				

Back 0mm (wwan+2.4G)											
Case No	Band	Position	SAR (W/kg)	Gap (mm)	SAR peak location (m)			3D distance (mm)	Summed SAR (W/kg)	SPLSR Results	Simultaneous SAR
					X	Y	Z				
121	LTE Band 25	Back	2.531	0	-0.0265	-0.0855	-0.204	154.5	4.09	0.05	Not required
	WLAN2.4GHz		1.556	0	-0.0398	0.0684	-0.208				
123	LTE Band 66	Back	3.151	0	-0.0345	-0.0855	-0.203	154.1	4.71	0.07	Not required
	WLAN2.4GHz		1.556	0	-0.0398	0.0684	-0.208				



**16.7 Volume Scan Result**

**General Note:**

1. During multi-band SAR combination, the SAR scaling factors were input into the SEMCAD X software to account for tune-up tolerance.
2. Multi-band SAR (Volume SAR) test results are less than 10g SAR 4.0W/kg and complied.

Back 0mm (wwan+5G)												
Case No	Band	Position	SAR (W/kg)	Gap (mm)	SAR peak location (m)			3D distance (mm)	Summed SAR (W/kg)	SPLSR Results	Simultaneous SAR	Multi Band SAR
					X	Y	Z					
122	LTE Band 25	Back	2.531	0	-0.0265	-0.0855	-0.204	135.6	6.04	0.11	Required	3.26
	WLAN5GHz		3.508	0	-0.05	0.048	-0.208					
Case No	Band	Position	SAR (W/kg)	Gap (mm)	SAR peak location (m)			3D distance (mm)	Summed SAR (W/kg)	SPLSR Results	Simultaneous SAR	Multi Band SAR
124	LTE Band 66	Back	3.151	0	-0.0345	-0.0855	-0.203	134.5	6.66	0.13	Required	3.39
	WLAN5GHz		3.508	0	-0.05	0.048	-0.208					



## **17. Supplemental Tuner Tests Results**

### **General Note:**

1. The following test procedure was followed to demonstrate that the SAR results in this report represent the appropriate SAR test conditions. For bands with dynamic tuning implemented, SAR will be measured according to the required FCC SAR test procedures with the dynamic tuner active to allow the device to automatically tune to the antenna state for the respective RF exposure test configurations. Additional single point SAR time-sweep measurements will be evaluated for other tuner states to determine that the other tuner configurations would result in equivalent or lower SAR values. The additional tuner hardware has no influence to the antenna characteristics, other than impedance matching.
2. To evaluate all of the tuner states, the 144 tuner states are divided evenly among bands (except for GSM850/1900, LTE B7/30/38/41), mode and exposure combinations so that at least one single point SAR measurement is measured in each configuration. Single point time-sweep measurements will be performed at the peak SAR location determined by the zoom scan of the configuration with the highest reported SAR for each combination. The tuner state will be established remotely so that the device is not moved for the entire series of single point SAR for the tuner states in each combination. The SAR probe will remain stationary at the same position throughout the entire series of single point measurements for each combination.
3. This device supports LTE B2 / B4 / B17 and B25 / B66 / B12. Since the supported frequency span for LTE B2 / B4 / B17 falls completely within the supports frequency span for LTE B25 / B66 / B12, both LTE bands have the same target power, and both LTE bands share the same transmission path; therefore, chose LTE B25 / B66 / B12 for dynamic antenna analysis.
4. According to workshop 2019, if any single point SAR measurement result is  $> 1.2 \text{ W/kg}$  for a band/exposure condition combination set, all supported tuner states are evaluated with single point SAR measurements for the combination. So we verified the single point SAR that bands with SAR value high than  $1.2 \text{ W/Kg}$ .
5. The operational decryption contains more information about the design and implementation of the dynamic antenna tuning.

### **17.1 Supplemental Tuner Head & Body SAR Results**

Please refer to Appendix F.

**Test Engineer** : Changlin Huang, Bin He, Mengming Dai



## **18. Uncertainty Assessment**

Per KDB 865664 D01 SAR measurement 100MHz to 6GHz, when the highest measured 1-g SAR within a frequency band is  $< 1.5$  W/kg and the measured 10-g SAR within a frequency band is  $< 3.75$  W/kg. The expanded SAR measurement uncertainty must be  $\leq 30\%$ , for a confidence interval of  $k = 2$ . If these conditions are met, extensive SAR measurement uncertainty analysis described in IEEE Std 1528-2013 is not required in SAR reports submitted for equipment approval. For this device, the highest measured 1-g SAR is less 1.5W/kg and highest measured 10-g SAR is less 3.75W/kg. Therefore, the measurement uncertainty table is not required in this report.



## **19. References**

- [1] FCC 47 CFR Part 2 “Frequency Allocations and Radio Treaty Matters; General Rules and Regulations”
- [2] ANSI/IEEE Std. C95.1-1992, “IEEE Standard for Safety Levels with Respect to Human Exposure to Radio Frequency Electromagnetic Fields, 3 kHz to 300 GHz”, September 1992
- [3] IEEE Std. 1528-2013, “IEEE Recommended Practice for Determining the Peak Spatial-Average Specific Absorption Rate (SAR) in the Human Head from Wireless Communications Devices: Measurement Techniques”, Sep 2013
- [4] SPEAG DASY System Handbook
- [5] FCC KDB 865664 D01 v01r04, "SAR Measurement Requirements for 100 MHz to 6 GHz", Aug 2015.
- [6] FCC KDB 865664 D02 v01r02, “RF Exposure Compliance Reporting and Documentation Considerations” Oct 2015.
- [7] FCC KDB 447498 D01 v06, “Mobile and Portable Device RF Exposure Procedures and Equipment Authorization Policies”, Oct 2015
- [8] FCC KDB 648474 D04 v01r03, “SAR Evaluation Considerations for Wireless Handsets”, Oct 2015.
- [9] FCC KDB 248227 D01 v02r02, “SAR Guidance for IEEE 802.11 (WiFi) Transmitters”, Oct 2015.
- [10] FCC KDB 616217 D04 v01r02, “SAR Evaluation Considerations for Laptop, Notebook, Netbook and Tablet Computers”, Oct 2015
- [11] FCC KDB 941225 D01 v03r01, “3G SAR MEAUREMENT PROCEDURES”, Oct 2015
- [12] FCC KDB 941225 D05 v02r05, “SAR Evaluation Considerations for LTE Devices”, Dec 2015
- [13] FCC KDB 941225 D05A v01r02, “Rel. 10 LTE SAR Test Guidance and KDB Inquiries”, Oct 2015
- [14] FCC KDB 941225 D06 v02r01, "SAR Evaluation Procedures for Portable Devices with Wireless Router Capabilities", Oct 2015.

-----THE END-----



---

**Appendix A. Plots of System Performance Check**

The plots are shown as follows.

### System Check\_Head\_750MHz

**DUT: D750V3-SN:1099**

Communication System: UID 0, CW (0); Frequency: 750 MHz; Duty Cycle: 1:1

Medium: HSL\_750\_200828 Medium parameters used:  $f = 750$  MHz;  $\sigma = 0.886$  S/m;  $\epsilon_r = 41.532$ ;  $\rho = 1000$  kg/m<sup>3</sup>

Ambient Temperature : 23.4 °C; Liquid Temperature : 22.4 °C

DASY5 Configuration:

- Probe: EX3DV4 - SN3826; ConvF(9.37, 9.37, 9.37); Calibrated: 2020.05.20;
- Sensor-Surface: 2mm (Mechanical Surface Detection)
- Electronics: DAE4 Sn1210; Calibrated: 2020.07.27
- Phantom: SAM2; Type: QD000P40CD; Serial: TP:1671
- Measurement SW: DASY52, Version 52.8 (8); SEMCAD X Version 14.6.10 (7331)

**Pin=250mW/Area Scan (61x61x1):** Interpolated grid: dx=1.500 mm, dy=1.500 mm

Maximum value of SAR (interpolated) = 2.78 W/kg

**Pin=250mW/Zoom Scan (5x5x7)/Cube 0:** Measurement grid: dx=8mm, dy=8mm, dz=5mm

Reference Value = 56.72 V/m; Power Drift = -0.18 dB

Peak SAR (extrapolated) = 3.28 W/kg

**SAR(1 g) = 2.21 W/kg; SAR(10 g) = 1.48 W/kg**

Maximum value of SAR (measured) = 2.76 W/kg

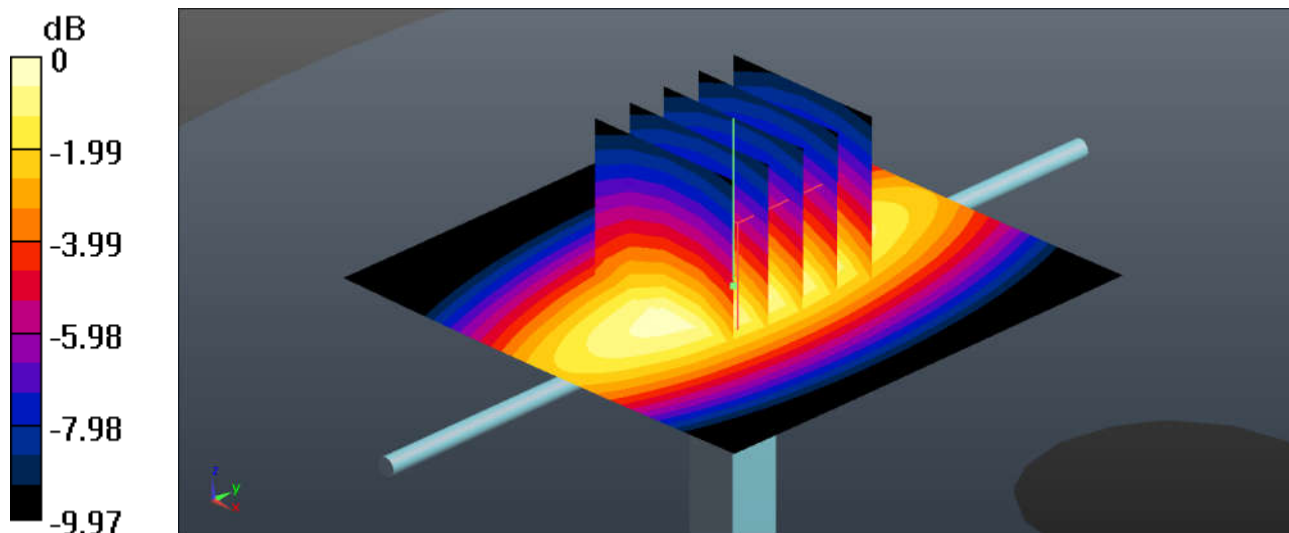

0 dB = 2.78 W/kg



## System Check\_Head\_750MHz

**DUT: D750V3-SN:1099**

Communication System: UID 0, CW (0); Frequency: 750 MHz; Duty Cycle: 1:1

Medium: HSL\_750\_200915 Medium parameters used:  $f = 750$  MHz;  $\sigma = 0.878$  S/m;  $\epsilon_r = 40.673$ ;  $\rho = 1000$  kg/m<sup>3</sup>

Ambient Temperature : 23.5 °C; Liquid Temperature : 22.4 °C

DASY5 Configuration:

- Probe: EX3DV4 - SN7576; ConvF(10.71, 10.71, 10.71); Calibrated: 2020.01.22;
- Sensor-Surface: 2mm (Mechanical Surface Detection)
- Electronics: DAE3 Sn528; Calibrated: 2020.03.16
- Phantom: SAM (Front) with CRP v5.0; Type: QD000P40CD; Serial: TP:1795
- Measurement SW: DASY52, Version 52.8 (8); SEMCAD X Version 14.6.10 (7331)

**Pin=250mW/Area Scan (61x61x1):** Interpolated grid: dx=1.500 mm, dy=1.500 mm

Maximum value of SAR (interpolated) = 2.60 W/kg

**Pin=250mW/Zoom Scan (5x5x7)/Cube 0:** Measurement grid: dx=8mm, dy=8mm, dz=5mm

Reference Value = 55.49 V/m; Power Drift = 0.05 dB

Peak SAR (extrapolated) = 3.03 W/kg

**SAR(1 g) = 2.1 W/kg; SAR(10 g) = 1.41 W/kg**

Maximum value of SAR (measured) = 2.62 W/kg

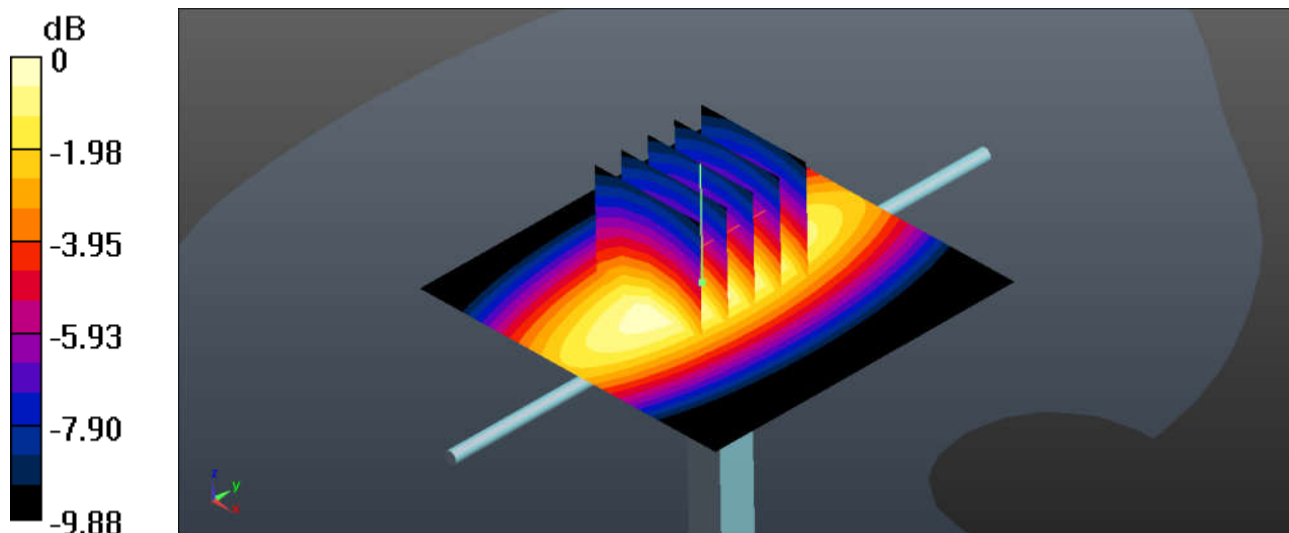

0 dB = 2.60 W/kg

### System Check\_Head\_835MHz

**DUT: D835V2-SN:4d162**

Communication System: UID 0, CW (0); Frequency: 835 MHz; Duty Cycle: 1:1

Medium: HSL\_835\_200827 Medium parameters used:  $f = 835$  MHz;  $\sigma = 0.913$  S/m;  $\epsilon_r = 40.859$ ;  $\rho = 1000$  kg/m<sup>3</sup>

Ambient Temperature : 23.4 °C; Liquid Temperature : 22.5 °C

DASY5 Configuration:

- Probe: EX3DV4 - SN3826; ConvF(9.12, 9.12, 9.12); Calibrated: 2020.05.20;
- Sensor-Surface: 2mm (Mechanical Surface Detection)
- Electronics: DAE4 Sn1210; Calibrated: 2020.07.27
- Phantom: SAM2; Type: QD000P40CD; Serial: TP:1671
- Measurement SW: DASY52, Version 52.8 (8); SEMCAD X Version 14.6.10 (7331)

**Pin=250mW/Area Scan (61x61x1):** Interpolated grid: dx=1.500 mm, dy=1.500 mm

Maximum value of SAR (interpolated) = 3.31 W/kg

**Pin=250mW/Zoom Scan (5x5x7)/Cube 0:** Measurement grid: dx=8mm, dy=8mm, dz=5mm

Reference Value = 58.61 V/m; Power Drift = -0.11 dB

Peak SAR (extrapolated) = 3.96 W/kg

**SAR(1 g) = 2.63 W/kg; SAR(10 g) = 1.73 W/kg**

Maximum value of SAR (measured) = 3.34 W/kg

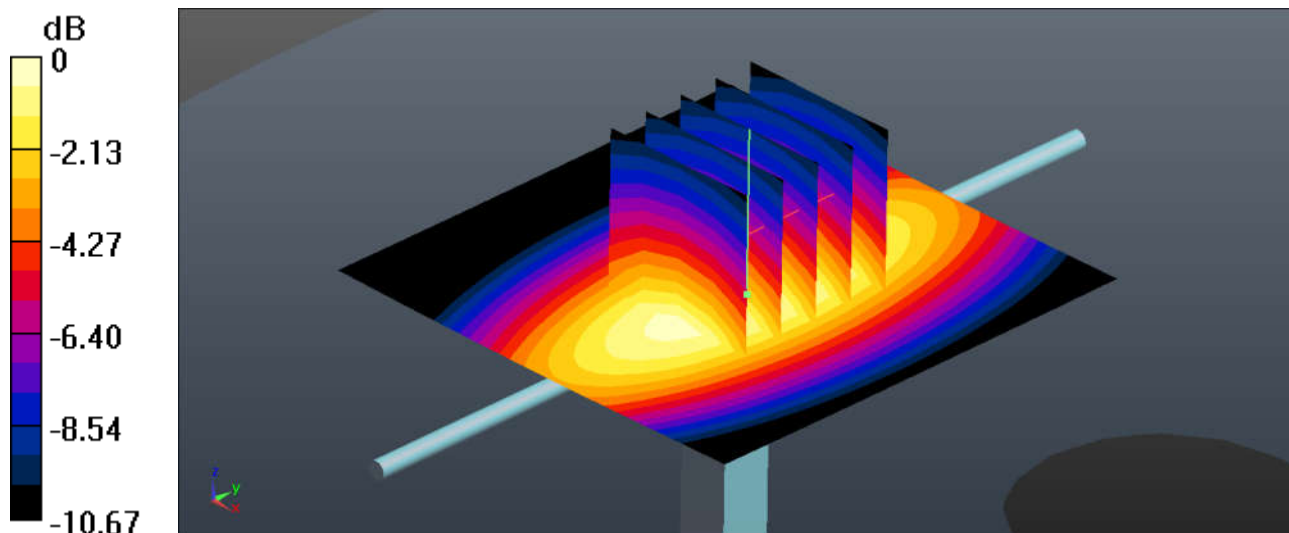

0 dB = 3.31 W/kg

### System Check\_Head\_835MHz

**DUT: D835V2-SN:4d162**

Communication System: UID 0, CW (0); Frequency: 835 MHz; Duty Cycle: 1:1

Medium: HSL\_835\_200917 Medium parameters used:  $f = 835$  MHz;  $\sigma = 0.914$  S/m;  $\epsilon_r = 41.826$ ;  $\rho = 1000$  kg/m<sup>3</sup>

Ambient Temperature : 23.5 °C ; Liquid Temperature : 22.5 °C

DASY5 Configuration:

- Probe: EX3DV4 - SN7576; ConvF(10.45, 10.45, 10.45); Calibrated: 2020.01.22;
- Sensor-Surface: 2mm (Mechanical Surface Detection)
- Electronics: DAE3 Sn528; Calibrated: 2020.03.16
- Phantom: SAM (Front) with CRP v5.0; Type: QD000P40CD; Serial: TP:1795
- Measurement SW: DASY52, Version 52.8 (8); SEMCAD X Version 14.6.10 (7331)

**Pin=250mW/Area Scan (61x61x1):** Interpolated grid: dx=1.500 mm, dy=1.500 mm  
Maximum value of SAR (interpolated) = 3.08 W/kg

**Pin=250mW/Zoom Scan (5x5x7)/Cube 0:** Measurement grid: dx=8mm, dy=8mm, dz=5mm  
Reference Value = 59.22 V/m; Power Drift = 0.01 dB  
Peak SAR (extrapolated) = 3.61 W/kg  
**SAR(1 g) = 2.47 W/kg; SAR(10 g) = 1.63 W/kg**  
Maximum value of SAR (measured) = 3.11 W/kg

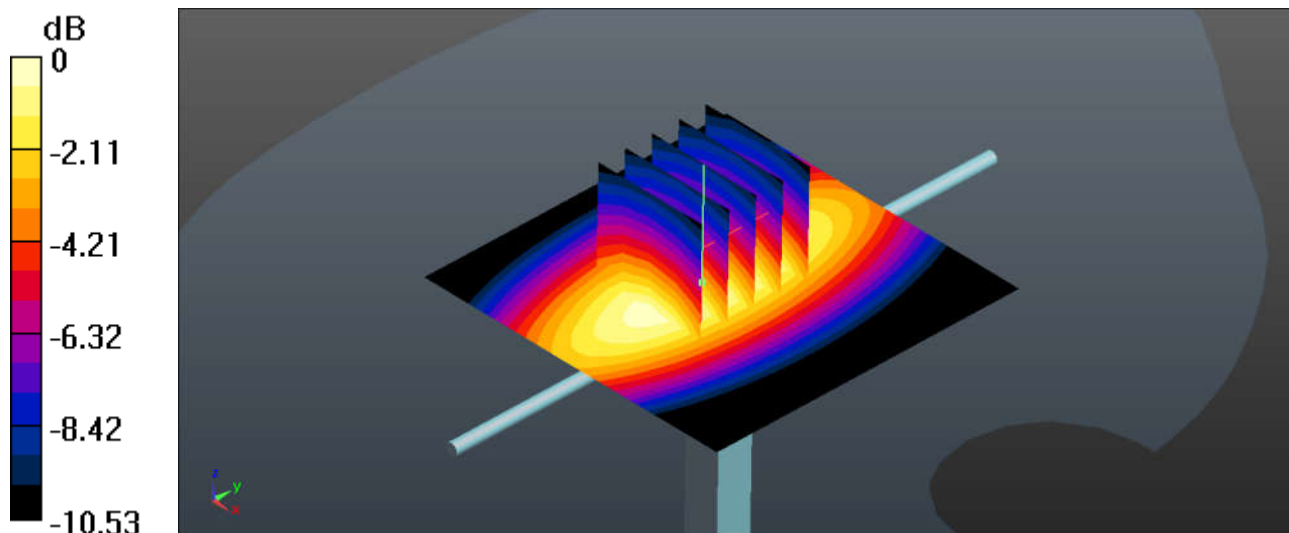

0 dB = 3.08 W/kg

## System Check\_Head\_1750MHz

**DUT: D1750V2-SN:1137**

Communication System: UID 0, CW; Frequency: 1750 MHz; Duty Cycle: 1:1

Medium: HSL\_1750\_200901 Medium parameters used:  $f = 1750$  MHz;  $\sigma = 1.373$  S/m;  $\epsilon_r = 41.392$ ;

$\rho = 1000$  kg/m<sup>3</sup>

Ambient Temperature : 23.5 °C; Liquid Temperature : 22.4 °C

DASY5 Configuration:

- Probe: EX3DV4 - SN3826; ConvF(7.98, 7.98, 7.98); Calibrated: 2020.05.20;
- Sensor-Surface: 2mm (Mechanical Surface Detection)
- Electronics: DAE4 Sn1210; Calibrated: 2020.07.27
- Phantom: SAM2; Type: QD000P40CD; Serial: TP:1671
- Measurement SW: DASY52, Version 52.8 (8); SEMCAD X Version 14.6.10 (7331)

**Pin=250mW/Area Scan (61x61x1):** Interpolated grid: dx=1.500 mm, dy=1.500 mm

Maximum value of SAR (interpolated) = 13.2 W/kg

**Pin=250mW/Zoom Scan (5x5x7)/Cube 0:** Measurement grid: dx=8mm, dy=8mm, dz=5mm

Reference Value = 92.43 V/m; Power Drift = -0.12 dB

Peak SAR (extrapolated) = 16.9 W/kg

**SAR(1 g) = 9.39 W/kg; SAR(10 g) = 4.99 W/kg**

Maximum value of SAR (measured) = 13.3 W/kg

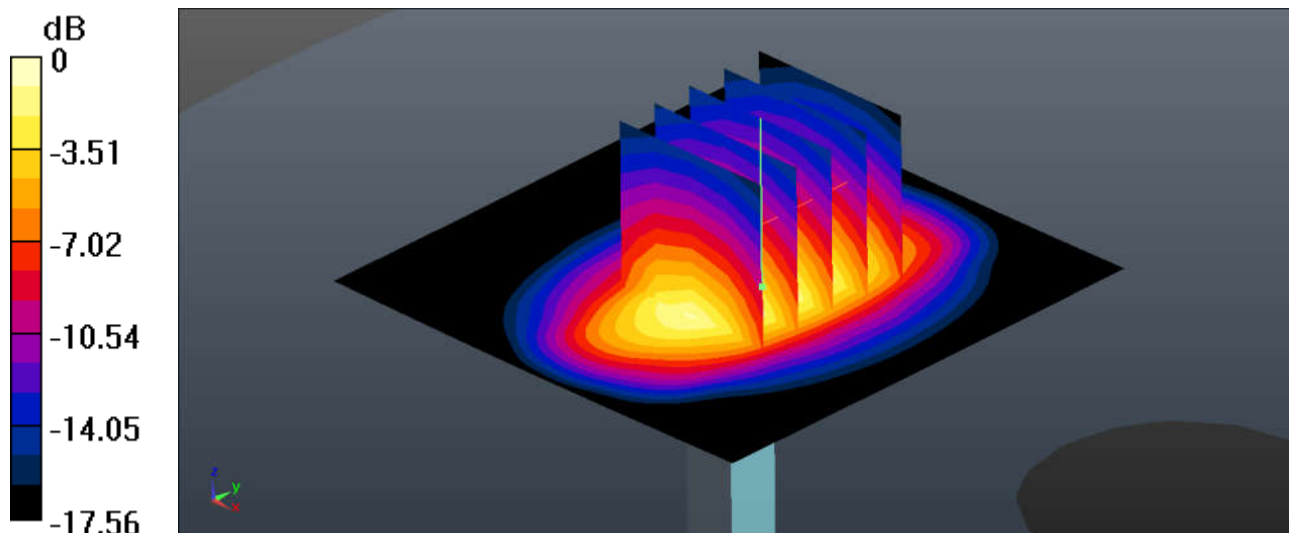

0 dB = 13.2 W/kg

### System Check\_Head\_1750MHz

**DUT: D1750V2-SN:1137**

Communication System: UID 0, CW; Frequency: 1750 MHz; Duty Cycle: 1:1

Medium: HSL\_1750\_200918 Medium parameters used:  $f = 1750$  MHz;  $\sigma = 1.406$  S/m;  $\epsilon_r = 41.525$ ;  $\rho = 1000$  kg/m<sup>3</sup>

Ambient Temperature : 23.6 °C; Liquid Temperature : 22.4 °C

DASY5 Configuration:

- Probe: EX3DV4 - SN7576; ConvF(8.88, 8.88, 8.88); Calibrated: 2020.01.22;
- Sensor-Surface: 2mm (Mechanical Surface Detection)
- Electronics: DAE3 Sn528; Calibrated: 2020.03.16
- Phantom: SAM (Front) with CRP v5.0; Type: QD000P40CD; Serial: TP:1795
- Measurement SW: DASY52, Version 52.8 (8); SEMCAD X Version 14.6.10 (7331)

**Pin=250mW/Area Scan (61x61x1):** Interpolated grid: dx=1.500 mm, dy=1.500 mm

Maximum value of SAR (interpolated) = 13.5 W/kg

**Pin=250mW/Zoom Scan (5x5x7)/Cube 0:** Measurement grid: dx=8mm, dy=8mm, dz=5mm

Reference Value = 96.69 V/m; Power Drift = 0.14 dB

Peak SAR (extrapolated) = 17.0 W/kg

**SAR(1 g) = 9.52 W/kg; SAR(10 g) = 5.1 W/kg**

Maximum value of SAR (measured) = 13.3 W/kg

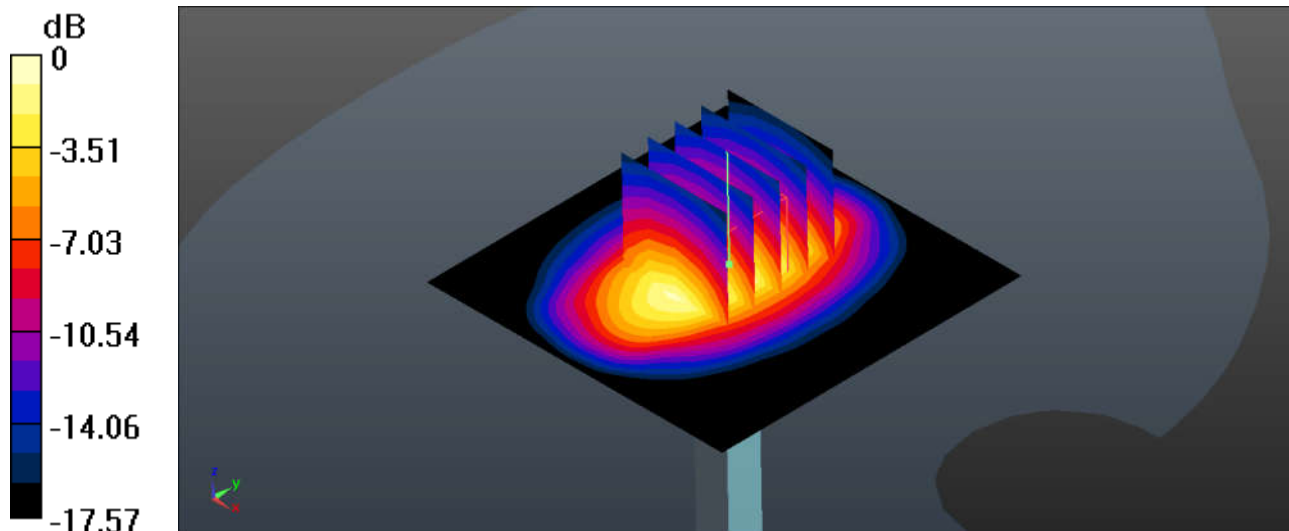

0 dB = 13.5 W/kg

## System Check\_Head\_1900MHz

**DUT: D1900V2-SN:5d182**

Communication System: UID 0, CW; Frequency: 1900 MHz; Duty Cycle: 1:1

Medium: HSL\_1900\_200831 Medium parameters used:  $f = 1900$  MHz;  $\sigma = 1.455$  S/m;  $\epsilon_r = 40.068$ ;  $\rho = 1000$  kg/m<sup>3</sup>

Ambient Temperature : 23.4 °C; Liquid Temperature : 22.6 °C

DASY5 Configuration:

- Probe: EX3DV4 - SN3826; ConvF(7.67, 7.67, 7.67); Calibrated: 2020.05.20;
- Sensor-Surface: 2mm (Mechanical Surface Detection)
- Electronics: DAE4 Sn1210; Calibrated: 2020.07.27
- Phantom: SAM2; Type: QD000P40CD; Serial: TP:1671
- Measurement SW: DASY52, Version 52.8 (8); SEMCAD X Version 14.6.10 (7331)

**Pin=250mW/Area Scan (61x61x1):** Interpolated grid: dx=1.500 mm, dy=1.500 mm

Maximum value of SAR (interpolated) = 15.2 W/kg

**Pin=250mW/Zoom Scan (5x5x7)/Cube 0:** Measurement grid: dx=8mm, dy=8mm, dz=5mm

Reference Value = 101.4 V/m; Power Drift = 0.18 dB

Peak SAR (extrapolated) = 19.7 W/kg

**SAR(1 g) = 10.5 W/kg; SAR(10 g) = 5.34 W/kg**

Maximum value of SAR (measured) = 15.1 W/kg

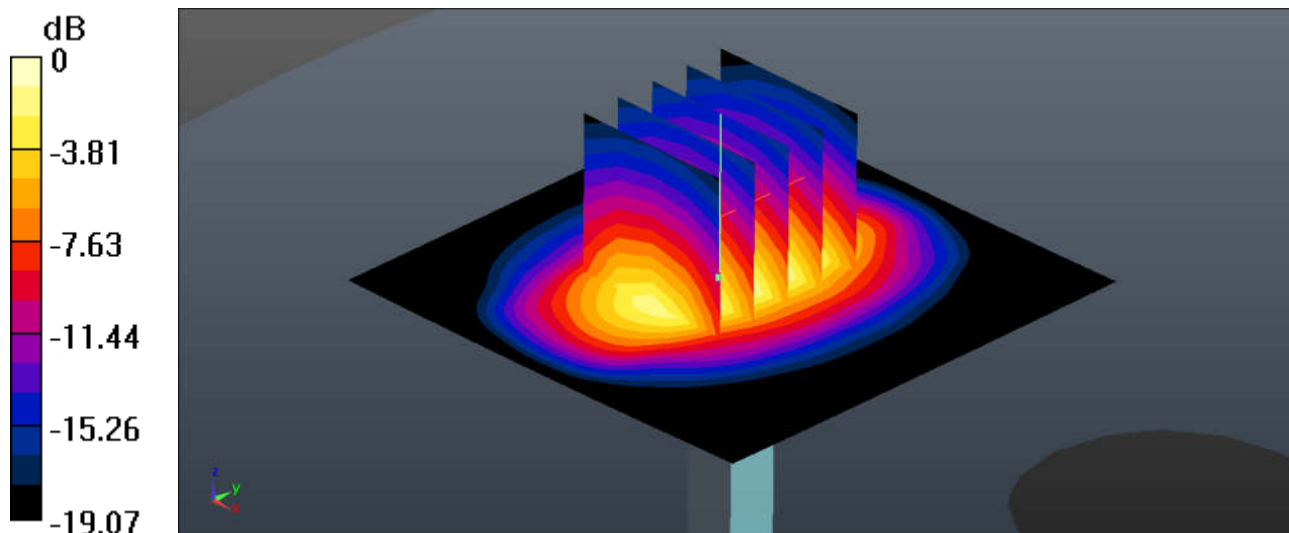

0 dB = 15.2 W/kg

### System Check\_Head\_1900MHz

**DUT: D1900V2-SN:5d182**

Communication System: UID 0, CW; Frequency: 1900 MHz; Duty Cycle: 1:1

Medium: HSL\_1900\_200921 Medium parameters used:  $f = 1900$  MHz;  $\sigma = 1.439$  S/m;  $\epsilon_r = 40.038$ ;  $\rho = 1000$  kg/m<sup>3</sup>

Ambient Temperature : 23.5 °C; Liquid Temperature : 22.6 °C

DASY5 Configuration:

- Probe: EX3DV4 - SN7576; ConvF(8.58, 8.58, 8.58); Calibrated: 2020.01.22;
- Sensor-Surface: 2mm (Mechanical Surface Detection)
- Electronics: DAE3 Sn528; Calibrated: 2020.03.16
- Phantom: SAM (Front) with CRP v5.0; Type: QD000P40CD; Serial: TP:1795
- Measurement SW: DASY52, Version 52.8 (8); SEMCAD X Version 14.6.10 (7331)

**Pin=250mW/Area Scan (61x61x1):** Interpolated grid: dx=1.500 mm, dy=1.500 mm

Maximum value of SAR (interpolated) = 15.6 W/kg

**Pin=250mW/Zoom Scan (5x5x7)/Cube 0:** Measurement grid: dx=8mm, dy=8mm, dz=5mm

Reference Value = 95.08 V/m; Power Drift = 0.19 dB

Peak SAR (extrapolated) = 19.3 W/kg

**SAR(1 g) = 10.2 W/kg; SAR(10 g) = 5.26 W/kg**

Maximum value of SAR (measured) = 14.8 W/kg

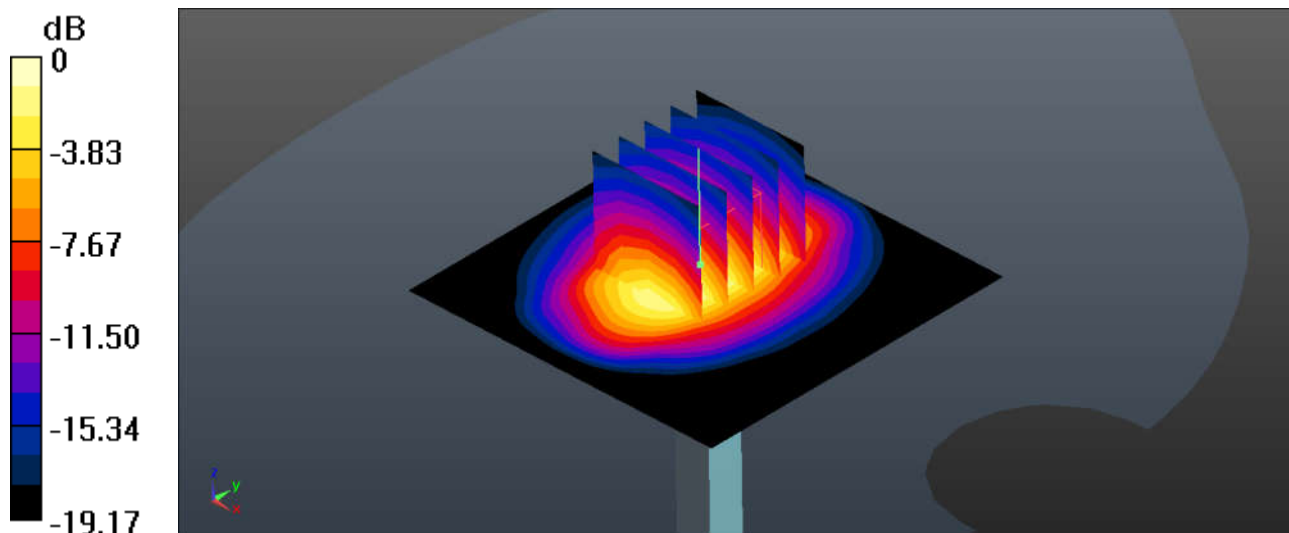

0 dB = 15.6 W/kg

### System Check\_Head\_2300MHz

**DUT: D2300V2-SN:1056**

Communication System: UID 0, CW (0); Frequency: 2300 MHz;Duty Cycle: 1:1  
Medium: HSL\_2300\_200904 Medium parameters used:  $f = 2300$  MHz;  $\sigma = 1.664$  S/m;  $\epsilon_r = 38.851$ ;  $\rho = 1000$  kg/m<sup>3</sup>  
Ambient Temperature : 23.6 °C; Liquid Temperature : 22.5 °C

DASY5 Configuration:

- Probe: EX3DV4 - SN3826; ConvF(7.35, 7.35, 7.35); Calibrated: 2020.05.20;
- Sensor-Surface: 2mm (Mechanical Surface Detection)
- Electronics: DAE4 Sn1210; Calibrated: 2020.07.27
- Phantom: SAM2; Type: QD000P40CD; Serial: TP:1671
- Measurement SW: DASY52, Version 52.8 (8); SEMCAD X Version 14.6.10 (7331)

**Pin=250mW/Area Scan (81x81x1):** Interpolated grid: dx=1.200 mm, dy=1.200 mm  
Maximum value of SAR (interpolated) = 18.1 W/kg

**Pin=250mW/Zoom Scan (7x7x7)/Cube 0:** Measurement grid: dx=5mm, dy=5mm, dz=5mm  
Reference Value = 100.1 V/m; Power Drift = 0.12 dB  
Peak SAR (extrapolated) = 25.0 W/kg  
**SAR(1 g) = 11.8 W/kg; SAR(10 g) = 5.52 W/kg**  
Maximum value of SAR (measured) = 18.3 W/kg

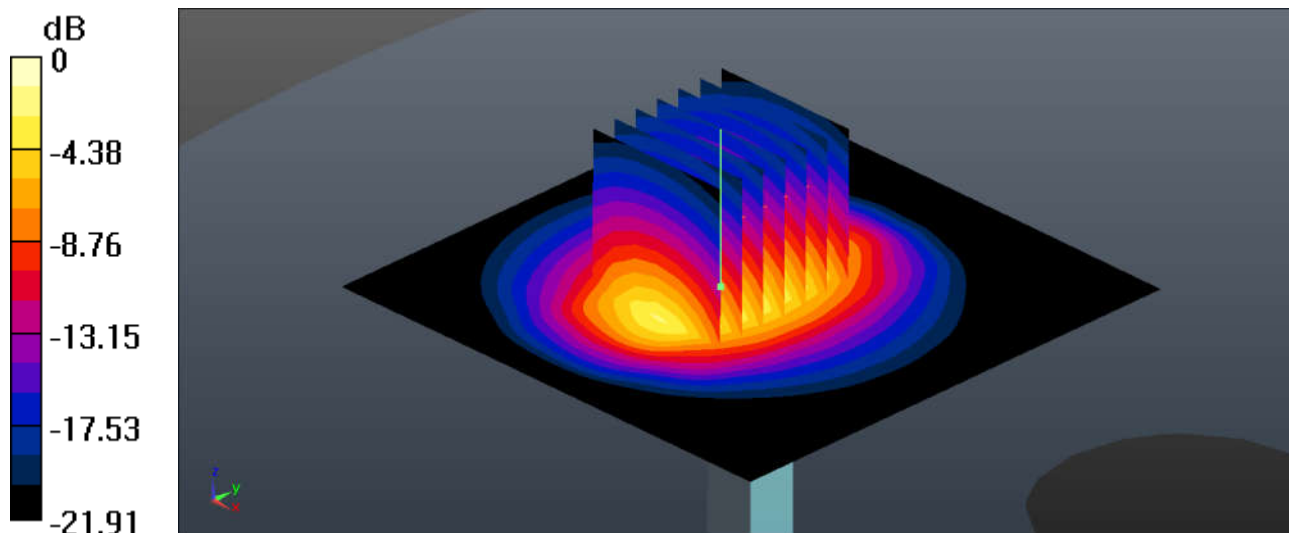

0 dB = 18.1 W/kg



## System Check\_Head\_2450MHz

**DUT: D2450V2-SN:924**

Communication System: UID 0, CW; Frequency: 2450 MHz; Duty Cycle: 1:1

Medium: HSL\_2450\_200914 Medium parameters used:  $f = 2450$  MHz;  $\sigma = 1.82$  S/m;  $\epsilon_r = 39.753$ ;  $\rho = 1000$  kg/m<sup>3</sup>

Ambient Temperature : 23.7 °C; Liquid Temperature : 22.4 °C

DASY5 Configuration:

- Probe: EX3DV4 - SN3826; ConvF(7.12, 7.12, 7.12); Calibrated: 2020.05.20;
- Sensor-Surface: 2mm (Mechanical Surface Detection)
- Electronics: DAE4 Sn1210; Calibrated: 2020.07.27
- Phantom: SAM2; Type: QD000P40CD; Serial: TP:1671
- Measurement SW: DASY52, Version 52.8 (8); SEMCAD X Version 14.6.10 (7331)

**Pin=250mW/Area Scan (81x81x1):** Interpolated grid: dx=1.200 mm, dy=1.200 mm

Maximum value of SAR (interpolated) = 21.0 W/kg

**Pin=250mW/Zoom Scan (7x7x7)/Cube 0:** Measurement grid: dx=5mm, dy=5mm, dz=5mm

Reference Value = 71.21 V/m; Power Drift = 0.11 dB

Peak SAR (extrapolated) = 29.4 W/kg

**SAR(1 g) = 13.2 W/kg; SAR(10 g) = 5.84 W/kg**

Maximum value of SAR (measured) = 20.8 W/kg

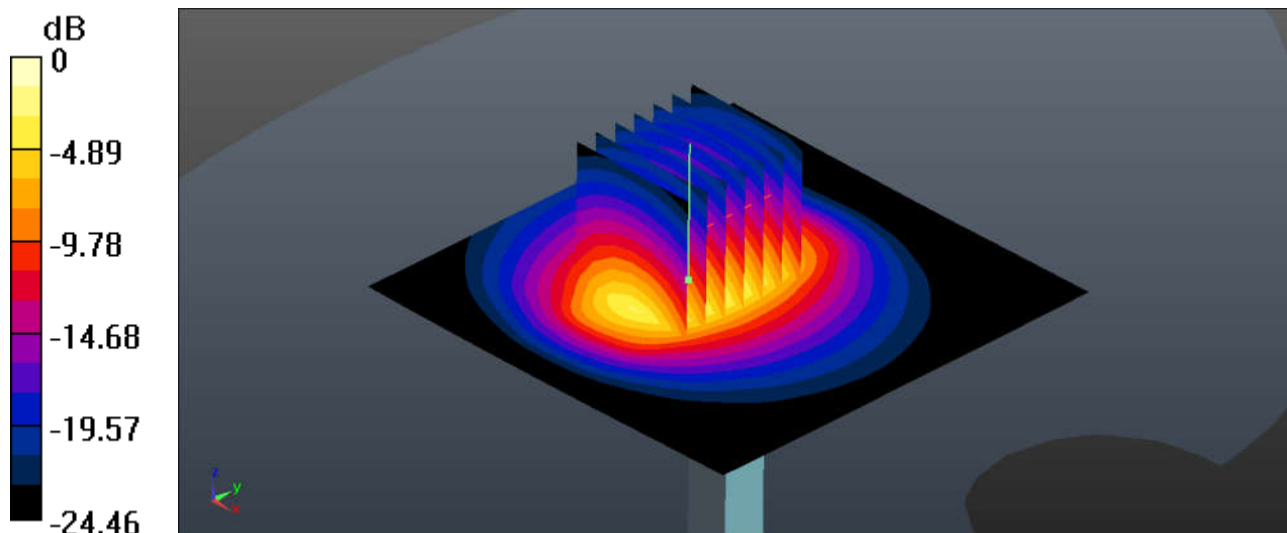

0 dB = 21.0 W/kg

## System Check\_Head\_2600MHz

**DUT: D2600V2-SN:1070**

Communication System: UID 0, CW (0); Frequency: 2600 MHz; Duty Cycle: 1:1

Medium: HSL\_2600\_200903 Medium parameters used:  $f = 2600$  MHz;  $\sigma = 2.05$  S/m;  $\epsilon_r = 38.344$ ;  $\rho = 1000$  kg/m<sup>3</sup>

Ambient Temperature : 23.4 °C; Liquid Temperature : 22.8 °C

DASY5 Configuration:

- Probe: EX3DV4 - SN3826; ConvF(6.94, 6.94, 6.94); Calibrated: 2020.05.20;
- Sensor-Surface: 2mm (Mechanical Surface Detection)
- Electronics: DAE4 Sn1210; Calibrated: 2020.07.27
- Phantom: SAM2; Type: QD000P40CD; Serial: TP:1671
- Measurement SW: DASY52, Version 52.8 (8); SEMCAD X Version 14.6.10 (7331)

**Pin=250mW/Area Scan (81x81x1):** Interpolated grid: dx=1.200 mm, dy=1.200 mm

Maximum value of SAR (interpolated) = 28.3 W/kg

**Pin=250mW/Zoom Scan (7x7x7)/Cube 0:** Measurement grid: dx=5mm, dy=5mm, dz=5mm

Reference Value = 90.62 V/m; Power Drift = 0.11 dB

Peak SAR (extrapolated) = 40.2 W/kg

**SAR(1 g) = 14.2 W/kg; SAR(10 g) = 6.01W/kg**

Maximum value of SAR (measured) = 28.4 W/kg

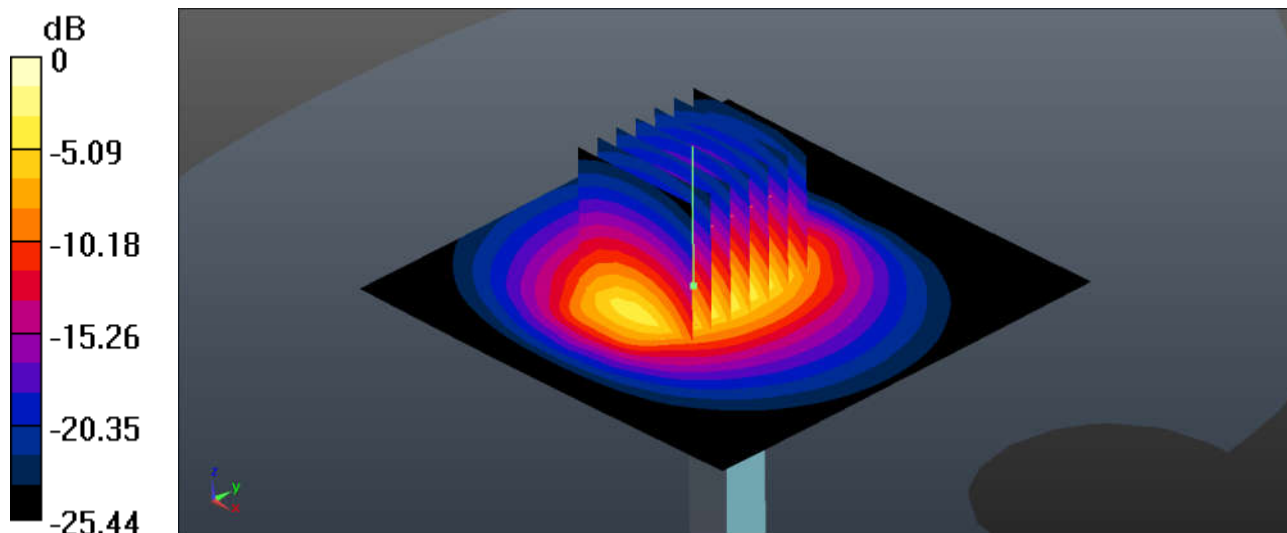

0 dB = 28.3 W/kg

### System Check\_Head\_2600MHz

**DUT: D2600V2-SN:1070**

Communication System: UID 0, CW (0); Frequency: 2600 MHz;Duty Cycle: 1:1  
Medium: HSL\_2600\_200919 Medium parameters used:  $f = 2600$  MHz;  $\sigma = 2.056$  S/m;  $\epsilon_r = 37.284$ ;  $\rho = 1000$  kg/m<sup>3</sup>  
Ambient Temperature : 23.7 °C; Liquid Temperature : 22.4 °C

#### DASY5 Configuration:

- Probe: EX3DV4 - SN7576; ConvF(7.47, 7.47, 7.47); Calibrated: 2020.01.22;
- Sensor-Surface: 2mm (Mechanical Surface Detection)
- Electronics: DAE3 Sn528; Calibrated: 2020.03.16
- Phantom: SAM (Front) with CRP v5.0; Type: QD000P40CD; Serial: TP:1795
- Measurement SW: DASY52, Version 52.8 (8); SEMCAD X Version 14.6.10 (7331)

**Pin=250mW/Area Scan (71x71x1):** Interpolated grid: dx=1.200 mm, dy=1.200 mm  
Maximum value of SAR (interpolated) = 25.6 W/kg

**Pin=250mW/Zoom Scan (7x7x7)/Cube 0:** Measurement grid: dx=5mm, dy=5mm, dz=5mm  
Reference Value = 95.17 V/m; Power Drift = 0.14 dB  
Peak SAR (extrapolated) = 34.9 W/kg  
**SAR(1 g) = 15.4 W/kg; SAR(10 g) = 6.7 W/kg**  
Maximum value of SAR (measured) = 24.8 W/kg

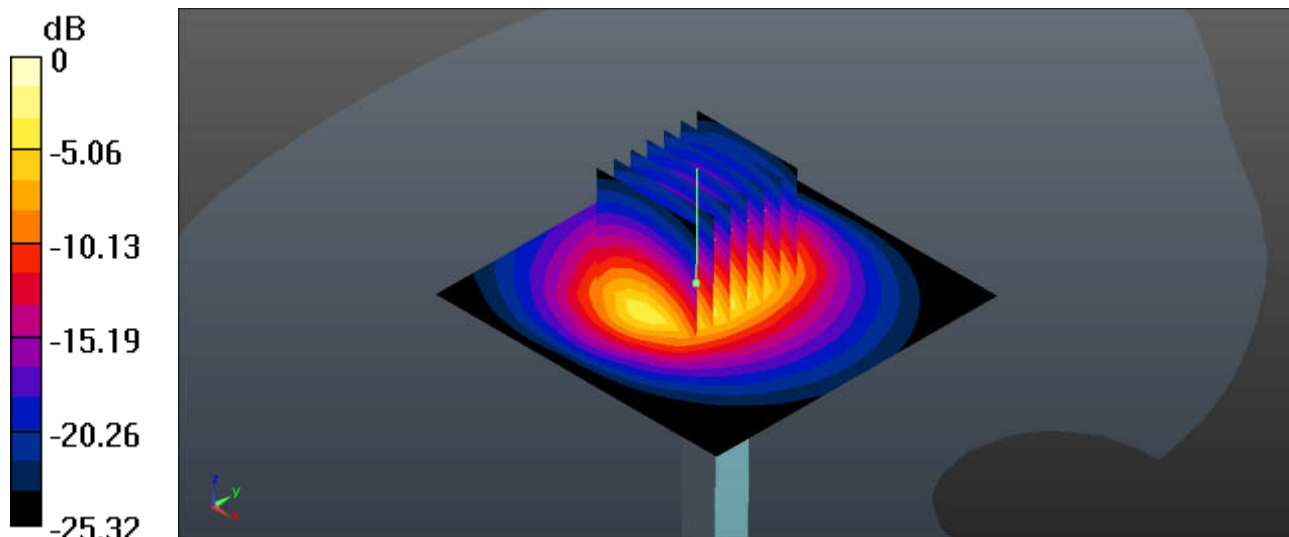

0 dB = 25.6 W/kg

## System Check\_Head\_5250MHz

**DUT: D5GHzV2-SN:1167**

Communication System: UID 0, CW (0); Frequency: 5250 MHz; Duty Cycle: 1:1

Medium: HSL\_5250\_200908 Medium parameters used:  $f = 5250$  MHz;  $\sigma = 4.597$  S/m;  $\epsilon_r = 36.241$ ;  $\rho = 1000$  kg/m<sup>3</sup>

Ambient Temperature : 23.5 °C; Liquid Temperature : 22.5 °C

DASY5 Configuration:

- Probe: EX3DV4 - SN3826; ConvF(5.09, 5.09, 5.09); Calibrated: 2020.05.20;
- Sensor-Surface: 1.4mm (Mechanical Surface Detection)
- Electronics: DAE4 Sn1210; Calibrated: 2020.07.27
- Phantom: SAM2; Type: QD000P40CD; Serial: TP:1671
- Measurement SW: DASY52, Version 52.8 (8); SEMCAD X Version 14.6.10 (7331)

**Pin=100mW/Area Scan (71x71x1):** Interpolated grid: dx=1.000 mm, dy=1.000 mm

Maximum value of SAR (interpolated) = 18.5 W/kg

**Pin=100mW/Zoom Scan (7x7x7)/Cube 0:** Measurement grid: dx=4mm, dy=4mm, dz=1.4mm

Reference Value = 44.13 V/m; Power Drift = 0.01 dB

Peak SAR (extrapolated) = 30.6 W/kg

**SAR(1 g) = 7.42 W/kg; SAR(10 g) = 2.04 W/kg**

Maximum value of SAR (measured) = 18.3 W/kg

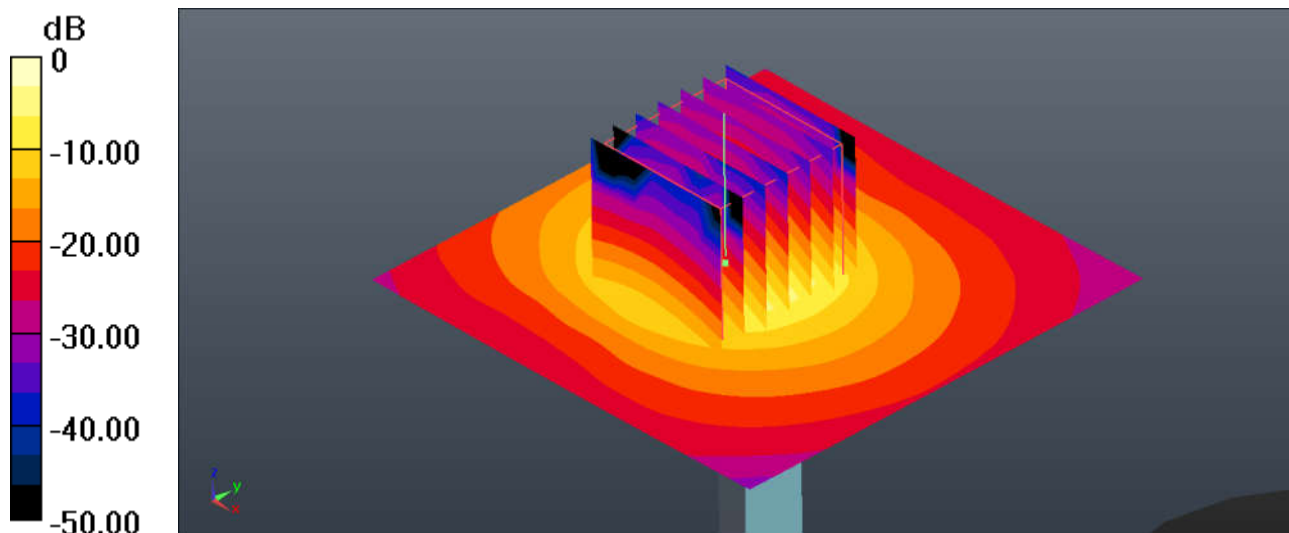

0 dB = 18.5 W/kg

## System Check\_Head\_5250MHz

**DUT: D5GHzV2-SN:1167**

Communication System: UID 0, CW (0); Frequency: 5250 MHz; Duty Cycle: 1:1

Medium: HSL\_5250\_200922 Medium parameters used:  $f = 5250$  MHz;  $\sigma = 4.757$  S/m;  $\epsilon_r = 36.931$ ;  $\rho = 1000$  kg/m<sup>3</sup>

Ambient Temperature : 23.4 °C; Liquid Temperature : 22.4 °C

DASY5 Configuration:

- Probe: EX3DV4 - SN7576; ConvF(5.2, 5.2, 5.2); Calibrated: 2020.01.22;
- Sensor-Surface: 1.4mm (Mechanical Surface Detection)
- Electronics: DAE3 Sn528; Calibrated: 2020.03.16
- Phantom: SAM (Front) with CRP v5.0; Type: QD000P40CD; Serial: TP:1795
- Measurement SW: DASY52, Version 52.8 (8); SEMCAD X Version 14.6.10 (7331)

**Pin=100mW/Area Scan (71x71x1):** Interpolated grid: dx=1.000 mm, dy=1.000 mm

Maximum value of SAR (interpolated) = 5.14 W/kg

**Pin=100mW/Zoom Scan (8x8x7)/Cube 0:** Measurement grid: dx=4mm, dy=4mm, dz=1.4mm

Reference Value = 25.28 V/m; Power Drift = 0.12 dB

Peak SAR (extrapolated) = 8.30 W/kg

**SAR(1 g) = 7.5 W/kg; SAR(10 g) = 2.3 W/kg**

Maximum value of SAR (measured) = 5.17 W/kg

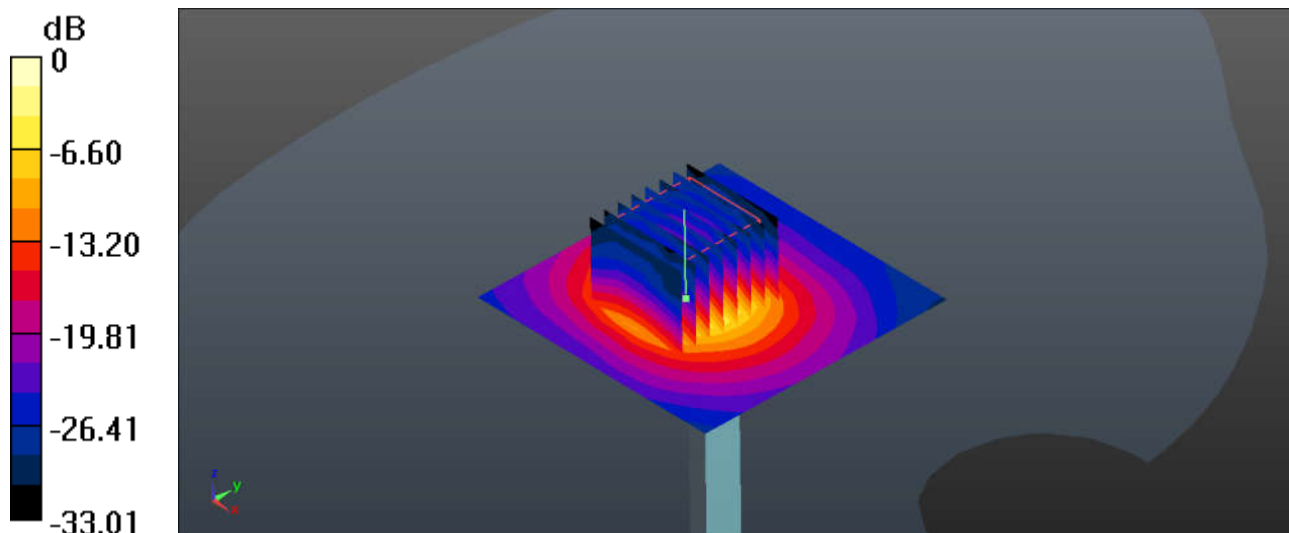

0 dB = 5.14 W/kg