



FCC RF Test Report

APPLICANT : Motorola Mobility LLC
EQUIPMENT : Mobile Cellular Phone
BRAND NAME : Motorola
MODEL NAME : XT2113-1, XT2113-1PP
FCC ID : IHDT56ZF3
STANDARD : 47 CFR Part 2, 22(H), 27(F), 27(H), 27(M)
CLASSIFICATION : PCS Licensed Transmitter Held to Ear (PCE)

The product was received on Mar. 08, 2021 and completely tested on Apr. 22, 2021. We, Sporton International (Kunshan) Inc., would like to declare that the tested sample has been evaluated in accordance with the procedures given in ANSI C63.26-2015 and shown compliance with the applicable technical standards.

The test results in this report apply exclusively to the tested model / sample. Without written approval of Sporton International (Kunshan) Inc., the test report shall not be reproduced except in full.

Reviewed by: Jason Jia / Supervisor

Approved by: Alex Wang / Manager



Sporton International (Kunshan) Inc.

No. 1098, Pengxi North Road, Kunshan Economic Development Zone Jiangsu Province 215300
People's Republic of China



TABLE OF CONTENTS

REVISION HISTORY... 3
SUMMARY OF TEST RESULT ... 4
1 GENERAL DESCRIPTION ... 5
1.1 Applicant ... 5
1.2 Manufacturer ... 5
1.3 Product Feature of Equipment Under Test ... 5
1.4 Product Specification of Equipment Under Test ... 6
1.5 Modification of EUT ... 6
1.6 Maximum ERP/EIRP, Frequency Tolerance, and Emission Designator ... 7
1.7 Testing Location ... 8
1.8 Test Software ... 8
1.9 Applicable Standards ... 8
2 TEST CONFIGURATION OF EQUIPMENT UNDER TEST ... 9
2.1 Test Mode ... 9
2.2 Connection Diagram of Test System ... 11
2.3 Support Unit used in test configuration and system ... 11
2.4 Measurement Results Explanation Example ... 11
2.5 Frequency List of Low/Middle/High Channels ... 12
3 CONDUCTED TEST ITEMS ... 15
3.1 Measuring Instruments ... 15
3.2 Test Setup ... 15
3.3 Test Result of Conducted Test ... 15
3.4 Conducted Output Power and ERP/EIRP ... 16
3.5 Peak-to-Average Ratio ... 17
3.6 Occupied Bandwidth ... 18
3.7 Conducted Band Edge ... 19
3.8 Conducted Spurious Emission ... 21
3.9 Frequency Stability ... 22
4 RADIATED TEST ITEMS ... 23
4.1 Measuring Instruments ... 23
4.2 Test Setup ... 23
4.3 Test Result of Radiated Test ... 23
4.4 Radiated Spurious Emission ... 24
5 LIST OF MEASURING EQUIPMENT ... 25
6 UNCERTAINTY OF EVALUATION ... 26
APPENDIX A. TEST RESULTS OF CONDUCTED TEST
APPENDIX B. TEST RESULTS OF RADIATED TEST
APPENDIX C. TEST SETUP PHOTOGRAPHS



REVISION HISTORY

REPORT NO.	VERSION	DESCRIPTION	ISSUED DATE
FG082402-06C	Rev. 01	Initial issue of report	Apr. 22, 2021



SUMMARY OF TEST RESULT

Report Section	FCC Rule	Description	Limit	Result	Remark
3.4	§2.1046	Conducted Output Power	Reporting Only	PASS	-
	§22.913(a)(5)	Effective Radiated Power (Band 5)	ERP < 7 Watt	PASS	
	§27.50(b)(10) §27.50(c)(10)	Effective Radiated Power (Band 12) (Band 13) (Band 17)	ERP < 3 Watt	PASS	
	§27.50(h)(2)	Equivalent Isotropic Radiated Power (Band 7)	EIRP < 2Watt	PASS	
3.6	§2.1049	Occupied Bandwidth	Reporting Only	PASS	-
3.7	§2.1051 §22.917(a) §27.53(c)(2)(4) §27.53(g)	Conducted Band Edge Measurement (Band 5) (Band 12) (Band 13) (Band 17)	< 43+10log ₁₀ (P[Watts])	PASS	-
	§27.53(m)(4)	Conducted Band Edge Measurement (Band 7)	§27.53(m)(4)		
3.8	§2.1051 §22.917(a) §27.53(c)(2) §27.53(g)	Conducted Spurious Emission (Band 5) (Band 12) (Band 13) (Band 17)	< 43+10log ₁₀ (P[Watts])	PASS	-
	§2.1051 §27.53(m)(4)	Conducted Spurious Emission (Band 7)	< 55+10log ₁₀ (P[Watts])		
3.9	§2.1055 §22.355	Frequency Stability Temperature & Voltage	< 2.5 ppm for Part 22	PASS	-
	§2.1055 §27.54		Within Authorized Band		
4.4	§2.1053 §22.917(a) §27.53(c)(2) §27.53(f) §27.53(g)	Radiated Spurious Emission (Band 5) (Band 12) (Band 13) (Band 17)	< 43+10log ₁₀ (P[Watts])	PASS	Under limit 17.86 dB at 5052.000 MHz
	§2.1053 §27.53(m)(4)	Radiated Spurious Emission (Band 7)	< 55+10log ₁₀ (P[Watts])		

Declaration of Conformity:

The test results with all measurement uncertainty excluded are presented in accordance with the regulation limits or requirements declared by manufacturers.

Comments and Explanations:

The declared of product specification for EUT presented in the report are provided by the manufacturer, and the manufacturer takes all the responsibilities for the accuracy of product specification.



1 General Description

1.1 Applicant

Motorola Mobility LLC
222 W,Merchandise Mart Plaza,Chicago,IL60654 USA

1.2 Manufacturer

Motorola Mobility LLC
222 W,Merchandise Mart Plaza,Chicago,IL60654 USA

1.3 Product Feature of Equipment Under Test

Product Feature	
Equipment	Mobile Cellular Phone
Brand Name	Motorola
Model Name	XT2113-1, XT2113-1PP
FCC ID	IHDT56ZF3
EUT supports Radios application	GSM/WCDMA/LTE/5G NR/NFC WLAN 2.4GHz 802.11b/g/n HT20 WLAN 5GHz 802.11a/n HT20/HT40 WLAN 5GHz 802.11ac VHT20/VHT40/VHT80 Bluetooth BR/EDR/LE FM Receiver and GNSS
IMEI Code	Conducted: N/A Radiation: 868869050005346/868869050005378
HW Version	DVT2
SW Version	RRV31.Q2-20
EUT Stage	Identical Prototype



1.4 Product Specification of Equipment Under Test

Standards-related Product Specification	
Tx Frequency	LTE Band 5 : 824 MHz ~ 849 MHz LTE Band 7 : 2500 MHz ~ 2570 MHz LTE Band 12 : 699 MHz ~ 716 MHz LTE Band 13 : 777 MHz ~ 787 MHz LTE Band 17 : 704 MHz ~ 716 MHz
Rx Frequency	LTE Band 5 : 869 MHz ~ 894 MHz LTE Band 7 : 2620 MHz ~ 2690 MHz LTE Band 12 : 729 MHz ~ 746 MHz LTE Band 13 : 746 MHz ~ 756 MHz LTE Band 17 : 734 MHz ~ 746 MHz
Bandwidth	LTE Band 5 : 1.4MHz / 3MHz / 5MHz / 10MHz LTE Band 7 : 5MHz / 10MHz / 15MHz / 20MHz LTE Band 12 : 1.4MHz / 3MHz / 5MHz / 10MHz LTE Band 13 : 5MHz / 10MHz LTE Band 17 : 5MHz / 10MHz
Maximum Output Power to Antenna	Ant 1: LTE Band 5 : 22.90 dBm; Band 5B_CA: 22.78 dBm LTE Band 7 : 23.63 dBm LTE Band 12 : 23.19 dBm LTE Band 13 : 23.28 dBm LTE Band 17 : 23.18 dBm Ant 2: LTE Band 5 : 22.36 dBm; Band 5B_CA: 22.23 dBm LTE Band 12 : 22.75 dBm LTE Band 13 : 22.99 dBm LTE Band 17 : 22.74 dBm
Antenna Gain	Ant 1&2: LTE Band 5 : -2.6 dBi LTE Band 7 : -1.8 dBi LTE Band 12 : -1.5 dBi LTE Band 13 : -4.0 dBi LTE Band 17 : -1.5 dBi
Type of Modulation	QPSK / 16QAM / 64QAM

Note: The Maximum ERP/EIRP is calculated from Max Output power and Max antenna gain, only the maximum ERP/EIRP is shown on the report

1.5 Modification of EUT

No modifications are made to the EUT during all test items.



1.6 Maximum ERP/EIRP, Frequency Tolerance, and Emission Designator

LTE Band 5		QPSK			16QAM		
BW (MHz)	Frequency Range (MHz)	Emission Designator (99%OBW)	Frequency Tolerance (ppm)	Maximum ERP(W)	Emission Designator (99%OBW)	Frequency Tolerance (ppm)	Maximum ERP(W)
10	829.0 ~ 844.0	9M01G7D	0.0046	0.0653	9M05W7D	-	0.0531
LTE Band 7		QPSK			16QAM		
BW (MHz)	Frequency Range (MHz)	Emission Designator (99%OBW)	Frequency Tolerance (ppm)	Maximum EIRP(W)	Emission Designator (99%OBW)	Frequency Tolerance (ppm)	Maximum EIRP(W)
20	2510.0 ~ 2560.0	17M9G7D	0.0036	0.1524	17M9W7D	-	0.1239
LTE Band 12		QPSK			16QAM		
BW (MHz)	Frequency Range (MHz)	Emission Designator (99%OBW)	Frequency Tolerance (ppm)	Maximum ERP(W)	Emission Designator (99%OBW)	Frequency Tolerance (ppm)	Maximum ERP(W)
10	704.0 ~ 711.0	8M97G7D	0.0108	0.0899	8M97W7D	-	0.0711
LTE Band 13		QPSK			16QAM		
BW (MHz)	Frequency Range (MHz)	Emission Designator (99%OBW)	Frequency Tolerance (ppm)	Maximum ERP(W)	Emission Designator (99%OBW)	Frequency Tolerance (ppm)	Maximum ERP(W)
10	782.0	8M97G7D	0.0102	0.0516	8M97W7D	-	0.0416
LTE Band 17		QPSK			16QAM		
BW (MHz)	Frequency Range (MHz)	Emission Designator (99%OBW)	Frequency Tolerance (ppm)	Maximum ERP(W)	Emission Designator (99%OBW)	Frequency Tolerance (ppm)	Maximum ERP(W)
10	709.0 ~ 711.0	8M97G7D	0.0108	0.0897	8M97W7D	-	0.0724

LTE Band 5B_CA		QPSK			16QAM		
BW (MHz)		Emission Designator (99%OBW)	Frequency Tolerance (ppm)	Maximum ERP(W)	Emission Designator (99%OBW)	Frequency Tolerance (ppm)	Maximum ERP(W)
10MHz+10MHz		19M4G7D	0.0016	0.0635	18M9W7D	-	0.0480

Note: LTE Band 12 overlaps the entire frequency range of LTE Band 17. Therefore, the test results provided in this report covers Band 12 as well as Band 17.



1.7 Testing Location

Sporton International (Kunshan) Inc. is accredited to ISO/IEC 17025:2017 by American Association for Laboratory Accreditation with Certificate Number 5145.02.

Test Firm	Sporton International (Kunshan) Inc.		
Test Site Location	No. 1098, Pengxi North Road, Kunshan Economic Development Zone Jiangsu Province 215300 People's Republic of China TEL : +86-512-57900158 FAX : +86-512-57900958		
Test Site No.	Sporton Site No.	FCC Designation No.	FCC Test Firm Registration No.
	03CH04-KS TH01-KS	CN1257	314309

1.8 Test Software

Item	Site	Manufacturer	Name	Version
1.	03CH04-KS	AUDIX	E3	6.2009-8-24a

1.9 Applicable Standards

According to the specifications of the manufacturer, the EUT must comply with the requirements of the following standards:

- ♦ 47 CFR Part 2, 22(H), 27(F), 27(H), 27(M)
- ♦ ANSI C63.26-2015
- ♦ FCC KDB 971168 D01 Power Meas License Digital Systems v03r01
- ♦ FCC KDB 412172 D01 Determining ERP and EIRP v01r01

Remark:

1. All test items were verified and recorded according to the standards and without any deviation during the test.
2. This EUT has also been tested and complied with the requirements of FCC Part 15, Subpart B, recorded in a separate test report.



2 Test Configuration of Equipment Under Test

2.1 Test Mode

Antenna port conducted and radiated test items listed below are performed according to KDB 971168 D01 Power Meas License Digital Systems v03r01 with maximum output power.

Radiated measurements are performed by rotating the EUT in three different orthogonal test planes to find the maximum emission.

Test Items	Band	Bandwidth (MHz)						Modulation			RB #			Test Channel			
		1.4	3	5	10	15	20	QPSK	16QAM	64QAM	1	Half	Full	L	M	H	
Max. Output Power	5	v	v	v	v	-	-	v	v	v	v	v	v	v	v	v	
	7	-	-	v	v	v	v	v	v	v	v	v	v	v	v	v	
	12	v	v	v	v	-	-	v	v	v	v	v	v	v	v	v	
	13	-	-	v	v	-	-	v	v	v	v	v	v	v	v	v	
	17	-	-	v	v	-	-	v	v	v	v	v	v	v	v	v	
Peak-to-Average Ratio	5				v	-	-	v	v	v	v		v		v		
	7	-	-				v	v	v	v	v		v		v		
	12				v	-	-	v	v	v	v		v		v		
	13	-	-		v	-	-	v	v	v	v		v		v		
26dB and 99% Bandwidth	5				v	-	-	v	v				v		v		
	7	-	-				v	v	v				v		v		
	12				v	-	-	v	v				v		v		
	13	-	-		v	-	-	v	v				v		v		
Conducted Band Edge	5	v	v	v	v	-	-	v	v	v	v		v	v		v	
	7	-	-	v	v	v	v	v	v	v	v		v	v		v	
	12	v	v	v	v	-	-	v	v	v	v		v	v		v	
	13	-	-	v	v	-	-	v	v	v	v		v	v		v	
Conducted Spurious Emission	5	v	v	v	v	-	-	v				v			v	v	v
	7	-	-	v	v	v	v	v				v			v	v	v
	12	v	v	v	v	-	-	v				v			v	v	v
	13	-	-	v	v	-	-	v				v			v	v	v
Frequency Stability	5				v	-	-	v						v		v	
	7	-	-				v	v						v		v	
	12				v	-	-	v						v		v	
	13	-	-		v	-	-	v						v		v	



Test Items	Band	Bandwidth (MHz)						Modulation			RB #			Test Channel		
		1.4	3	5	10	15	20	QPSK	16QAM	64QAM	1	Half	Full	L	M	H
E.R.P / E.I.R.P	5	v	v	v	v	-	-	v	v	v	v			v	v	v
	7	-	-	v	v	v	v	v	v	v	v			v	v	v
	12	v	v	v	v	-	-	v	v	v	v			v	v	v
	13	-	-	v	v	-	-	v	v	v	v			v	v	v
	17	-	-	v	v	-	-	v	v	v	v			v	v	v
Radiated Spurious Emission	5	Worst Case													v	
	7	Worst Case													v	
	12	Worst Case													v	
	13	Worst Case													v	
Note	<ol style="list-style-type: none"> The mark "v" means that this configuration is chosen for testing The mark "-" means that this bandwidth is not supported. The device is investigated from 30MHz to 10 times of fundamental signal for radiated spurious emission test under different RB size/offset and modulations in exploratory test. Subsequently, only the worst case emissions are reported. LTE Band 12 overlaps the entire frequency range of LTE Band 17. Therefore, the test results provided in this report covers Band 12 as well as Band 17. 															

Test Items	Band	Bandwidth (MHz)					Modulation				RB #			Test Channel		
		3+5	5+3	5+10	10+5	10+10	QPSK	16QAM	64QAM	256QAM	1	Half	Full	L	M	H
Max. Output Power	5B_CA	v	v	v	v	v	v	v	v		v	v	v	v	v	v
26dB and 99% Bandwidth	5B_CA					v	v	v			v				v	
Conducted Band Edge	5B_CA	v	v	v	v	v	v				v	v	v	v		v
Conducted Spurious Emission	5B_CA	v	v	v	v	v	v				v	v	v	v	v	v
E.I.R.P.	5B_CA	v	v	v	v	v	v	v	v		v			v	v	v
Radiated Spurious Emission	5B_CA	Worst Case													v	
Note	<ol style="list-style-type: none"> The mark "v" means that this configuration is chosen for testing The mark "-" means that this bandwidth is not supported. The device is investigated from 30MHz to 10 times of fundamental signal for radiated spurious emission test under different RB size/offset and modulations in exploratory test. Subsequently, only the worst case emissions are reported. All test items are based on engineering evaluation. 															

2.2 Connection Diagram of Test System

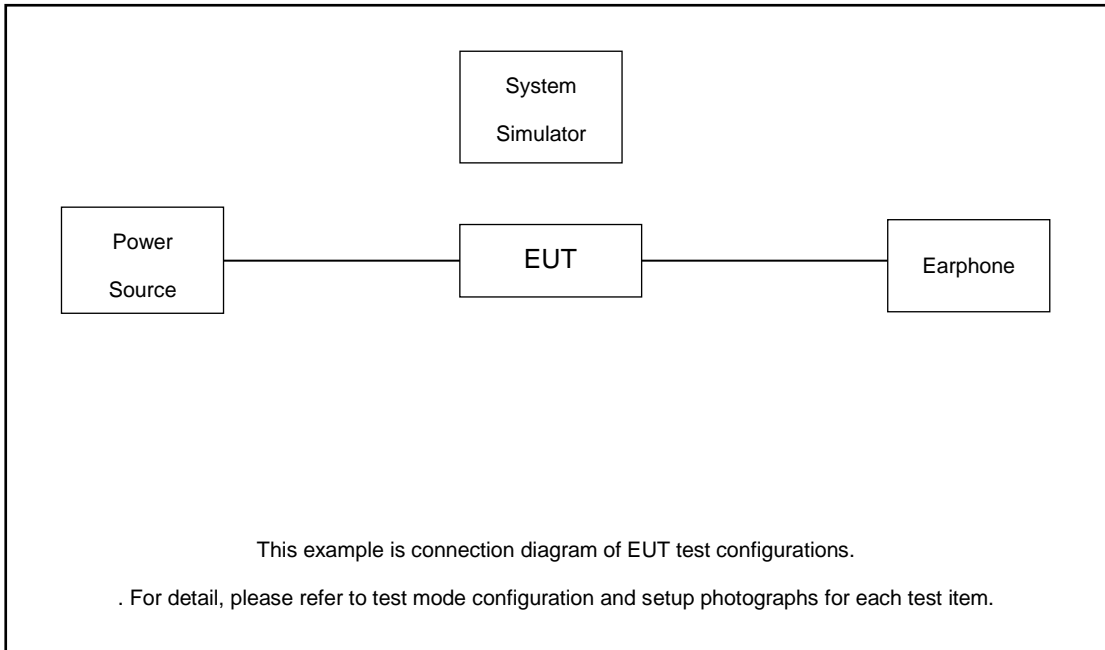

2.3 Support Unit used in test configuration and system

Item	Equipment	Trade Name	Model No.	FCC ID	Data Cable	Power Cord
1.	Power Supply	GWINSTEK	PSS-2002	N/A	N/A	Unshielded, 1.8 m
2.	LTE Base Station	Anritsu	MT8820C	N/A	N/A	Unshielded, 1.8 m
3.	Earphone	N/A	N/A	N/A	N/A	N/A

2.4 Measurement Results Explanation Example

For all conducted test items:

The offset level is set in the spectrum analyzer to compensate the RF cable loss between EUT conducted output port and spectrum analyzer. With the offset compensation, the spectrum analyzer reading level is exactly the EUT RF output level.

The spectrum analyzer offset is derived from RF cable loss.

Offset = RF cable loss.

Following shows an offset computation example with cable loss 5.0 dB.

Example :

$$\begin{aligned} \text{Offset(dB)} &= \text{RF cable loss(dB)} \\ &= 5.0 \text{ (dB)} \end{aligned}$$



2.5 Frequency List of Low/Middle/High Channels

LTE Band 5 Channel and Frequency List				
BW [MHz]	Channel/Frequency(MHz)	Lowest	Middle	Highest
10	Channel	20450	20525	20600
	Frequency	829	836.5	844
5	Channel	20425	20525	20625
	Frequency	826.5	836.5	846.5
3	Channel	20415	20525	20635
	Frequency	825.5	836.5	847.5
1.4	Channel	20407	20525	20643
	Frequency	824.7	836.5	848.3

LTE Band 7 Channel and Frequency List				
BW [MHz]	Channel/Frequency(MHz)	Lowest	Middle	Highest
20	Channel	20850	21100	21350
	Frequency	2510	2535	2560
15	Channel	20825	21100	21375
	Frequency	2507.5	2535	2562.5
10	Channel	20800	21100	21400
	Frequency	2505	2535	2565
5	Channel	20775	21100	21425
	Frequency	2502.5	2535	2567.5



LTE Band 12 Channel and Frequency List				
BW [MHz]	Channel/Frequency(MHz)	Lowest	Middle	Highest
10	Channel	23060	23095	23130
	Frequency	704	707.5	711
5	Channel	23035	23095	23155
	Frequency	701.5	707.5	713.5
3	Channel	23025	23095	23165
	Frequency	700.5	707.5	714.5
1.4	Channel	23017	23095	23173
	Frequency	699.7	707.5	715.3

LTE Band 13 Channel and Frequency List				
BW [MHz]	Channel/Frequency(MHz)	Lowest	Middle	Highest
10	Channel	-	23230	-
	Frequency	-	782	-
5	Channel	23205	23230	23255
	Frequency	779.5	782	784.5

LTE Band 17 Channel and Frequency List				
BW [MHz]	Channel/Frequency(MHz)	Lowest	Middle	Highest
10	Channel	23780	23790	23800
	Frequency	709	710	711
5	Channel	23755	23790	23825
	Frequency	706.5	710	713.5



LTE Band 5B_CA Channel and Frequency List					
BW [MHz]	Channel/Frequency(MHz)		Lowest	Middle	Highest
3 + 5	PCC	Channel	20416	20501	20586
		Frequency	825.6	834.1	842.6
	SCC	Channel	20455	20540	20625
		Frequency	829.5	838.0	846.5
5 + 3	PCC	Channel	20425	20510	20595
		Frequency	826.5	835.0	843.5
	SCC	Channel	20464	20549	20634
		Frequency	830.4	838.9	847.4
5 + 10	PCC	Channel	20428	20478	20528
		Frequency	826.8	831.8	836.8
	SCC	Channel	20500	20550	20600
		Frequency	834	839	844
10 + 5	PCC	Channel	20450	20500	20550
		Frequency	829	834	839
	SCC	Channel	20522	20572	20622
		Frequency	836.2	841.2	846.2
10 + 10	PCC	Channel	20450	20476	20501
		Frequency	829	831.6	834.1
	SCC	Channel	20549	20575	20600
		Frequency	838.9	841.5	844

3 Conducted Test Items

3.1 Measuring Instruments

See list of measuring instruments of this test report.

3.2 Test Setup

3.2.1 Conducted Output Power

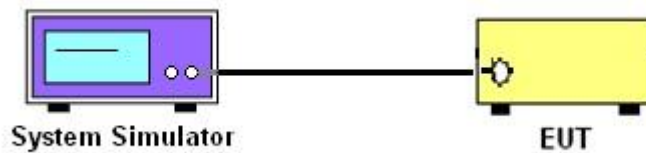

3.2.2 Peak-to-Average Ratio, Occupied Bandwidth ,Conducted Band-Edge and Conducted Spurious Emission

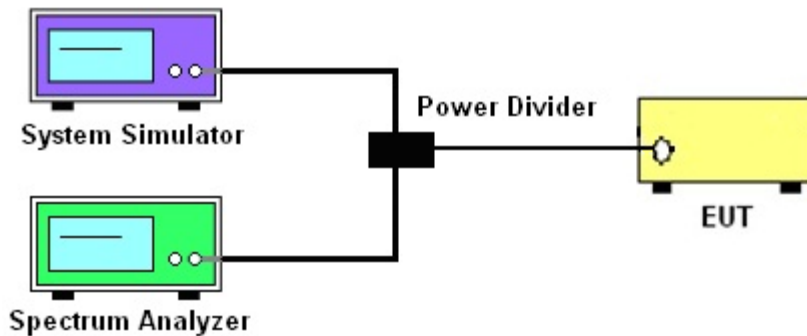

3.2.3 Frequency Stability

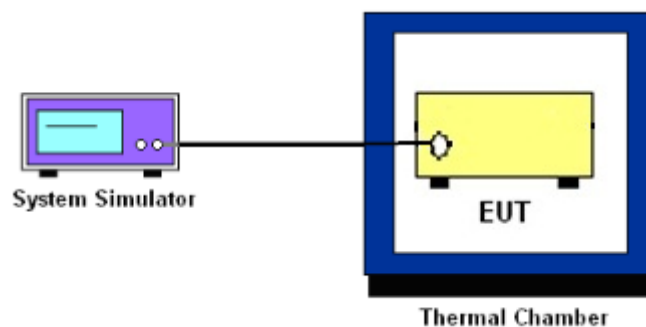

3.3 Test Result of Conducted Test

Please refer to Appendix A.



3.4 Conducted Output Power and ERP/EIRP

3.4.1 Description of the Conducted Output Power Measurement and ERP/EIRP Measurement

A system simulator was used to establish communication with the EUT. Its parameters were set to force the EUT transmitting at maximum output power. The measured power in the radio frequency on the transmitter output terminals shall be reported.

The ERP of mobile transmitters must not exceed 7 Watts for LTE Band 5.

The ERP of mobile transmitters must not exceed 3 Watts for LTE Band 12, Band 13 and Band 17.

The EIRP of mobile transmitters must not exceed 2 Watts for LTE Band 7

The EIRP of mobile transmitters must not exceed 1 Watts for LTE Band 4 and Band 66.

According to KDB 412172 D01 Power Approach,

$EIRP = P_T + G_T - L_C$, $ERP = EIRP - 2.15$, where

P_T = transmitter output power in dBm

G_T = gain of the transmitting antenna in dBi

L_C = signal attenuation in the connecting cable between the transmitter and antenna in dB

3.4.2 Test Procedures

1. The testing follows ANSI C63.26 Section 5.2
2. The transmitter output port was connected to the system simulator.
3. Set EUT at maximum power through the system simulator.
4. Select lowest, middle, and highest channels for each band and different modulation.
5. Measure and record the power level from the system simulator.



3.5 Peak-to-Average Ratio

3.5.1 Description of the PAR Measurement

Power Complementary Cumulative Distribution Function (CCDF) curves provide a means for characterizing the power peaks of a digitally modulated signal on a statistical basis. A CCDF curve depicts the probability of the peak signal amplitude exceeding the average power level. Most contemporary measurement instrumentation include the capability to produce CCDF curves for an input signal provided that the instrument's resolution bandwidth can be set wide enough to accommodate the entire input signal bandwidth. In measuring transmissions in this band using an average power technique, the peak-to-average ratio (PAR) of the transmission may not exceed 13 dB.

3.5.2 Test Procedures

1. The testing follows ANSI C63.26 Section 5.2.3.4 (CCDF).
2. The EUT was connected to spectrum and system simulator via a power divider.
3. Set the CCDF (Complementary Cumulative Distribution Function) option in spectrum analyzer.
4. The highest RF powers were measured and recorded the maximum PAPR level associated with a probability of 0.1 %.
5. Record the deviation as Peak to Average Ratio.



3.6 Occupied Bandwidth

3.6.1 Description of Occupied Bandwidth Measurement

The occupied bandwidth is the width of a frequency band such that, below the lower and above the upper frequency limits, the mean powers emitted are each equal to a specified percentage 0.5% of the total mean transmitted power.

The 26 dB emission bandwidth is defined as the frequency range between two points, one above and one below the carrier frequency, at which the spectral density of the emission is attenuated 26 dB below the maximum in-band spectral density of the modulated signal. Spectral density (power per unit bandwidth) is to be measured with a detector of resolution bandwidth equal to approximately 1.0% of the emission bandwidth.

3.6.2 Test Procedures

1. The testing follows ANSI C63.26 Section 5.4
2. The EUT was connected to spectrum analyzer and system simulator via a power divider.
3. The spectrum analyzer center frequency is set to the nominal EUT channel center frequency. The span range for the spectrum analyzer shall be between two and five times the anticipated OBW.
4. The nominal resolution bandwidth (RBW) shall be in the range of 1 to 5 % of the anticipated OBW, and the VBW shall be at least 3 times the RBW.
5. Set the detection mode to peak, and the trace mode to max hold.
6. Determine the reference value: Set the EUT to transmit a modulated signal. Allow the trace to stabilize. Set the spectrum analyzer marker to the highest level of the displayed trace.
(this is the reference value)
7. Determine the “-26 dB down amplitude” as equal to (Reference Value – X).
8. Place two markers, one at the lowest and the other at the highest frequency of the envelope of the spectral display such that each marker is at or slightly below the “-X dB down amplitude” determined in step 6. If a marker is below this “-X dB down amplitude” value it shall be placed as close as possible to this value. The OBW is the positive frequency difference between the two markers.
9. Use the 99 % power bandwidth function of the spectrum analyzer and report the measured bandwidth.



3.7 Conducted Band Edge

3.7.1 Description of Conducted Band Edge Measurement

22.917(a)

For operations in the 824 – 849 MHz band, the FCC limit is $43 + 10\log_{10}(P[\text{Watts}])$ dB below the transmitter power P(Watts) in a 100kHz bandwidth. However, in the 1MHz bands immediately outside and adjacent to the licensee's frequency block, a resolution bandwidth of at least one percent of the emission bandwidth of the fundamental emission of the transmitter may be employed.

27.53 (c)

For operations in the 776-788 MHz band, the FCC limit is $43 + 10\log_{10}(P[\text{Watts}])$ dB below the transmitter power P(Watts) in a 100 kHz bandwidth. However, in the 100 kHz bands immediately outside and adjacent to the frequency block, a resolution bandwidth of at least 30 kHz may be employed. In addition, the power of any unwanted emissions in any 6.25 kHz bandwidth for all frequencies between 763-775 MHz and 793-806 MHz shall be attenuated below the transmitter power, P (dBW), by at least $65 + 10 \log_{10} p(\text{watts})$, dB, for mobile and portable equipment.

27.53 (g)

For operations in the 600MHz band and 698 -746 MHz band, the FCC limit is $43 + 10\log_{10}(P[\text{Watts}])$ dB below the transmitter power P(Watts) in a 100 kHz bandwidth. However, in the 100 kilohertz bands immediately outside and adjacent to a licensee's frequency block, a resolution bandwidth of at least 30 kHz may be employed.

27.53(m)(4)

For mobile digital stations, the attenuation factor shall be not less than $40 + 10 \log (P)$ dB on all frequencies between the channel edge and 5 megahertz from the channel edge, $43 + 10 \log (P)$ dB on all frequencies between 5 megahertz and X megahertz from the channel edge, and $55 + 10 \log (P)$ dB on all frequencies more than X megahertz from the channel edge, where X is the greater of 6 megahertz or the actual emission bandwidth as defined in paragraph (m)(6) of this section. In addition, the attenuation factor shall not be less that $43 + 10 \log (P)$ dB on all frequencies between 2490.5 MHz and 2496 MHz and $55 + 10 \log (P)$ dB at or below 2490.5 MHz. Mobile Satellite Service licensees operating on frequencies below 2495 MHz may also submit a documented interference complaint against BRS licensees operating on channel BRS Channel 1 on the same terms and conditions as adjacent channel BRS or EBS licensees.



3.7.2 Test Procedures

1. The testing follows ANSI C63.26 section 5.7
2. The EUT was connected to spectrum analyzer and system simulator via a power divider.
3. The band edges of low and high channels for the highest RF powers were measured.
4. Set RBW \geq 1% EBW in the 1MHz band immediately outside and adjacent to the band edge.
5. Beyond the 1 MHz band from the band edge, RBW=1MHz was used or a narrower RBW was used and the measured power was integrated over the full required measurement bandwidth of 1 MHz.
6. Set spectrum analyzer with RMS detector.
7. The RF fundamental frequency should be excluded against the limit line in the operating frequency band.
8. Checked that all the results comply with the emission limit line.

Example:

The limit line is derived from $43 + 10\log(P)$ dB below the transmitter power P(Watts)

$$= P(W) - [43 + 10\log(P)] \text{ (dB)}$$

$$= [30 + 10\log(P)] \text{ (dBm)} - [43 + 10\log(P)] \text{ (dB)} = -13\text{dBm}.$$

9. For LTE Band 7, the other 40 dB, and 55 dB have additionally applied same calculation above.



3.8 Conducted Spurious Emission

3.8.1 Description of Conducted Spurious Emission Measurement

The power of any emission outside of the authorized operating frequency ranges must be lower than the transmitter power (P) by a factor of at least $43 + 10 \log (P)$ dB.

For Band 7:

The power of any emission outside of the authorized operating frequency ranges must be lower than the transmitter power (P) by a factor of at least $55 + 10 \log (P)$ dB.

It is measured by means of a calibrated spectrum analyzer and scanned from 30 MHz up to a frequency including its 10th harmonic.

3.8.2 Test Procedures

1. The testing follows ANSI C63.26 section 5.7
2. The EUT was connected to spectrum analyzer and system simulator via a power divider.
3. The RF output of EUT was connected to the spectrum analyzer by RF cable and attenuator. The path loss was compensated to the results for each measurement.
4. The middle channel for the highest RF power within the transmitting frequency was measured.
5. The conducted spurious emission for the whole frequency range was taken.
6. Make the measurement with the spectrum analyzer's RBW = 1MHz, VBW = 3MHz.
7. Set spectrum analyzer with RMS detector.
8. Taking the record of maximum spurious emission.
9. The RF fundamental frequency should be excluded against the limit line in the operating frequency band.
10. The limit line is derived from $43 + 10\log(P)$ dB below the transmitter power P(Watts)
 $= P(W) - [43 + 10\log(P)]$ (dB)
 $= [30 + 10\log(P)]$ (dBm) - $[43 + 10\log(P)]$ (dB)
 $= -13$ dBm.
11. For Band 7
The limit line is derived from $55 + 10\log(P)$ dB below the transmitter power P(Watts)
 $= P(W) - [55 + 10\log(P)]$ (dB)
 $= [30 + 10\log(P)]$ (dBm) - $[55 + 10\log(P)]$ (dB)
 $= -25$ dBm.



3.9 Frequency Stability

3.9.1 Description of Frequency Stability Measurement

The frequency stability shall be measured by variation of ambient temperature and variation of primary supply voltage to ensure that the fundamental emission stays within the authorized frequency block. The frequency stability of the transmitter shall be maintained within $\pm 0.00025\%$ ($\pm 2.5\text{ppm}$) of the center frequency.

3.9.2 Test Procedures for Temperature Variation

1. The testing follows ANSI C63.26 section 5.6.4
2. The EUT was set up in the thermal chamber and connected with the system simulator.
3. With power OFF, the temperature was decreased to -30°C and the EUT was stabilized before testing. Power was applied and the maximum change in frequency was recorded within one minute.
4. With power OFF, the temperature was raised in 10°C step up to 50°C . The EUT was stabilized at each step for at least half an hour. Power was applied and the maximum frequency change was recorded within one minute.

3.9.3 Test Procedures for Voltage Variation

1. The testing follows ANSI C63.26 section 5.6.5
2. The EUT was placed in a temperature chamber at $20\pm 5^{\circ}\text{C}$ and connected with the system simulator.
3. The power supply voltage to the EUT was varied from 85% to 115% of the nominal value for other than hand carried battery equipment.
4. For hand carried, battery powered equipment, reduce the primary ac or dc supply voltage to the battery operating end point, which shall be specified by the manufacturer.
5. The variation in frequency was measured for the worst case.

4 Radiated Test Items

4.1 Measuring Instruments

See list of measuring instruments of this test report.

4.2 Test Setup

4.2.1 For radiated test from 30MHz to 1GHz

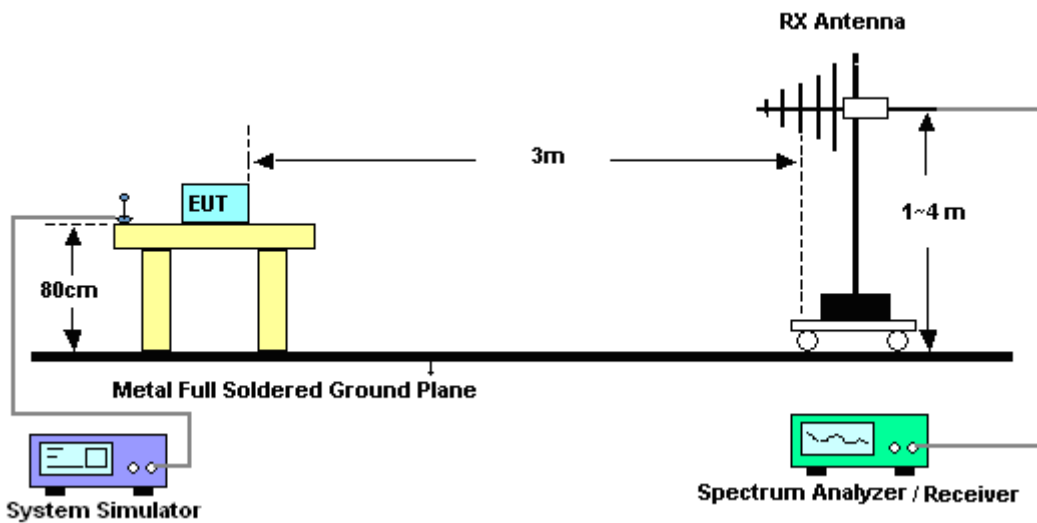

4.2.2 For radiated test above 1GHz

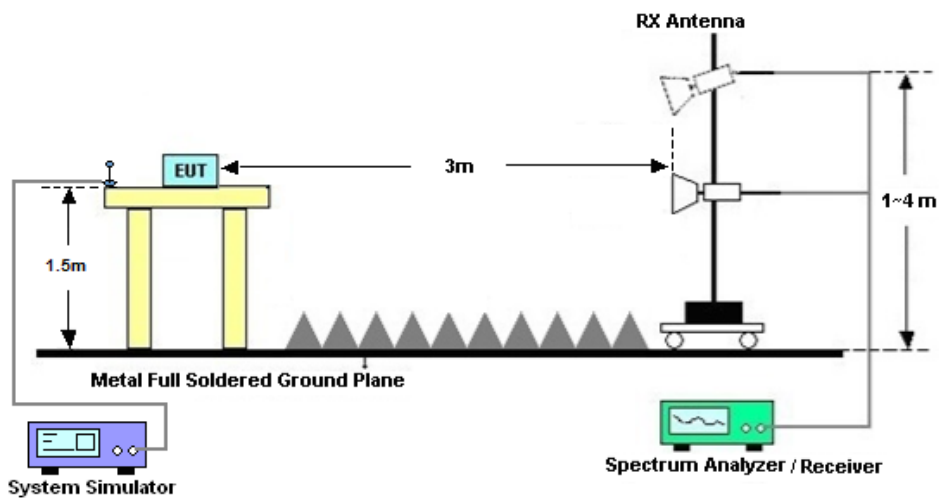

4.3 Test Result of Radiated Test

Please refer to Appendix B.



4.4 Radiated Spurious Emission

4.4.1 Description of Radiated Spurious Emission

The radiated spurious emission was measured by substitution method according to ANSI C63.26. The power of any emission outside of the authorized operating frequency ranges must be attenuated below the transmitter power (P) by a factor of at least $43 + 10 \log (P)$ dB.

For Band 7

The power of any emission outside of the authorized operating frequency ranges must be attenuated below the transmitter power (P) by a factor of at least $55 + 10 \log (P)$ dB.

For LTE Band 13

For operations in the 746-758 MHz, 775-788 MHz, and 805-806 MHz bands, emissions in the band 1559-1610 MHz shall be limited to -70 dBW/MHz equivalent isotropically radiated power (EIRP) for wideband signals, and -80 dBW EIRP for discrete emissions of less than 700 Hz bandwidth.

The spectrum is scanned from 30 MHz up to a frequency including its 10th harmonic.

4.4.2 Test Procedures

1. The testing follows ANSI C63.26 Section 5.5
2. The EUT was placed on a turntable with 0.8 meter height for frequency below 1GHz and 1.5 meter height for frequency above 1GHz respectively above ground.
3. The EUT was set 3 meters from the receiving antenna mounted on the antenna tower.
4. The table was rotated 360 degrees to determine the position of the highest spurious emission.
5. The height of the receiving antenna is varied between 1m to 4m to search the maximum spurious emission for both horizontal and vertical polarizations.
6. During the measurement, the system simulator parameters were set to force the EUT transmitting at maximum output power.
7. Make the measurement with the spectrum analyzer's RBW = 1MHz, VBW = 3MHz, taking the record of maximum spurious emission.
8. A horn antenna was substituted in place of the EUT and was driven by a signal generator.
9. Tune the output power of signal generator to the same emission level with EUT maximum spurious emission.
10. $EIRP (dBm) = S.G. Power - Tx Cable Loss + Tx Antenna Gain$
11. $ERP (dBm) = EIRP - 2.15$
12. The RF fundamental frequency should be excluded against the limit line in the operating frequency band.
The limit line is derived from $43 + 10\log(P)$ dB below the transmitter power P(Watts)
 $= P(W) - [43 + 10\log(P)] (dB)$
 $= [30 + 10\log(P)] (dBm) - [43 + 10\log(P)] (dB)$
 $= -13dBm.$
13. For Band 7: The limit line is derived from $55 + 10\log(P)$ dB below the transmitter power P(Watts)



5 List of Measuring Equipment

Instrument	Manufacturer	Model No.	Serial No.	Characteristics	Calibration Date	Test Date	Due Date	Remark
Spectrum Analyzer	R&S	FSV40	101040	10Hz~40GHz	Nov. 02, 2020	Mar. 13, 2021~ Apr. 22, 2021	Nov. 01, 2021	Conducted (TH01-KS)
Temperature & humidity chamber	Hongzhan	LP-150U	H2014011440	-40~+150°C 20%~95%RH	Jul. 03, 2020	Mar. 13, 2021~ Apr. 22, 2021	Jul. 02, 2021	Conducted (TH01-KS)
EXA Spectrum Analyzer	Keysight	N9010A	MY55150244	10Hz-44G,MAX 30dB	Apr. 15, 2020	Mar. 27, 2021	Apr. 14, 2021	Radiation (03CH04-KS)
Bilog Antenna	TeseQ	CBL6111D	49922	30MHz-1GHz	Jun. 08, 2020	Mar. 27, 2021	Jun. 07, 2021	Radiation (03CH04-KS)
Double Ridge Horn Antenna	ETS-Lindgren	3117	218642	1GHz~18GHz	Dec. 20, 2020	Mar. 27, 2021	Dec. 19, 2021	Radiation (03CH04-KS)
SHF-EHF Horn	Com-power	AH-840	101115	18GHz~40GHz	Jan. 06, 2021	Mar. 27, 2021	Jan. 05, 2022	Radiation (03CH04-KS)
Amplifier	SONOMA	310N	187289	9KHz-1GHz	Jan. 06, 2021	Mar. 27, 2021	Jan. 05, 2022	Radiation (03CH04-KS)
Amplifier	MITEQ	EM18G40G GA	060728	18~40GHz	Jan. 06, 2021	Mar. 27, 2021	Jan. 05, 2022	Radiation (03CH04-KS)
high gain Amplifier	MITEQ	AMF-7D-00 101800-30-1 0P	2025788	1Ghz-18Ghz	Jan. 06, 2021	Mar. 27, 2021	Jan. 05, 2022	Radiation (03CH04-KS)
Amplifier	Keysight	83017A	MY57280106	500MHz~26.5GHz	Oct. 14, 2020	Mar. 27, 2021	Oct. 13, 2021	Radiation (03CH04-KS)
AC Power Source	Chroma	61601	F104090004	N/A	NCR	Mar. 27, 2021	NCR	Radiation (03CH04-KS)
Turn Table	ChamPro	EM 1000-T	060762-T	0~360 degree	NCR	Mar. 27, 2021	NCR	Radiation (03CH04-KS)
Antenna Mast	ChamPro	EM 1000-A	060762-A	1 m~4 m	NCR	Mar. 27, 2021	NCR	Radiation (03CH04-KS)



6 Uncertainty of Evaluation

The measurement uncertainties shown below were calculated in accordance with the requirements of ANSI 63.26-2015. All the measurement uncertainty value were shown with a coverage K=2 to indicate 95% level of confidence. The measurement data show herein meets or exceeds the CISPR measurement uncertainty values specified in CISPR 16-4-2 and can be compared directly to specified limit to determine compliance.

Uncertainty of Radiated Emission Measurement (30 MHz ~ 1000 MHz)

Measuring Uncertainty for a Level of Confidence of 95% (U = 2Uc(y))	3.3dB
---	-------

Uncertainty of Radiated Emission Measurement (1 GHz ~ 40 GHz)

Measuring Uncertainty for a Level of Confidence of 95% (U = 2Uc(y))	2.8dB
---	-------



Appendix A. Test Results of Conducted Test

Conducted Output Power(Average power) and ERP/EIRP

Ant 1

LTE Band 5									
BW [MHz]	Modulation	RB Size	RB Offset	Power Low Ch. / Freq.	Power Middle Ch. / Freq.	Power High Ch. / Freq.	ERP(W)		
Channel				20450	20525	20600			
Frequency (MHz)				829	836.5	844	L	M	H
10	QPSK	1	0	22.71	22.90	22.57	0.0625	0.0653	0.0605
10	QPSK	1	49	22.64	22.64	22.59	0.0615	0.0615	0.0608
10	QPSK	50	0	21.72	21.79	21.54	0.0498	0.0506	0.0478
10	16QAM	1	0	21.89	22.00	21.70	0.0518	0.0531	0.0495
10	64QAM	1	0	21.22	21.20	21.21	0.0444	0.0442	0.0443
Channel				20425	20525	20625	ERP(W)		
Frequency (MHz)				826.5	836.5	846.5	L	M	H
5	QPSK	1	0	22.58	22.45	22.39	0.0607	0.0589	0.0581
5	16QAM	1	0	21.92	22.00	21.84	0.0521	0.0531	0.0512
Channel				20415	20525	20635	ERP(W)		
Frequency (MHz)				825.5	836.5	847.5	L	M	H
3	QPSK	1	0	22.60	22.45	22.42	0.0610	0.0589	0.0585
3	16QAM	1	0	21.99	21.86	21.81	0.0530	0.0514	0.0508
Channel				20407	20525	20643	ERP(W)		
Frequency (MHz)				824.7	836.5	848.3	L	M	H
1.4	QPSK	1	0	22.54	22.46	22.33	0.0601	0.0590	0.0573
1.4	16QAM	1	0	21.91	21.78	21.77	0.0520	0.0505	0.0504



LTE Band 7									
BW [MHz]	Modulation	RB Size	RB Offset	Power Low Ch. / Freq.	Power Middle Ch. / Freq.	Power High Ch. / Freq.	EIRP(W)		
Channel				20850	20850	21350			
Frequency (MHz)				2510	2535	2560	L	M	H
20	QPSK	1	0	23.46	23.63	23.39	0.1466	0.1524	0.1442
20	QPSK	1	99	23.47	23.40	23.45	0.1469	0.1445	0.1462
20	QPSK	100	0	22.33	22.45	22.38	0.1130	0.1161	0.1143
20	16QAM	1	0	22.60	22.73	22.53	0.1202	0.1239	0.1183
20	64QAM	1	0	21.72	21.59	21.47	0.0982	0.0953	0.0927
Channel				20825	21100	21375	EIRP(W)		
Frequency (MHz)				2507.5	2535	2562.5	L	M	H
15	QPSK	1	0	23.32	23.21	23.16	0.1419	0.1384	0.1368
15	16QAM	1	0	22.67	22.47	22.56	0.1222	0.1167	0.1191
Channel				20800	21100	21400	EIRP(W)		
Frequency (MHz)				2505	2535	2565	L	M	H
10	QPSK	1	0	23.54	23.45	23.40	0.1493	0.1462	0.1445
10	16QAM	1	0	22.65	22.63	22.70	0.1216	0.1211	0.1230
Channel				20775	21100	21425	EIRP(W)		
Frequency (MHz)				2502.5	2535	2567.5	L	M	H
5	QPSK	1	0	23.53	23.35	23.37	0.1489	0.1429	0.1435
5	16QAM	1	0	22.60	22.73	22.60	0.1202	0.1239	0.1202



LTE Band 12									
BW [MHz]	Modulation	RB Size	RB Offset	Power Low Ch. / Freq.	Power Middle Ch. / Freq.	Power High Ch. / Freq.	ERP(W)		
Channel				23060	23095	23160			
Frequency (MHz)				704	707.5	714	L	M	H
10	QPSK	1	0	22.93	23.19	22.90	0.0847	0.0899	0.0841
10	QPSK	1	49	22.62	22.60	22.61	0.0789	0.0785	0.0787
10	QPSK	50	0	21.99	22.01	21.86	0.0682	0.0685	0.0662
10	16QAM	1	0	22.05	22.04	22.17	0.0692	0.0690	0.0711
10	64QAM	1	0	21.27	21.22	21.28	0.0578	0.0571	0.0579
Channel				23035	23095	23205	ERP(W)		
Frequency (MHz)				701.5	707.5	718.5	L	M	H
5	QPSK	1	0	22.76	22.58	22.66	0.0815	0.0782	0.0796
5	16QAM	1	0	22.13	22.00	22.11	0.0705	0.0684	0.0701
Channel				23025	23095	23195	ERP(W)		
Frequency (MHz)				700.5	707.5	717.5	L	M	H
3	QPSK	1	0	22.81	22.64	22.62	0.0824	0.0793	0.0789
3	16QAM	1	0	22.14	22.17	22.04	0.0706	0.0711	0.0690
Channel				23017	23095	23173	ERP(W)		
Frequency (MHz)				699.7	707.5	715.3	L	M	H
1.4	QPSK	1	0	22.71	22.61	22.45	0.0805	0.0787	0.0759
1.4	16QAM	1	0	22.13	22.05	22.08	0.0705	0.0692	0.0697



LTE Band 13									
BW [MHz]	Modulation	RB Size	RB Offset	Power Low Ch. / Freq.	Power Middle Ch. / Freq.	Power High Ch. / Freq.	ERP(W)		
Channel				23230					
Frequency (MHz)				782				M	
10	QPSK	1	0		23.28			0.0516	
10	QPSK	1	49		22.93			0.0476	
10	QPSK	50	0		22.18			0.0401	
10	16QAM	1	0		22.34			0.0416	
10	64QAM	1	0		21.52			0.0344	
Channel				23205	23230	23255	EIRP(W)		
Frequency (MHz)				779.5	782	784.5	L	M	H
5	QPSK	1	0	22.98	23.10	23.03	0.0482	0.0495	0.0488
5	16QAM	1	0	22.34	22.34	22.21	0.0416	0.0416	0.0404

LTE Band 17									
BW [MHz]	Modulation	RB Size	RB Offset	Power Low Ch. / Freq.	Power Middle Ch. / Freq.	Power High Ch. / Freq.	ERP(W)		
Channel				23780	23790	23830			
Frequency (MHz)				709	710	714	L	M	H
10	QPSK	1	0	23.00	23.18	22.91	0.0861	0.0897	0.0843
10	QPSK	1	49	22.82	22.81	22.75	0.0826	0.0824	0.0813
10	QPSK	50	0	21.91	22.04	21.89	0.0670	0.0690	0.0667
10	16QAM	1	0	22.25	22.17	22.10	0.0724	0.0711	0.0700
10	64QAM	1	0	21.27	21.27	21.21	0.0578	0.0578	0.0570
Channel				23755	23790	23825	EIRP(W)		
Frequency (MHz)				706.5	710	713.5	L	M	H
5	QPSK	1	0	22.84	22.79	22.74	0.0830	0.0820	0.0811
5	16QAM	1	0	22.25	22.05	22.13	0.0724	0.0692	0.0705



LTE Band 5B_CA								
Combination 10MHz+10MHz (50RB+50RB)								
Channel	Modulation	PCC		SCC		Measured Power	ERP	EIRP
		RB Size	RB offset	RB Size	RB offset			
L	QPSK	1	Max	1	0	22.78	0.0635	0.1042
M	QPSK	1	Max	1	0	22.65	0.0617	0.1012
H	QPSK	1	Max	1	0	22.55	0.0603	0.0989
L	16QAM	1	Max	1	0	21.56	0.0480	0.0787
M	16QAM	1	Max	1	0	21.55	0.0479	0.0785
H	16QAM	1	Max	1	0	21.45	0.0468	0.0767
L	64QAM	1	Max	1	0	20.89	0.0411	0.0675
M	64QAM	1	Max	1	0	20.78	0.0401	0.0658
H	64QAM	1	Max	1	0	20.65	0.0389	0.0638
Combination 10MHz+5MHz (50RB+25RB)								
Channel	Modulation	PCC		SCC		Measured Power	ERP	EIRP
		RB Size	RB offset	RB Size	RB offset			
L	QPSK	1	Max	1	0	22.14	0.0548	0.0899
L	16QAM	1	Max	1	0	21.12	0.0434	0.0711
Combination 5MHz+10MHz (25RB+50RB)								
Channel	Modulation	PCC		SCC		Measured Power	ERP	EIRP
		RB Size	RB offset	RB Size	RB offset			
L	QPSK	1	Max	1	0	22.13	0.0547	0.0897
L	16QAM	1	Max	1	0	21.23	0.0445	0.0729
Combination 5MHz+3MHz (25RB+15RB)								
Channel	Modulation	PCC		SCC		Measured Power	ERP	EIRP
		RB Size	RB offset	RB Size	RB offset			
L	QPSK	1	Max	1	0	22.21	0.0557	0.0914
L	16QAM	1	Max	1	0	21.12	0.0434	0.0711
Combination 3MHz+5MHz (15RB+25RB)								
Channel	Modulation	PCC		SCC		Measured Power	ERP	EIRP
		RB Size	RB offset	RB Size	RB offset			
L	QPSK	1	Max	1	0	22.23	0.0560	0.0918
L	16QAM	1	Max	1	0	21.01	0.0423	0.0693



LTE Band 5

Peak-to-Average Ratio

Mode	LTE Band 5 / 10MHz			
Mod.	QPSK	16QAM	64QAM	Limit: 13dB
RB Size	Full RB	Full RB	Full RB	Result
Middle CH	5.07	5.77	5.80	PASS

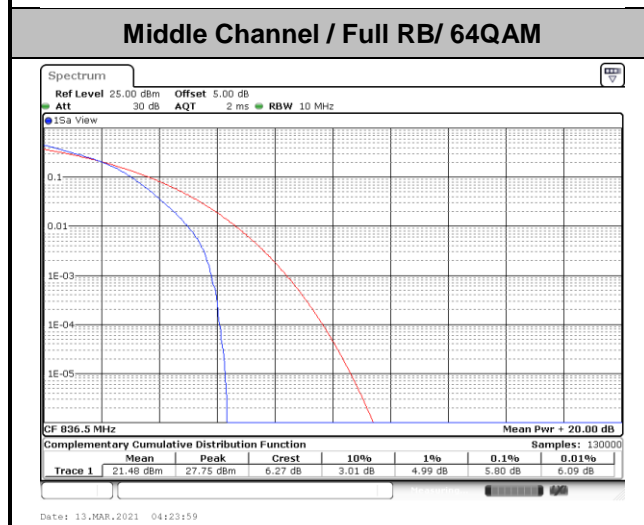
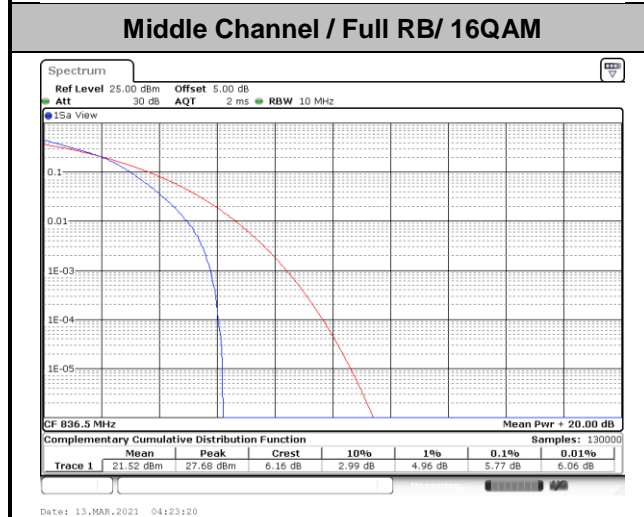
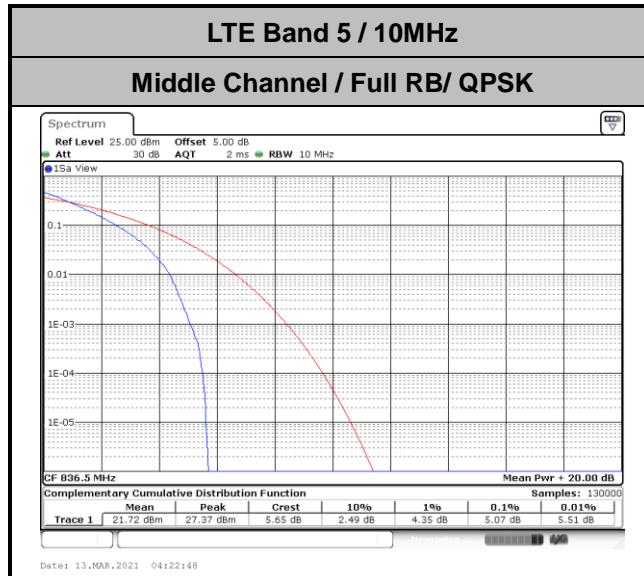



26dB Bandwidth

Mode	LTE Band 5 : 26dB BW(MHz)	
BW	10MHz	
Mod.	QPSK	16QAM
Middle CH	9.75	9.73

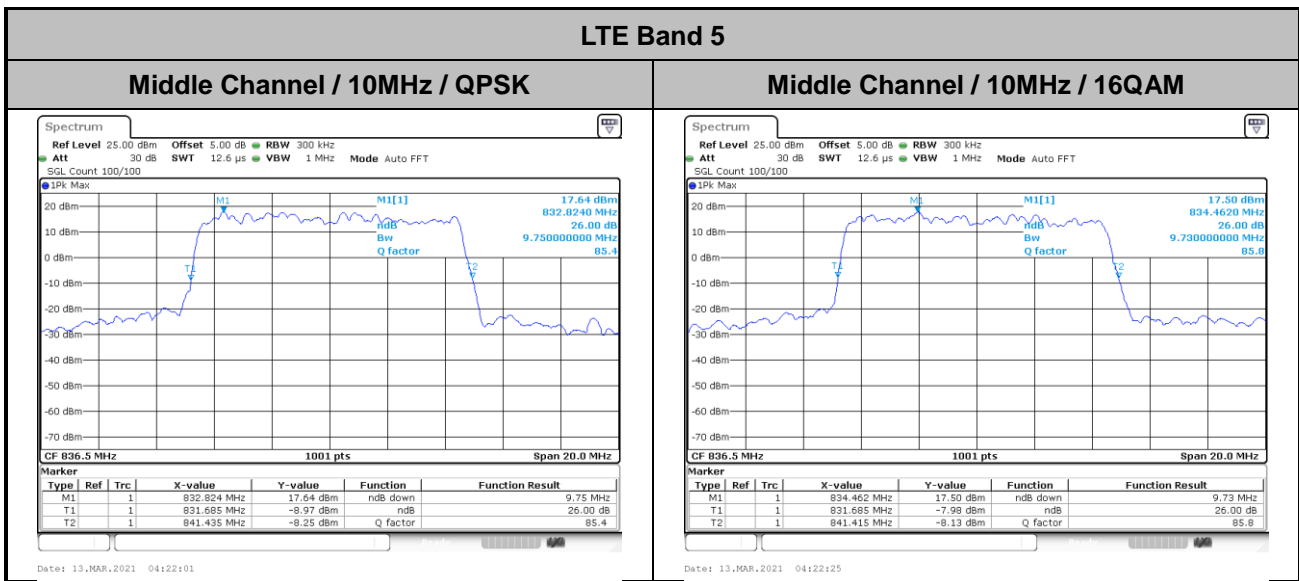



Occupied Bandwidth

Mode	LTE Band 5 : 99%OBW(MHz)	
BW	10MHz	
Mod.	QPSK	16QAM
Middle CH	9.01	9.05

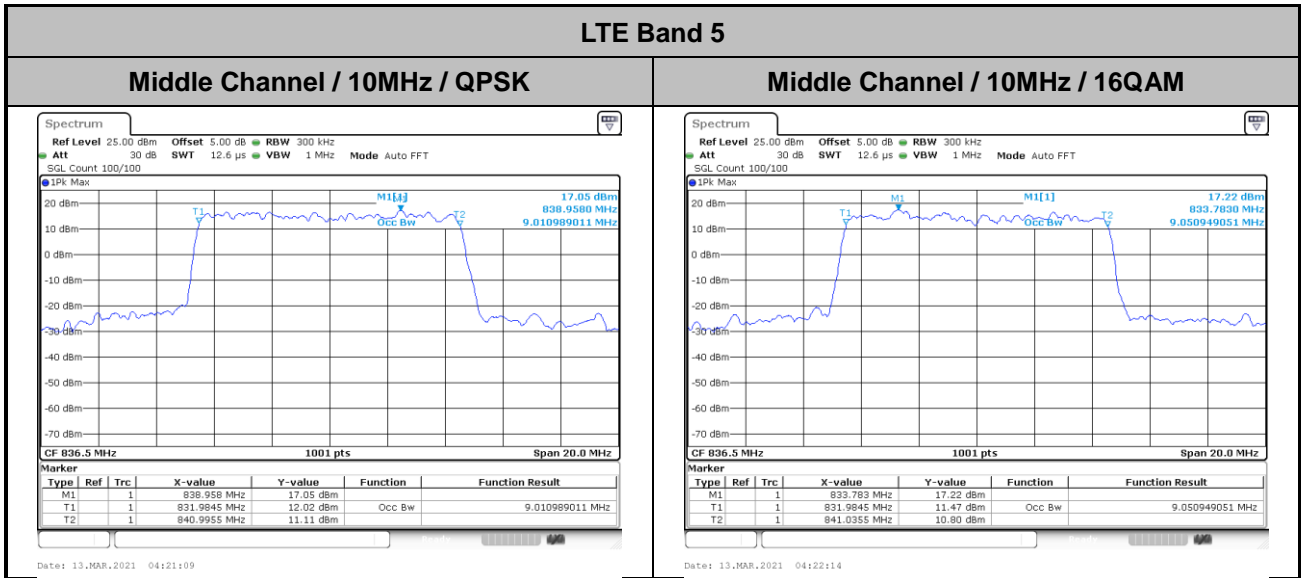



Conducted Band Edge

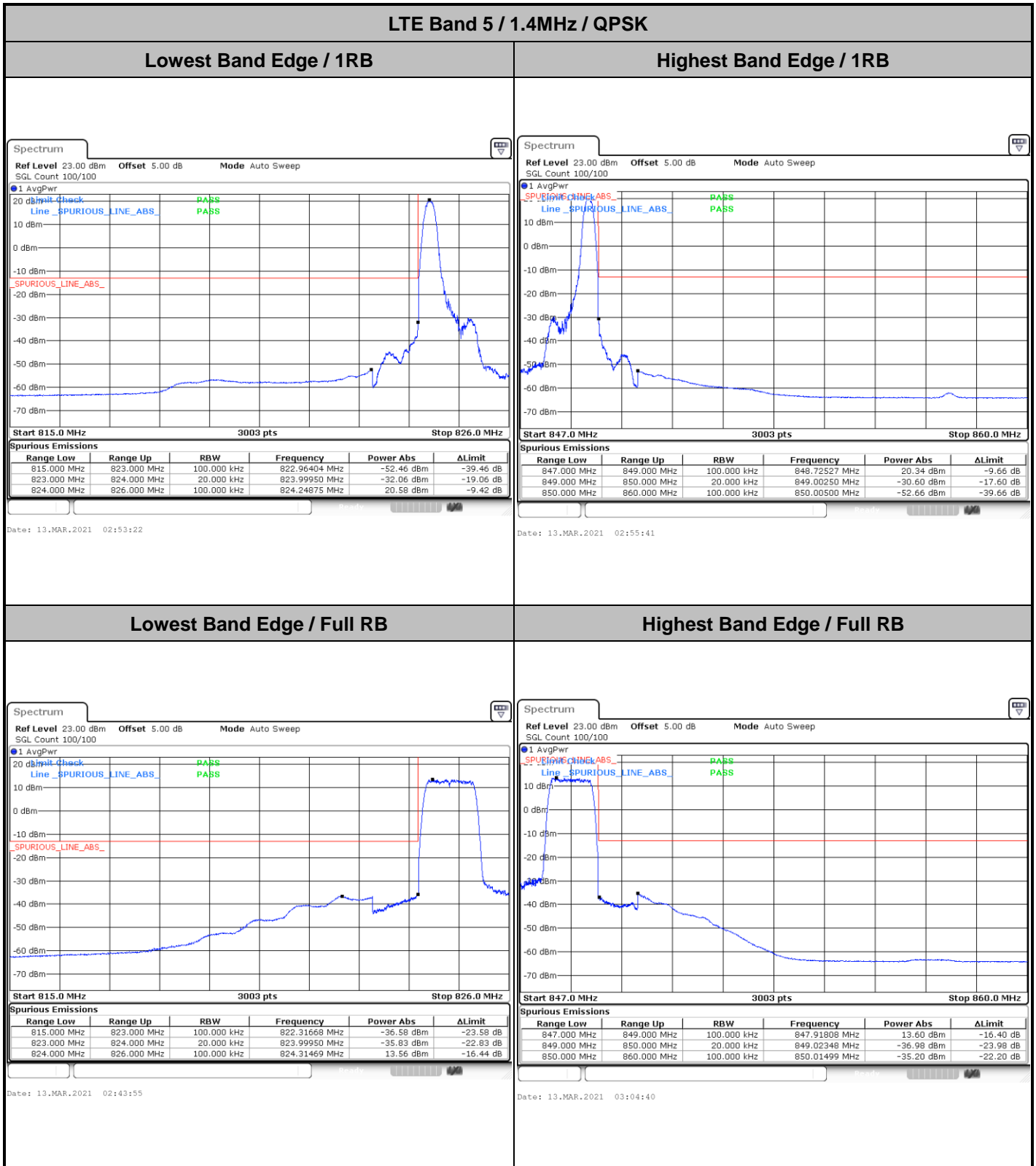



LTE Band 5 / 1.4MHz / 16QAM

Lowest Band Edge / 1 RB

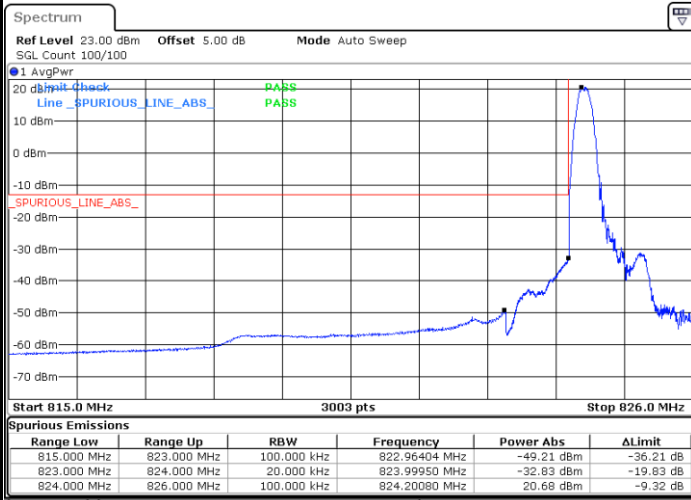

Date: 13.MAR.2021 02:51:03

Highest Band Edge / 1 RB



Date: 13.MAR.2021 02:57:12

Lowest Band Edge / Full RB

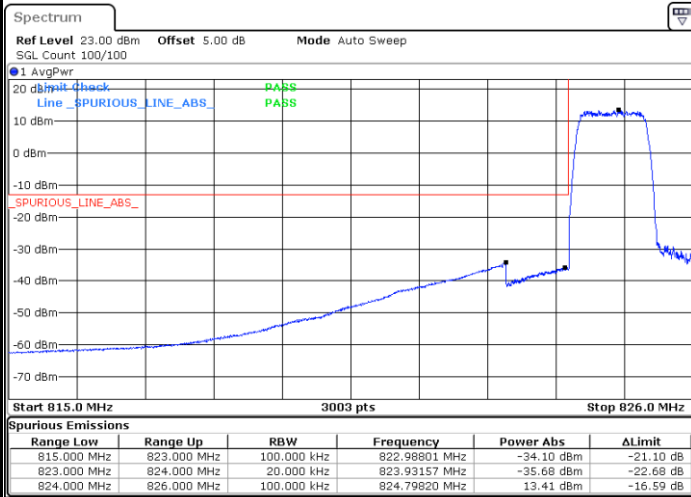

Date: 13.MAR.2021 02:45:19

Highest Band Edge / Full RB

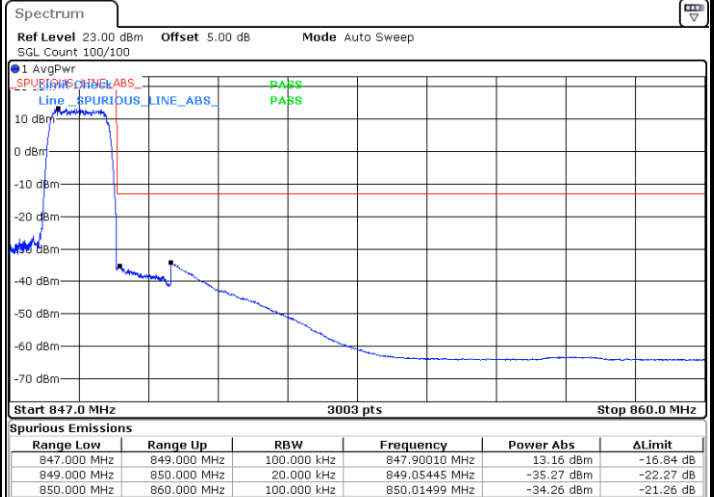

Date: 13.MAR.2021 03:02:28



LTE Band 5 / 1.4MHz / 64QAM

Lowest Band Edge / 1 RB

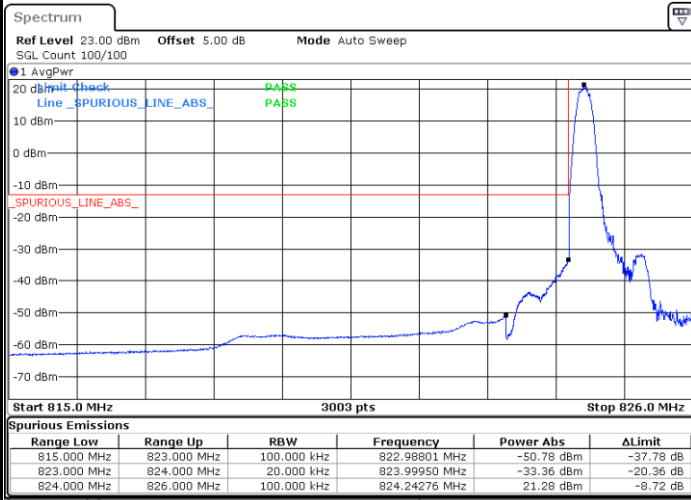

Date: 13.MAR.2021 02:48:12

Highest Band Edge / 1 RB



Date: 13.MAR.2021 02:58:48

Lowest Band Edge / Full RB

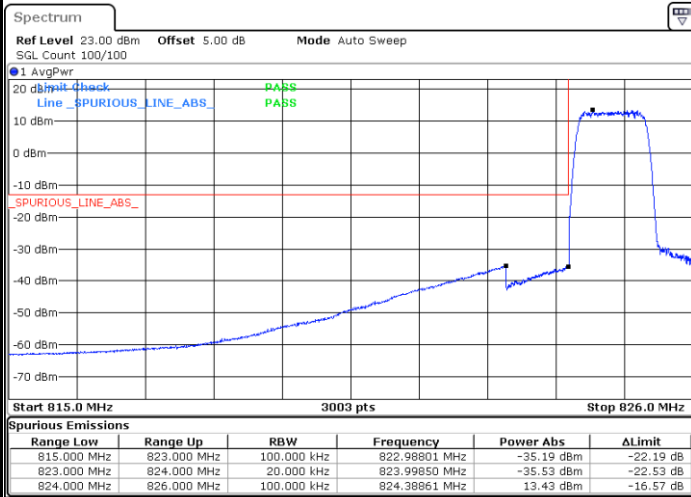

Date: 13.MAR.2021 02:46:46

Highest Band Edge / Full RB



Date: 13.MAR.2021 03:00:26



LTE Band 5 / 3MHz / QPSK

Lowest Band Edge / 1RB

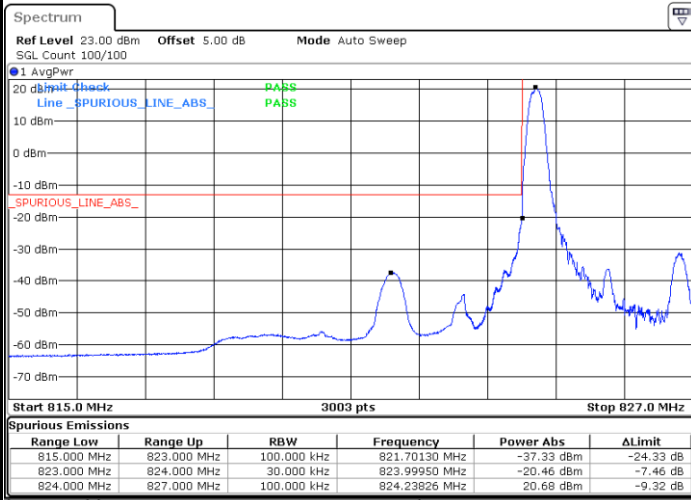

Date: 13.MAR.2021 03:31:58

Highest Band Edge / 1 RB

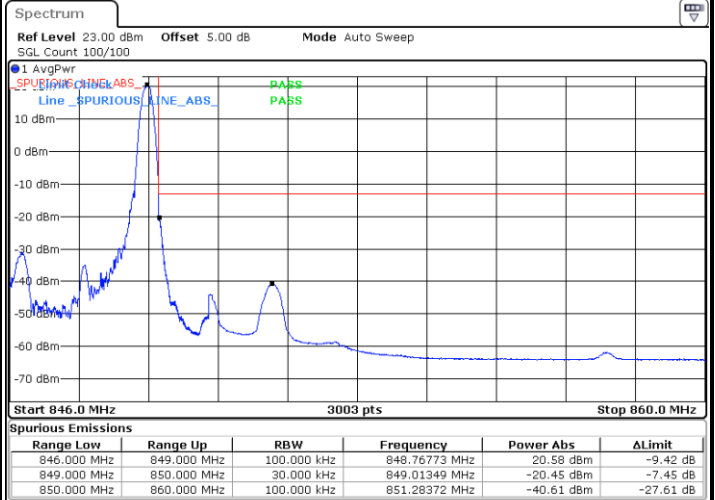

Date: 13.MAR.2021 03:44:53

Lowest Band Edge / Full RB

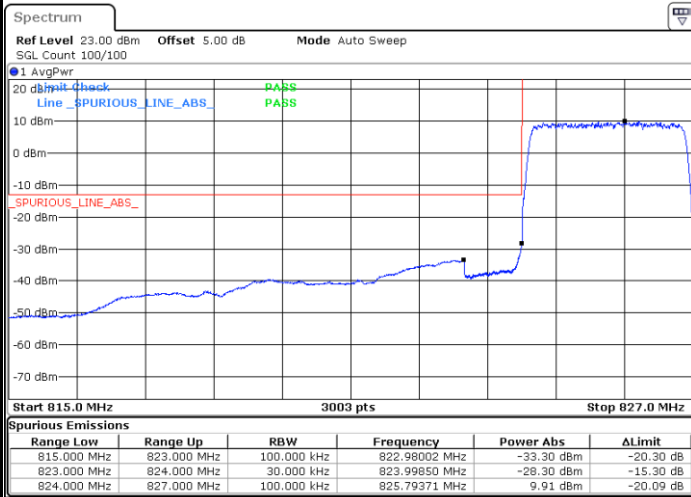

Date: 13.MAR.2021 03:37:28

Highest Band Edge / Full RB

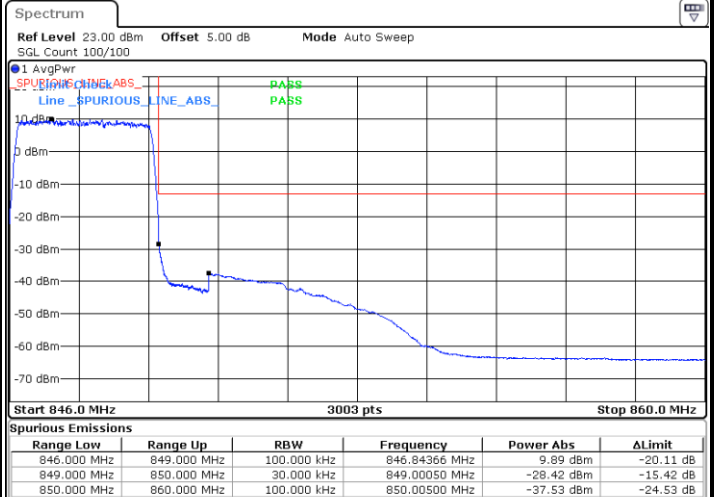

Date: 13.MAR.2021 03:38:52



LTE Band 5 / 3MHz / 16QAM

Lowest Band Edge / 1 RB

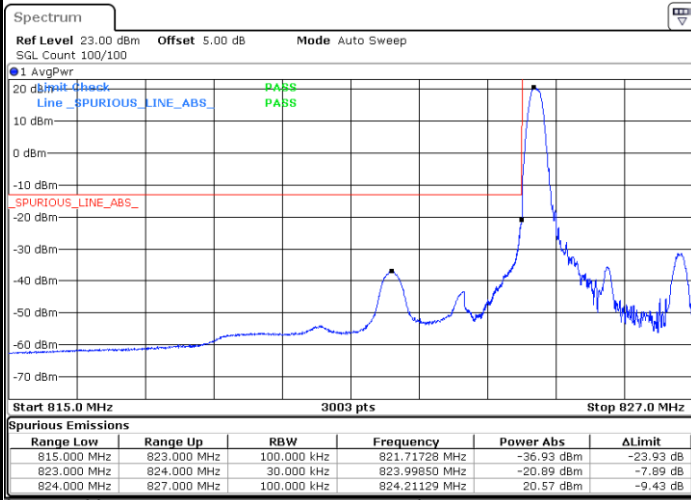

Date: 13.MAR.2021 03:33:08

Highest Band Edge / 1 RB

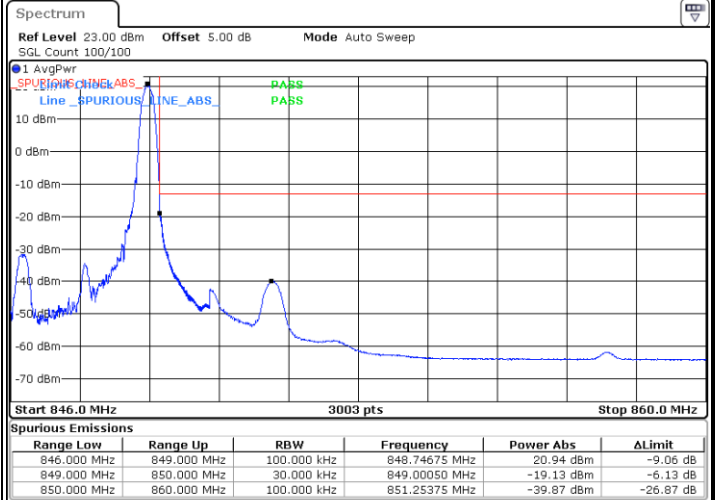

Date: 13.MAR.2021 03:43:51

Lowest Band Edge / Full RB

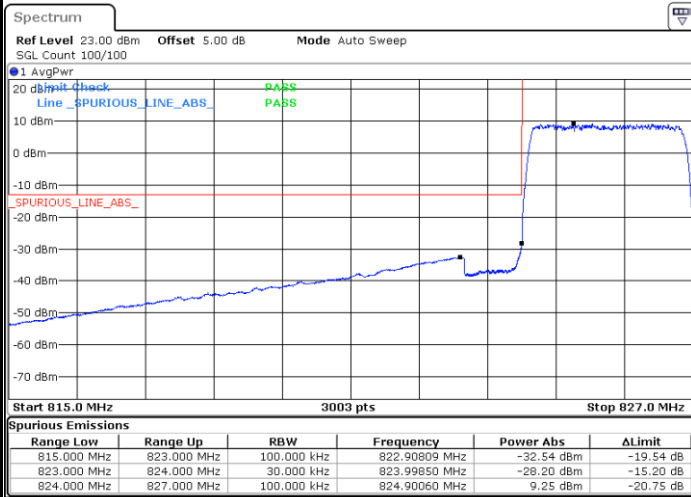

Date: 13.MAR.2021 03:36:10

Highest Band Edge / Full RB



Date: 13.MAR.2021 03:40:28



LTE Band 5 / 3MHz / 64QAM

Lowest Band Edge / 1 RB

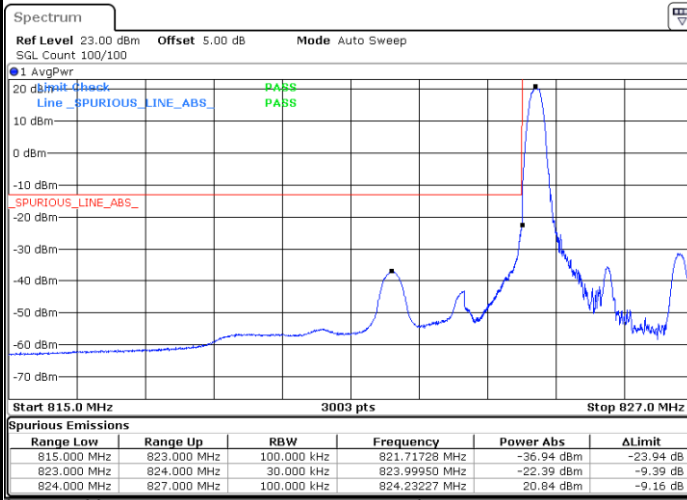

Date: 13.MAR.2021 03:34:06

Highest Band Edge / 1 RB

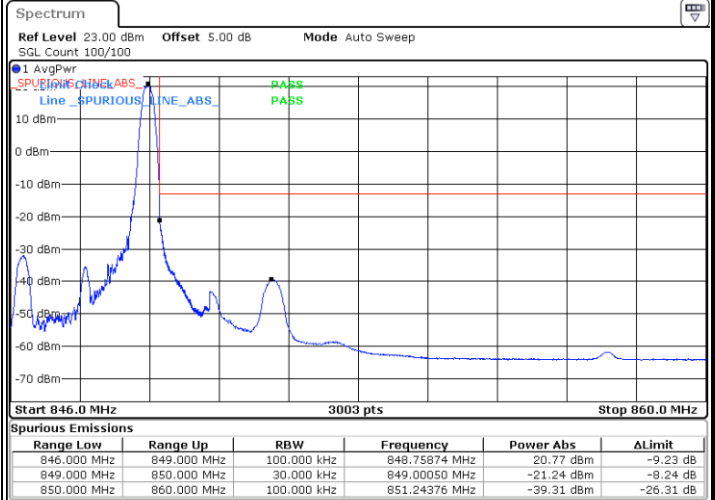

Date: 13.MAR.2021 03:42:47

Lowest Band Edge / Full RB

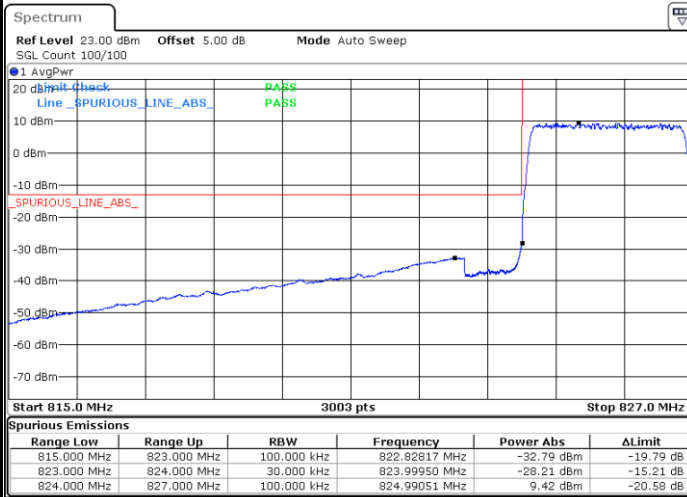

Date: 13.MAR.2021 03:35:12

Highest Band Edge / Full RB



Date: 13.MAR.2021 03:41:41



LTE Band 5 / 5MHz / QPSK

Lowest Band Edge / 1 RB

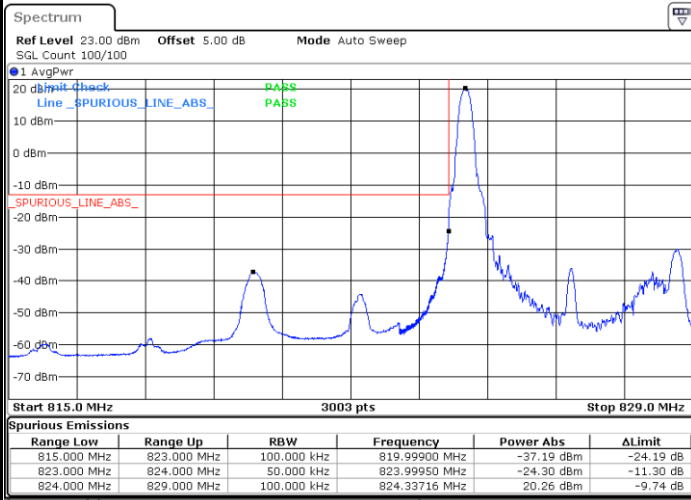

Date: 13.MAR.2021 03:58:28

Highest Band Edge / 1 RB

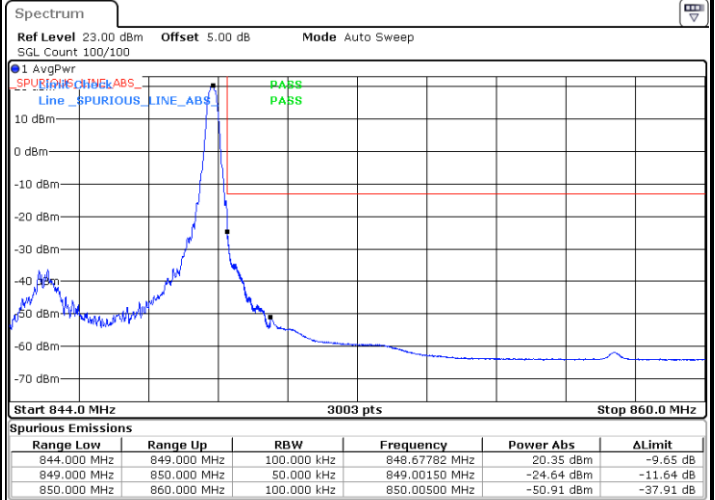

Date: 13.MAR.2021 03:46:25

Lowest Band Edge / Full RB

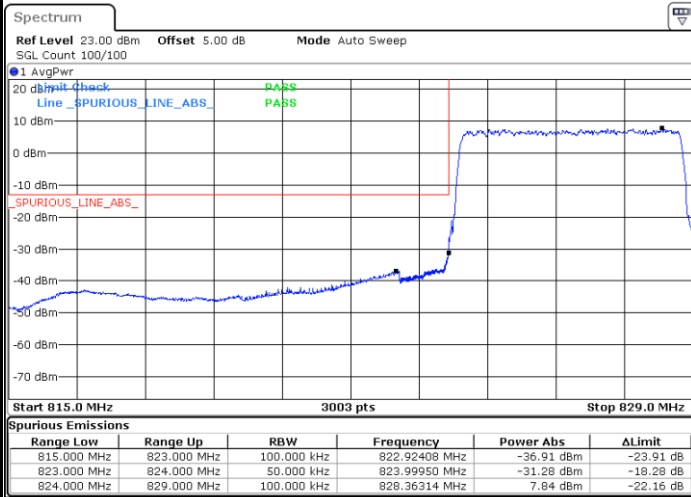

Date: 13.MAR.2021 03:53:21

Highest Band Edge / Full RB



Date: 13.MAR.2021 03:52:27



LTE Band 5 / 5MHz / 16QAM

Lowest Band Edge / 1RB

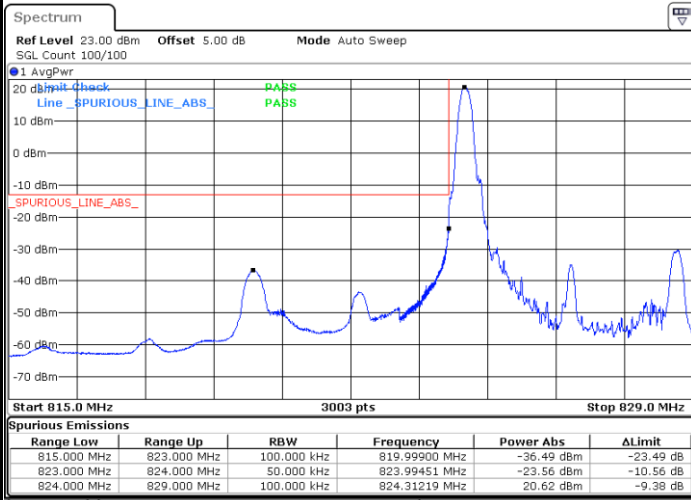

Date: 13.MAR.2021 03:56:38

Highest Band Edge / 1 RB

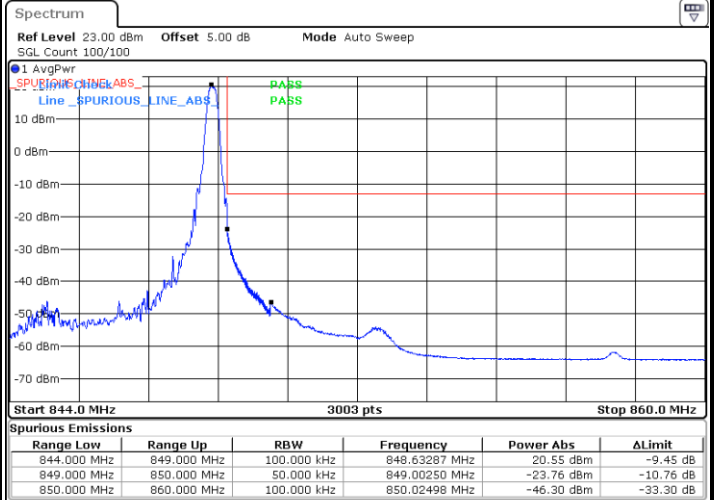

Date: 13.MAR.2021 03:47:15

Lowest Band Edge / Full RB

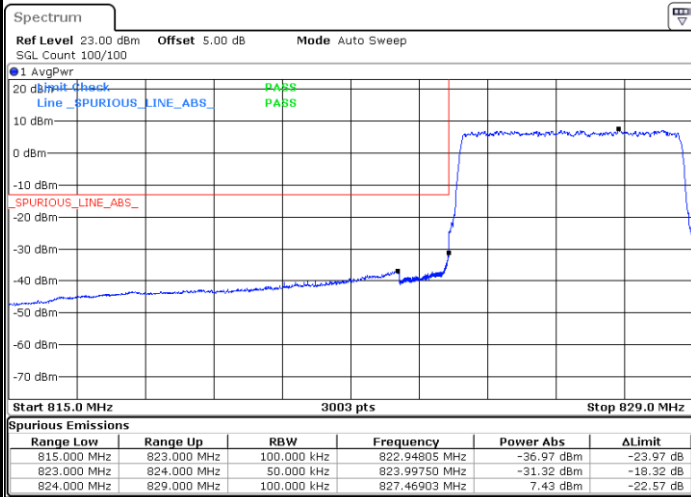

Date: 13.MAR.2021 03:54:08

Highest Band Edge / Full RB

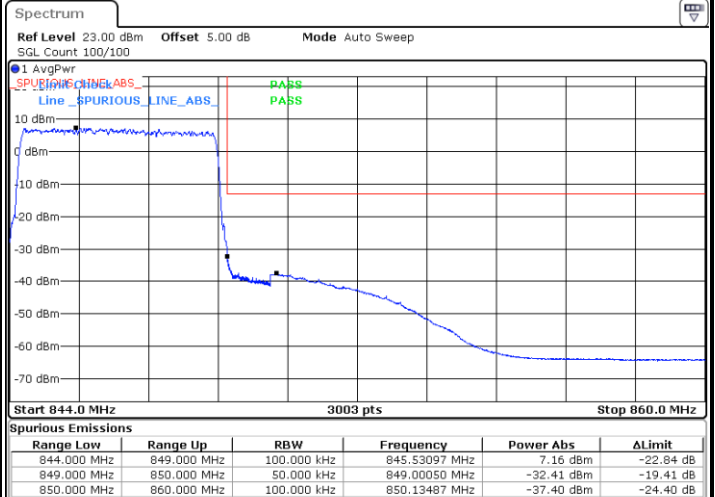

Date: 13.MAR.2021 03:49:53



LTE Band 5 / 5MHz / 64QAM

Lowest Band Edge / 1RB

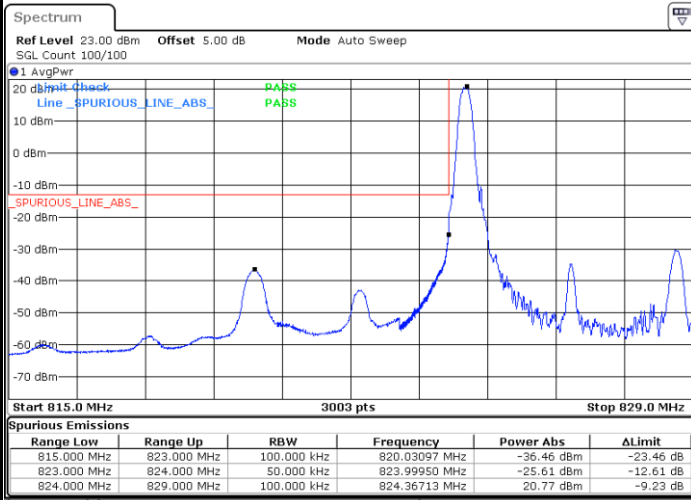

Date: 13.MAR.2021 03:55:44

Highest Band Edge / 1 RB

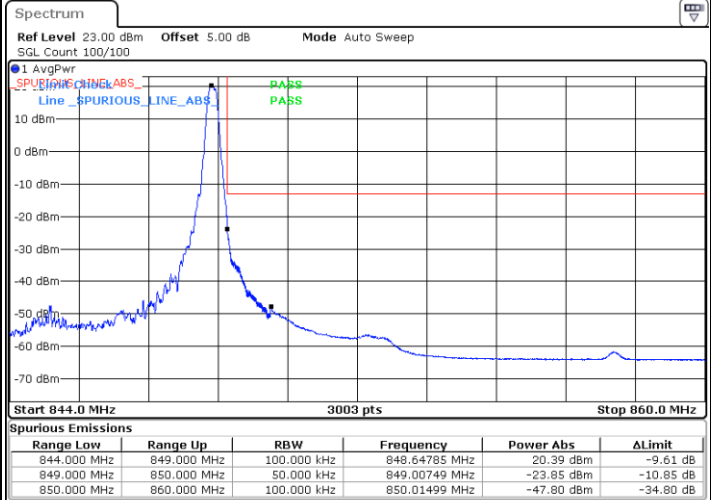

Date: 13.MAR.2021 03:48:01

Lowest Band Edge / Full RB

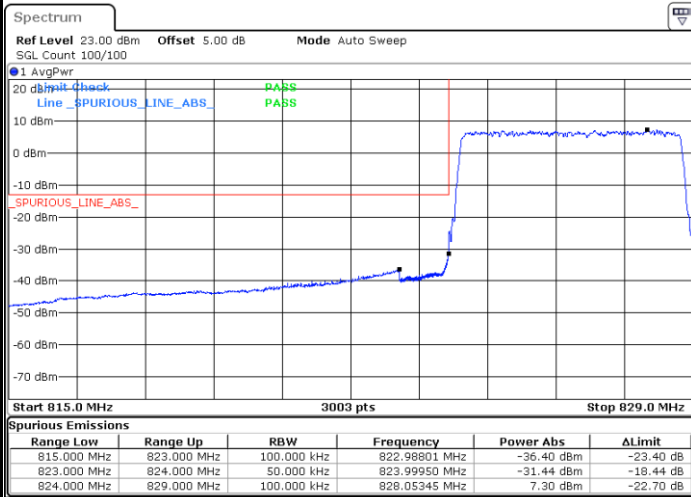

Date: 13.MAR.2021 03:54:51

Highest Band Edge / Full RB



Date: 13.MAR.2021 03:48:52



LTE Band 5 / 10MHz / QPSK

Lowest Band Edge / 1 RB

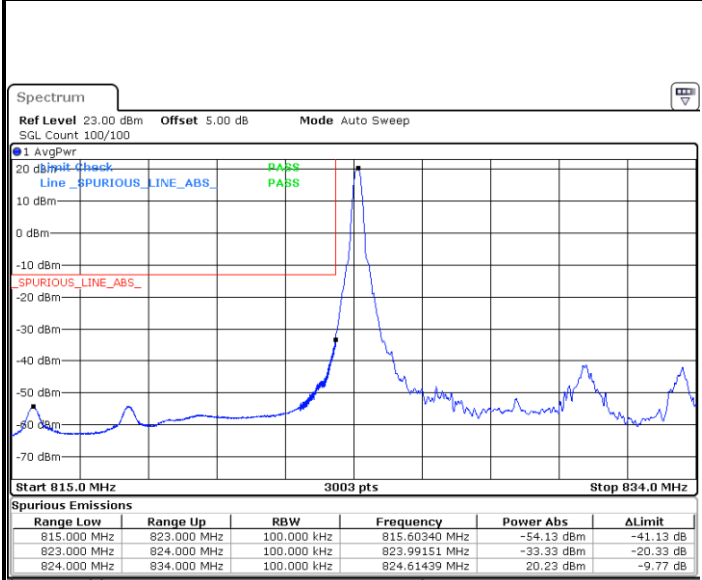

Date: 13.MAR.2021 04:05:26

Highest Band Edge / 1 RB

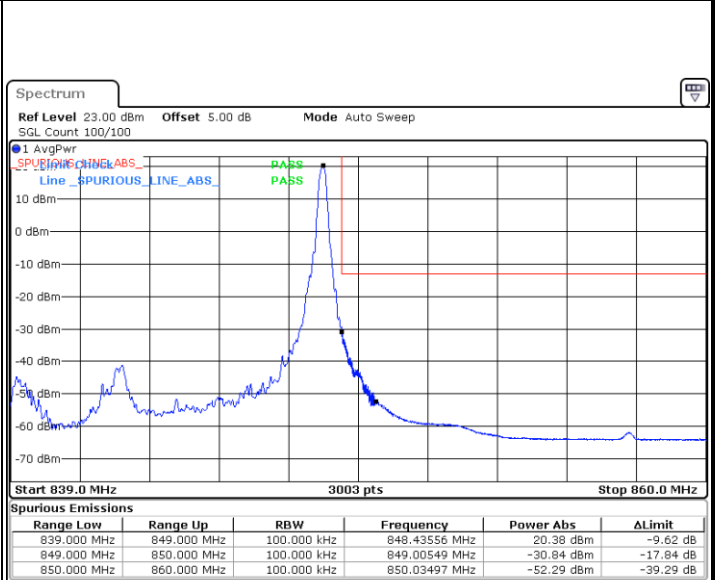

Date: 13.MAR.2021 04:20:32

Lowest Band Edge / Full RB

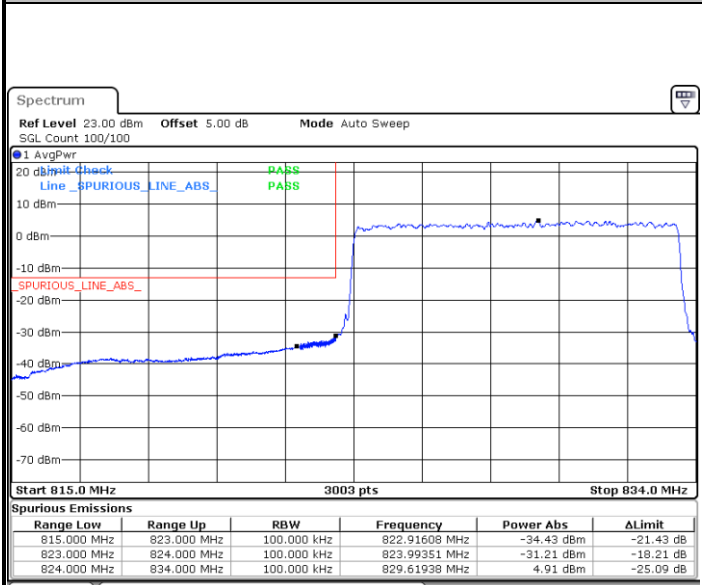

Date: 13.MAR.2021 04:15:14

Highest Band Edge / Full RB

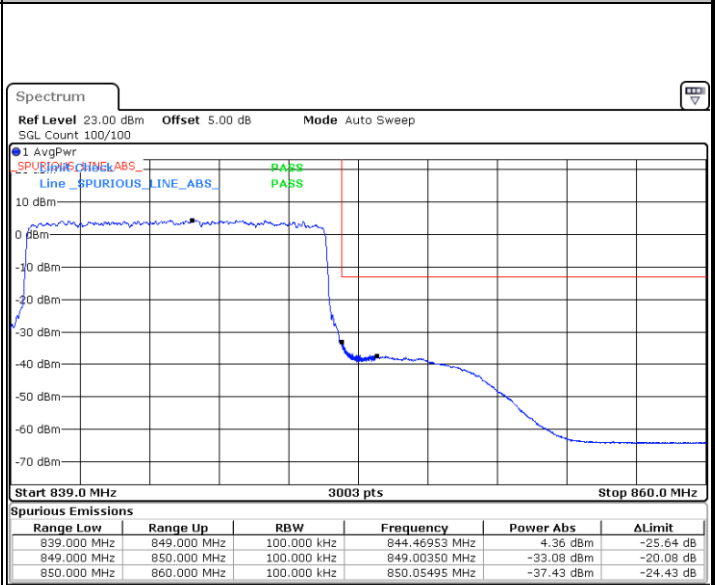

Date: 13.MAR.2021 04:15:57



LTE Band 5 / 10MHz / 16QAM

Lowest Band Edge / 1 RB

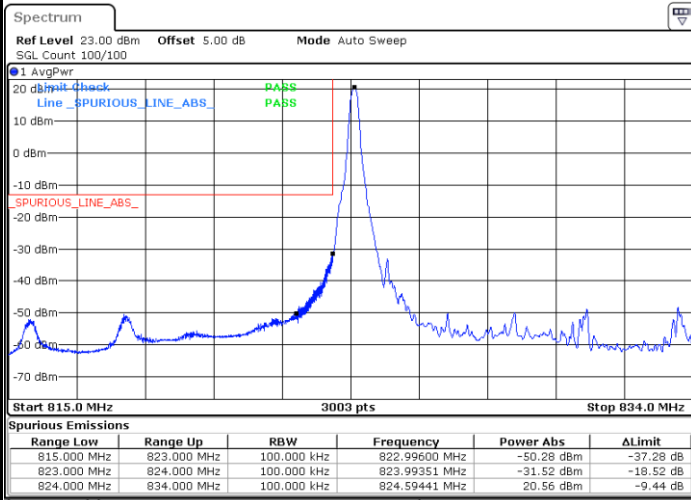

Date: 13.MAR.2021 04:06:10

Highest Band Edge / 1 RB

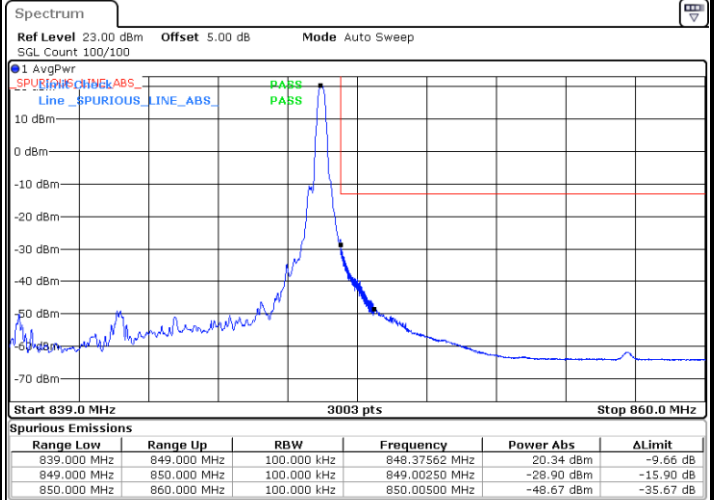

Date: 13.MAR.2021 04:18:44

Lowest Band Edge / Full RB

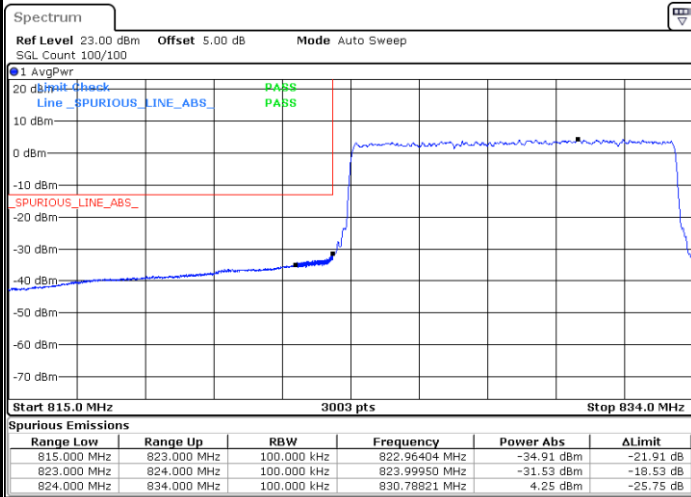

Date: 13.MAR.2021 04:14:34

Highest Band Edge / Full RB

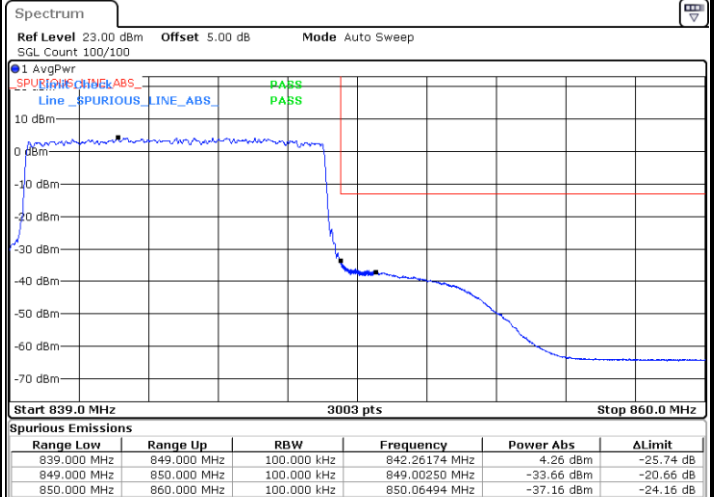

Date: 13.MAR.2021 04:16:38



LTE Band 5 / 10MHz / 64QAM

Lowest Band Edge / 1 RB

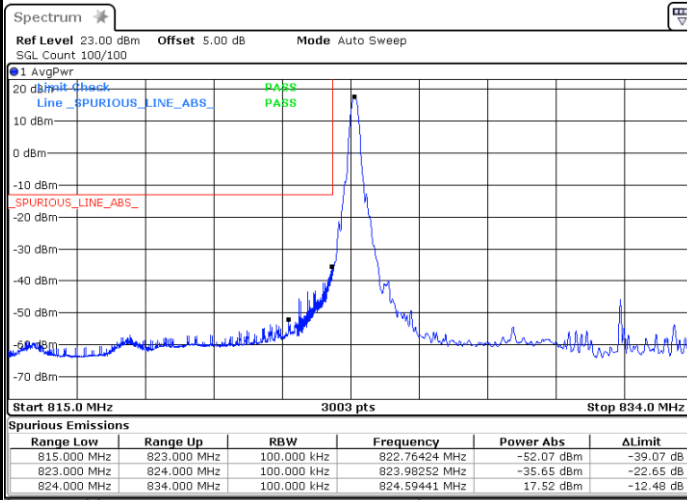

Date: 13.MAR.2021 04:10:42

Highest Band Edge / 1 RB

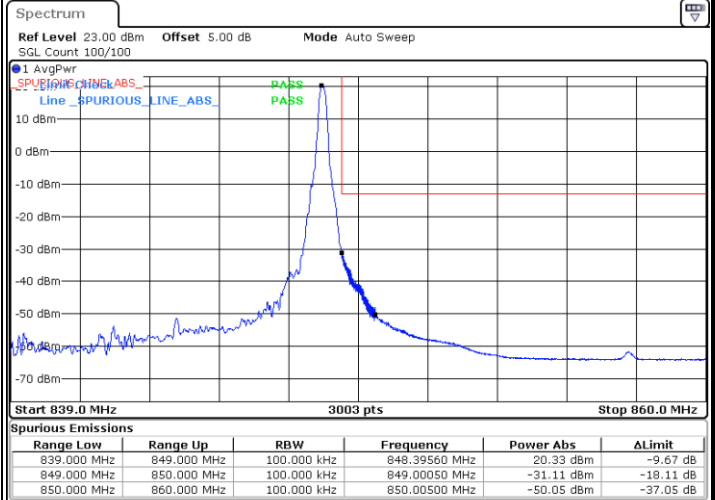

Date: 13.MAR.2021 04:19:24

Lowest Band Edge / Full RB

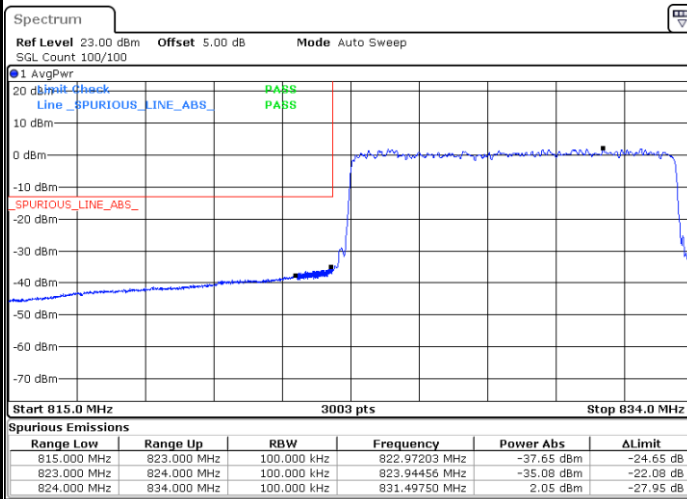

Date: 13.MAR.2021 04:13:34

Highest Band Edge / Full RB

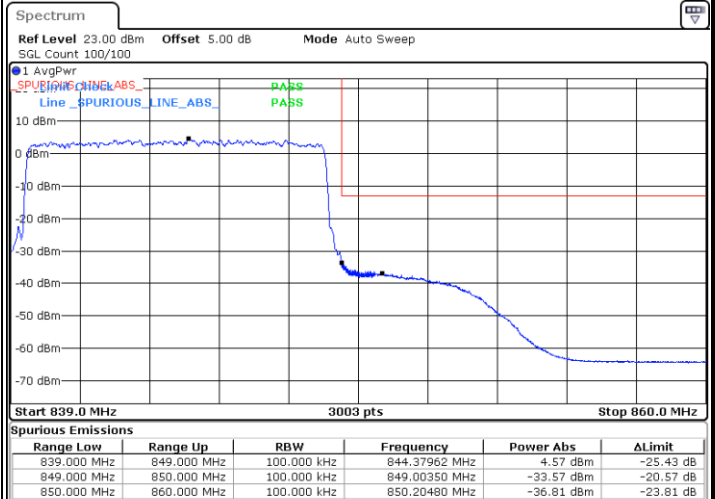

Date: 13.MAR.2021 04:17:15



Conducted Spurious Emission

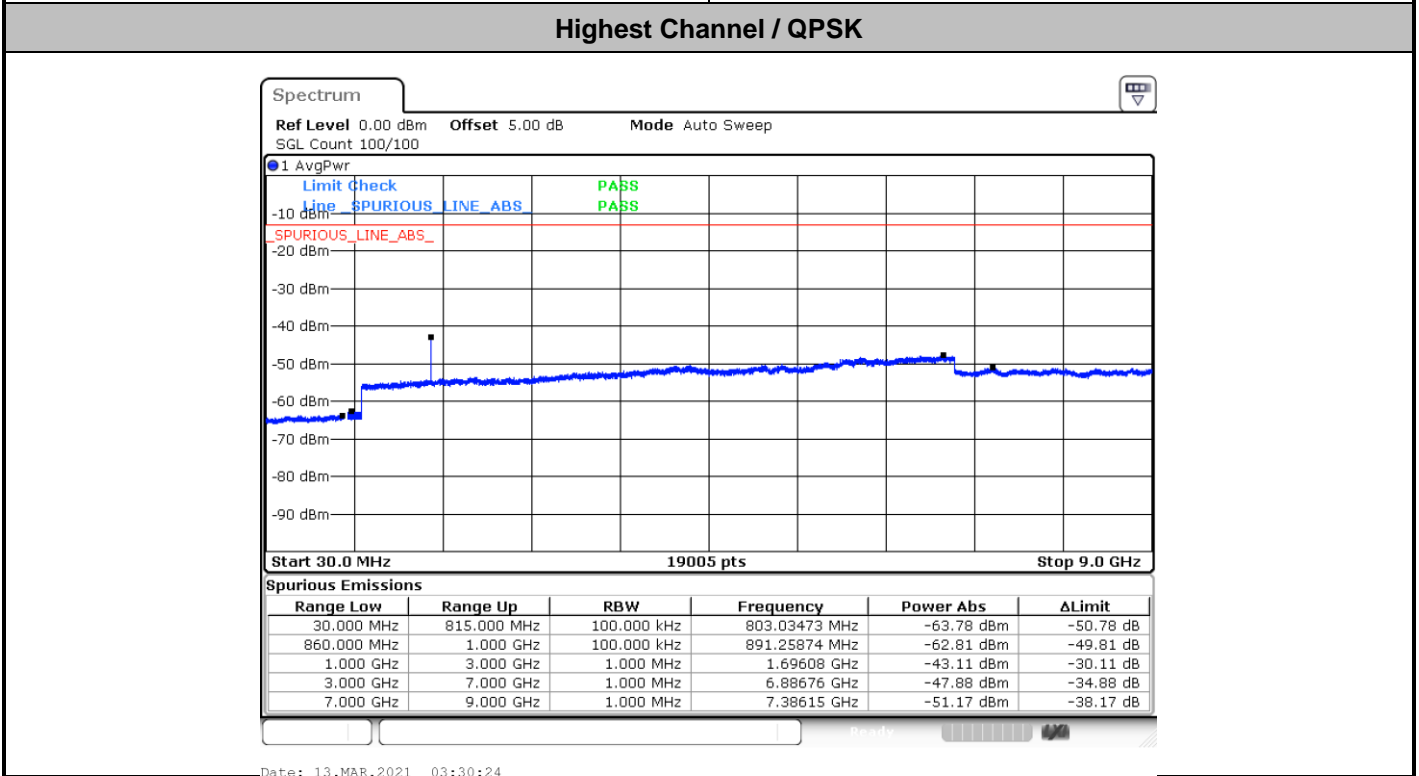
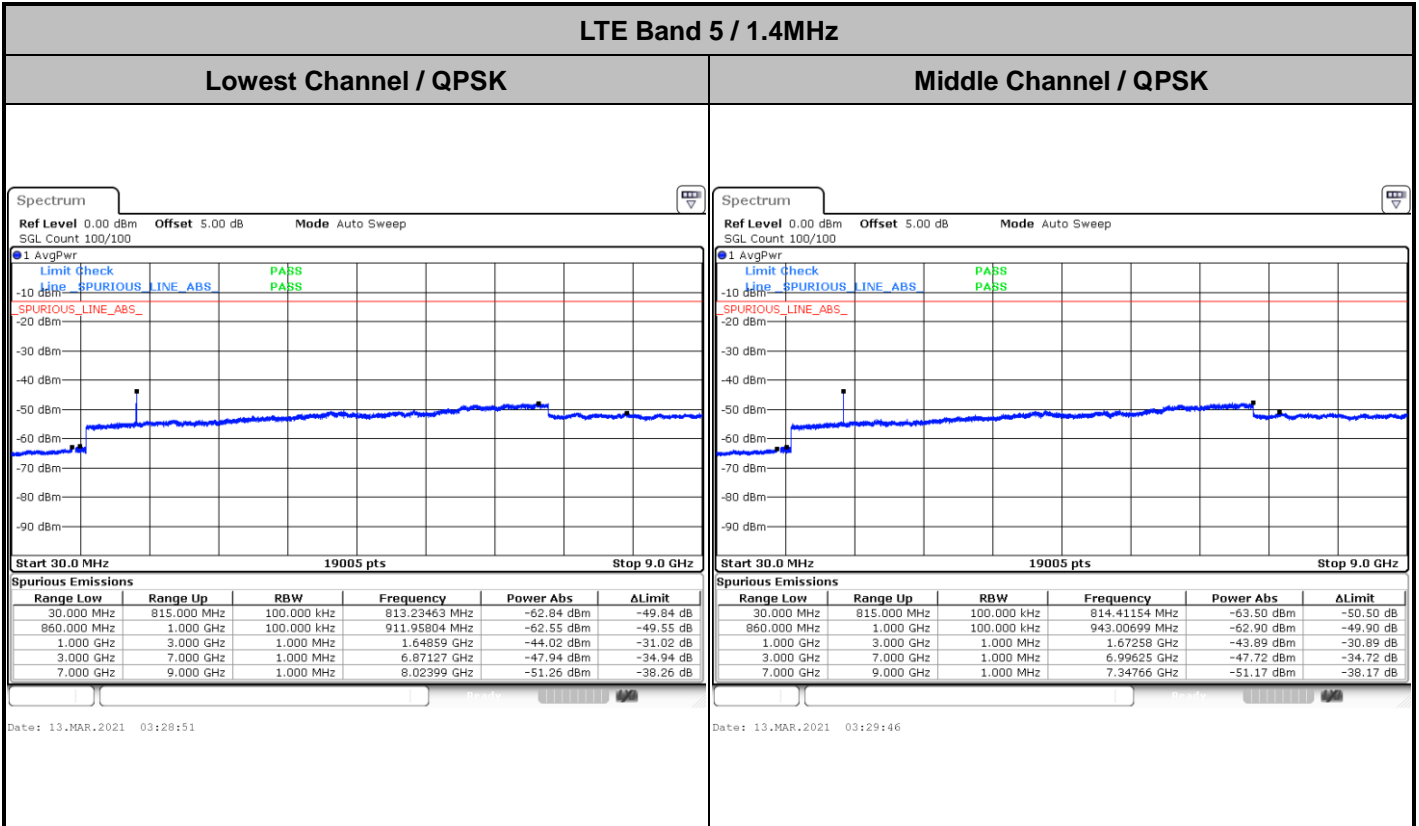



LTE Band 5 / 3MHz

Lowest Channel / QPSK

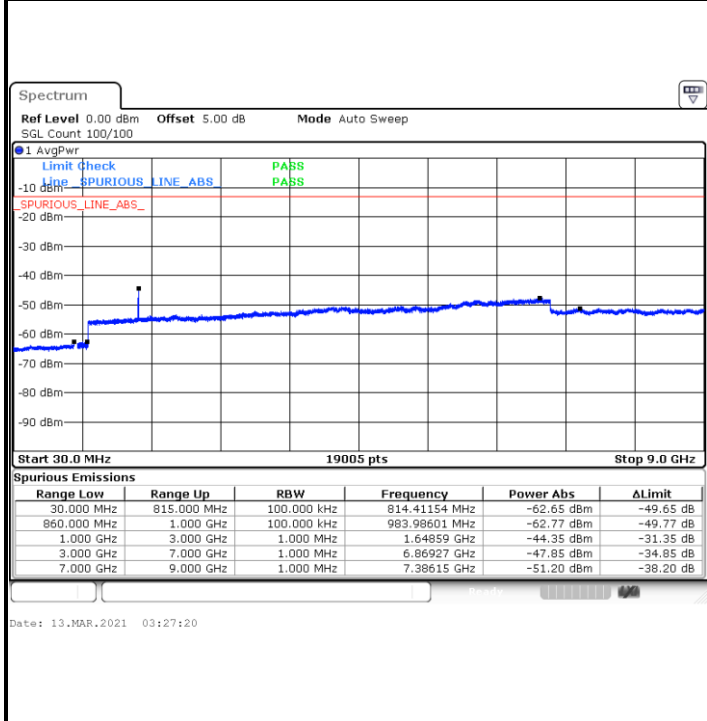

Middle Channel / QPSK

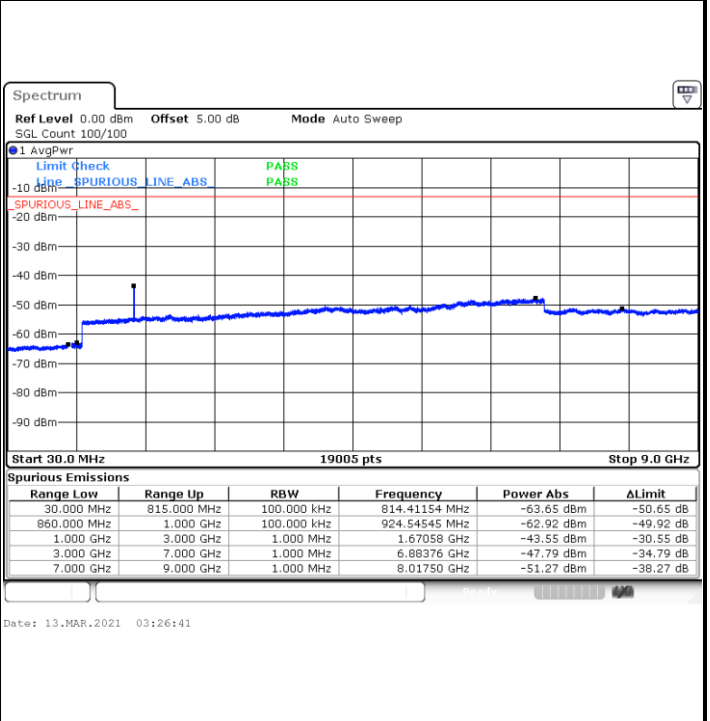

Highest Channel / QPSK

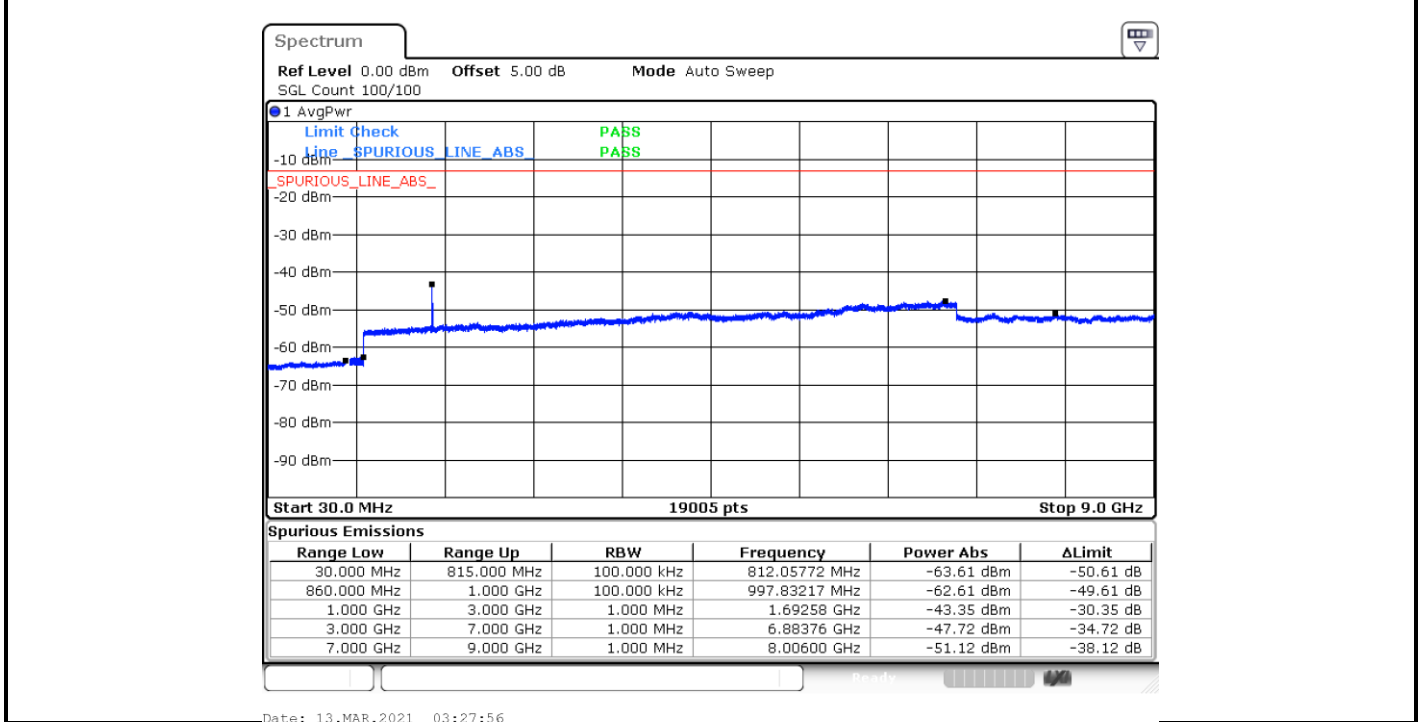



LTE Band 5 / 5MHz

Lowest Channel / QPSK

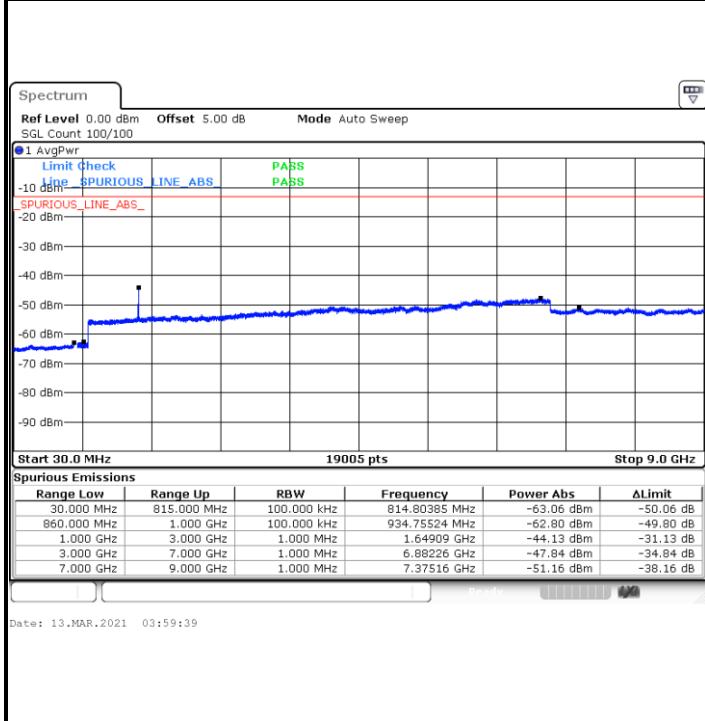

Middle Channel / QPSK

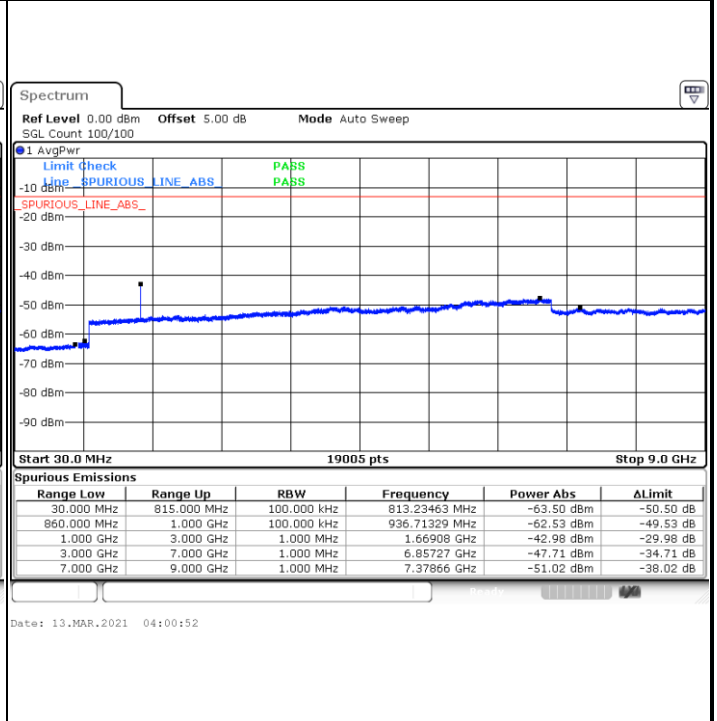

Highest Channel / QPSK

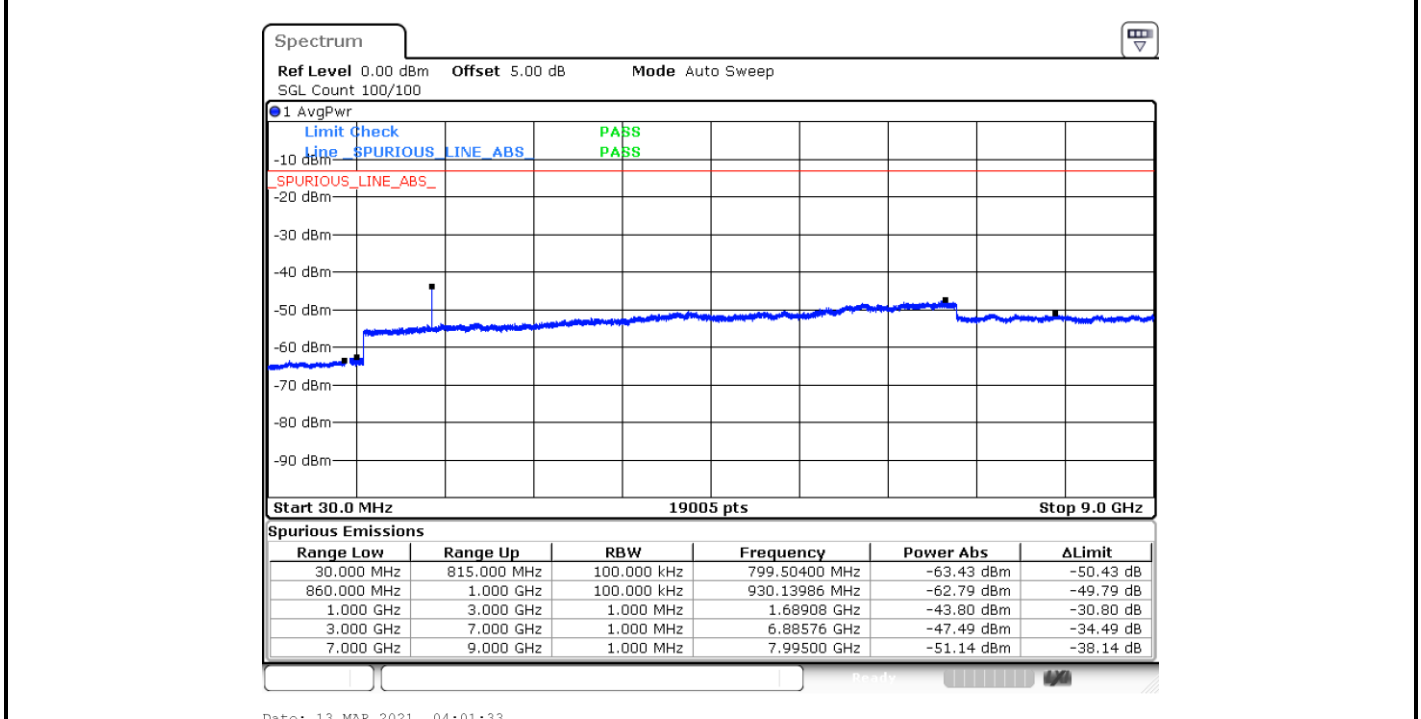



LTE Band 5 / 10MHz

Lowest Channel / QPSK

Middle Channel / QPSK

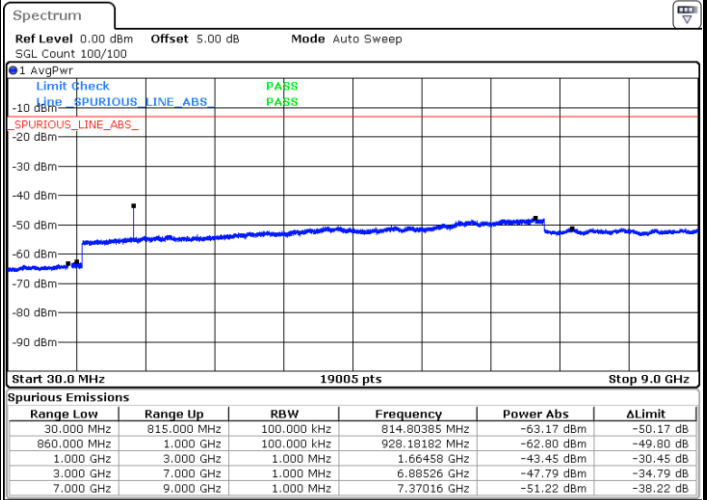
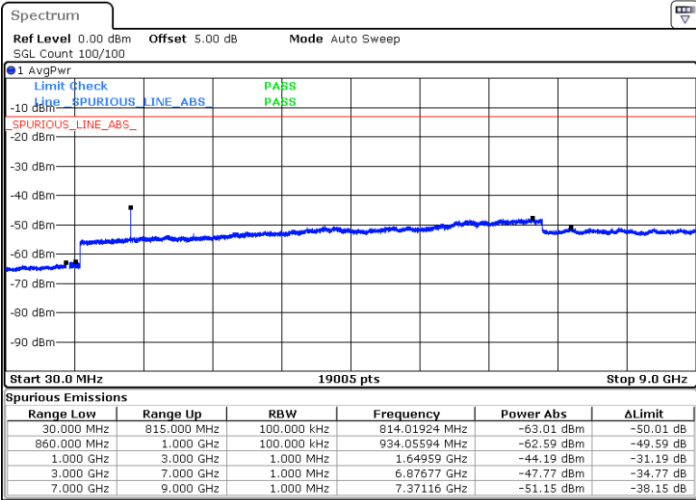

Date: 13.MAR.2021 04:02:55

Date: 13.MAR.2021 04:03:36

Highest Channel / QPSK

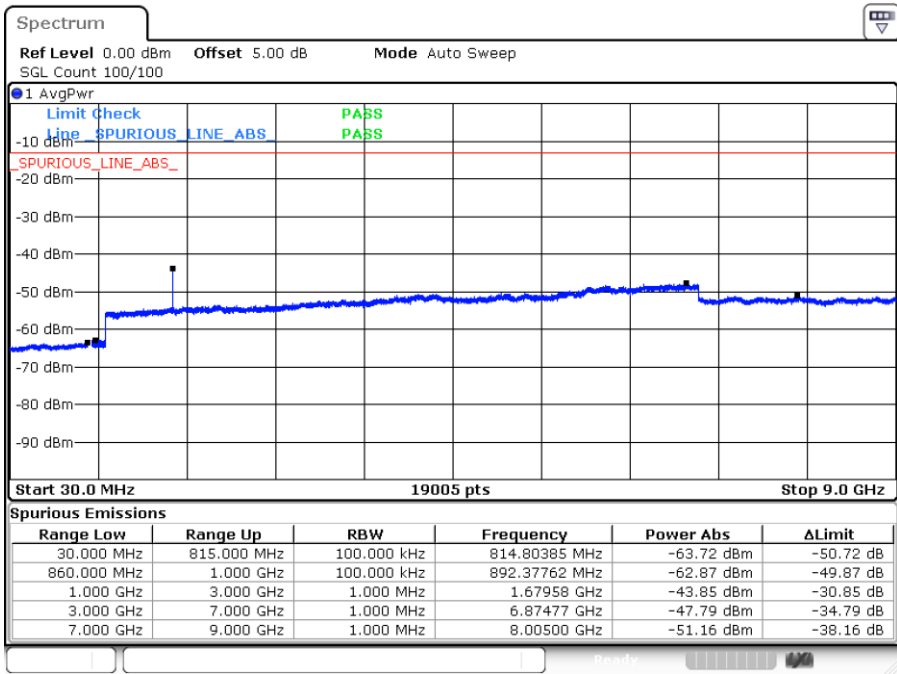

Date: 13.MAR.2021 04:04:16



Frequency Stability

Test Conditions		LTE Band 5 (QPSK) / Middle Channel	Limit
Temperature (°C)	Voltage (Volt)	BW 10MHz	Note 2.
		Deviation (ppm)	Result
50	Normal Voltage	0.0015	PASS
40	Normal Voltage	0.0026	
30	Normal Voltage	0.0014	
20(Ref.)	Normal Voltage	0.0000	
10	Normal Voltage	0.0003	
0	Normal Voltage	0.0012	
-10	Normal Voltage	0.0034	
-20	Normal Voltage	0.0046	
-30	Normal Voltage	0.0037	
20	Maximum Voltage	0.0008	
20	Normal Voltage	0.0012	
20	Battery End Point	0.0004	

Note:

1. Normal Voltage =3.8 V. ; Battery End Point (BEP) =3.4 V. ; Maximum Voltage =4.4V.
2. Note: The frequency fundamental emissions stay within the authorized frequency block.



LTE Band 7

Peak-to-Average Ratio

Mode	LTE Band 7 / 20MHz			
Mod.	QPSK	16QAM	64QAM	Limit: 13dB
RB Size	Full RB	Full RB	Full RB	Result
Middle CH	4.90	5.91	5.88	PASS

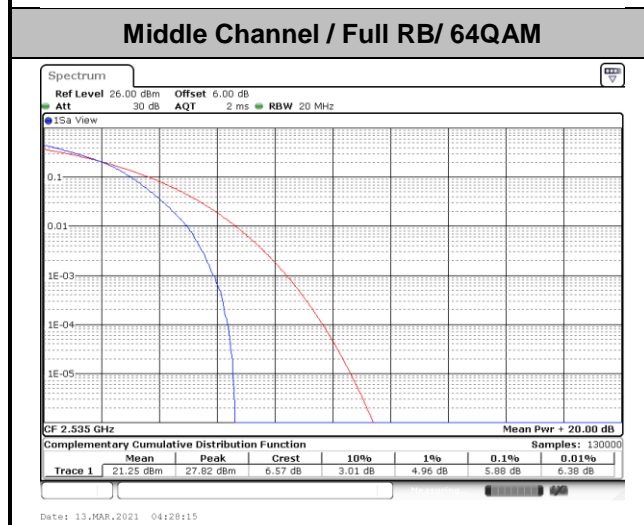
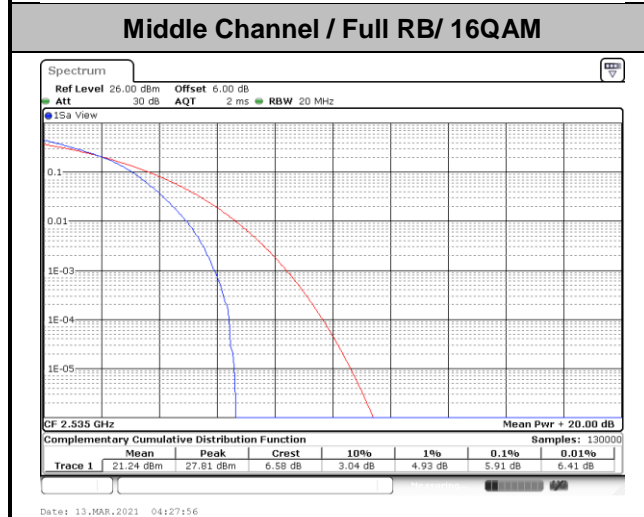
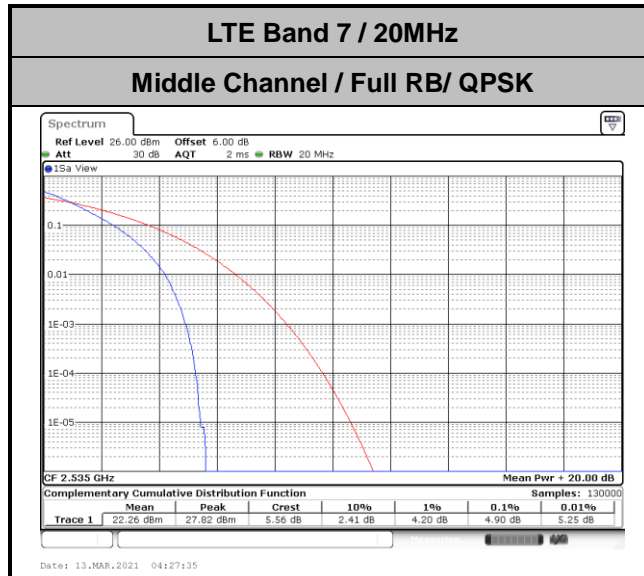



26dB Bandwidth

Mode	LTE Band 7 : 26dB BW(MHz)	
BW	20MHz	
Mod.	QPSK	16QAM
Middle CH	19.34	19.14

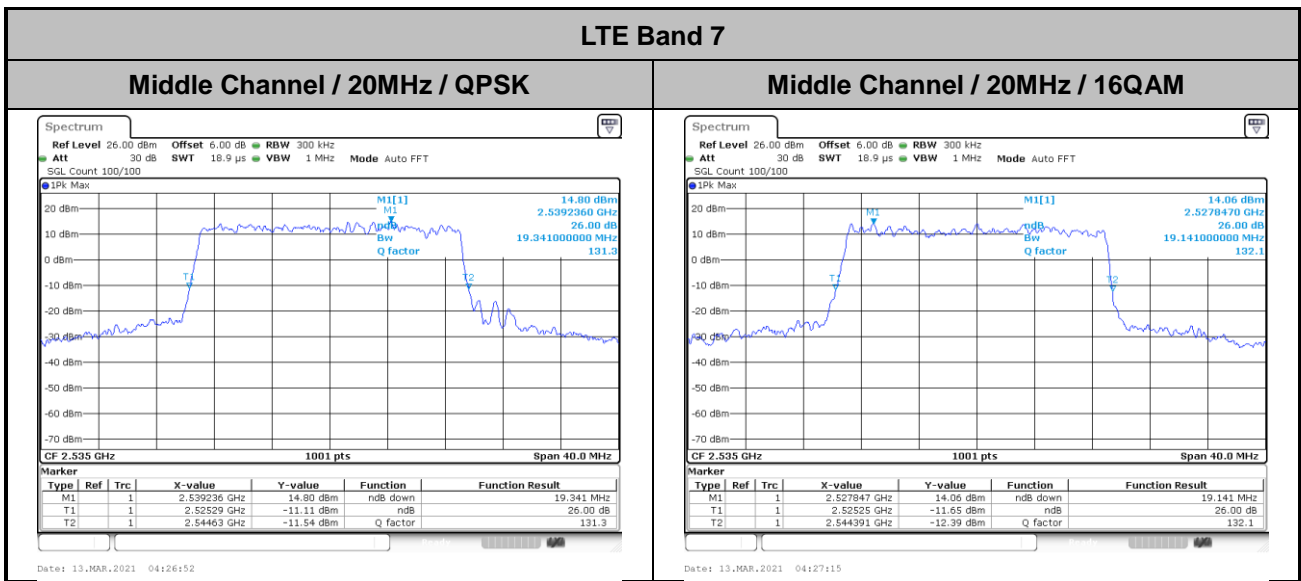



Occupied Bandwidth

Mode	LTE Band 7 : 99%OBW(MHz)	
BW	20MHz	
Mod.	QPSK	16QAM
Middle CH	17.90	17.86

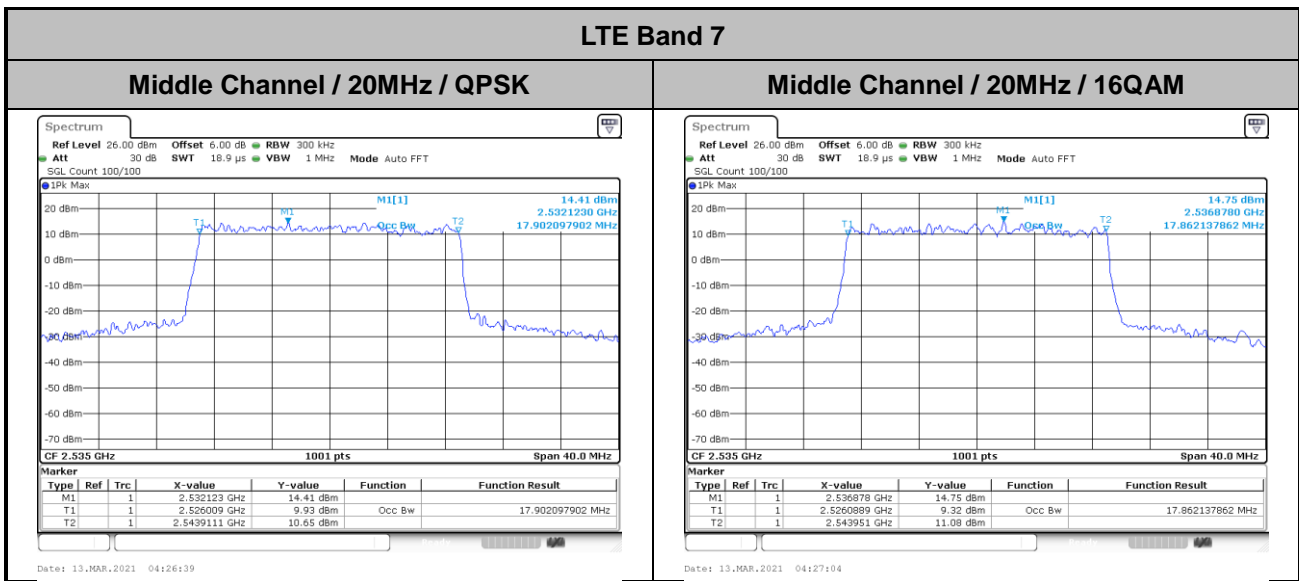



Conducted Band Edge

LTE Band 7 / 5MHz / QPSK

Lowest Band Edge / 1 RB

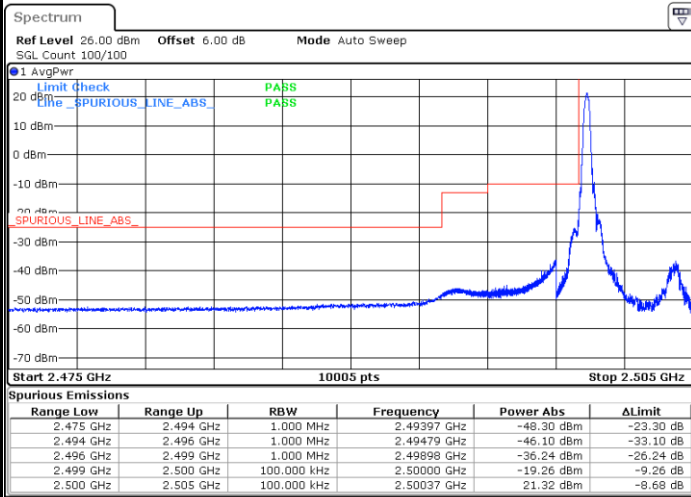

Date: 13.MAR.2021 05:21:40

Highest Band Edge / 1 RB

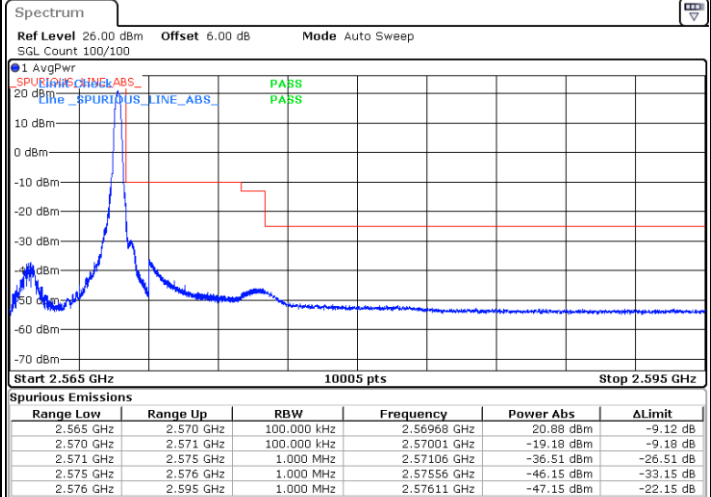

Date: 22 APR 2021 11:46:41

Lowest Band Edge / Full RB

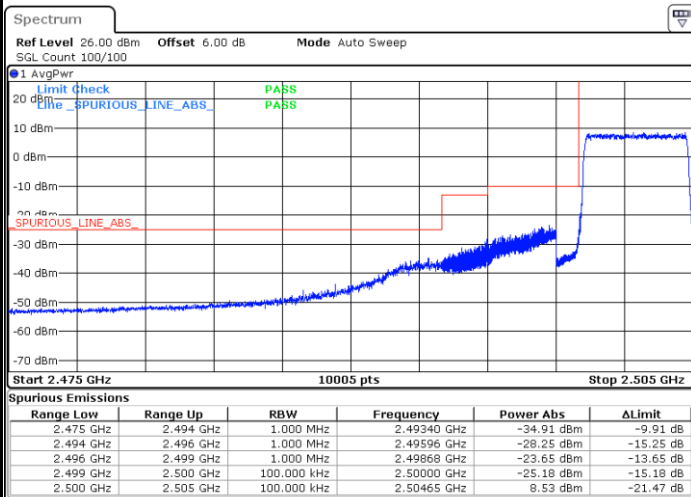

Date: 13.MAR.2021 05:19:01

Highest Band Edge / Full RB

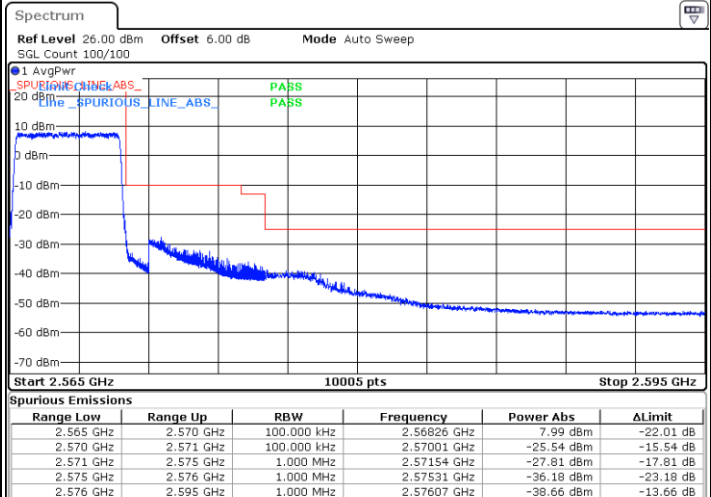

Date: 13.MAR.2021 05:18:29



LTE Band 7 / 5MHz / 16QAM

Lowest Band Edge / 1RB

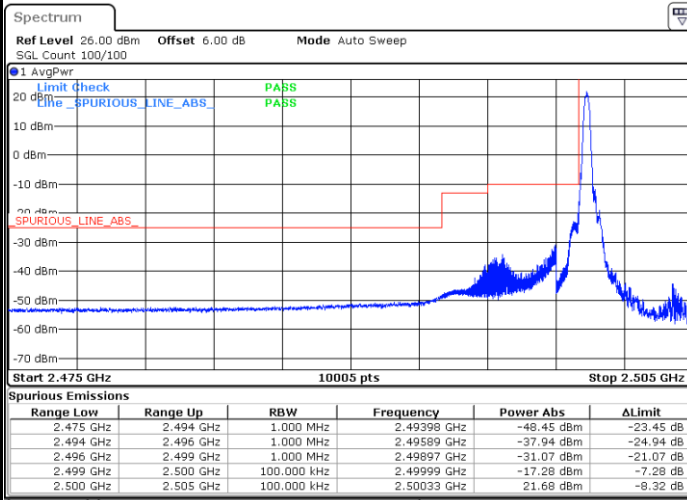

Date: 13.MAR.2021 05:21:23

Highest Band Edge / 1 RB

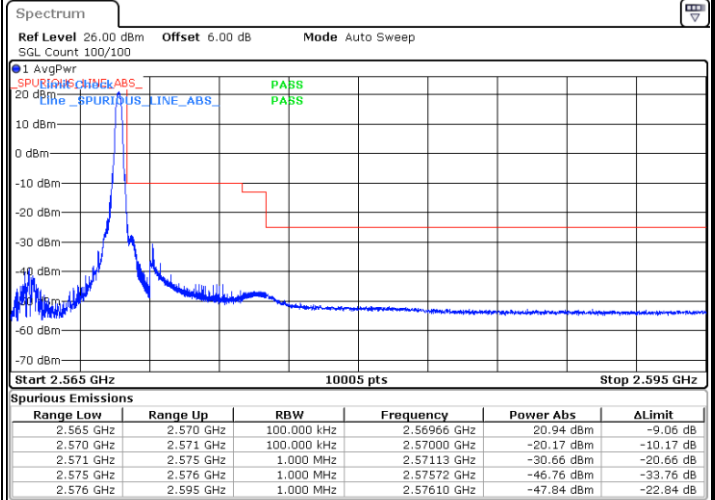

Date: 22 APR 2021 11:47:09

Lowest Band Edge / Full RB

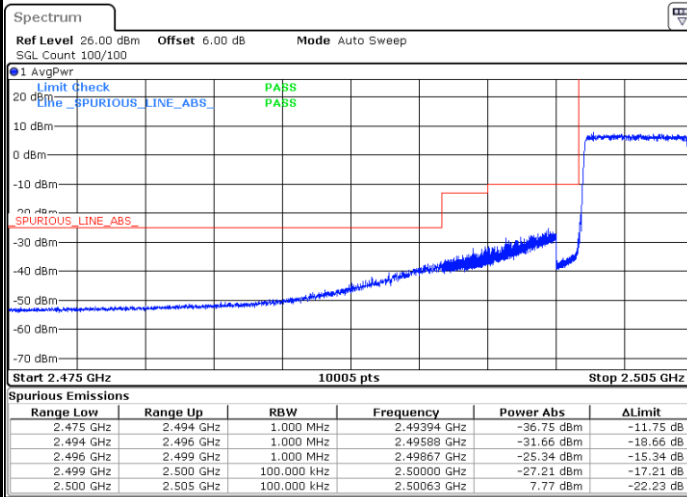

Date: 13.MAR.2021 05:19:26

Highest Band Edge / Full RB

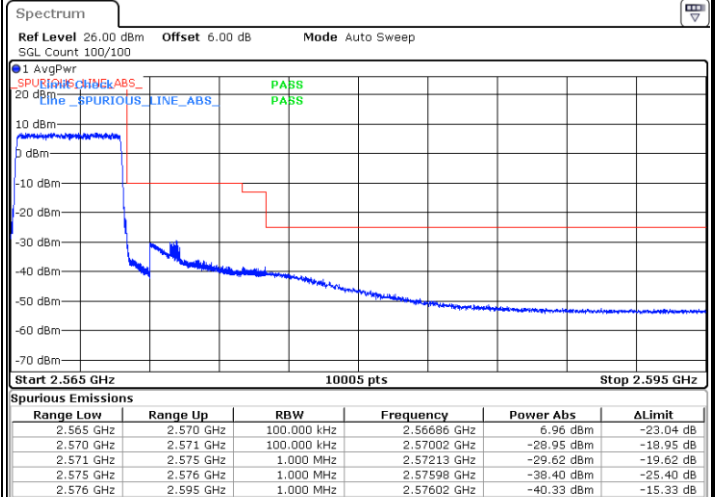

Date: 13.MAR.2021 05:17:43



LTE Band 7 / 5MHz / 64QAM

Lowest Band Edge / 1RB

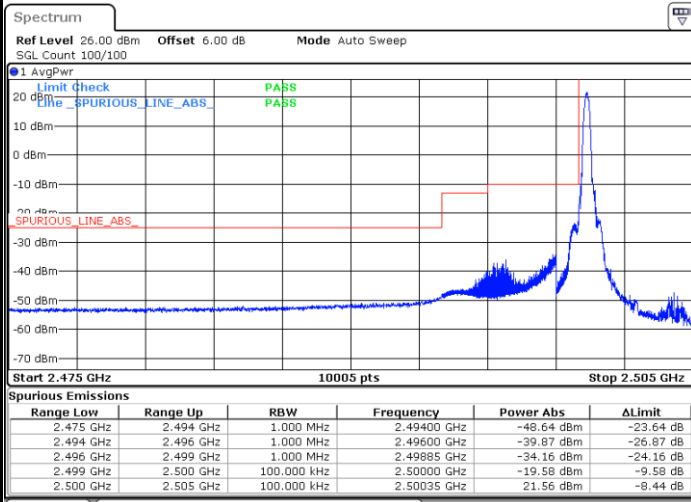

Date: 13.MAR.2021 05:20:44

Highest Band Edge / 1 RB

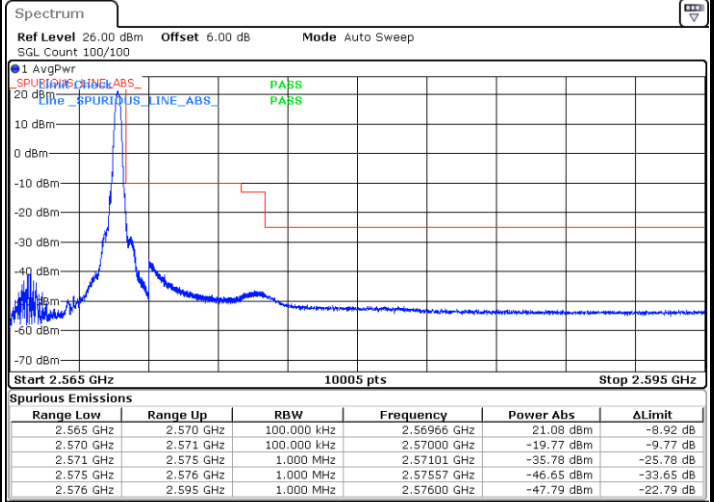

Date: 22 APR 2021 11:47:26

Lowest Band Edge / Full RB

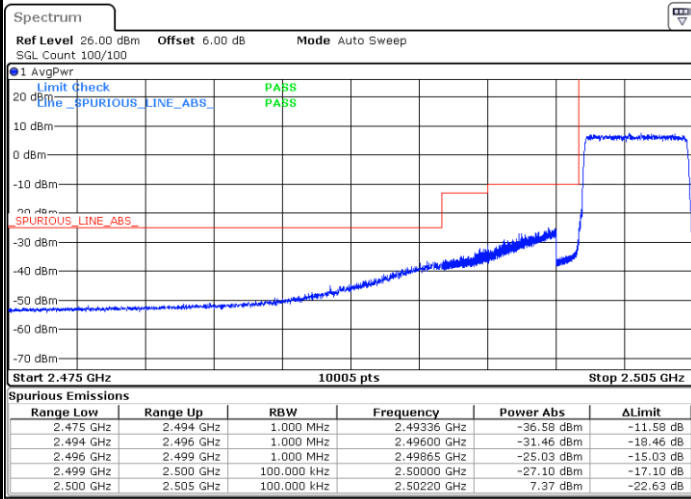

Date: 13.MAR.2021 05:20:00

Highest Band Edge / Full RB

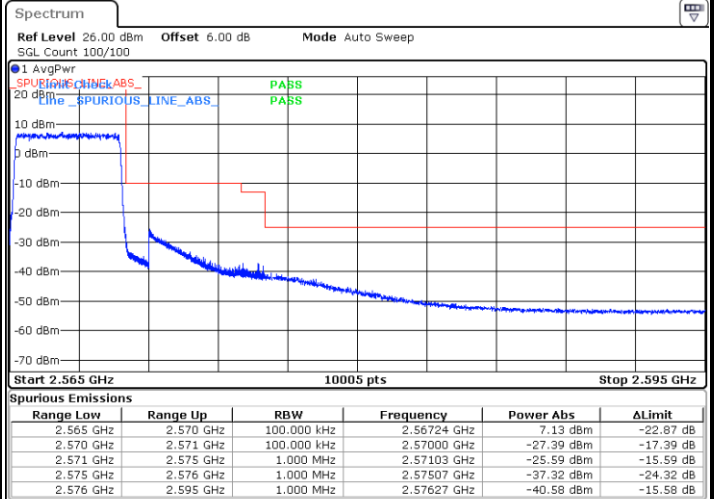

Date: 13.MAR.2021 05:17:06



LTE Band 7 / 10MHz / QPSK

Lowest Band Edge / 1 RB

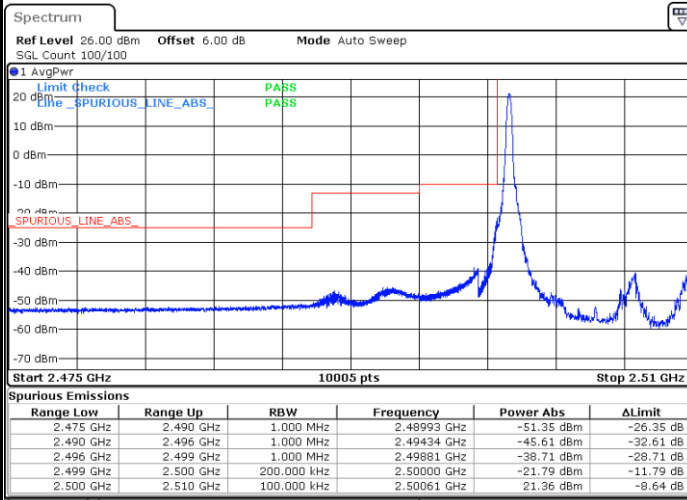

Date: 13.MAR.2021 05:04:45

Highest Band Edge / 1 RB

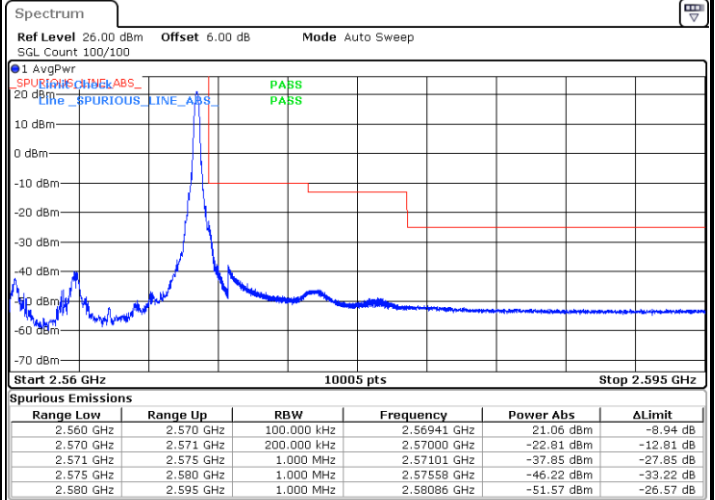

Date: 13.MAR.2021 05:14:03

Lowest Band Edge / Full RB

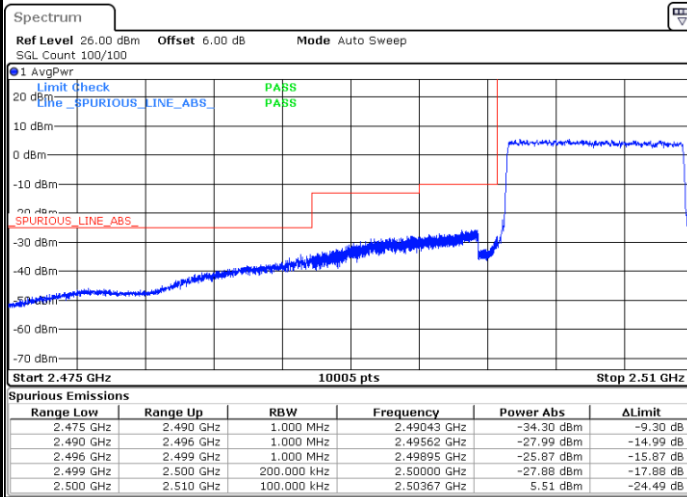

Date: 13.MAR.2021 05:09:03

Highest Band Edge / Full RB

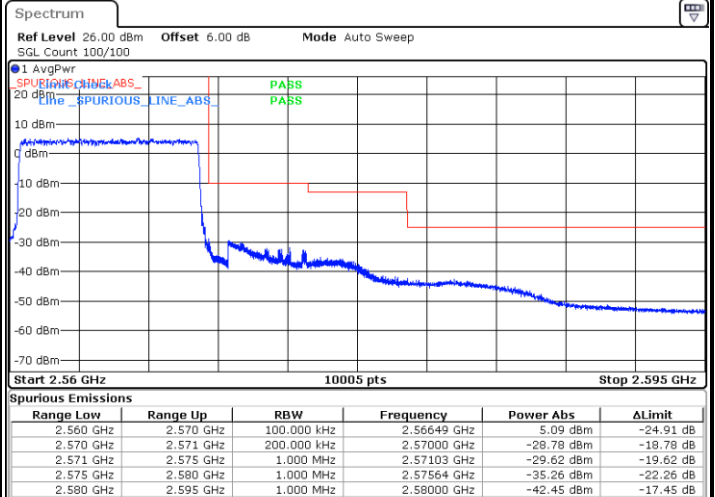

Date: 13.MAR.2021 05:11:11



LTE Band 7 / 10MHz / 16QAM

Lowest Band Edge / 1 RB

Highest Band Edge / 1 RB

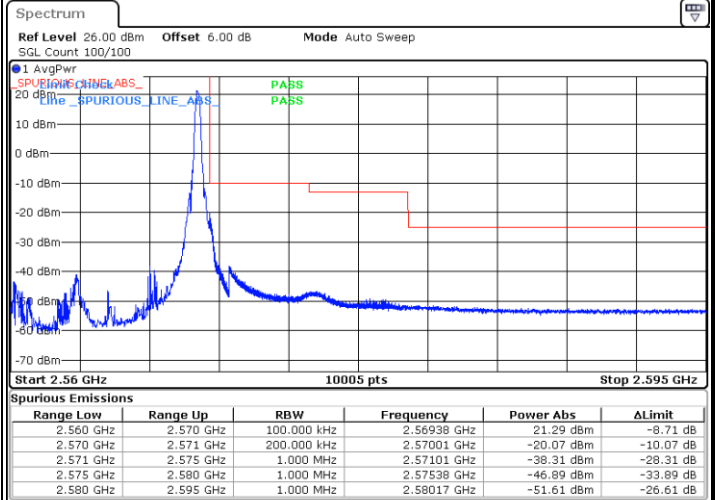
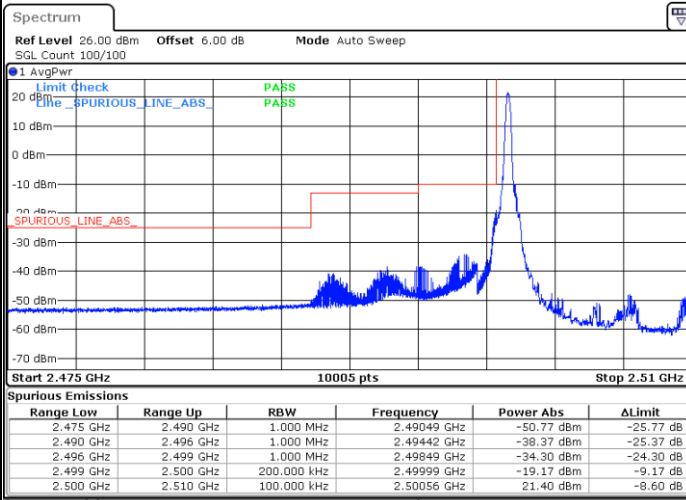

Date: 13.MAR.2021 05:05:43

Date: 13.MAR.2021 05:13:47

Lowest Band Edge / Full RB

Highest Band Edge / Full RB

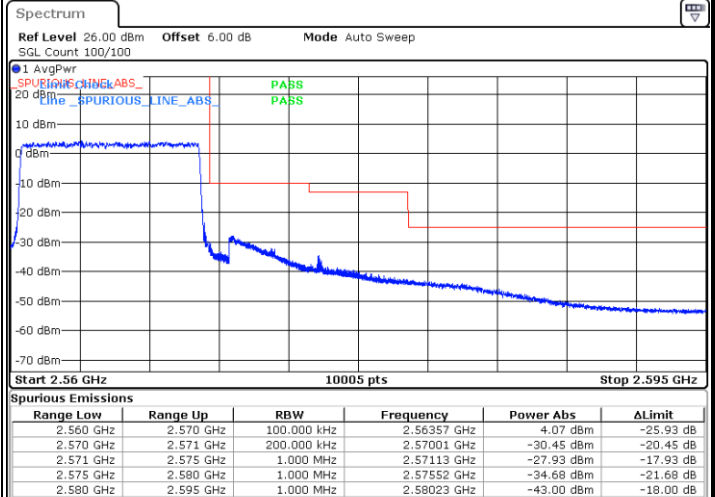
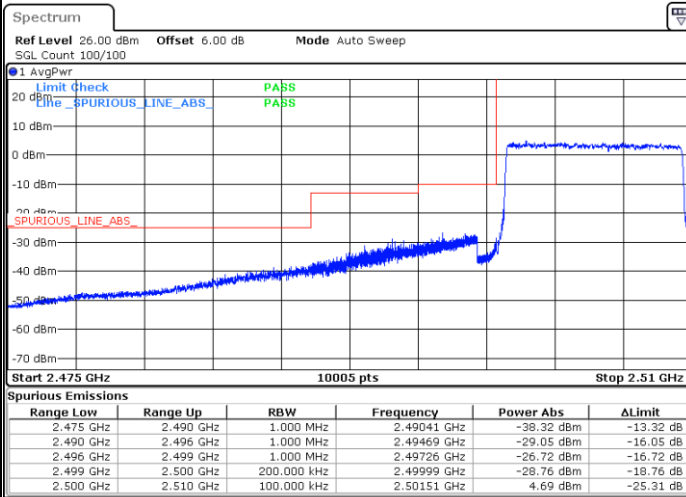

Date: 13.MAR.2021 05:07:38

Date: 13.MAR.2021 05:10:39