



FCC RF Test Report

APPLICANT : Motorola Mobility LLC
EQUIPMENT : Mobile Cellular Phone
BRAND NAME : Motorola
MODEL NAME : XT2113-1, XT2113-1PP
FCC ID : IHDT56ZF3
STANDARD : 47 CFR Part 2, 24(E), 27(L)
CLASSIFICATION : PCS Licensed Transmitter Held to Ear (PCE)

The product was received on Mar. 08, 2021 and completely tested on Mar. 27, 2021. We, Sporton International (Kunshan) Inc., would like to declare that the tested sample has been evaluated in accordance with the procedures given in ANSI C63.26-2015 and shown compliance with the applicable technical standards.

The test results in this report apply exclusively to the tested model / sample. Without written approval of Sporton International (Kunshan) Inc., the test report shall not be reproduced except in full.

Jason Jia

Reviewed by: Jason Jia / Supervisor

Alex Wang

Approved by: Alex Wang / Manager



Sporton International (Kunshan) Inc.

No. 1098, Pengxi North Road, Kunshan Economic Development Zone Jiangsu Province 215300
People's Republic of China



TABLE OF CONTENTS

REVISION HISTORY... 3
SUMMARY OF TEST RESULT ... 4
1 GENERAL DESCRIPTION ... 5
1.1 Applicant ... 5
1.2 Manufacturer ... 5
1.3 Product Feature of Equipment Under Test ... 5
1.4 Product Specification of Equipment Under Test ... 6
1.5 Specification of Accessory ... 6
1.6 Modification of EUT ... 6
1.7 Maximum EIRP, Frequency Tolerance, and Emission Designator ... 7
1.8 Testing Location ... 8
1.9 Test Software ... 8
1.10 Applicable Standards ... 8
2 TEST CONFIGURATION OF EQUIPMENT UNDER TEST ... 9
2.1 Test Mode ... 9
2.2 Connection Diagram of Test System ... 11
2.3 Support Unit used in test configuration and system ... 11
2.4 Measurement Results Explanation Example ... 12
2.5 Frequency List of Low/Middle/High Channels ... 12
3 CONDUCTED TEST ITEMS ... 16
3.1 Measuring Instruments ... 16
3.2 Test Setup ... 16
3.3 Test Result of Conducted Test ... 16
3.4 Conducted Output Power and EIRP ... 17
3.5 Peak-to-Average Ratio ... 18
3.6 Occupied Bandwidth ... 19
3.7 Conducted Band Edge ... 20
3.8 Conducted Spurious Emission ... 21
3.9 Frequency Stability ... 22
4 RADIATED TEST ITEMS ... 23
4.1 Measuring Instruments ... 23
4.2 Test Setup ... 23
4.3 Test Result of Radiated Test ... 23
4.4 Radiated Spurious Emission ... 24
5 LIST OF MEASURING EQUIPMENT ... 25
6 UNCERTAINTY OF EVALUATION ... 26
APPENDIX A. TEST RESULTS OF CONDUCTED TEST
APPENDIX B. TEST RESULTS OF RADIATED TEST
APPENDIX C. TEST SETUP PHOTOGRAPHS



REVISION HISTORY

REPORT NO.	VERSION	DESCRIPTION	ISSUED DATE
FG082402-06B	Rev. 01	Initial issue of report	Apr. 22, 2021



SUMMARY OF TEST RESULT

Report Section	FCC Rule	Description	Limit	Result	Remark
3.4	§2.1046	Conducted Output Power	Reporting Only	PASS	-
	§24.232(c)	Equivalent Isotropic Radiated Power (Band 2)	EIRP < 2Watt	PASS	-
	§27.50(d)(4)	Equivalent Isotropic Radiated Power (Band 4) (Band 66)	EIRP < 1Watt	PASS	-
3.5	§24.232(d)	Peak-to-Average Ratio	<13 dB	PASS	-
3.6	§2.1049	Occupied Bandwidth	Reporting Only	PASS	-
3.7	§2.1051 §24.238(a) §27.53(h)	Conducted Band Edge Measurement (Band 2) (Band 4) (Band 66)	< 43+10log ₁₀ (P[Watts])	PASS	-
3.8	§2.1051 §24.238(a) §27.53(h)	Conducted Spurious Emission (Band 2) (Band 4) (Band 66)	< 43+10log ₁₀ (P[Watts])	PASS	-
3.9	§2.1055 §24.235 §27.54	Frequency Stability Temperature & Voltage	Within Authorized Band	PASS	-
4.4	§2.1053 §24.238(a) §27.53(h)	Radiated Spurious Emission (Band 2) (Band 4) (Band 66)	< 43+10log ₁₀ (P[Watts])	PASS	Under limit 30.82 dB at 8676.000 MHz

Declaration of Conformity:

The test results with all measurement uncertainty excluded are presented in accordance with the regulation limits or requirements declared by manufacturers.

Comments and Explanations:

The declared of product specification for EUT presented in the report are provided by the manufacturer, and the manufacturer takes all the responsibilities for the accuracy of product specification.



1 General Description

1.1 Applicant

Motorola Mobility LLC
222 W,Merchandise Mart Plaza, Chicago IL 60654 USA

1.2 Manufacturer

Motorola Mobility LLC
222 W,Merchandise Mart Plaza, Chicago IL 60654 USA

1.3 Product Feature of Equipment Under Test

Product Feature	
Equipment	Mobile Cellular Phone
Brand Name	Motorola
Model Name	XT2113-1, XT2113-1PP
FCC ID	IHDT56ZF3
EUT supports Radios application	GSM/WCDMA/LTE/5G NR/NFC WLAN 2.4GHz 802.11b/g/n HT20 WLAN 5GHz 802.11a/n HT20/HT40 WLAN 5GHz 802.11ac VHT20/VHT40/VHT80 Bluetooth BR/EDR/LE FM Receiver and GNSS
IMEI Code	Conducted: 35688110009114 Radiation: 868869050005346
HW Version	DVT2
SW Version	RRV31.Q2-20
EUT Stage	Identical Prototype

1.4 Product Specification of Equipment Under Test

Standards-related Product Specification	
Tx Frequency	LTE Band 2 : 1850 MHz ~ 1910 MHz LTE Band 4 : 1710 MHz ~ 1755 MHz LTE Band 66 : 1710 MHz ~ 1780 MHz
Rx Frequency	LTE Band 2 : 1930 MHz ~ 1990 MHz LTE Band 4 : 2110 MHz ~ 2155 MHz LTE Band 66 : 2110 MHz~ 2200 MHz
Bandwidth	LTE Band 2 : 1.4MHz / 3MHz / 5MHz / 10MHz / 15MHz / 20MHz LTE Band 4 : 1.4MHz / 3MHz / 5MHz / 10MHz / 15MHz / 20MHz LTE Band 66 : 1.4MHz / 3MHz / 5MHz / 10MHz / 15MHz / 20MHz
Maximum Output Power to Antenna	Ant. 1: LTE Band 2 : 23.51 dBm LTE Band 4 : 23.33 dBm LTE Band 66 : 23.35 dBm LTE Band 66B_CA : 23.01 dBm LTE Band 66C_CA : 23.22 dBm Ant. 2: LTE Band 2 : 21.89 dBm LTE Band 4 : 21.99 dBm LTE Band 66 : 22.06 dBm LTE Band 66B_CA : 21.66 dBm
Antenna Gain	Ant. 1/ Ant. 2: LTE Band 2 : -2.2 dBi LTE Band 4 : -1.9 dBi LTE Band 66 : -1.9 dBi
Type of Modulation	QPSK / 16QAM / 64QAM

Note: The Maximum EIRP is calculated from Max Output power and Max antenna gain, only the maximum EIRP of Ant. 1 is shown on the report

1.5 Specification of Accessory

Specification of Accessory				
AC Adapter	Brand Name	Motorola (Chenyang)	Model Name	MC-201
Battery	Brand Name	Motorola (Amperex)	Model Name	MK50
USB Cable 1	Brand Name	Motorola (Saibao)	Model Name	SC18C24367
USB Cable 2	Brand Name	Motorola (Luxshare)	Model Name	SC18C24368
USB Cable 3	Brand Name	Motorola (I SHENG)	Model Name	SC18C28955

1.6 Modification of EUT

No modifications are made to the EUT during all test items.



1.7 Maximum EIRP, Frequency Tolerance, and Emission Designator

LTE Band 2		QPSK			16QAM		
BW (MHz)	Frequency Range (MHz)	Emission Designator (99%OBW)	Frequency Tolerance (ppm)	Maximum EIRP(W)	Emission Designator (99%OBW)	Frequency Tolerance (ppm)	Maximum EIRP(W)
20	1860.0 ~ 1900.0	18M5G7D	0.0018	0.1352	18M4W7D	-	0.1099
LTE Band 4		QPSK			16QAM		
BW (MHz)	Frequency Range (MHz)	Emission Designator (99%OBW)	Frequency Tolerance (ppm)	Maximum EIRP(W)	Emission Designator (99%OBW)	Frequency Tolerance (ppm)	Maximum EIRP(W)
20	1720.0 ~ 1745.0	17M9G7D	0.0024	0.1390	17M9W7D	-	0.1130
LTE Band 66		QPSK			16QAM		
BW (MHz)	Frequency Range (MHz)	Emission Designator (99%OBW)	Frequency Tolerance (ppm)	Maximum EIRP(W)	Emission Designator (99%OBW)	Frequency Tolerance (ppm)	Maximum EIRP(W)
20	1720.0 ~ 1770.0	17M9G7D	0.0024	0.1396	17M9W7D	-	0.1245

LTE Band 66B_CA		QPSK			16QAM		
BW (MHz)		Emission Designator (99%OBW)	Frequency Tolerance (ppm)	Maximum EIRP(W)	Emission Designator (99%OBW)	Frequency Tolerance (ppm)	Maximum EIRP(W)
10MHz+10MHz		19M0G7D	-	0.1291	19M3W7D	-	0.1079
LTE Band 66C_CA		QPSK			16QAM		
BW (MHz)		Emission Designator (99%OBW)	Frequency Tolerance (ppm)	Maximum EIRP(W)	Emission Designator (99%OBW)	Frequency Tolerance (ppm)	Maximum EIRP(W)
20MHz+20MHz		37M6G7D	-	0.1355	37M6W7D	-	0.1159

Note:

1. LTE Band 66 overlaps the entire frequency range of LTE Band 4. Therefore, the test results provided in this report covers Band 66 as well as Band 4.
2. Based on engineering evaluation, only the maximum bandwidth and the worst modulation test results are shown in the report.



1.8 Testing Location

Sporton International (Kunshan) Inc. is accredited to ISO/IEC 17025:2017 by American Association for Laboratory Accreditation with Certificate Number 5145.02.

Test Firm	Sporton International (Kunshan) Inc.		
Test Site Location	No. 1098, Pengxi North Road, Kunshan Economic Development Zone Jiangsu Province 215300 People's Republic of China TEL : +86-512-57900158 FAX : +86-512-57900958		
Test Site No.	Sporton Site No.	FCC Designation No.	FCC Test Firm Registration No.
	03CH04-KS TH01-KS	CN1257	314309

1.9 Test Software

Item	Site	Manufacturer	Name	Version
1.	03CH04-KS	AUDIX	E3	6.2009-8-24a

1.10 Applicable Standards

According to the specifications of the manufacturer, the EUT must comply with the requirements of the following standards:

- ♦ 47 CFR Part 2, 24(E), 27(L)
- ♦ ANSI C63.26-2015
- ♦ FCC KDB 971168 D01 Power Meas License Digital Systems v03r01
- ♦ FCC KDB 412172 D01 Determining ERP and EIRP v01r01

Remark:

1. All test items were verified and recorded according to the standards and without any deviation during the test.
2. This EUT has also been tested and complied with the requirements of FCC Part 15, Subpart B, recorded in a separate test report.



2 Test Configuration of Equipment Under Test

2.1 Test Mode

Antenna port conducted and radiated test items listed below are performed according to KDB 971168 D01 Power Meas License Digital Systems v03r01 with maximum output power.

Radiated measurements are performed by rotating the EUT in three different orthogonal test planes to find the maximum emission.

Test Items	Band	Bandwidth (MHz)						Modulation			RB #			Test Channel			
		1.4	3	5	10	15	20	QPSK	16QAM	64QAM	1	Half	Full	L	M	H	
Max. Output Power	2	v	v	v	v	v	v	v	v	v	v	v	v	v	v	v	
	4	v	v	v	v	v	v	v	v	v	v	v	v	v	v	v	
	66	v	v	v	v	v	v	v	v	v	v	v	v	v	v	v	
Peak-to-Average Ratio	2						v	v	v	v			v		v		
	66						v	v	v	v			v		v		
26dB and 99% Bandwidth	2						v	v	v				v		v		
	66						v	v	v				v		v		
Conducted Band Edge	2	v	v	v	v	v	v	v	v	v	v		v	v		v	
	66	v	v	v	v	v	v	v	v	v	v		v	v		v	
Conducted Spurious Emission	2	v	v	v	v	v	v	v				v			v	v	v
	66	v	v	v	v	v	v	v				v			v	v	v
Frequency Stability	2						v	v				v				v	
	66						v	v				v				v	
E.R.P / E.I.R.P	2	v	v	v	v	v	v	v	v	v	v	v	v	v	v	v	v
	4	v	v	v	v	v	v	v	v	v	v	v	v	v	v	v	v
	66	v	v	v	v	v	v	v	v	v	v	v	v	v	v	v	v
Radiated Spurious Emission	2	Worst Case														v	
	66	Worst Case														v	
Note	<ol style="list-style-type: none"> The mark "v" means that this configuration is chosen for testing The mark "-" means that this bandwidth is not supported. The device is investigated from 30MHz to 10 times of fundamental signal for radiated spurious emission test under different RB size/offset and modulations in exploratory test. Subsequently, only the worst case emissions are reported. LTE Band 66 overlaps the entire frequency range of LTE Band 4. Therefore, the test results provided in this report covers Band 66 as well as Band 4. All test items are based on engineering evaluation. 																



Test Items	Band	Bandwidth (MHz)						Modulation			RB #			Test Channel				
		5+5	5+10	10+5	5+15	15+5	10+10	QPSK	16QAM	64QAM	1	Half	Full	L	M	H		
Max. Output Power	66B_CA	v	v	v	v	v	v	v	v	v	v	v				v	v	v
26dB and 99% Bandwidth	66B_CA							v	v	v					v		v	
Conducted Band Edge	66B_CA	v	v	v	v	v	v	v	v	v	v	v			v	v		v
Conducted Spurious Emission	66B_CA	v	v	v	v	v	v	v				v				v	v	v
E.I.R.P.	66B_CA	v	v	v	v	v	v	v	v	v	v	v				v	v	v
Radiated Spurious Emission	66B_CA	Worst Case																v
Note	<ol style="list-style-type: none"> The mark "v" means that this configuration is chosen for testing The mark "-" means that this bandwidth is not supported. The device is investigated from 30MHz to 10 times of fundamental signal for radiated spurious emission test under different RB size/offset and modulations in exploratory test. Subsequently, only the worst case emissions are reported. All test items are based on engineering evaluation. 																	

Test Items	Band	Bandwidth (MHz)										Modulation			RB #			Test Channel			
		5+20	20+5	10+15	15+10	10+20	20+10	15+15	15+20	20+15	20+20	QPSK	16QAM	64QAM	1	Half	Full	L	M	H	
Max. Output Power	66C_CA	v	v	v	v	v	v	v	v	v	v	v	v	v	v	v			v	v	v
26dB and 99% Bandwidth	66C_CA											v	v	v			v		v		
Conducted Band Edge	66C_CA	v	v	v	v	v	v	v	v	v	v	v	v	v	v		v	v		v	
Conducted Spurious Emission	66C_CA	v	v	v	v	v	v	v	v	v	v	v			v				v	v	v
E.I.R.P.	66C_CA	v	v	v	v	v	v	v	v	v	v	v	v	v	v				v	v	v
Radiated Spurious Emission	66C_CA	Worst Case																v			
Note	<ol style="list-style-type: none"> The mark "v" means that this configuration is chosen for testing The mark "-" means that this bandwidth is not supported. The device is investigated from 30MHz to 10 times of fundamental signal for radiated spurious emission test under different RB size/offset and modulations in exploratory test. Subsequently, only the worst case emissions are reported. All test items are based on engineering evaluation. 																				

2.2 Connection Diagram of Test System

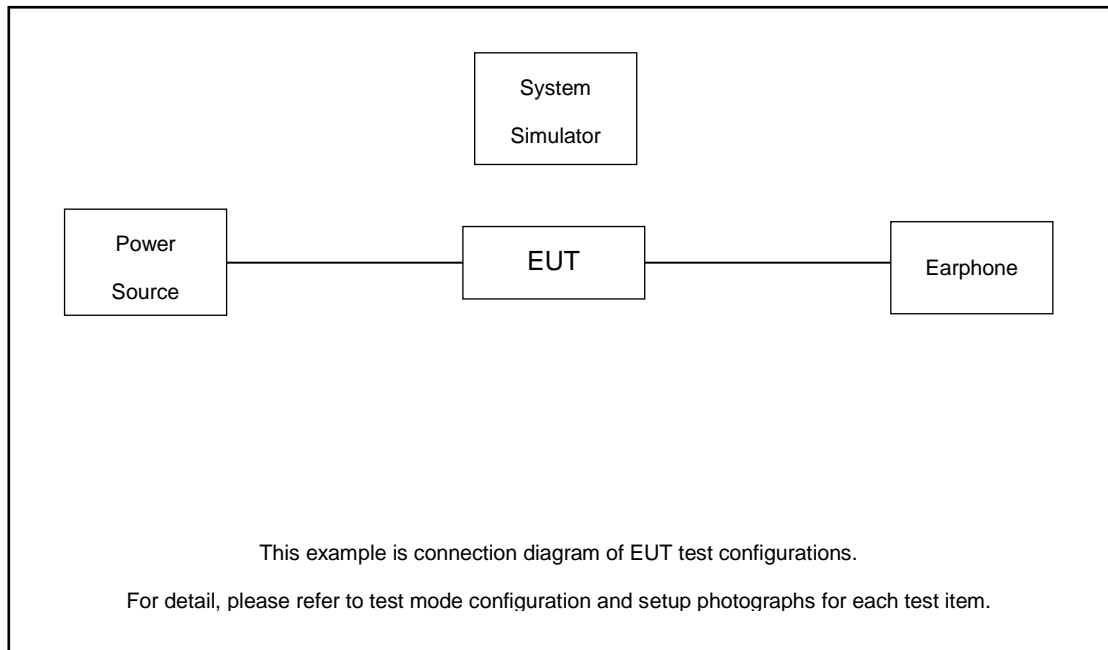

2.3 Support Unit used in test configuration and system

Item	Equipment	Trade Name	Model No.	FCC ID	Data Cable	Power Cord
1.	Power Supply	GWINSTEK	PSS-2002	N/A	N/A	Unshielded, 1.8 m
2.	LTE Base Station	Anritsu	MT8820C	N/A	N/A	Unshielded, 1.8 m
3.	Earphone	N/A	N/A	N/A	Unshielded, 1.2m	N/A



2.4 Measurement Results Explanation Example

For all conducted test items:

The offset level is set in the spectrum analyzer to compensate the RF cable loss between EUT conducted output port and spectrum analyzer. With the offset compensation, the spectrum analyzer reading level is exactly the EUT RF output level.

The spectrum analyzer offset is derived from RF cable loss.

$$\text{Offset} = \text{RF cable loss.}$$

Following shows an offset computation example with cable loss 5.4 dB.

Example :

$$\begin{aligned} \text{Offset(dB)} &= \text{RF cable loss(dB)}. \\ &= 5.4 \text{ (dB)} \end{aligned}$$

2.5 Frequency List of Low/Middle/High Channels

LTE Band 2 Channel and Frequency List				
BW [MHz]	Channel/Frequency(MHz)	Lowest	Middle	Highest
20	Channel	18700	18900	19100
	Frequency	1860	1880	1900
15	Channel	18675	18900	19125
	Frequency	1857.5	1880	1902.5
10	Channel	18650	18900	19150
	Frequency	1855	1880	1905
5	Channel	18625	18900	19175
	Frequency	1852.5	1880	1907.5
3	Channel	18615	18900	19185
	Frequency	1851.5	1880	1908.5
1.4	Channel	18607	18900	19193
	Frequency	1850.7	1880	1909.3



LTE Band 4 Channel and Frequency List				
BW [MHz]	Channel/Frequency(MHz)	Lowest	Middle	Highest
20	Channel	20050	20175	20300
	Frequency	1720	1732.5	1745
15	Channel	20025	20175	20325
	Frequency	1717.5	1732.5	1747.5
10	Channel	20000	20175	20350
	Frequency	1715	1732.5	1750
5	Channel	19975	20175	20375
	Frequency	1712.5	1732.5	1752.5
3	Channel	19965	20175	20385
	Frequency	1711.5	1732.5	1753.5
1.4	Channel	19957	20175	20393
	Frequency	1710.7	1732.5	1754.3

LTE Band 66 Channel and Frequency List				
BW [MHz]	Channel/Frequency(MHz)	Lowest	Middle	Highest
20	Channel	132072	132322	132572
	Frequency	1720	1745	1770
15	Channel	132047	132322	132597
	Frequency	1717.5	1745	1772.5
10	Channel	132022	132322	132622
	Frequency	1715	1745	1775
5	Channel	131997	132322	132647
	Frequency	1712.5	1745	1777.5
3	Channel	131987	132322	132657
	Frequency	1711.5	1745	1778.5
1.4	Channel	131979	132322	132665
	Frequency	1710.7	1745	1779.3



LTE Band 66C_CA Channel and Frequency List					
BW [MHz]	Channel/Frequency(MHz)		Lowest	Middle	Highest
10 + 15	PCC	Channel	132025	132351	132477
		Frequency	1715.3	1747.9	1760.5
	SCC	Channel	132145	132471	132597
		Frequency	1727.3	1759.9	1772.5
15 + 10	PCC	Channel	132047	132373	132499
		Frequency	1717.5	1750.1	1762.7
	SCC	Channel	132167	132493	132619
		Frequency	1729.5	1762.1	1774.7
10 + 20	PCC	Channel	132027	132328	132428
		Frequency	1715.5	1745.6	1755.6
	SCC	Channel	132171	132472	132572
		Frequency	1729.9	1760	1770
20 + 10	PCC	Channel	132072	132373	132473
		Frequency	1720	1750.1	1760.1
	SCC	Channel	132216	132517	132617
		Frequency	1734.4	1764.5	1774.5
15 + 15	PCC	Channel	132047	132347	132447
		Frequency	1717.5	1747.5	1757.5
	SCC	Channel	132197	132497	132597
		Frequency	1732.5	1762.5	1772.5
15 + 20	PCC	Channel	132050	132325	132401
		Frequency	1717.8	1745.3	1752.9
	SCC	Channel	132221	132496	132572
		Frequency	1734.9	1762.4	1770
20 + 15	PCC	Channel	132072	132348	132423
		Frequency	1720	1747.6	1755.1
	SCC	Channel	132243	132519	132594
		Frequency	1737.1	1764.7	1772.2
20 + 5	PCC	Channel	132072	132397	132522
		Frequency	1720	1752.5	1765
	SCC	Channel	132189	132514	132639
		Frequency	1731.7	1764.2	1776.7
5 + 20	PCC	Channel	132005	132330	132455



	SCC	Frequency	1713.3	1745.8	1758.3
		Channel	132122	132447	132572
20 + 20	PCC	Frequency	1725	1757.5	1770
		Channel	132072	132323	132374
	SCC	Frequency	1720	1745.1	1750.2
		Channel	132270	132521	132572
	SCC	Frequency	1739.8	1764.9	1770
		Channel			

LTE Band 66B_CA Channel and Frequency List					
BW [MHz]	Channel/Frequency(MHz)		Lowest	Middle	Highest
5 + 5	PCC	Channel	131997	132398	132599
		Frequency	1712.5	1752.6	1772.7
	SCC	Channel	132045	132446	132647
		Frequency	1717.3	1757.4	1777.5
5 + 10	PCC	Channel	132000	132375	132550
		Frequency	1712.8	1750.3	1767.8
	SCC	Channel	132072	132447	132622
		Frequency	1720	1757.5	1775
10 + 5	PCC	Channel	132022	132397	132572
		Frequency	1715	1752.5	1770
	SCC	Channel	132094	132469	132644
		Frequency	1722.2	1759.7	1777.2
5 + 15	PCC	Channel	132002	132353	132504
		Frequency	1713	1748.1	1763.2
	SCC	Channel	132095	132446	132597
		Frequency	1722.3	1757.4	1772.5
15 + 5	PCC	Channel	132047	132398	132549
		Frequency	1717.5	1752.6	1767.7
	SCC	Channel	132140	132491	132642
		Frequency	1726.8	1761.9	1777
10 + 10	PCC	Channel	132022	132373	132523
		Frequency	1715	1750.1	1765.1
	SCC	Channel	132121	132472	132622
		Frequency	1724.9	1760	1775

3 Conducted Test Items

3.1 Measuring Instruments

See list of measuring instruments of this test report.

3.2 Test Setup

3.2.1 Conducted Output Power



3.2.2 Peak-to-Average Ratio, Occupied Bandwidth, Conducted Band-Edge and Conducted Spurious Emission



3.2.3 Frequency Stability

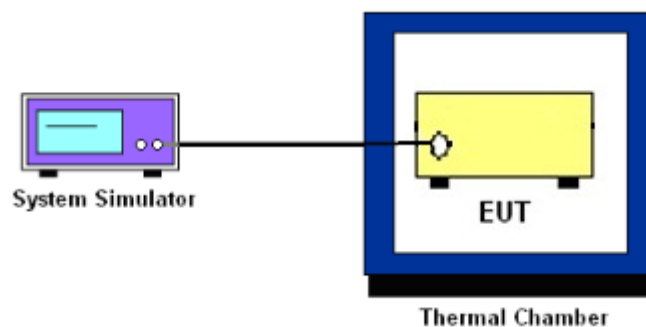

3.3 Test Result of Conducted Test

Please refer to Appendix A.



3.4 Conducted Output Power and EIRP

3.4.1 Description of the Conducted Output Power Measurement and EIRP Measurement

A system simulator was used to establish communication with the EUT. Its parameters were set to force the EUT transmitting at maximum output power. The measured power in the radio frequency on the transmitter output terminals shall be reported.

The EIRP of mobile transmitters must not exceed 2 Watts for LTE Band 2.

The EIRP of mobile transmitters must not exceed 1 Watts for LTE Band 4 and Band 66.

According to KDB 412172 D01 Power Approach,

$EIRP = P_T + G_T - L_C$, $ERP = EIRP - 2.15$, where

P_T = transmitter output power in dBm

G_T = gain of the transmitting antenna in dBi

L_C = signal attenuation in the connecting cable between the transmitter and antenna in dB

3.4.2 Test Procedures

1. The testing follows ANSI C63.26 Section 5.2
2. The transmitter output port was connected to the system simulator.
3. Set EUT at maximum power through the system simulator.
4. Select lowest, middle, and highest channels for each band and different modulation.
5. Measure and record the power level from the system simulator.



3.5 Peak-to-Average Ratio

3.5.1 Description of the PAR Measurement

Power Complementary Cumulative Distribution Function (CCDF) curves provide a means for characterizing the power peaks of a digitally modulated signal on a statistical basis. A CCDF curve depicts the probability of the peak signal amplitude exceeding the average power level. Most contemporary measurement instrumentation include the capability to produce CCDF curves for an input signal provided that the instrument's resolution bandwidth can be set wide enough to accommodate the entire input signal bandwidth. In measuring transmissions in this band using an average power technique, the peak-to-average ratio (PAR) of the transmission may not exceed 13 dB.

3.5.2 Test Procedures

1. The testing follows ANSI C63.26 Section 5.2.3.4 (CCDF).
2. The EUT was connected to spectrum and system simulator via a power divider.
3. Set the CCDF (Complementary Cumulative Distribution Function) option in spectrum analyzer.
4. The highest RF powers were measured and recorded the maximum PAPR level associated with a probability of 0.1 %.
5. Record the deviation as Peak to Average Ratio.



3.6 Occupied Bandwidth

3.6.1 Description of Occupied Bandwidth Measurement

The occupied bandwidth is the width of a frequency band such that, below the lower and above the upper frequency limits, the mean powers emitted are each equal to a specified percentage 0.5% of the total mean transmitted power.

The 26 dB emission bandwidth is defined as the frequency range between two points, one above and one below the carrier frequency, at which the spectral density of the emission is attenuated 26 dB below the maximum in-band spectral density of the modulated signal. Spectral density (power per unit bandwidth) is to be measured with a detector of resolution bandwidth equal to approximately 1.0% of the emission bandwidth.

3.6.2 Test Procedures

1. The testing follows ANSI C63.26 Section 5.4
2. The EUT was connected to spectrum analyzer and system simulator via a power divider.
3. The spectrum analyzer center frequency is set to the nominal EUT channel center frequency. The span range for the spectrum analyzer shall be between two and five times the anticipated OBW.
4. The nominal resolution bandwidth (RBW) shall be in the range of 1 to 5 % of the anticipated OBW, and the VBW shall be at least 3 times the RBW.
5. Set the detection mode to peak, and the trace mode to max hold.
6. Determine the reference value: Set the EUT to transmit a modulated signal. Allow the trace to stabilize. Set the spectrum analyzer marker to the highest level of the displayed trace.
(this is the reference value)
7. Determine the “-26 dB down amplitude” as equal to (Reference Value – X).
8. Place two markers, one at the lowest and the other at the highest frequency of the envelope of the spectral display such that each marker is at or slightly below the “-X dB down amplitude” determined in step 6. If a marker is below this “-X dB down amplitude” value it shall be placed as close as possible to this value. The OBW is the positive frequency difference between the two markers.
9. Use the 99 % power bandwidth function of the spectrum analyzer and report the measured bandwidth.



3.7 Conducted Band Edge

3.7.1 Description of Conducted Band Edge Measurement

24.238 (a)

For operations in the 1850-1910 and 1930-1990 MHz band, the FCC limit is $43 + 10\log_{10}(P[\text{Watts}])$ dB below the transmitter power $P(\text{Watts})$ in a 1MHz bandwidth. However, in the 1 MHz bands immediately outside and adjacent to the frequency block a resolution bandwidth of at least one percent of the emission bandwidth of the fundamental emission of the transmitter may be employed.

27.53 (h)

For operations in the 1710 – 1755 MHz band, the FCC limit is $43 + 10\log_{10}(P[\text{Watts}])$ dB below the transmitter power $P(\text{Watts})$ in a 1 MHz bandwidth. However, in the 1MHz bands immediately outside and adjacent to the licensee's frequency block, a resolution bandwidth of at least one percent of the emission bandwidth of the fundamental emission of the transmitter may be employed.

3.7.2 Test Procedures

1. The testing follows ANSI C63.26 section 5.7
2. The EUT was connected to spectrum analyzer and system simulator via a power divider.
3. The band edges of low and high channels for the highest RF powers were measured.
4. Set RBW \geq 1% EBW in the 1MHz band immediately outside and adjacent to the band edge.
5. Beyond the 1 MHz band from the band edge, RBW=1MHz was used.
6. Set spectrum analyzer with RMS detector.
7. The RF fundamental frequency should be excluded against the limit line in the operating frequency band.
8. Checked that all the results comply with the emission limit line.

Example:

$$\begin{aligned} & \text{The limit line is derived from } 43 + 10\log(P)\text{dB below the transmitter power } P(\text{Watts}) \\ & = P(\text{W}) - [43 + 10\log(P)] \text{ (dB)} \\ & = [30 + 10\log(P)] \text{ (dBm)} - [43 + 10\log(P)] \text{ (dB)} = -13\text{dBm}. \end{aligned}$$



3.8 Conducted Spurious Emission

3.8.1 Description of Conducted Spurious Emission Measurement

The power of any emission outside of the authorized operating frequency ranges must be lower than the transmitter power (P) by a factor of at least $43 + 10 \log (P)$ dB.

It is measured by means of a calibrated spectrum analyzer and scanned from 30 MHz up to a frequency including its 10th harmonic.

3.8.2 Test Procedures

1. The testing follows ANSI C63.26 section 5.7
2. The EUT was connected to spectrum analyzer and system simulator via a power divider.
3. The RF output of EUT was connected to the spectrum analyzer by RF cable and attenuator. The path loss was compensated to the results for each measurement.
4. The middle channel for the highest RF power within the transmitting frequency was measured.
5. The conducted spurious emission for the whole frequency range was taken.
6. Make the measurement with the spectrum analyzer's RBW = 1MHz, VBW = 3MHz.
7. Set spectrum analyzer with RMS detector.
8. Taking the record of maximum spurious emission.
9. The RF fundamental frequency should be excluded against the limit line in the operating frequency band.
10. The limit line is derived from $43 + 10\log(P)$ dB below the transmitter power P(Watts)
= P(W)- [43 + 10log(P)] (dB)
= [30 + 10log(P)] (dBm) - [43 + 10log(P)] (dB)
= -13dBm.



3.9 Frequency Stability

3.9.1 Description of Frequency Stability Measurement

The frequency stability shall be measured by variation of ambient temperature and variation of primary supply voltage to ensure that the fundamental emission stays within the authorized frequency block. The frequency stability of the transmitter shall be maintained within $\pm 0.00025\%$ ($\pm 2.5\text{ppm}$) of the center frequency.

3.9.2 Test Procedures for Temperature Variation

1. The testing follows ANSI C63.26 section 5.6.4
2. The EUT was set up in the thermal chamber and connected with the system simulator.
3. With power OFF, the temperature was decreased to -30°C and the EUT was stabilized before testing. Power was applied and the maximum change in frequency was recorded within one minute.
4. With power OFF, the temperature was raised in 10°C step up to 50°C . The EUT was stabilized at each step for at least half an hour. Power was applied and the maximum frequency change was recorded within one minute.

3.9.3 Test Procedures for Voltage Variation

1. The testing follows ANSI C63.26 section 5.6.5
2. The EUT was placed in a temperature chamber at $20\pm 5^{\circ}\text{C}$ and connected with the system simulator.
3. The power supply voltage to the EUT was varied from 85% to 115% of the nominal value for other than hand carried battery equipment.
4. For hand carried, battery powered equipment, reduce the primary ac or dc supply voltage to the battery operating end point, which shall be specified by the manufacturer.
5. The variation in frequency was measured for the worst case.

4 Radiated Test Items

4.1 Measuring Instruments

See list of measuring instruments of this test report.

4.2 Test Setup

4.2.1 For radiated test from 30MHz to 1GHz

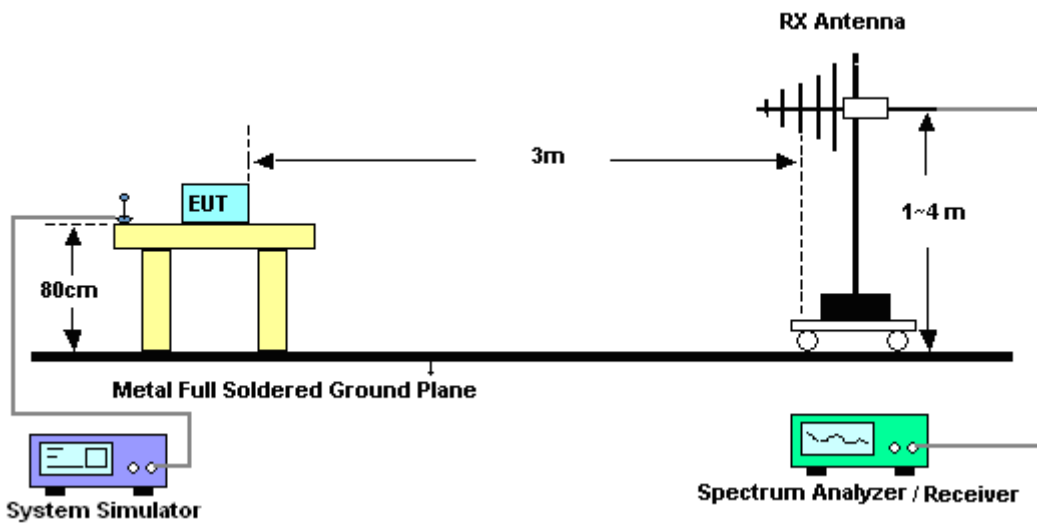

4.2.2 For radiated test above 1GHz

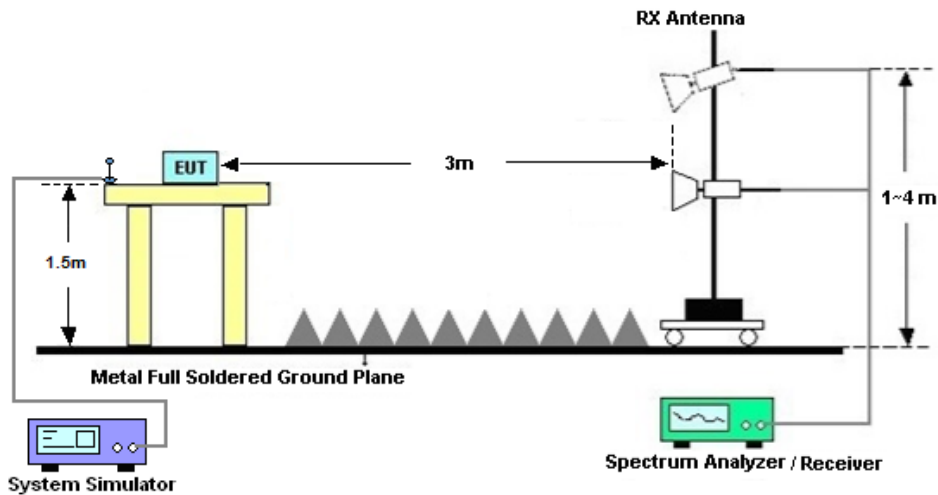

4.3 Test Result of Radiated Test

Please refer to Appendix B.



4.4 Radiated Spurious Emission

4.4.1 Description of Radiated Spurious Emission

The radiated spurious emission was measured by substitution method according to ANSI C63.26. The power of any emission outside of the authorized operating frequency ranges must be attenuated below the transmitter power (P) by a factor of at least $43 + 10 \log (P)$ dB.

The spectrum is scanned from 30 MHz up to a frequency including its 10th harmonic.

4.4.2 Test Procedures

1. The testing follows ANSI C63.26 Section 5.5
2. The EUT was placed on a turntable with 0.8 meter height for frequency below 1GHz and 1.5 meter height for frequency above 1GHz respectively above ground.
3. The EUT was set 3 meters from the receiving antenna mounted on the antenna tower.
4. The table was rotated 360 degrees to determine the position of the highest spurious emission.
5. The height of the receiving antenna is varied between 1m to 4m to search the maximum spurious emission for both horizontal and vertical polarizations.
6. During the measurement, the system simulator parameters were set to force the EUT transmitting at maximum output power.
7. Make the measurement with the spectrum analyzer's RBW = 1MHz, VBW = 3MHz, taking the record of maximum spurious emission.
8. A horn antenna was substituted in place of the EUT and was driven by a signal generator.
9. Tune the output power of signal generator to the same emission level with EUT maximum spurious emission.
10. $EIRP \text{ (dBm)} = S.G. \text{ Power} - Tx \text{ Cable Loss} + Tx \text{ Antenna Gain}$
11. $ERP \text{ (dBm)} = EIRP - 2.15$
12. The RF fundamental frequency should be excluded against the limit line in the operating frequency band.

The limit line is derived from $43 + 10\log(P)$ dB below the transmitter power P(Watts)
= $P(W) - [43 + 10\log(P)] \text{ (dB)}$
= $[30 + 10\log(P)] \text{ (dBm)} - [43 + 10\log(P)] \text{ (dB)}$
= -13dBm.



5 List of Measuring Equipment

Instrument	Manufacturer	Model No.	Serial No.	Characteristics	Calibration Date	Test Date	Due Date	Remark
Spectrum Analyzer	R&S	FSV40	101040	10Hz~40GHz	Nov. 01, 2020	Mar. 12, 2021~ Mar. 17, 2021	Oct. 31, 2021	Conducted (TH01-KS)
Temperature & humidity chamber	Hongzhan	LP-150U	H2014011440	-40~+150°C 20%~95%RH	Jul. 03, 2020	Mar. 12, 2021~ Mar. 17, 2021	Jul. 02, 2021	Conducted (TH01-KS)
EXA Spectrum Analyzer	Keysight	N9010A	MY55150244	10Hz-44G,MAX 30dB	Apr. 15, 2020	Mar. 27, 2021	Apr. 14, 2021	Radiation (03CH04-KS)
Bilog Antenna	TeseQ	CBL6111D	49922	30MHz-1GHz	Jun. 08, 2020	Mar. 27, 2021	Jun. 07, 2021	Radiation (03CH04-KS)
Horn Antenna	Schwarzbeck	BBHA9120D	1356	1GHz~18GHz	Apr. 20, 2020	Mar. 27, 2021	Apr. 19, 2021	Radiation (03CH04-KS)
SHF-EHF Horn	Com-power	AH-840	101115	18GHz~40GHz	Jan. 06, 2021	Mar. 27, 2021	Jan. 05, 2022	Radiation (03CH04-KS)
Amplifier	SONOMA	310N	187289	9KHz-1GHz	Jan. 06, 2021	Mar. 27, 2021	Jan. 05, 2022	Radiation (03CH04-KS)
Amplifier	MITEQ	EM18G40G GA	060728	18~40GHz	Jan. 07, 2021	Mar. 27, 2021	Jan. 06, 2022	Radiation (03CH04-KS)
high gain Amplifier	MITEQ	AMF-7D-00 101800-30-1 0P	2025788	1Ghz-18Ghz	Jan. 06, 2021	Mar. 27, 2021	Jan.05, 2022	Radiation (03CH04-KS)
Amplifier	Keysight	83017A	MY57280106	500MHz~26.5GHz	Oct. 14, 2020	Mar. 27, 2021	Oct. 13, 2021	Radiation (03CH04-KS)
AC Power Source	Chroma	61601	F104090004	N/A	NCR	Mar. 27, 2021	NCR	Radiation (03CH04-KS)
Turn Table	ChamPro	EM 1000-T	060762-T	0~360 degree	NCR	Mar. 27, 2021	NCR	Radiation (03CH04-KS)
Antenna Mast	ChamPro	EM 1000-A	060762-A	1 m~4 m	NCR	Mar. 27, 2021	NCR	Radiation (03CH04-KS)

NCR: No Calibration Required



6 Uncertainty of Evaluation

The measurement uncertainties shown below were calculated in accordance with the requirements of ANSI 63.26-2015. All the measurement uncertainty value were shown with a coverage K=2 to indicate 95% level of confidence. The measurement data show herein meets or exceeds the CISPR measurement uncertainty values specified in CISPR 16-4-2 and can be compared directly to specified limit to determine compliance.

Uncertainty of Radiated Emission Measurement (30 MHz ~ 1000 MHz)

Measuring Uncertainty for a Level of Confidence of 95% ($U = 2Uc(y)$)	3.3dB
---	-------

Uncertainty of Radiated Emission Measurement (1 GHz ~ 40 GHz)

Measuring Uncertainty for a Level of Confidence of 95% ($U = 2Uc(y)$)	2.8dB
---	-------



Appendix A. Test Results of Conducted Test

Conducted Output Power(Average power) and EIRP

LTE Band 2:

BW [MHz]	Modulation	RB Size	RB Offset	Power Low Ch. / Freq.	Power Middle Ch. / Freq.	Power High Ch. / Freq.	EIRP(W)		
Channel				18700	18900	19100	EIRP(W)		
Frequency (MHz)				1860	1880	1900	L	M	H
20	QPSK	1	0	23.12	23.51	23.06	0.1236	0.1352	0.1219
20	QPSK	1	99	23.09	23.32	23.06	0.1227	0.1294	0.1219
20	QPSK	100	0	22.13	22.23	22.03	0.0984	0.1007	0.0962
20	16QAM	1	0	22.24	22.24	22.61	0.1009	0.1009	0.1099
20	64QAM	1	0	21.52	21.25	21.30	0.0855	0.0804	0.0813
Channel				18675	18900	19125	EIRP(W)		
Frequency (MHz)				1857.5	1880	1902.5	L	M	H
15	QPSK	1	0	23.03	22.86	22.84	0.1211	0.1164	0.1159
15	16QAM	1	0	22.31	22.24	22.45	0.1026	0.1009	0.1059
Channel				18650	18900	19150	EIRP(W)		
Frequency (MHz)				1855	1880	1905	L	M	H
10	QPSK	1	0	23.17	22.98	23.09	0.1250	0.1197	0.1227
10	16QAM	1	0	22.56	22.36	22.32	0.1086	0.1038	0.1028
Channel				18625	18900	19175	EIRP(W)		
Frequency (MHz)				1852.5	1880	1907.5	L	M	H
5	QPSK	1	0	23.16	23.05	23.13	0.1247	0.1216	0.1239
5	16QAM	1	0	22.54	22.48	22.61	0.1081	0.1067	0.1099
Channel				18615	18900	19185	EIRP(W)		
Frequency (MHz)				1851.5	1880	1908.5	L	M	H
3	QPSK	1	0	23.21	23.01	23.15	0.1262	0.1205	0.1245
3	16QAM	1	0	22.56	22.39	22.52	0.1086	0.1045	0.1076
Channel				18607	18900	19193	EIRP(W)		
Frequency (MHz)				1850.7	1880	1909.3	L	M	H
1.4	QPSK	1	0	23.02	23.01	23.04	0.1208	0.1205	0.1213
1.4	16QAM	1	0	22.54	22.48	22.38	0.1081	0.1067	0.1042



LTE Band 4:

BW [MHz]	Modulation	RB Size	RB Offset	Power Low Ch. / Freq.	Power Middle Ch. / Freq.	Power High Ch. / Freq.	EIRP(W)		
Channel				20050	20175	20300	EIRP(W)		
Frequency (MHz)				1720	1732.5	1745	L	M	H
20	QPSK	1	0	22.92	23.33	23.02	0.1265	0.1390	0.1294
20	QPSK	1	99	22.93	22.94	22.94	0.1268	0.1271	0.1271
20	QPSK	100	0	21.91	22.05	22.02	0.1002	0.1035	0.1028
20	16QAM	1	0	22.19	22.43	22.24	0.1069	0.1130	0.1081
20	64QAM	1	0	21.21	21.39	21.07	0.0853	0.0889	0.0826
Channel				20025	20175	20325	EIRP(W)		
Frequency (MHz)				1717.5	1732.5	1747.5	L	M	H
15	QPSK	1	0	22.77	22.65	22.82	0.1222	0.1189	0.1236
15	16QAM	1	0	22.08	22.28	22.26	0.1042	0.1091	0.1086
Channel				20000	20175	20350	EIRP(W)		
Frequency (MHz)				1715	1732.5	1750	L	M	H
10	QPSK	1	0	22.88	23.02	22.99	0.1253	0.1294	0.1285
10	16QAM	1	0	22.22	22.41	22.28	0.1076	0.1125	0.1091
Channel				19975	20175	20375	EIRP(W)		
Frequency (MHz)				1712.5	1732.5	1752.5	L	M	H
5	QPSK	1	0	23.00	22.95	22.92	0.1288	0.1274	0.1265
5	16QAM	1	0	22.34	22.38	22.42	0.1107	0.1117	0.1127
Channel				19965	20175	20385	EIRP(W)		
Frequency (MHz)				1711.5	1732.5	1753.5	L	M	H
3	QPSK	1	0	22.94	23.02	22.96	0.1271	0.1294	0.1276
3	16QAM	1	0	22.36	22.43	22.32	0.1112	0.1130	0.1102
Channel				19950	20175	20393	EIRP(W)		
Frequency (MHz)				1710	1732.5	1754.3	L	M	H
1.4	QPSK	1	0	22.79	22.97	22.89	0.1227	0.1279	0.1256
1.4	16QAM	1	0	22.23	22.35	22.36	0.1079	0.1109	0.1112



LTE Band 66:

BW [MHz]	Modulation	RB Size	RB Offset	Power Low Ch. / Freq.	Power Middle Ch. / Freq.	Power High Ch. / Freq.	EIRP(W)		
Channel				132072	132322	132572	EIRP(W)		
Frequency (MHz)				1720	1745	1770	L	M	H
20	QPSK	1	0	23.20	23.35	23.21	0.1349	0.1396	0.1352
20	QPSK	1	99	23.11	23.15	23.05	0.1321	0.1334	0.1304
20	QPSK	100	0	22.76	22.70	22.65	0.1219	0.1202	0.1189
20	16QAM	1	0	22.46	22.77	22.85	0.1138	0.1222	0.1245
20	64QAM	1	0	21.25	21.55	21.47	0.0861	0.0923	0.0906
Channel				132047	132322	132597	EIRP(W)		
Frequency (MHz)				1717.5	1745	1772.5	L	M	H
15	QPSK	1	0	22.78	23.03	23.02	0.1225	0.1297	0.1294
15	16QAM	1	0	22.42	22.71	22.58	0.1127	0.1205	0.1169
Channel				132022	132322	132622	EIRP(W)		
Frequency (MHz)				1715	1745	1775	L	M	H
10	QPSK	1	0	23.06	23.03	23.05	0.1306	0.1297	0.1303
10	16QAM	1	0	22.62	22.75	22.64	0.1180	0.1216	0.1186
Channel				131997	132322	132647	EIRP(W)		
Frequency (MHz)				1712.5	1745	1777.5	L	M	H
5	QPSK	1	0	23.02	23.03	23.09	0.1294	0.1297	0.1315
5	16QAM	1	0	22.85	22.83	22.77	0.1245	0.1239	0.1222
Channel				131987	132322	132657	EIRP(W)		
Frequency (MHz)				1711.5	1745	1778.5	L	M	H
3	QPSK	1	0	22.88	23.06	22.93	0.1253	0.1306	0.1268
3	16QAM	1	0	22.74	22.83	22.85	0.1213	0.1239	0.1245
Channel				131979	132322	132665	EIRP(W)		
Frequency (MHz)				1710.7	1745	1779.3	L	M	H
1.4	QPSK	1	0	22.91	23.07	22.90	0.1262	0.1309	0.1259
1.4	16QAM	1	0	22.70	22.52	22.83	0.1202	0.1153	0.1239



LTE Band 66B_CA:

Combination 10MHz+10MHz (50RB+50RB)							
Channel	Modulation	PCC		SCC		Measured Power	EIRP(W)
		RB Size	RB offset	RB Size	RB offset		
L	QPSK	1	Max	1	0	23.01	0.1291
M	QPSK	1	Max	1	0	22.99	0.1285
H	QPSK	1	Max	1	0	22.98	0.1282
L	16QAM	1	Max	1	0	22.23	0.1079
M	16QAM	1	Max	1	0	22.20	0.1072
H	16QAM	1	Max	1	0	22.10	0.1047
L	64QAM	1	Max	1	0	21.34	0.0879
M	64QAM	1	Max	1	0	21.33	0.0877
H	64QAM	1	Max	1	0	21.41	0.0893
Combination 15MHz+5MHz (75RB+25RB)							
Channel	Modulation	PCC		SCC		Measured Power	EIRP(W)
		RB Size	RB offset	RB Size	RB offset		
L	QPSK	1	Max	1	0	22.34	0.1107
L	16QAM	1	Max	1	0	21.45	0.0902
Combination 5MHz+15MHz (25RB+75RB)							
Channel	Modulation	PCC		SCC		Measured Power	EIRP(W)
		RB Size	RB offset	RB Size	RB offset		
L	QPSK	1	Max	1	0	22.65	0.1189
L	16QAM	1	Max	1	0	21.23	0.0857
Combination 10MHz+5MHz (50RB+25RB)							
Channel	Modulation	PCC		SCC		Measured Power	EIRP(W)
		RB Size	RB offset	RB Size	RB offset		
L	QPSK	1	Max	1	0	22.75	0.1216
L	16QAM	1	Max	1	0	21.43	0.0897
Combination 5MHz+10MHz (25RB+50RB)							
Channel	Modulation	PCC		SCC		Measured Power	EIRP(W)
		RB Size	RB offset	RB Size	RB offset		
L	QPSK	1	Max	1	0	22.63	0.1183
L	16QAM	1	Max	1	0	21.65	0.0944
Combination 5MHz+5MHz (25RB+25RB)							
Channel	Modulation	PCC		SCC		Measured Power	EIRP(W)
		RB Size	RB offset	RB Size	RB offset		
L	QPSK	1	Max	1	0	22.43	0.1130
L	16QAM	1	Max	1	0	21.45	0.0902



LTE Band 66C_CA:

Combination 20MHz+20MHz (100RB+100RB)							
Channel	Modulation	PCC		SCC		Measured Power	EIRP(W)
		RB Size	RB offset	RB Size	RB offset		
L	QPSK	1	Max	1	0	23.22	0.1355
M	QPSK	1	Max	1	0	23.22	0.1355
H	QPSK	1	Max	1	0	23.12	0.1324
L	16QAM	1	Max	1	0	22.54	0.1159
M	16QAM	1	Max	1	0	22.44	0.1132
H	16QAM	1	Max	1	0	22.52	0.1153
L	64QAM	1	Max	1	0	21.23	0.0857
M	64QAM	1	Max	1	0	21.22	0.0855
H	64QAM	1	Max	1	0	21.09	0.0830
Combination 20MHz+15MHz (100RB+75RB)							
Channel	Modulation	PCC		SCC		Measured Power	EIRP(W)
		RB Size	RB offset	RB Size	RB offset		
M	QPSK	1	Max	1	0	22.32	0.1102
L	16QAM	1	Max	1	0	21.98	0.1019
Combination 15MHz+20MHz (75RB+100RB)							
Channel	Modulation	PCC		SCC		Measured Power	EIRP(W)
		RB Size	RB offset	RB Size	RB offset		
M	QPSK	1	Max	1	0	22.43	0.1130
L	16QAM	1	Max	1	0	21.67	0.0948
Combination 15MHz+15MHz (75RB+75RB)							
Channel	Modulation	PCC		SCC		Measured Power	EIRP(W)
		RB Size	RB offset	RB Size	RB offset		
M	QPSK	1	Max	1	0	22.32	0.1102
L	16QAM	1	Max	1	0	21.45	0.0902
Combination 20MHz+10MHz (100RB+50RB)							
Channel	Modulation	PCC		SCC		Measured Power	EIRP(W)
		RB Size	RB offset	RB Size	RB offset		
M	QPSK	1	Max	1	0	22.45	0.1135
L	16QAM	1	Max	1	0	21.65	0.0944
Combination 10MHz+20MHz (50RB+100RB)							
Channel	Modulation	PCC		SCC		Measured Power	EIRP(W)
		RB Size	RB offset	RB Size	RB offset		
M	QPSK	1	Max	1	0	22.23	0.1079
L	16QAM	1	Max	1	0	21.32	0.0875
Combination 15MHz+10MHz (75RB+50RB)							
Channel	Modulation	PCC		SCC		Measured Power	EIRP(W)
		RB Size	RB offset	RB Size	RB offset		
M	QPSK	1	Max	1	0	22.30	0.1096
L	16QAM	1	Max	1	0	21.54	0.0920
Combination 10MHz+15MHz (50RB+75RB)							
Channel	Modulation	PCC		SCC		Measured Power	EIRP(W)
		RB Size	RB offset	RB Size	RB offset		
M	QPSK	1	Max	1	0	22.45	0.1135
L	16QAM	1	Max	1	0	21.90	0.1000



Combination 20MHz+5MHz (100RB+25RB)							
Channel	Modulation	PCC		SCC		Measured Power	EIRP(W)
		RB Size	RB offset	RB Size	RB offset		
M	QPSK	1	Max	1	0	22.32	0.1102
L	16QAM	1	Max	1	0	21.12	0.0836
Combination 5MHz+20MHz (25RB+100RB)							
Channel	Modulation	PCC		SCC		Measured Power	EIRP(W)
		RB Size	RB offset	RB Size	RB offset		
M	QPSK	1	Max	1	0	22.65	0.1189
L	16QAM	1	Max	1	0	21.43	0.0897



LTE Band 2

Peak-to-Average Ratio

Mode	LTE Band 2 / 20MHz			
Mod.	QPSK	16QAM	64QAM	Limit: 13dB
RB Size	Full RB	Full RB	Full RB	Result
Middle CH	4.93	5.88	5.86	PASS

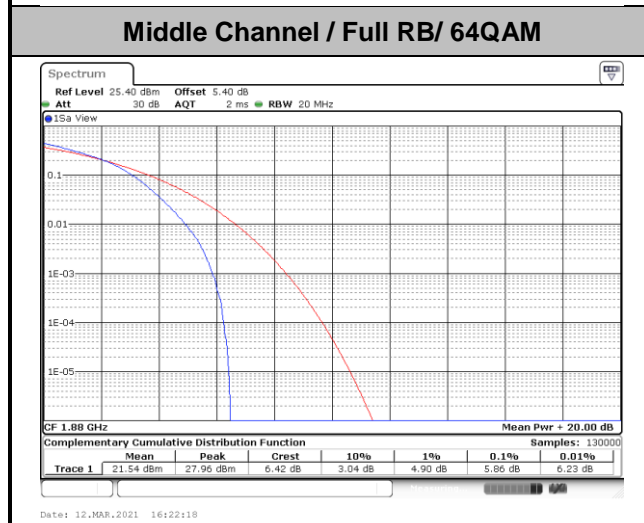
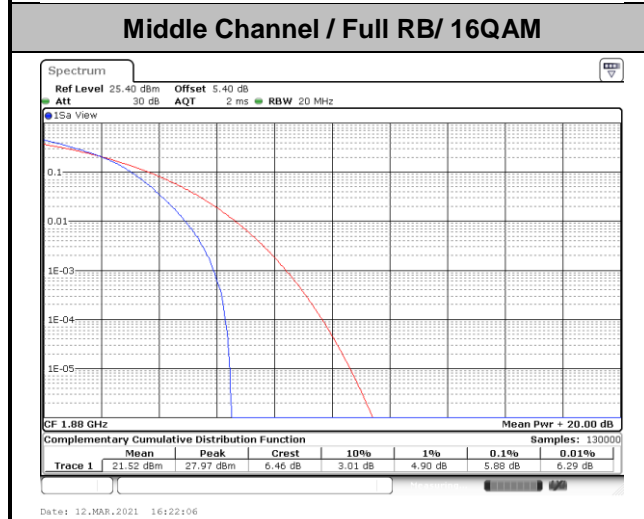
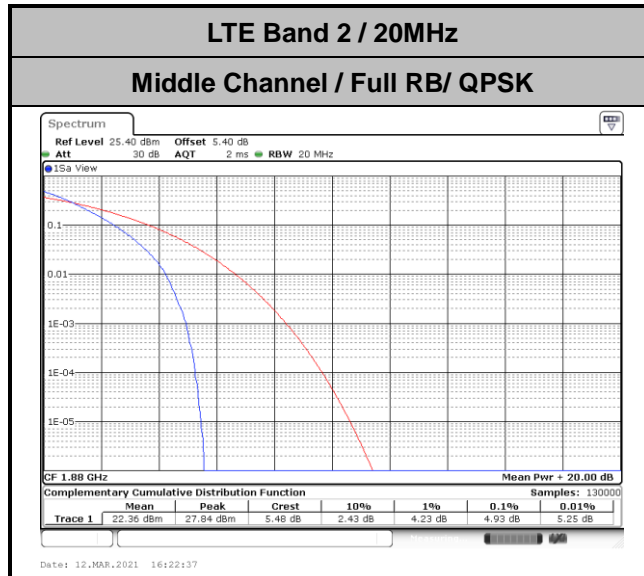



26dB Bandwidth

Mode	LTE Band 2 : 26dB BW(MHz)	
BW	20MHz	
Mod.	QPSK	16QAM
Middle CH	20.30	20.30

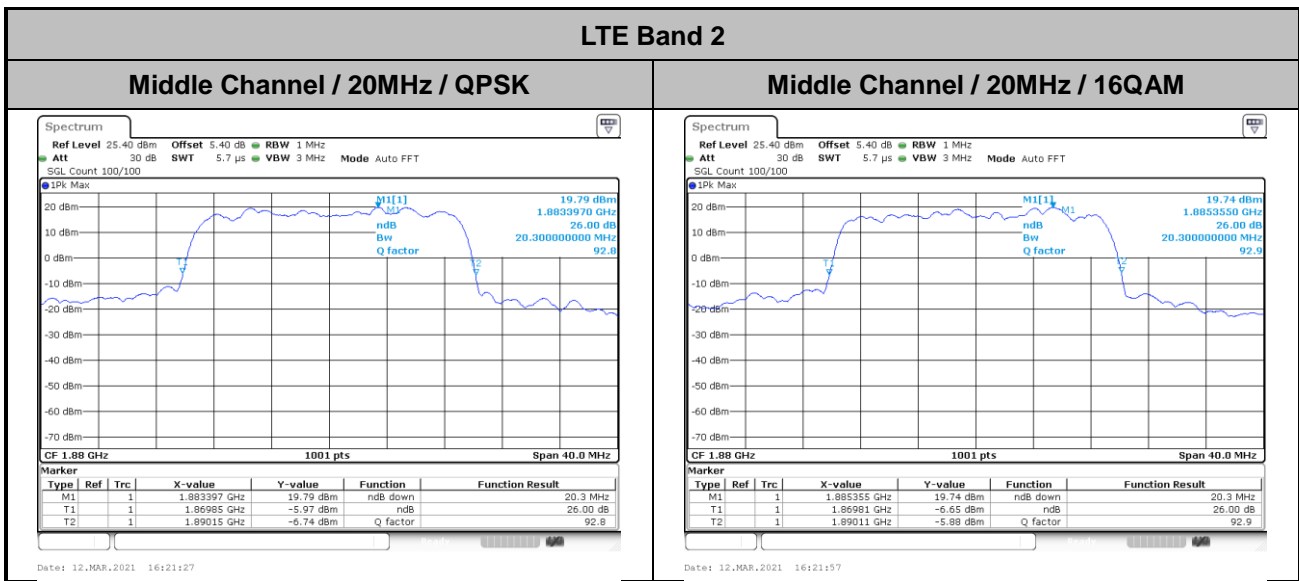



Occupied Bandwidth

Mode	LTE Band 2 : 99%OBW(MHz)	
BW	20MHz	
Mod.	QPSK	16QAM
Middle CH	18.46	18.42

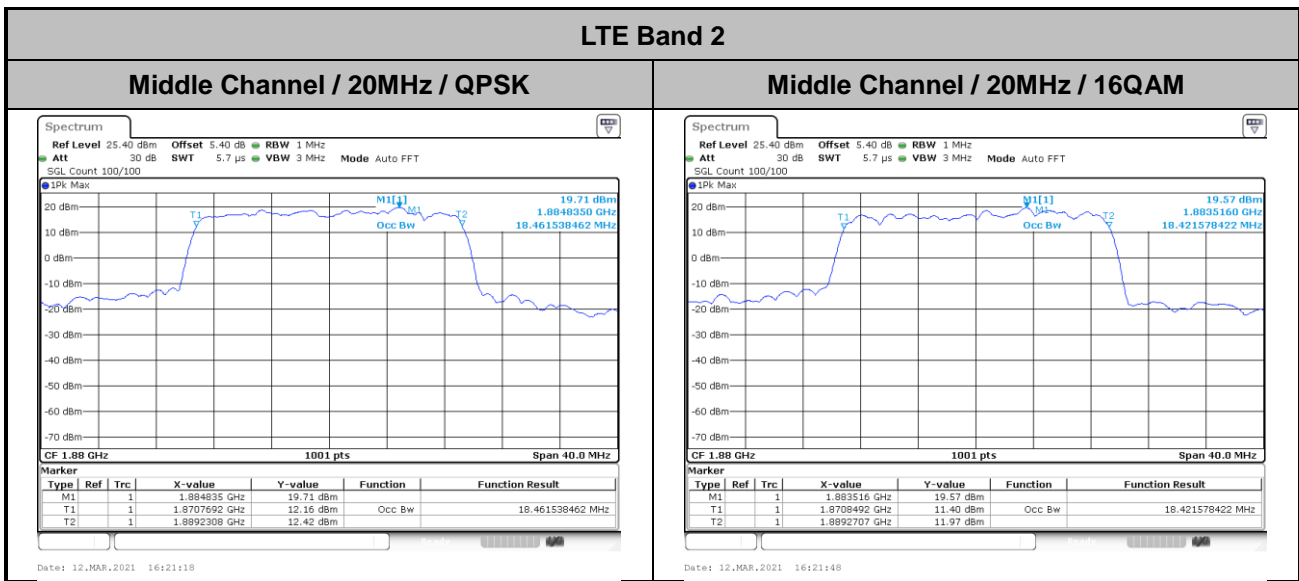



Conducted Band Edge

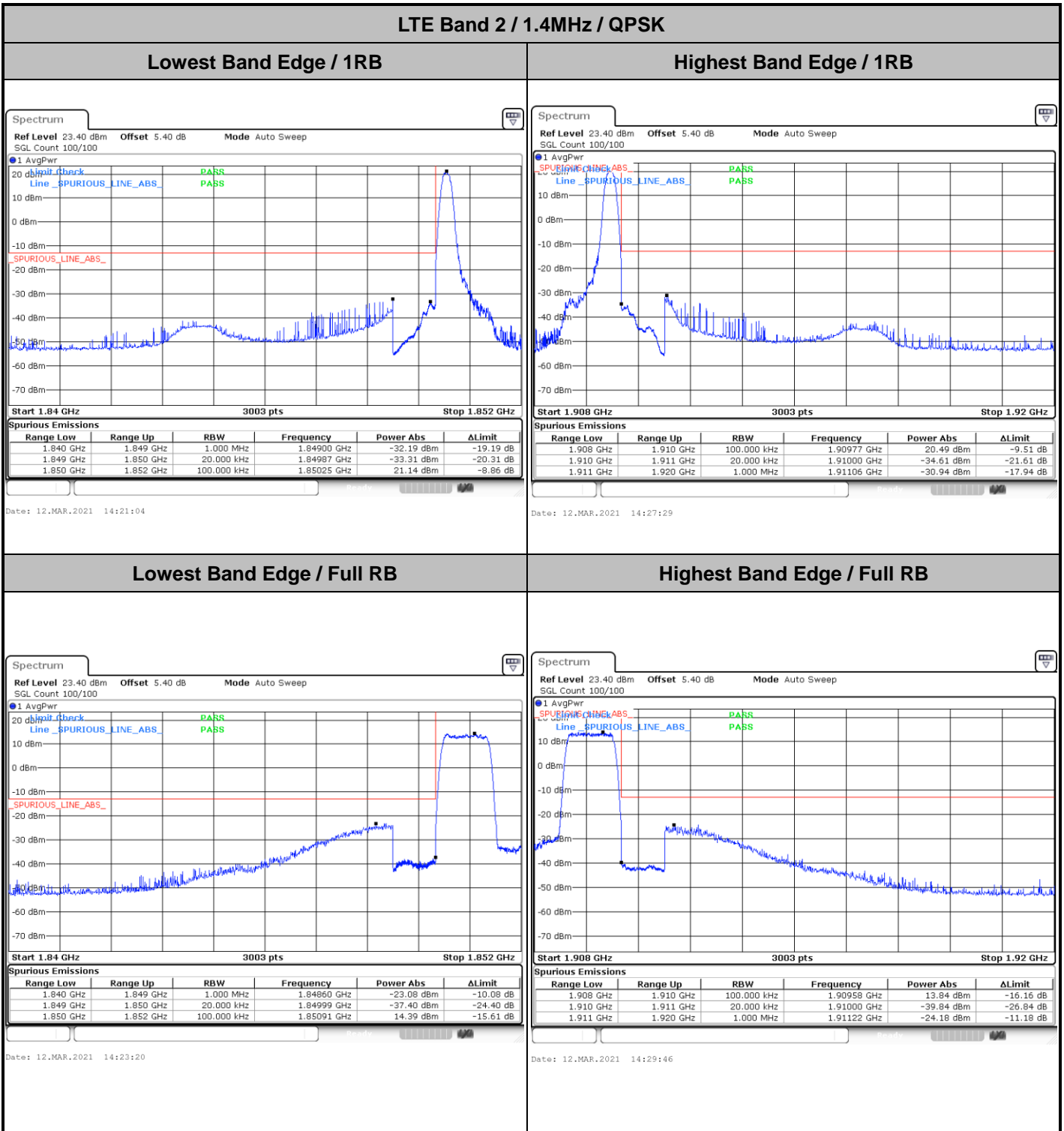



LTE Band 2 / 1.4MHz / 16QAM

Lowest Band Edge / 1 RB

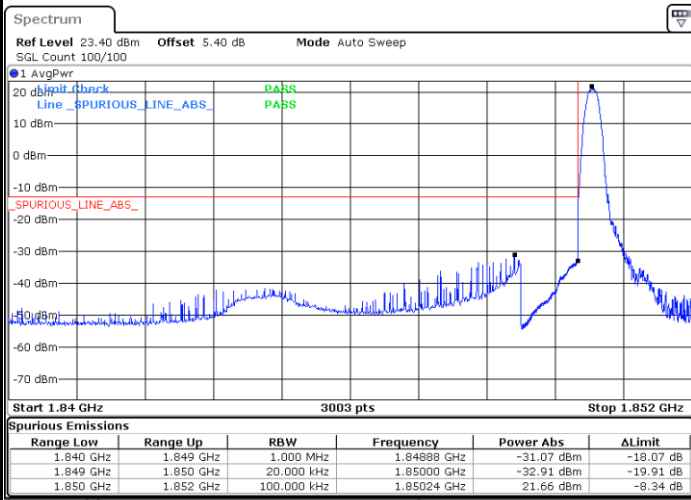

Date: 12.MAR.2021 14:22:12

Highest Band Edge / 1 RB



Date: 12.MAR.2021 14:28:38

Lowest Band Edge / Full RB

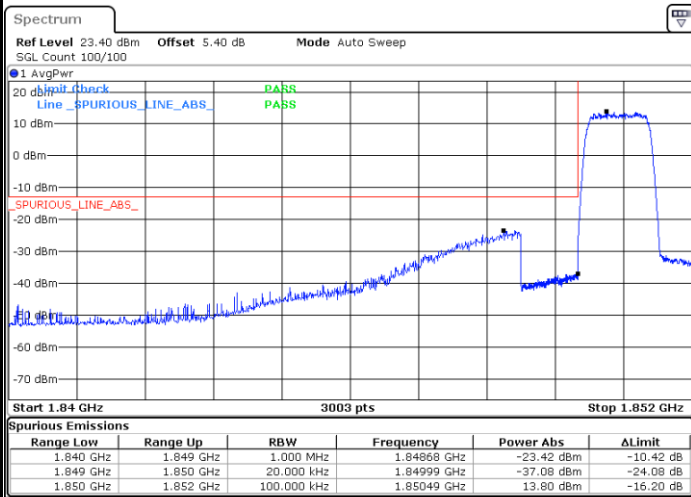

Date: 12.MAR.2021 14:24:29

Highest Band Edge / Full RB

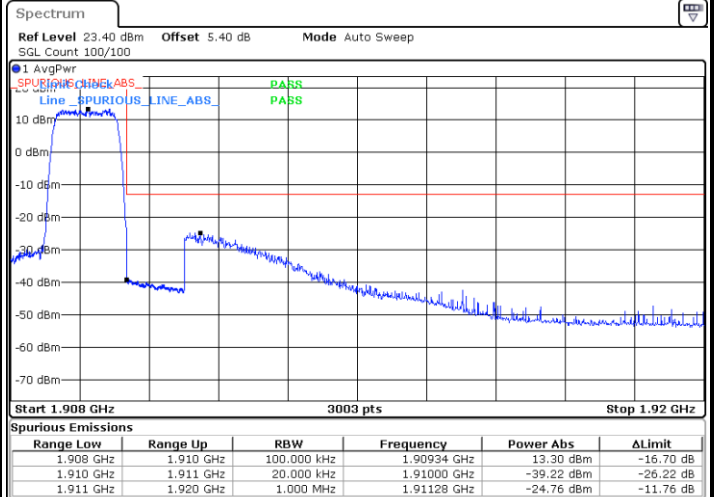

Date: 12.MAR.2021 14:30:55



LTE Band 2 / 1.4MHz / 64QAM

Lowest Band Edge / 1 RB

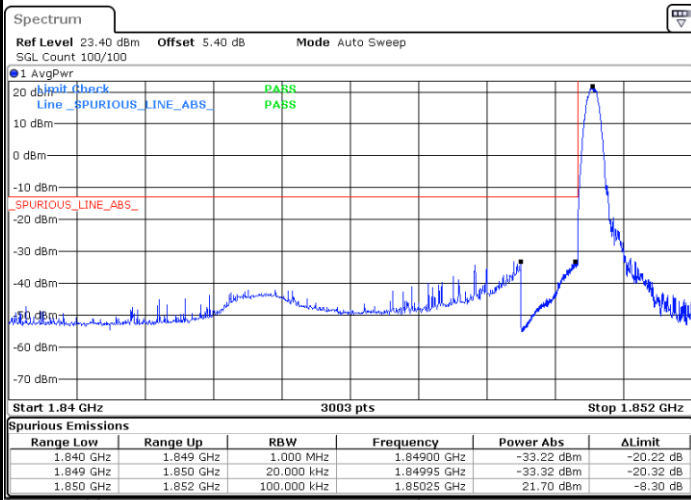

Date: 12.MAR.2021 15:59:45

Highest Band Edge / 1 RB



Date: 12.MAR.2021 15:33:59

Lowest Band Edge / Full RB

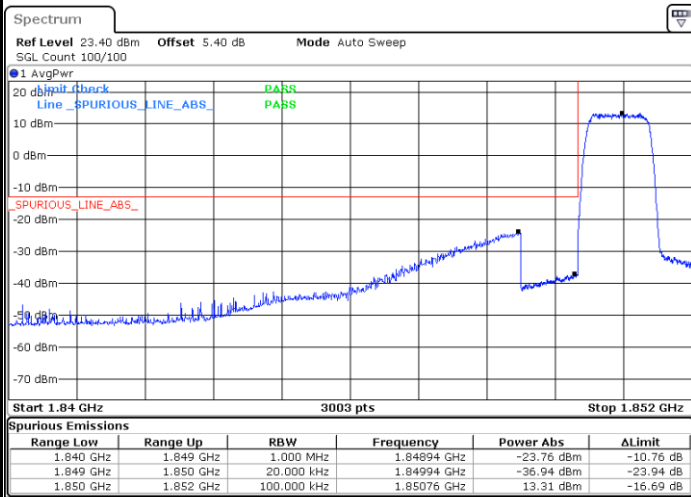

Date: 12.MAR.2021 16:01:29

Highest Band Edge / Full RB

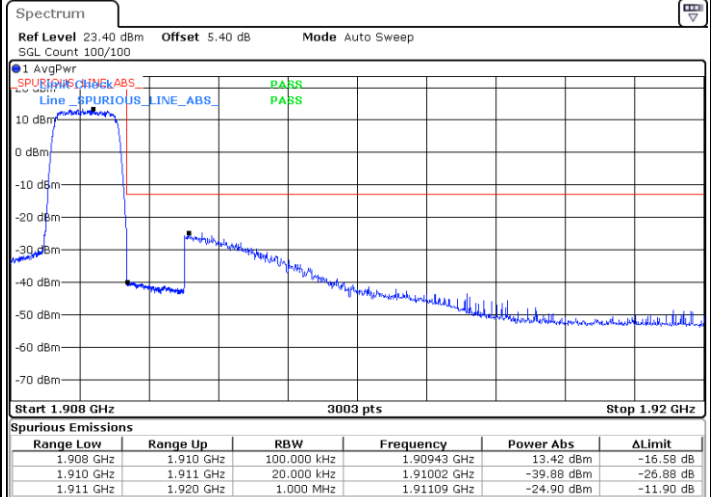

Date: 12.MAR.2021 15:35:07



LTE Band 2 / 3MHz / QPSK

Lowest Band Edge / 1RB

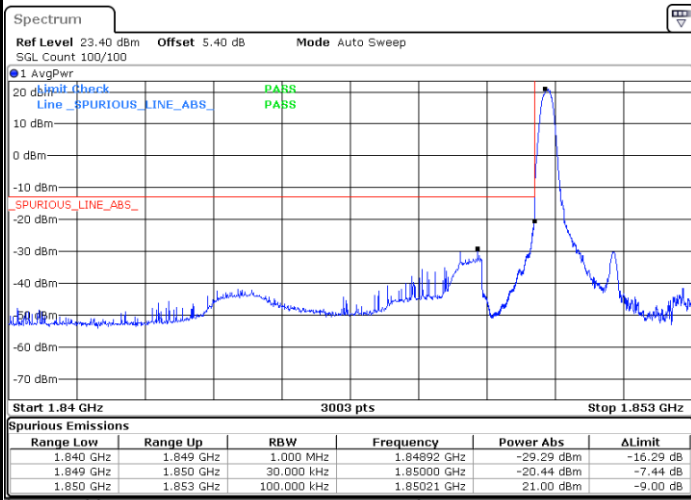

Date: 12.MAR.2021 14:32:59

Highest Band Edge / 1 RB

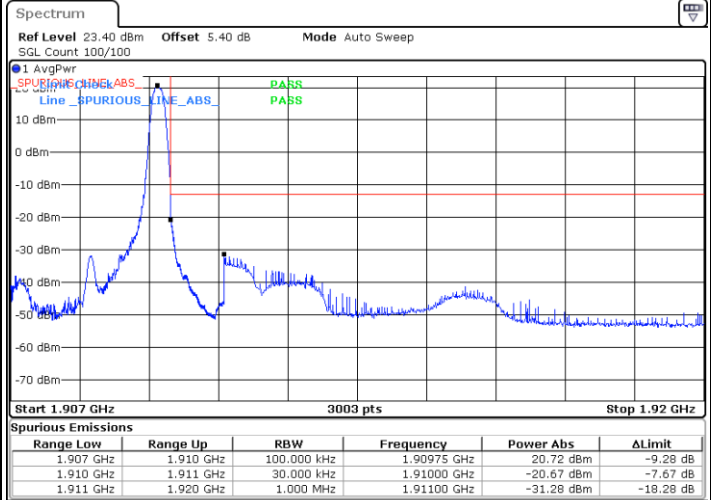

Date: 12.MAR.2021 14:41:45

Lowest Band Edge / Full RB

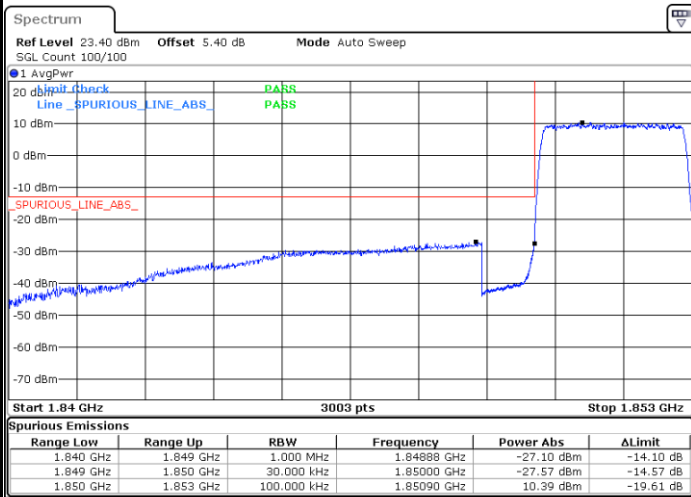

Date: 12.MAR.2021 14:35:16

Highest Band Edge / Full RB

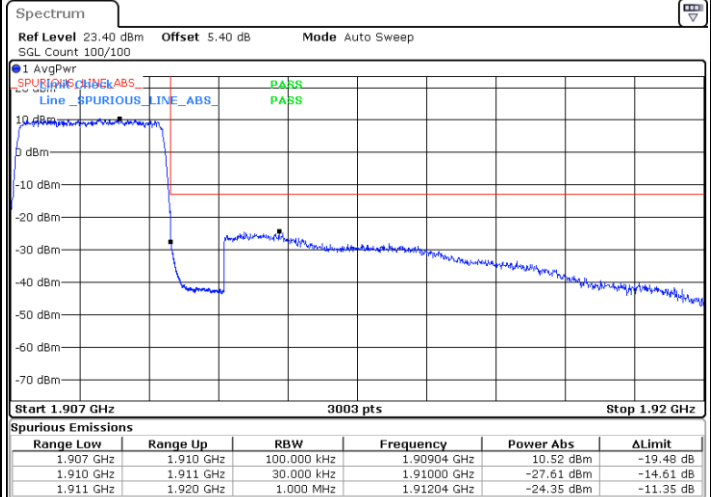

Date: 12.MAR.2021 14:44:02



LTE Band 2 / 3MHz / 16QAM

Lowest Band Edge / 1 RB

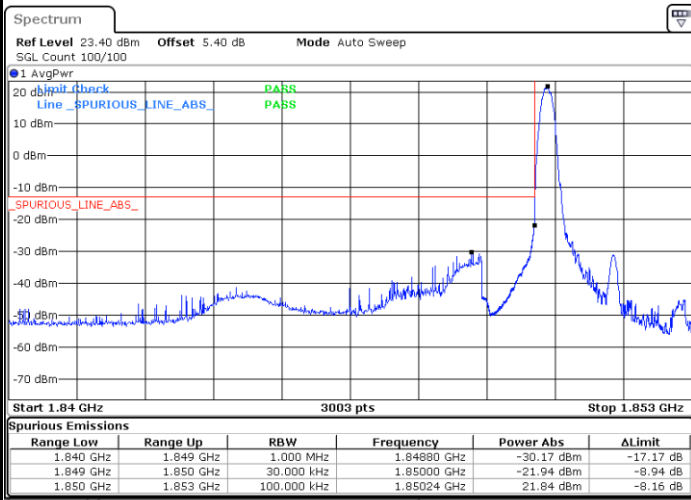

Date: 12.MAR.2021 15:36:15

Highest Band Edge / 1 RB

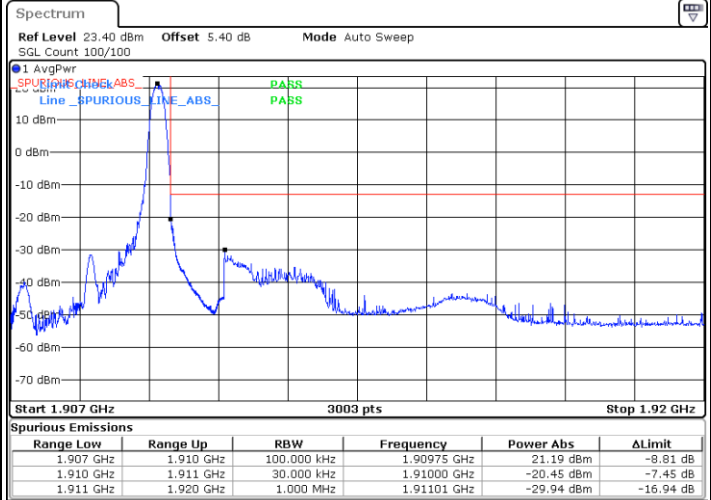

Date: 12.MAR.2021 14:42:53

Lowest Band Edge / Full RB

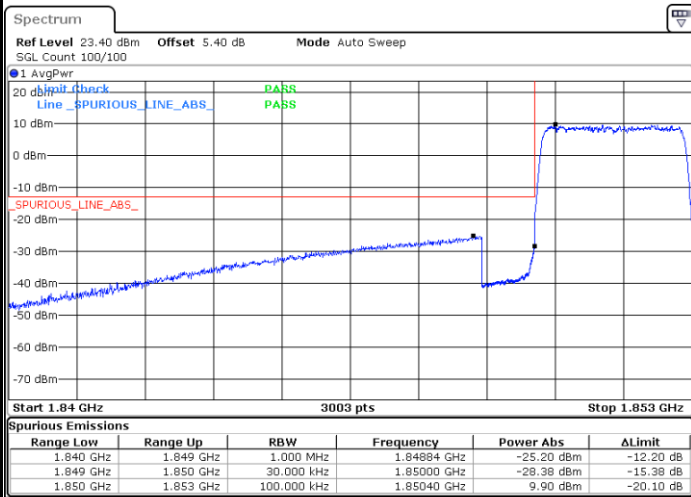

Date: 12.MAR.2021 14:36:24

Highest Band Edge / Full RB

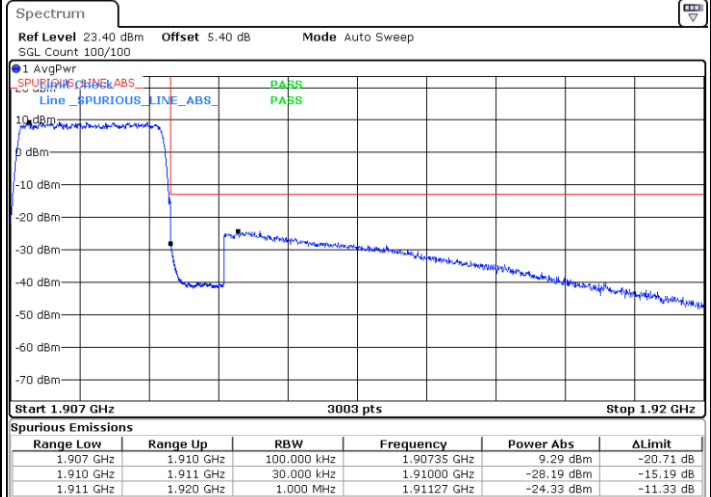

Date: 12.MAR.2021 14:45:10



LTE Band 2 / 3MHz / 64QAM

Lowest Band Edge / 1 RB

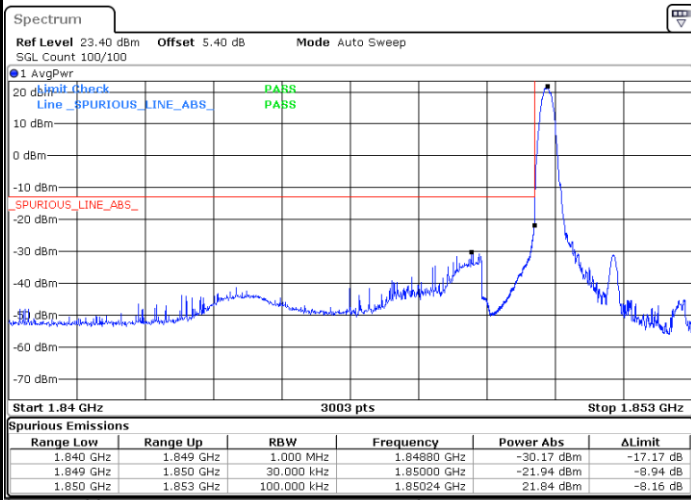

Date: 12.MAR.2021 15:36:15

Highest Band Edge / 1 RB

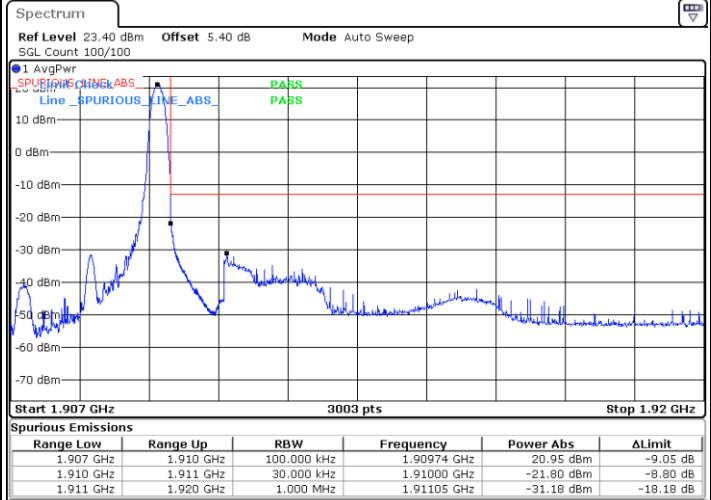

Date: 12.MAR.2021 15:39:39

Lowest Band Edge / Full RB

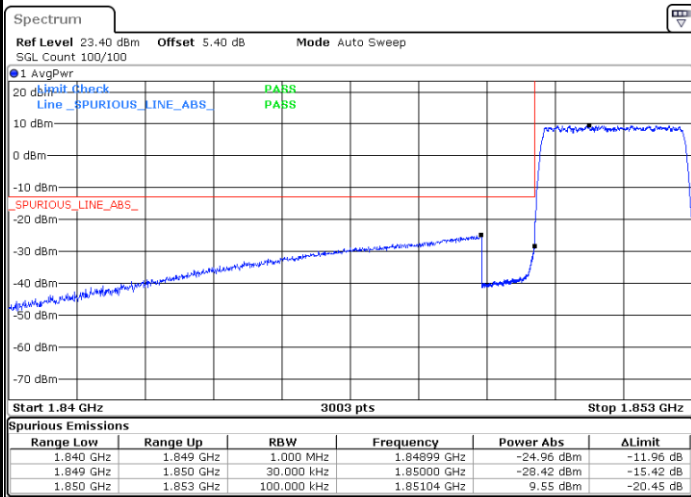

Date: 12.MAR.2021 15:37:23

Highest Band Edge / Full RB

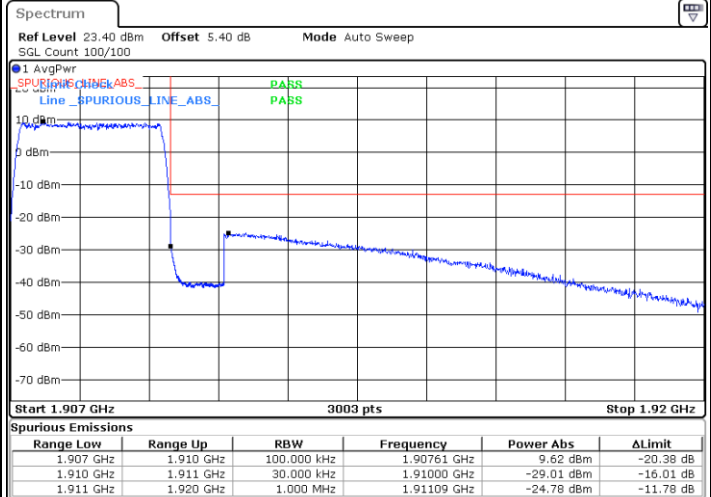

Date: 12.MAR.2021 15:38:31



LTE Band 2 / 5MHz / QPSK

Lowest Band Edge / 1 RB

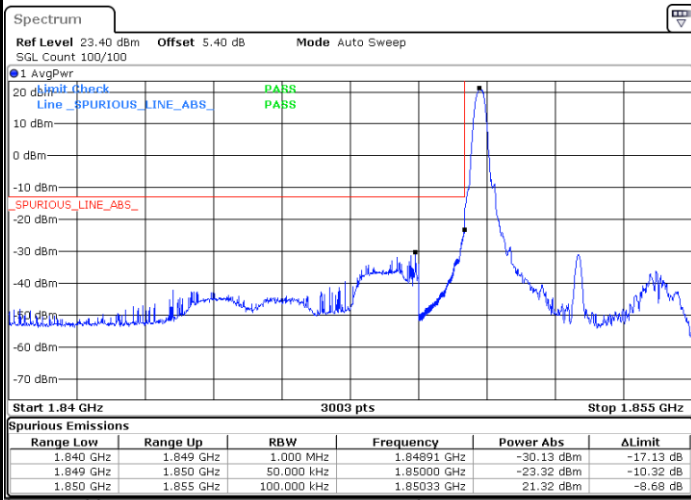

Date: 12.MAR.2021 14:46:31

Highest Band Edge / 1 RB

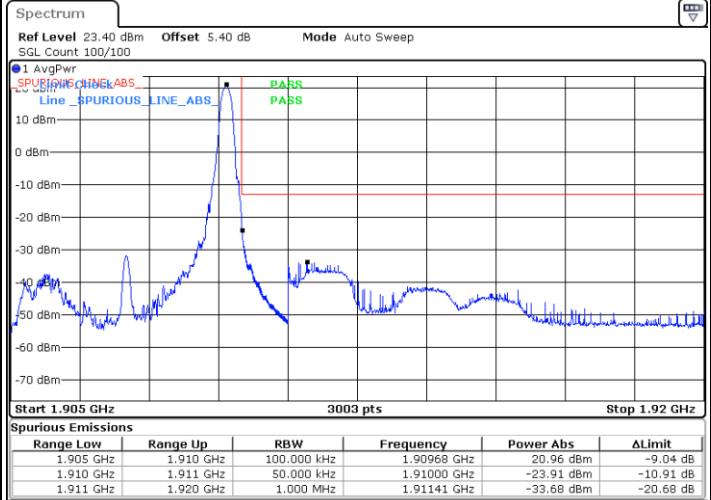

Date: 12.MAR.2021 14:53:12

Lowest Band Edge / Full RB

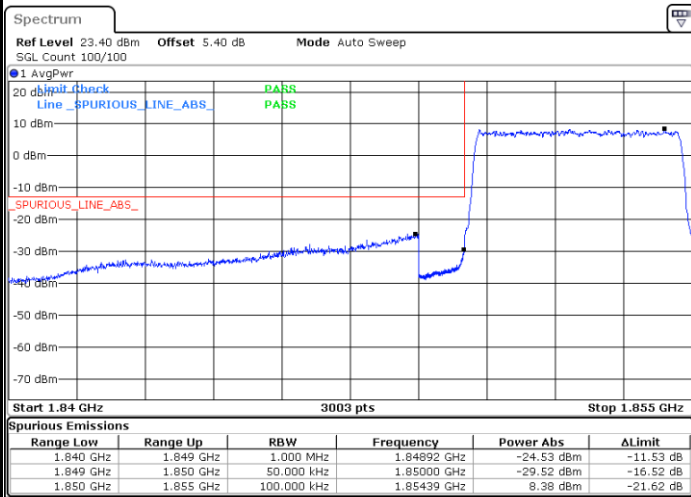

Date: 12.MAR.2021 14:48:47

Highest Band Edge / Full RB

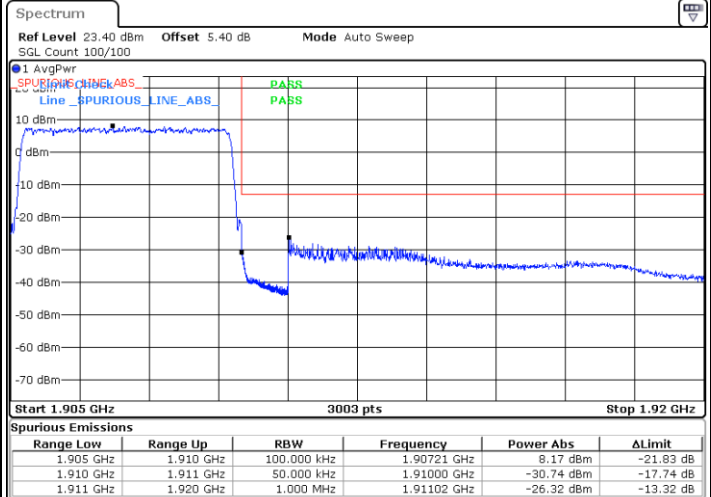

Date: 12.MAR.2021 14:55:28



LTE Band 2 / 5MHz / 16QAM

Lowest Band Edge / 1RB

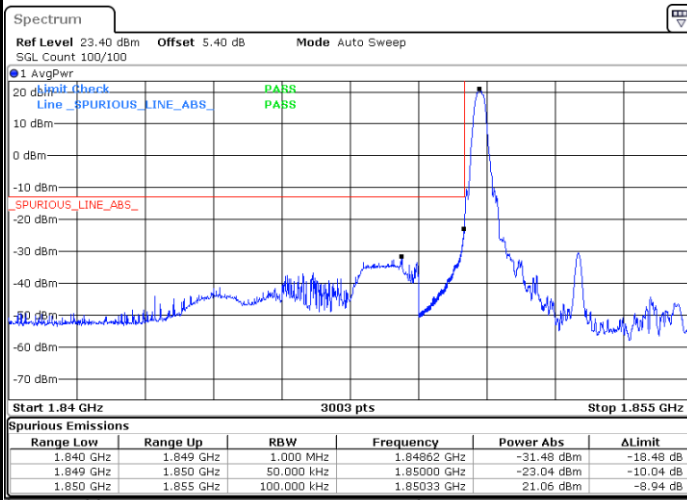

Date: 12.MAR.2021 14:47:39

Highest Band Edge / 1 RB

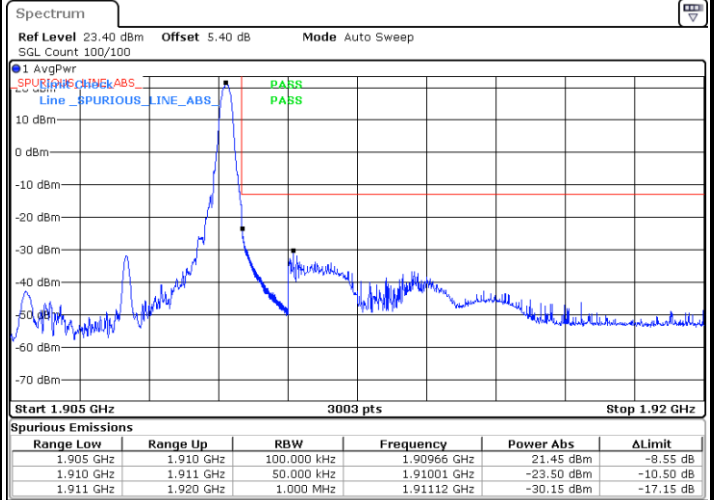

Date: 12.MAR.2021 14:54:20

Lowest Band Edge / Full RB

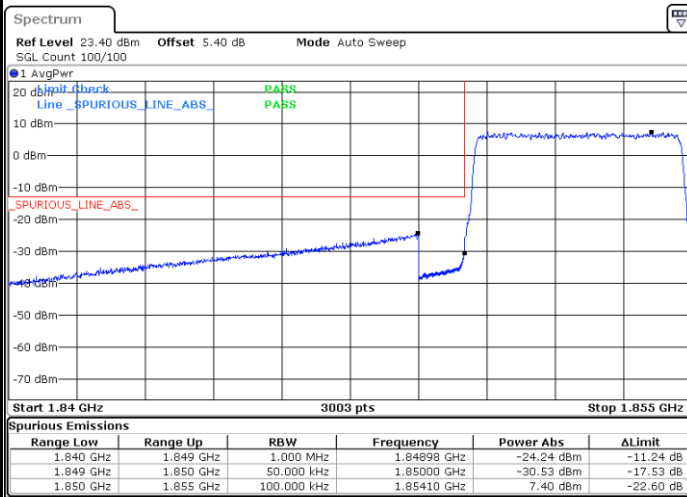

Date: 12.MAR.2021 14:49:55

Highest Band Edge / Full RB

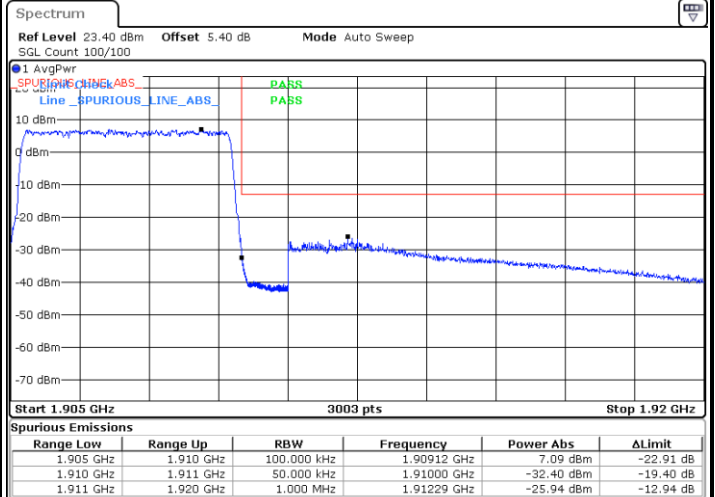

Date: 12.MAR.2021 14:56:36



LTE Band 2 / 5MHz / 64QAM

Lowest Band Edge / 1RB

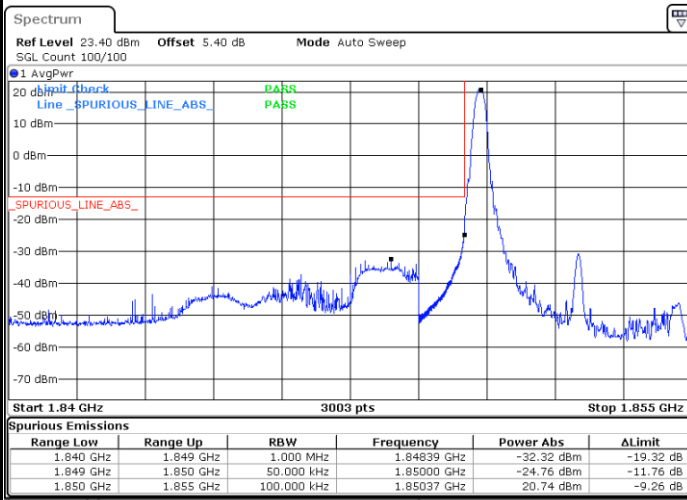

Date: 12.MAR.2021 15:40:47

Highest Band Edge / 1 RB

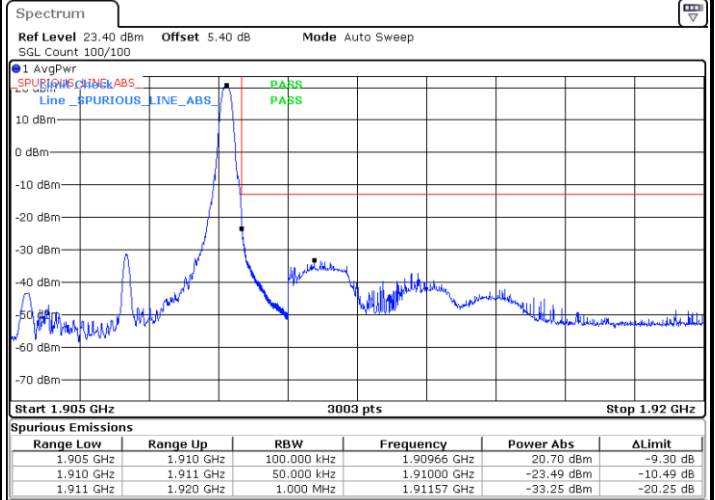

Date: 12.MAR.2021 15:44:11

Lowest Band Edge / Full RB

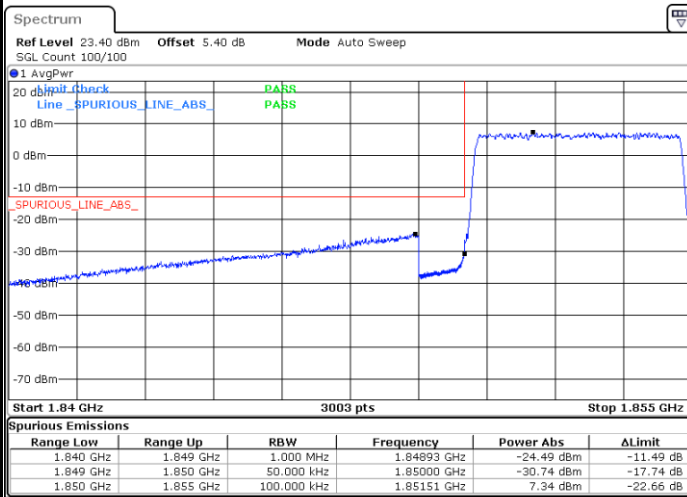

Date: 12.MAR.2021 15:41:55

Highest Band Edge / Full RB

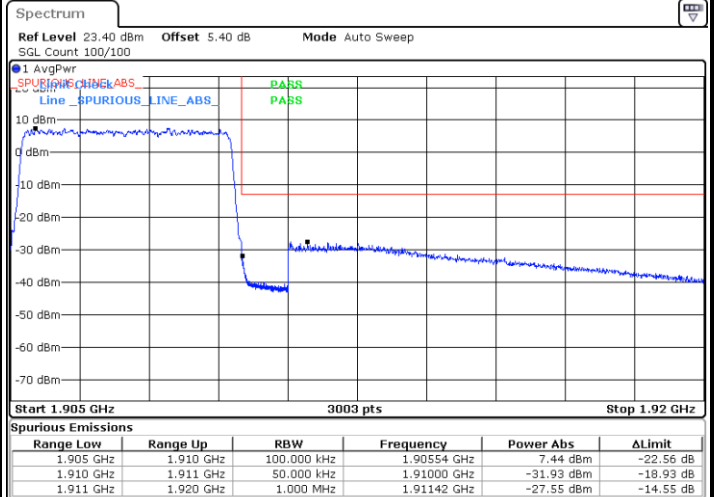

Date: 12.MAR.2021 15:43:03



LTE Band 2 / 10MHz / QPSK

Lowest Band Edge / 1 RB

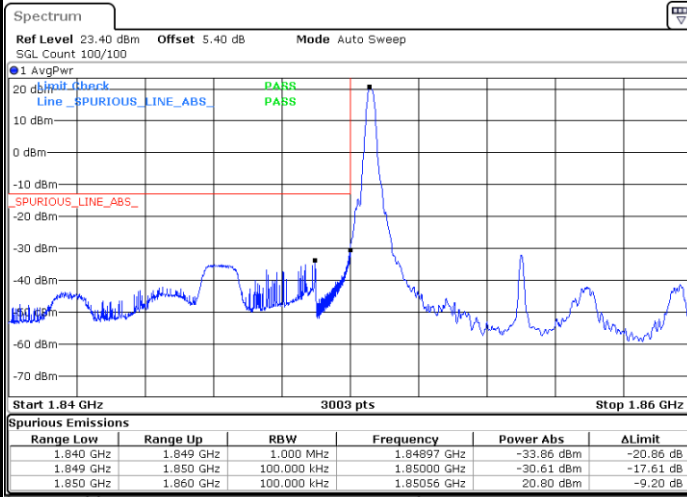

Date: 12.MAR.2021 15:03:36

Highest Band Edge / 1 RB

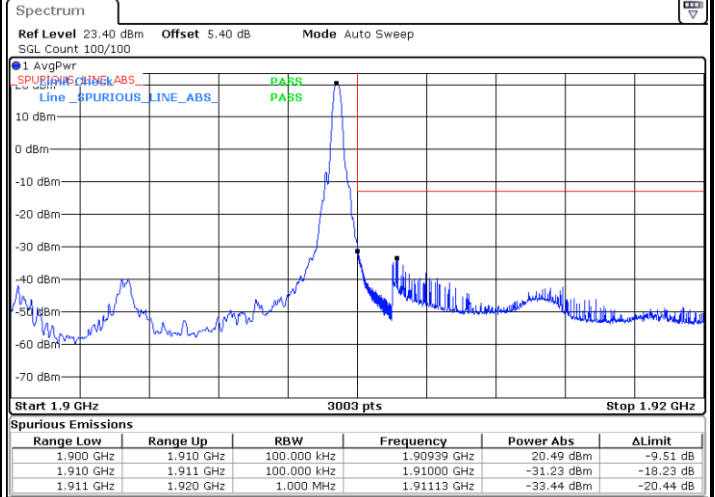

Date: 12.MAR.2021 15:08:08

Lowest Band Edge / Full RB

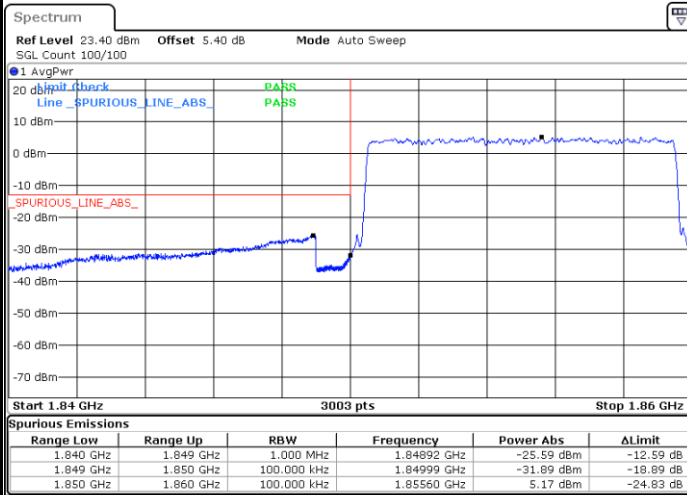

Date: 12.MAR.2021 15:05:51

Highest Band Edge / Full RB

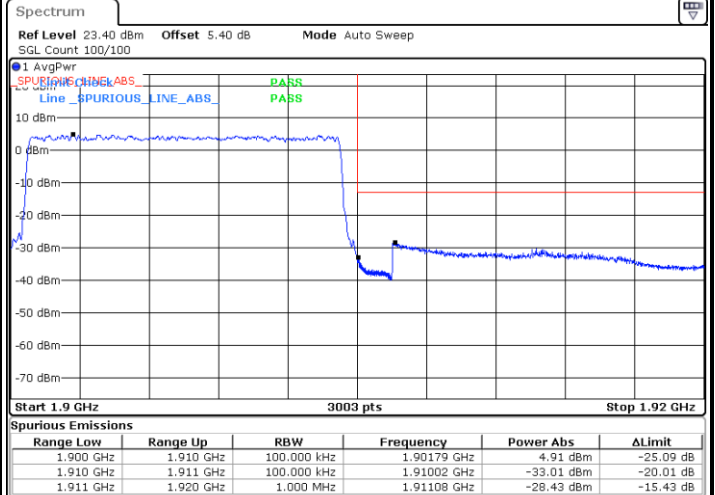

Date: 12.MAR.2021 15:10:24



LTE Band 2 / 10MHz / 16QAM

Lowest Band Edge / 1 RB

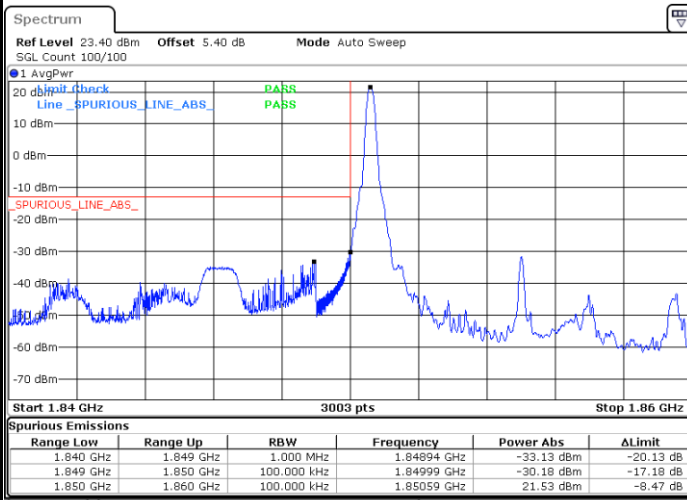

Date: 12.MAR.2021 15:04:44

Highest Band Edge / 1 RB

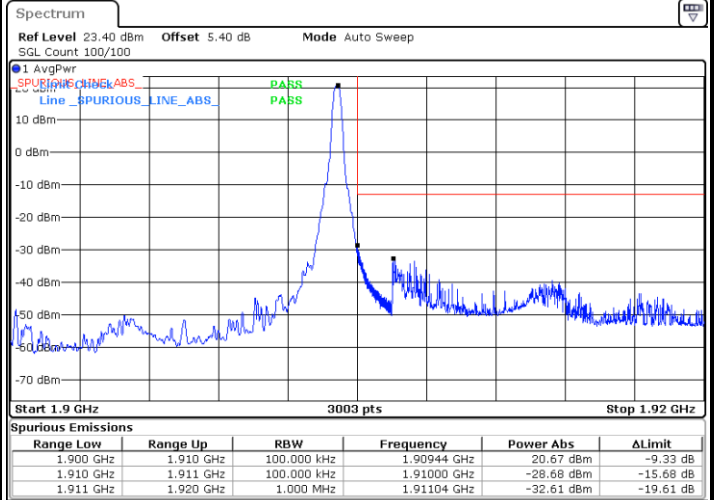

Date: 12.MAR.2021 15:09:16

Lowest Band Edge / Full RB

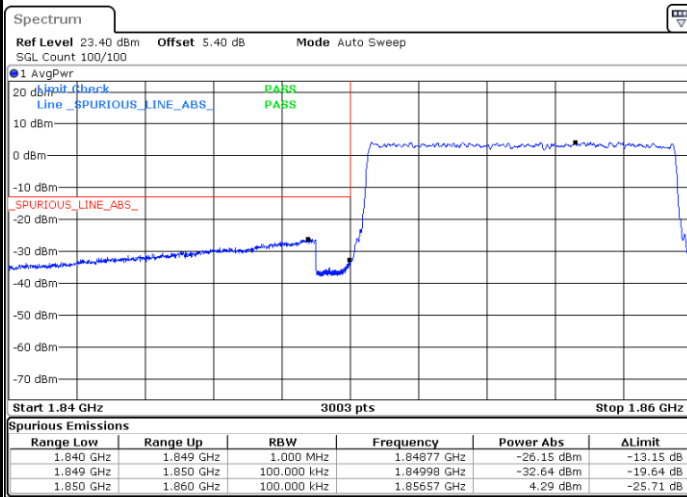

Date: 12.MAR.2021 15:06:59

Highest Band Edge / Full RB

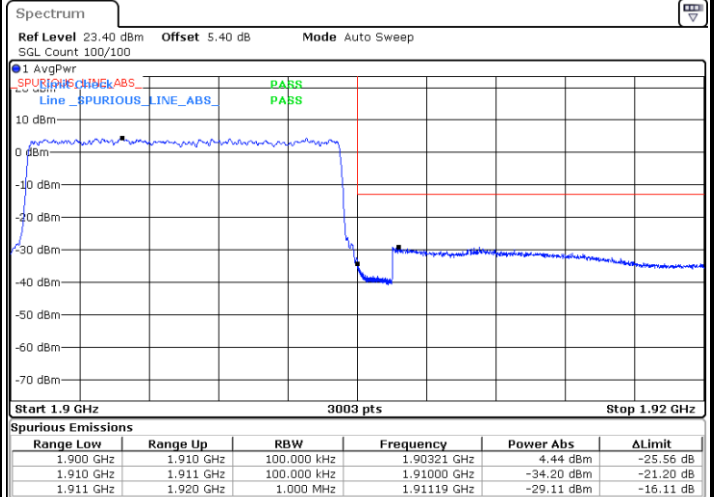

Date: 12.MAR.2021 15:11:32



LTE Band 2 / 10MHz / 64QAM

Lowest Band Edge / 1 RB

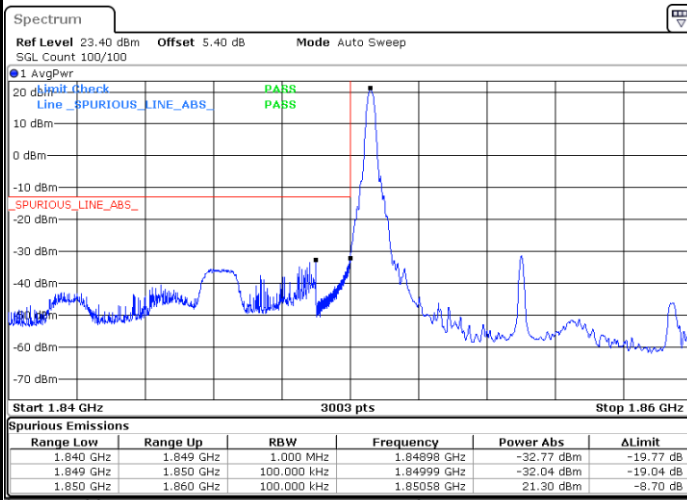

Date: 12.MAR.2021 15:45:19

Highest Band Edge / 1 RB

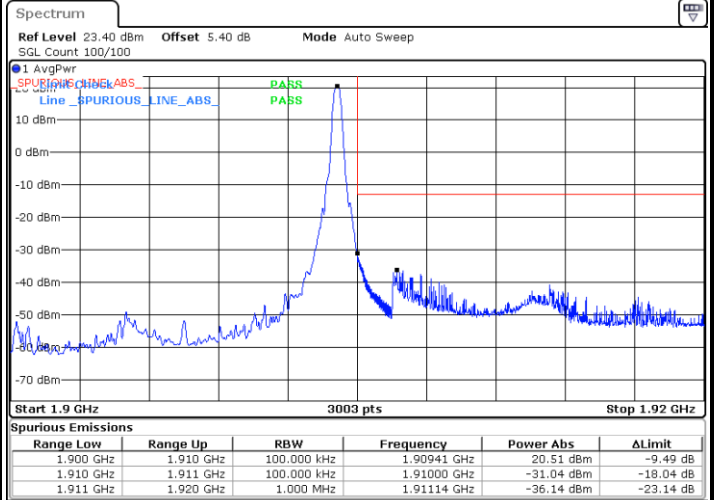

Date: 12.MAR.2021 15:48:42

Lowest Band Edge / Full RB

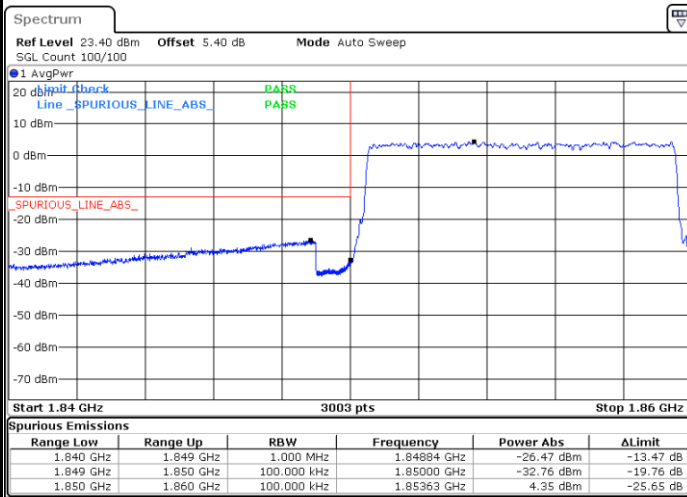

Date: 12.MAR.2021 15:46:26

Highest Band Edge / Full RB

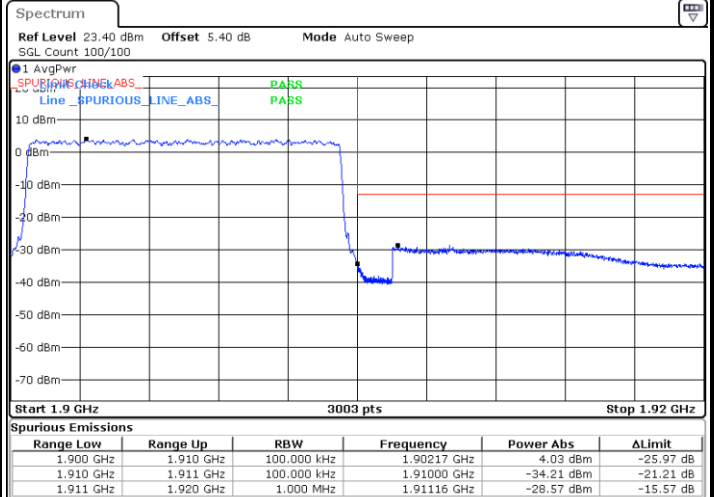

Date: 12.MAR.2021 15:47:34



LTE Band 2 / 15MHz / QPSK

Lowest Band Edge / 1 RB

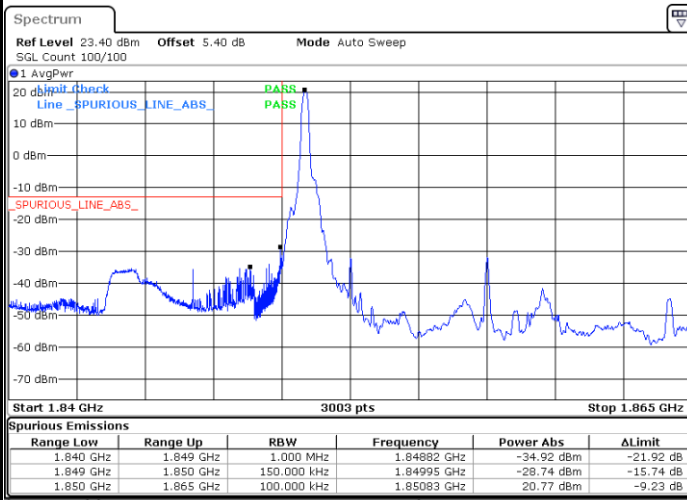

Date: 12.MAR.2021 15:12:40

Highest Band Edge / 1 RB



Date: 12.MAR.2021 15:17:11

Lowest Band Edge / Full RB

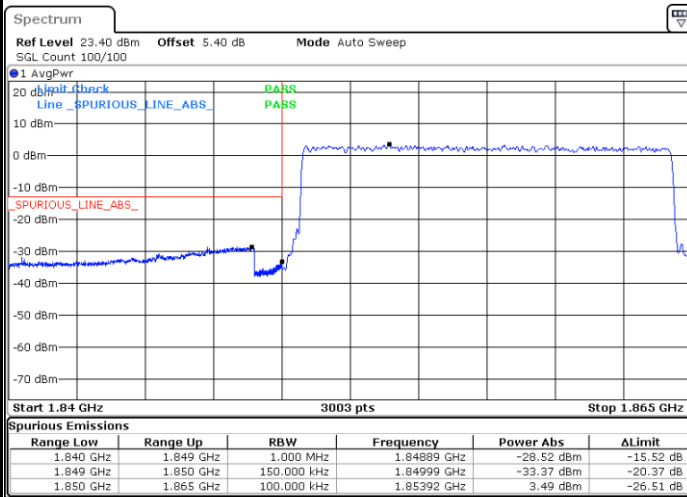

Date: 12.MAR.2021 15:14:56

Highest Band Edge / Full RB



Date: 12.MAR.2021 15:19:27



LTE Band 2 / 15MHz / 16QAM

Lowest Band Edge / 1 RB

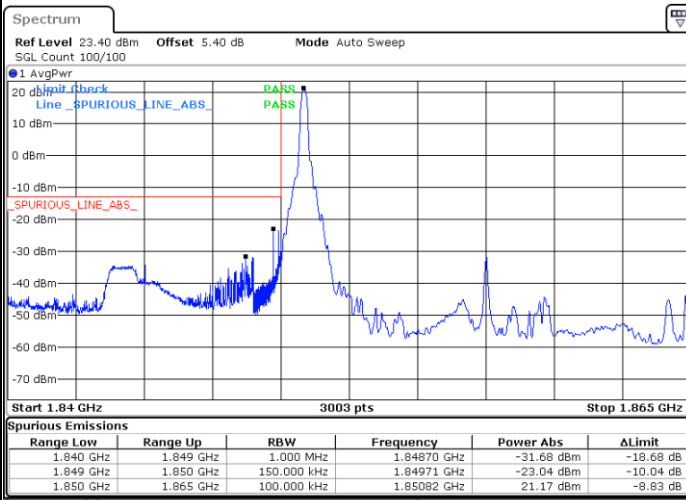

Date: 12.MAR.2021 15:13:48

Highest Band Edge / 1 RB

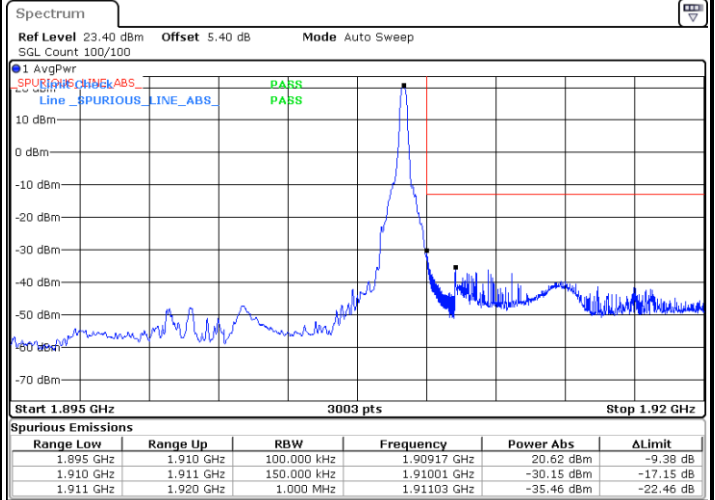

Date: 12.MAR.2021 15:18:19

Lowest Band Edge / Full RB

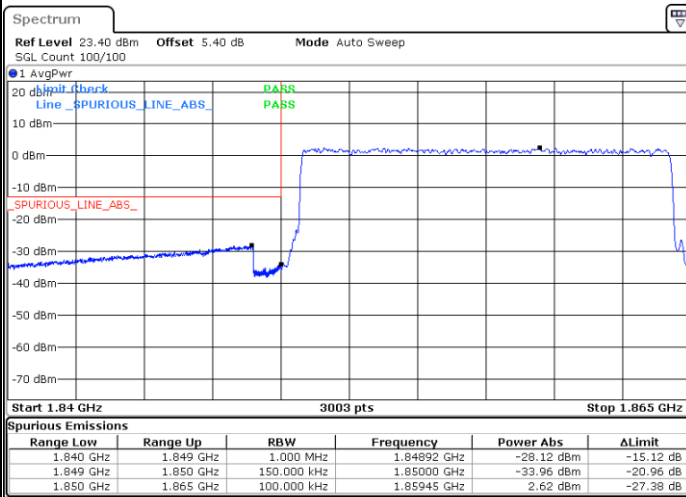

Date: 12.MAR.2021 15:16:03

Highest Band Edge / Full RB

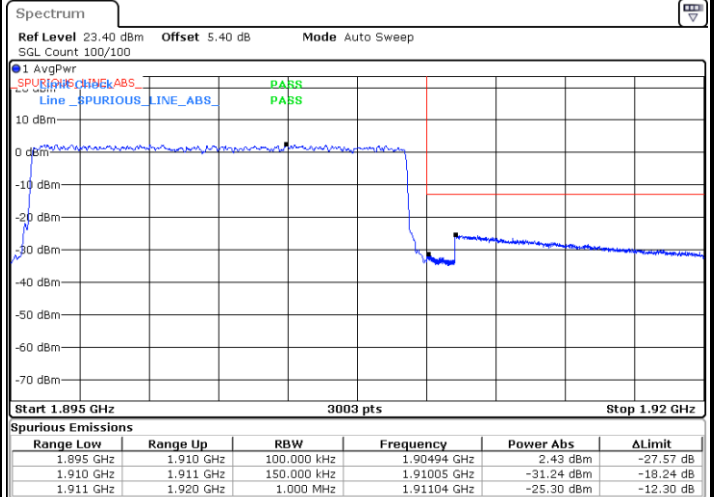

Date: 12.MAR.2021 15:20:35



LTE Band 2 / 15MHz / 64QAM

Lowest Band Edge / 1 RB

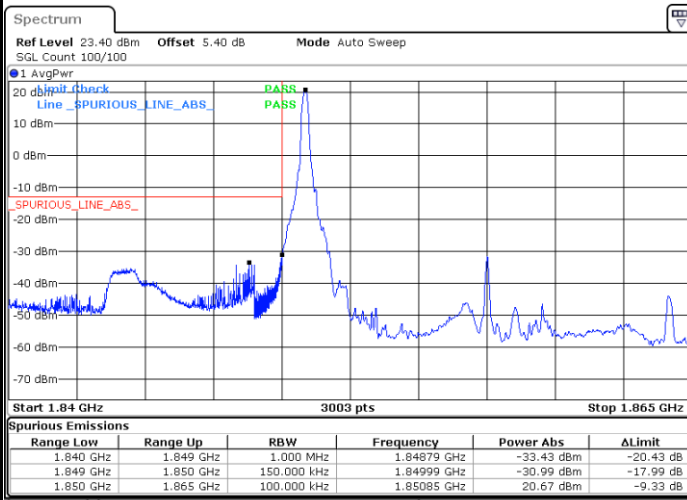

Date: 12.MAR.2021 15:49:50

Highest Band Edge / 1 RB



Date: 12.MAR.2021 15:53:14

Lowest Band Edge / Full RB

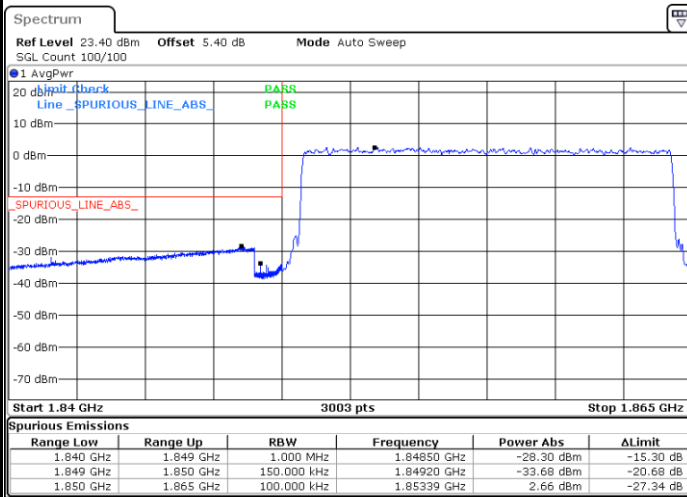

Date: 12.MAR.2021 15:50:58

Highest Band Edge / Full RB

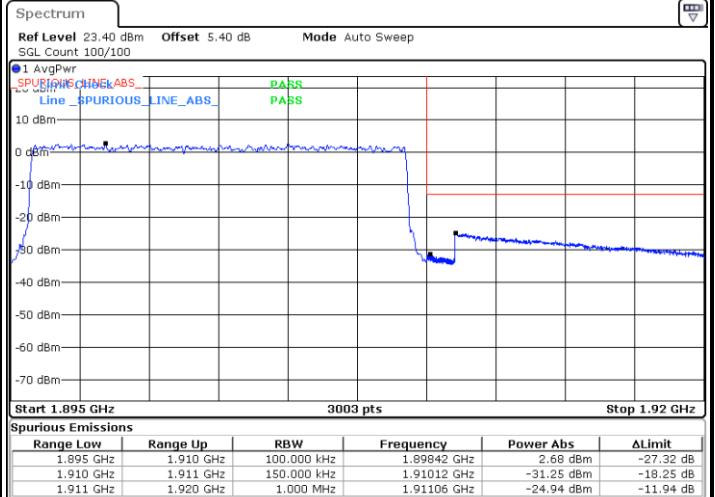

Date: 12.MAR.2021 15:52:06



LTE Band 2 / 20MHz / QPSK

Lowest Band Edge / 1 RB

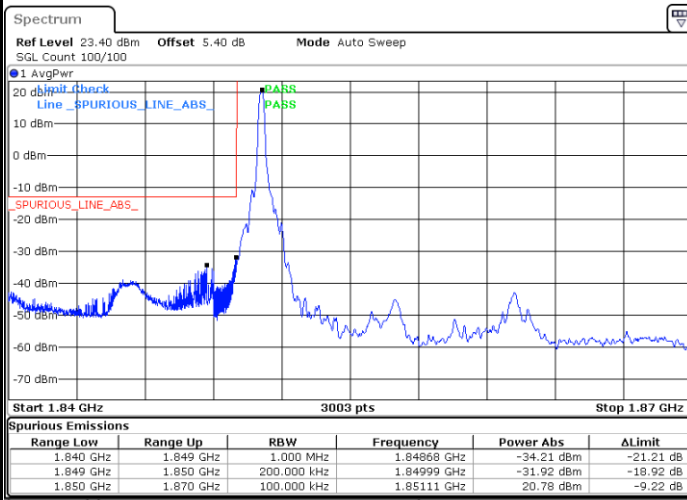

Date: 12.MAR.2021 15:21:43

Highest Band Edge / 1 RB



Date: 12.MAR.2021 15:26:15

Lowest Band Edge / Full RB

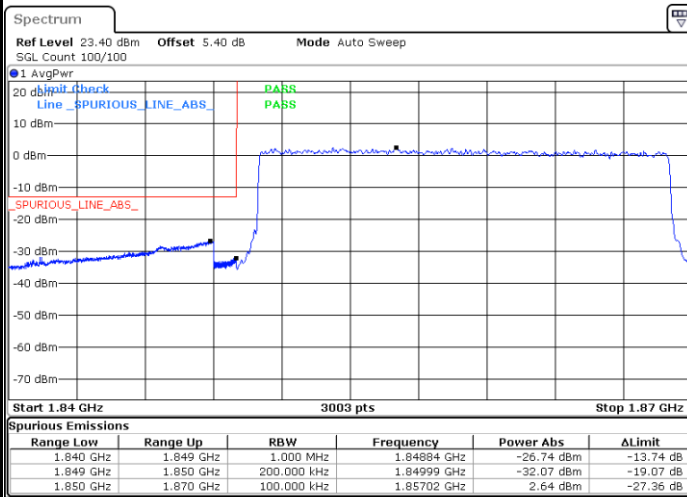

Date: 12.MAR.2021 15:23:59

Highest Band Edge / Full RB

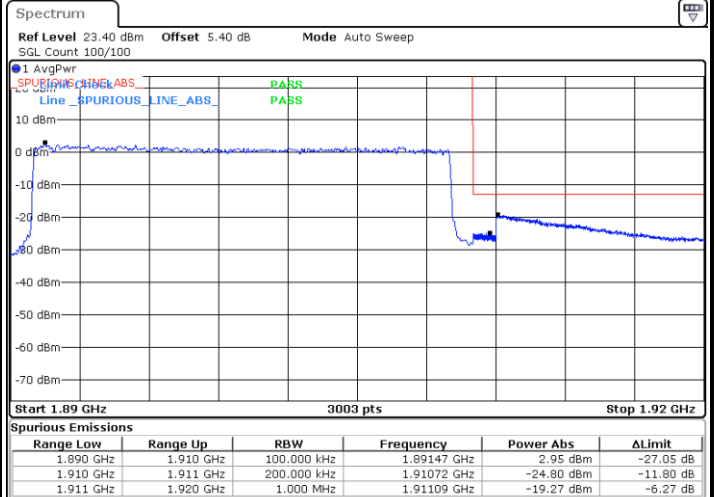

Date: 12.MAR.2021 15:28:30



LTE Band 2 / 20MHz / 16QAM

Lowest Band Edge / 1 RB

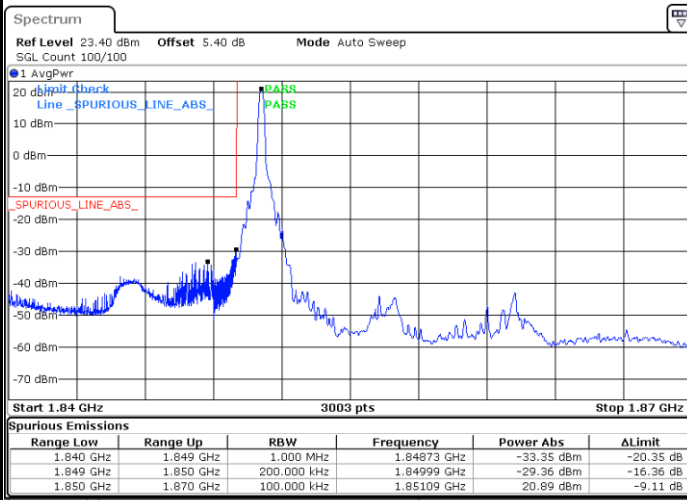

Date: 12.MAR.2021 15:22:51

Highest Band Edge / 1 RB



Date: 12.MAR.2021 15:27:23

Lowest Band Edge / Full RB

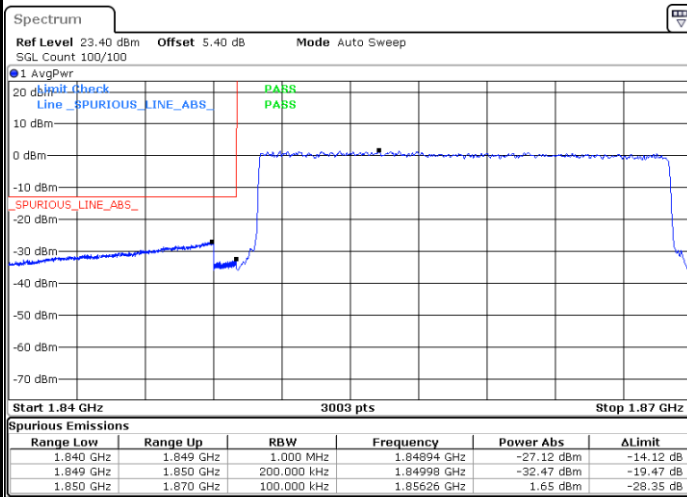

Date: 12.MAR.2021 15:25:07

Highest Band Edge / Full RB

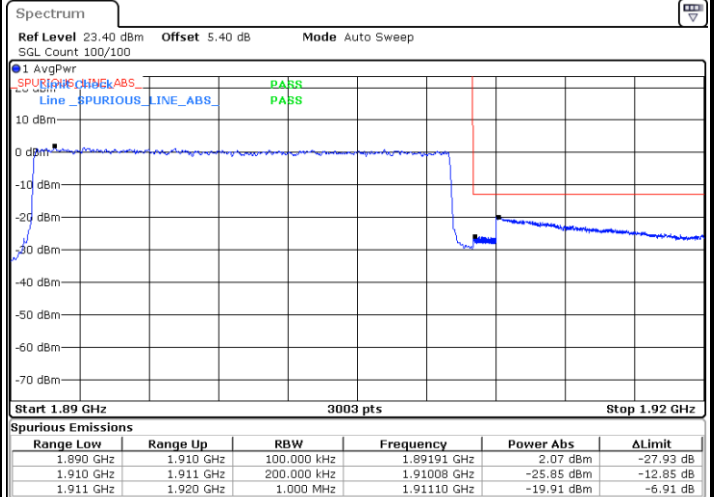

Date: 12.MAR.2021 15:29:38



LTE Band 2 / 20MHz / 64QAM

Lowest Band Edge / 1 RB

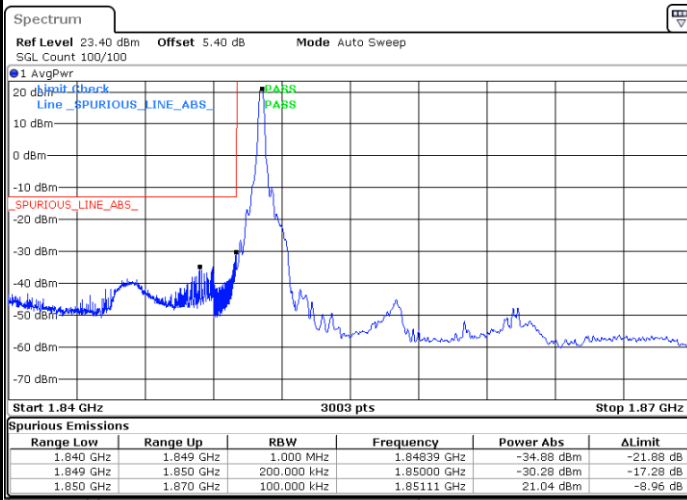

Date: 12.MAR.2021 15:54:21

Highest Band Edge / 1 RB



Date: 12.MAR.2021 15:57:45

Lowest Band Edge / Full RB

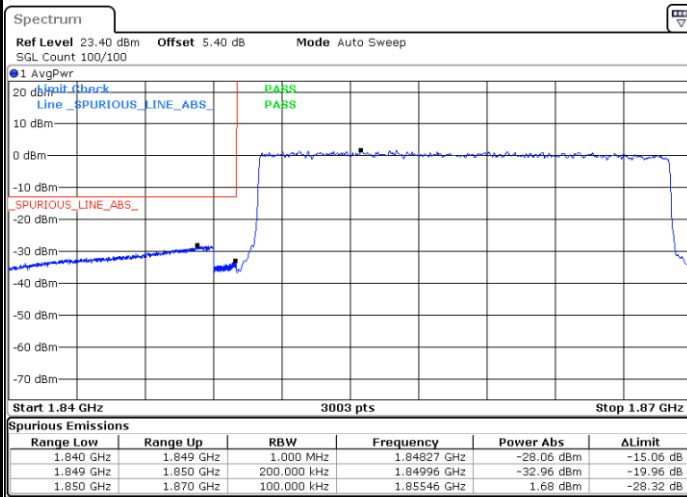

Date: 12.MAR.2021 15:55:29

Highest Band Edge / Full RB

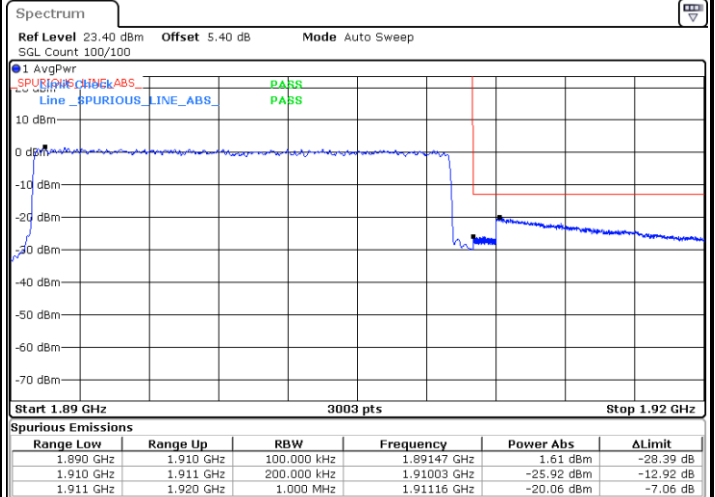

Date: 12.MAR.2021 15:56:37



Conducted Spurious Emission

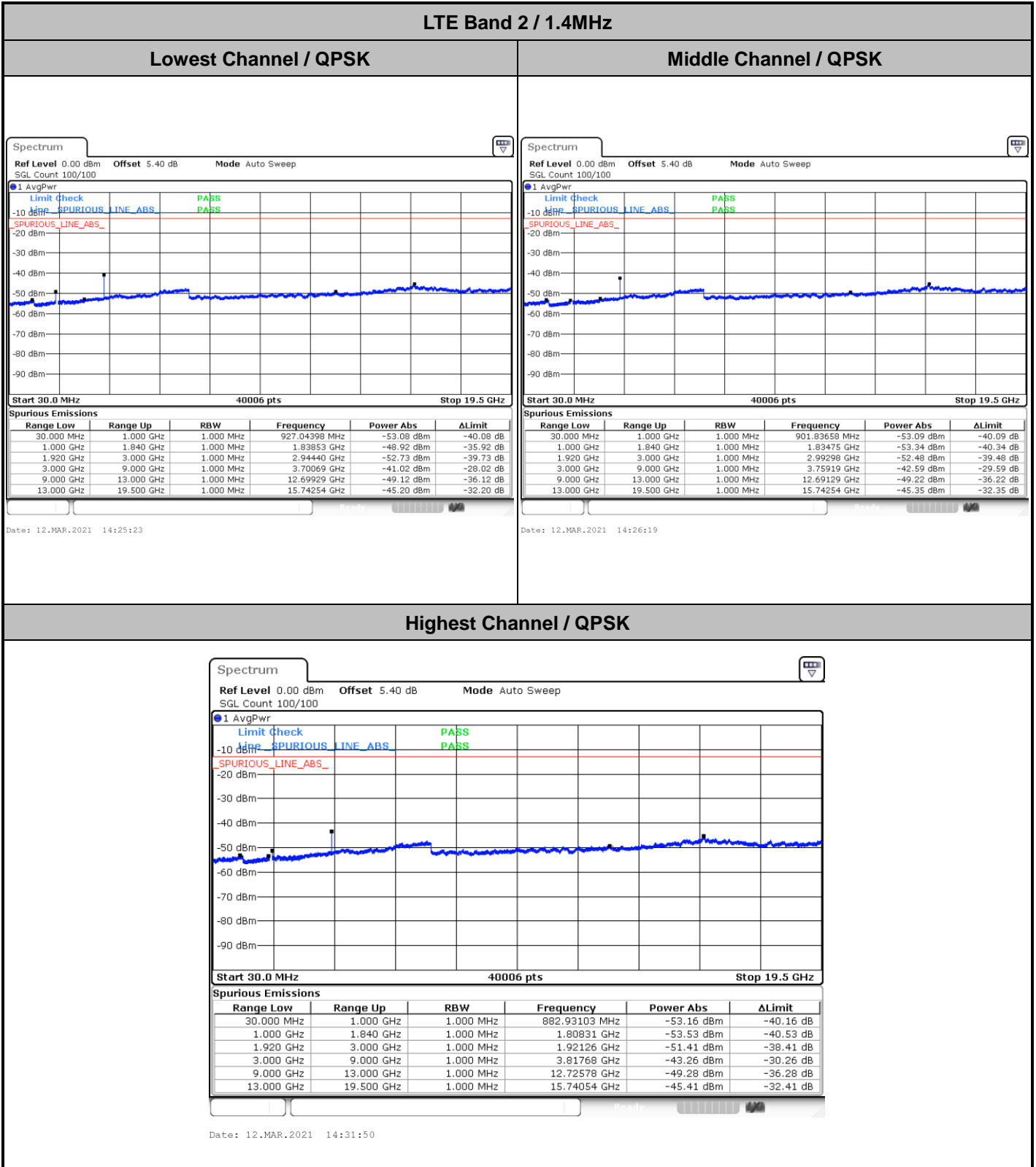



LTE Band 2 / 3MHz

Lowest Channel / QPSK

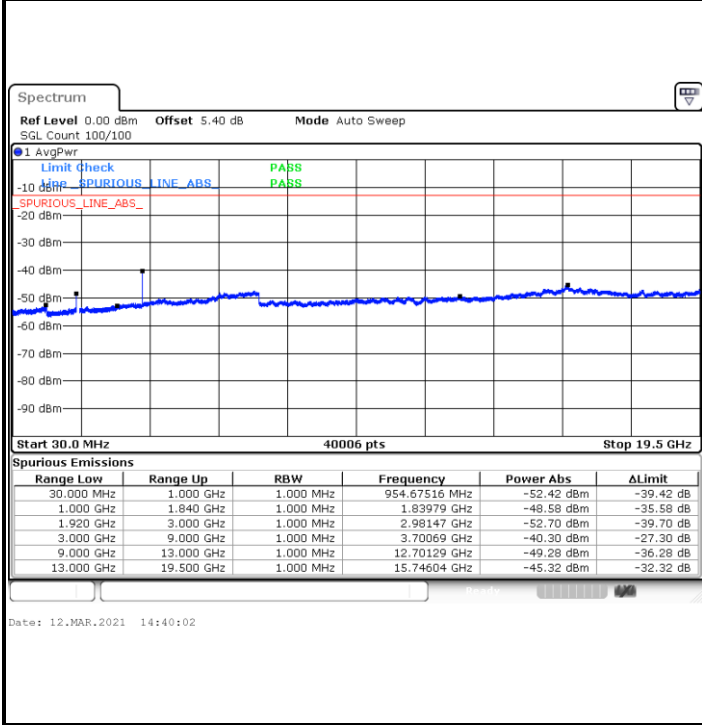

Middle Channel / QPSK

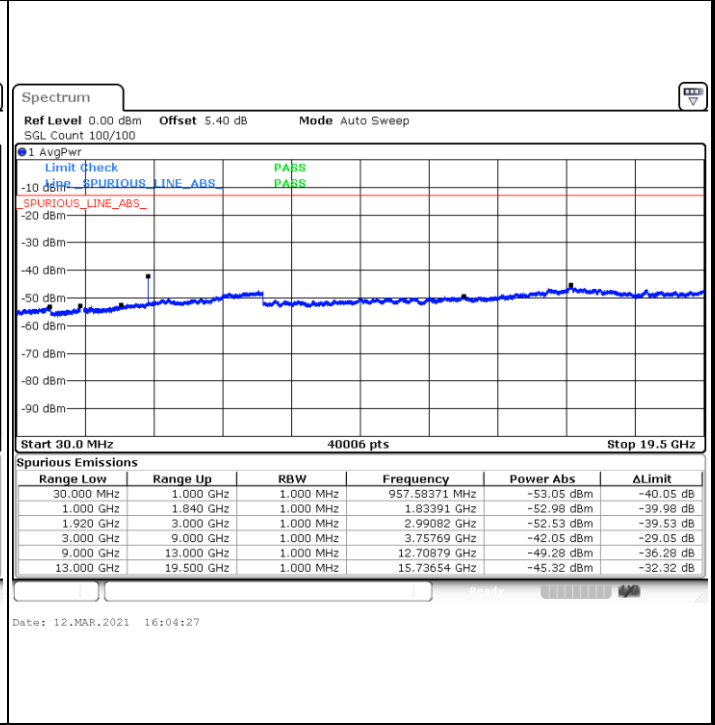

Highest Channel / QPSK

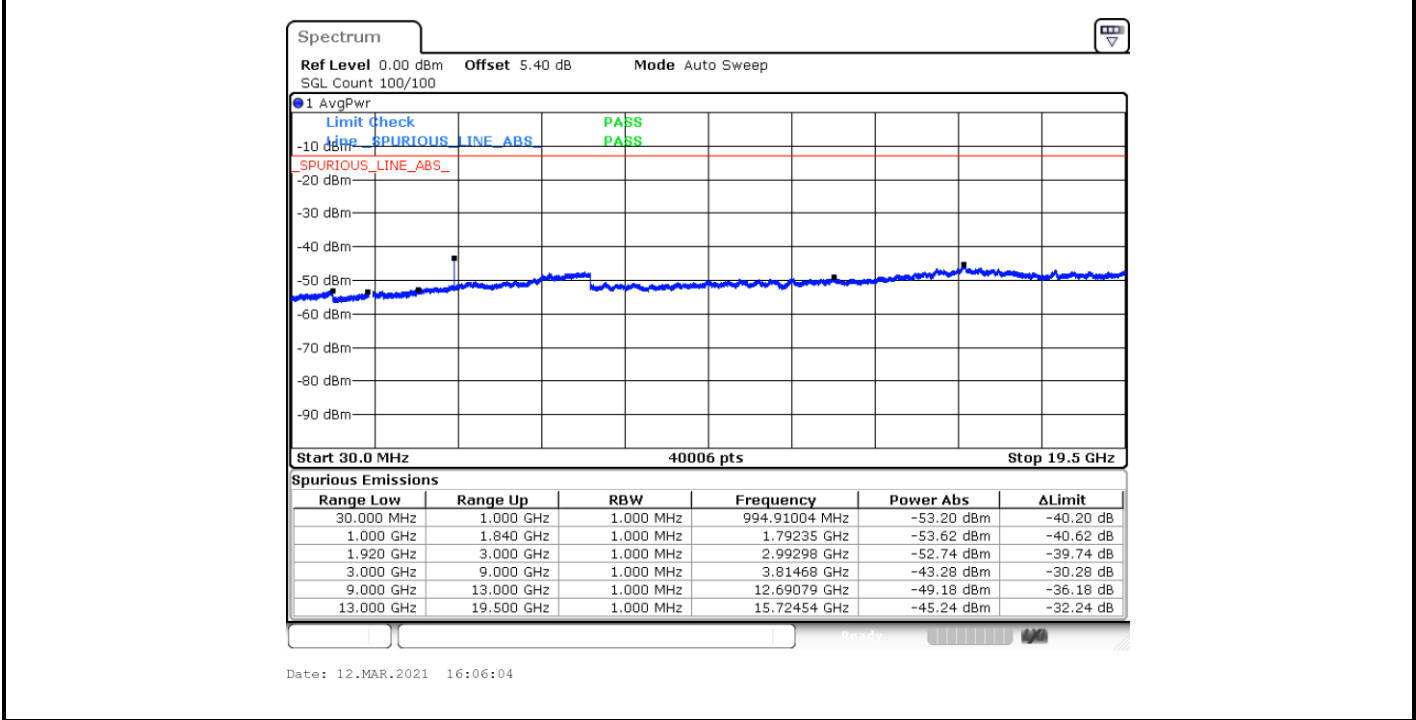



LTE Band 2 / 5MHz

Lowest Channel / QPSK

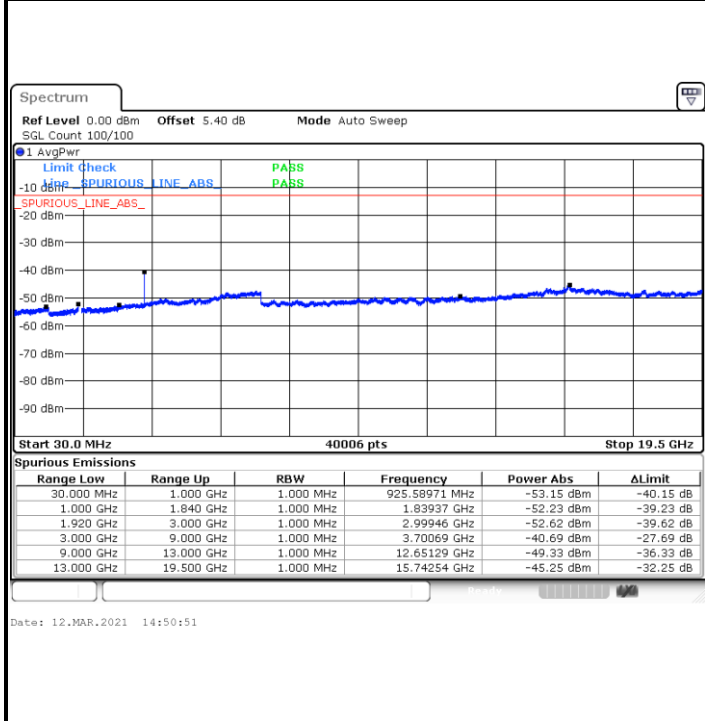

Middle Channel / QPSK

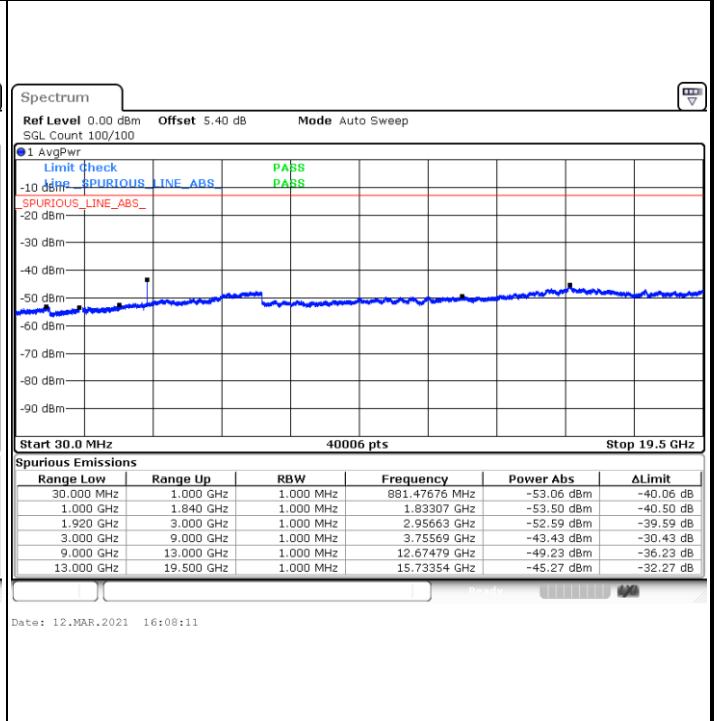

Highest Channel / QPSK

