



# FCC RF Test Report

**APPLICANT** : Motorola Mobility LLC  
**EQUIPMENT** : Mobile Cellular Phone  
**BRAND NAME** : Motorola  
**MODEL NAME** : XT2087-2  
**FCC ID** : IHDT56ZE2  
**STANDARD** : 47 CFR Part 2, 22(H), 24(E), 27(L), 27(M)  
**CLASSIFICATION** : PCS Licensed Transmitter Held to Ear (PCE)

The product was received on Jun. 03, 2020 and completely tested on Jul. 16, 2020. We, Sporton International (Kunshan) Inc., would like to declare that the tested sample has been evaluated in accordance with the procedures given in ANSI C63.26-2015 and shown compliance with the applicable technical standards.

The test results in this report apply exclusively to the tested model / sample. Without written approval of Sporton International (Kunshan) Inc., the test report shall not be reproduced except in full.

Jason Jia

Reviewed by: Jason Jia / Supervisor

James Huang

Approved by: James Huang / Manager



**Sporton International (Kunshan) Inc.**

**No. 1098, Pengxi North Road, Kunshan Economic Development Zone Jiangsu Province 215300  
People's Republic of China**



TABLE OF CONTENTS

REVISION HISTORY... 3
SUMMARY OF TEST RESULT ... 4
1 GENERAL DESCRIPTION ... 5
1.1 Applicant ... 5
1.2 Manufacturer ... 5
1.3 Product Feature of Equipment Under Test ... 5
1.4 Product Specification of Equipment Under Test ... 6
1.5 Modification of EUT ... 6
1.6 Specification of Accessory ... 7
1.7 Re-use of Measured Data ... 8
1.8 Maximum EIRP Power, Frequency Tolerance, and Emission Designator ... 9
1.9 Testing Location ... 12
1.10 Test Software ... 12
1.11 Applicable Standards ... 12
2 TEST CONFIGURATION OF EQUIPMENT UNDER TEST ... 13
2.1 Test Mode ... 13
2.2 Connection Diagram of Test System ... 15
2.3 Support Unit used in test configuration and system ... 15
2.4 Measurement Results Explanation Example ... 15
2.5 Frequency List of Low/Middle/High Channels ... 16
3 CONDUCTED TEST ITEMS ... 19
3.1 Measuring Instruments ... 19
3.2 Test Setup ... 19
3.3 Test Result of Conducted Test ... 19
3.4 Conducted Output Power and EIRP ... 20
3.5 Peak-to-Average Ratio ... 21
3.6 Occupied Bandwidth ... 22
3.7 Conducted Band Edge ... 23
3.8 Conducted Spurious Emission ... 25
3.9 Frequency Stability ... 26
4 RADIATED TEST ITEMS ... 27
4.1 Measuring Instruments ... 27
4.2 Test Setup ... 27
4.3 Test Result of Radiated Test ... 27
4.4 Radiated Spurious Emission ... 28
5 LIST OF MEASURING EQUIPMENT ... 29
6 UNCERTAINTY OF EVALUATION ... 30
APPENDIX A. TEST RESULTS OF CONDUCTED TEST
APPENDIX B. TEST RESULTS OF RADIATED TEST
APPENDIX C. TEST SETUP PHOTOGRAPHS
APPENDIX D. REFERENCE REPORT



### REVISION HISTORY

REPORT NO.	VERSION	DESCRIPTION	ISSUED DATE
FG060301-01B	Rev. 01	Initial issue of report	Jul. 29, 2020



## SUMMARY OF TEST RESULT

Report Section	FCC Rule	Description	Limit	Result	Remark
3.4	§2.1046	Conducted Output Power	Reporting Only	PASS	-
	§24.232(c) §27.50(h)(2)	Equivalent Isotropic Radiated Power (Band 2) (Band 38) (Band 41)	EIRP < 2Watt	PASS	-
	§27.50(d)(4)	Equivalent Isotropic Radiated Power (Band 4) (Band 66)	EIRP < 1Watt	PASS	-
3.5	§24.232(d)	Peak-to-Average Ratio	<13 dB	PASS	-
3.6	§2.1049	Occupied Bandwidth	Reporting Only	PASS	-
3.7	§2.1051 §24.238(a) §27.53(h)	Conducted Band Edge Measurement (Band 2) (Band 4) (Band 66)	< 43+10log <sub>10</sub> (P[Watts])	PASS	-
	§27.53(m)(4)	Conducted Band Edge Measurement (Band 38) (Band 41)	§27.53(m)(4)		
3.8	§2.1051 §24.238(a) §27.53(h)	Conducted Spurious Emission (Band 2) (Band 4) (Band 66)	< 43+10log <sub>10</sub> (P[Watts])	PASS	-
	§2.1051 §27.53(m)(4)	Conducted Spurious Emission (Band 38) (Band 41)	< 55+10log <sub>10</sub> (P[Watts])		
3.9	§2.1055 §24.235 §27.54	Frequency Stability Temperature & Voltage	Within Authorized Band	PASS	-
4.4	§2.1053 §24.238(a) §27.53(h)	Radiated Spurious Emission (Band 2) (Band 4) (Band 66)	< 43+10log <sub>10</sub> (P[Watts])	PASS	Under limit 32.75 dB at 10340.000 MHz
	§2.1053 §27.53(m)(4)	Radiated Spurious Emission (Band 38) (Band 41)	< 55+10log <sub>10</sub> (P[Watts])		

**Declaration of Conformity:**

The test results with all measurement uncertainty excluded are presented in accordance with the regulation limits or requirements declared by manufacturers.

**Comments and Explanations:**

The declared of product specification for EUT presented in the report are provided by the manufacturer, and the manufacturer takes all the responsibilities for the accuracy of product specification.



# 1 General Description

## 1.1 Applicant

Motorola Mobility LLC  
222 W,Merchandise Mart Plaza, Chicago IL 60654 USA

## 1.2 Manufacturer

Motorola Mobility LLC  
222 W,Merchandise Mart Plaza, Chicago IL 60654 USA

## 1.3 Product Feature of Equipment Under Test

Product Feature	
Equipment	Mobile Cellular Phone
Brand Name	Motorola
Model Name	XT2087-2
FCC ID	IHDT56ZE2
EUT supports Radios application	GSM/WCDMA/LTE/NFC WLAN 2.4GHz 802.11b/g/n HT20 WLAN 5GHz 802.11a/n HT20/HT40 WLAN 5GHz 802.11ac VHT20/VHT40/VHT80 Bluetooth BR/EDR/LE FM Receiver / GNSS
IMEI Code	Conducted: 355540110033111/355540110033129 Radiation: 355540110034077/355540110034085
HW Version	DVT2
SW Version	QPA30.19
EUT Stage	Identical Prototype



### 1.4 Product Specification of Equipment Under Test

Standards-related Product Specification	
<b>Tx Frequency</b>	LTE Band 2 : 1850.7 MHz ~ 1909.3 MHz LTE Band 4 : 1710.7 MHz ~ 1754.3 MHz LTE Band 5 : 824.7 MHz ~ 848.3 MHz LTE Band 7 : 2502.5 MHz ~ 2567.5 MHz LTE Band 38 : 2572.5MHz ~ 2617.5MHz LTE Band 41 : 2537.5 MHz ~ 2652.5 MHz LTE Band 66 : 1710.7 MHz ~ 1779.3 MHz
<b>Rx Frequency</b>	LTE Band 2 : 1930.7 MHz ~ 1989.3 MHz LTE Band 4 : 2110.7 MHz ~ 2154.3 MHz LTE Band 5 : 869.7 MHz ~ 893.3 MHz LTE Band 7 : 2622.5MHz ~ 2687.5 MHz LTE Band 38 : 2572.5MHz ~ 2617.5MHz LTE Band 41 : 2537.5 MHz ~ 2652.5 MHz LTE Band 66 : 2110.7 MHz~ 2199.3 MHz
<b>Bandwidth</b>	LTE Band 2 : 1.4MHz / 3MHz / 5MHz / 10MHz / 15MHz / 20MHz LTE Band 4 : 1.4MHz / 3MHz / 5MHz / 10MHz / 15MHz / 20MHz LTE Band 5 : 1.4MHz / 3MHz / 5MHz / 10MHz LTE Band 7 : 5MHz/ 10MHz / 15MHz / 20MHz LTE Band 38 : 5MHz / 10MHz / 15MHz / 20MHz LTE Band 41 : 5MHz / 10MHz / 15MHz / 20MHz LTE Band 66 : 1.4MHz / 3MHz / 5MHz / 10MHz / 15MHz / 20MHz
<b>Maximum Output Power to Antenna</b>	LTE Band 2 : 22.98 dBm LTE Band 4 : 22.91 dBm LTE Band 38 : 22.96 dBm LTE Band 41 : 22.97 dBm LTE Band 66 : 22.92 dBm
<b>Antenna Gain</b>	LTE Band 2 : 0.14 dBi LTE Band 4 : 0.30 dBi LTE Band 38 : -1.30 dBi LTE Band 41 : -1.30 dBi LTE Band 66 : 0.30 dBi
<b>Type of Modulation</b>	QPSK / 16QAM / 64QAM

### 1.5 Modification of EUT

No modifications are made to the EUT during all test items.



## 1.6 Specification of Accessory

Specification of Accessory				
AC Adapter 1(US)	Brand Name	Motorola (Acbel)	Model Name	MC-301
AC Adapter 1(EU)	Brand Name	Motorola (Acbel)	Model Name	MC-302
AC Adapter 1(UK)	Brand Name	Motorola (Acbel)	Model Name	MC-303
AC Adapter 1(AR)	Brand Name	Motorola (Acbel)	Model Name	MC-306
AC Adapter 1(AU)	Brand Name	Motorola (Acbel)	Model Name	MC-305
AC Adapter 1(Chile)	Brand Name	Motorola (Acbel)	Model Name	MC-309
AC Adapter 2(US)	Brand Name	Motorola (Salom)	Model Name	MC-301
AC Adapter 2(EU)	Brand Name	Motorola (Salom)	Model Name	MC-302
AC Adapter 2(UK)	Brand Name	Motorola (Salom)	Model Name	MC-303
AC Adapter 2(AR)	Brand Name	Motorola (Salom)	Model Name	MC-306
AC Adapter 2(AU)	Brand Name	Motorola (Salom)	Model Name	MC-305
AC Adapter 2(BR)	Brand Name	Motorola (Salom)	Model Name	MC-307
AC Adapter 3(UK)	Brand Name	Motorola (Chenyang)	Model Name	MC-203
AC Adapter 4(UK)	Brand Name	Motorola (Acbel)	Model Name	MC-203
Battery	Brand Name	Motorola(ATL)	Model Name	MG50
Earphone	Brand Name	Motorola (NLD)	Model Name	NLD-EM301K-06SF
USB Cable 1	Brand Name	Motorola (Cabletech)	Model Name	SC18C37155
USB Cable 2	Brand Name	Motorola (Luxshare)	Model Name	SC18C37156
USB Cable 3	Brand Name	Motorola (Saibao)	Model Name	SC18C37157
USB Cable 4	Brand Name	Motorola (Saibao)	Model Name	SC18C24367
USB Cable 5	Brand Name	Motorola (Luxshare)	Model Name	SC18C24368



## 1.7 Re-use of Measured Data

### 1.7.1 Introduction Section

This application re-uses data collected on a similar device. The subject device of this application (Model: XT2087-2, FCC ID: IHDT56ZE2) is electrically identical to the reference device (Model: XT2087-1, FCC ID: IHDT56ZE1) for the portions of the circuitry corresponding to the data being re-used, as treated by KDB Publication 484596 D01.

### 1.7.2 Difference Section

For details concerning the similarity with respect to component placement, mechanical/electrical design etc., please refer to the Product Equality Declaration.

The re-used RF data includes the following bands provided in Appendix D (Sporton RF Report No. FG060301B for the reference device Model: XT2087-1, FCC ID: IHDT56ZE1).

### 1.7.3 Reference detail Section:

Equipment Class	Reference FCC ID	Folder Test	Report Title/Section
PCE (LTE)	IHDT56ZE1	Part22H.24E.27H.27L.27M (FG060301B)	All sections applicable for LTE Band 5/7

### 1.7.4 Spot Check Verification Data Section

In order to confirm hardware similarity of the subject device with the reference device, spot check measurements were performed on the subject device for the following test items, the test result were consistent with FCC ID: IHDT56ZE1 and LTE Band 2/4/38/41/66 to full test.

Assertions concerning the similarity of these devices are based on representations by the applicant. The applicant accepts full responsibility for the validity of the similarity claim, and for the determination that verification test data are sufficient to support it.

Test Item	Mode	IHDT56ZE1 Worst Result	IHDT56ZE2 Worst Result	Difference (dB)
Radiated Spurious Emission (dBm)	LTE Band7	-57.77	-57.34	0.43

Note: The verify data of Part 22H could be referred to FG060301-01A.





### 1.8 Maximum EIRP Power, Frequency Tolerance, and Emission Designator

LTE Band 2		QPSK			16QAM		
BW (MHz)	Frequency Range (MHz)	Emission Designator (99%OBW)	Frequency Tolerance (ppm)	Maximum EIRP(W)	Emission Designator (99%OBW)	Frequency Tolerance (ppm)	Maximum EIRP(W)
1.4	1850.7 ~ 1909.3	1M10G7D	-	0.1986	1M10W7D	-	0.1714
3	1851.5 ~ 1908.5	2M73G7D	-	0.2000	2M74W7D	-	0.1758
5	1852.5 ~ 1907.5	4M52G7D	-	0.2000	4M49W7D	-	0.1730
10	1855.0 ~ 1905.0	9M09G7D	0.0022	0.2046	9M07W7D	-	0.1778
15	1857.5 ~ 1902.5	13M5G7D	-	0.2032	13M5W7D	-	0.1770
20	1860.0 ~ 1900.0	18M4G7D	-	0.2051	18M5W7D	-	0.1770
LTE Band 2		64QAM					
BW (MHz)	Frequency Range (MHz)	Emission Designator (99%OBW)	Frequency Tolerance (ppm)		Maximum EIRP(W)		
1.4	1850.7 ~ 1909.3	1M10W7D	-		0.1324		
3	1851.5 ~ 1908.5	2M73W7D	-		0.1346		
5	1852.5 ~ 1907.5	4M54W7D	-		0.1361		
10	1855.0 ~ 1905.0	9M07W7D	-		0.1368		
15	1857.5 ~ 1902.5	13M5W7D	-		0.1374		
20	1860.0 ~ 1900.0	18M3W7D	-		0.1384		
LTE Band 4		QPSK			16QAM		
BW (MHz)	Frequency Range (MHz)	Emission Designator (99%OBW)	Frequency Tolerance (ppm)	Maximum EIRP(W)	Emission Designator (99%OBW)	Frequency Tolerance (ppm)	Maximum EIRP(W)
1.4	1710.7 ~ 1754.3	1M09G7D	-	0.2023	1M10W7D	-	0.1828
3	1711.5 ~ 1753.5	2M72G7D	-	0.2023	2M72W7D	-	0.1824
5	1712.5 ~ 1752.5	4M51G7D	-	0.2028	4M50W7D	-	0.1858
10	1715.0 ~ 1750.0	9M13G7D	0.0159	0.2046	9M05W7D	-	0.1879
15	1717.5 ~ 1747.5	13M5G7D	-	0.2070	13M5W7D	-	0.1884
20	1720.0 ~ 1745.0	18M5G7D	-	0.2099	18M4W7D	-	0.1897
LTE Band 4		64QAM					
BW (MHz)	Frequency Range (MHz)	Emission Designator (99%OBW)	Frequency Tolerance (ppm)		Maximum EIRP(W)		
1.4	1710.7 ~ 1754.3	1M10W7D	-		0.1413		
3	1711.5 ~ 1753.5	2M73W7D	-		0.1419		
5	1712.5 ~ 1752.5	4M51W7D	-		0.1435		



10	1715.0 ~ 1750.0	9M05W7D	-	0.1445			
15	1717.5 ~ 1747.5	13M5W7D	-	0.1472			
20	1720.0 ~ 1745.0	18M5W7D	-	0.1445			
LTE Band 38		QPSK			16QAM		
BW (MHz)	Frequency Range (MHz)	Emission Designator (99%OBW)	Frequency Tolerance (ppm)	Maximum EIRP(W)	Emission Designator (99%OBW)	Frequency Tolerance (ppm)	Maximum EIRP(W)
5	2572.5 ~ 2617.5	4M52G7D	-	0.1413	4M52W7D	-	0.1156
10	2575.0 ~ 2615.0	9M06G7D	0.0024	0.1442	9M03W7D	-	0.1183
15	2577.5 ~ 2612.5	13M4G7D	-	0.1469	13M4W7D	-	0.1202
20	2580.0 ~ 2610.0	17M9G7D	-	0.1462	17M8W7D	-	0.1183
LTE Band 38		64QAM					
BW (MHz)	Frequency Range (MHz)	Emission Designator (99%OBW)	Frequency Tolerance (ppm)	Maximum EIRP(W)			
5	2572.5 ~ 2617.5	4M50W7D	-	0.0902			
10	2575.0 ~ 2615.0	9M06W7D	-	0.0933			
15	2577.5 ~ 2612.5	13M5W7D	-	0.0938			
20	2580.0 ~ 2610.0	18M0W7D	-	0.0940			
LTE Band 41		QPSK			16QAM		
BW (MHz)	Frequency Range (MHz)	Emission Designator (99%OBW)	Frequency Tolerance (ppm)	Maximum EIRP(W)	Emission Designator (99%OBW)	Frequency Tolerance (ppm)	Maximum EIRP(W)
5	2537.5 ~ 2652.5	4M52G7D	-	0.1413	4M52W7D	-	0.1156
10	2540.0 ~ 2650.0	9M06G7D	0.0024	0.1442	9M03W7D	-	0.1183
15	2542.5 ~ 2647.5	13M4G7D	-	0.1469	13M4W7D	-	0.1202
20	2545.0 ~ 2645.0	17M9G7D	-	0.1462	17M8W7D	-	0.1183
LTE Band 41		64QAM					
BW (MHz)	Frequency Range (MHz)	Emission Designator (99%OBW)	Frequency Tolerance (ppm)	Maximum EIRP(W)			
5	2537.5 ~ 2652.5	4M50W7D	-	0.0902			
10	2540.0 ~ 2650.0	9M06W7D	-	0.0933			
15	2542.5 ~ 2647.5	13M5W7D	-	0.0938			
20	2545.0 ~ 2645.0	18M0W7D	-	0.0940			



LTE Band 66		QPSK			16QAM		
BW (MHz)	Frequency Range (MHz)	Emission Designator (99%OBW)	Frequency Tolerance (ppm)	Maximum EIRP(W)	Emission Designator (99%OBW)	Frequency Tolerance (ppm)	Maximum EIRP(W)
1.4	1710.7 ~ 1779.3	1M09G7D	-	0.2023	1M10W7D	-	0.1828
3	1711.5 ~ 1778.5	2M72G7D	-	0.2023	2M72W7D	-	0.1824
5	1712.5 ~ 1777.5	4M51G7D	-	0.2028	4M50W7D	-	0.1858
10	1715.0 ~ 1775.0	9M13G7D	0.0159	0.2046	9M05W7D	-	0.1879
15	1717.5 ~ 1772.5	13M5G7D	-	0.2070	13M5W7D	-	0.1884
20	1720.0 ~ 1770.0	18M5G7D	-	0.2099	18M4W7D	-	0.1897
LTE Band 66		64QAM					
BW (MHz)	Frequency Range (MHz)	Emission Designator (99%OBW)	Frequency Tolerance (ppm)		Maximum EIRP(W)		
1.4	1710.7 ~ 1779.3	1M10W7D	-		0.1413		
3	1711.5 ~ 1778.5	2M73W7D	-		0.1419		
5	1712.5 ~ 1777.5	4M51W7D	-		0.1435		
10	1715.0 ~ 1775.0	9M05W7D	-		0.1445		
15	1717.5 ~ 1772.5	13M5W7D	-		0.1472		
20	1720.0 ~ 1770.0	18M5W7D	-		0.1445		

Note:

1. LTE Band 66 overlaps the entire frequency range of LTE Band 4. Therefore, the test results provided in this report covers Band 66 as well as Band 4.
2. LTE Band 41 overlaps the entire frequency range of LTE Band 38. Therefore, the test results provided in this report covers Band 41 as well as Band 38.



### 1.9 Testing Location

Sporton International (Kunshan) Inc. is accredited to ISO/IEC 17025:2017 by American Association for Laboratory Accreditation with Certificate Number 5145.02.

<b>Test Firm</b>	Sporton International (Kunshan) Inc.		
<b>Test Site Location</b>	No. 1098, Pengxi North Road, Kunshan Economic Development Zone Jiangsu Province 215300 People's Republic of China TEL : +86-512-57900158 FAX : +86-512-57900958		
<b>Test Site No.</b>	<b>Sporton Site No.</b>	<b>FCC Designation No.</b>	<b>FCC Test Firm Registration No.</b>
	CO01-KS 03CH04-KS TH01-KS	CN1257	314309

### 1.10 Test Software

Item	Site	Manufacture	Name	Version
1.	03CH04-KS	AUDIX	E3	6.2009-8-24a

### 1.11 Applicable Standards

According to the specifications of the manufacturer, the EUT must comply with the requirements of the following standards:

- 47 CFR Part 2, 22(H), 24(E), 27(L), 27(M)
- ANSI C63.26-2015
- FCC KDB 971168 D01 Power Meas License Digital Systems v03r01
- FCC KDB 412172 D01 Determining ERP and EIRP v01r01

**Remark:**

1. All test items were verified and recorded according to the standards and without any deviation during the test.
2. This EUT has also been tested and complied with the requirements of FCC Part 15, Subpart B, recorded in a separate test report.



## 2 Test Configuration of Equipment Under Test

### 2.1 Test Mode

Antenna port conducted and radiated test items listed below are performed according to KDB 971168 D01 Power Meas License Digital Systems v03r01 with maximum output power.

Radiated measurements are performed by rotating the EUT in three different orthogonal test planes to find the maximum emission.

Test Items	Band	Bandwidth (MHz)						Modulation			RB #			Test Channel		
		1.4	3	5	10	15	20	QPSK	16QAM	64QAM	1	Half	Full	L	M	H
Max. Output Power	2	v	v	v	v	v	v	v	v	v	v	v	v	v	v	v
	4	v	v	v	v	v	v	v	v	v	v	v	v	v	v	v
	38	-	-	v	v	v	v	v	v	v	v	v	v	v	v	v
	41	-	-	v	v	v	v	v	v	v	v	v	v	v	v	v
	66	v	v	v	v	v	v	v	v	v	v	v	v	v	v	v
Peak-to-Average Ratio	2						v	v	v	v	v		v	v	v	v
	41	-	-				v	v	v	v	v		v	v	v	v
	66						v	v	v	v	v		v	v	v	v
26dB and 99% Bandwidth	2	v	v	v	v	v	v	v	v	v			v	v	v	v
	41	-	-	v	v	v	v	v	v	v			v	v	v	v
	66	v	v	v	v	v	v	v	v	v			v	v	v	v
Conducted Band Edge	2	v	v	v	v	v	v	v	v	v	v		v	v		v
	41	-	-	v	v	v	v	v	v	v	v		v	v		v
	66	v	v	v	v	v	v	v	v	v	v		v	v		v



Test Items	Band	Bandwidth (MHz)						Modulation			RB #			Test Channel		
		1.4	3	5	10	15	20	QPSK	16QAM	64QAM	1	Half	Full	L	M	H
Conducted Spurious Emission	2	v	v	v	v	v	v	v	v	v	v			v	v	v
	41	-	-	v	v	v	v	v	v	v	v			v	v	v
	66	v	v	v	v	v	v	v	v	v	v			v	v	v
Frequency Stability	2				v			v					v		v	
	41	-	-		v			v					v		v	
	66				v			v					v		v	
E.I.R.P	2	v	v	v	v	v	v	v	v	v	v			v	v	v
	41	-	-	v	v	v	v	v	v	v	v			v	v	v
	66	v	v	v	v	v	v	v	v	v	v			v	v	v
Radiated Spurious Emission	2	Worst Case													v	
	41	Worst Case													v	
	66	Worst Case													v	
Note	<ol style="list-style-type: none"> <li>The mark "v" means that this configuration is chosen for testing</li> <li>The mark "-" means that this bandwidth is not supported.</li> <li>The device is investigated from 30MHz to 10 times of fundamental signal for radiated spurious emission test under different RB size/offset and modulations in exploratory test. Subsequently, only the worst case emissions are reported.</li> <li>LTE Band 66 overlaps the entire frequency range of LTE Band 4. Therefore, the test results provided in this report covers Band 66 as well as Band 4.</li> <li>LTE Band 41 overlaps the entire frequency range of LTE Band 38. Therefore, the test results provided in this report covers Band 41 as well as Band 38.</li> </ol>															

## 2.2 Connection Diagram of Test System

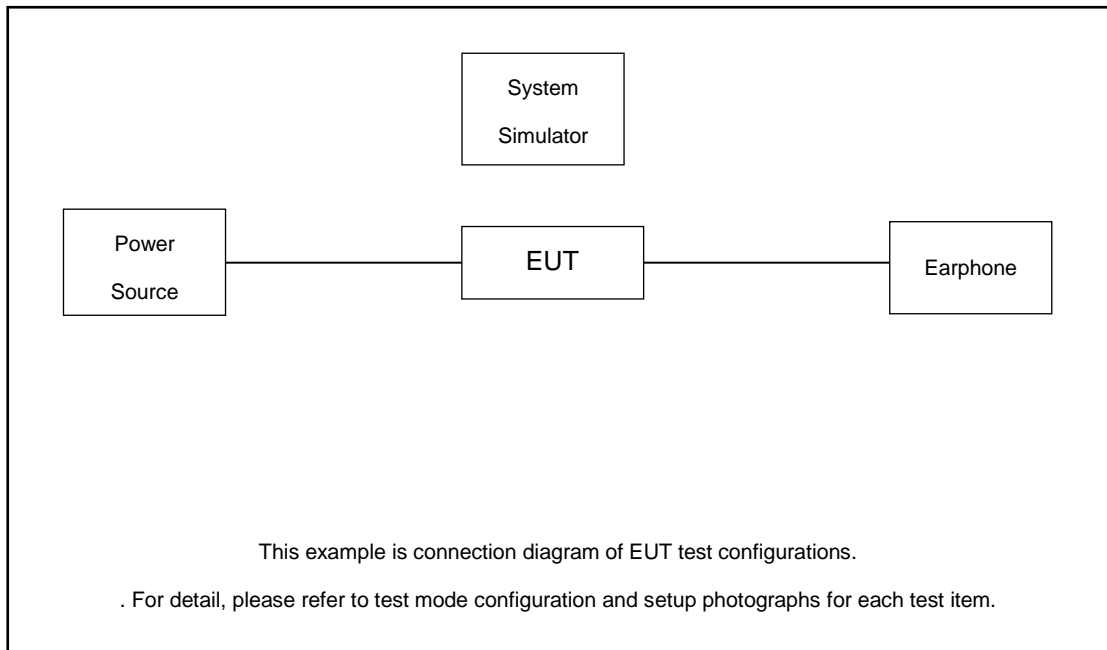

## 2.3 Support Unit used in test configuration and system

Item	Equipment	Trade Name	Model No.	FCC ID	Data Cable	Power Cord
1.	Power Supply	GWINSTEK	PSS-2002	N/A	N/A	Unshielded, 1.8 m
2.	LTE Base Station	Anritsu	MT8820C	N/A	N/A	Unshielded, 1.8 m

## 2.4 Measurement Results Explanation Example

### For all conducted test items:

The offset level is set in the spectrum analyzer to compensate the RF cable loss and attenuator factor between EUT conducted output port and spectrum analyzer. With the offset compensation, the spectrum analyzer reading level is exactly the EUT RF output level.

The spectrum analyzer offset is derived from RF cable loss.

$$\text{Offset} = \text{RF cable loss.}$$

Following shows an offset computation example with cable loss 5.6 dB

Example :

$$\begin{aligned} \text{Offset(dB)} &= \text{RF cable loss(dB)}. \\ &= 5.6 \text{ (dB)} \end{aligned}$$



### 2.5 Frequency List of Low/Middle/High Channels

LTE Band 2 Channel and Frequency List				
BW [MHz]	Channel/Frequency(MHz)	Lowest	Middle	Highest
20	Channel	18700	18900	19100
	Frequency	1860	1880	1900
15	Channel	18675	18900	19125
	Frequency	1857.5	1880	1902.5
10	Channel	18650	18900	19150
	Frequency	1855	1880	1905
5	Channel	18625	18900	19175
	Frequency	1852.5	1880	1907.5
3	Channel	18615	18900	19185
	Frequency	1851.5	1880	1908.5
1.4	Channel	18607	18900	19193
	Frequency	1850.7	1880	1909.3

LTE Band 4 Channel and Frequency List				
BW [MHz]	Channel/Frequency(MHz)	Lowest	Middle	Highest
20	Channel	20050	20175	20300
	Frequency	1720	1732.5	1745
15	Channel	20025	20175	20325
	Frequency	1717.5	1732.5	1747.5
10	Channel	20000	20175	20350
	Frequency	1715	1732.5	1750
5	Channel	19975	20175	20375
	Frequency	1712.5	1732.5	1752.5
3	Channel	19965	20175	20385
	Frequency	1711.5	1732.5	1753.5
1.4	Channel	19957	20175	20393
	Frequency	1710.7	1732.5	1754.3





LTE Band 38 Channel and Frequency List				
BW [MHz]	Channel/Frequency(MHz)	Lowest	Middle	Highest
20	Channel	37850	38000	38150
	Frequency	2580	2595	2610
15	Channel	37825	38000	38175
	Frequency	2577.5	2595	2612.5
10	Channel	37800	38000	38200
	Frequency	2575	2595	2615
5	Channel	37775	38000	38225
	Frequency	2572.5	2595	2617.5

LTE Band 41 Channel and Frequency List				
BW [MHz]	Channel/Frequency(MHz)	Lowest	Middle	Highest
20	Channel	40140	40640	41140
	Frequency	2545	2595	2645
15	Channel	40115	40640	41165
	Frequency	2542.5	2595	2647.5
10	Channel	40090	40640	41190
	Frequency	2540	2595	2650
5	Channel	40065	40640	41215
	Frequency	2537.5	2595	2652.5



LTE Band 66 Channel and Frequency List				
BW [MHz]	Channel/Frequency(MHz)	Lowest	Middle	Highest
20	Channel	132072	132322	132572
	Frequency	1720	1745	1770
15	Channel	132047	132322	132597
	Frequency	1717.5	1745	1772.5
10	Channel	132022	132322	132622
	Frequency	1715	1745	1775
5	Channel	131997	132322	132647
	Frequency	1712.5	1745	1777.5
3	Channel	131987	132322	132657
	Frequency	1711.5	1745	1778.5
1.4	Channel	131979	132322	132665
	Frequency	1710.7	1745	1779.3

### 3 Conducted Test Items

#### 3.1 Measuring Instruments

See list of measuring instruments of this test report.

#### 3.2 Test Setup

##### 3.2.1 Conducted Output Power



##### 3.2.2 Peak-to-Average Ratio, Occupied Bandwidth ,Conducted Band-Edge and Conducted Spurious Emission

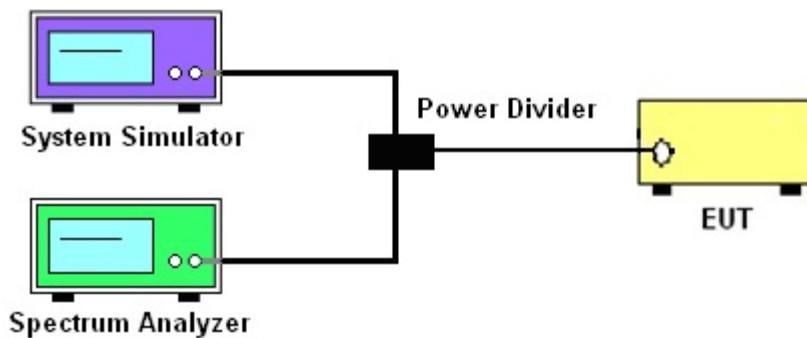

##### 3.2.3 Frequency Stability

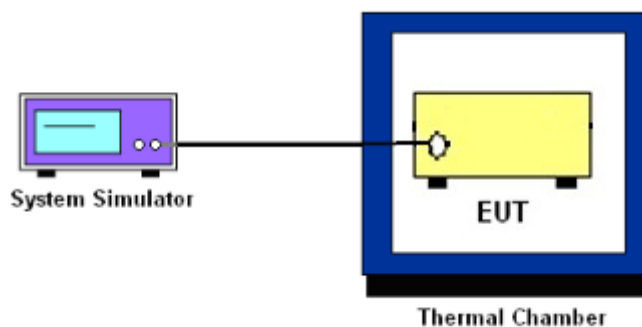

### 3.3 Test Result of Conducted Test

Please refer to Appendix A.



### 3.4 Conducted Output Power and EIRP

#### 3.4.1 Description of the Conducted Output Power Measurement and EIRP Measurement

A system simulator was used to establish communication with the EUT. Its parameters were set to force the EUT transmitting at maximum output power. The measured power in the radio frequency on the transmitter output terminals shall be reported.

The EIRP of mobile transmitters must not exceed 2 Watts for LTE Band 2 and Band 38 and Band 41.

The EIRP of mobile transmitters must not exceed 1 Watts for LTE Band 4 and Band 66.

According to KDB 412172 D01 Power Approach,

$EIRP = P_T + G_T - L_C$ ,  $ERP = EIRP - 2.15$ , where

$P_T$  = transmitter output power in dBm

$G_T$  = gain of the transmitting antenna in dBi

$L_C$  = signal attenuation in the connecting cable between the transmitter and antenna in dB

#### 3.4.2 Test Procedures

1. The testing follows ANSI C63.26 Section 5.2
2. The transmitter output port was connected to the system simulator.
3. Set EUT at maximum power through the system simulator.
4. Select lowest, middle, and highest channels for each band and different modulation.
5. Measure and record the power level from the system simulator.



## 3.5 Peak-to-Average Ratio

### 3.5.1 Description of the PAR Measurement

Power Complementary Cumulative Distribution Function (CCDF) curves provide a means for characterizing the power peaks of a digitally modulated signal on a statistical basis. A CCDF curve depicts the probability of the peak signal amplitude exceeding the average power level. Most contemporary measurement instrumentation include the capability to produce CCDF curves for an input signal provided that the instrument's resolution bandwidth can be set wide enough to accommodate the entire input signal bandwidth. In measuring transmissions in this band using an average power technique, the peak-to-average ratio (PAR) of the transmission may not exceed 13 dB.

### 3.5.2 Test Procedures

1. The testing follows ANSI C63.26 Section 5.2.3.4 (CCDF).
2. The EUT was connected to spectrum and system simulator via a power divider.
3. Set the CCDF (Complementary Cumulative Distribution Function) option in spectrum analyzer.
4. The highest RF powers were measured and recorded the maximum PAPR level associated with a probability of 0.1 %.
5. Record the deviation as Peak to Average Ratio.



### 3.6 Occupied Bandwidth

#### 3.6.1 Description of Occupied Bandwidth Measurement

The occupied bandwidth is the width of a frequency band such that, below the lower and above the upper frequency limits, the mean powers emitted are each equal to a specified percentage 0.5% of the total mean transmitted power.

The 26 dB emission bandwidth is defined as the frequency range between two points, one above and one below the carrier frequency, at which the spectral density of the emission is attenuated 26 dB below the maximum in-band spectral density of the modulated signal. Spectral density (power per unit bandwidth) is to be measured with a detector of resolution bandwidth equal to approximately 1.0% of the emission bandwidth.

#### 3.6.2 Test Procedures

1. The testing follows ANSI C63.26 Section 5.4
2. The EUT was connected to spectrum analyzer and system simulator via a power divider.
3. The spectrum analyzer center frequency is set to the nominal EUT channel center frequency. The span range for the spectrum analyzer shall be between two and five times the anticipated OBW.
4. The nominal resolution bandwidth (RBW) shall be in the range of 1 to 5 % of the anticipated OBW, and the VBW shall be at least 3 times the RBW.
5. Set the detection mode to peak, and the trace mode to max hold.
6. Determine the reference value: Set the EUT to transmit a modulated signal. Allow the trace to stabilize. Set the spectrum analyzer marker to the highest level of the displayed trace.  
(this is the reference value)
7. Determine the “-26 dB down amplitude” as equal to (Reference Value – X).
8. Place two markers, one at the lowest and the other at the highest frequency of the envelope of the spectral display such that each marker is at or slightly below the “-X dB down amplitude” determined in step 6. If a marker is below this “-X dB down amplitude” value it shall be placed as close as possible to this value. The OBW is the positive frequency difference between the two markers.
9. Use the 99 % power bandwidth function of the spectrum analyzer and report the measured bandwidth.



### 3.7 Conducted Band Edge

#### 3.7.1 Description of Conducted Band Edge Measurement

24.238 (a)

For operations in the 1850-1910 and 1930-1990 MHz band, the FCC limit is  $43 + 10\log_{10}(P[\text{Watts}])$  dB below the transmitter power  $P(\text{Watts})$  in a 1MHz bandwidth. However, in the 1 MHz bands immediately outside and adjacent to the frequency block a resolution bandwidth of at least one percent of the emission bandwidth of the fundamental emission of the transmitter may be employed.

27.53 (h)

For operations in the 1710 – 1755 MHz band, the FCC limit is  $43 + 10\log_{10}(P[\text{Watts}])$  dB below the transmitter power  $P(\text{Watts})$  in a 1 MHz bandwidth. However, in the 1MHz bands immediately outside and adjacent to the licensee's frequency block, a resolution bandwidth of at least one percent of the emission bandwidth of the fundamental emission of the transmitter may be employed.

27.53(m)(4)

For mobile digital stations, the attenuation factor shall be not less than  $40 + 10 \log (P)$  dB on all frequencies between the channel edge and 5 megahertz from the channel edge,  $43 + 10 \log (P)$  dB on all frequencies between 5 megahertz and X megahertz from the channel edge, and  $55 + 10 \log (P)$  dB on all frequencies more than X megahertz from the channel edge, where X is the greater of 6 megahertz or the actual emission bandwidth as defined in paragraph (m)(6) of this section. In addition, the attenuation factor shall not be less that  $43 + 10 \log (P)$  dB on all frequencies between 2490.5 MHz and 2496 MHz and  $55 + 10 \log (P)$  dB at or below 2490.5 MHz. Mobile Satellite Service licensees operating on frequencies below 2495 MHz may also submit a documented interference complaint against BRS licensees operating on channel BRS Channel 1 on the same terms and conditions as adjacent channel BRS or EBS licensees.



### 3.7.2 Test Procedures

1. The testing follows ANSI C63.26 section 5.7
2. The EUT was connected to spectrum analyzer and system simulator via a power divider.
3. The band edges of low and high channels for the highest RF powers were measured.
4. Set RBW  $\geq$  1% EBW in the 1MHz band immediately outside and adjacent to the band edge.
5. Beyond the 1 MHz band from the band edge, RBW=1MHz was used or a narrower RBW was used and the measured power was integrated over the full required measurement bandwidth of 1 MHz.
6. Set spectrum analyzer with RMS detector.
7. Offset has included the duty factor for LTE Band 38/41. Duty factor =  $10 \log (1/x)$ , where x is the measured duty cycle.
8. The RF fundamental frequency should be excluded against the limit line in the operating frequency band.
9. Checked that all the results comply with the emission limit line.

Example:

The limit line is derived from  $43 + 10\log(P)$ dB below the transmitter power P(Watts)

$$= P(W) - [43 + 10\log(P)] \text{ (dB)}$$

$$= [30 + 10\log(P)] \text{ (dBm)} - [43 + 10\log(P)] \text{ (dB)} = -13\text{dBm}.$$

10. For LTE Band 7, 38, 41, the other 40 dB, and 55 dB have additionally applied same calculation above.





## 3.8 Conducted Spurious Emission

### 3.8.1 Description of Conducted Spurious Emission Measurement

The power of any emission outside of the authorized operating frequency ranges must be lower than the transmitter power (P) by a factor of at least  $43 + 10 \log (P)$  dB.

For Band 7,38,41:

The power of any emission outside of the authorized operating frequency ranges must be lower than the transmitter power (P) by a factor of at least  $55 + 10 \log (P)$  dB.

It is measured by means of a calibrated spectrum analyzer and scanned from 30 MHz up to a frequency including its 10<sup>th</sup> harmonic.

### 3.8.2 Test Procedures

1. The testing follows ANSI C63.26 section 5.7
2. The EUT was connected to spectrum analyzer and system simulator via a power divider.
3. The RF output of EUT was connected to the spectrum analyzer by RF cable and attenuator. The path loss was compensated to the results for each measurement.
4. The middle channel for the highest RF power within the transmitting frequency was measured.
5. The conducted spurious emission for the whole frequency range was taken.
6. Make the measurement with the spectrum analyzer's RBW = 1MHz, VBW = 3MHz.
7. Set spectrum analyzer with RMS detector.
8. Offset has included the duty factor for LTE Band 38/41. Duty factor =  $10 \log (1/x)$ , where x is the measured duty cycle.
9. Taking the record of maximum spurious emission.
10. The RF fundamental frequency should be excluded against the limit line in the operating frequency band.
11. The limit line is derived from  $43 + 10 \log (P)$  dB below the transmitter power P(Watts)  
=  $P(W) - [43 + 10 \log (P)]$  (dB)  
=  $[30 + 10 \log (P)]$  (dBm) -  $[43 + 10 \log (P)]$  (dB)  
= -13dBm.
12. For Band 7, 38, 41  
The limit line is derived from  $55 + 10 \log (P)$  dB below the transmitter power P(Watts)  
=  $P(W) - [55 + 10 \log (P)]$  (dB)  
=  $[30 + 10 \log (P)]$  (dBm) -  $[55 + 10 \log (P)]$  (dB)  
= -25dBm.



## 3.9 Frequency Stability

### 3.9.1 Description of Frequency Stability Measurement

The frequency stability shall be measured by variation of ambient temperature and variation of primary supply voltage to ensure that the fundamental emission stays within the authorized frequency block. The frequency stability of the transmitter shall be maintained within  $\pm 0.00025\%$  ( $\pm 2.5\text{ppm}$ ) of the center frequency.

### 3.9.2 Test Procedures for Temperature Variation

1. The testing follows ANSI C63.26 section 5.6.4
2. The EUT was set up in the thermal chamber and connected with the system simulator.
3. With power OFF, the temperature was decreased to  $-30^{\circ}\text{C}$  and the EUT was stabilized before testing. Power was applied and the maximum change in frequency was recorded within one minute.
4. With power OFF, the temperature was raised in  $10^{\circ}\text{C}$  step up to  $50^{\circ}\text{C}$ . The EUT was stabilized at each step for at least half an hour. Power was applied and the maximum frequency change was recorded within one minute.

### 3.9.3 Test Procedures for Voltage Variation

1. The testing follows ANSI C63.26 section 5.6.5
2. The EUT was placed in a temperature chamber at  $20\pm 5^{\circ}\text{C}$  and connected with the system simulator.
3. The power supply voltage to the EUT was varied from 85% to 115% of the nominal value for other than hand carried battery equipment.
4. For hand carried, battery powered equipment, reduce the primary ac or dc supply voltage to the battery operating end point, which shall be specified by the manufacturer.
5. The variation in frequency was measured for the worst case.

## 4 Radiated Test Items

### 4.1 Measuring Instruments

See list of measuring instruments of this test report.

### 4.2 Test Setup

#### 4.2.1 For radiated test from 30MHz to 1GHz

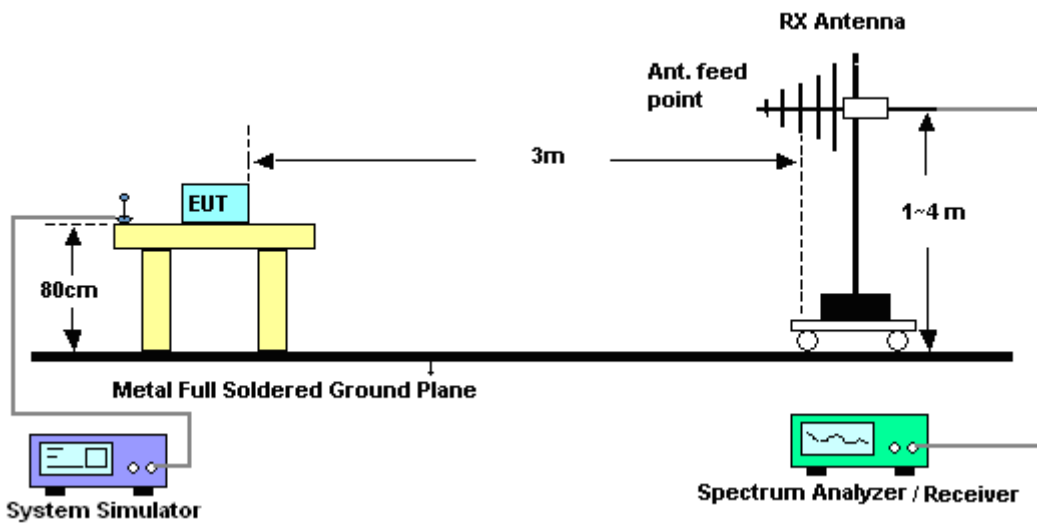

#### 4.2.2 For radiated test above 1GHz

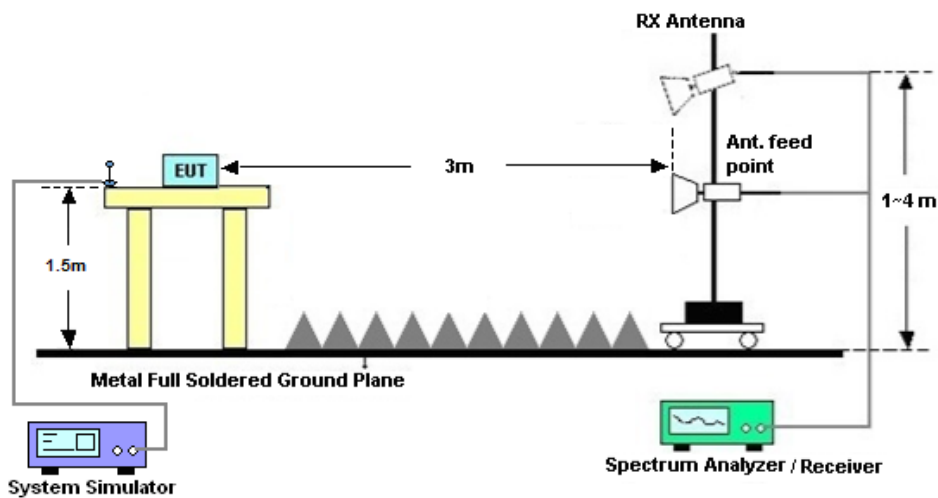

### 4.3 Test Result of Radiated Test

Please refer to Appendix B.



## 4.4 Radiated Spurious Emission

### 4.4.1 Description of Radiated Spurious Emission

The radiated spurious emission was measured by substitution method according to ANSI C63.26. The power of any emission outside of the authorized operating frequency ranges must be attenuated below the transmitter power (P) by a factor of at least  $43 + 10 \log (P)$  dB.

For Band 7, 38, 41

The power of any emission outside of the authorized operating frequency ranges must be attenuated below the transmitter power (P) by a factor of at least  $55 + 10 \log (P)$  dB.

The spectrum is scanned from 30 MHz up to a frequency including its 10th harmonic.

### 4.4.2 Test Procedures

1. The testing follows ANSI C63.26 Section 5.5
2. The EUT was placed on a turntable with 0.8 meter height for frequency below 1GHz and 1.5 meter height for frequency above 1GHz respectively above ground.
3. The EUT was set 3 meters from the receiving antenna mounted on the antenna tower.
4. The table was rotated 360 degrees to determine the position of the highest spurious emission.
5. The height of the receiving antenna is varied between 1m to 4m to search the maximum spurious emission for both horizontal and vertical polarizations.
6. During the measurement, the system simulator parameters were set to force the EUT transmitting at maximum output power.
7. Make the measurement with the spectrum analyzer's RBW = 1MHz, VBW = 3MHz, taking the record of maximum spurious emission.
8. A horn antenna was substituted in place of the EUT and was driven by a signal generator.
9. Tune the output power of signal generator to the same emission level with EUT maximum spurious emission.
10.  $EIRP (dBm) = S.G. Power - Tx Cable Loss + Tx Antenna Gain$
11.  $ERP (dBm) = EIRP - 2.15$
12. The RF fundamental frequency should be excluded against the limit line in the operating frequency band.

The limit line is derived from  $43 + 10\log(P)$ dB below the transmitter power P(Watts)  
 $= P(W) - [43 + 10\log(P)] (dB)$   
 $= [30 + 10\log(P)] (dBm) - [43 + 10\log(P)] (dB)$   
 $= -13dBm.$

13. For Band 7, 38, 41:

The limit line is derived from  $55 + 10\log(P)$ dB below the transmitter power P(Watts)



## 5 List of Measuring Equipment

Instrument	Manufacturer	Model No.	Serial No.	Characteristics	Calibration Date	Test Date	Due Date	Remark
Spectrum Analyzer	R&S	FSV40	101040	10Hz~40GHz	Nov. 02, 2019	Jul. 09, 2020~ Jul. 18, 2020	Nov. 01, 2020	Conducted (TH01-KS)
Thermal Chamber	Ten Billion	TTC-B3S	TBN-960502	-40~+150°C	Oct. 28, 2019	Jul. 09, 2020~ Jul. 18, 2020	Oct. 27, 2020	Conducted (TH01-KS)
EXA Spectrum Analyzer	Keysight	N9010A	MY55150244	10Hz-44G,MAX 30dB	Apr. 15, 2020	Jul. 16, 2020	Apr. 14, 2021	Radiation (03CH04-KS)
Bilog Antenna	TeseQ	CBL6111D	49921	30MHz-1GHz	Aug. 19, 2019	Jul. 16, 2020	Aug. 18, 2020	Radiation (03CH04-KS)
Horn Antenna	Schwarzbeck	BBHA9120D	1356	1GHz~18GHz	Apr. 20, 2020	Jul. 16, 2020	Apr. 19, 2021	Radiation (03CH04-KS)
SHF-EHF Horn	Com-power	AH-840	101115	18GHz~40GHz	Nov. 10, 2019	Jul. 16, 2020	Nov. 09, 2020	Radiation (03CH04-KS)
Amplifier	SONOMA	310N	187289	9KHz-1GHz	Aug. 06, 2019	Jul. 16, 2020	Aug. 05, 2020	Radiation (03CH04-KS)
Amplifier	MITEQ	EM18G40G GA	060728	18~40GHz	Jan. 08, 2020	Jul. 16, 2020	Jan. 07, 2021	Radiation (03CH04-KS)
high gain Amplifier	MITEQ	AMF-7D-00 101800-30-1 0P	2025788	1Ghz-18Ghz	Aug. 16, 2019	Jul. 16, 2020	Aug. 15, 2020	Radiation (03CH04-KS)
Amplifier	Keysight	83017A	MY57280106	500MHz~26.5GHz	Oct. 15, 2019	Jul. 16, 2020	Oct. 14, 2020	Radiation (03CH04-KS)
AC Power Source	Chroma	61601	F104090004	N/A	NCR	Jul. 16, 2020	NCR	Radiation (03CH04-KS)
Turn Table	ChamPro	EM 1000-T	060762-T	0~360 degree	NCR	Jul. 16, 2020	NCR	Radiation (03CH04-KS)
Antenna Mast	ChamPro	EM 1000-A	060762-A	1 m~4 m	NCR	Jul. 16, 2020	NCR	Radiation (03CH04-KS)

NCR: No Calibration Required



## 6 Uncertainty of Evaluation

The measurement uncertainties shown below were calculated in accordance with the requirements of ANSI 63.26-2015. All the measurement uncertainty value were shown with a coverage K=2 to indicate 95% level of confidence. The measurement data show herein meets or exceeds the CISPR measurement uncertainty values specified in CISPR 16-4-2 and can be compared directly to specified limit to determine compliance.

### Uncertainty of Radiated Emission Measurement (30 MHz ~ 1000 MHz)

Measuring Uncertainty for a Level of Confidence of 95% (U = 2Uc(y))	3.3dB
---	-------

### Uncertainty of Radiated Emission Measurement (1 GHz ~ 40 GHz)

Measuring Uncertainty for a Level of Confidence of 95% (U = 2Uc(y))	2.8dB
---	-------



# Appendix A. Test Results of Conducted Test

## Conducted Output Power(Average power)

### LTE Band 2

BW [MHz]	Modulation	RB Size	RB Offset	Power Low Ch. / Freq.	Power Middle Ch. / Freq.	Power High Ch. / Freq.
Channel				18700	18900	19100
Frequency (MHz)				1860	1880	1900
20	QPSK	1	0	22.91	22.98	22.96
20	QPSK	1	49	22.88	22.86	22.89
20	QPSK	1	99	22.96	22.91	22.90
20	QPSK	50	0	21.88	21.96	21.92
20	QPSK	50	24	21.92	21.90	21.92
20	QPSK	50	50	21.95	21.84	21.87
20	QPSK	100	0	21.96	21.98	21.90
20	16QAM	1	0	22.34	22.33	22.33
20	16QAM	1	49	22.27	22.30	22.31
20	16QAM	1	99	22.33	22.31	22.26
20	16QAM	50	0	21.04	21.01	21.04
20	16QAM	50	24	21.08	21.07	21.08
20	16QAM	50	50	21.11	21.01	20.99
20	16QAM	100	0	21.10	20.95	21.02
20	64QAM	1	0	21.27	21.19	21.23
20	64QAM	1	49	21.17	21.22	21.16
20	64QAM	1	99	21.23	21.25	21.13
20	64QAM	50	0	20.03	19.98	20.04
20	64QAM	50	24	20.05	20.03	20.05
20	64QAM	50	50	20.08	20.00	20.01
20	64QAM	100	0	20.10	20.00	20.03



Channel				18675	18900	19125
Frequency (MHz)				1857.5	1880	1902.5
15	QPSK	1	0	22.89	22.84	22.89
15	QPSK	1	37	22.86	22.81	22.94
15	QPSK	1	74	22.80	22.79	22.89
15	QPSK	36	0	21.92	21.86	21.90
15	QPSK	36	20	21.95	21.90	21.90
15	QPSK	36	39	21.86	21.87	21.94
15	QPSK	75	0	21.91	21.87	21.87
15	16QAM	1	0	22.29	22.26	22.29
15	16QAM	1	37	22.32	22.28	22.34
15	16QAM	1	74	22.23	22.17	22.24
15	16QAM	36	0	21.05	21.04	21.05
15	16QAM	36	20	21.09	21.07	21.06
15	16QAM	36	39	21.04	21.05	21.10
15	16QAM	75	0	21.04	21.00	20.99
15	64QAM	1	0	21.15	21.16	21.19
15	64QAM	1	37	21.14	21.18	21.24
15	64QAM	1	74	21.11	21.11	21.13
15	64QAM	36	0	20.05	20.02	20.04
15	64QAM	36	20	20.10	20.07	20.05
15	64QAM	36	39	20.05	20.03	20.08
15	64QAM	75	0	19.98	20.04	20.00





Channel				18650	18900	19150
Frequency (MHz)				1855	1880	1905
10	QPSK	1	0	22.97	22.92	22.86
10	QPSK	1	25	22.87	22.83	22.92
10	QPSK	1	49	22.86	22.87	22.87
10	QPSK	25	0	21.87	21.87	21.88
10	QPSK	25	12	21.89	21.87	21.95
10	QPSK	25	25	21.87	21.82	21.93
10	QPSK	50	0	21.89	21.86	21.83
10	16QAM	1	0	22.35	22.36	22.25
10	16QAM	1	25	22.30	22.29	22.32
10	16QAM	1	49	22.28	22.27	22.23
10	16QAM	25	0	21.04	21.01	21.00
10	16QAM	25	12	21.02	21.02	21.09
10	16QAM	25	25	20.98	21.02	21.05
10	16QAM	50	0	21.02	21.01	20.98
10	64QAM	1	0	21.22	21.22	21.11
10	64QAM	1	25	21.13	21.12	21.17
10	64QAM	1	49	21.16	21.16	21.12
10	64QAM	25	0	20.05	20.00	20.00
10	64QAM	25	12	20.03	20.02	20.08
10	64QAM	25	25	20.00	20.00	20.05
10	64QAM	50	0	20.02	20.00	19.95



Channel				18625	18900	19175
Frequency (MHz)				1852.5	1880	1907.5
5	QPSK	1	0	22.86	22.80	22.87
5	QPSK	1	12	22.84	22.81	22.86
5	QPSK	1	24	22.82	22.80	22.84
5	QPSK	12	0	21.92	21.88	21.89
5	QPSK	12	7	21.91	21.89	21.92
5	QPSK	12	13	21.89	21.84	21.90
5	QPSK	25	0	21.87	21.82	21.91
5	16QAM	1	0	22.19	22.18	22.23
5	16QAM	1	12	22.24	22.19	22.21
5	16QAM	1	24	22.21	22.16	22.15
5	16QAM	12	0	21.08	21.06	21.05
5	16QAM	12	7	21.07	21.02	21.09
5	16QAM	12	13	21.06	21.05	21.03
5	16QAM	25	0	21.00	20.97	21.01
5	64QAM	1	0	21.15	21.11	21.12
5	64QAM	1	12	21.20	21.12	21.14
5	64QAM	1	24	21.09	21.06	21.07
5	64QAM	12	0	20.05	20.02	20.03
5	64QAM	12	7	20.05	20.03	20.08
5	64QAM	12	13	20.00	20.03	20.04
5	64QAM	25	0	19.97	19.99	20.01



Channel				18615	18900	19185
Frequency (MHz)				1851.5	1880	1908.5
3	QPSK	1	0	22.83	22.78	22.85
3	QPSK	1	8	22.87	22.81	22.82
3	QPSK	1	14	22.81	22.76	22.85
3	QPSK	8	0	21.90	21.85	21.86
3	QPSK	8	4	21.94	21.89	21.91
3	QPSK	8	7	21.90	21.85	21.89
3	QPSK	15	0	21.86	21.86	21.88
3	16QAM	1	0	22.23	22.23	22.19
3	16QAM	1	8	22.31	22.25	22.27
3	16QAM	1	14	22.21	22.23	22.19
3	16QAM	8	0	21.08	21.05	21.07
3	16QAM	8	4	21.14	21.13	21.13
3	16QAM	8	7	21.10	21.09	21.08
3	16QAM	15	0	21.03	21.00	21.02
3	64QAM	1	0	21.11	21.08	21.13
3	64QAM	1	8	21.15	21.12	21.14
3	64QAM	1	14	21.10	21.09	21.08
3	64QAM	8	0	20.04	20.00	20.03
3	64QAM	8	4	20.08	20.05	20.07
3	64QAM	8	7	20.04	20.03	20.03
3	64QAM	15	0	20.00	19.94	19.99



Channel				18607	18900	19193
Frequency (MHz)				1850.7	1880	1909.3
1.4	QPSK	1	0	22.67	22.72	22.72
1.4	QPSK	1	3	22.73	22.81	22.84
1.4	QPSK	1	5	22.66	22.71	22.73
1.4	QPSK	3	0	22.70	22.75	22.82
1.4	QPSK	3	1	22.71	22.78	22.83
1.4	QPSK	3	3	22.70	22.74	22.82
1.4	QPSK	6	0	21.68	21.76	21.81
1.4	16QAM	1	0	22.06	22.11	22.08
1.4	16QAM	1	3	22.13	22.20	22.18
1.4	16QAM	1	5	22.03	22.13	22.07
1.4	16QAM	3	0	21.82	21.89	21.90
1.4	16QAM	3	1	21.88	21.95	21.95
1.4	16QAM	3	3	21.83	21.88	21.92
1.4	16QAM	6	0	20.88	20.92	21.00
1.4	64QAM	1	0	20.93	21.07	20.97
1.4	64QAM	1	3	20.96	21.08	21.02
1.4	64QAM	1	5	20.91	21.00	20.96
1.4	64QAM	3	0	20.85	20.91	20.89
1.4	64QAM	3	1	20.89	20.94	20.97
1.4	64QAM	3	3	20.83	20.87	20.92
1.4	64QAM	6	0	19.81	19.86	19.90



LTE Band 4

BW [MHz]	Modulation	RB Size	RB Offset	Power Low Ch. / Freq.	Power Middle Ch. / Freq.	Power High Ch. / Freq.
Channel				20050	20175	20300
Frequency (MHz)				1720	1732.5	1745
20	QPSK	1	0	22.79	22.91	22.80
20	QPSK	1	49	22.80	22.77	22.82
20	QPSK	1	99	22.72	22.65	22.66
20	QPSK	50	0	21.83	21.86	21.78
20	QPSK	50	24	21.81	21.81	21.71
20	QPSK	50	50	21.82	21.75	21.82
20	QPSK	100	0	21.75	21.79	21.71
20	16QAM	1	0	22.09	22.21	22.19
20	16QAM	1	49	22.16	22.21	22.24
20	16QAM	1	99	22.15	21.99	22.05
20	16QAM	50	0	20.93	20.98	20.89
20	16QAM	50	24	20.92	20.93	20.86
20	16QAM	50	50	20.95	20.87	20.93
20	16QAM	100	0	20.89	20.93	20.83
20	64QAM	1	0	21.03	21.11	21.17
20	64QAM	1	49	21.08	21.11	21.13
20	64QAM	1	99	21.10	20.91	20.99
20	64QAM	50	0	19.92	20.00	19.88
20	64QAM	50	24	19.91	19.95	19.83
20	64QAM	50	50	19.93	19.84	19.90
20	64QAM	100	0	19.90	19.98	19.84



Channel				20025	20175	20325
Frequency (MHz)				1717.5	1732.5	1747.5
15	QPSK	1	0	22.76	22.90	22.81
15	QPSK	1	37	22.77	22.79	22.80
15	QPSK	1	74	22.64	22.73	22.67
15	QPSK	36	0	21.80	21.84	21.75
15	QPSK	36	20	21.83	21.82	21.84
15	QPSK	36	39	21.77	21.78	21.83
15	QPSK	75	0	21.76	21.80	21.70
15	16QAM	1	0	22.12	22.27	22.21
15	16QAM	1	37	22.17	22.19	22.21
15	16QAM	1	74	22.15	22.08	22.08
15	16QAM	36	0	20.95	20.98	20.90
15	16QAM	36	20	20.95	21.00	21.03
15	16QAM	36	39	20.89	20.87	20.94
15	16QAM	75	0	20.95	20.96	20.82
15	64QAM	1	0	21.05	21.16	21.14
15	64QAM	1	37	21.03	21.05	21.07
15	64QAM	1	74	20.99	20.96	20.95
15	64QAM	36	0	19.96	19.99	19.88
15	64QAM	36	20	19.95	19.96	20.00
15	64QAM	36	39	19.88	19.89	19.93
15	64QAM	75	0	19.94	19.91	19.83



Channel				20000	20175	20350
Frequency (MHz)				1715	1732.5	1750
10	QPSK	1	0	22.75	22.84	22.81
10	QPSK	1	25	22.68	22.80	22.77
10	QPSK	1	49	22.74	22.68	22.67
10	QPSK	25	0	21.75	21.80	21.83
10	QPSK	25	12	21.80	21.80	21.83
10	QPSK	25	25	21.77	21.77	21.78
10	QPSK	50	0	21.81	21.82	21.81
10	16QAM	1	0	22.11	22.27	22.22
10	16QAM	1	25	22.09	22.21	22.16
10	16QAM	1	49	22.11	22.13	22.04
10	16QAM	25	0	20.84	20.95	20.96
10	16QAM	25	12	20.92	20.94	20.97
10	16QAM	25	25	20.88	20.88	20.89
10	16QAM	50	0	20.93	20.93	20.96
10	64QAM	1	0	21.02	21.15	21.11
10	64QAM	1	25	21.00	21.12	21.05
10	64QAM	1	49	21.01	21.02	20.97
10	64QAM	25	0	19.84	19.94	19.98
10	64QAM	25	12	19.93	19.94	19.96
10	64QAM	25	25	19.87	19.90	19.89
10	64QAM	50	0	19.92	19.89	19.92



Channel				19975	20175	20375
Frequency (MHz)				1712.5	1732.5	1752.5
5	QPSK	1	0	22.70	22.81	22.74
5	QPSK	1	12	22.68	22.78	22.71
5	QPSK	1	24	22.61	22.70	22.66
5	QPSK	12	0	21.71	21.79	21.78
5	QPSK	12	7	21.73	21.83	21.84
5	QPSK	12	13	21.67	21.76	21.78
5	QPSK	25	0	21.68	21.79	21.77
5	16QAM	1	0	22.08	22.20	22.12
5	16QAM	1	12	22.06	22.17	22.13
5	16QAM	1	24	22.02	22.14	22.05
5	16QAM	12	0	20.87	20.99	20.97
5	16QAM	12	7	20.87	20.98	21.00
5	16QAM	12	13	20.84	20.93	20.92
5	16QAM	25	0	20.82	20.93	20.91
5	64QAM	1	0	20.96	21.09	21.06
5	64QAM	1	12	20.96	21.05	21.00
5	64QAM	1	24	20.89	21.02	20.95
5	64QAM	12	0	19.82	19.96	19.93
5	64QAM	12	7	19.84	19.97	19.94
5	64QAM	12	13	19.80	19.90	19.90
5	64QAM	25	0	19.79	19.91	19.91





Channel				19965	20175	20385
Frequency (MHz)				1711.5	1732.5	1753.5
3	QPSK	1	0	22.66	22.74	22.73
3	QPSK	1	8	22.66	22.77	22.67
3	QPSK	1	14	22.59	22.70	22.66
3	QPSK	8	0	21.68	21.78	21.74
3	QPSK	8	4	21.70	21.81	21.78
3	QPSK	8	7	21.66	21.78	21.75
3	QPSK	15	0	21.67	21.79	21.77
3	16QAM	1	0	21.99	22.15	22.11
3	16QAM	1	8	22.05	22.17	22.14
3	16QAM	1	14	22.03	22.11	22.06
3	16QAM	8	0	20.91	20.99	20.96
3	16QAM	8	4	20.93	21.00	21.00
3	16QAM	8	7	20.89	20.97	20.96
3	16QAM	15	0	20.84	20.91	20.88
3	64QAM	1	0	20.89	21.03	20.99
3	64QAM	1	8	20.93	21.04	21.01
3	64QAM	1	14	20.92	21.00	20.95
3	64QAM	8	0	19.83	19.94	19.91
3	64QAM	8	4	19.85	19.96	19.95
3	64QAM	8	7	19.83	19.92	19.89
3	64QAM	15	0	19.79	19.90	19.89



Channel				19957	20175	20393
Frequency (MHz)				1710.7	1732.5	1754.3
1.4	QPSK	1	0	22.56	22.67	22.62
1.4	QPSK	1	3	22.66	22.76	22.71
1.4	QPSK	1	5	22.60	22.68	22.60
1.4	QPSK	3	0	22.62	22.72	22.68
1.4	QPSK	3	1	22.68	22.78	22.70
1.4	QPSK	3	3	22.61	22.69	22.67
1.4	QPSK	6	0	21.63	21.71	21.73
1.4	16QAM	1	0	21.92	22.07	21.94
1.4	16QAM	1	3	22.01	22.12	22.07
1.4	16QAM	1	5	21.94	22.04	21.98
1.4	16QAM	3	0	21.77	21.85	21.80
1.4	16QAM	3	1	21.79	21.90	21.83
1.4	16QAM	3	3	21.74	21.83	21.80
1.4	16QAM	6	0	20.83	20.92	20.88
1.4	64QAM	1	0	20.85	20.95	20.88
1.4	64QAM	1	3	20.91	21.01	20.94
1.4	64QAM	1	5	20.83	20.93	20.86
1.4	64QAM	3	0	20.76	20.87	20.82
1.4	64QAM	3	1	20.82	20.92	20.85
1.4	64QAM	3	3	20.76	20.87	20.80
1.4	64QAM	6	0	19.73	19.83	19.81



LTE Band 38

BW [MHz]	Modulation	RB Size	RB Offset	Power Low Ch. / Freq.	Power Middle Ch. / Freq.	Power High Ch. / Freq.
Channel				37850	38000	38150
Frequency (MHz)				2580	2595	2610
20	QPSK	1	0	22.70	22.96	22.89
20	QPSK	1	49	22.82	22.78	22.85
20	QPSK	1	99	22.83	22.80	22.87
20	QPSK	50	0	22.41	22.42	22.40
20	QPSK	50	24	22.41	22.37	22.38
20	QPSK	50	50	22.36	22.33	22.39
20	QPSK	100	0	22.39	22.41	22.39
20	16QAM	1	0	22.52	22.50	22.56
20	16QAM	1	49	22.47	22.41	22.52
20	16QAM	1	99	22.44	22.40	22.51
20	16QAM	50	0	21.53	21.50	21.51
20	16QAM	50	24	21.54	21.50	21.52
20	16QAM	50	50	21.52	21.47	21.53
20	16QAM	100	0	21.51	21.46	21.53
20	64QAM	1	0	21.24	21.22	21.31
20	64QAM	1	49	21.18	21.17	21.27
20	64QAM	1	99	21.22	21.19	21.21
20	64QAM	50	0	20.47	20.42	20.45
20	64QAM	50	24	20.45	20.43	20.43
20	64QAM	50	50	20.46	20.39	20.44
20	64QAM	100	0	20.55	20.51	20.59



Channel				37825	38000	38175
Frequency (MHz)				2577.5	2595	2612.5
15	QPSK	1	0	22.87	22.88	22.89
15	QPSK	1	37	22.90	22.82	22.85
15	QPSK	1	74	22.86	22.87	22.95
15	QPSK	36	0	22.43	22.34	22.40
15	QPSK	36	20	22.44	22.38	22.39
15	QPSK	36	39	22.38	22.36	22.40
15	QPSK	75	0	22.42	22.38	22.41
15	16QAM	1	0	22.51	22.47	22.59
15	16QAM	1	37	22.56	22.44	22.52
15	16QAM	1	74	22.57	22.45	22.57
15	16QAM	36	0	21.52	21.45	21.48
15	16QAM	36	20	21.52	21.49	21.52
15	16QAM	36	39	21.48	21.43	21.47
15	16QAM	75	0	21.55	21.51	21.53
15	64QAM	1	0	21.32	21.24	21.29
15	64QAM	1	37	21.27	21.18	21.26
15	64QAM	1	74	21.32	21.21	21.34
15	64QAM	36	0	20.54	20.48	20.52
15	64QAM	36	20	20.55	20.50	20.55
15	64QAM	36	39	20.53	20.48	20.52
15	64QAM	75	0	20.51	20.51	20.53



Channel				37800	38000	38200
Frequency (MHz)				2575	2595	2615
10	QPSK	1	0	22.89	22.76	22.81
10	QPSK	1	25	22.86	22.80	22.85
10	QPSK	1	49	22.86	22.80	22.84
10	QPSK	25	0	22.37	22.28	22.32
10	QPSK	25	12	22.38	22.31	22.36
10	QPSK	25	25	22.35	22.31	22.37
10	QPSK	50	0	22.39	22.33	22.36
10	16QAM	1	0	22.50	22.44	22.48
10	16QAM	1	25	22.50	22.43	22.48
10	16QAM	1	49	22.51	22.40	22.47
10	16QAM	25	0	21.53	21.44	21.52
10	16QAM	25	12	21.53	21.47	21.51
10	16QAM	25	25	21.52	21.40	21.51
10	16QAM	50	0	21.54	21.44	21.50
10	64QAM	1	0	21.30	21.18	21.23
10	64QAM	1	25	21.23	21.15	21.22
10	64QAM	1	49	21.25	21.19	21.23
10	64QAM	25	0	20.47	20.40	20.45
10	64QAM	25	12	20.46	20.41	20.47
10	64QAM	25	25	20.45	20.37	20.47
10	64QAM	50	0	20.45	20.38	20.43



Channel				37775	38000	38225
Frequency (MHz)				2572.5	2595	2617.5
5	QPSK	1	0	22.89	22.85	22.81
5	QPSK	1	12	22.88	22.83	22.86
5	QPSK	1	24	22.82	22.77	22.80
5	QPSK	12	0	22.41	22.36	22.36
5	QPSK	12	7	22.44	22.38	22.41
5	QPSK	12	13	22.41	22.36	22.40
5	QPSK	25	0	22.40	22.35	22.36
5	16QAM	1	0	22.53	22.43	22.48
5	16QAM	1	12	22.55	22.46	22.50
5	16QAM	1	24	22.53	22.46	22.49
5	16QAM	12	0	21.52	21.39	21.46
5	16QAM	12	7	21.50	21.45	21.48
5	16QAM	12	13	21.46	21.42	21.49
5	16QAM	25	0	21.54	21.51	21.53
5	64QAM	1	0	21.30	21.23	21.24
5	64QAM	1	12	21.29	21.20	21.26
5	64QAM	1	24	21.30	21.19	21.24
5	64QAM	12	0	20.48	20.40	20.43
5	64QAM	12	7	20.56	20.46	20.50
5	64QAM	12	13	20.46	20.42	20.46
5	64QAM	25	0	20.49	20.46	20.45



LTE Band 41

BW [MHz]	Modulation	RB Size	RB Offset	Power Low Ch. / Freq.	Power Middle Ch. / Freq.	Power High Ch. / Freq.
Channel				40140	40640	41140
Frequency (MHz)				2545	2595	2645
20	QPSK	1	0	22.64	22.85	22.88
20	QPSK	1	49	22.68	22.90	22.93
20	QPSK	1	99	22.84	22.92	22.95
20	QPSK	50	0	21.79	21.93	21.96
20	QPSK	50	24	21.86	21.96	21.99
20	QPSK	50	50	21.83	21.90	21.93
20	QPSK	100	0	21.84	21.92	21.95
20	16QAM	1	0	21.91	21.99	22.02
20	16QAM	1	49	21.90	22.00	22.03
20	16QAM	1	99	21.95	22.00	22.03
20	16QAM	50	0	20.90	21.05	21.08
20	16QAM	50	24	20.97	21.07	21.10
20	16QAM	50	50	20.97	21.06	21.09
20	16QAM	100	0	20.93	20.96	21.07
20	64QAM	1	0	20.89	20.78	21.03
20	64QAM	1	49	20.82	20.95	21.03
20	64QAM	1	99	20.74	20.93	21.00
20	64QAM	50	0	20.05	20.10	20.28
20	64QAM	50	24	20.14	20.09	20.22
20	64QAM	50	50	20.09	20.12	20.24
20	64QAM	100	0	20.19	20.19	20.32



Channel				40115	40640	41165
Frequency (MHz)				2542.5	2595	2647.5
15	QPSK	1	0	22.72	22.69	22.82
15	QPSK	1	37	22.73	22.70	22.84
15	QPSK	1	74	22.87	22.84	22.97
15	QPSK	36	0	21.74	21.71	21.92
15	QPSK	36	20	21.88	21.85	21.95
15	QPSK	36	39	21.88	21.85	21.91
15	QPSK	75	0	21.86	21.83	21.93
15	16QAM	1	0	21.85	22.07	22.10
15	16QAM	1	37	21.91	21.99	22.02
15	16QAM	1	74	21.99	21.98	22.01
15	16QAM	36	0	20.83	20.95	20.98
15	16QAM	36	20	20.90	20.98	21.01
15	16QAM	36	39	20.90	20.99	21.02
15	16QAM	75	0	20.92	21.01	21.04
15	64QAM	1	0	20.83	20.94	20.97
15	64QAM	1	37	20.83	20.98	21.01
15	64QAM	1	74	20.91	20.99	21.02
15	64QAM	36	0	20.11	20.11	20.24
15	64QAM	36	20	20.17	20.15	20.24
15	64QAM	36	39	20.14	20.16	20.26
15	64QAM	75	0	20.15	20.15	20.29





Channel				40090	40640	41190
Frequency (MHz)				2540	2595	2650
10	QPSK	1	0	22.68	22.65	22.78
10	QPSK	1	25	22.74	22.71	22.86
10	QPSK	1	49	22.68	22.65	22.89
10	QPSK	25	0	21.75	21.72	21.79
10	QPSK	25	12	21.75	21.72	21.87
10	QPSK	25	25	21.73	21.70	21.89
10	QPSK	50	0	21.74	21.71	21.90
10	16QAM	1	0	21.81	21.97	22.00
10	16QAM	1	25	21.89	21.96	21.99
10	16QAM	1	49	21.88	22.00	22.03
10	16QAM	25	0	20.83	20.95	20.98
10	16QAM	25	12	20.87	20.99	21.02
10	16QAM	25	25	20.85	20.99	21.02
10	16QAM	50	0	20.82	21.00	21.03
10	64QAM	1	0	20.78	20.97	21.00
10	64QAM	1	25	20.79	20.97	21.00
10	64QAM	1	49	20.83	20.95	20.98
10	64QAM	25	0	20.02	20.06	20.15
10	64QAM	25	12	19.99	20.08	20.18
10	64QAM	25	25	19.98	20.01	20.16
10	64QAM	50	0	20.01	20.06	20.14



Channel				40065	40640	41215
Frequency (MHz)				2537.5	2595	2652.5
5	QPSK	1	0	22.62	22.59	22.71
5	QPSK	1	12	22.65	22.62	22.80
5	QPSK	1	24	22.63	22.60	22.65
5	QPSK	12	0	21.70	21.67	21.75
5	QPSK	12	7	21.76	21.73	21.83
5	QPSK	12	13	21.72	21.69	21.80
5	QPSK	25	0	21.70	21.67	21.78
5	16QAM	1	0	21.82	21.83	21.86
5	16QAM	1	12	21.78	21.90	21.93
5	16QAM	1	24	21.76	21.90	21.93
5	16QAM	12	0	20.73	20.82	20.85
5	16QAM	12	7	20.82	20.84	20.87
5	16QAM	12	13	20.78	20.79	20.82
5	16QAM	25	0	20.80	20.86	20.89
5	64QAM	1	0	20.82	20.82	20.85
5	64QAM	1	12	20.80	20.72	20.75
5	64QAM	1	24	20.84	20.78	20.81
5	64QAM	12	0	19.99	20.03	20.02
5	64QAM	12	7	20.03	20.08	20.08
5	64QAM	12	13	20.00	20.05	20.05
5	64QAM	25	0	19.97	20.02	20.07



LTE Band 66

BW [MHz]	Modulation	RB Size	RB Offset	Power Low Ch. / Freq.	Power Middle Ch. / Freq.	Power High Ch. / Freq.
Channel				132072	132322	132572
Frequency (MHz)				1720	1745	1770
20	QPSK	1	0	22.88	22.92	22.77
20	QPSK	1	49	22.82	22.69	22.66
20	QPSK	1	99	22.62	22.59	22.50
20	QPSK	50	0	21.89	22.09	21.97
20	QPSK	50	24	22.08	21.97	21.91
20	QPSK	50	50	21.96	21.98	21.83
20	QPSK	100	0	22.04	22.00	21.94
20	16QAM	1	0	22.43	22.48	22.34
20	16QAM	1	49	22.38	22.36	22.29
20	16QAM	1	99	22.24	22.16	22.09
20	16QAM	50	0	21.21	21.17	21.11
20	16QAM	50	24	21.17	21.13	21.09
20	16QAM	50	50	21.11	21.06	20.98
20	16QAM	100	0	21.13	21.10	21.04
20	64QAM	1	0	21.29	21.28	21.25
20	64QAM	1	49	21.30	21.22	21.12
20	64QAM	1	99	21.19	21.09	21.03
20	64QAM	50	0	20.20	20.14	20.07
20	64QAM	50	24	20.18	20.10	20.04
20	64QAM	50	50	20.09	20.03	19.95
20	64QAM	100	0	20.19	20.10	20.04



Channel				132047	132322	132597
Frequency (MHz)				1717.5	1745	1772.5
15	QPSK	1	0	22.86	22.79	22.71
15	QPSK	1	37	22.77	22.68	22.60
15	QPSK	1	74	22.68	22.62	22.55
15	QPSK	36	0	22.05	22.01	21.90
15	QPSK	36	20	22.03	22.01	21.89
15	QPSK	36	39	22.00	21.95	21.82
15	QPSK	75	0	21.98	21.93	21.85
15	16QAM	1	0	22.44	22.45	22.34
15	16QAM	1	37	22.38	22.35	22.20
15	16QAM	1	74	22.35	22.23	22.16
15	16QAM	36	0	21.20	21.14	21.05
15	16QAM	36	20	21.20	21.15	21.05
15	16QAM	36	39	21.14	21.04	21.00
15	16QAM	75	0	21.13	21.12	20.97
15	64QAM	1	0	21.38	21.34	21.19
15	64QAM	1	37	21.28	21.19	21.07
15	64QAM	1	74	21.20	21.07	21.02
15	64QAM	36	0	20.18	20.13	20.07
15	64QAM	36	20	20.20	20.12	20.04
15	64QAM	36	39	20.12	20.03	19.97
15	64QAM	75	0	20.16	20.10	20.03



Channel				132022	132322	132622
Frequency (MHz)				1715	1745	1775
10	QPSK	1	0	22.81	22.77	22.62
10	QPSK	1	25	22.78	22.70	22.61
10	QPSK	1	49	22.71	22.61	22.52
10	QPSK	25	0	22.05	21.98	21.87
10	QPSK	25	12	22.07	21.97	21.87
10	QPSK	25	25	21.98	21.89	21.81
10	QPSK	50	0	22.01	21.95	21.87
10	16QAM	1	0	22.44	22.40	22.25
10	16QAM	1	25	22.42	22.36	22.20
10	16QAM	1	49	22.28	22.22	22.11
10	16QAM	25	0	21.20	21.08	21.03
10	16QAM	25	12	21.21	21.09	21.01
10	16QAM	25	25	21.15	21.05	20.95
10	16QAM	50	0	21.16	21.10	21.01
10	64QAM	1	0	21.30	21.24	21.11
10	64QAM	1	25	21.25	21.17	21.07
10	64QAM	1	49	21.20	21.10	20.99
10	64QAM	25	0	20.17	20.10	20.01
10	64QAM	25	12	20.17	20.08	19.99
10	64QAM	25	25	20.14	20.04	19.96
10	64QAM	50	0	20.11	20.09	19.96



Channel				131997	132322	132647
Frequency (MHz)				1712.5	1745	1777.5
5	QPSK	1	0	22.77	22.69	22.58
5	QPSK	1	12	22.75	22.65	22.55
5	QPSK	1	24	22.72	22.63	22.50
5	QPSK	12	0	22.02	21.95	21.87
5	QPSK	12	7	22.08	22.00	21.88
5	QPSK	12	13	22.02	21.93	21.85
5	QPSK	25	0	22.00	21.95	21.80
5	16QAM	1	0	22.33	22.36	22.18
5	16QAM	1	12	22.39	22.31	22.19
5	16QAM	1	24	22.34	22.25	22.14
5	16QAM	12	0	21.19	21.10	21.00
5	16QAM	12	7	21.21	21.16	21.05
5	16QAM	12	13	21.17	21.09	20.98
5	16QAM	25	0	21.17	21.07	20.94
5	64QAM	1	0	21.27	21.19	21.06
5	64QAM	1	12	21.27	21.22	21.04
5	64QAM	1	24	21.24	21.11	21.00
5	64QAM	12	0	20.18	20.08	19.98
5	64QAM	12	7	20.19	20.13	20.04
5	64QAM	12	13	20.15	20.04	19.95
5	64QAM	25	0	20.13	20.07	19.94



Channel				131987	132322	132657
Frequency (MHz)				1711.5	1745	1778.5
3	QPSK	1	0	22.74	22.67	22.56
3	QPSK	1	8	22.76	22.66	22.56
3	QPSK	1	14	22.70	22.61	22.51
3	QPSK	8	0	22.02	21.95	21.82
3	QPSK	8	4	22.07	21.95	21.83
3	QPSK	8	7	22.01	21.92	21.79
3	QPSK	15	0	22.03	21.93	21.81
3	16QAM	1	0	22.31	22.22	22.16
3	16QAM	1	8	22.30	22.25	22.16
3	16QAM	1	14	22.26	22.19	22.08
3	16QAM	8	0	21.22	21.14	21.03
3	16QAM	8	4	21.22	21.17	21.07
3	16QAM	8	7	21.20	21.12	21.00
3	16QAM	15	0	21.18	21.05	20.95
3	64QAM	1	0	21.20	21.13	21.03
3	64QAM	1	8	21.22	21.17	21.05
3	64QAM	1	14	21.20	21.09	21.00
3	64QAM	8	0	20.17	20.08	19.95
3	64QAM	8	4	20.19	20.12	19.99
3	64QAM	8	7	20.14	20.07	19.96
3	64QAM	15	0	20.14	20.05	19.96



Channel				131979	132322	132665
Frequency (MHz)				1710.7	1745	1779.3
1.4	QPSK	1	0	22.69	22.56	22.49
1.4	QPSK	1	3	22.76	22.67	22.56
1.4	QPSK	1	5	22.65	22.56	22.47
1.4	QPSK	3	0	22.74	22.64	22.51
1.4	QPSK	3	1	22.76	22.64	22.56
1.4	QPSK	3	3	22.75	22.60	22.51
1.4	QPSK	6	0	21.97	21.86	21.76
1.4	16QAM	1	0	22.22	22.20	22.09
1.4	16QAM	1	3	22.32	22.27	22.17
1.4	16QAM	1	5	22.24	22.21	22.04
1.4	16QAM	3	0	22.03	21.99	21.87
1.4	16QAM	3	1	22.08	22.03	21.87
1.4	16QAM	3	3	22.05	21.98	21.82
1.4	16QAM	6	0	21.16	21.05	20.95
1.4	64QAM	1	0	21.12	21.12	20.97
1.4	64QAM	1	3	21.20	21.18	21.06
1.4	64QAM	1	5	21.13	21.07	20.96
1.4	64QAM	3	0	21.08	21.04	20.87
1.4	64QAM	3	1	21.11	21.08	20.89
1.4	64QAM	3	3	21.05	21.01	20.88
1.4	64QAM	6	0	20.08	19.98	19.90





**EIRP**

LTE Band 2 (GT - LC = 0.14 dB) QPSK									
Bandwidth	1.4M			3M			5M		
Channel	18607	18900	19193	18615	18900	19185	18625	18900	19175
	(Low)	(Mid)	(High)	(Low)	(Mid)	(High)	(Low)	(Mid)	(High)
Frequency	1850.7	1880	1909.3	1851.5	1880	1908.5	1852.5	1880	1907.5
(MHz)									
Conducted Power (dBm)	22.73	22.81	22.84	22.87	22.81	22.82	22.86	22.80	22.87
Conducted Power (Watts)	0.1875	0.1910	0.1923	0.1936	0.1910	0.1914	0.1932	0.1905	0.1936
EIRP(dBm)	22.87	22.95	22.98	23.01	22.95	22.96	23.00	22.94	23.01
EIRP(Watts)	0.1936	0.1972	0.1986	0.2000	0.1972	0.1977	0.1995	0.1968	0.2000

LTE Band 2 (GT - LC = 0.14 dB) QPSK									
Bandwidth	10M			15M			20M		
Channel	18650	18900	19150	18675	18900	19125	18650	18900	19100
	(Low)	(Mid)	(High)	(Low)	(Mid)	(High)	(Low)	(Mid)	(High)
Frequency	1855	1880	1905	1857.5	1880	1902.5	1860	1880	1900
(MHz)									
Conducted Power (dBm)	22.97	22.92	22.86	22.86	22.81	22.94	22.91	22.98	22.96
Conducted Power (Watts)	0.1982	0.1959	0.1932	0.1932	0.1910	0.1968	0.1954	0.1986	0.1977
EIRP(dBm)	23.11	23.06	23.00	23.00	22.95	23.08	23.05	23.12	23.10
EIRP(Watts)	0.2046	0.2023	0.1995	0.1995	0.1972	0.2032	0.2018	0.2051	0.2042



LTE Band 2 (GT - LC = 0.14 dB) 16QAM									
Bandwidth	1.4M			3M			5M		
Channel	18607	18900	19193	18615	18900	19185	18625	18900	19175
	(Low)	(Mid)	(High)	(Low)	(Mid)	(High)	(Low)	(Mid)	(High)
Frequency (MHz)	1850.7	1880	1909.3	1851.5	1880	1908.5	1852.5	1880	1907.5
Conducted Power (dBm)	22.13	22.20	22.18	22.31	22.25	22.27	22.24	22.19	22.21
Conducted Power (Watts)	0.1633	0.1660	0.1652	0.1702	0.1679	0.1687	0.1675	0.1656	0.1663
EIRP(dBm)	22.27	22.34	22.32	22.45	22.39	22.41	22.38	22.33	22.35
EIRP(Watts)	0.1687	0.1714	0.1706	0.1758	0.1734	0.1742	0.1730	0.1710	0.1718

LTE Band 2 (GT - LC = 0.14 dB) 16QAM									
Bandwidth	10M			15M			20M		
Channel	18650	18900	19150	18675	18900	19125	18650	18900	19100
	(Low)	(Mid)	(High)	(Low)	(Mid)	(High)	(Low)	(Mid)	(High)
Frequency (MHz)	1855	1880	1905	1857.5	1880	1902.5	1860	1880	1900
Conducted Power (dBm)	22.35	22.36	22.25	22.32	22.28	22.34	22.34	22.33	22.33
Conducted Power (Watts)	0.1718	0.1722	0.1679	0.1706	0.1690	0.1714	0.1714	0.1710	0.1710
EIRP(dBm)	22.49	22.50	22.39	22.46	22.42	22.48	22.48	22.47	22.47
EIRP(Watts)	0.1774	0.1778	0.1734	0.1762	0.1746	0.1770	0.1770	0.1766	0.1766



LTE Band 2 (GT - LC = 0.14 dB) 64QAM									
Bandwidth	1.4M			3M			5M		
Channel	18607	18900	19193	18615	18900	19185	18625	18900	19175
	(Low)	(Mid)	(High)	(Low)	(Mid)	(High)	(Low)	(Mid)	(High)
Frequency (MHz)	1850.7	1880	1909.3	1851.5	1880	1908.5	1852.5	1880	1907.5
Conducted Power (dBm)	20.96	21.08	21.02	21.15	21.12	21.14	21.20	21.12	21.14
Conducted Power (Watts)	0.1247	0.1282	0.1265	0.1303	0.1294	0.1300	0.1318	0.1294	0.1300
EIRP(dBm)	21.10	21.22	21.16	21.29	21.26	21.28	21.34	21.26	21.28
EIRP(Watts)	0.1288	0.1324	0.1306	0.1346	0.1337	0.1343	0.1361	0.1337	0.1343

LTE Band 2 (GT - LC = 0.14 dB) 64QAM									
Bandwidth	10M			15M			20M		
Channel	18650	18900	19150	18675	18900	19125	18650	18900	19100
	(Low)	(Mid)	(High)	(Low)	(Mid)	(High)	(Low)	(Mid)	(High)
Frequency (MHz)	1855	1880	1905	1857.5	1880	1902.5	1860	1880	1900
Conducted Power (dBm)	21.22	21.22	21.11	21.14	21.18	21.24	21.27	21.19	21.23
Conducted Power (Watts)	0.1324	0.1324	0.1291	0.1300	0.1312	0.1330	0.1340	0.1315	0.1327
EIRP(dBm)	21.36	21.36	21.25	21.28	21.32	21.38	21.41	21.33	21.37
EIRP(Watts)	0.1368	0.1368	0.1334	0.1343	0.1355	0.1374	0.1384	0.1358	0.1371



LTE Band 41 (G <sub>T</sub> - L <sub>C</sub> = -1.30dB) QPSK									
Bandwidth	5M			10M			15M		
Channel	40065	40640	41215	40090	40640	41190	40115	40640	41165
	(Low)	(Mid)	(High)	(Low)	(Mid)	(High)	(Low)	(Mid)	(High)
Frequency (MHz)	2537.5	2595	2652.5	2540	2595	2650	2542.5	2595	2647.5
Conducted Power (dBm)	22.65	22.62	22.80	22.68	22.65	22.89	22.87	22.84	22.97
Conducted Power (Watts)	0.1841	0.1828	0.1905	0.1854	0.1841	0.1945	0.1936	0.1923	0.1982
EIRP(dBm)	21.35	21.32	21.50	21.38	21.35	21.59	21.57	21.54	21.67
EIRP(Watts)	0.1365	0.1355	0.1413	0.1374	0.1365	0.1442	0.1435	0.1426	0.1469

LTE Band 41 (G <sub>T</sub> - L <sub>C</sub> = -1.30dB) QPSK			
Bandwidth	20M		
Channel	40140	40640	41140
	(Low)	(Mid)	(High)
Frequency (MHz)	2545	2595	2645
Conducted Power (dBm)	22.84	22.92	22.95
Conducted Power (Watts)	0.1923	0.1959	0.1972
EIRP(dBm)	21.54	21.62	21.65
EIRP(Watts)	0.1426	0.1452	0.1462



LTE Band 41 (G <sub>T</sub> - L <sub>C</sub> = -1.30dB) 16QAM									
Bandwidth	5M			10M			15M		
Channel	40065	40640	41215	40065	40640	41215	40065	40640	41215
	(Low)	(Mid)	(High)	(Low)	(Mid)	(High)	(Low)	(Mid)	(High)
Frequency (MHz)	2537.5	2595	2652.5	2537.5	2595	2652.5	2537.5	2595	2652.5
Conducted Power (dBm)	21.78	21.90	21.93	21.88	22.00	22.03	21.85	22.07	22.10
Conducted Power (Watts)	0.1507	0.1549	0.1560	0.1542	0.1585	0.1596	0.1531	0.1611	0.1622
EIRP(dBm)	20.48	20.60	20.63	20.58	20.70	20.73	20.55	20.77	20.80
EIRP(Watts)	0.1117	0.1148	0.1156	0.1143	0.1175	0.1183	0.1135	0.1194	0.1202

LTE Band 41 (G <sub>T</sub> - L <sub>C</sub> = -1.30dB) 16QAM			
Bandwidth	20M		
Channel	40140	40640	41140
	(Low)	(Mid)	(High)
Frequency (MHz)	2545	2595	2645
Conducted Power (dBm)	21.95	22.00	22.03
Conducted Power (Watts)	0.1567	0.1585	0.1596
EIRP(dBm)	20.65	20.70	20.73
EIRP(Watts)	0.1161	0.1175	0.1183



LTE Band 41 (G <sub>T</sub> - L <sub>C</sub> = -1.30dB) 64QAM									
Bandwidth	5M			10M			15M		
Channel	40065	40640	41215	40065	40640	41215	40065	40640	41215
	(Low)	(Mid)	(High)	(Low)	(Mid)	(High)	(Low)	(Mid)	(High)
Frequency (MHz)	2537.5	2595	2652.5	2537.5	2595	2652.5	2537.5	2595	2652.5
Conducted Power (dBm)	20.82	20.82	20.85	20.79	20.97	21.00	20.91	20.99	21.02
Conducted Power (Watts)	0.1208	0.1208	0.1216	0.1199	0.1250	0.1259	0.1233	0.1256	0.1265
EIRP(dBm)	19.52	19.52	19.55	19.49	19.67	19.70	19.61	19.69	19.72
EIRP(Watts)	0.0895	0.0895	0.0902	0.0889	0.0927	0.0933	0.0914	0.0931	0.0938

LTE Band 41 (G <sub>T</sub> - L <sub>C</sub> = -1.30dB) 64QAM			
Bandwidth	20M		
Channel	40140	40640	41140
	(Low)	(Mid)	(High)
Frequency (MHz)	2545	2595	2645
Conducted Power (dBm)	20.82	20.95	21.03
Conducted Power (Watts)	0.1208	0.1245	0.1268
EIRP(dBm)	19.52	19.65	19.73
EIRP(Watts)	0.0895	0.0923	0.0940



LTE Band 66 (GT - LC = 0.30 dB) QPSK									
Bandwidth	1.4M			3M			5M		
Channel	131979	132322	132665	131987	132322	132657	131997	132322	132647
	(Low)	(Mid)	(High)	(Low)	(Mid)	(High)	(Low)	(Mid)	(High)
Frequency (MHz)	1710.7	1745	1779.3	1711.5	1745	1778.5	1712.5	1745	1777.5
Conducted Power (dBm)	22.76	22.67	22.56	22.76	22.66	22.56	22.77	22.69	22.58
Conducted Power (Watts)	0.1888	0.1849	0.1803	0.1888	0.1845	0.1803	0.1892	0.1858	0.1811
EIRP(dBm)	23.06	22.97	22.86	23.06	22.96	22.86	23.07	22.99	22.88
EIRP(Watts)	0.2023	0.1982	0.1932	0.2023	0.1977	0.1932	0.2028	0.1991	0.1941

LTE Band 66 (GT - LC = 0.30 dB) QPSK									
Bandwidth	10M			15M			20M		
Channel	132022	132322	132622	132047	132322	132597	132072	132322	132572
	(Low)	(Mid)	(High)	(Low)	(Mid)	(High)	(Low)	(Mid)	(Mid)
Frequency (MHz)	1715	1745	1775	1717.5	1745	1772.5	1720	1745	1770
Conducted Power (dBm)	22.81	22.77	22.62	22.86	22.79	22.71	22.88	22.92	22.77
Conducted Power (Watts)	0.1910	0.1892	0.1828	0.1932	0.1901	0.1866	0.1941	0.1959	0.1892
EIRP(dBm)	23.11	23.07	22.92	23.16	23.09	23.01	23.18	23.22	23.07
EIRP(Watts)	0.2046	0.2028	0.1959	0.2070	0.2037	0.2000	0.2080	0.2099	0.2028



LTE Band 66 (GT - LC = 0.30 dB) 16QAM									
Bandwidth	1.4M			3M			5M		
Channel	131979	132322	132665	131987	132322	132657	131997	132322	132647
	(Low)	(Mid)	(High)	(Low)	(Mid)	(High)	(Low)	(Mid)	(High)
Frequency (MHz)	1710.7	1745	1779.3	1711.5	1745	1778.5	1712.5	1745	1777.5
Conducted Power (dBm)	22.32	22.27	22.17	22.31	22.22	22.16	22.39	22.31	22.19
Conducted Power (Watts)	0.1706	0.1687	0.1648	0.1702	0.1667	0.1644	0.1734	0.1702	0.1656
EIRP(dBm)	22.62	22.57	22.47	22.61	22.52	22.46	22.69	22.61	22.49
EIRP(Watts)	0.1828	0.1807	0.1766	0.1824	0.1786	0.1762	0.1858	0.1824	0.1774

LTE Band 66 (GT - LC = 0.30 dB) 16QAM									
Bandwidth	10M			15M			20M		
Channel	132022	132322	132622	132047	132322	132597	132072	132322	132572
	(Low)	(Mid)	(High)	(Low)	(Mid)	(High)	(Low)	(Mid)	(Mid)
Frequency (MHz)	1715	1745	1775	1717.5	1745	1772.5	1720	1745	1770
Conducted Power (dBm)	22.44	22.40	22.25	22.44	22.45	22.34	22.43	22.48	22.34
Conducted Power (Watts)	0.1754	0.1738	0.1679	0.1754	0.1758	0.1714	0.1750	0.1770	0.1714
EIRP(dBm)	22.74	22.70	22.55	22.74	22.75	22.64	22.73	22.78	22.64
EIRP(Watts)	0.1879	0.1862	0.1799	0.1879	0.1884	0.1837	0.1875	0.1897	0.1837





LTE Band 66 (GT - LC = 0.30 dB) 64QAM									
Bandwidth	1.4M			3M			5M		
Channel	131979	132322	132665	131987	132322	132657	131997	132322	132647
	(Low)	(Mid)	(High)	(Low)	(Mid)	(High)	(Low)	(Mid)	(High)
Frequency (MHz)	1710.7	1745	1779.3	1711.5	1745	1778.5	1712.5	1745	1777.5
Conducted Power (dBm)	21.20	21.18	21.06	21.22	21.17	21.05	21.27	21.22	21.04
Conducted Power (Watts)	0.1318	0.1312	0.1276	0.1324	0.1309	0.1274	0.1340	0.1324	0.1271
EIRP(dBm)	21.50	21.48	21.36	21.52	21.47	21.35	21.57	21.52	21.34
EIRP(Watts)	0.1413	0.1406	0.1368	0.1419	0.1403	0.1365	0.1435	0.1419	0.1361

LTE Band 66 (GT - LC = 0.30 dB) 64QAM									
Bandwidth	10M			15M			20M		
Channel	132022	132322	132622	132047	132322	132597	132072	132322	132572
	(Low)	(Mid)	(High)	(Low)	(Mid)	(High)	(Low)	(Mid)	(Mid)
Frequency (MHz)	1715	1745	1775	1717.5	1745	1772.5	1720	1745	1770
Conducted Power (dBm)	21.30	21.24	21.11	21.38	21.34	21.19	21.30	21.22	21.12
Conducted Power (Watts)	0.1349	0.1330	0.1291	0.1374	0.1361	0.1315	0.1349	0.1324	0.1294
EIRP(dBm)	21.60	21.54	21.41	21.68	21.64	21.49	21.60	21.52	21.42
EIRP(Watts)	0.1445	0.1426	0.1384	0.1472	0.1459	0.1409	0.1445	0.1419	0.1387



# LTE Band 2

## Peak-to-Average Ratio

Mode	LTE Band 2 / 20MHz				
Mod.	QPSK		16QAM		Limit: 13dB
RB Size	1RB	Full RB	1RB	Full RB	Result
Lowest CH	3.68	4.72	5.10	6.17	PASS
Middle CH	3.80	4.84	5.36	6.17	
Highest CH	3.71	4.64	5.48	6.06	
Mode	LTE Band 2 / 20MHz				
Mod.	64QAM				Limit: 13dB
RB Size	1RB	Full RB			Result
Lowest CH	5.39	6.20	-	-	PASS
Middle CH	5.65	6.17	-	-	
Highest CH	5.59	6.03	-	-	



LTE Band 2 / 20MHz / QPSK

Lowest Channel / 1RB

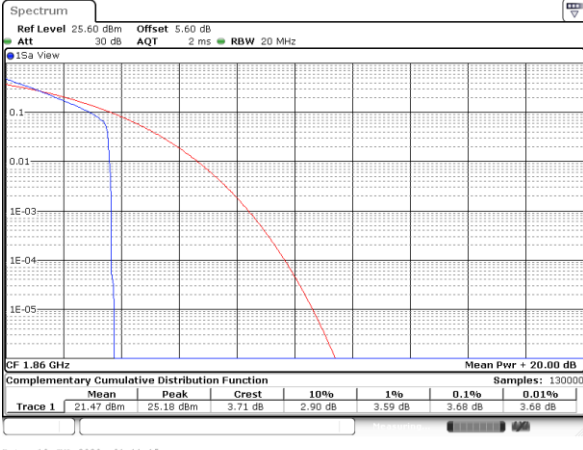

Date: 10\_JUL\_2020 01:11:15

Lowest Channel / Full RB

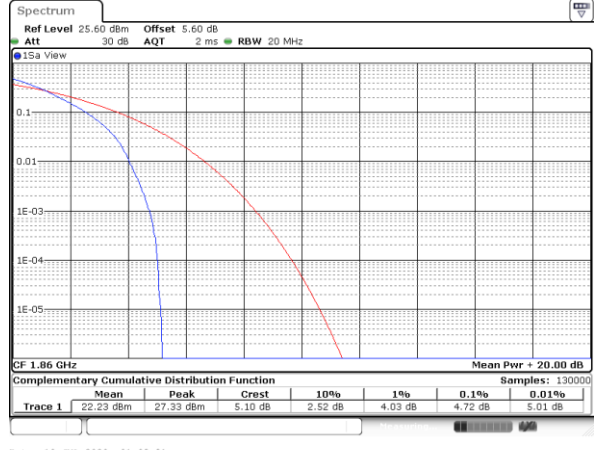

Date: 10\_JUL\_2020 01:10:31

Middle Channel / 1RB

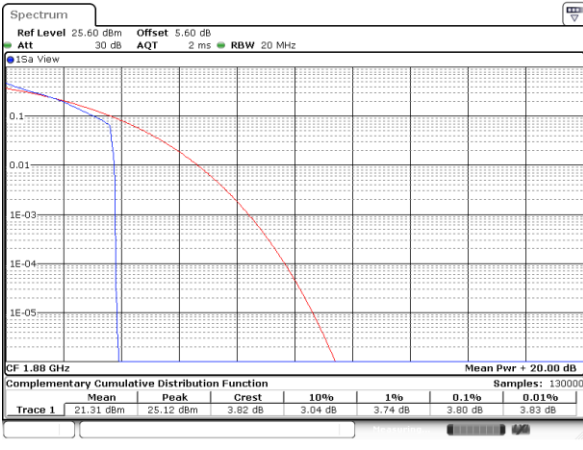

Date: 10\_JUL\_2020 01:11:55

Middle Channel / Full RB

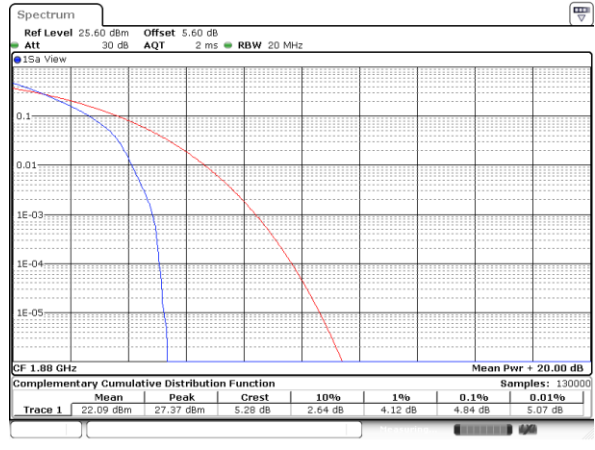

Date: 10\_JUL\_2020 01:13:19

Highest Channel / 1RB

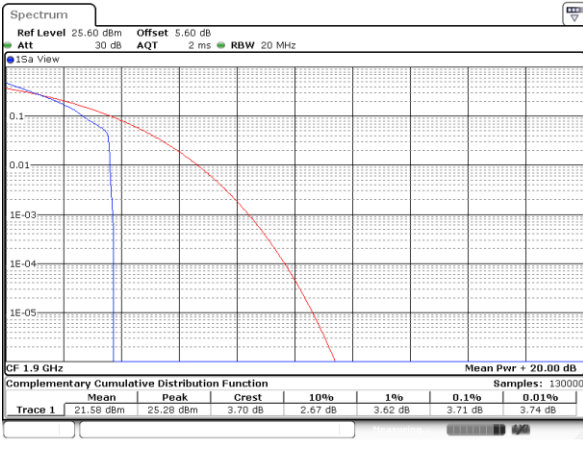

Date: 10\_JUL\_2020 01:15:45

Highest Channel / Full RB

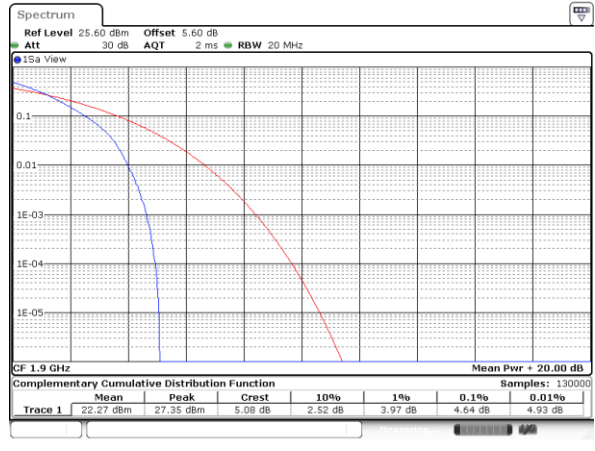

Date: 10\_JUL\_2020 01:13:56



LTE Band 2 / 20MHz / 16QAM

Lowest Channel / 1RB



Date: 10\_JUL\_2020 01:10:59

Lowest Channel / Full RB

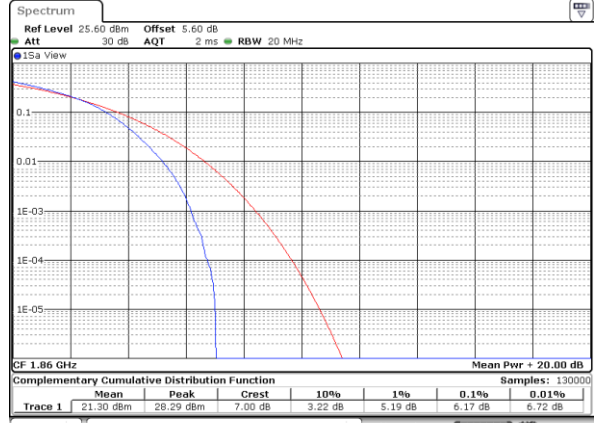

Date: 10\_JUL\_2020 01:10:49

Middle Channel / 1RB

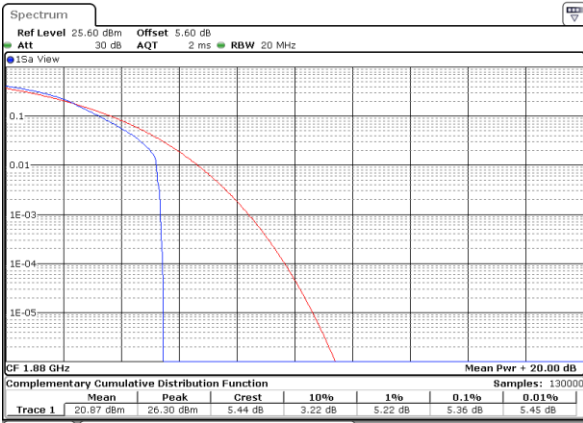

Date: 10\_JUL\_2020 01:12:12

Middle Channel / Full RB

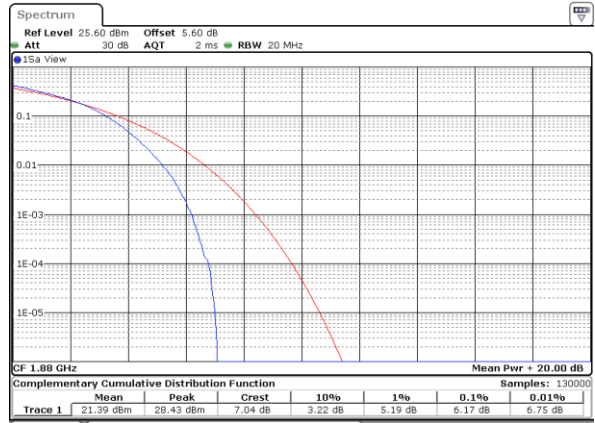

Date: 10\_JUL\_2020 01:13:01

Highest Channel / 1RB

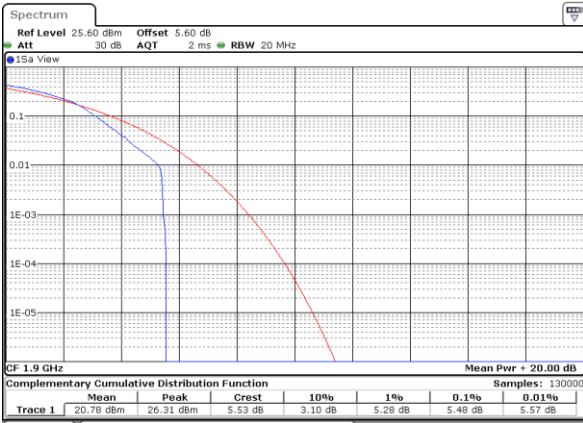

Date: 10\_JUL\_2020 01:15:32

Highest Channel / Full RB

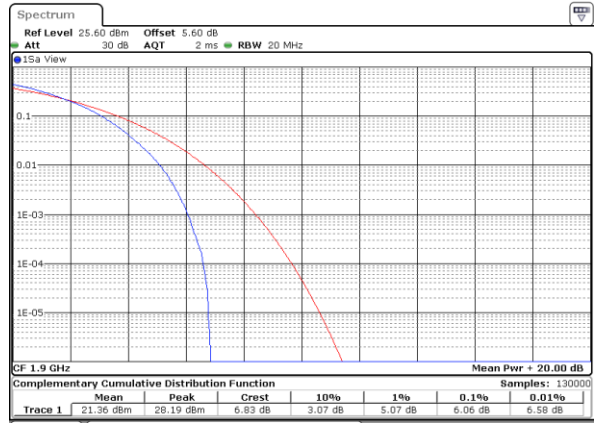

Date: 10\_JUL\_2020 01:14:15



LTE Band 2 / 20MHz / 64QAM

Lowest Channel / 1RB

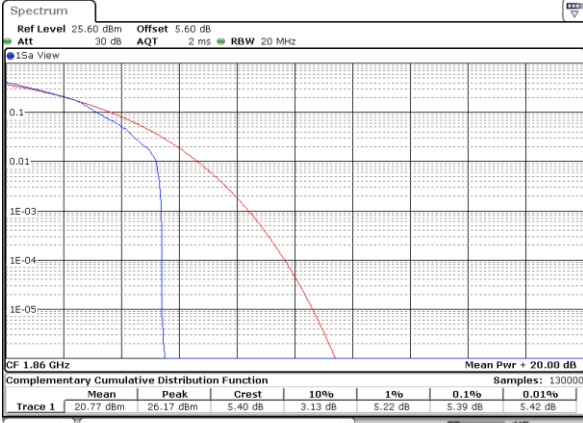

Date: 10\_JUL\_2020 01:10:45

Lowest Channel / Full RB

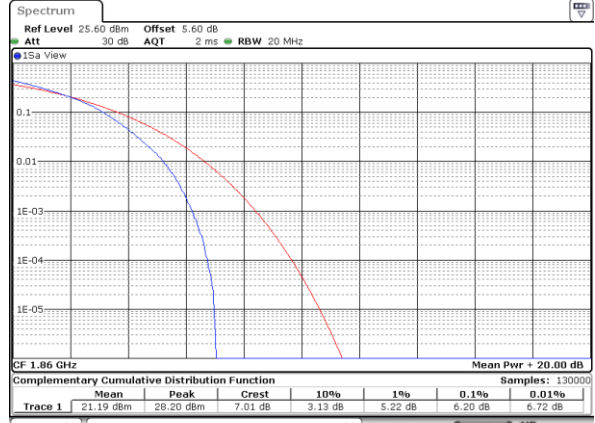

Date: 10\_JUL\_2020 01:10:06

Middle Channel / 1RB

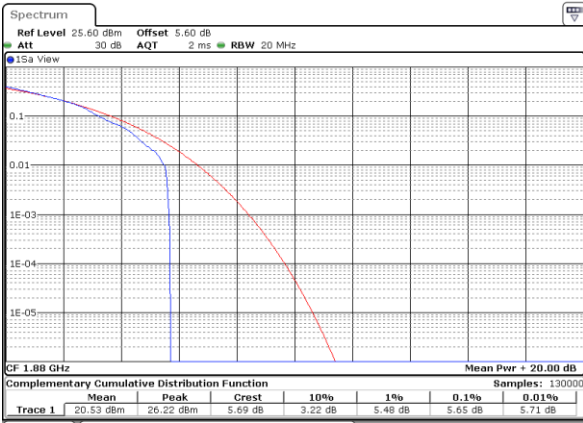

Date: 10\_JUL\_2020 01:12:25

Middle Channel / Full RB

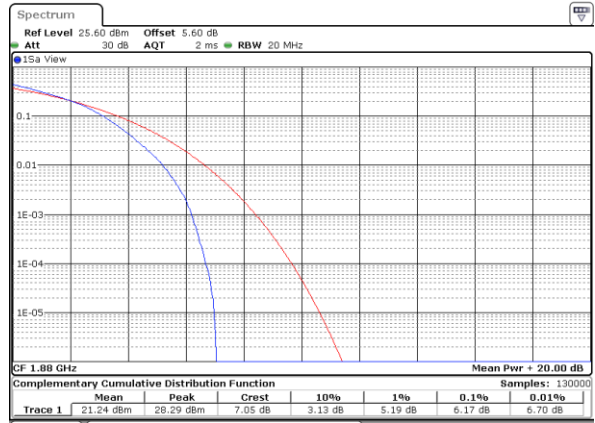

Date: 10\_JUL\_2020 01:12:46

Highest Channel / 1RB



Date: 10\_JUL\_2020 01:15:15

Highest Channel / Full RB

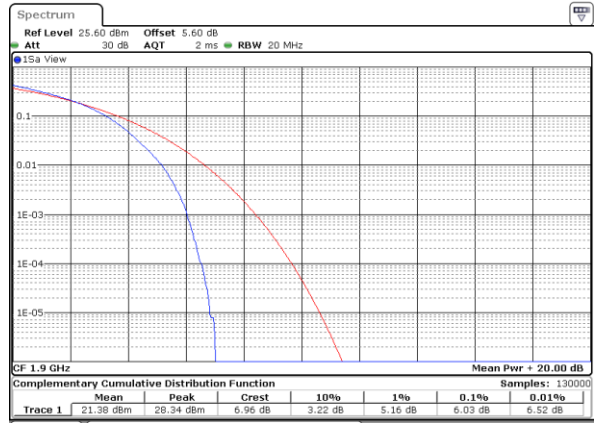

Date: 10\_JUL\_2020 01:14:49



**26dB Bandwidth**

Mode	LTE Band 2 : 26dB BW(MHz)											
BW	1.4MHz		3MHz		5MHz		10MHz		15MHz		20MHz	
Mod.	QPSK	16QAM	QPSK	16QAM	QPSK	16QAM	QPSK	16QAM	QPSK	16QAM	QPSK	16QAM
Lowest CH	1.23	1.22	2.99	3.02	4.94	4.88	9.73	9.81	14.36	14.33	20.14	20.10
Middle CH	1.23	1.23	3.05	3.00	4.93	4.90	9.97	9.81	14.18	14.45	20.22	20.10
Highest CH	1.23	1.24	3.02	3.00	4.88	4.88	9.71	9.77	14.21	14.48	20.10	20.10
Mode	LTE Band 2 : 26dB BW(MHz)											
BW	1.4MHz		3MHz		5MHz		10MHz		15MHz		20MHz	
Mod.	64QAM		64QAM		64QAM		64QAM		64QAM		64QAM	
Lowest CH	1.23	-	3.00	-	4.84	-	9.81	-	14.48	-	20.14	-
Middle CH	1.21	-	3.02	-	5.00	-	9.89	-	14.57	-	20.18	-
Highest CH	1.24	-	3.00	-	4.97	-	9.91	-	14.27	-	20.06	-



LTE Band 2

Lowest Channel / 1.4MHz / QPSK

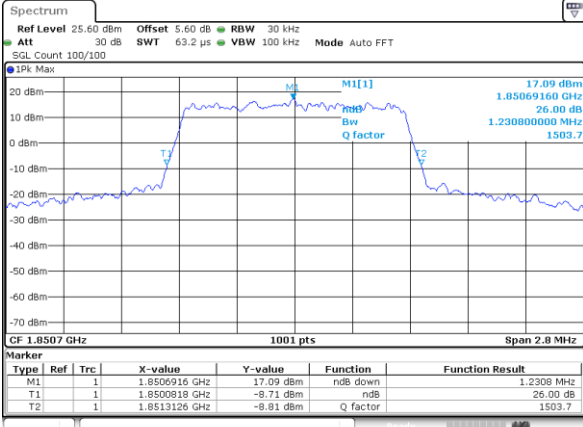

Date: 9 JUL 2020 21:57:44

Lowest Channel / 1.4MHz / 16QAM

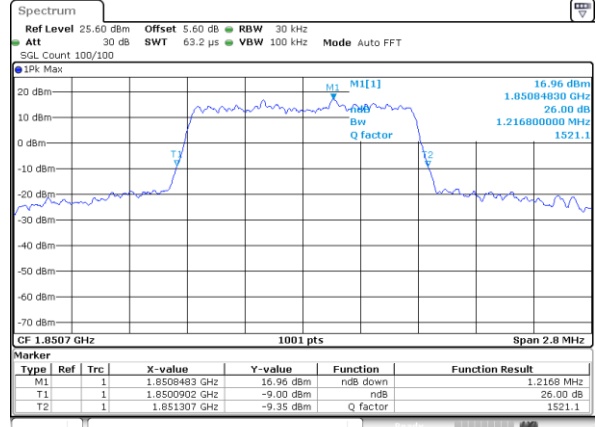

Date: 9 JUL 2020 21:57:54

Middle Channel / 1.4MHz / QPSK

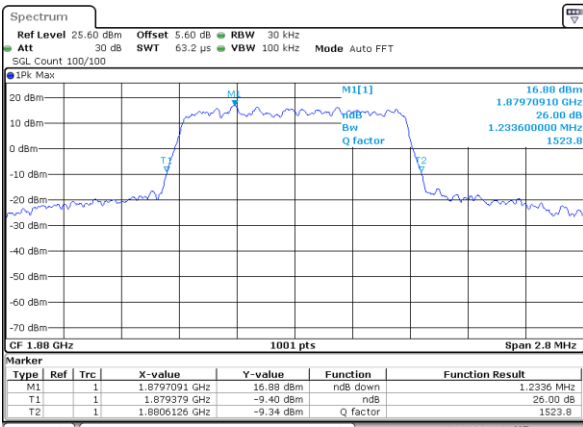

Date: 9 JUL 2020 22:05:12

Middle Channel / 1.4MHz / 16QAM

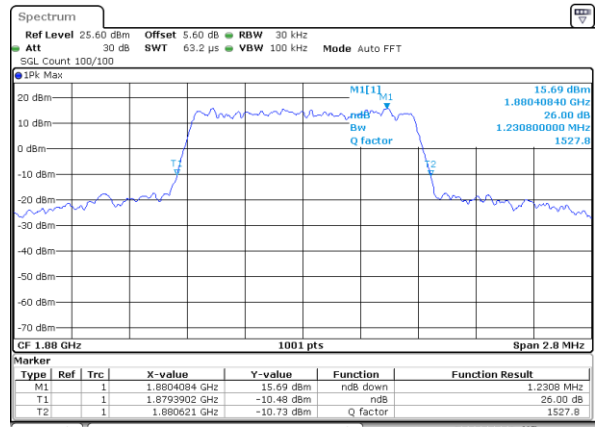

Date: 9 JUL 2020 22:05:22

Highest Channel / 1.4MHz / QPSK

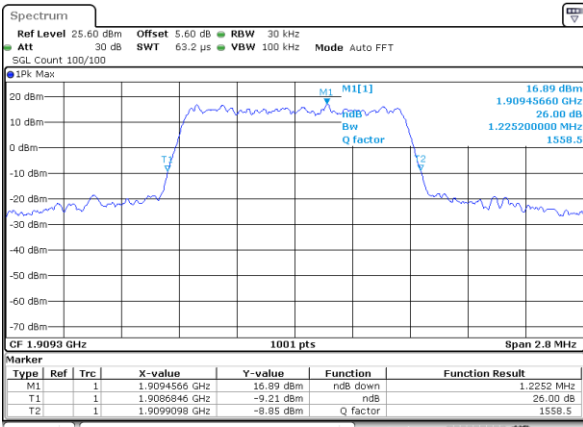

Date: 9 JUL 2020 22:07:45

Highest Channel / 1.4MHz / 16QAM

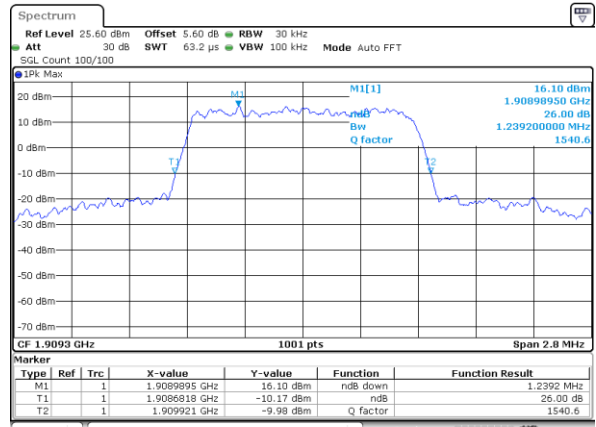

Date: 9 JUL 2020 22:07:55



LTE Band 2

Lowest Channel / 3MHz / QPSK

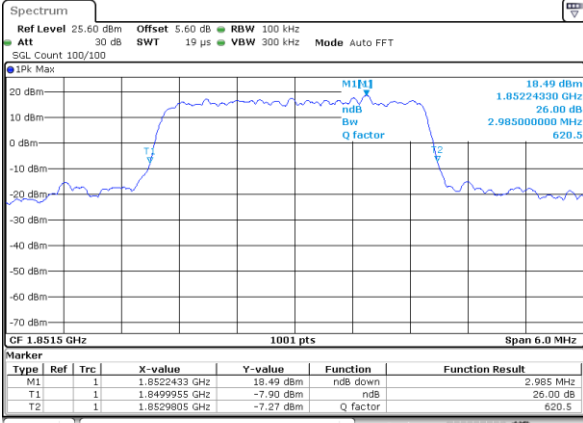

Date: 9 JUL 2020 22:14:50

Lowest Channel / 3MHz / 16QAM

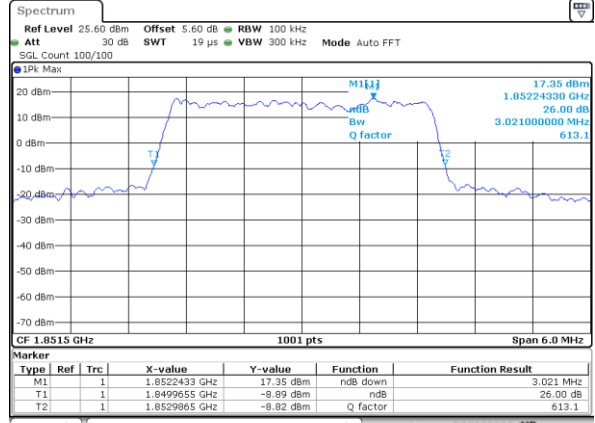

Date: 9 JUL 2020 22:15:00

Middle Channel / 3MHz / QPSK

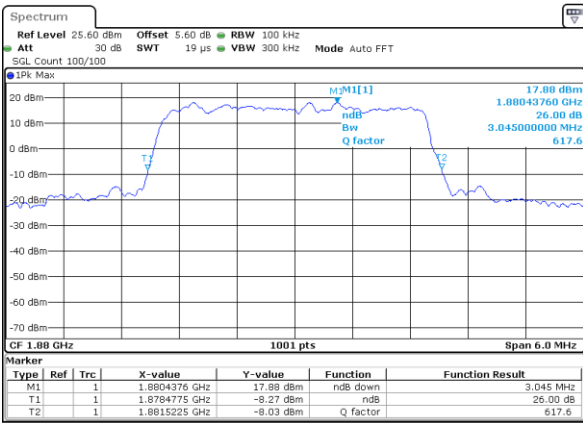

Date: 9 JUL 2020 22:21:55

Middle Channel / 3MHz / 16QAM

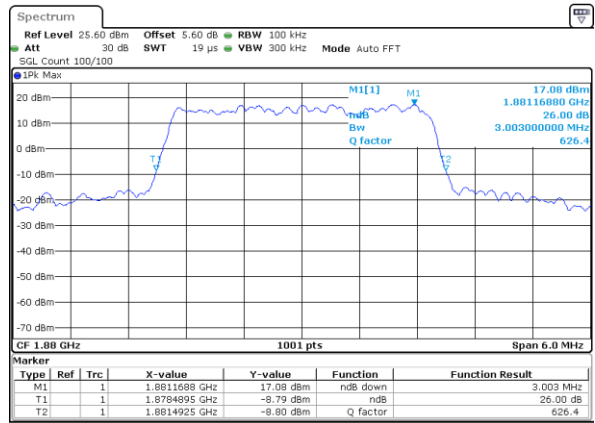

Date: 9 JUL 2020 22:22:05

Highest Channel / 3MHz / QPSK

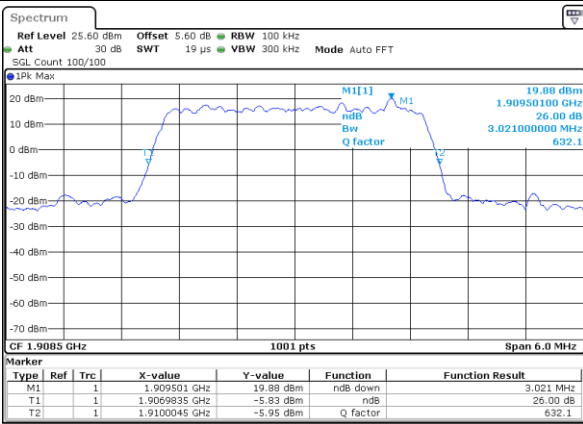

Date: 9 JUL 2020 22:24:28

Highest Channel / 3MHz / 16QAM

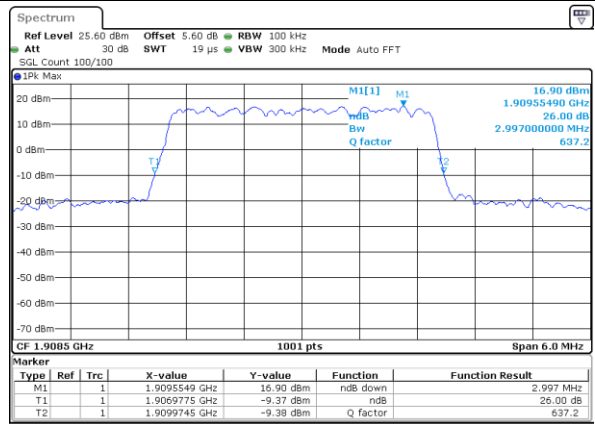

Date: 9 JUL 2020 22:24:38





LTE Band 2

Lowest Channel / 5MHz / QPSK

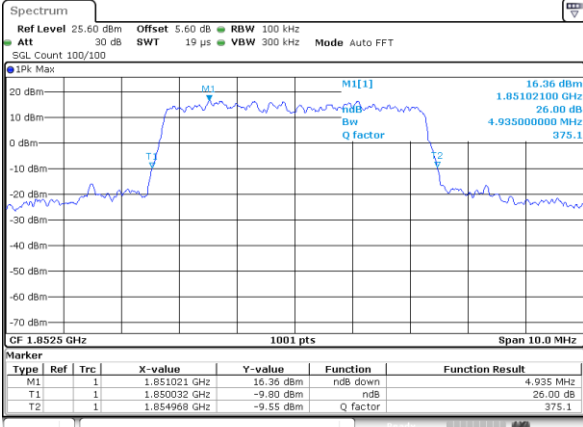

Date: 9 JUL 2020 22:31:32

Lowest Channel / 5MHz / 16QAM

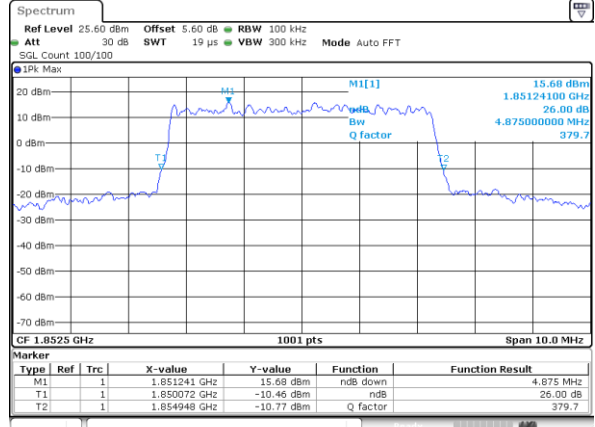

Date: 9 JUL 2020 22:31:42

Middle Channel / 5MHz / QPSK

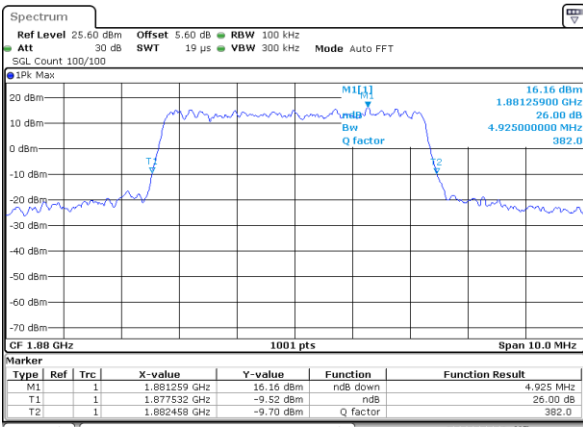

Date: 9 JUL 2020 22:38:35

Middle Channel / 5MHz / 16QAM

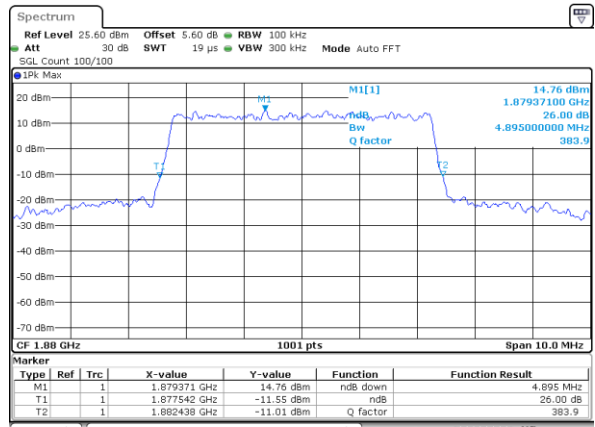

Date: 9 JUL 2020 22:38:45

Highest Channel / 5MHz / QPSK

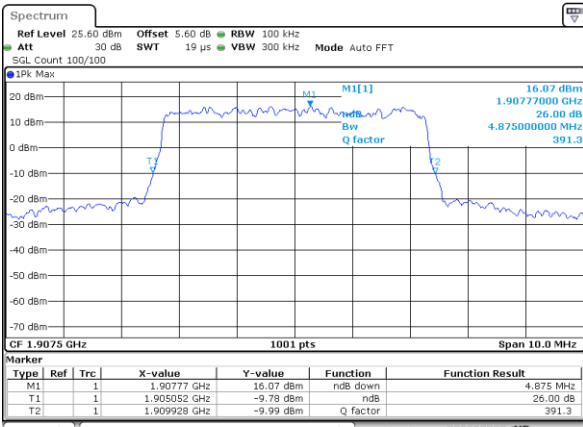

Date: 9 JUL 2020 22:41:08

Highest Channel / 5MHz / 16QAM

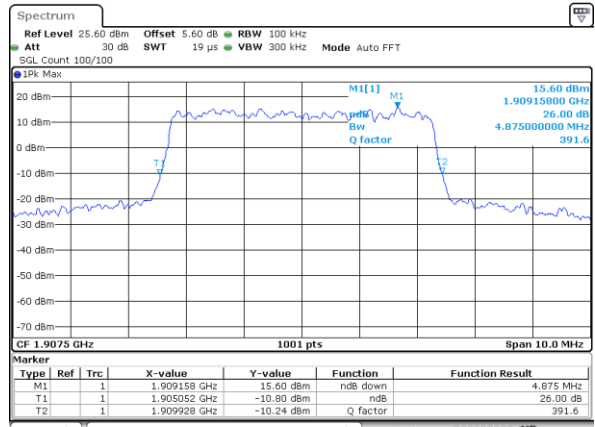

Date: 9 JUL 2020 22:41:18



LTE Band 2

Lowest Channel / 10MHz / QPSK

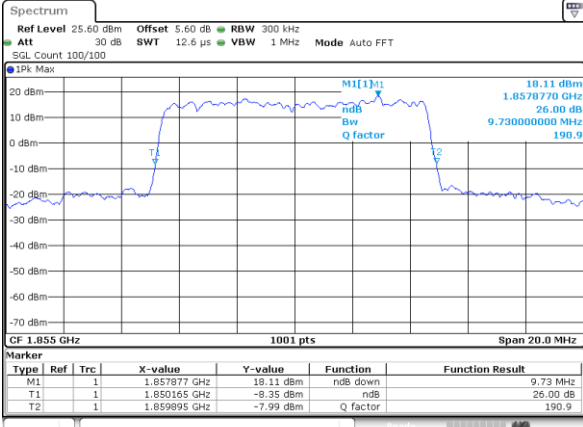

Date: 9\_JUL\_2020 22:48:12

Lowest Channel / 10MHz / 16QAM

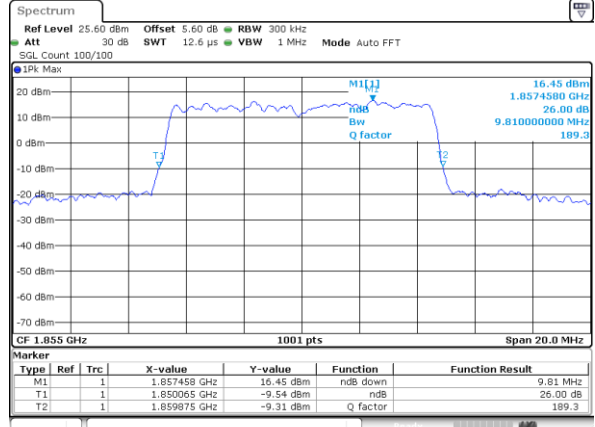

Date: 9\_JUL\_2020 22:48:22

Middle Channel / 10MHz / QPSK

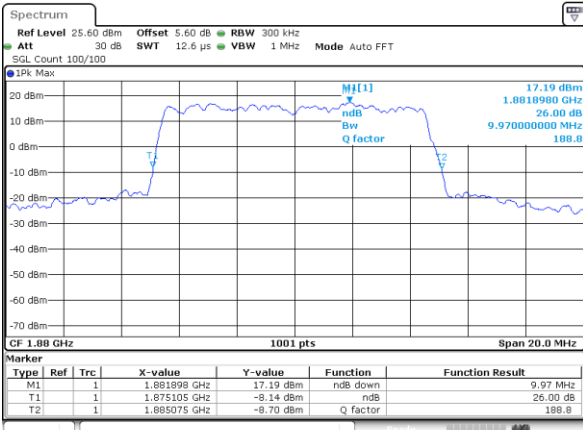

Date: 9\_JUL\_2020 22:57:48

Middle Channel / 10MHz / 16QAM

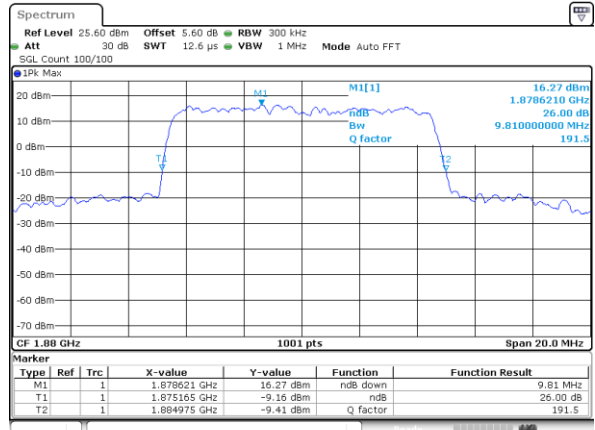

Date: 9\_JUL\_2020 22:57:58

Highest Channel / 10MHz / QPSK

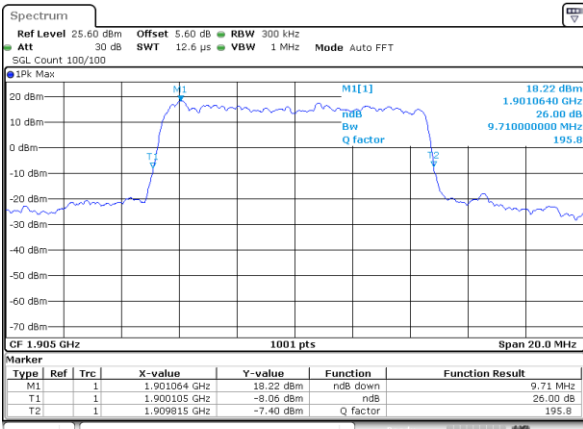

Date: 9\_JUL\_2020 23:00:21

Highest Channel / 10MHz / 16QAM

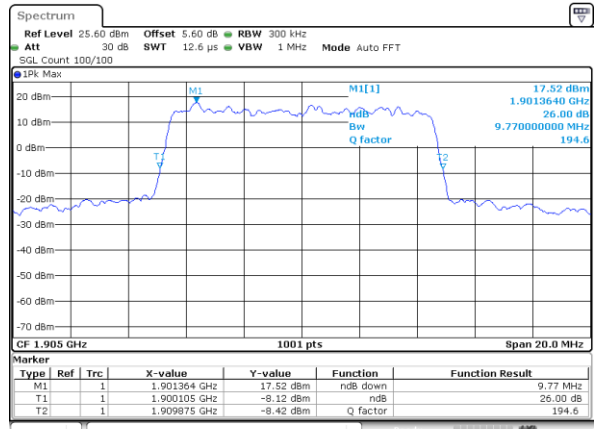

Date: 9\_JUL\_2020 23:00:31



LTE Band 2

Lowest Channel / 15MHz / QPSK

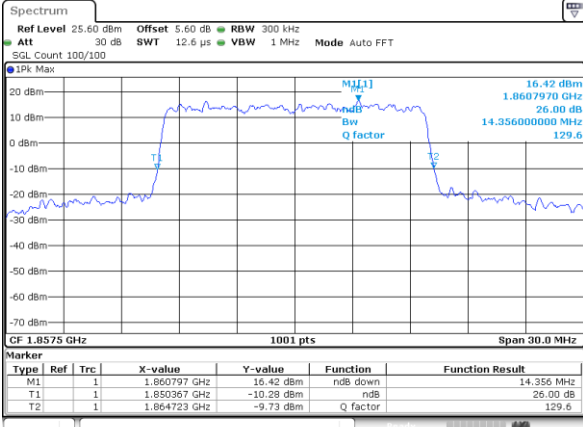

Date: 9\_JUL\_2020 23:07:24

Lowest Channel / 15MHz / 16QAM

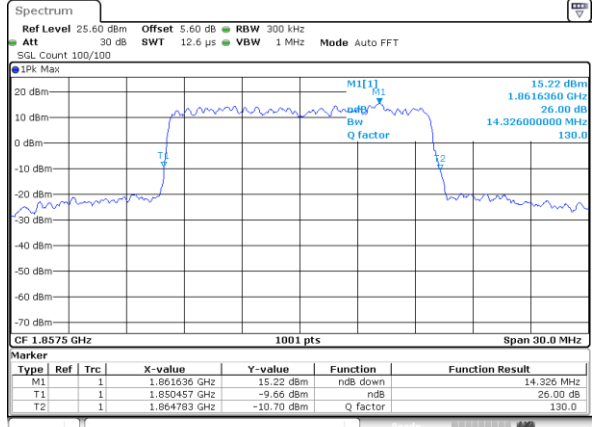

Date: 9\_JUL\_2020 23:07:34

Middle Channel / 15MHz / QPSK

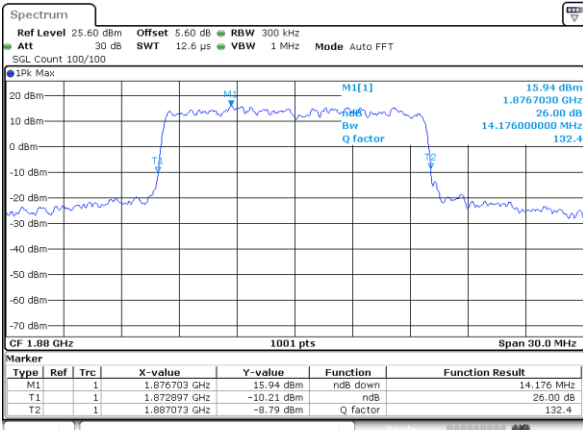

Date: 9\_JUL\_2020 23:14:28

Middle Channel / 15MHz / 16QAM

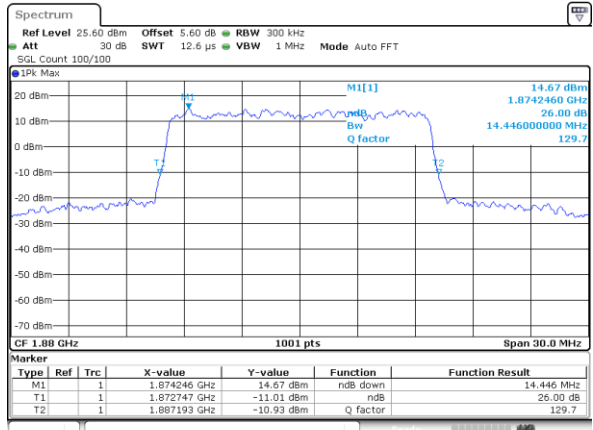

Date: 9\_JUL\_2020 23:14:38

Highest Channel / 15MHz / QPSK

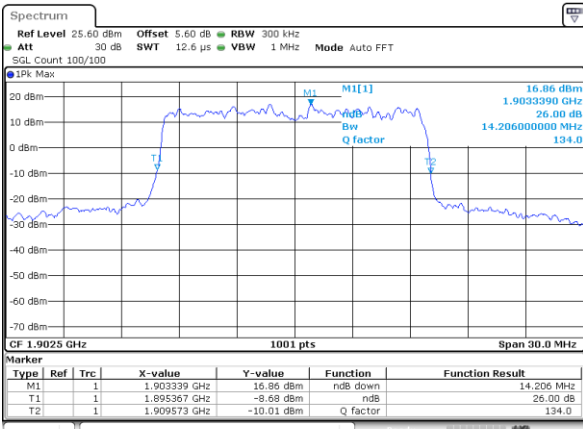

Date: 9\_JUL\_2020 23:17:01

Highest Channel / 15MHz / 16QAM

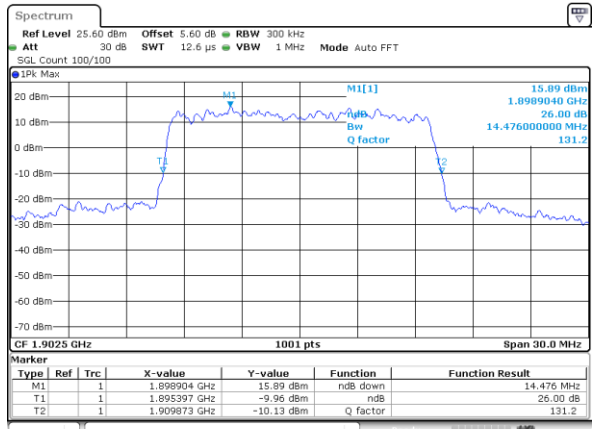

Date: 9\_JUL\_2020 23:17:11



LTE Band 2

Lowest Channel / 20MHz / QPSK

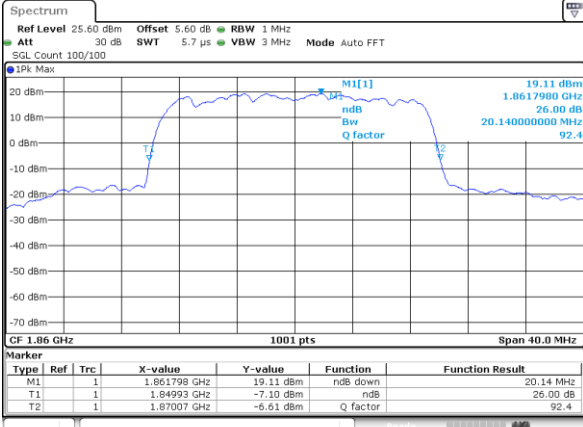

Date: 10\_JUL\_2020 00:13:11

Lowest Channel / 20MHz / 16QAM

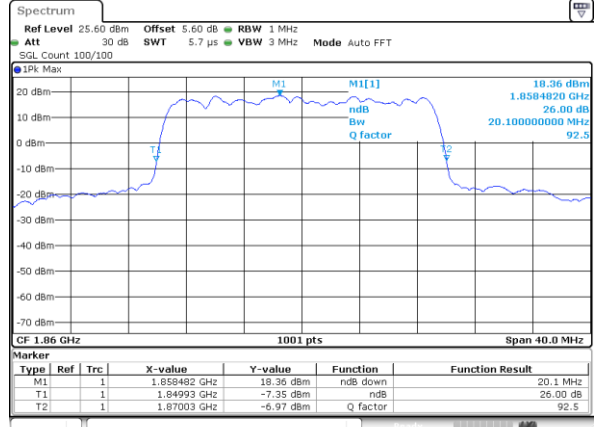

Date: 10\_JUL\_2020 00:13:12

Middle Channel / 20MHz / QPSK

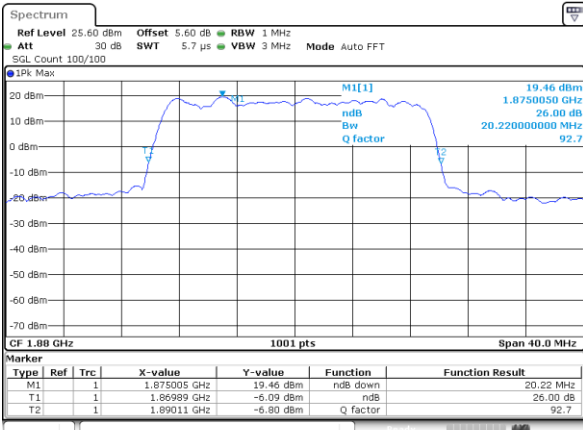

Date: 9\_JUL\_2020 23:42:59

Middle Channel / 20MHz / 16QAM

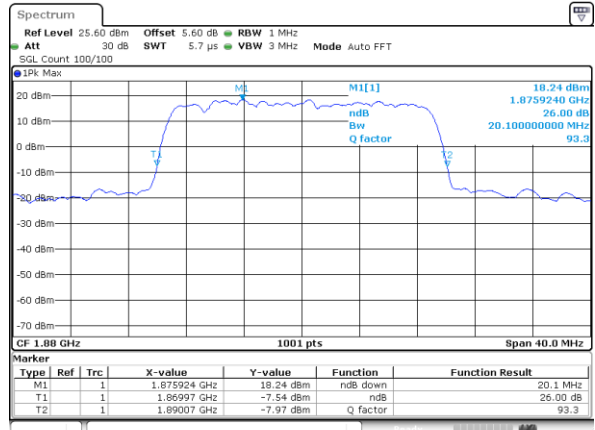

Date: 9\_JUL\_2020 23:43:09

Highest Channel / 20MHz / QPSK

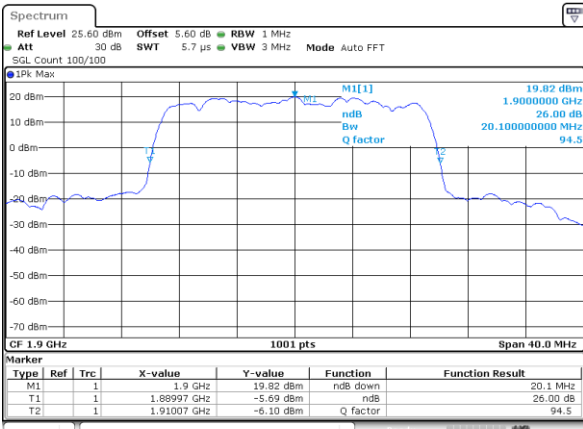

Date: 10\_JUL\_2020 00:45:19

Highest Channel / 20MHz / 16QAM

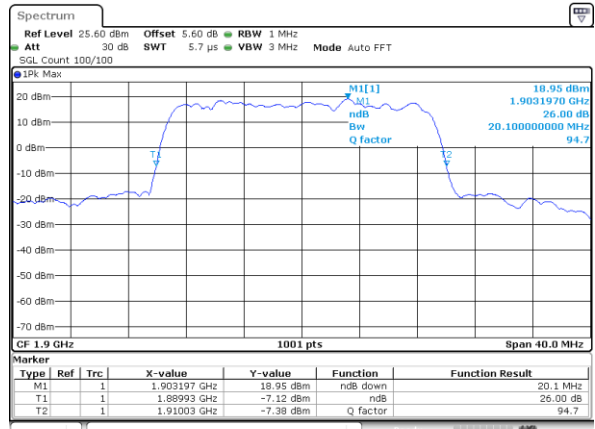

Date: 10\_JUL\_2020 00:46:03



LTE Band 2

Lowest Channel / 1.4MHz / 64QAM

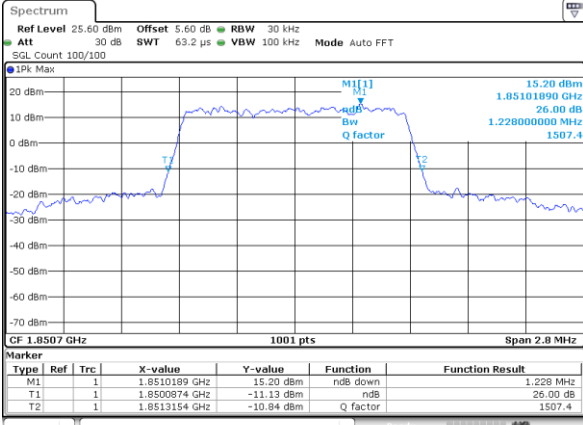

Date: 10\_JUL\_2020 01:23:16

Lowest Channel / 3MHz / 64QAM

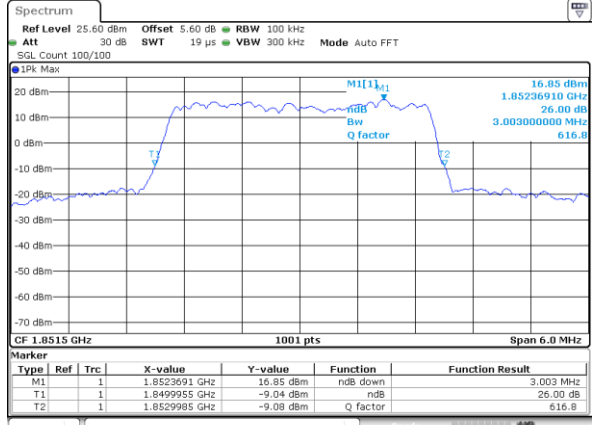

Date: 10\_JUL\_2020 01:24:06

Middle Channel / 1.4MHz / 64QAM

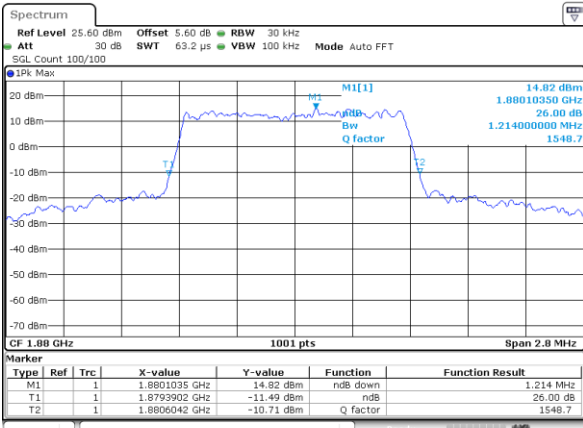

Date: 10\_JUL\_2020 01:23:46

Middle Channel / 3MHz / 64QAM

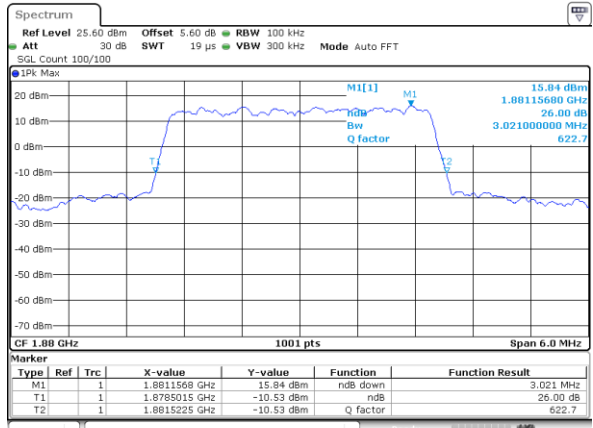

Date: 10\_JUL\_2020 01:24:16

Highest Channel / 1.4MHz / 64QAM

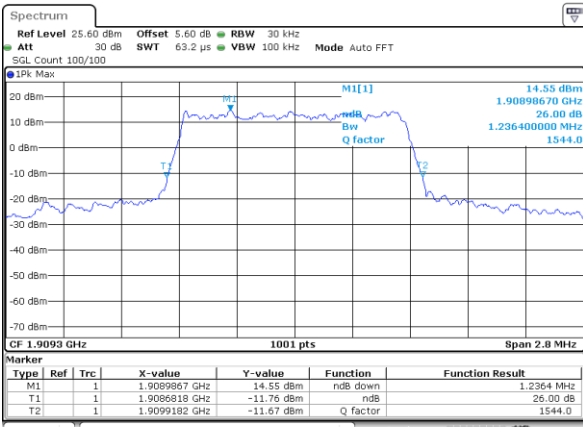

Date: 10\_JUL\_2020 01:23:56

Highest Channel / 3MHz / 64QAM

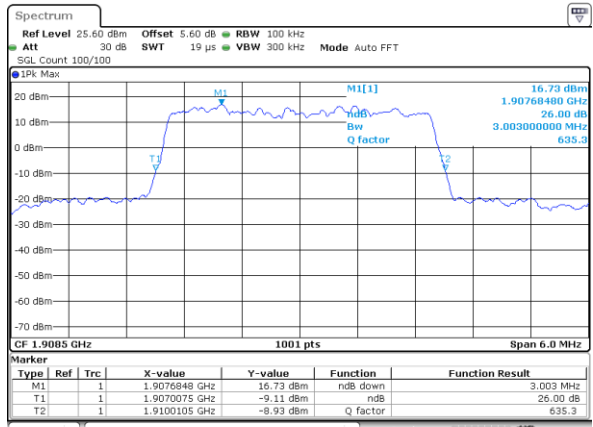

Date: 10\_JUL\_2020 01:24:26



LTE Band 2

Lowest Channel / 5MHz / 64QAM

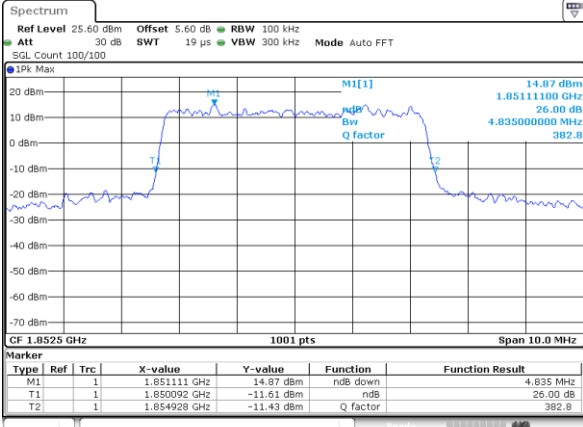

Date: 10\_JUL\_2020 01:24:36

Lowest Channel / 10MHz / 64QAM

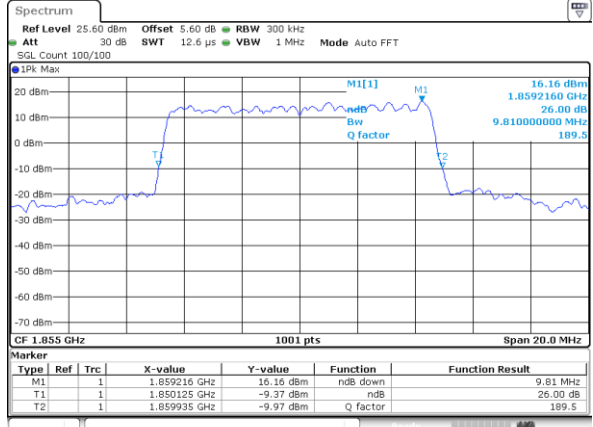

Date: 10\_JUL\_2020 01:25:06

Middle Channel / 5MHz / 64QAM

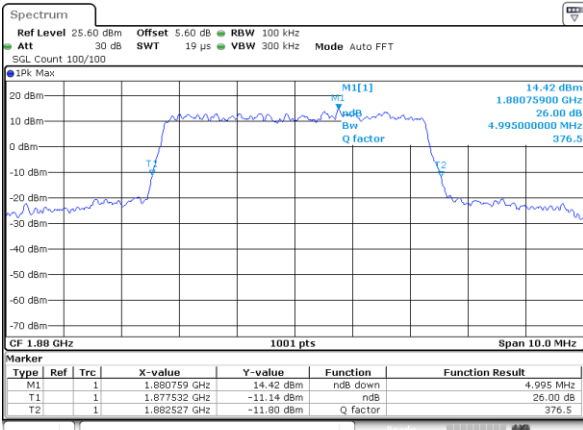

Date: 10\_JUL\_2020 01:24:46

Middle Channel / 10MHz / 64QAM

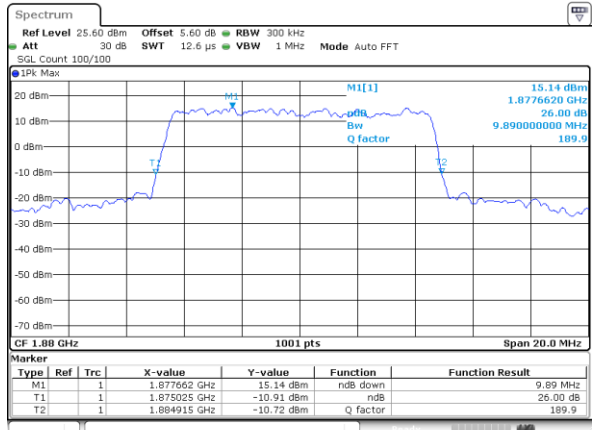

Date: 10\_JUL\_2020 01:25:16

Highest Channel / 5MHz / 64QAM

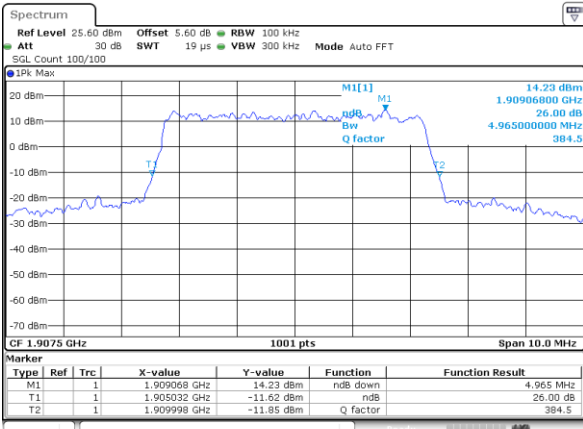

Date: 10\_JUL\_2020 01:24:56

Highest Channel / 10MHz / 64QAM

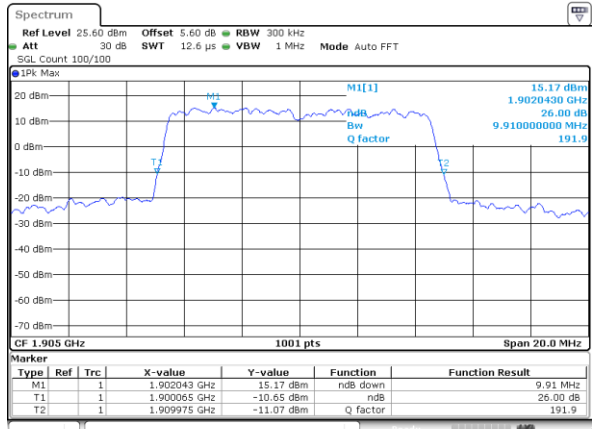

Date: 10\_JUL\_2020 01:25:26



LTE Band 2

Lowest Channel / 15MHz / 64QAM

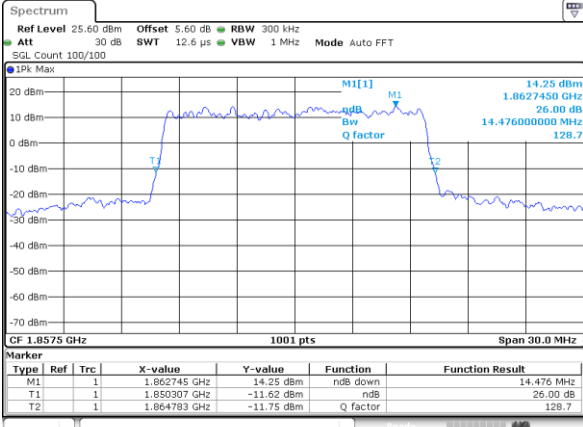

Date: 10\_JUL\_2020 01:25:36

Lowest Channel / 20MHz / 64QAM

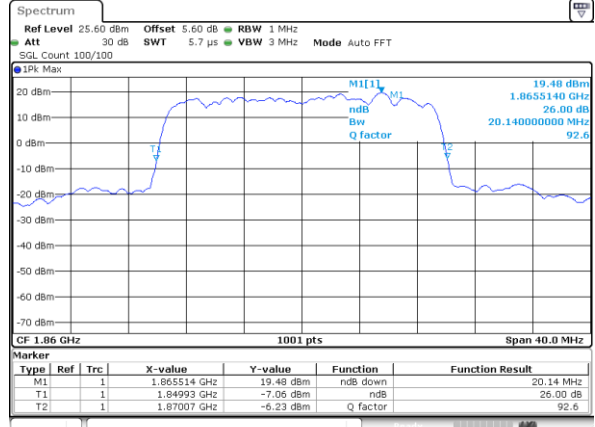

Date: 10\_JUL\_2020 00:15:04

Middle Channel / 15MHz / 64QAM

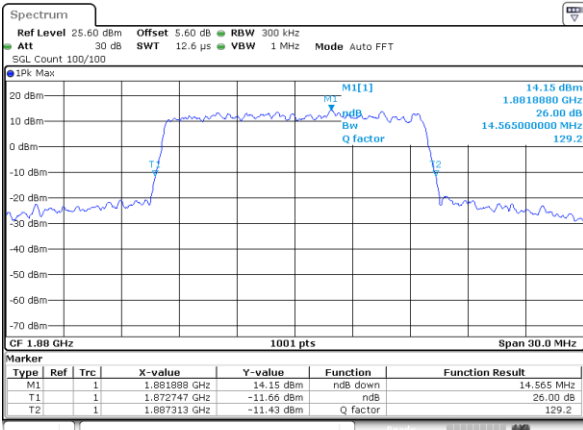

Date: 10\_JUL\_2020 01:25:46

Middle Channel / 20MHz / 64QAM

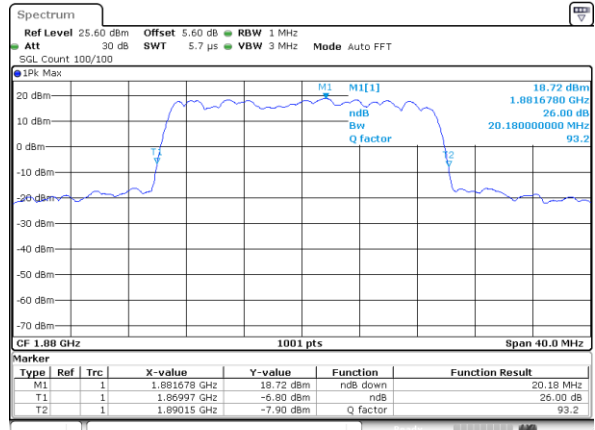

Date: 10\_JUL\_2020 00:14:32

Highest Channel / 15MHz / 64QAM

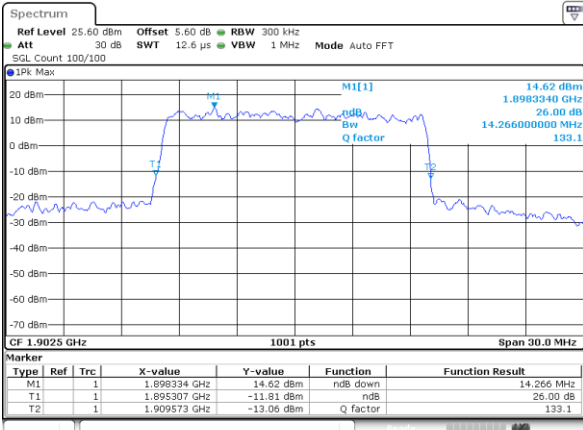

Date: 10\_JUL\_2020 01:25:56

Highest Channel / 20MHz / 64QAM

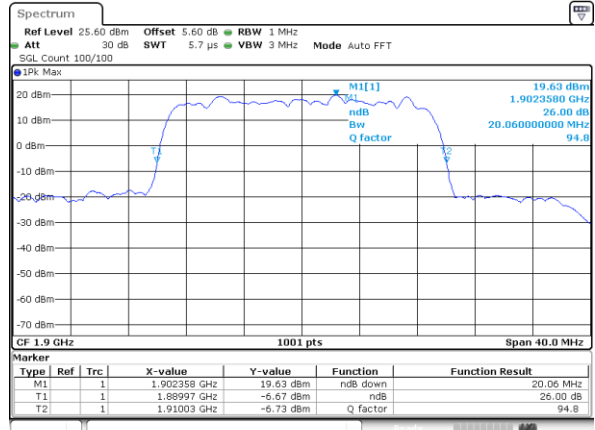

Date: 10\_JUL\_2020 00:14:40



**Occupied Bandwidth**

Mode	LTE Band 2 : 99%OBW(MHz)											
BW	1.4MHz		3MHz		5MHz		10MHz		15MHz		20MHz	
Mod.	QPSK	16QAM	QPSK	16QAM	QPSK	16QAM	QPSK	16QAM	QPSK	16QAM	QPSK	16QAM
Lowest CH	1.09	1.09	2.72	2.74	4.50	4.49	9.01	9.03	13.40	13.43	18.26	18.42
Middle CH	1.10	1.10	2.73	2.71	4.52	4.47	9.09	9.07	13.46	13.46	18.34	18.54
Highest CH	1.08	1.09	2.72	2.72	4.48	4.49	9.01	9.05	13.52	13.49	18.38	18.42
Mode	LTE Band 2 : 99%OBW(MHz)											
BW	1.4MHz		3MHz		5MHz		10MHz		15MHz		20MHz	
Mod.	64QAM		64QAM		64QAM		64QAM		64QAM		64QAM	
Lowest CH	1.10	-	2.72	-	4.50	-	9.03	-	13.43	-	18.30	-
Middle CH	1.09	-	2.73	-	4.54	-	9.07	-	13.46	-	18.26	-
Highest CH	1.08	-	2.72	-	4.49	-	9.03	-	13.49	-	18.26	-





LTE Band 2

Lowest Channel / 1.4MHz / QPSK

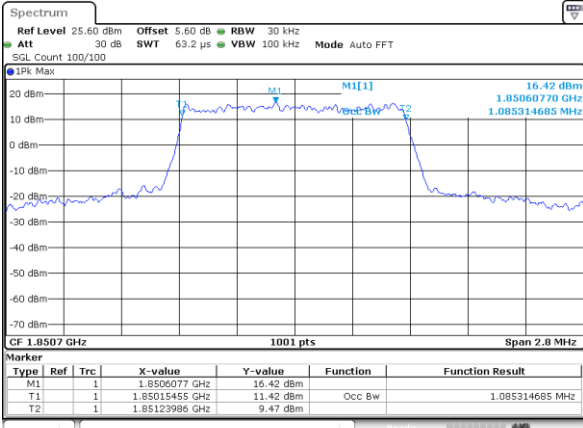

Date: 9 JUL 2020 21:57:23

Lowest Channel / 1.4MHz / 16QAM

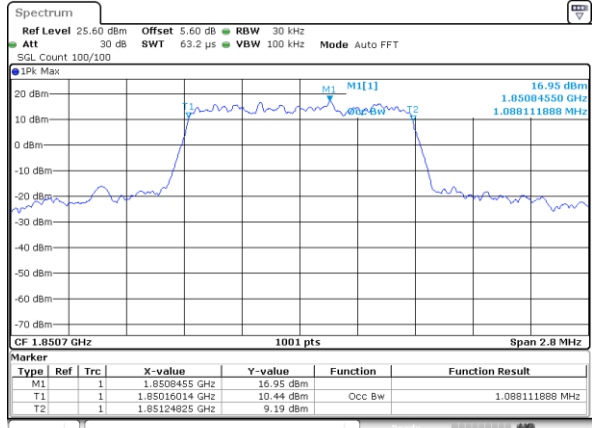

Date: 9 JUL 2020 21:57:34

Middle Channel / 1.4MHz / QPSK

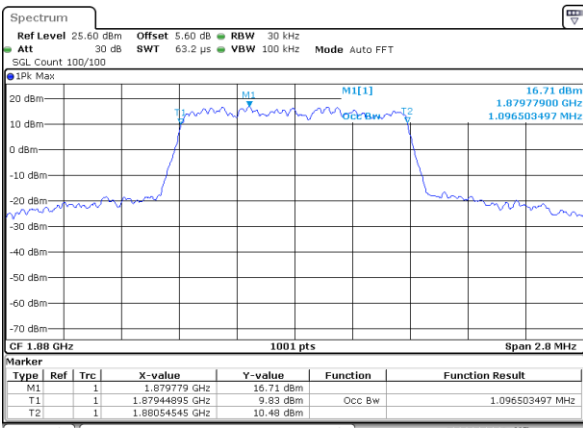

Date: 9 JUL 2020 22:04:52

Middle Channel / 1.4MHz / 16QAM

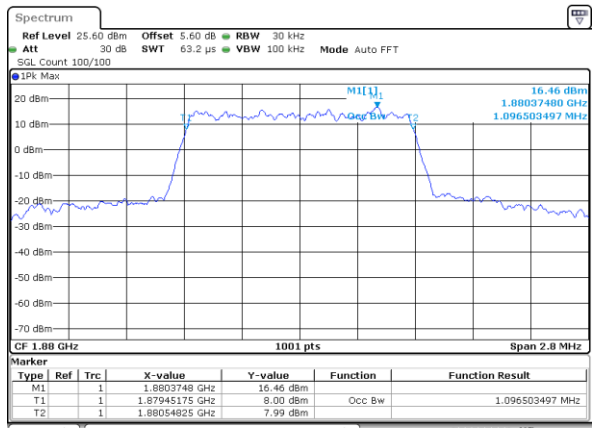

Date: 9 JUL 2020 22:05:02

Highest Channel / 1.4MHz / QPSK

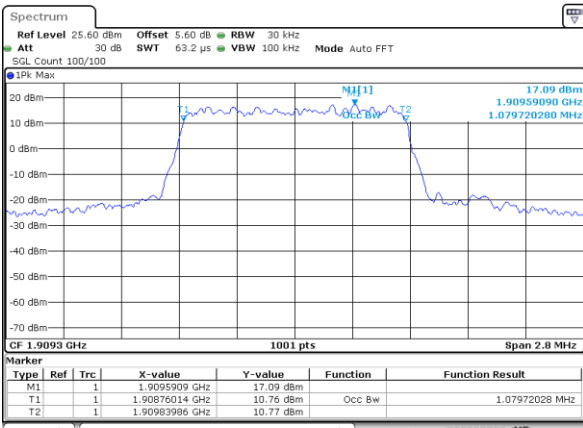

Date: 9 JUL 2020 22:07:25

Highest Channel / 1.4MHz / 16QAM

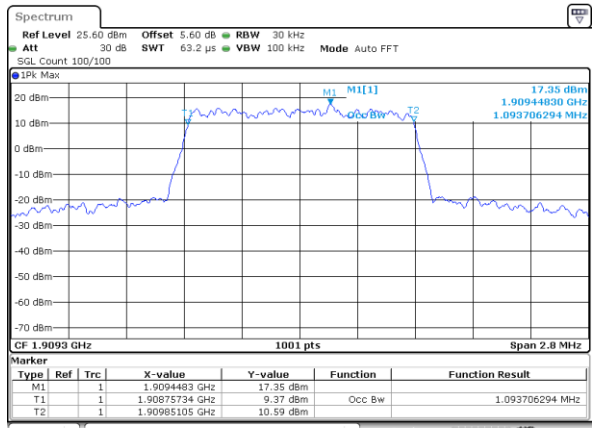

Date: 9 JUL 2020 22:07:35



LTE Band 2

Lowest Channel / 3MHz / QPSK

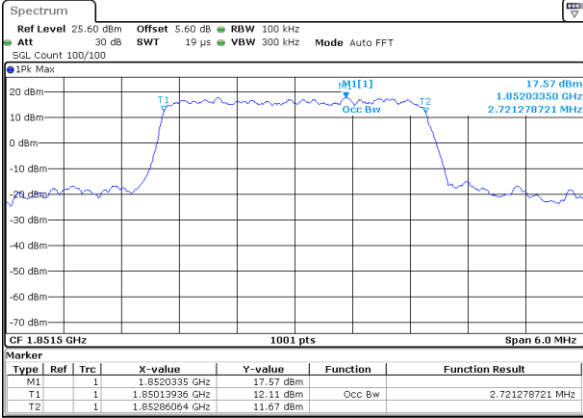

Date: 9 JUL 2020 22:14:30

Lowest Channel / 3MHz / 16QAM

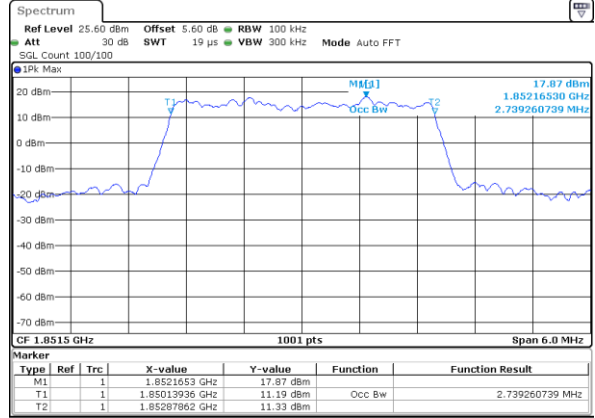

Date: 9 JUL 2020 22:14:40

Middle Channel / 3MHz / QPSK

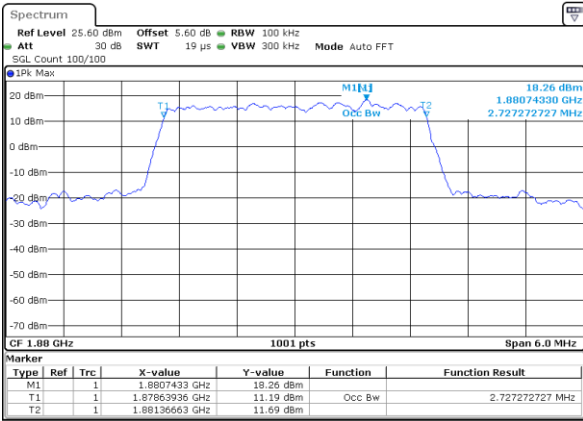

Date: 9 JUL 2020 22:21:35

Middle Channel / 3MHz / 16QAM

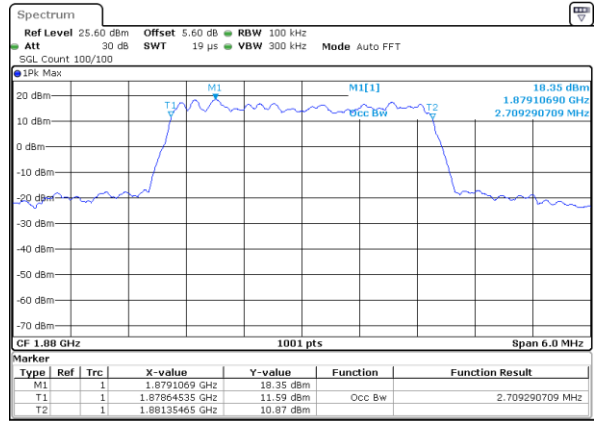

Date: 9 JUL 2020 22:21:45

Highest Channel / 3MHz / QPSK

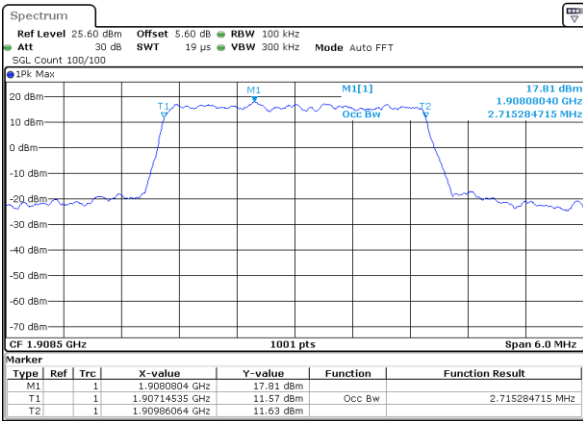

Date: 9 JUL 2020 22:24:08

Highest Channel / 3MHz / 16QAM

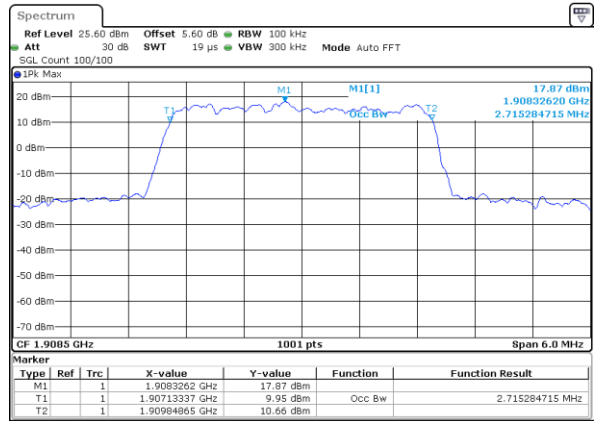

Date: 9 JUL 2020 22:24:18



LTE Band 2

Lowest Channel / 5MHz / QPSK

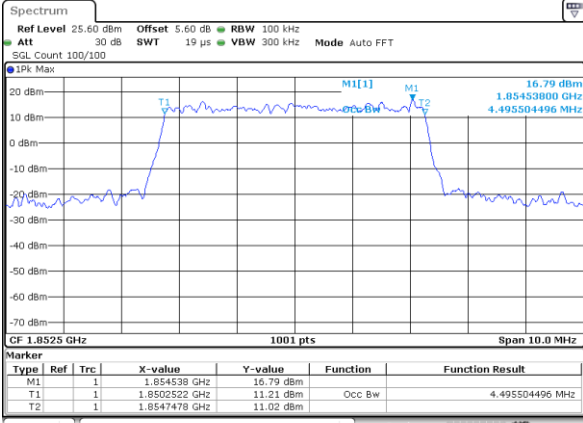

Date: 9 JUL 2020 22:31:12

Lowest Channel / 5MHz / 16QAM

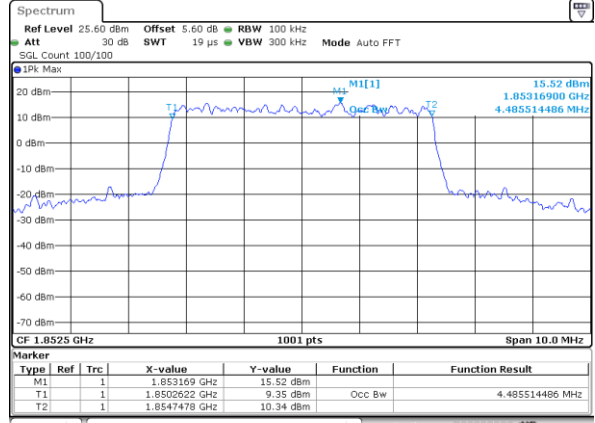

Date: 9 JUL 2020 22:31:22

Middle Channel / 5MHz / QPSK

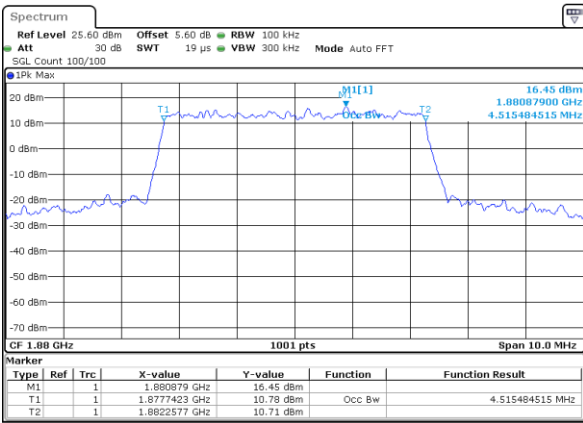

Date: 9 JUL 2020 22:38:15

Middle Channel / 5MHz / 16QAM

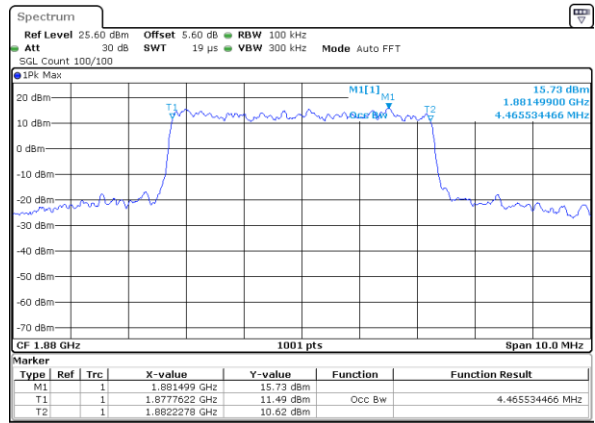

Date: 9 JUL 2020 22:38:25

Highest Channel / 5MHz / QPSK

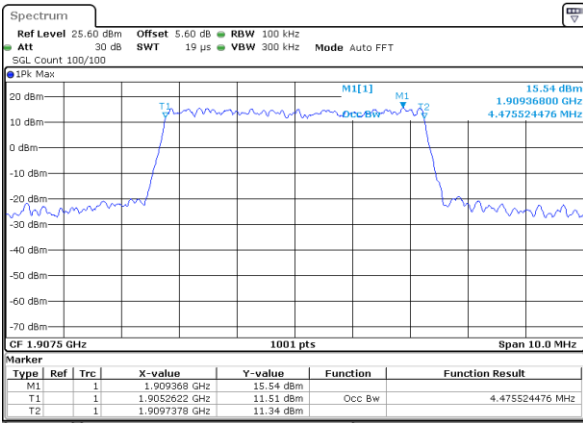

Date: 9 JUL 2020 22:40:48

Highest Channel / 5MHz / 16QAM

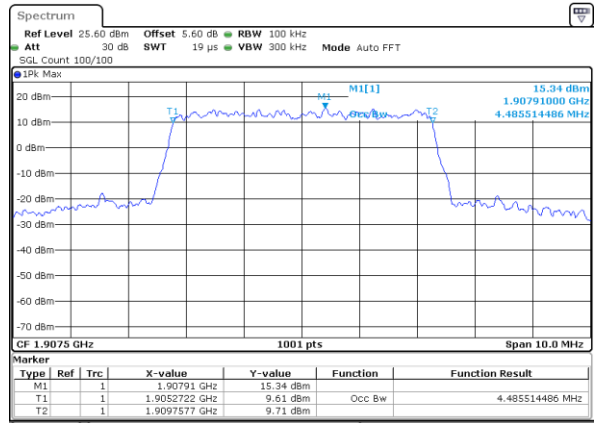

Date: 9 JUL 2020 22:40:58



LTE Band 2

Lowest Channel / 10MHz / QPSK

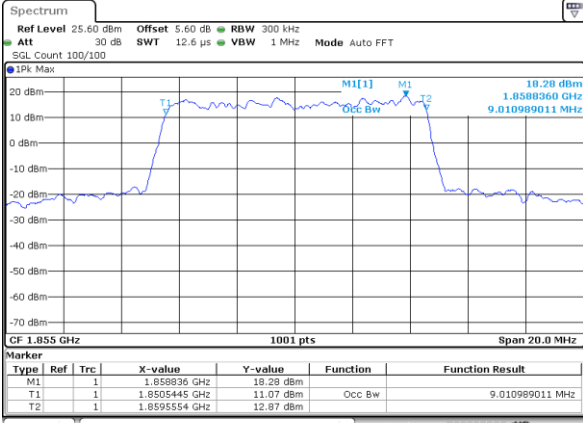

Date: 9 JUL 2020 22:47:52

Lowest Channel / 10MHz / 16QAM

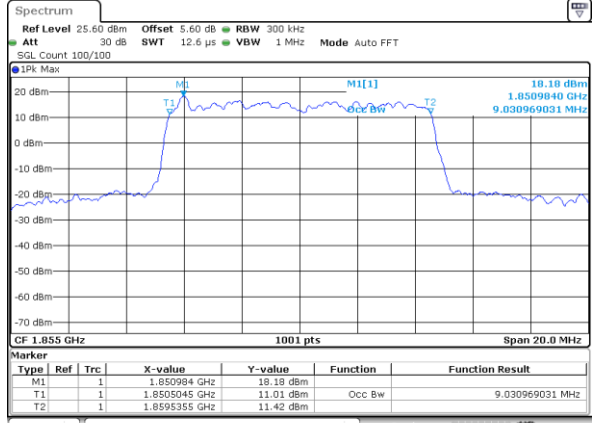

Date: 9 JUL 2020 22:48:02

Middle Channel / 10MHz / QPSK

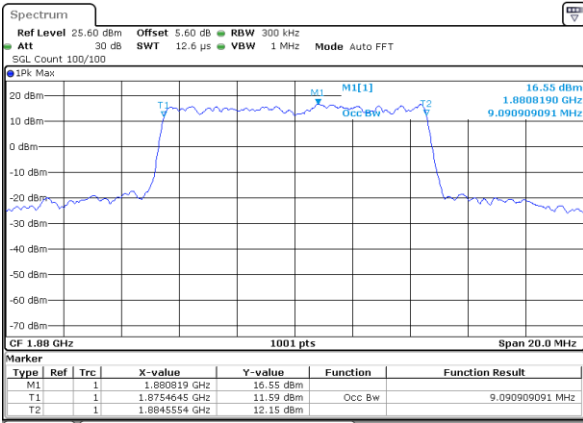

Date: 9 JUL 2020 22:57:28

Middle Channel / 10MHz / 16QAM

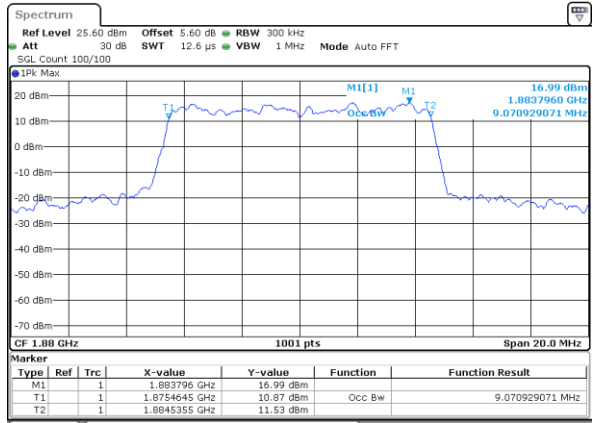

Date: 9 JUL 2020 22:57:38

Highest Channel / 10MHz / QPSK

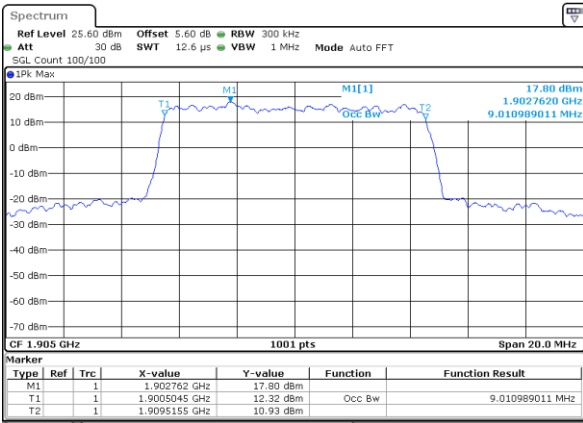

Date: 9 JUL 2020 23:00:01

Highest Channel / 10MHz / 16QAM

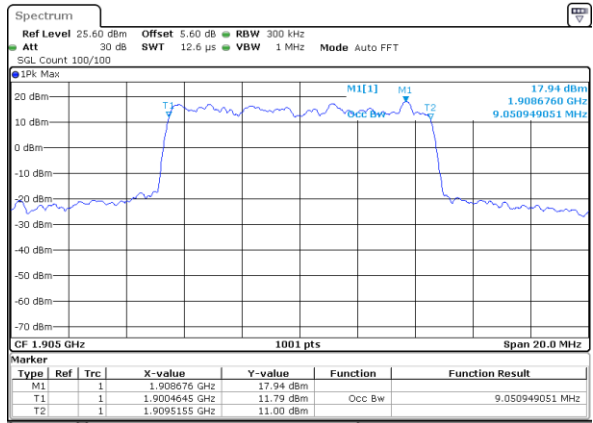

Date: 9 JUL 2020 23:00:11



LTE Band 2

Lowest Channel / 15MHz / QPSK

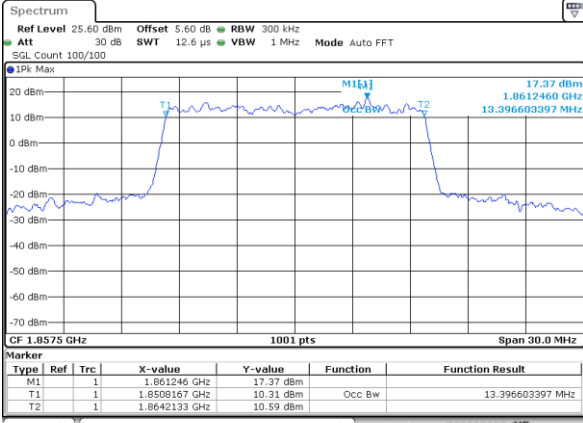

Date: 9 JUL 2020 23:07:04

Lowest Channel / 15MHz / 16QAM

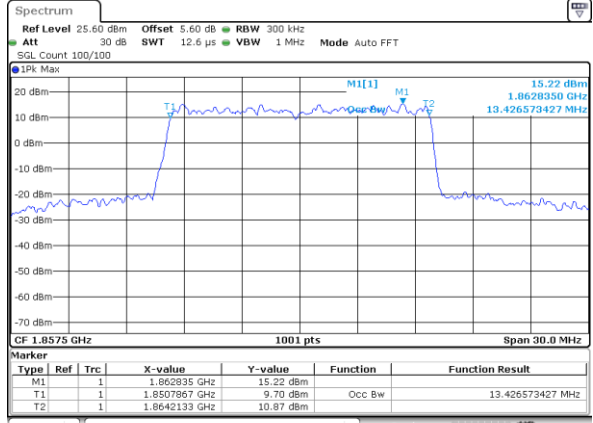

Date: 9 JUL 2020 23:07:14

Middle Channel / 15MHz / QPSK

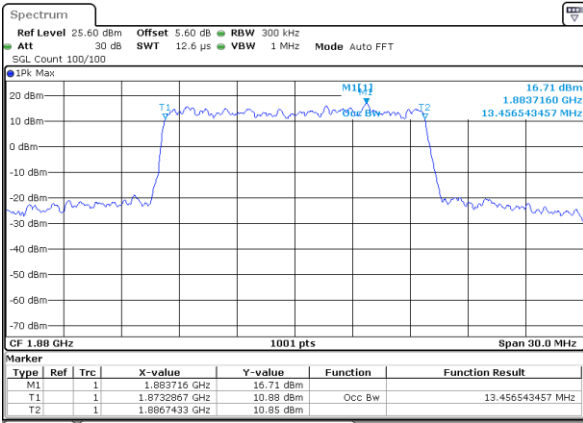

Date: 9 JUL 2020 23:14:08

Middle Channel / 15MHz / 16QAM

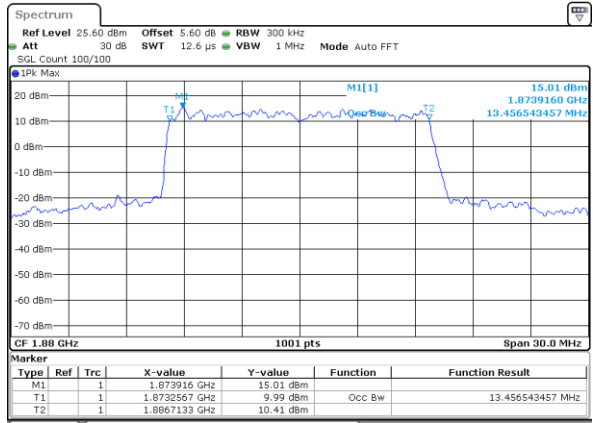

Date: 9 JUL 2020 23:14:18

Highest Channel / 15MHz / QPSK

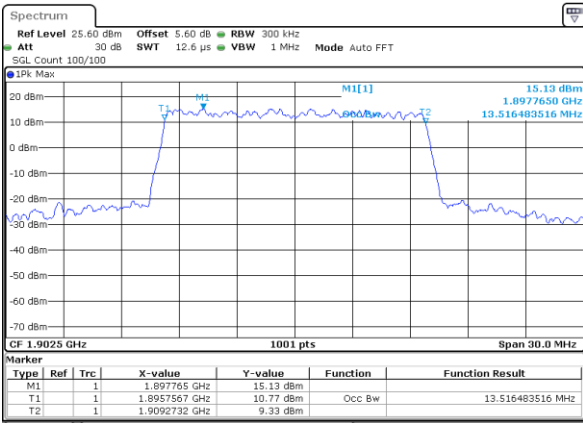

Date: 9 JUL 2020 23:16:41

Highest Channel / 15MHz / 16QAM

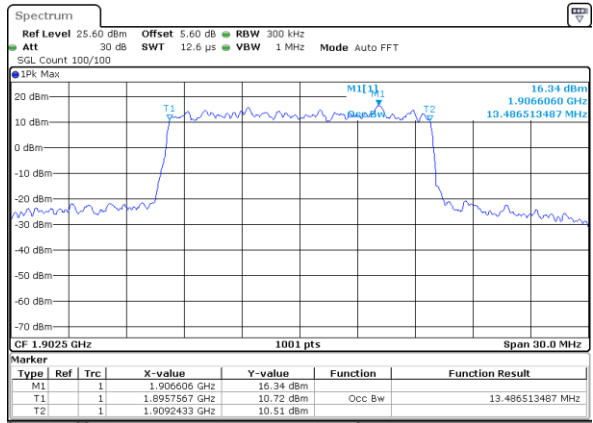

Date: 9 JUL 2020 23:16:51



LTE Band 2

Lowest Channel / 20MHz / QPSK

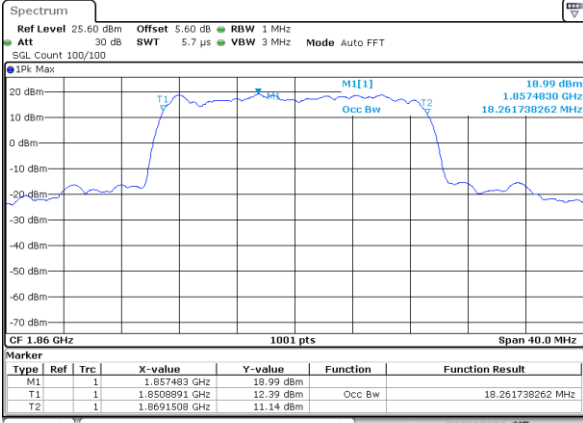

Date: 10\_JUL\_2020 00:35:51

Lowest Channel / 20MHz / 16QAM

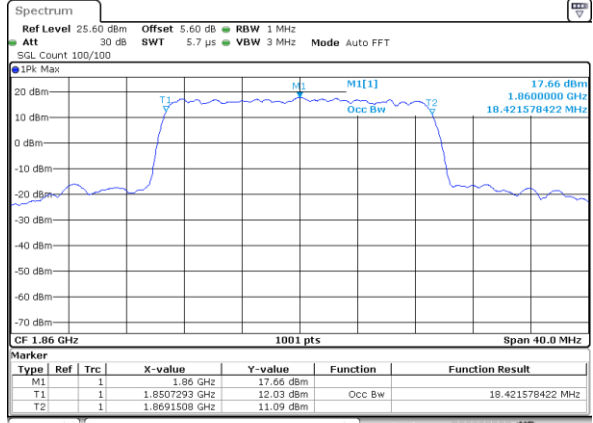

Date: 10\_JUL\_2020 00:36:01

Middle Channel / 20MHz / QPSK

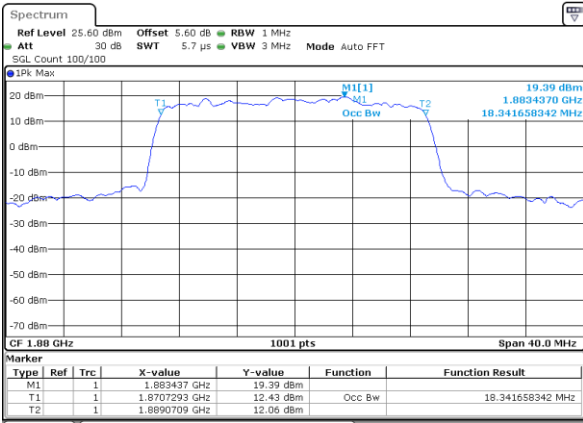

Date: 10\_JUL\_2020 00:42:05

Middle Channel / 20MHz / 16QAM

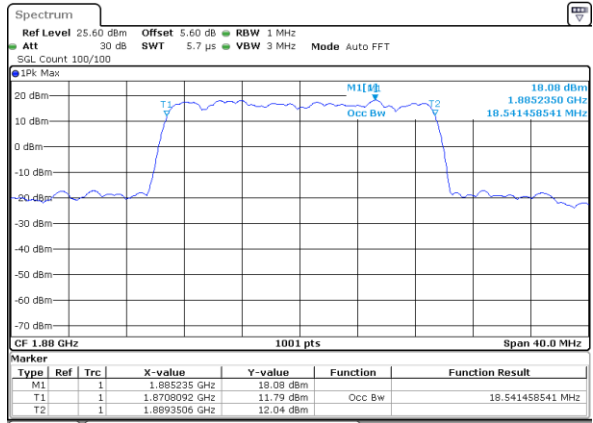

Date: 10\_JUL\_2020 00:42:52

Highest Channel / 20MHz / QPSK

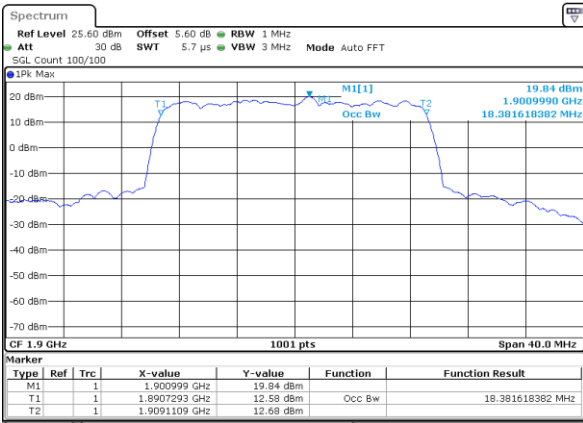

Date: 10\_JUL\_2020 00:45:08

Highest Channel / 20MHz / 16QAM

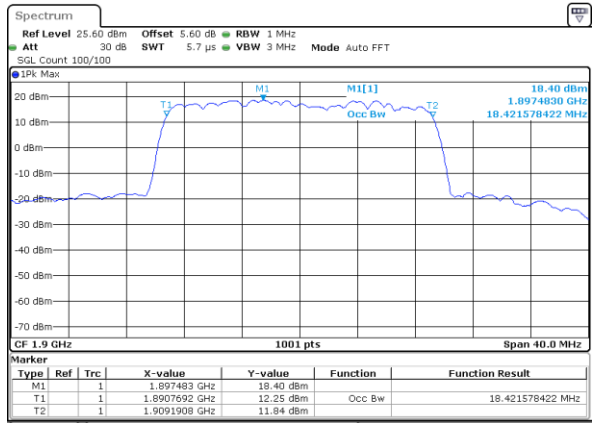

Date: 10\_JUL\_2020 00:45:56



LTE Band 2

Lowest Channel / 1.4MHz / 64QAM

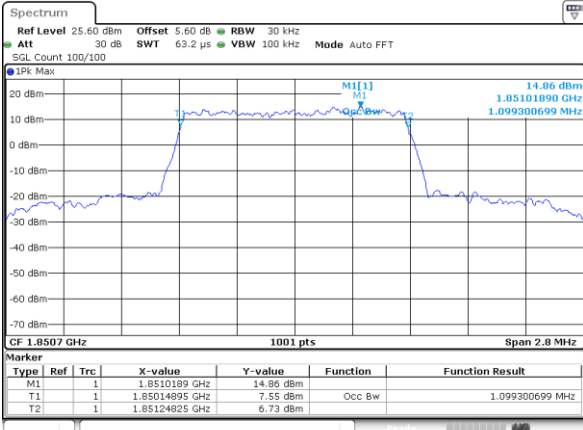

Date: 10\_JUL\_2020 01:20:36

Lowest Channel / 3MHz / 64QAM

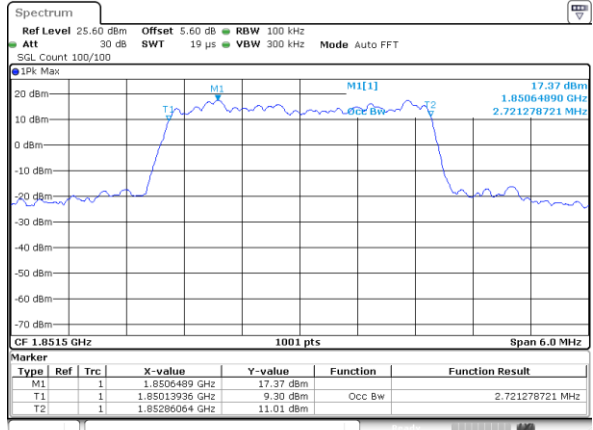

Date: 10\_JUL\_2020 01:21:06

Middle Channel / 1.4MHz / 64QAM

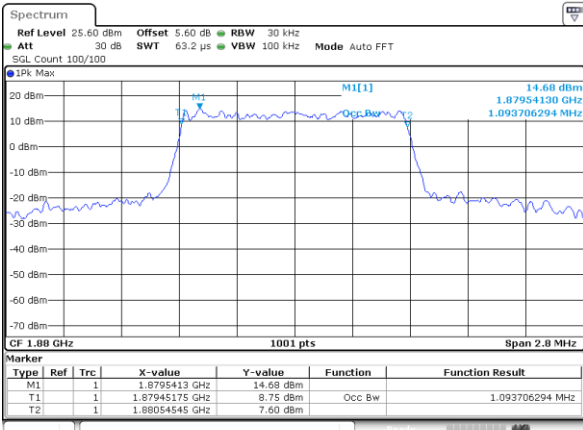

Date: 10\_JUL\_2020 01:20:46

Middle Channel / 3MHz / 64QAM

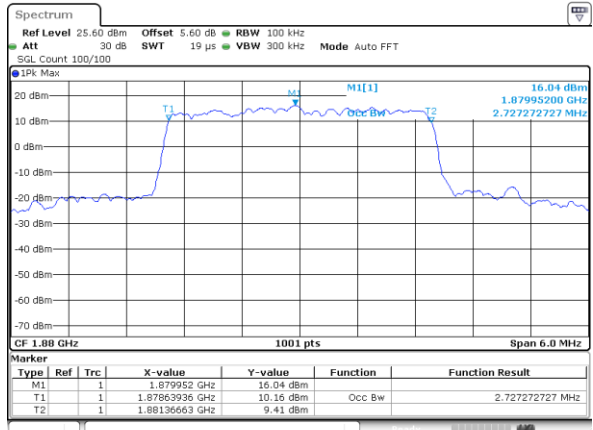

Date: 10\_JUL\_2020 01:21:16

Highest Channel / 1.4MHz / 64QAM

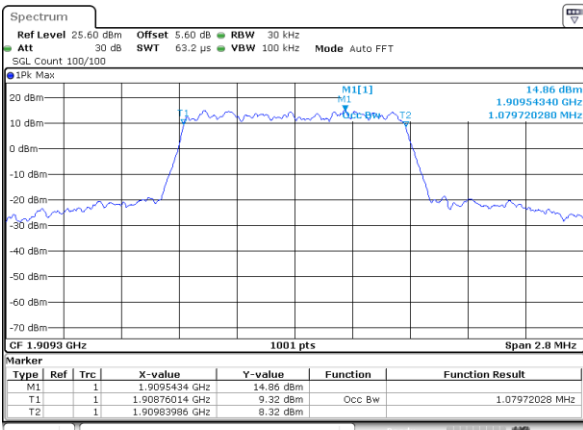

Date: 10\_JUL\_2020 01:20:56

Highest Channel / 3MHz / 64QAM

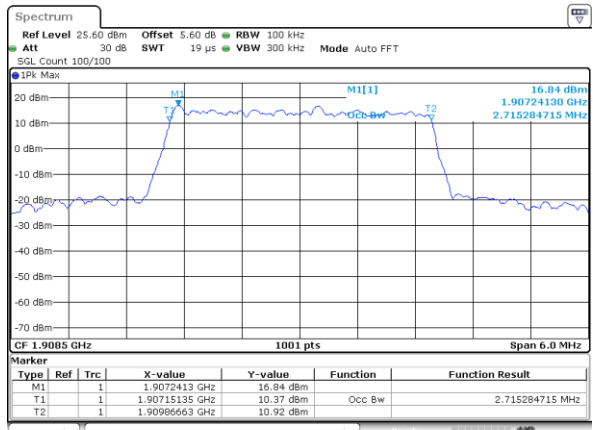

Date: 10\_JUL\_2020 01:21:26