



FCC RF Test Report

APPLICANT : Motorola Mobility LLC
EQUIPMENT : Mobile Cellular Phone
BRAND NAME : Motorola
MODEL NAME : XT2083-1
FCC ID : IHDT56ZD5
STANDARD : FCC Part 15 Subpart C §15.247
CLASSIFICATION : (DTS) Digital Transmission System

The product was received on Apr. 21, 2020 and testing was completed on Jun. 01, 2020. We, Sporton International (Kunshan) Inc., would like to declare that the tested sample has been evaluated in accordance with the test procedures and has been in compliance with the applicable technical standards.

The test results in this report apply exclusively to the tested model / sample. Without written approval of Sporton International (Kunshan) Inc., the test report shall not be reproduced except in full.

Jason Jia

Reviewed by: Jason Jia / Supervisor

James Huang

Approved by: James Huang / Manager



Sporton International (Kunshan) Inc.

**No. 1098, Pengxi North Road, Kunshan Economic Development Zone Jiangsu Province 215300
People's Republic of China**



TABLE OF CONTENTS

REVISION HISTORY..... 3

SUMMARY OF TEST RESULT 4

1 GENERAL DESCRIPTION..... 5

 1.1 Applicant 5

 1.2 Manufacturer 5

 1.3 Product Feature of Equipment Under Test..... 5

 1.4 Product Specification of Equipment Under Test..... 5

 1.5 Modification of EUT 6

 1.6 Testing Location 6

 1.7 Test Software 6

 1.8 Applicable Standards..... 6

 1.9 Specification of Accessory 7

2 TEST CONFIGURATION OF EQUIPMENT UNDER TEST..... 8

 2.1 Carrier Frequency Channel 8

 2.2 Test Mode 9

 2.3 Connection Diagram of Test System 10

 2.4 Support Unit used in test configuration and system 11

 2.5 EUT Operation Test Setup 11

 2.6 Measurement Results Explanation Example..... 11

3 TEST RESULT 12

 3.1 6dB Bandwidth Measurement 12

 3.2 Output Power Measurement..... 15

 3.3 Power Spectral Density Measurement 16

 3.4 Conducted Band Edges and Spurious Emission Measurement 21

 3.5 Radiated Band Edges and Spurious Emission Measurement 26

 3.6 AC Conducted Emission Measurement..... 30

 3.7 Antenna Requirements 32

4 LIST OF MEASURING EQUIPMENT..... 33

5 UNCERTAINTY OF EVALUATION..... 34

APPENDIX A. CONDUCTED TEST RESULTS

APPENDIX B. AC CONDUCTED EMISSION TEST RESULT

APPENDIX C. RADIATED SPURIOUS EMISSION

APPENDIX D. DUTY CYCLE PLOTS

APPENDIX E. SETUP PHOTOGRAPHS



REVISION HISTORY

| REPORT NO. | VERSION | DESCRIPTION | ISSUED DATE |
|------------|---------|-------------------------|---------------|
| FR042102B | Rev. 01 | Initial issue of report | Jun. 19, 2020 |
| | | | |
| | | | |
| | | | |
| | | | |
| | | | |
| | | | |
| | | | |
| | | | |
| | | | |
| | | | |
| | | | |
| | | | |
| | | | |
| | | | |
| | | | |



SUMMARY OF TEST RESULT

| Report Section | FCC Rule | Description | Limit | Result | Remark |
|----------------|--------------------|--|-----------------------|--------------|---|
| 3.1 | 15.247(a)(2) | 6dB Bandwidth | ≥ 0.5MHz | Pass | - |
| - | - | 99% Bandwidth | - | Not Required | - |
| 3.2 | 15.247(b)(3) | Peak Output Power | ≤ 30dBm | Pass | - |
| 3.3 | 15.247(e) | Power Spectral Density | ≤ 8dBm/3kHz | Pass | - |
| 3.4 | 15.247(d) | Conducted Band Edges and Spurious Emission | ≤ 20dBc | Pass | - |
| 3.5 | 15.247(d) | Radiated Band Edges and Spurious Emission | 15.209(a) & 15.247(d) | Pass | Under limit 5.91 dB at 2483.500 MHz |
| 3.6 | 15.207 | AC Conducted Emission | 15.207(a) | Pass | Under limit 8.61 dB at 0.200 MHz |
| 3.7 | 15.203 & 15.247(b) | Antenna Requirement | N/A | Pass | - |

Remark: Not required means after assessing, test items are not necessary to carry out.

| |
|--|
| Declaration of Conformity: |
| The test results with all measurement uncertainty excluded are presented in accordance with the regulation limits or requirements declared by manufacturers. |
| Comments and Explanations: |
| The declared of product specification for EUT presented in the report are provided by the manufacturer, and the manufacturer takes all the responsibilities for the accuracy of product specification. |



1 General Description

1.1 Applicant

Motorola Mobility LLC
222 W,Merchandise Mart Plaza,Chicago,IL60654 USA

1.2 Manufacturer

Motorola Mobility LLC
222 W,Merchandise Mart Plaza,Chicago,IL60654 USA

1.3 Product Feature of Equipment Under Test

| Product Feature | |
|---------------------------------|---|
| Equipment | Mobile Cellular Phone |
| Brand Name | Motorola |
| Model Name | XT2083-1 |
| FCC ID | IHDT56ZD5 |
| EUT supports Radios application | GSM/WCDMA/LTE WLAN 2.4GHz 802.11b/g/n HT20 WLAN 5GHz 802.11a/n HT20/HT40 WLAN 5GHz 802.11ac VHT20/VHT40/VHT80 Bluetooth BR / EDR / LE FM Receiver / GNSS |
| IMEI Code | Conducted / Radiation: N/A Conduction: 355530110015754/355530110015762 |
| HW Version | DVT2 |
| SW Version | QPX30.34 |
| EUT Stage | Production Unit |

Remark:

1. The above EUT's information was declared by manufacturer. Please refer to the specifications or user's manual for more detailed description.
2. BT4.2/5.0 supports 1Mbps data rate only.

1.4 Product Specification of Equipment Under Test

| Standards-related Product Specification | |
|---|--|
| Tx/Rx Frequency Range | 2402 MHz ~ 2480 MHz |
| Number of Channels | 40 |
| Carrier Frequency of Each Channel | 40 Channel(37 hopping + 3 advertising channel) |
| Maximum Output Power to Antenna | 7.93 dBm (0.0062 W) |
| Antenna Type / Gain | PIFA Antenna type with gain -0.50 dBi |
| Type of Modulation | Bluetooth LE : GFSK |



1.5 Modification of EUT

No modifications are made to the EUT during all test items.

1.6 Testing Location

Sporton International (Kunshan) Inc. is accredited to ISO/IEC 17025:2017 by American Association for Laboratory Accreditation with Certificate Number 5145.02.

| | | | |
|---------------------------|--|----------------------------|---------------------------------------|
| Test Firm | Sporton International (Kunshan) Inc. | | |
| Test Site Location | No. 1098, Pengxi North Road, Kunshan Economic Development Zone Jiangsu Province 215300 People's Republic of China TEL : +86-512-57900158 FAX : +86-512-57900958 | | |
| Test Site No. | Sporton Site No. | FCC Designation No. | FCC Test Firm Registration No. |
| | CO01-KS 03CH05-KS TH01-KS | CN1257 | 314309 |

1.7 Test Software

| Item | Site | Manufacture | Name | Version |
|------|-----------|-------------|------|---------------|
| 1. | 03CH05-KS | AUDIX | E3 | 6.2009-8-24al |
| 2. | CO01-KS | AUDIX | E3 | 6.2009-8-24 |

1.8 Applicable Standards

According to the specifications of the manufacturer, the EUT must comply with the requirements of the following standards:

- 47 CFR Part 15 Subpart C §15.247
- FCC KDB 558074 D01 15.247 Meas Guidance v05r02
- ANSI C63.10-2013

Remark:

1. All test items were verified and recorded according to the standards and without any deviation during the test.
2. This EUT has also been tested and complied with the requirements of FCC Part 15, Subpart B, recorded in a separate test report.



1.9 Specification of Accessory

| Specification of Accessory | | | | |
|----------------------------|------------|----------------------------|------------|--------------|
| AC Adapter 1(US) | Brand Name | Motorola (Acbel) | Model Name | MC-201 |
| AC Adapter 1(EU) | Brand Name | Motorola (Acbel) | Model Name | MC-202 |
| AC Adapter 1(UK) | Brand Name | Motorola (Acbel) | Model Name | MC-203 |
| AC Adapter 1(AU) | Brand Name | Motorola (Acbel) | Model Name | MC-205 |
| AC Adapter 1(AR) | Brand Name | Motorola (Acbel) | Model Name | MC-206 |
| AC Adapter 1(BR) | Brand Name | Motorola (Acbel) | Model Name | MC-207 |
| AC Adapter 1(Chile) | Brand Name | Motorola (Acbel) | Model Name | MC-209 |
| AC Adapter 2(US) | Brand Name | Motorola (Chenyang) | Model Name | MC-201 |
| AC Adapter 2(EU) | Brand Name | Motorola (Chenyang) | Model Name | MC-202 |
| AC Adapter 2(UK) | Brand Name | Motorola (Chenyang) | Model Name | MC-203 |
| AC Adapter 2(IN) | Brand Name | Motorola (Chenyang) | Model Name | MC-204 |
| AC Adapter 2(AU) | Brand Name | Motorola (Chenyang) | Model Name | MC-205 |
| AC Adapter 2(AR) | Brand Name | Motorola (Chenyang) | Model Name | MC-206 |
| AC Adapter 2(BR) | Brand Name | Motorola (Chenyang) | Model Name | MC-207 |
| AC Adapter 3(BR) | Brand Name | Motorola (Flex/Salom) | Model Name | SC-57 |
| AC Adapter 4(BR) | Brand Name | Motorola (Cliptech/Tenpao) | Model Name | SC-57 |
| Battery | Brand Name | Motorola(ATL) | Model Name | JK50 |
| Earphone 1 | Brand Name | Motorola (New Leader) | Model Name | EM09 |
| Earphone 2 | Brand Name | Motorola(Lyand) | Model Name | MH191 |
| Earphone 3 | Brand Name | Motorola (Juwei) | Model Name | JWEP1123-T03 |
| Earphone 4 | Brand Name | Motorola (Lchse) | Model Name | MH191 |
| USB Cable 1 | Brand Name | Motorola (Yihuaxing) | Model Name | T365-008 |
| USB Cable 2 | Brand Name | Motorola (Saibao) | Model Name | STN-A110 |
| USB Cable 3 | Brand Name | Motorola (I SHENG) | Model Name | SC18C28955 |



2 Test Configuration of Equipment Under Test

2.1 Carrier Frequency Channel

| Frequency Band | Channel | Freq. (MHz) | Channel | Freq. (MHz) |
|-----------------|---------|-------------|---------|-------------|
| 2400-2483.5 MHz | 0 | 2402 | 21 | 2444 |
| | 1 | 2404 | 22 | 2446 |
| | 2 | 2406 | 23 | 2448 |
| | 3 | 2408 | 24 | 2450 |
| | 4 | 2410 | 25 | 2452 |
| | 5 | 2412 | 26 | 2454 |
| | 6 | 2414 | 27 | 2456 |
| | 7 | 2416 | 28 | 2458 |
| | 8 | 2418 | 29 | 2460 |
| | 9 | 2420 | 30 | 2462 |
| | 10 | 2422 | 31 | 2464 |
| | 11 | 2424 | 32 | 2466 |
| | 12 | 2426 | 33 | 2468 |
| | 13 | 2428 | 34 | 2470 |
| | 14 | 2430 | 35 | 2472 |
| | 15 | 2432 | 36 | 2474 |
| | 16 | 2434 | 37 | 2476 |
| | 17 | 2436 | 38 | 2478 |
| | 18 | 2438 | 39 | 2480 |
| | 19 | 2440 | - | - |
| 20 | 2442 | - | - | |



2.2 Test Mode

- a. The EUT has been associated with peripherals and configuration operated in a manner tended to maximize its emission characteristics in a typical application. Frequency range investigated: conduction emission (150 kHz to 30 MHz), radiation emission (9 kHz to the 10th harmonic of the highest fundamental frequency or to 40 GHz, whichever is lower). For radiated measurement, pre-scanned in three orthogonal panels, X, Y, Z. The worst cases (X plane) were recorded in this report.
- b. AC power line Conducted Emission was tested under maximum output power.

The following summary table is showing all test modes to demonstrate in compliance with the standard.

| Summary table of Test Cases | |
|---|--|
| Test Item | Data Rate / Modulation |
| | Bluetooth – LE / GFSK |
| Conducted TCs | Mode 1: Bluetooth Tx CH00_2402 MHz_1Mbps Mode 2: Bluetooth Tx CH19_2440 MHz_1Mbps Mode 3: Bluetooth Tx CH39_2480 MHz_1Mbps |
| Radiated TCs | Mode 1: Bluetooth Tx CH00_2402 MHz_1Mbps Mode 2: Bluetooth Tx CH19_2440 MHz_1Mbps Mode 3: Bluetooth Tx CH39_2480 MHz_1Mbps |
| AC Conducted Emission | Mode 1: GSM 850 Idle + Bluetooth Link + WLAN Link (2.4G) + USB Cable 4(Charging from Adapter 4) + Earphone 1 + Battery 1 |
| Remark: For Radiated Test Cases, The tests were performed with Adapter 1, Battery, Earphone and USB Cable 1. | |

2.3 Connection Diagram of Test System

For Radiation

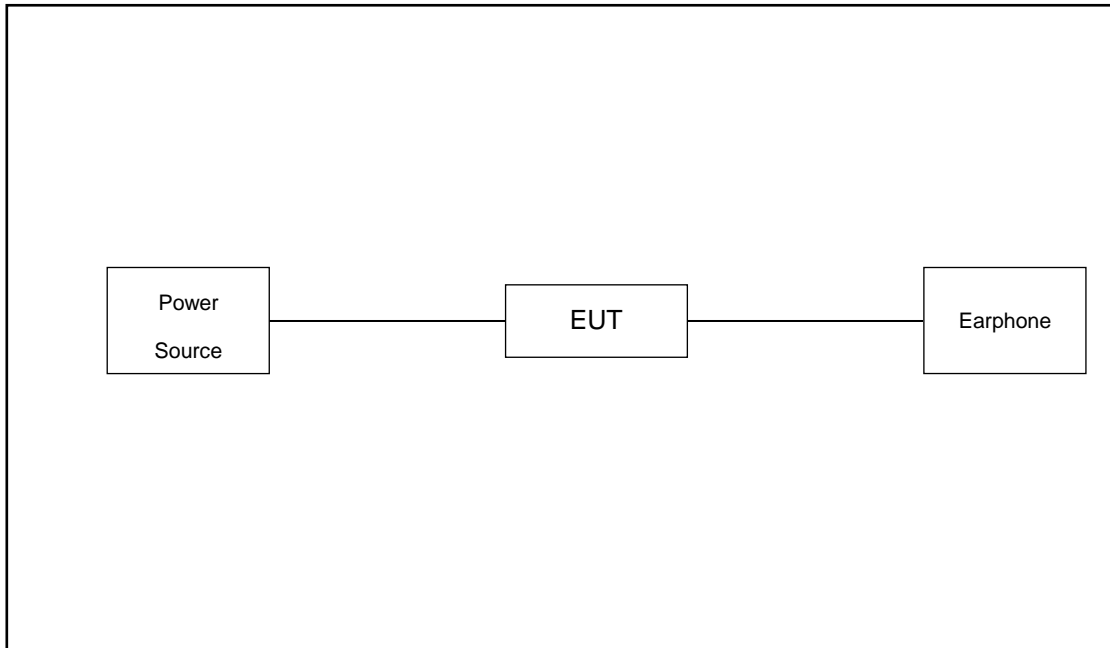

For Conducted Emission

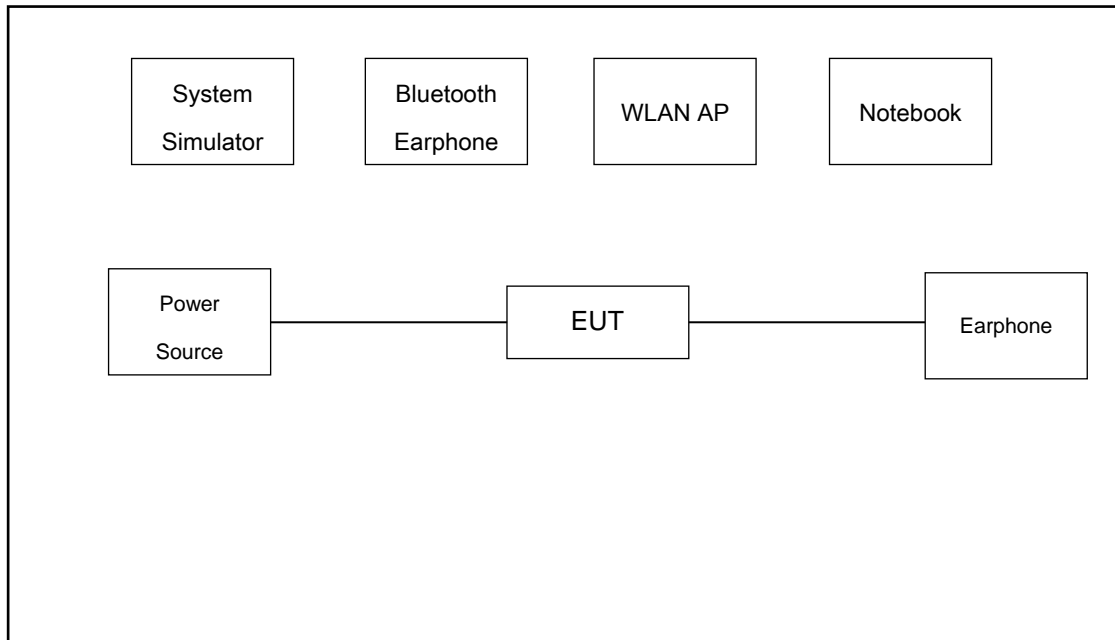

2.4 Support Unit used in test configuration and system

| Item | Equipment | Trade Name | Model Name | FCC ID | Data Cable | Power Cord |
|------|--------------------|------------|------------|---------------|----------------|--|
| 1. | System Simulator | Anritsu | MT8820C | N/A | N/A | Unshielded, 1.8m |
| 2. | WLAN AP | D-link | DIR-655 | KA21R655B1 | N/A | Unshielded, 1.8m |
| 3. | Notebook | Lenovo | G480 | QDS-BRCM1050I | N/A | AC I/P: Unshielded, 1.2 m DC O/P: Shielded, 1.8 m |
| 4. | Bluetooth Earphone | Lenovo | LBH308 | N/A | N/A | N/A |
| 5. | SD Card | Kingston | 8GB | N/A | N/A | N/A |
| 6. | Hard Disk | Lenovo | F310 | DoC | Shielded, 1.2m | N/A |

2.5 EUT Operation Test Setup

For BLE function, the engineering test program was provided and enabled to make EUT continuous transmit/receive.

For AC power line conducted emissions, the EUT was set to connect with the WLAN AP under large package sizes transmission.

2.6 Measurement Results Explanation Example

For all conducted test items:

The offset level is set in the spectrum analyzer to compensate the RF cable loss and attenuator factor between EUT conducted output port and spectrum analyzer. With the offset compensation, the spectrum analyzer reading level is exactly the EUT RF output level.

Example :

The spectrum analyzer offset is derived from RF cable loss and attenuator factor.

Offset = RF cable loss.

Following shows an offset computation example with cable loss 5.3 dB.

$$\begin{aligned} \text{Offset(dB)} &= \text{RF cable loss(dB)}. \\ &= 5.3 \text{ (dB)} \end{aligned}$$

3 Test Result

3.1 6dB Bandwidth Measurement

3.1.1 Limit of 6dB Bandwidth

The minimum 6 dB bandwidth shall be at least 500 kHz.

3.1.2 Measuring Instruments

The section 4.0 of List of Measuring Equipment of this test report is used for test.

3.1.3 Test Procedures

1. The testing follows ANSI C63.10-2013 clause 11.8
2. The RF output of EUT was connected to the spectrum analyzer by RF cable and attenuator. The path loss was compensated to the results for each measurement.
3. Set to the maximum power setting and enable the EUT transmit continuously.
4. Make the measurement with the spectrum analyzer's resolution bandwidth (RBW) = 100 kHz. Set the Video bandwidth (VBW) = 300 kHz. In order to make an accurate measurement. The 6 dB bandwidth must be greater than 500 kHz.
5. Measure and record the results in the test report.

3.1.4 Test Setup

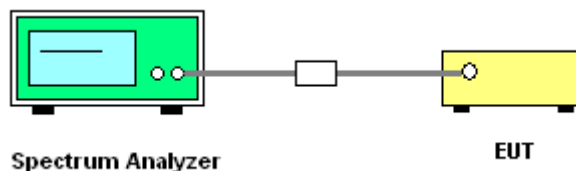



3.1.5 Test Result of 6dB Bandwidth

Please refer to Appendix A.

6 dB Bandwidth Plot on Channel 00

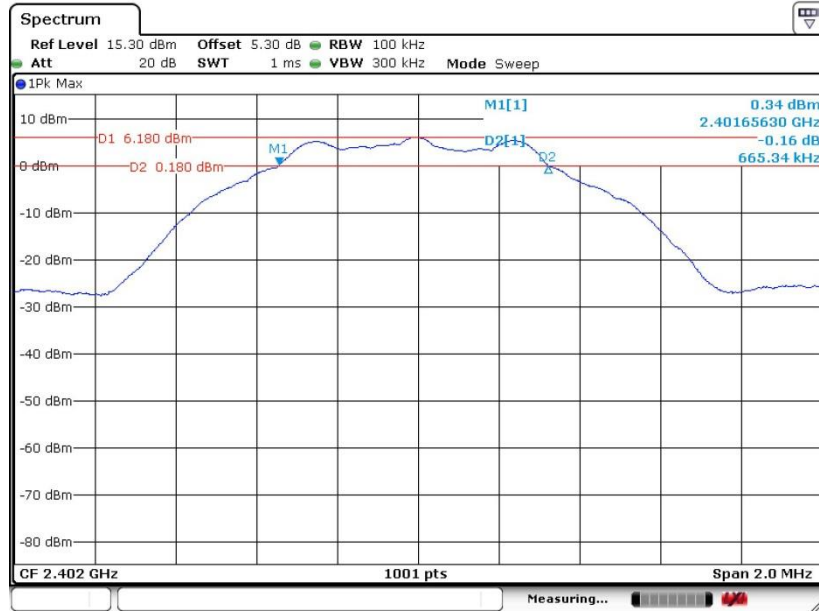

6 dB Bandwidth Plot on Channel 19

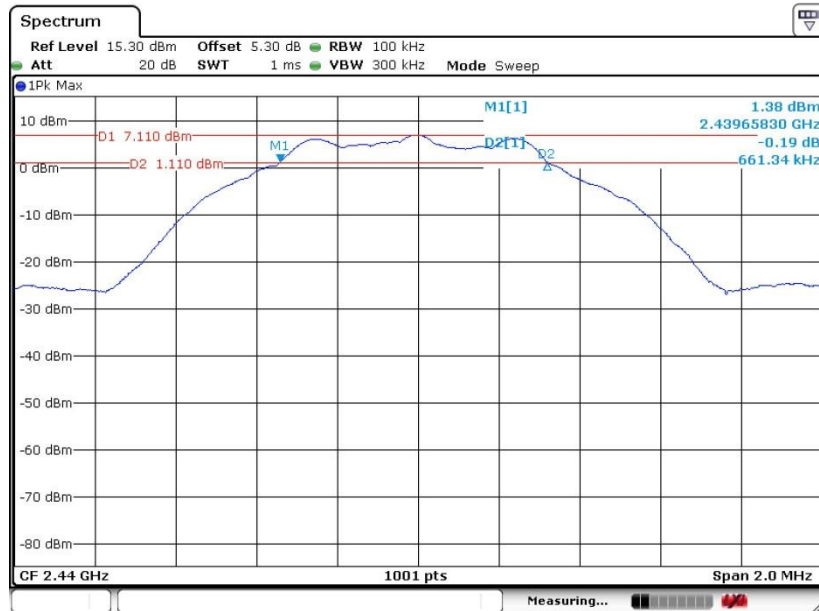



6 dB Bandwidth Plot on Channel 39

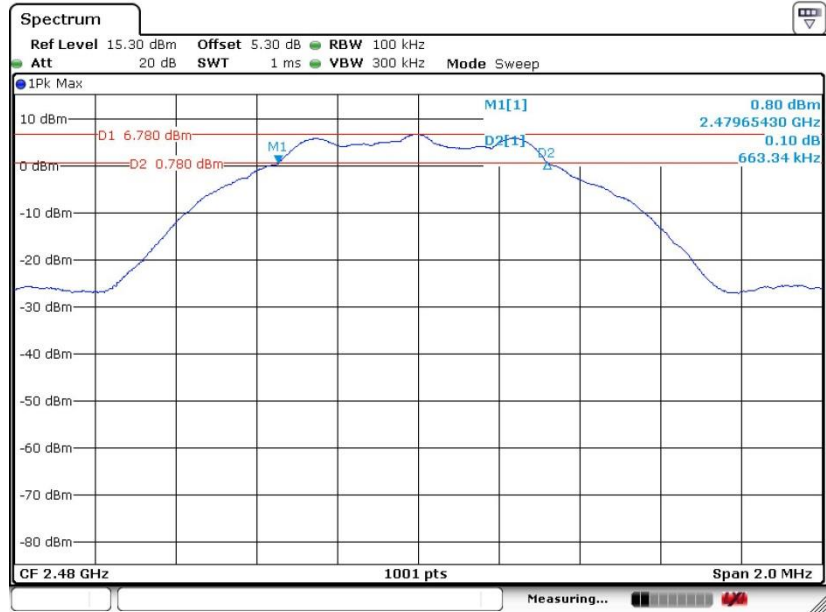

Date: 1.MAY.2020 23:42:39

3.2 Output Power Measurement

3.2.1 Limit of Output Power

For systems using digital modulation in the 2400-2483.5MHz, the limit for peak output power is 30dBm. If transmitting antenna of directional gain greater than 6dBi is used, the peak output power from the intentional radiator shall be reduced below the above stated value by the amount in dB that the directional gain of the antenna exceeds 6 dBi. In case of point-to-point operation, the limit has to be reduced by 1dB for every 3dB that the directional gain of the antenna exceeds 6dBi.

3.2.2 Measuring Instruments

The section 4.0 of List of Measuring Equipment of this test report is used for test.

3.2.3 Test Procedures

1. The testing follows the Measurement Procedure of ANSI C63.10-2013 clause 11.9.1.3 PKPM1 Peak power meter or ANSI C63.10-2013 clause 11.9.2.3.2 Method AVGPM-G method.
2. The RF output of EUT was connected to the power meter by RF cable and attenuator. The path loss was compensated to the results for each measurement.
3. Set to the maximum power setting and enable the EUT transmit continuously.
4. Measure the conducted output power and record the results in the test report.

3.2.4 Test Setup

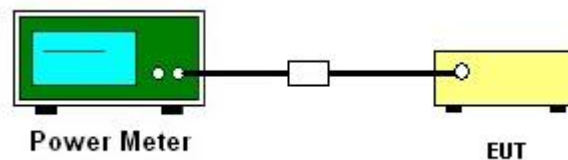

3.2.5 Test Result of Peak Output Power

Please refer to Appendix A.

3.2.6 Test Result of Average Output Power (Reporting Only)

Please refer to Appendix A.

3.3 Power Spectral Density Measurement

3.3.1 Limit of Power Spectral Density

The peak power spectral density shall not be greater than 8dBm in any 3kHz band at any time interval of continuous transmission.

3.3.2 Measuring Instruments

The section 4.0 of List of Measuring Equipment of this test report is used for test.

3.3.3 Test Procedures

1. The testing follows Measurement Procedure of ANSI C63.10-2013 clause 11.10.2 Method PKPSD.
2. The RF output of EUT was connected to the spectrum analyzer by RF cable and attenuator. The path loss was compensated to the results for each measurement.
3. Set to the maximum power setting and enable the EUT transmit continuously.
4. Make the measurement with the spectrum analyzer's resolution bandwidth (RBW) = 3 kHz. Video bandwidth VBW = 10 kHz In order to make an accurate measurement, set the span to 1.5 times DTS Channel Bandwidth. (6dB BW)
5. Detector = peak, Sweep time = auto couple, Trace mode = max hold, Allow trace to fully stabilize. Use the peak marker function to determine the maximum power level.
6. Measure and record the results in the test report.
7. The Measured power density (dBm)/ 100kHz is a reference level and used as 20dBc down limit line for Conducted Band Edges and Conducted Spurious Emission.

3.3.4 Test Setup

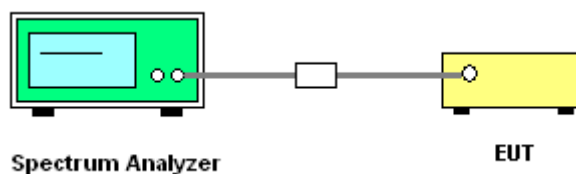

3.3.5 Test Result of Power Spectral Density

Please refer to Appendix A.



3.3.6 Test Result of Power Spectral Density Plots (100kHz)

PSD 100kHz Plot on Channel 00

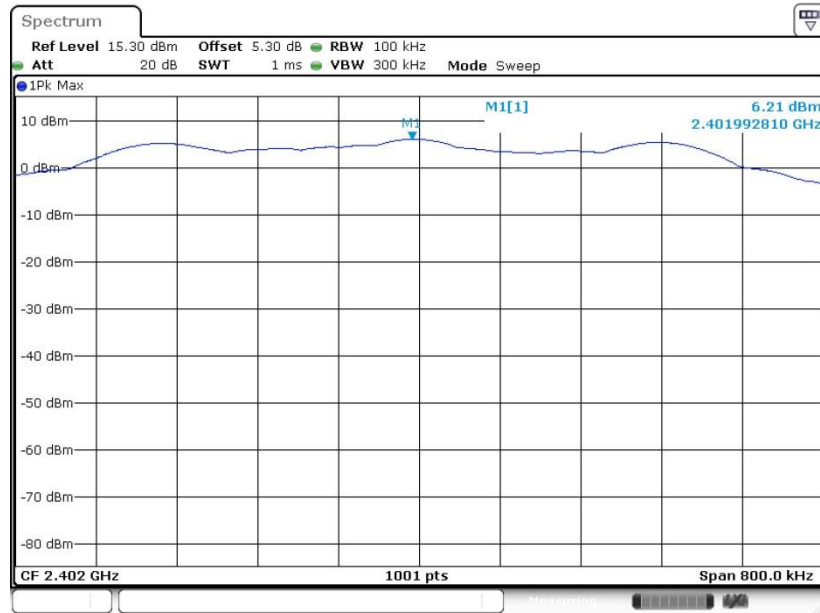

Date: 1.MAY.2020 23:38:53

PSD 100kHz Plot on Channel 19

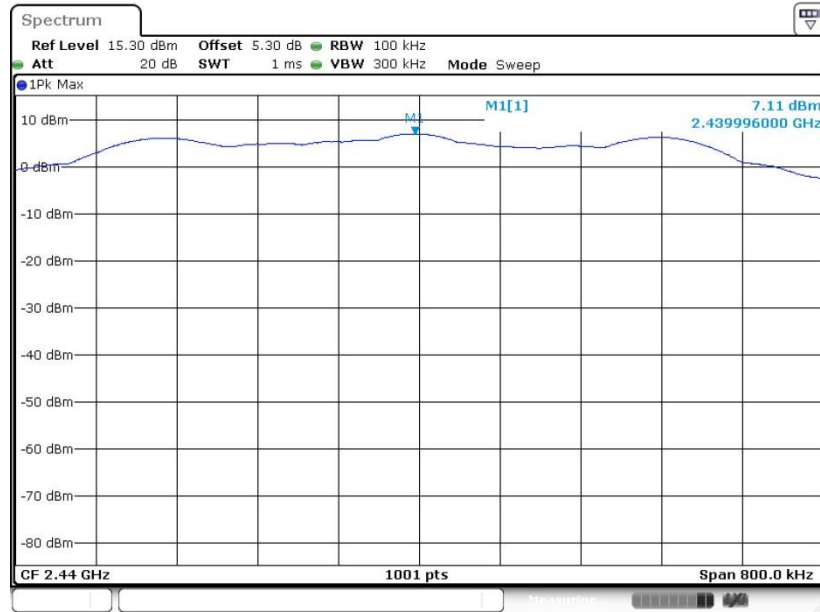

Date: 1.MAY.2020 23:41:25



PSD 100kHz Plot on Channel 39

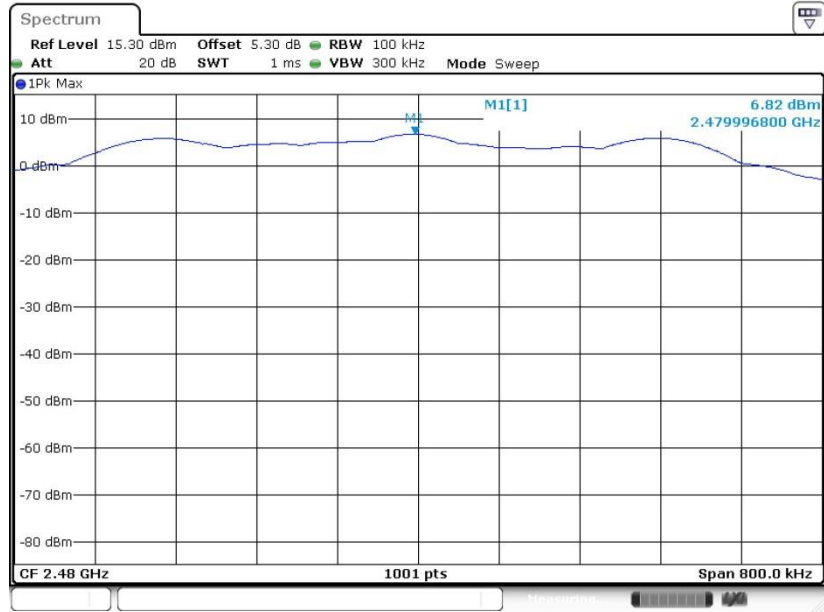

Date: 1.MAY.2020 23:43:08



3.3.7 Test Result of Power Spectral Density Plots (3kHz)

PSD 3kHz Plot on Channel 00

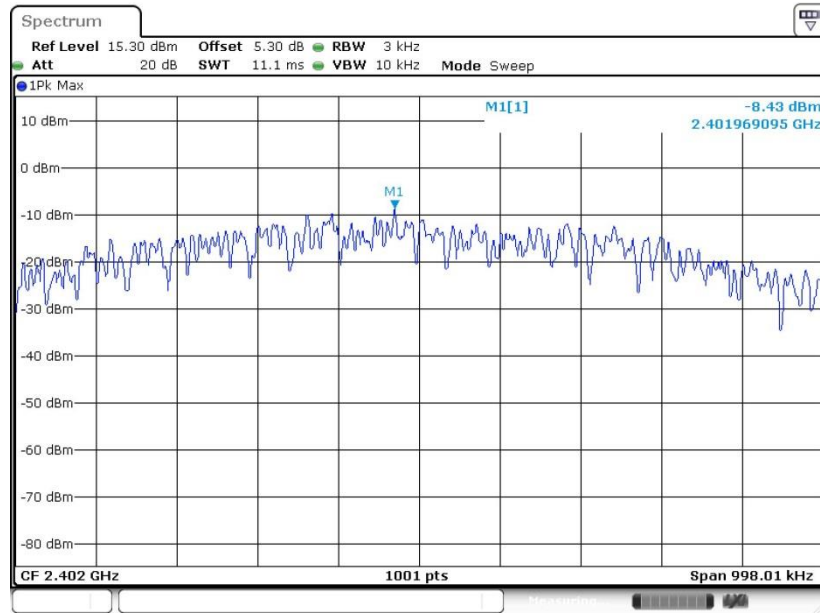

Date: 1.MAY.2020 23:38:40

PSD 3kHz Plot on Channel 19

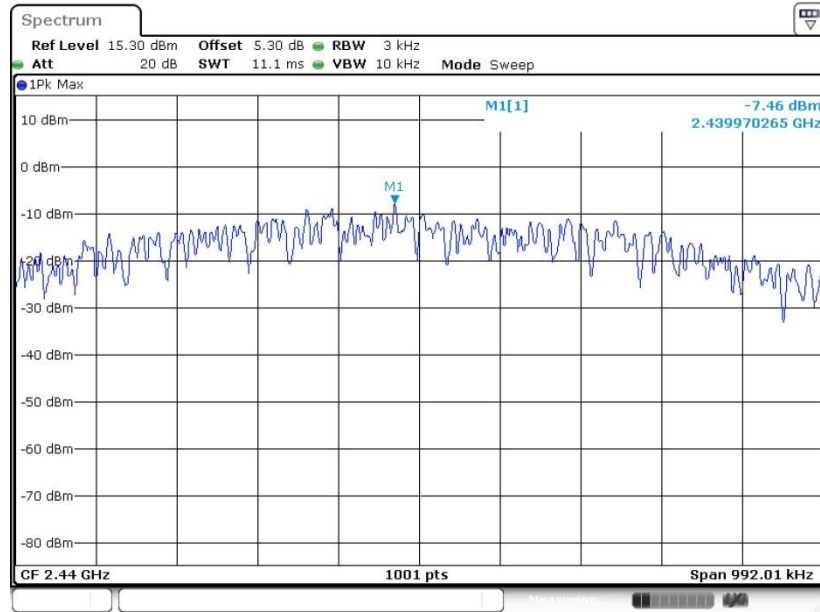

Date: 1.MAY.2020 23:41:13



PSD 3kHz Plot on Channel 39

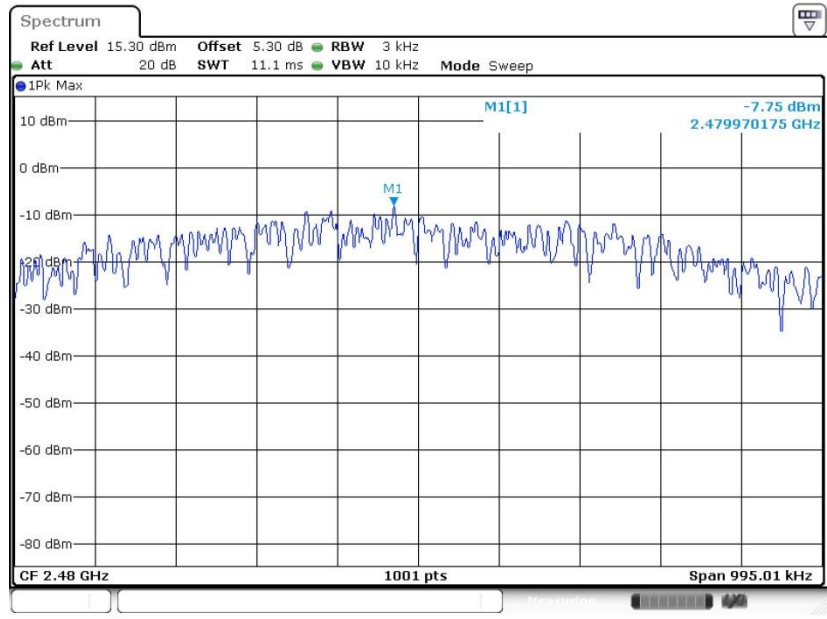

Date: 1.MAY.2020 23:42:51

3.4 Conducted Band Edges and Spurious Emission Measurement

3.4.1 Limit of Conducted Band Edges and Spurious Emission

All harmonics/spurious must be at least 20 dB down from the highest emission level within the authorized band.

3.4.2 Measuring Instruments

The section 4.0 of List of Measuring Equipment of this test report is used for test.

3.4.3 Test Procedure

1. The testing follows ANSI C63.10-2013 clause 11.13
2. The RF output of EUT was connected to the spectrum analyzer by RF cable and attenuator. The path loss was compensated to the results for each measurement.
3. Set to the maximum power setting and enable the EUT transmit continuously.
4. Set RBW = 100 kHz, VBW=300 kHz, Peak Detector. Unwanted Emissions measured in any 100 kHz bandwidth outside of the authorized frequency band shall be attenuated by at least 20 dB relative to the maximum in-band peak PSD level in 100 kHz when maximum peak conducted output power procedure is used. If the transmitter complies with the conducted power limits based on the use of RMS averaging over a time interval, the attenuation required under this paragraph shall be 30 dB instead of 20 dB.
5. Measure and record the results in the test report.
6. The RF fundamental frequency should be excluded against the limit line in the operating frequency band.

3.4.4 Test Setup

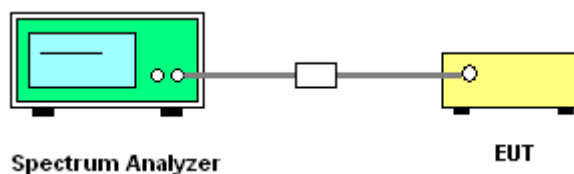



3.4.5 Test Result of Conducted Band Edges Plots

Low Band Edge Plot on Channel 00

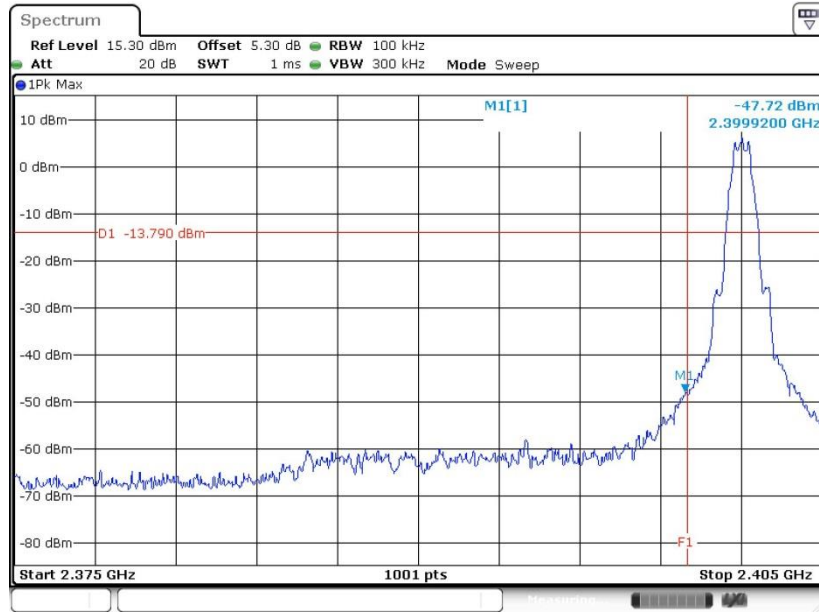

Date: 1.MAY.2020 23:39:02

High Band Edge Plot on Channel 39

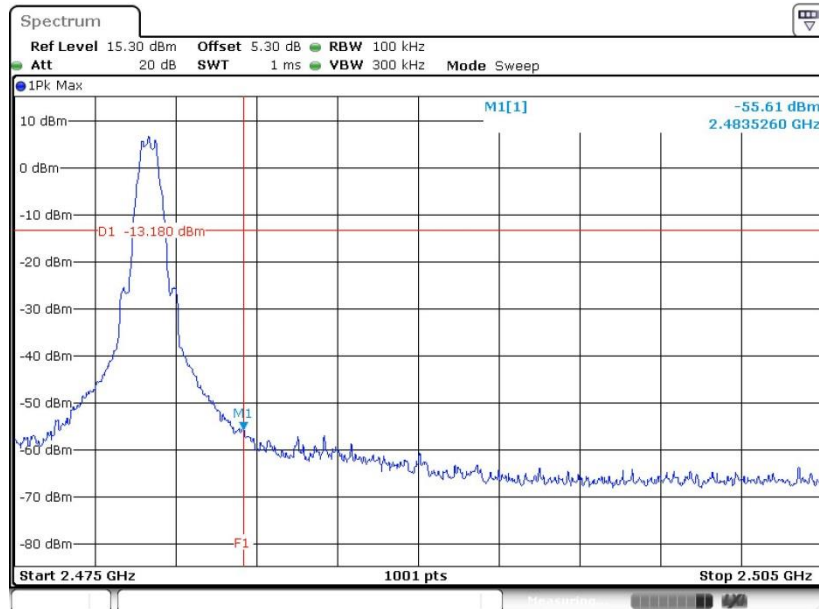

Date: 1.MAY.2020 23:43:39



3.4.6 Test Result of Conducted Spurious Emission Plots

Conducted Spurious Emission Plot on Bluetooth LE 1Mbps GFSK Channel 00

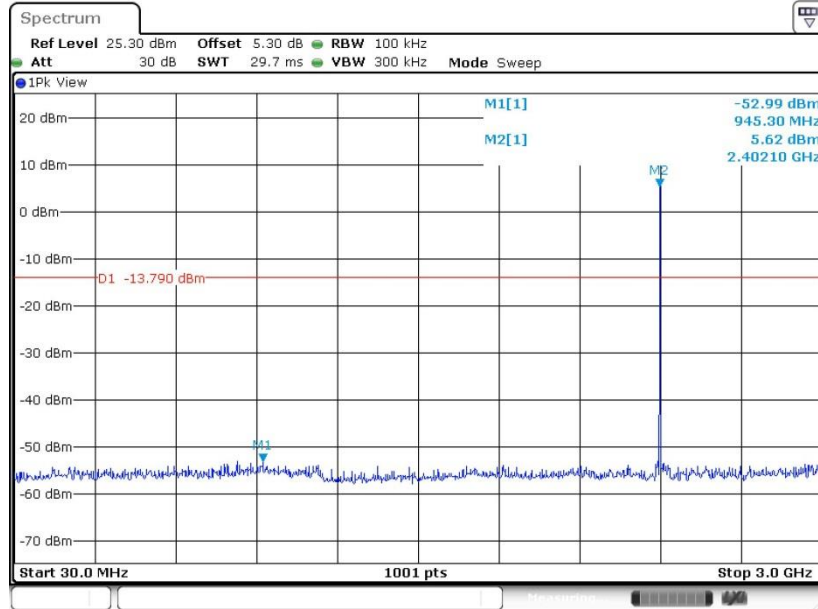

Date: 1.MAY.2020 23:39:51

Conducted Spurious Emission Plot on Bluetooth LE 1Mbps GFSK Channel 00

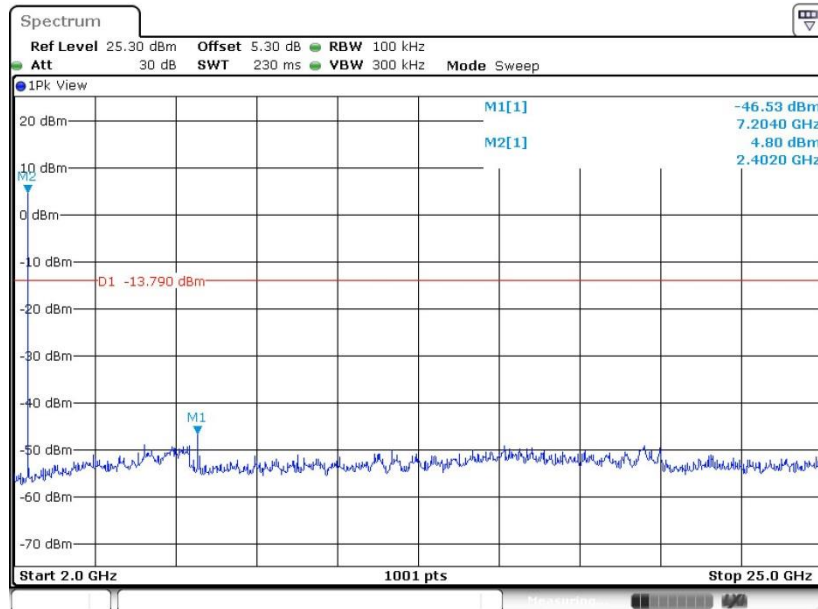

Date: 1.MAY.2020 23:39:59



Conducted Spurious Emission Plot on Bluetooth LE 1Mbps GFSK Channel 19

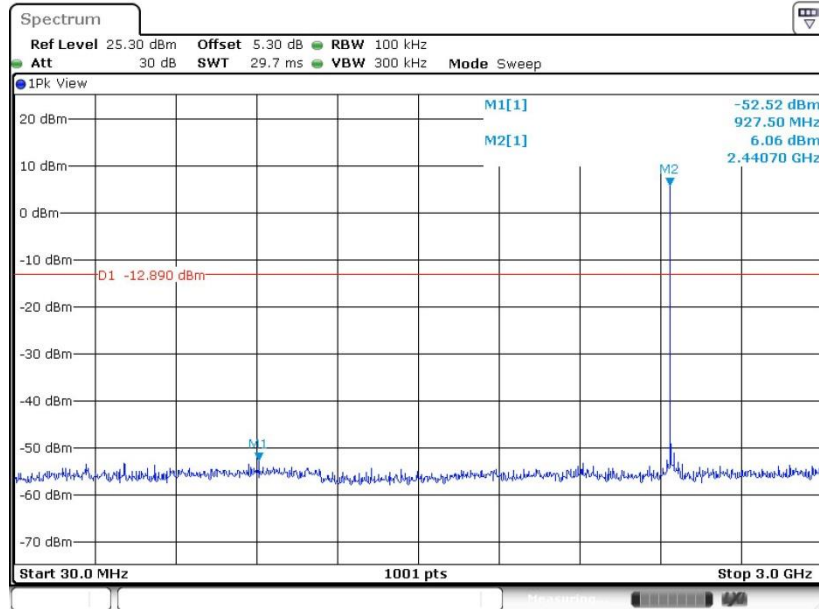

Date: 1.MAY.2020 23:41:35

Conducted Spurious Emission Plot on Bluetooth LE 1Mbps GFSK Channel 19

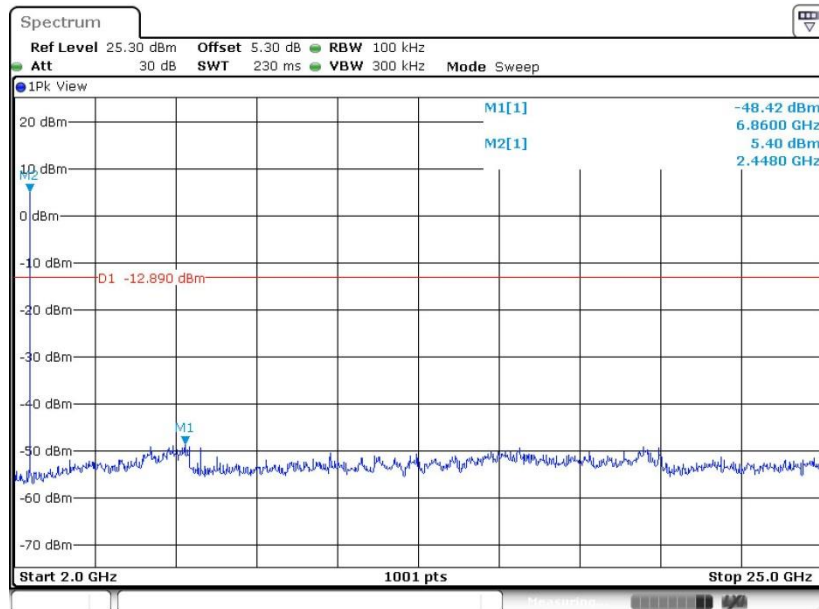

Date: 1.MAY.2020 23:41:43



Conducted Spurious Emission Plot on Bluetooth LE 1Mbps GFSK Channel 39

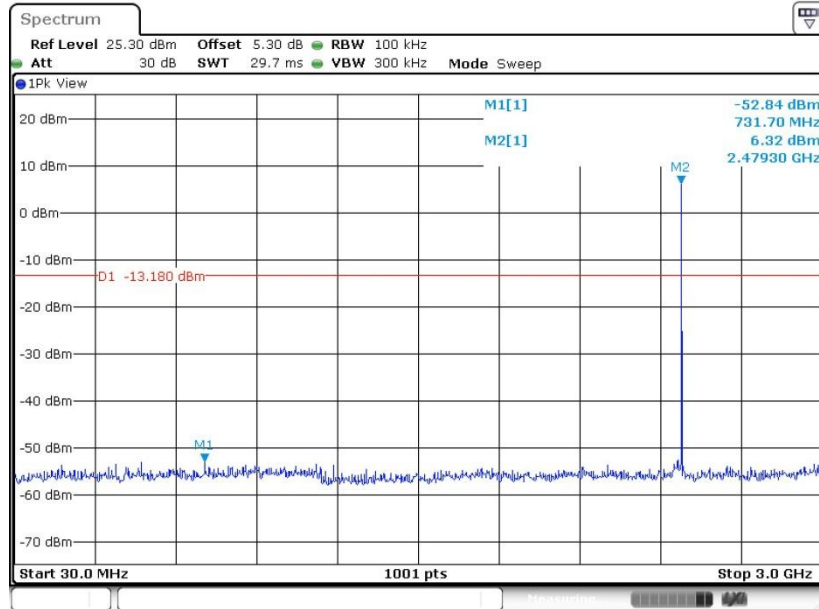

Date: 1.MAY.2020 23:43:53

Conducted Spurious Emission Plot on Bluetooth LE 1Mbps GFSK Channel 39

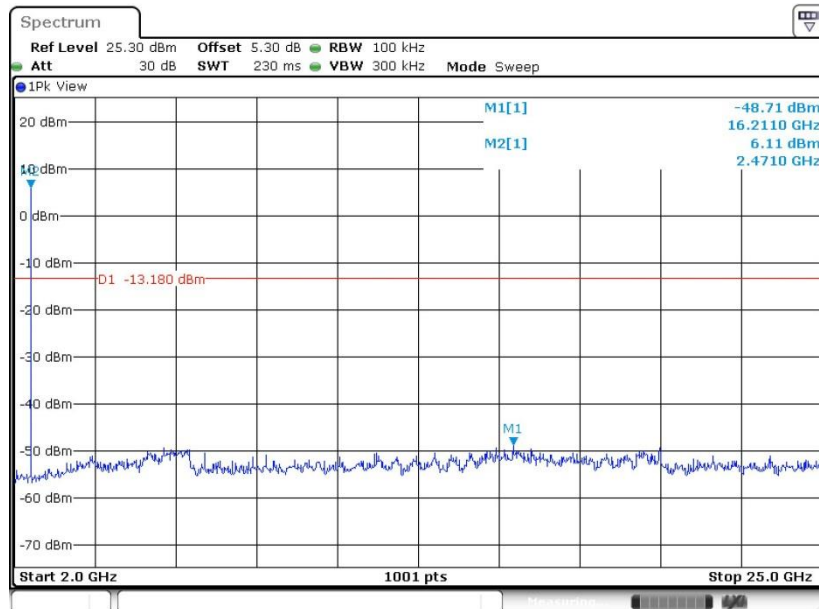

Date: 1.MAY.2020 23:44:01



3.5 Radiated Band Edges and Spurious Emission Measurement

3.5.1 Limit of Radiated Band Edges and Spurious Emission

In any 100 kHz bandwidth outside the intentional radiator frequency band, all harmonics/spurious must be at least 20 dB below the highest emission level within the authorized band. If the output power of this device was measured by spectrum analyzer, the attenuation under this paragraph shall be 30 dB instead of 20 dB. In addition, radiated emissions which fall in the restricted bands must also comply with the limits as below.

| Frequency (MHz) | Field Strength (microvolts/meter) | Measurement Distance (meters) |
|-----------------|-----------------------------------|-------------------------------|
| 0.009 – 0.490 | 2400/F(kHz) | 300 |
| 0.490 – 1.705 | 24000/F(kHz) | 30 |
| 1.705 – 30.0 | 30 | 30 |
| 30 – 88 | 100 | 3 |
| 88 – 216 | 150 | 3 |
| 216 - 960 | 200 | 3 |
| Above 960 | 500 | 3 |

3.5.2 Measuring Instruments

The section 4.0 of List of Measuring Equipment of this test report is used for test.



3.5.3 Test Procedures

1. The testing follows ANSI C63.10-2013 clause 11.11 & 11.12
2. The EUT was arranged to its worst case and then tune the antenna tower (from 1 m to 4 m) and turntable (from 0 degree to 360 degrees) to find the maximum reading. A pre-amp and a high pass filter are used for the test in order to get better signal level.
3. The EUT was placed on a turntable with 0.8 meter for frequency below 1GHz and 1.5 meter for frequency above 1GHz respectively above ground.
4. The EUT was set 3 meters from the interference receiving antenna, which was mounted on the top of a variable height antenna tower.
5. Corrected Reading: Antenna Factor + Cable Loss + Read Level - Preamp Factor = Level
6. For testing below 1GHz, if the emission level of the EUT in peak mode was 3 dB lower than the limit specified, then peak values of EUT will be reported, otherwise, the emissions will be repeated one by one using the CISPR quasi-peak method and reported.
7. For testing above 1GHz, the emission level of the EUT in peak mode was 20dB lower than average limit (that means the emission level in average mode also complies with the limit in average mode), then peak values of EUT will be reported, otherwise, the emissions will be measured in average mode again and reported.
8. Use the following spectrum analyzer settings:
 - (1) Span shall wide enough to fully capture the emission being measured;
 - (2) Set RBW=100 kHz for $f < 1$ GHz; $VBW \geq RBW$; Sweep = auto; Detector function = peak; Trace = max hold;
 - (3) Set RBW = 1 MHz, VBW= 3MHz for $f \geq 1$ GHz for peak measurement.
For average measurement:
 - $VBW = 10$ Hz, when duty cycle is no less than 98 percent.
 - $VBW \geq 1/T$, when duty cycle is less than 98 percent where T is the minimum transmission duration over which the transmitter is on and is transmitting at its maximum power control level for the tested mode of operation.

3.5.4 Test Setup

For radiated emissions below 30MHz

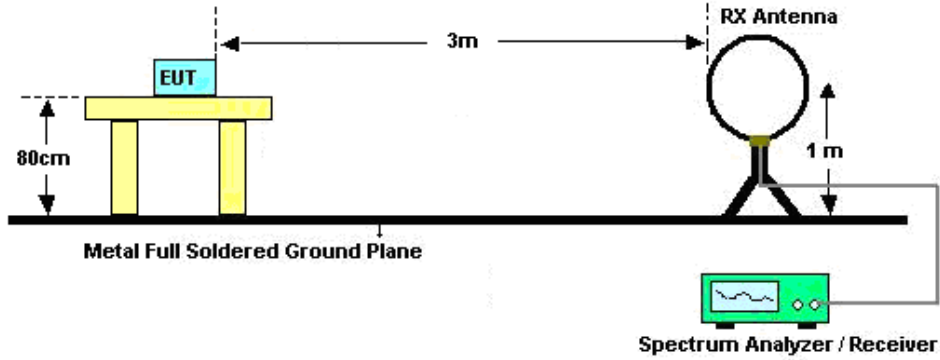

For radiated emissions from 30MHz to 1GHz

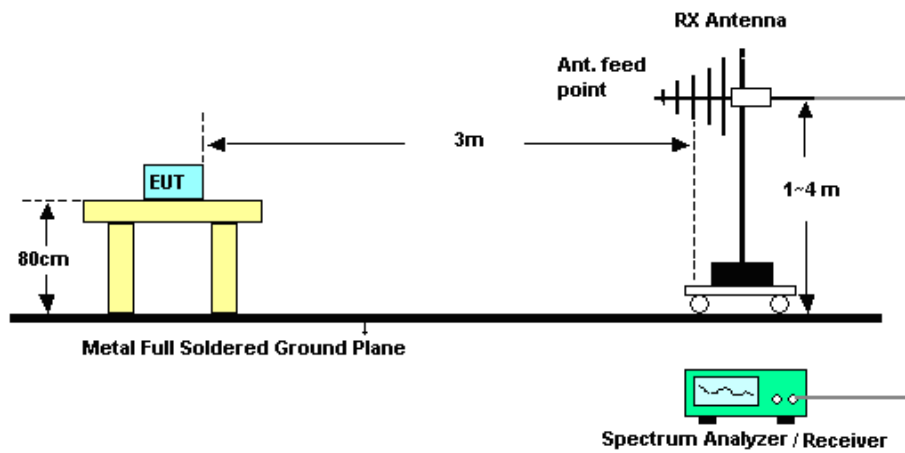

For radiated emissions above 1GHz

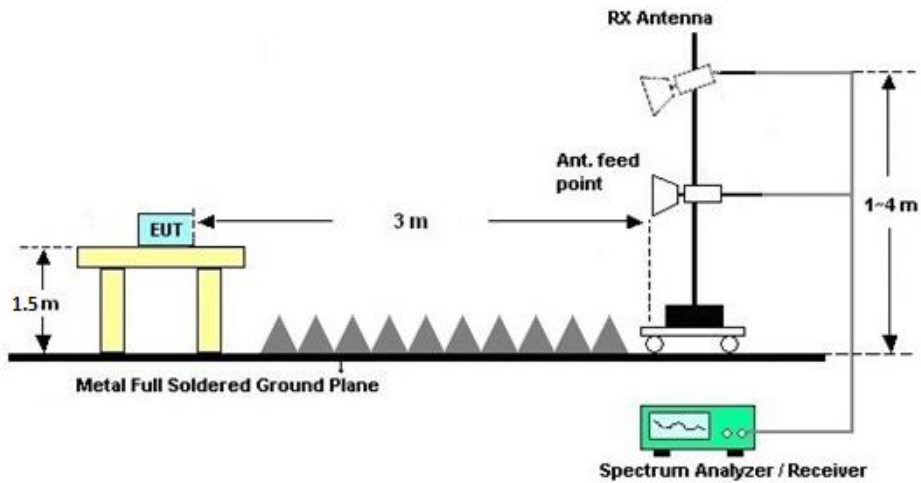



3.5.5 Test Results of Radiated Spurious Emissions (9 kHz ~ 30 MHz)

The low frequency, which started from 9 kHz to 30MHz, was pre-scanned and the result which was 20dB lower than the limit line was not reported.

There is a comparison data of both open-field test site and semi-Anechoic chamber, and the result came out very similar.

3.5.6 Test Result of Radiated Spurious at Band Edges

Please refer to Appendix C.

3.5.7 Duty Cycle

Please refer to Appendix D.

3.5.8 Test Result of Radiated Spurious Emission (30MHz ~ 10th Harmonic)

Please refer to Appendix C.



3.6 AC Conducted Emission Measurement

3.6.1 Limit of AC Conducted Emission

For equipment that is designed to be connected to the public utility (AC) power line, the radio frequency voltage that is conducted back onto the AC power line on any frequency or frequencies within the band 150 kHz to 30 MHz shall not exceed the limits in the following table.

| Frequency of emission (MHz) | Conducted limit (dBµV) | |
|-----------------------------|------------------------|-----------|
| | Quasi-peak | Average |
| 0.15-0.5 | 66 to 56* | 56 to 46* |
| 0.5-5 | 56 | 46 |
| 5-30 | 60 | 50 |

*Decreases with the logarithm of the frequency.

3.6.2 Measuring Instruments

The section 4.0 of List of Measuring Equipment of this test report is used for test.

3.6.3 Test Procedures

1. The EUT was placed 0.4 meter from the conducting wall of the shielding room was kept at least 80 centimeters from any other grounded conducting surface.
2. Connect EUT to the power mains through a line impedance stabilization network (LISN).
3. All the support units are connecting to the other LISN.
4. The LISN provides 50 ohm coupling impedance for the measuring instrument.
5. The FCC states that a 50 ohm, 50 microhenry LISN should be used.
6. Both sides of AC line were checked for maximum conducted interference.
7. The frequency range from 150 kHz to 30 MHz was searched.
8. Set the test-receiver system to Peak Detect Function and specified bandwidth (IF Bandwidth = 9kHz) with Maximum Hold Mode. Then measurement is also conducted by Average Detector and Quasi-Peak Detector Function respectively.

3.6.4 Test Setup



3.6.5 Test Result of AC Conducted Emission

Please refer to Appendix B.



3.7 Antenna Requirements

3.7.1 Standard Applicable

If directional gain of transmitting antennas is greater than 6dBi, the power shall be reduced by the same level in dB comparing to gain minus 6dBi. The use of a permanently attached antenna or of an antenna that uses a unique coupling to the intentional radiator shall be considered sufficient to comply with the rule.

3.7.2 Antenna Anti-Replacement Construction

An embedded-in antenna design is used.

3.7.3 Antenna Gain

The antenna peak gain of EUT is less than 6 dBi. Therefore, it is not necessary to reduce maximum peak output power limit.



4 List of Measuring Equipment

| Instrument | Manufacturer | Model No. | Serial No. | Characteristics | Calibration Date | Test Date | Due Date | Remark |
|-----------------------------------|--------------|----------------------------|-------------|-------------------------|------------------|---------------|---------------|-----------------------|
| Spectrum Analyzer | R&S | FSV40 | 101040 | 10Hz~40GHz | Nov. 02, 2019 | May 01, 2020 | Nov. 01, 2020 | Conducted (TH01-KS) |
| Pulse Power Sensor | Anritsu | MA2411B | 0917070 | 300MHz~40GHz | Jan. 15, 2020 | May 01, 2020 | Jan. 14, 2021 | Conducted (TH01-KS) |
| Power Meter | Anritsu | ML2495A | 1005002 | 50MHz Bandwidth | Jan. 08, 2020 | May 01, 2020 | Jan. 07, 2021 | Conducted (TH01-KS) |
| EMI Test Receiver | Keysight | N9038A | MY57290151 | 3Hz~8.5GHz;Max 30dBm | Jul. 18, 2019 | Jun. 01, 2020 | Jul. 17, 2020 | Radiation (03CH05-KS) |
| EXA Spectrum Analyzer | Keysight | N9010A | MY55150244 | 10Hz~44G,MAX 30dB | Apr. 15, 2020 | Jun. 01, 2020 | Apr. 14, 2021 | Radiation (03CH05-KS) |
| Loop Antenna | R&S | HFH2-Z2 | 100321 | 9kHz~30MHz | Nov. 10, 2019 | Jun. 01, 2020 | Nov. 09, 2020 | Radiation (03CH05-KS) |
| Bilog Antenna | TeseQ | CBL6111D | 49922 | 30MHz~1GHz | Dec. 28, 2019 | Jun. 01, 2020 | Dec. 27, 2020 | Radiation (03CH05-KS) |
| Double Ridge Horn Antenna | ETS-Lindgren | 3117 | 00218652 | 1GHz~18GHz | Apr. 26, 2020 | Jun. 01, 2020 | Apr. 25, 2021 | Radiation (03CH05-KS) |
| SHF-EHF Horn | Com-power | AH-840 | 101115 | 18GHz~40GHz | Nov. 10, 2019 | Jun. 01, 2020 | Nov. 09, 2020 | Radiation (03CH05-KS) |
| Amplifier | SONOMA | 310N | 187289 | 9KHz~1GHz | Aug. 06, 2019 | Jun. 01, 2020 | Aug. 05, 2020 | Radiation (03CH05-KS) |
| Amplifier | MITEQ | EM18G40GGA | 060728 | 18~40GHz | Jan. 08, 2020 | Jun. 01, 2020 | Jan. 07, 2021 | Radiation (03CH05-KS) |
| high gain Amplifier | MITEQ | AMF-7D-0010 1800-30-10P | 2025788 | 1Ghz~18Ghz | Aug. 17, 2019 | Jun. 01, 2020 | Aug. 16, 2020 | Radiation (03CH05-KS) |
| Amplifier | Keysight | 83017A | MY53270316 | 500MHz~26.5GHz | Oct. 18, 2019 | Jun. 01, 2020 | Oct. 17, 2020 | Radiation (03CH05-KS) |
| AC Power Source | Chroma | 61601 | F104090004 | N/A | NCR | Jun. 01, 2020 | NCR | Radiation (03CH05-KS) |
| Turn Table | ChamPro | EM 1000-T | 060762-T | 0~360 degree | NCR | Jun. 01, 2020 | NCR | Radiation (03CH05-KS) |
| EMI Receiver | R&S | ESCI7 | 100768 | 9kHz~7GHz; | Apr. 14, 2020 | May 09, 2020 | Apr. 13, 2021 | Conduction (CO01-KS) |
| AC LISN (for auxiliary equipment) | MessTec | AN3016 | 060103 | 9kHz~30MHz | Oct. 18, 2019 | May 09, 2020 | Oct. 17, 2020 | Conduction (CO01-KS) |
| AC LISN | MessTec | AN3016 | 060105 | 9kHz~30MHz | Oct. 28, 2019 | May 09, 2020 | Oct. 27, 2020 | Conduction (CO01-KS) |
| AC Power Source | Chroma | 61602 | ABP00000811 | AC 0V~300V, 45Hz~1000Hz | Oct. 18, 2019 | May 09, 2020 | Oct. 17, 2020 | Conduction (CO01-KS) |

NCR: No Calibration Required



5 Uncertainty of Evaluation

The measurement uncertainties shown below were calculated in accordance with the requirements of ANSI 63.10-2013. All the measurement uncertainty value were shown with a coverage K=2 to indicate 95% level of confidence. The measurement data show herein meets or exceeds the CISPR measurement uncertainty values specified in CISPR 16-4-2 and can be compared directly to specified limit to determine compliance.

Uncertainty of Conducted Emission Measurement (150 kHz ~ 30 MHz)

| | |
|---|-------|
| Measuring Uncertainty for a Level of Confidence of 95% (U = 2Uc(y)) | 2.9dB |
|---|-------|

Uncertainty of Radiated Emission Measurement (30 MHz ~ 1000 MHz)

| | |
|---|-------|
| Measuring Uncertainty for a Level of Confidence of 95% (U = 2Uc(y)) | 5.0dB |
|---|-------|

Uncertainty of Radiated Emission Measurement (1000 MHz ~ 18000 MHz)

| | |
|---|-------|
| Measuring Uncertainty for a Level of Confidence of 95% (U = 2Uc(y)) | 5.0dB |
|---|-------|

Uncertainty of Radiated Emission Measurement (18000 MHz ~ 40000 MHz)

| | |
|---|-------|
| Measuring Uncertainty for a Level of Confidence of 95% (U = 2Uc(y)) | 5.0dB |
|---|-------|



Appendix A. Conducted Test Results

Bluetooth Low Energy

| | | | | |
|----------------|----------|--------------------|-------|----|
| Test Engineer: | Aly Cao | Temperature: | 20~26 | °C |
| Test Date: | 2020/5/1 | Relative Humidity: | 40~51 | % |

TEST RESULTS DATA
6dB and 99% Occupied Bandwidth

| Mod. | Data Rate | N _{Tx} | CH. | Freq. (MHz) | 99% Occupied BW (MHz) | 6dB BW (MHz) | 6dB BW Limit (MHz) | Pass/Fail |
|------|-----------|-----------------|-----|-------------|-----------------------|--------------|--------------------|-----------|
| BLE | 1Mbps | 1 | 0 | 2402 | 1.03 | 0.67 | 0.50 | Pass |
| BLE | 1Mbps | 1 | 19 | 2440 | 1.03 | 0.66 | 0.50 | Pass |
| BLE | 1Mbps | 1 | 39 | 2480 | 1.03 | 0.66 | 0.50 | Pass |

TEST RESULTS DATA
Peak Power Table

| Mod. | Data Rate | N _{Tx} | CH. | Freq. (MHz) | Peak Conducted Power (dBm) | Conducted Power Limit (dBm) | DG (dBi) | EIRP Power (dBm) | EIRP Power Limit (dBm) | Pass /Fail |
|------|-----------|-----------------|-----|-------------|----------------------------|-----------------------------|----------|------------------|------------------------|------------|
| BLE | 1Mbps | 1 | 0 | 2402 | 7.21 | 30.00 | 0.50 | 7.71 | 36.00 | Pass |
| BLE | 1Mbps | 1 | 19 | 2440 | 7.93 | 30.00 | 0.50 | 8.43 | 36.00 | Pass |
| BLE | 1Mbps | 1 | 39 | 2480 | 7.72 | 30.00 | 0.50 | 8.22 | 36.00 | Pass |

TEST RESULTS DATA
Average Power Table
(Reporting Only)

| Mod. | Data Rate | N _{Tx} | CH. | Freq. (MHz) | Duty Factor (dB) | Average Conducted Power (dBm) |
|------|-----------|-----------------|-----|-------------|------------------|-------------------------------|
| BLE | 1Mbps | 1 | 0 | 2402 | 2.04 | 6.98 |
| BLE | 1Mbps | 1 | 19 | 2440 | 2.04 | 7.69 |
| BLE | 1Mbps | 1 | 39 | 2480 | 2.04 | 7.51 |

TEST RESULTS DATA
Peak Power Density

| Mod. | Data Rate | N _{Tx} | CH. | Freq. (MHz) | Peak PSD (dBm /100kHz) | Peak PSD (dBm /3kHz) | DG (dBi) | Peak PSD Limit (dBm /3kHz) | Pass/Fail |
|------|-----------|-----------------|-----|-------------|------------------------|----------------------|----------|----------------------------|-----------|
| BLE | 1Mbps | 1 | 0 | 2402 | 6.21 | -8.43 | 0.50 | 8.00 | Pass |
| BLE | 1Mbps | 1 | 19 | 2440 | 7.11 | -7.46 | 0.50 | 8.00 | Pass |
| BLE | 1Mbps | 1 | 39 | 2480 | 6.82 | -7.75 | 0.50 | 8.00 | Pass |

Note: PSD (dBm/ 100kHz) is a reference level used for Conducted Band Edges and Conducted Spurious Emission 20dBc limit.



Appendix B. AC Conducted Emission Test Results

| | | | |
|-----------------|---|---------------------|-------------|
| Test Engineer : | Amos Zhang | Temperature : | 25.3~26.2°C |
| | | Relative Humidity : | 38~40% |
| Test Voltage : | 120Vac / 60Hz | Phase : | Line |
| Remark : | All emissions not reported here are more than 10 dB below the prescribed limit. | | |

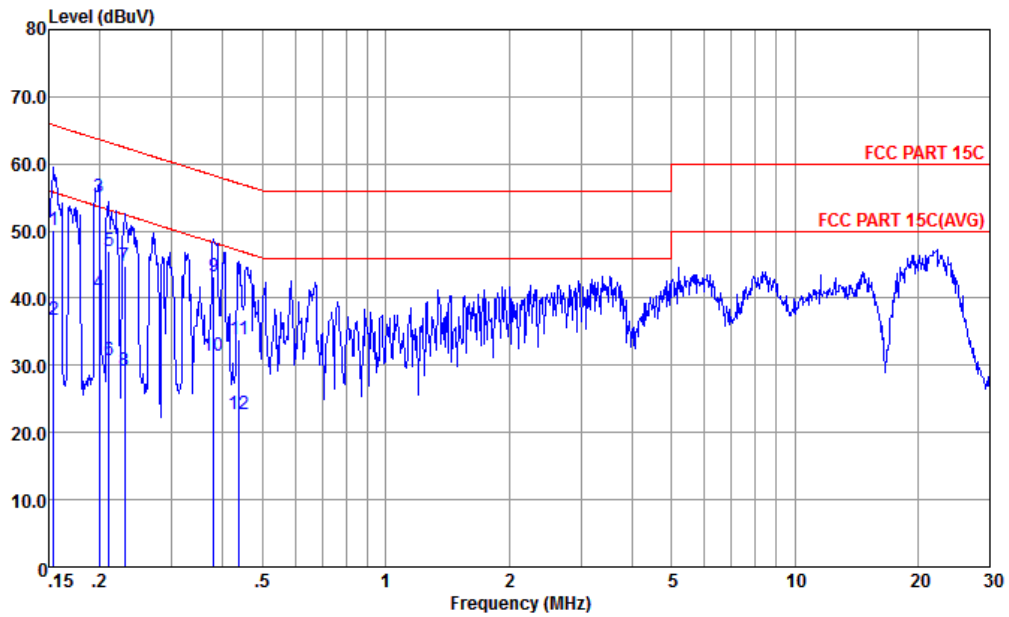

Site : CO01-KS
Condition : FCC PART 15C LISN-L-191028-060105 LINE

| | Freq | Level | Over | Limit | Read | LISN | Cable | Remark |
|-----|-------|-------|--------|-------|-------|--------|-------|---------|
| | MHz | dBuV | Limit | Line | Level | Factor | Loss | |
| | | | dB | dBuV | dBuV | dB | dB | |
| 1 | 0.154 | 50.10 | -15.68 | 65.78 | 39.60 | 0.03 | 10.47 | QP |
| 2 | 0.154 | 36.80 | -18.98 | 55.78 | 26.30 | 0.03 | 10.47 | Average |
| 3 * | 0.200 | 55.01 | -8.61 | 63.62 | 44.61 | 0.04 | 10.36 | QP |
| 4 | 0.200 | 40.70 | -12.92 | 53.62 | 30.30 | 0.04 | 10.36 | Average |
| 5 | 0.211 | 47.00 | -16.18 | 63.18 | 36.60 | 0.04 | 10.36 | QP |
| 6 | 0.211 | 30.70 | -22.48 | 53.18 | 20.30 | 0.04 | 10.36 | Average |
| 7 | 0.230 | 44.89 | -17.55 | 62.44 | 34.51 | 0.04 | 10.34 | QP |
| 8 | 0.230 | 29.29 | -23.15 | 52.44 | 18.91 | 0.04 | 10.34 | Average |
| 9 | 0.379 | 43.13 | -15.17 | 58.30 | 32.81 | 0.05 | 10.27 | QP |
| 10 | 0.379 | 31.53 | -16.77 | 48.30 | 21.21 | 0.05 | 10.27 | Average |
| 11 | 0.437 | 33.91 | -23.20 | 57.11 | 23.60 | 0.06 | 10.25 | QP |
| 12 | 0.437 | 22.81 | -24.30 | 47.11 | 12.50 | 0.06 | 10.25 | Average |



| | | | |
|-----------------|---|---------------------|-------------|
| Test Engineer : | Amos Zhang | Temperature : | 25.3~26.2°C |
| | | Relative Humidity : | 38~40% |
| Test Voltage : | 120Vac / 60Hz | Phase : | Neutral |
| Remark : | All emissions not reported here are more than 10 dB below the prescribed limit. | | |

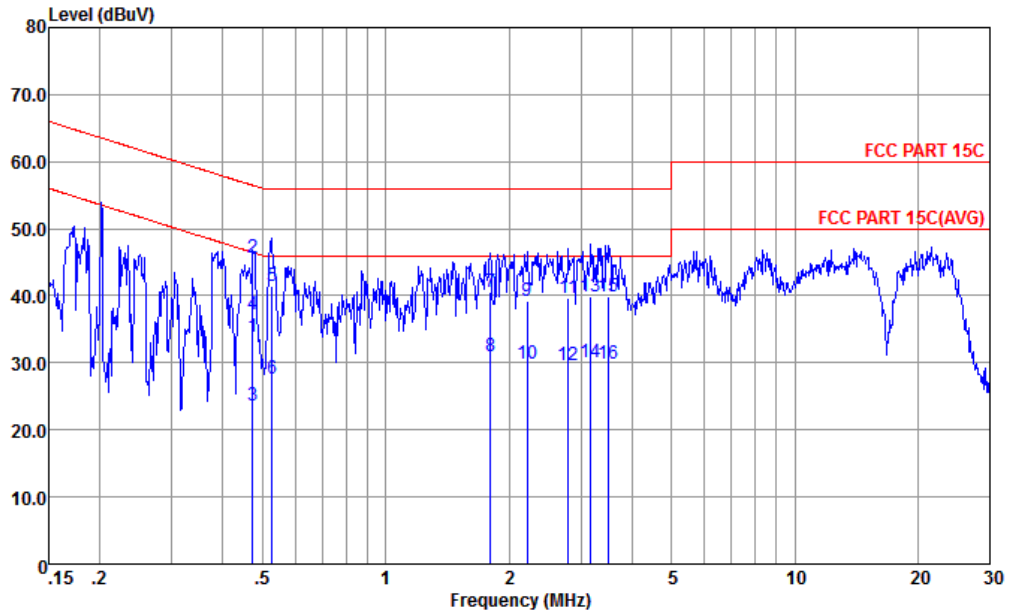

Site : CO01-KS
 Condition : FCC PART 15C LISN-N-191028-060105 NEUTRAL

| | Freq | Level | Over | Limit | Read | LISN | Cable | Remark |
|-----|-------|-------|--------|-------|-------|--------|-------|---------|
| | MHz | dBuV | Limit | Line | Level | Factor | Loss | |
| | | | dB | dBuV | dBuV | dB | dB | |
| 1 | 0.474 | 33.94 | -22.51 | 56.45 | 23.60 | 0.10 | 10.24 | QP |
| 2 | 0.474 | 45.64 | -10.81 | 56.45 | 35.30 | 0.10 | 10.24 | QP |
| 3 | 0.474 | 23.64 | -22.81 | 46.45 | 13.30 | 0.10 | 10.24 | Average |
| 4 * | 0.474 | 37.14 | -9.31 | 46.45 | 26.80 | 0.10 | 10.24 | Average |
| 5 | 0.527 | 41.44 | -14.56 | 56.00 | 31.10 | 0.10 | 10.24 | QP |
| 6 | 0.527 | 27.54 | -18.46 | 46.00 | 17.20 | 0.10 | 10.24 | Average |
| 7 | 1.800 | 40.66 | -15.34 | 56.00 | 30.30 | 0.13 | 10.23 | QP |
| 8 | 1.800 | 30.96 | -15.04 | 46.00 | 20.60 | 0.13 | 10.23 | Average |
| 9 | 2.213 | 39.26 | -16.74 | 56.00 | 28.90 | 0.13 | 10.23 | QP |
| 10 | 2.213 | 29.96 | -16.04 | 46.00 | 19.60 | 0.13 | 10.23 | Average |
| 11 | 2.794 | 39.58 | -16.42 | 56.00 | 29.20 | 0.14 | 10.24 | QP |
| 12 | 2.794 | 29.68 | -16.32 | 46.00 | 19.30 | 0.14 | 10.24 | Average |
| 13 | 3.173 | 39.99 | -16.01 | 56.00 | 29.60 | 0.15 | 10.24 | QP |
| 14 | 3.173 | 29.99 | -16.01 | 46.00 | 19.60 | 0.15 | 10.24 | Average |
| 15 | 3.509 | 40.00 | -16.00 | 56.00 | 29.60 | 0.15 | 10.25 | QP |
| 16 | 3.509 | 29.90 | -16.10 | 46.00 | 19.50 | 0.15 | 10.25 | Average |

Note:

- Level(dBμV) = Read Level(dBμV) + LISN Factor(dB) + Cable Loss(dB)
- Over Limit(dB) = Level(dBμV) – Limit Line(dBμV)



Appendix C. Radiated Spurious Emission

2.4GHz 2400~2483.5MHz

BLE (Band Edge @ 3m)

| BLE | Note | Frequency | Level | Over Limit | Limit Line | Read Level | Antenna Factor | Cable Loss | Preamp Factor | Ant Pos | Table Pos | Peak Avg. | Pol. |
|-------------------------|---|-----------|------------|------------|------------|------------|----------------|------------|---------------|---------|-----------|-----------|---------|
| | | (MHz) | (dBμV/m) | (dB) | (dBμV/m) | (dBμV) | (dB/m) | (dB) | (dB) | (cm) | (deg) | (P/A) | (H/V) |
| BLE CH 00 2402MHz | | 2388.91 | 55.13 | -18.87 | 74 | 48.54 | 31.2 | 7.04 | 31.65 | 283 | 109 | P | H |
| | | 2387.35 | 44.98 | -9.02 | 54 | 38.39 | 31.2 | 7.04 | 31.65 | 283 | 109 | A | H |
| | * | 2402 | 102.1 | - | - | 95.51 | 31.2 | 7.04 | 31.65 | 283 | 109 | P | H |
| | * | 2402 | 101.68 | - | - | 95.09 | 31.2 | 7.04 | 31.65 | 283 | 109 | A | H |
| | | 2363.17 | 54.82 | -19.18 | 74 | 48.32 | 31.18 | 6.98 | 31.66 | 352 | 69 | P | V |
| | | 2383.97 | 44.97 | -9.03 | 54 | 38.42 | 31.19 | 7.01 | 31.65 | 352 | 69 | A | V |
| | * | 2402 | 98.3 | - | - | 91.71 | 31.2 | 7.04 | 31.65 | 352 | 69 | P | V |
| | * | 2402 | 97.76 | - | - | 91.17 | 31.2 | 7.04 | 31.65 | 352 | 69 | A | V |
| BLE CH 39 2480MHz | | 2480 | 101.98 | - | - | 94.63 | 31.77 | 7.16 | 31.58 | 173 | 105 | P | H |
| | | 2480 | 101.65 | - | - | 94.3 | 31.77 | 7.16 | 31.58 | 173 | 105 | A | H |
| | | 2483.74 | 58.59 | -15.41 | 74 | 51.24 | 31.77 | 7.16 | 31.58 | 173 | 105 | P | H |
| | | 2483.5 | 48.09 | -5.91 | 54 | 40.74 | 31.77 | 7.16 | 31.58 | 173 | 105 | A | H |
| | | 2480 | 99.28 | - | - | 91.93 | 31.77 | 7.16 | 31.58 | 370 | 66 | P | V |
| | | 2480 | 98.75 | - | - | 91.4 | 31.77 | 7.16 | 31.58 | 370 | 66 | A | V |
| | | 2483.5 | 57.37 | -16.63 | 74 | 50.02 | 31.77 | 7.16 | 31.58 | 370 | 66 | P | V |
| | | 2483.5 | 46.99 | -7.01 | 54 | 39.64 | 31.77 | 7.16 | 31.58 | 370 | 66 | A | V |
| Remark | 1. No other spurious found. 2. All results are PASS against Peak and Average limit line. | | | | | | | | | | | | |



2.4GHz 2400~2483.5MHz
BLE (Harmonic @ 3m)

Table with 14 columns: BLE, Note, Frequency (MHz), Level (dBµV/m), Over Limit (dB), Limit Line (dBµV/m), Read Level (dBµV), Antenna Factor (dB/m), Cable Loss (dB), Preamp Factor (dB), Ant Pos (cm), Table Pos (deg), Peak Avg. (P/A), Pol. (H/V). Rows include data for BLE CH 00 (2402MHz) and BLE CH 19 (2440MHz) and BLE CH 39 (2480MHz).



Emission below 1GHz

2.4GHz BLE (LF)

| BLE | Note | Frequency | Level | Over | Limit | Read | Antenna | Cable | Preamp | Ant | Table | Peak | Pol. |
|---------------------|------|-----------|------------|--------|------------|----------|----------|--------|--------|--------|---------|---------|---------|
| | | (MHz) | (dBμV/m) | (dB) | (dBμV/m) | (dBμV) | (dB/m) | (dB) | (dB) | (cm) | (deg) | (P/A) | (H/V) |
| 2.4GHz BLE LF | | 35.82 | 20.36 | -19.64 | 40 | 37.94 | 21.62 | 0.69 | 39.89 | - | - | P | H |
| | | 177.44 | 27.83 | -15.67 | 43.5 | 49.96 | 15.26 | 1.47 | 38.86 | - | - | P | H |
| | | 204.6 | 31.49 | -12.01 | 43.5 | 53.21 | 15.19 | 1.59 | 38.5 | 100 | 360 | P | H |
| | | 312.27 | 29.26 | -16.74 | 46 | 45.72 | 19.62 | 1.94 | 38.02 | - | - | P | H |
| | | 848.68 | 28.95 | -17.05 | 46 | 29.52 | 29.28 | 3.22 | 33.07 | - | - | P | H |
| | | 980.6 | 29.61 | -24.39 | 54 | 27.47 | 30.25 | 3.46 | 31.57 | - | - | P | H |
| | | 47.46 | 28.16 | -11.84 | 40 | 51.39 | 15.9 | 0.79 | 39.92 | 100 | 360 | P | V |
| | | 60.07 | 26.23 | -13.77 | 40 | 53 | 12.3 | 0.88 | 39.95 | - | - | P | V |
| | | 155.13 | 30.03 | -13.47 | 43.5 | 50.98 | 16.9 | 1.37 | 39.22 | - | - | P | V |
| | | 202.66 | 26.79 | -16.71 | 43.5 | 48.55 | 15.15 | 1.59 | 38.5 | - | - | P | V |
| | | 852.56 | 28.57 | -17.43 | 46 | 29.09 | 29.29 | 3.22 | 33.03 | - | - | P | V |
| | | 991.27 | 28.86 | -25.14 | 54 | 26.43 | 30.39 | 3.48 | 31.44 | - | - | P | V |

| | |
|---------------|---|
| Remark | 1. No other spurious found. |
| | 2. All results are PASS against limit line. |



Note symbol

| | |
|-----|--|
| * | Fundamental Frequency which can be ignored. However, the level of any unwanted emissions shall not exceed the level of the fundamental frequency. |
| ! | Test result is over limit line. |
| P/A | Peak or Average |
| H/V | Horizontal or Vertical |



A calculation example for radiated spurious emission is shown as below:

| WIFI | Note | Frequency | Level | Over | Limit | Read | Antenna | Cable | Preamp | Ant | Table | Peak | Pol. |
|---------|------|-----------|------------|--------|------------|----------|----------|--------|--------|--------|---------|---------|---------|
| Ant. | | | | Limit | Line | Level | Factor | Loss | Factor | Pos | Pos | Avg. | |
| 1+2 | | (MHz) | (dBμV/m) | (dB) | (dBμV/m) | (dBμV) | (dB/m) | (dB) | (dB) | (cm) | (deg) | (P/A) | (H/V) |
| 802.11b | | 2390 | 55.45 | -18.55 | 74 | 54.51 | 32.22 | 4.58 | 35.86 | 103 | 308 | P | H |
| CH 01 | | | | | | | | | | | | | |
| 2412MHz | | 2390 | 43.54 | -10.46 | 54 | 42.6 | 32.22 | 4.58 | 35.86 | 103 | 308 | A | H |

- Level(dBμV/m) =
Antenna Factor(dB/m) + Cable Loss(dB) + Read Level(dBμV) - Preamp Factor(dB)
- Over Limit(dB) = Level(dBμV/m) – Limit Line(dBμV/m)

For Peak Limit @ 2390MHz:

- Level(dBμV/m)
= Antenna Factor(dB/m) + Cable Loss(dB) + Read Level(dBμV) - Preamp Factor(dB)
= 32.22(dB/m) + 4.58(dB) + 54.51(dBμV) – 35.86 (dB)
= 55.45 (dBμV/m)
- Over Limit(dB)
= Level(dBμV/m) – Limit Line(dBμV/m)
= 55.45(dBμV/m) – 74(dBμV/m)
= -18.55(dB)

For Average Limit @ 2390MHz:

- Level(dBμV/m)
= Antenna Factor(dB/m) + Cable Loss(dB) + Read Level(dBμV) - Preamp Factor(dB)
= 32.22(dB/m) + 4.58(dB) + 42.6(dBμV) – 35.86 (dB)
= 43.54 (dBμV/m)
- Over Limit(dB)
= Level(dBμV/m) – Limit Line(dBμV/m)
= 43.54(dBμV/m) – 54(dBμV/m)
= -10.46(dB)

Both peak and average measured complies with the limit line, so test result is “PASS”.



Appendix D. Duty Cycle Plots

| Band | Duty Cycle(%) | T(ms) | 1/T(kHz) | VBW Setting |
|---------------|---------------|-------|----------|-------------|
| Bluetooth -LE | 62.50 | 0.391 | 2.556 | 2.7kHz |

Bluetooth - LE

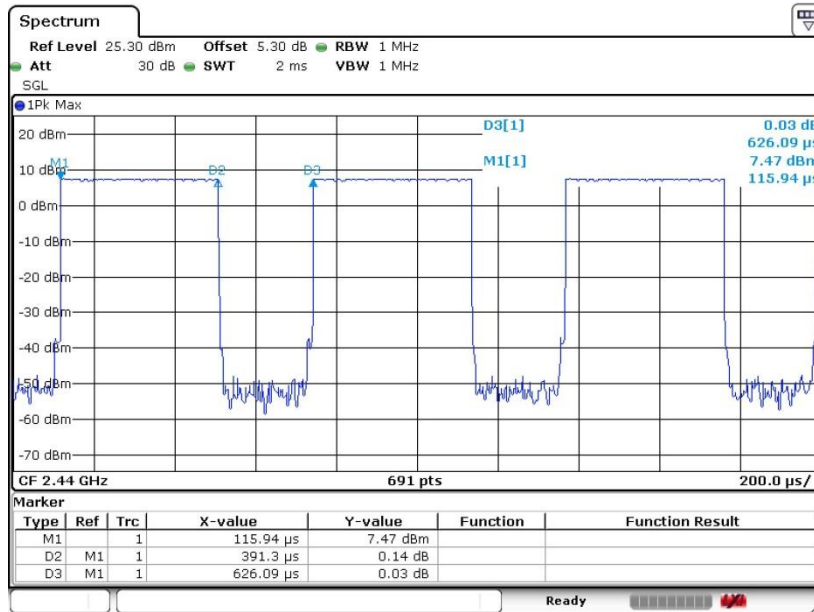

Date: 23.APR.2020 12:35:10