



HEARING AID COMPATIBILITY RF EMISSIONS TEST REPORT

FCC ID : IHDT56ZD4
Equipment : Mobile Cellular Phone
Brand Name : Motorola
Model Name : XT2093-3, XT2093DL, XT2093-4, XT2093-2, XT2093-2PP
M-Rating : M3
Applicant : Motorola Mobility LLC
222 W,Merchandise Mart Plaza, Chicago IL 60654 USA
Manufacturer : Motorola Mobility LLC
222 W,Merchandise Mart Plaza, Chicago IL 60654 USA
Standard : FCC 47 CFR §20.19
ANSI C63.19-2011

The product was received on Aug. 07, 2020 and completed on Aug. 29, 2020. We, Sporton International (Kunshan) Inc., would like to declare that the tested sample has been evaluated in accordance with the test procedures and has been in compliance with the applicable technical standards.

The test results in this report apply exclusively to the tested model / sample. Without written approval of Sporton International (Kunshan) Inc., the test report shall not be reproduced except in full.

Rose Wang

Reviewed by: Rose Wang / Supervisor

Kat Yin

Approved by: Kat Yin / Manager



Sporton International (Kunshan) Inc.

**No. 1098, Pengxi North Road, Kunshan Economic Development Zone Jiangsu Province 215300
People's Republic of China**



Table of Contents

1. General Information..... 5
2. Testing Location..... 6
3. Applied Standards 6
4. RF Audio Interference Level..... 6
5. Air Interface and Operating Mode..... 7
6. Measurement System Specification 8
 6.1 E-Field Probe System..... 8
 6.2 Data Storage and Evaluation..... 9
7. RF Emissions Test Procedure.....10
8. Test Equipment List13
9. Measurement System Validation14
10. Modulation Interference Factor.....15
11. Low-power Exemption.....16
12. Conducted RF Output Power (Unit: dBm).....18
13. HAC RF Emission Test Results.....19
14. Uncertainty Assessment20
15. References.....22

Appendix A. Plots of System Performance Check
Appendix B. Plots of RF Emission Measurement
Appendix C. DASYS Calibration Certificate
Appendix D. Test Setup Photos



History of this test report

Report No.	Version	Description	Issued Date
HA080709A	Rev. 01	Initial issue of report	Sep. 21, 2020



1. General Information

Product Feature & Specification	
Applicant Name	Motorola Mobility LLC
Equipment Name	Mobile Cellular Phone
Brand Name	Motorola
Model Name	XT2093-3, XT2093DL, XT2093-4, XT2093-2, XT2093-2PP
IMEI Code	355567110009916
FCC ID	IHDT56ZD4
HW	DVT2
SW	QZA30.32
EUT Stage	Identical Prototype
Date Tested	2020/8/29
Frequency Band	GSM850: 824.2 MHz ~ 848.8 MHz GSM1900: 1850.2 MHz ~ 1909.8 MHz WCDMA Band II: 1852.4 MHz ~ 1907.6 MHz WCDMA Band IV: 1712.4 MHz ~ 1752.6 MHz WCDMA Band V: 826.4 MHz ~ 846.6 MHz CDMA2000 BC0: 824.7 MHz ~ 848.31 MHz CDMA 2000 BC1: 1851.25 MHz ~ 1908.75 MHz CDMA 2000 BC10: 817.9 MHz ~ 823.1 MHz LTE Band 2: 1850.7 MHz ~ 1909.3 MHz LTE Band 4: 1710.7 MHz ~ 1754.3 MHz LTE Band 5: 824.7 MHz ~ 848.3 MHz LTE Band 7: 2502.5 MHz ~ 2567.5 MHz LTE Band 12: 699.7 MHz ~ 715.3 MHz LTE Band 13: 779.5 MHz ~ 784.5 MHz LTE Band 17: 706.5 MHz ~ 713.5 MHz LTE Band 25: 1850.7 MHz ~ 1914.3 MHz LTE Band 26: 814.7 MHz ~ 848.3 MHz LTE Band 38: 2572.5 MHz ~ 2617.5 MHz LTE Band 41: 2498.5 MHz ~ 2687.5 MHz LTE Band 66: 1710.7 MHz ~ 1779.3 MHz LTE Band 71: 665.5 MHz ~ 695.5 MHz WLAN 2.4GHz Band: 2412 MHz ~ 2462 MHz WLAN 5.2GHz Band: 5180 MHz ~ 5240 MHz WLAN 5.3GHz Band: 5260 MHz ~ 5320 MHz WLAN 5.5GHz Band: 5500 MHz ~ 5720 MHz WLAN 5.8GHz Band: 5745 MHz ~ 5825 MHz Bluetooth: 2402 MHz ~ 2480 MHz
Mode	GSM/GPRS/EGPRS AMR / RMC 12.2Kbps HSDPA HSUPA DC-HSDPA HSPA+ (16QAM uplink is not supported) CDMA2000 : 1xRTT/1xEv-Do(Rel.0)/1xEv-Do(Rev.A) LTE: QPSK, 16QAM, 64QAM WLAN 2.4GHz : 802.11b/g/n HT20 WLAN 5GHz : 802.11a/n/ac HT20/HT40/VHT20/VHT40/VHT80 Bluetooth BR/EDR/LE



2. Testing Location

Sporton International (Kunshan) Inc. is accredited to ISO/IEC 17025:2017 by American Association for Laboratory Accreditation with Certificate Number 5145.02.

Table with 3 columns: Test Firm, Test Site Location, and Test Site No. (with sub-columns for FCC Designation No. and FCC Test Firm Registration No.).

3. Applied Standards

- FCC CFR47 Part 20.19
ANSI C63.19-2011
FCC KDB 285076 D01 HAC Guidance v05
FCC KDB 285076 D02 T Coil testing v03
FCC KDB 285076 D03 HAC FAQ v01

4. RF Audio Interference Level

FCC wireless hearing aid compatibility rules ensure that consumers with hearing loss are able to access wireless communications services through a wide selection of handsets without experiencing disabling radio frequency (RF) interference or other technical obstacles.

To define and measure the hearing aid compatibility of handsets, in CFR47 part 20.19 ANSI C63.19 is referenced. A handset is considered hearing aid-compatible for acoustic coupling if it meets a rating of at least M3 under ANSI C63.19, and A handset is considered hearing aid compatible for inductive coupling if it meets a rating of at least T3. According to ANSI C63.19 2011 version, for acoustic coupling, the RF electric field emissions of wireless communication devices should be measured and rated according to the emission level as below.

Table 5.1: Telephone near-field categories in linear units. Columns: Emission Categories, E-field emissions (<960Mhz, >960Mhz). Rows: M1, M2, M3, M4.

Table 5.1 Telephone near-field categories in linear units



5. Air Interface and Operating Mode

Air Interface	Band MHz	Type	C63.19 Tested	Simultaneous Transmitter	Name of Voice Service	Power Reduction
GSM	GSM850	VO	Yes	WLAN, BT	CMRS Voice	No
	GSM1900			WLAN, BT		No
	EDGE850	VD	Yes	WLAN, BT	Google Duo	No
	EDGE1900			WLAN, BT		
WCDMA	850	VO	No ⁽¹⁾	WLAN, BT	CMRS Voice	No
	1750			WLAN, BT		No
	1900			WLAN, BT		No
	HSPA	VD	No ⁽¹⁾	WLAN, BT	Google Duo	No
CDMA	BC0	VO	Yes	WLAN, BT	CMRS Voice	No
	BC1			WLAN, BT		No
	BC10			WLAN, BT		No
	EVDO	VD	No ⁽¹⁾	WLAN, BT	Google Duo	No
LTE (FDD)	Band 2	VD	No ⁽¹⁾	WLAN, BT	VoLTE / Google Duo	No
	Band 4			WLAN, BT		No
	Band 5			WLAN, BT		No
	Band 7			WLAN, BT		No
	Band 12			WLAN, BT		No
	Band 13			WLAN, BT		No
	Band 17			WLAN, BT		No
	Band 25			WLAN, BT		No
	Band 26			WLAN, BT		No
	Band 66			WLAN, BT		No
Band 71	WLAN, BT	No				
LTE (TDD)	Band 38	VD	Yes	WLAN, BT	VoLTE / Google Duo	No
	Band 41			WLAN, BT		No
Wi-Fi	2450	VD	No ⁽¹⁾	GSM,CDMA,WCDMA,LTE	VoWiFi / Google Duo	No
	5200			GSM,CDMA,WCDMA,LTE		No
	5300			GSM,CDMA,WCDMA,LTE		No
	5500			GSM,CDMA,WCDMA,LTE		No
	5800			GSM,CDMA,WCDMA,LTE		No
BT	2450	DT	No	GSM,CDMA,WCDMA,LTE	NA	No

Type Transport:
 VO= Voice only
 DT= Digital Transport only (no voice)
 VD= CMRS and IP Voice Service over Digital Transport

Remark:

- The air interface is exempted from testing by low power exemption that its average antenna input power plus its MIF is ≤17 dBm, and is rated as M4.
- The device have similar frequency in some LTE bands: LTE B 38/41, since the supported frequency spans for the smaller LTE bands are completely cover by the larger LTE bands, therefore, only larger LTE bands were required to be tested for hearing-aid compliance.
- According to ANSI C63.19 2011 -version, for the air interface technology of a device is exempt from testing whose peak antenna input power, averaged over intervals ≤50 μs, is ≤23 dBm. An RF air interface technology that is exempted from testing shall be rated as M4.

6. Measurement System Specification

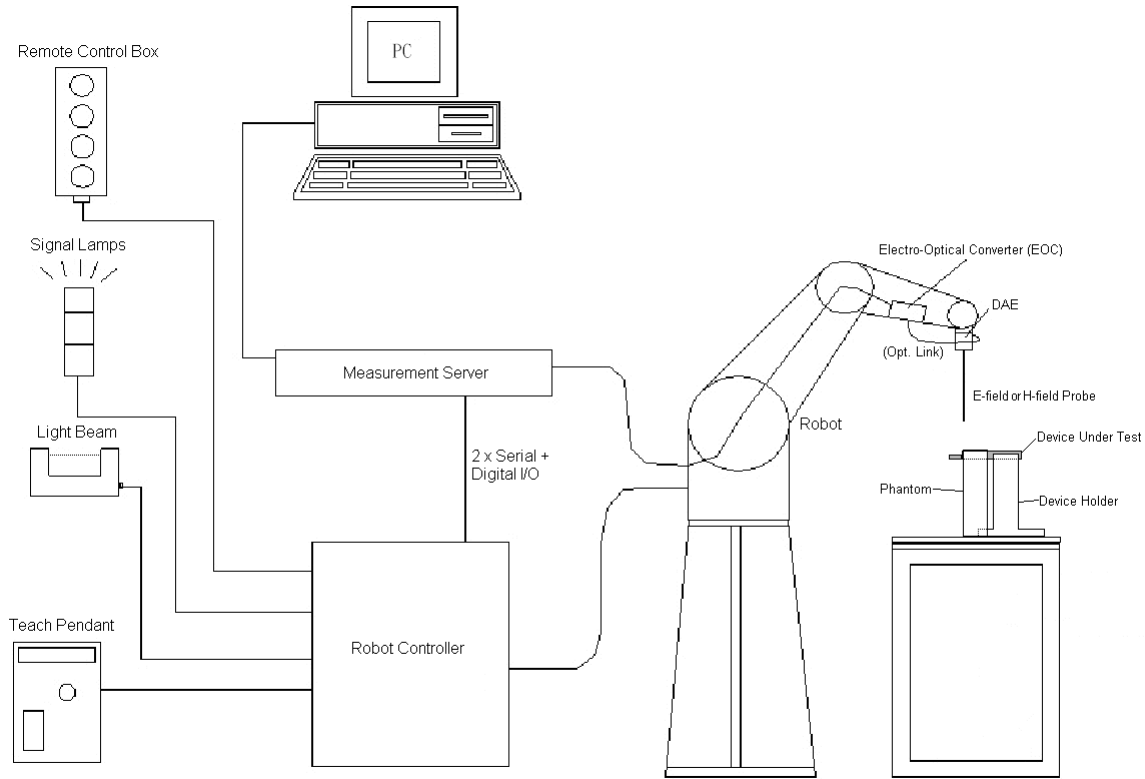

Fig 5.1 System Configurations

6.1 E-Field Probe System

E-Field Probe Specification

<ER3DV6>

Construction	One dipole parallel, two dipoles normal to probe axis Built-in shielding against static charges
Calibration	In air from 100 MHz to 3.0 GHz (absolute accuracy $\pm 6.0\%$, $k=2$)
Frequency	100 MHz to 6 GHz; Linearity: ± 2.0 dB (100 MHz to 3 GHz)
Directivity	± 0.2 dB in air (rotation around probe axis) ± 0.4 dB in air (rotation normal to probe axis)
Dynamic Range	2 V/m to 1000 V/m (M3 or better device readings fall well below diode compression point)
Linearity	± 0.2 dB
Dimensions	Overall length: 330 mm (Tip: 16 mm) Tip diameter: 8 mm (Body: 12 mm) Distance from probe tip to dipole centers: 2.5 mm



Fig 5.2 Photo of E-field Probe

Probe Tip Description:

HAC field measurements take place in the close near field with high gradients. Increasing the measuring distance from the source will generally decrease the measured field values (in case of the validation dipole approx. 10% per mm).

6.2 Data Storage and Evaluation

The DASY software stores the assessed data from the data acquisition electronics as raw data (in microvolt readings from the probe sensors), together with all the necessary software parameters for the data evaluation (probe calibration data, and device frequency and modulation data) in measurement files.

Probe parameters :	- Sensitivity	Norm _i , a _{i0} , a _{i1} , a _{i2}
	- Conversion factor	ConvF _i
	- Diode compression point	dcp _i
Device parameters :	- Frequency	f
	- Crest factor	cf
Media parameters :	- Conductivity	σ
	- Density	ρ

The formula for each channel can be given as :

$$V_i = U_i + U_i^2 \cdot \frac{cf}{dcp_i}$$

with V_i = compensated signal of channel i , ($i = x, y, z$)
 U_i = input signal of channel i , ($i = x, y, z$)
 cf = crest factor of exciting field (DASY parameter)
 dcp_i = diode compression point (DASY parameter)

From the compensated input signals, the primary field data for each channel can be evaluated :

$$\text{E-field Probes : } E_i = \sqrt{\frac{V_i}{\text{Norm}_i \cdot \text{ConvF}}}$$

with V_i = compensated signal of channel i , ($i = x, y, z$)
 Norm_i = sensor sensitivity of channel i , ($i = x, y, z$), $\mu\text{V}/(\text{V}/\text{m})^2$ for E-field Probes
 ConvF = sensitivity enhancement in solution
 f = carrier frequency [GHz]
 E_i = electric field strength of channel i in V/m

The RSS value of the field components gives the total field strength (Hermitian magnitude) :

$$E_{\text{tot}} = \sqrt{E_x^2 + E_y^2 + E_z^2}$$

The primary field data are used to calculate the derived field units.



7. RF Emissions Test Procedure

Referenced from ANSI C63.19 -2011 section 5.5.1

- a. Confirm the proper operation of the field probe, probe measurement system, and other instrumentation and the positioning system.
- b. Position the WD in its intended test position.
- c. Set the WD to transmit a fixed and repeatable combination of signal power and modulation characteristic that is representative of the worst case (highest interference potential) encountered in normal use. Transiently occurring start-up, changeover, or termination conditions, or other operations likely to occur less than 1% of the time during normal operation, may be excluded from consideration.
- d. The center sub-grid shall be centered on the T-Coil mode perpendicular measurement point or the acoustic output, as appropriate. Locate the field probe at the initial test position in the 50 mm by 50 mm grid, which is contained in the measurement plane, refer to illustrated in Figure 8.2. If the field alignment method is used, align the probe for maximum field reception.
- e. Record the reading at the output of the measurement system.
- f. Scan the entire 50 mm by 50 mm region in equality spaced increments and record the reading at each measurement point, The distance between measurement points shall be sufficient to assure the identification of the maximum reading.
- g. Identify the five contiguous sub-grids around the center sub-grid whose maximum reading is the lowest of all available choices. This eliminates the three sub-grids with the maximum readings. Thus, the six areas to be used to determine the WD's highest emissions are identified.
- h. Identify the maximum reading within the non-excluded sub-grids identified in step g).
- i. Indirect measurement method
- j. The RF audio interference level in dB (V/m) is obtained by adding the MIF (in dB) to the maximum steady-state rms field-strength reading, in dB (V/m)
- k. Compare this RF audio interference level with the categories in ANSI C63.19-2011 clause 8 and record the resulting WD category rating.
- l. For the T-Coil perpendicular measurement location is ≥ 5.0 mm from the center of the acoustic output, then two different 50 mm by 50 mm areas may need to be scanned, the first for the microphone mode assessment and the second for the T-Coil assessment.
- m. The second for the T-Coil assessment, with the grid shifted so that it is centered on the perpendicular measurement point. Record the WD category rating.

Test Instructions

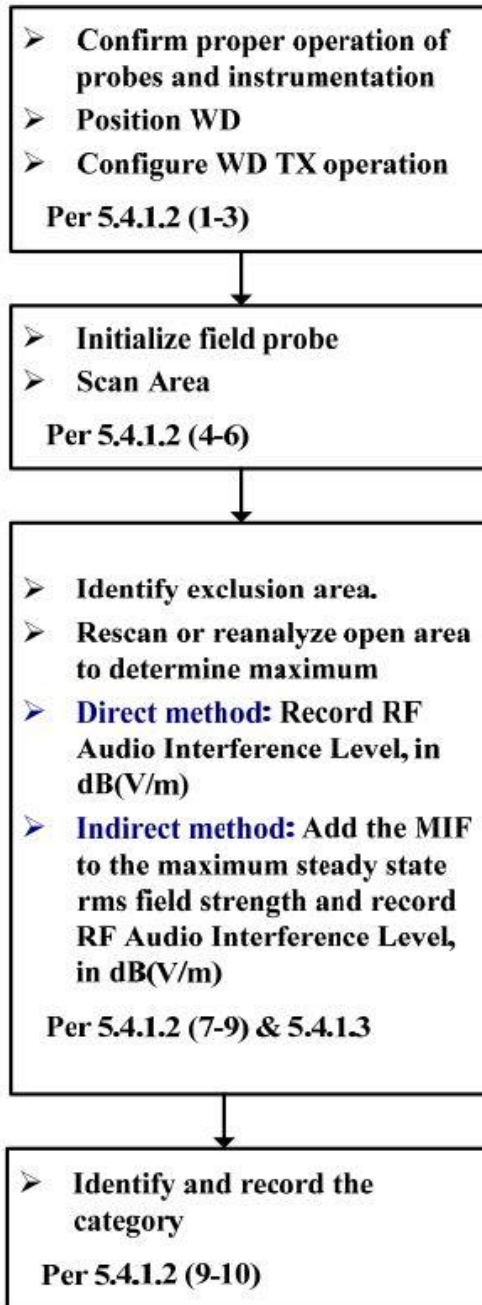

Figure 8.1 RF Emissions Flow Chart

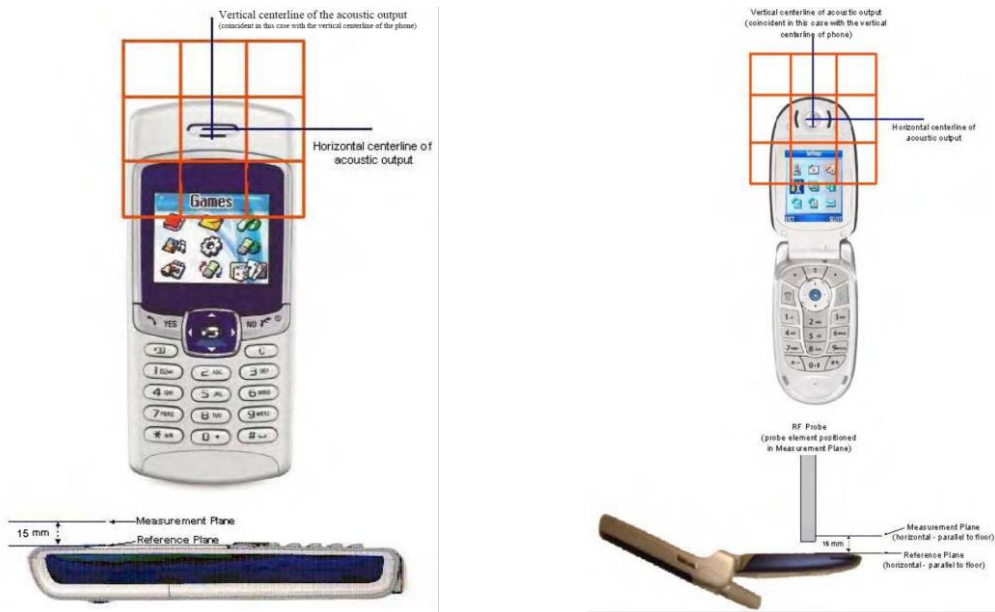

Fig 8.2 EUT reference and plane for HAC RF emission measurements

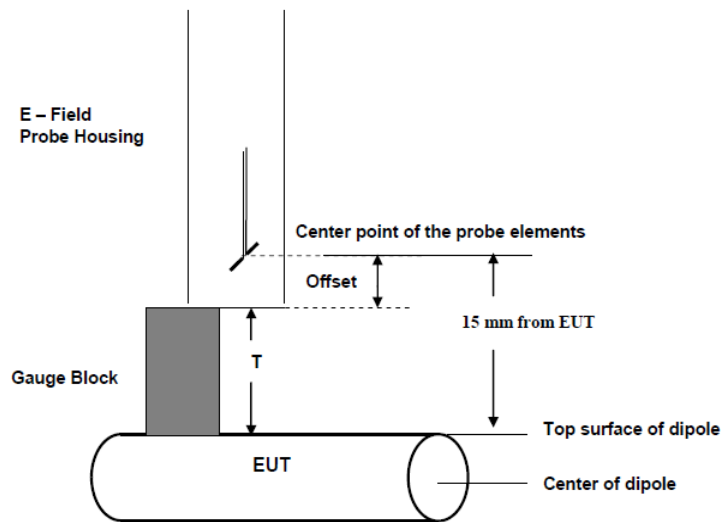

Fig. 8.3 Gauge block with E-field probe

**8. Test Equipment List**

Manufacturer	Name of Equipment	Type/Model	Serial Number	Calibration	
				Last Cal.	Due Date
SPEAG	835MHz Calibration Dipole	CD835V3	1045	2018/9/19	2021/9/16
SPEAG	1880MHz Calibration Dipole	CD1880V3	1038	2018/9/19	2021/9/16
SPEAG	2600Mhz Calibration Dipole	CD2600V3	1010	2019/3/14	2022/3/12
SPEAG	Data Acquisition Electronics	DAE4	690	2020/3/26	2021/3/25
SPEAG	Isotropic E-Field Probe	EF3DV3	4050	2020/1/24	2021/1/23
Anritsu	Radio Communication Analyzer	MT8821C	6201432831	2020/4/16	2021/4/15
Agilent	Wireless Communication Test Set	E5515C	MY52102706	2020/4/16	2021/4/15
Anritsu	Vector Signal Generator	MG3710A	6201682672	2020/1/8	2021/1/7
BONN	POWER AMPLIFIER	BLMA 0830-3	087193A	2020/8/13	2021/8/12
BONN	POWER AMPLIFIER	BLMA 2060-2	087193B	2020/8/1	2021/7/31
Rohde & Schwarz	Power Meter	NRVD	102081	2020/8/14	2021/8/13
Rohde & Schwarz	Power Sensor	NRV-Z5	100538	2020/8/13	2021/8/12
Rohde & Schwarz	Power Sensor	NRV-Z5	100539	2020/8/13	2021/8/12
ARRA	Power Divider	A3200-2	N/A	NCR	NCR
MCL	Attenuation1	BW-S10W5+	N/A	NCR	NCR
MCL	Attenuation2	BW-S10W5+	N/A	NCR	NCR
MCL	Attenuation3	BW-S10W5+	N/A	NCR	NCR
R&S	CBT BLUETOOTH TESTER	CBT	101641	2020/1/8	2021/1/7
EXA	Spectrum Analyzer	FSV7	101631	2020/1/8	2021/1/7
Agilent	Dual Directional Coupler	778D	20500	2020/8/13	2021/8/12
Agilent	Dual Directional Coupler	11691D	MY48151020	2020/8/13	2021/8/12
Testo	Hygrometer	608-H1	1241332088	2020/1/8	2021/1/7

Note:

1. NCR: "No-Calibration Required"
2. Referring to KDB 865664 D01v01r04, the dipole calibration interval can be extended to 3 years with justification. The dipoles are also not physically damaged, or repaired during the interval.
3. The justification data of dipole CD835V3, SN: 1045, CD1880V3, SN: 1038, CD2600V3, SN: 1010 can be found in appendix C. The return loss is < -20dB, within 20% of prior calibration, the impedance is within 5 ohm of prior calibration.

9. Measurement System Validation

Each DASY system is equipped with one or more system validation kits. These units, together with the predefined measurement procedures within the DASY software, enable the user to conduct the system performance check and system validation. System validation kit includes a dipole, tripod holder to fix it underneath the test Arch and a corresponding distance holder.

The system performance check verifies that the system operates within its specifications. System and operator errors can be detected and corrected. It is recommended that the system performance check be performed prior to any usage of the system in order to guarantee reproducible results. The system performance check uses normal HAC measurements in a simplified setup with a well characterized source. This setup was selected to give a high sensitivity to all parameters that might fail or vary over time. The system check does not intend to replace the calibration of the components, but indicates situations where the system uncertainty is exceeded due to drift or failure.

<Test Setup>

1. In the simplified setup for system evaluation, the EUT is replaced by a calibrated dipole and the power source is replaced by a continuous wave which comes from a signal generator.
2. The center point of the probe element(s) is 15mm from the closest surface of the dipole elements.
3. The calibrated dipole must be placed beneath the arch phantom. The equipment setup is shown below:
4. The output power on dipole port must be calibrated to 20dBm (100mW) before dipole is connected.

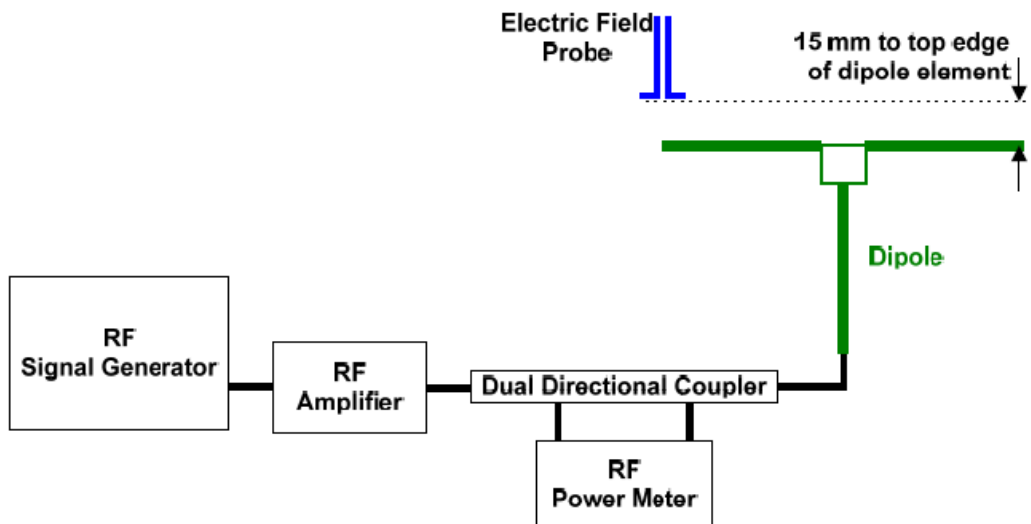

Fig. 7.1 Setup Diagram

<Validation Results>

Comparing to the original E-field value provided by SPEAG, the verification data should be within its specification of 25 %. Table 6.1 shows the target value and measured value. The table below indicates the system performance check can meet the variation criterion and the plots can be referred to appendix A of this report.

$$\text{Deviation} = ((\text{Average E-field Value}) - (\text{Target value})) / (\text{Target value}) * 100\%$$

Frequency (MHz)	Input Power (dBm)	Target Value (V/m)	E-Field 1 (V/m)	E-Field 2 (V/m)	Average Value (V/m)	Deviation (%)	Date
835	20	108.8	110.3	107.5	108.9	0.09	Aug. 29, 2020
1880	20	89.5	87.21	90.87	89.04	-0.51	Aug. 29, 2020
2600	20	84.5	87.12	88.64	87.88	4.00	Aug. 29, 2020



10. Modulation Interference Factor

The HAC Standard ANSI C63.19-2011 defines a new scaling using the Modulation Interference Factor (MIF). For any specific fixed and repeatable modulated signal, a modulation interference factor (MIF, expressed in dB) may be developed that relates its interference potential to its steady-state rms signal level or average power level. This factor is a function only of the audio-frequency amplitude modulation characteristics of the signal and is the same for field-strength and conducted power measurements. It is important to emphasize that the MIF is valid only for a specific repeatable audio-frequency amplitude modulation characteristic. Any change in modulation characteristic requires determination and application of a new MIF

The Modulation Interference factor (MIF, in dB) is added to the measured average E-field (in dBV/m) and converts it to the RF Audio Interference level (in dBV/m). This level considers the audible amplitude modulation components in the RF E-field. CW fields without amplitude modulation are assumed to not interfere with the hearing aid electronics. Modulations without time slots and low fluctuations at low frequencies have low MIF values, TDMA modulations with narrow transmission and repetition rates of few 100 Hz have high MIF values and give similar classifications as ANSI C63.19-2011.

ER3D, EF3D and EU2D E-field probes have a bandwidth <10 kHz and can therefore not evaluate the RF envelope in the full audio band. DASY52 is therefore using the indirect measurement method according to ANSI C63.19-2011 which is the primary method. These near field probes read the averaged E-field measurement. Especially for the new high peak-to-average (PAR) signal types, the probes shall be linearized by PMR calibration in order to not overestimate the field reading. Probe Modulation Response (PMR) calibration linearizes the probe response over its dynamic range for specific modulations which are characterized by their UID and result in an uncertainty specified in the probe calibration certificate. The MIF is characteristic for a given waveform envelope and can be used as a constant conversion factor if the probe has been PMR calibrated.

The evaluation method for the MIF is defined in ANSI C63.19-2011 section D.7. An RMS demodulated RF signal is fed to a spectral filter (similar to an A weighting filter) and forwarded to a temporal filter acting as a quasi-peak detector. The averaged output of these filtering is scaled to a 1 kHz 80% AM signal as reference. MIF measurement requires additional instrumentation and is not well suited for evaluation by the end user with reasonable uncertainty. It may alternatively be determined through analysis and simulation, because it is constant and characteristic for a communication signal. DASY52 uses well-defined signals for PMR calibration. The MIF of these signals has been determined by simulation and it is automatically applied.

The MIF measurement uncertainty is estimated as follows, declared by HAC equipment provider SPEAG, for modulation frequencies from slotted waveforms with fundamental frequency and at least 2 harmonics within 10 kHz:

- 1. 0.2 dB for MIF: -7 to +5 dB
2. 0.5 dB for MIF: -13 to +11 dB
3. 1 dB for MIF: > -20 dB

MIF values applied in this test report were provided by the HAC equipment provider of SPEAG, and the worst values for all air interface are listed below to be determine the Low-power Exemption.

Table with 3 columns: UID, Communication System Name, MIF(dB). Rows include GSM-FDD, EDGE-FDD, UMTS-FDD, CDMA2000, and LTE-FDD/TDD systems with their respective MIF values.



11. Low-power Exemption

<Max Tune-up Limit>

Frequency Band		Average Power (dBm)
GSM	GSM850	33.50
	EDGE850	27.00
	GSM1900	30.50
	EDGE1900	26.00
WCDMA	Band V	24.00
	Band IV	24.00
	Band II	24.00
	HSPA	23.00
CDMA	BC0	25.00
	BC1	25.00
	BC10	25.00
	1xEvDO	25.00
FDD LTE	Band 2	24.00
	Band 4	24.00
	Band 5	24.00
	Band 7	24.00
	Band 12	24.00
	Band 13	24.00
	Band 17	24.00
	Band 25	24.00
	Band 26	24.00
	Band 71	24.00
	Band 66	24.00
TDD LTE	TDD-PC3	25.00
	TDD-PC2	27.00
2.4GHz WLAN	802.11b	16.00
	802.11g	16.00
	802.11n-HT20	16.00
5GHz WLAN	802.11a	18.50
	802.11n-HT20	18.50
	802.11n-HT40	18.50
	802.11ac-VHT20	18.50
	802.11ac-VHT40	18.50
	802.11ac-VHT80	17.00



<Low Power Exemption>

Air Interface	Max Average Antenna Input Power (dBm)	Worst Case MIF (dB)	Power + MIF(dB)	C63.19 test required
GSM850	33.50	3.63	37.13	Yes
EDGE850	27.00	3.75	30.75	Yes ⁽¹⁾
GSM1900	30.50	3.63	34.13	Yes
EDGE1900	26.00	3.75	29.75	Yes ⁽¹⁾
WCDMA	24.00	-25.43	-1.43	No
WCDMA - HSPA	24.00	-20.39	3.61	No
CDMA Full Frame Rate	25.00	-19.71	5.29	No
CDMA 1/8th Frame Rate	25.00	3.26	28.26	Yes
CDMA - EVDO	25.00	-17.67	7.33	No
LTE - FDD	24.00	-9.76	14.24	No
LTE – TDD - PC3	25.00	-1.44	23.56	Yes
LTE – TDD - PC2	27.00	-1.44	25.56	Yes
802.11b	16.00	-2.02	13.98	No
802.11g	16.00	0.12	16.12	No
802.11n-HT20	16.00	-13.44	2.56	No
802.11a	18.50	-3.15	15.35	No
802.11n-HT20	18.50	-13.44	5.06	No
802.11n-HT40	18.50	-13.44	5.06	No
802.11ac-VHT20	18.50	-5.57	12.93	No
802.11ac-VHT40	18.50	-5.57	12.93	No
802.11ac-VHT80	17.00	-5.57	11.43	No

General Note:

- EDGE data modes is not necessary due the GSM Voice mode is the worst case.
- According to ANSI C63.19 2011-version, for the air interface technology of a device is exempt from testing when its average antenna input power plus its MIF is ≤ 17 dBm for any of its operating modes.
- HAC RF rating is M4 for the air interface which meets the low power exemption.
- When the phone is in talking mode and receiver worked, then power reduction will be implemented immediately for WLAN2.4GHz.



12. Conducted RF Output Power (Unit: dBm)

<GSM>

Average Antenna Input Power(dBm)						
Band	GSM850			GSM1900		
Channel	128	189	251	512	661	810
Frequency (MHz)	824.2	836.4	848.8	1850.2	1880.0	1909.8
GSM (GMSK, 1 Tx slot)	31.85	31.98	32.03	29.25	29.28	29.10

<CDMA>

Band	CDMA BC0			CDMA BC1			CDMA BC10		
TX Channel	1013	384	777	25	600	1175	476	580	684
Frequency (MHz)	824.7	836.52	848.31	1851.25	1880	1908.75	817.9	820.5	823.1
1xRTT RC1 SO3, 1/8th Rate	24.23	24.39	24.33	24.01	24.36	24.24	24.00	24.25	24.13

<TDD LTE B38>

BW [MHz]	Modulation	RB Size	RB Offset	Power Low Ch. / Freq.	Power Middle Ch. / Freq.	Power High Ch. / Freq.
Channel				37850	38000	38150
Frequency (MHz)				2580	2595	2610
20	QPSK	1	0	23.22	23.26	23.14

<TDD LTE B41_PC3>

BW [MHz]	Modulation	RB Size	RB Offset	Power Low Ch. / Freq.	Power Low Middle Ch. / Freq.	Power Middle Ch. / Freq.	Power High Middle Ch. / Freq.	Power High Ch. / Freq.
Channel				39750	40185	40620	41055	41490
Frequency (MHz)				2506	2549.5	2593	2636.5	2680
20	QPSK	1	0	24.31	24.34	24.35	24.23	24.34

<TDD LTE B41_PC2>

BW [MHz]	Modulation	RB Size	RB Offset	Power Low Ch. / Freq.	Power Low Middle Ch. / Freq.	Power Middle Ch. / Freq.	Power High Middle Ch. / Freq.	Power High Ch. / Freq.
Channel				39750	40185	40620	41055	41490
Frequency (MHz)				2506	2549.5	2593	2636.5	2680
20	QPSK	1	0	25.46	25.55	25.68	25.34	25.66



13. HAC RF Emission Test Results

Plot No.	Air Interface	Mode	Channel	Average Antenna Input Power (dBm)	MIF	E-Field (dBV/m)	Margin to FCC M3 limit (dB)	E-Field M Rating
1	GSM850	Voice	128	31.85	3.63	38.59	6.41	M4
2	GSM850	Voice	189	31.98	3.63	38.11	6.89	M4
3	GSM850	Voice	251	32.03	3.63	37.22	7.78	M4
4	GSM1900	Voice	512	29.25	3.63	26.63	8.37	M4
5	GSM1900	Voice	661	29.28	3.63	27.09	7.91	M4
6	GSM1900	Voice	810	29.10	3.63	30.48	4.52	M3
7	CDMA BC0	1xRTT, RC1 SO3, 1/8th Rate	1013	24.23	3.26	25.67	9.33	M4
8	CDMA BC0	1xRTT, RC1 SO3, 1/8th Rate	384	24.39	3.26	26.60	8.40	M4
9	CDMA BC0	1xRTT, RC1 SO3, 1/8th Rate	777	24.33	3.26	26.85	8.15	M4
10	CDMA BC1	1xRTT, RC1 SO3, 1/8th Rate	25	24.01	3.26	18.45	16.55	M4
11	CDMA BC1	1xRTT, RC1 SO3, 1/8th Rate	600	24.36	3.26	16.96	18.04	M4
12	CDMA BC1	1xRTT, RC1 SO3, 1/8th Rate	1175	24.24	3.26	15.09	19.91	M4
13	CDMA BC10	1xRTT, RC1 SO3, 1/8th Rate	476	24.00	3.26	28.32	6.68	M4
14	CDMA BC10	1xRTT, RC1 SO3, 1/8th Rate	580	24.25	3.26	25.61	9.39	M4
15	CDMA BC10	1xRTT, RC1 SO3, 1/8th Rate	684	24.13	3.26	26.96	8.04	M4
16	LTE Band41 PC3	20M_QPSK_1_0	39750	24.31	-1.62	24.53	10.47	M4
17	LTE Band41 PC3	20M_QPSK_1_0	40185	24.34	-1.62	25.89	9.11	M4
18	LTE Band41 PC3	20M_QPSK_1_0	40620	24.35	-1.62	26.07	8.93	M4
19	LTE Band41 PC3	20M_QPSK_1_0	41055	24.23	-1.62	26.17	8.83	M4
20	LTE Band41 PC3	20M_QPSK_1_0	41490	24.34	-1.62	26.67	8.33	M4
21	LTE Band41 PC2	20M_QPSK_1_0	39750	25.46	-1.62	24.76	10.24	M4
22	LTE Band41 PC2	20M_QPSK_1_0	40185	25.55	-1.62	24.77	10.23	M4
23	LTE Band41 PC2	20M_QPSK_1_0	40620	25.68	-1.62	24.75	10.25	M4
24	LTE Band41 PC2	20M_QPSK_1_0	41055	25.34	-1.62	24.70	10.30	M4
25	LTE Band41 PC2	20M_QPSK_1_0	41490	25.66	-1.62	25.73	9.27	M4

Remark:

1. The HAC measurement system applies MIF value onto the measured RMS E-field, which is indirect method in ANSI C63.19 2011 version, and reports the RF audio interference level.
2. Phone Condition: Mute on; Backlight off; Max Volume

Test Engineer : Nick Hu.



14. Uncertainty Assessment

The component of uncertainty may generally be categorized according to the methods used to evaluate them. The evaluation of uncertainty by the statistical analysis of a series of observations is termed a Type A evaluation of uncertainty. The evaluation of uncertainty by means other than the statistical analysis of a series of observation is termed a Type B evaluation of uncertainty. Each component of uncertainty, however evaluated, is represented by an estimated standard deviation, termed standard uncertainty, which is determined by the positive square root of the estimated variance.

The combined standard uncertainty of the measurement result represents the estimated standard deviation of the result. It is obtained by combining the individual standard uncertainties of both Type A and Type B evaluation using the usual “root-sum-squares” (RSS) methods of combining standard deviations by taking the positive square root of the estimated variances. Expanded uncertainty is a measure of uncertainty that defines an interval about the measurement result within which the measured value is confidently believed to lie. It is obtained by multiplying the combined standard uncertainty by a coverage factor. For purpose of this document, a coverage factor two is used, which corresponds to confidence interval of about 95 %. The DASy uncertainty Budget is showed in Table 12.1.

The judgment of conformity in the report is based on the measurement results excluding the measurement uncertainty.

Error Description	Uncertainty Value (±%)	Probability	Divisor	(Ci) E	(Ci) H	Standard Uncertainty (E) (±%)
Measurement System						
Probe Calibration	5.1	N	1	1	1	5.1
Axial Isotropy	4.7	R	1.732	1	1	2.7
Sensor Displacement	16.5	R	1.732	1	0.145	9.5
Boundary Effects	2.4	R	1.732	1	1	1.4
Phantom Boundary Effect	7.2	R	1.732	1	0	4.2
Linearity	4.7	R	1.732	1	1	2.7
Scaling with PMR calibration	10.0	R	1.732	1	1	5.8
System Detection Limit	1.0	R	1.732	1	1	0.6
Readout Electronics	0.3	N	1	1	1	0.3
Response Time	2.6	R	1.732	1	1	1.5
Integration Time	2.6	R	1.732	1	1	1.5
RF Ambient Conditions	3.0	R	1.732	1	1	1.7
RF Reflections	12.0	R	1.732	1	1	6.9
Probe Positioner	1.2	R	1.732	1	0.67	0.7
Probe Positioning	4.7	R	1.732	1	0.67	2.7
Extrap. and Interpolation	1.0	R	1.732	1	1	0.6
Test Sample Related						
Device Positioning Vertical	4.7	R	1.732	1	0.67	2.7
Device Positioning Lateral	1.0	R	1.732	1	1	0.6
Device Holder and Phantom	2.4	R	1.732	1	1	1.4
Power Drift	5.0	R	1.732	1	1	2.9
Phantom and Setup Related						
Phantom Thickness	2.4	R	1.732	1	0.67	1.4
Combined Std. Uncertainty						16.4%
Coverage Factor for 95 %						K=2
Expanded STD Uncertainty						32.7%

Table 12.1 Uncertainty Budget of HAC free field assessment
Remark:

Worst-Case uncertainty budget for HAC free field assessment according to ANSIC63.19 [1], [2]. The budget is valid for the frequency range 700 MHz - 3 GHz and represents a worst case analysis.



15. References

- [1] ANSI C63.19-2011, "American National Standard for Methods of Measurement of Compatibility between Wireless Communications Devices and Hearing Aids", 27 May 2011.
- [2] FCC KDB 285076 D01v05, "Equipment Authorization Guidance for Hearing Aid Compatibility", Sep 2017
- [3] FCC KDB 285076 D02v03, "Guidance for performing T-Coil tests for air interfaces supporting voice over IP (e.g., LTE and WiFi) to support CMRS based telephone services", Sep 2017
- [4] FCC KDB 285076 D03v01, "Hearing aid compatibility frequently asked questions", Sep 2017
- [5] SPEAG DASY System Handbook



Appendix A. Plots of System Performance Check

The plots are shown as follows.

HAC_E_Dipole_835

DUT: HAC-Dipole 835 MHz

Communication System: UID 0, CW; Frequency: 835 MHz; Duty Cycle: 1:1

Medium: Air Medium parameters used: $\sigma = 0$ S/m, $\epsilon_r = 1$; $\rho = 0$ kg/m³

Ambient Temperature : 23.5 °C

DASY5 Configuration:

- Probe: EF3DV3 - SN4050; ConvF(1, 1, 1); Calibrated: 2020.1.24
- Sensor-Surface: (Fix Surface)
- Electronics: DAE4 Sn690; Calibrated: 2020.3.26
- Phantom: HAC Test Arch with AMCC; Type: SD HAC P01 BA;
- Measurement SW: DASY52, Version 52.10 (4); SEMCAD X Version 14.6.14 (7483)

E Scan - measurement distance from the probe sensor center to CD835 = 15mm/Hearing Aid Compatibility Test at 15mm distance (41x361x1): Interpolated grid:

dx=0.5000 mm, dy=0.5000 mm

Device Reference Point: 0, 0, -6.3 mm

Reference Value = 126.5 V/m; Power Drift = -0.10 dB

PMR not calibrated. PMF = 1.000 is applied.

E-field emissions = 110.1 V/m

Average value of Total=(110.3+107.5)/2 = 108.9 V/m

PMF scaled E-field

Grid 1 M4 109.7 V/m	Grid 2 M4 110.3 V/m	Grid 3 M4 104.5 V/m
Grid 4 M4 62.31 V/m	Grid 5 M4 62.42 V/m	Grid 6 M4 59.95 V/m
Grid 7 M4 107.1 V/m	Grid 8 M4 107.5 V/m	Grid 9 M4 104.3 V/m

Cursor:

Total = 110.1 V/m

E Category: M4

Location: 2, -72, 9.7 mm

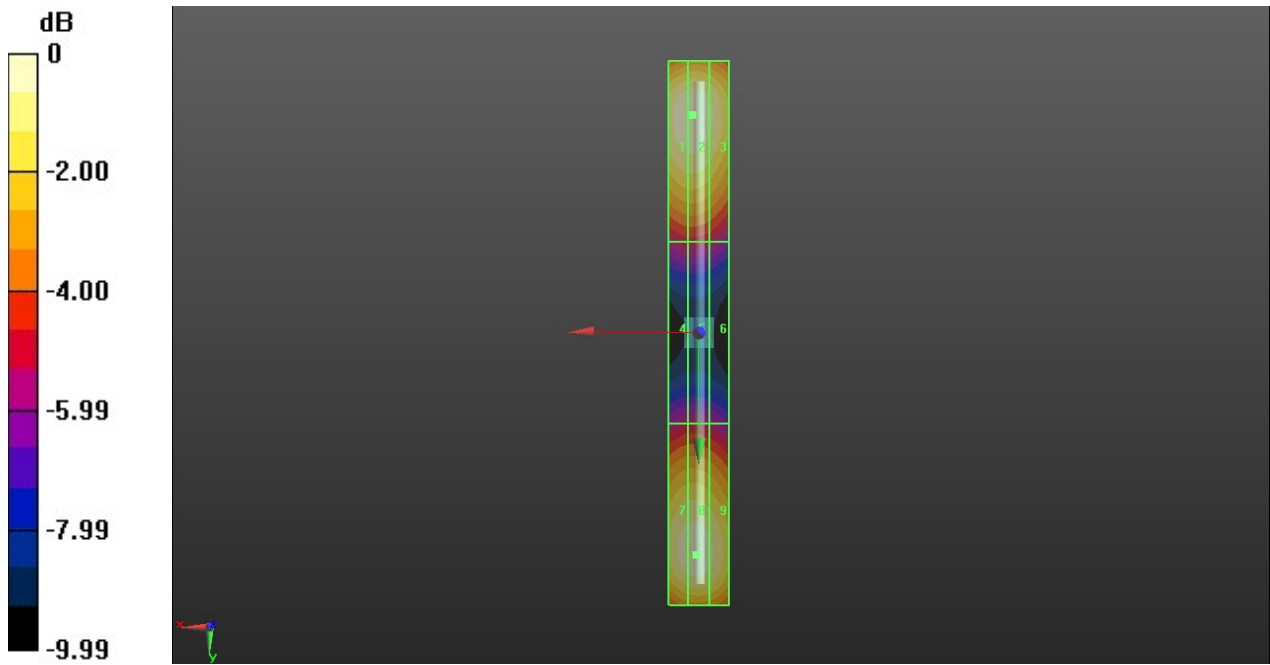

0 dB = 110.1 V/m = 40.84 dBV/m

HAC_E_Dipole_1880

DUT: HAC-Dipole 1880 MHz

Communication System: UID 0, CW; Frequency: 1880 MHz; Duty Cycle: 1:1

Medium: Air Medium parameters used: $\sigma = 0$ S/m, $\epsilon_r = 1$; $\rho = 0$ kg/m³

Ambient Temperature : 23.2 °C

DASY5 Configuration:

- Probe: EF3DV3 - SN4050; ConvF(1, 1, 1); Calibrated: 2020.1.24
- Sensor-Surface: (Fix Surface)
- Electronics: DAE4 Sn690; Calibrated: 2020.3.26
- Phantom: HAC Test Arch with AMCC; Type: SD HAC P01 BA;
- Measurement SW: DASY52, Version 52.10 (4); SEMCAD X Version 14.6.14 (7483)

E Scan - measurement distance from the probe sensor center to CD1880 = 15mm/Hearing Aid Compatibility Test at 15mm distance (41x181x1): Interpolated grid:

dx=0.5000 mm, dy=0.5000 mm

Device Reference Point: 0, 0, -6.3 mm

Reference Value = 166.8 V/m; Power Drift = 0.03 dB

PMR not calibrated. PMF = 1.000 is applied.

E-field emissions = 90.82 V/m

Average value of Total=(87.21+90.87)/2 = 89.04 V/m

PMF scaled E-field

Grid 1 M3 86.93 V/m	Grid 2 M3 87.21 V/m	Grid 3 M3 83.37 V/m
Grid 4 M3 64.99 V/m	Grid 5 M3 65.09 V/m	Grid 6 M3 64.28 V/m
Grid 7 M3 88.75 V/m	Grid 8 M3 90.87 V/m	Grid 9 M3 88.73 V/m

Cursor:

Total = 90.82 V/m

E Category: M3

Location: 0, 33.5, 9.7 mm

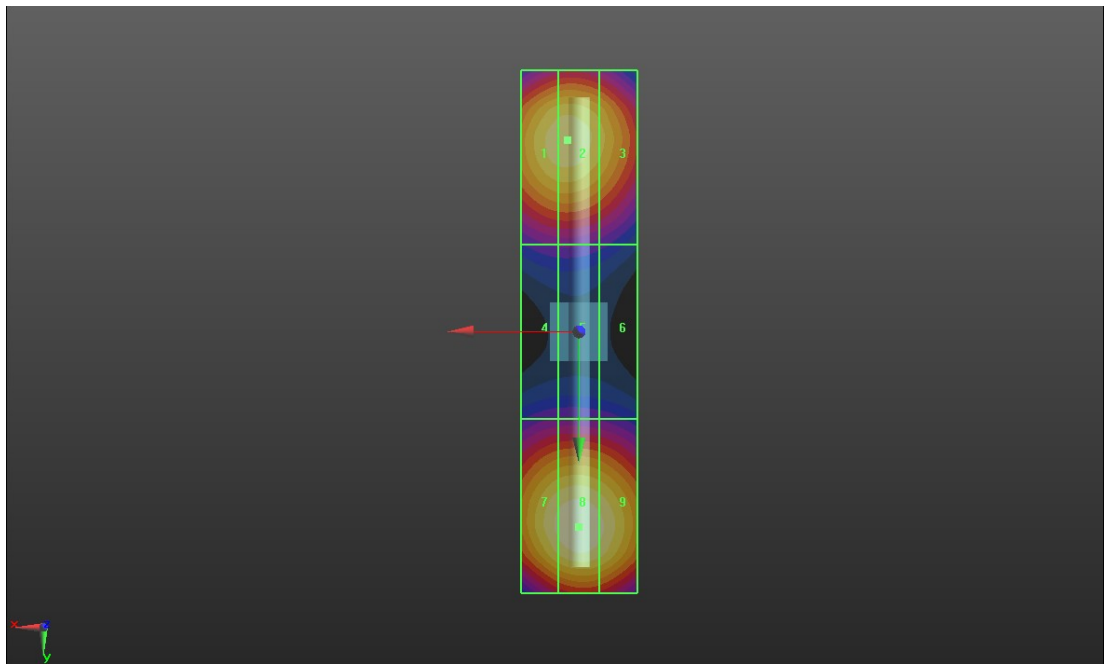
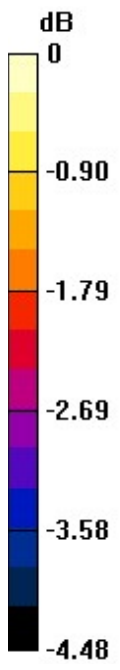

0 dB = 90.82 V/m = 39.16 dBV/m

HAC_E_Dipole_2600

DUT: HAC-Dipole 2600 MHz

Communication System: UID 0, CW (0); Frequency: 2600 MHz; Duty Cycle: 1:1

Medium: Air Medium parameters used: $\sigma = 0$ S/m, $\epsilon_r = 1$; $\rho = 0$ kg/m³

Ambient Temperature : 23.4 °C

DASY5 Configuration:

- Probe: EF3DV3 - SN4050; ConvF(1, 1, 1); Calibrated: 2019.1.24
- Sensor-Surface: (Fix Surface)
- Electronics: DAE4 Sn690; Calibrated: 2020.3.26
- Phantom: HAC Test Arch with AMCC; Type: SD HAC P01 BA;
- Measurement SW: DASY52, Version 52.10 (4); SEMCAD X Version 14.6.14 (7483)

E Scan - measurement distance from the probe sensor center to CD2600 = 15mm/Hearing Aid Compatibility Test at 15mm distance (41x181x1): Interpolated grid:

dx=0.5000 mm, dy=0.5000 mm

Device Reference Point: 0, 0, -6.3 mm

Reference Value = 73.73 V/m; Power Drift = 0.02 dB

PMR not calibrated. PMF = 1.000 is applied.

E-field emissions = 88.55 V/m

Average value of Total=(87.12+88.64)/2 = 87.88 V/m

PMF scaled E-field

Grid 1 M3 86.15 V/m	Grid 2 M3 87.12 V/m	Grid 3 M3 84.88 V/m
Grid 4 M3 80.85 V/m	Grid 5 M3 81.45 V/m	Grid 6 M3 79.78 V/m
Grid 7 M3 87.76 V/m	Grid 8 M3 88.64 V/m	Grid 9 M3 85.73 V/m

Cursor:

Total = 88.55 V/m

E Category: M3

Location: 1, 23.5, 9.7 mm

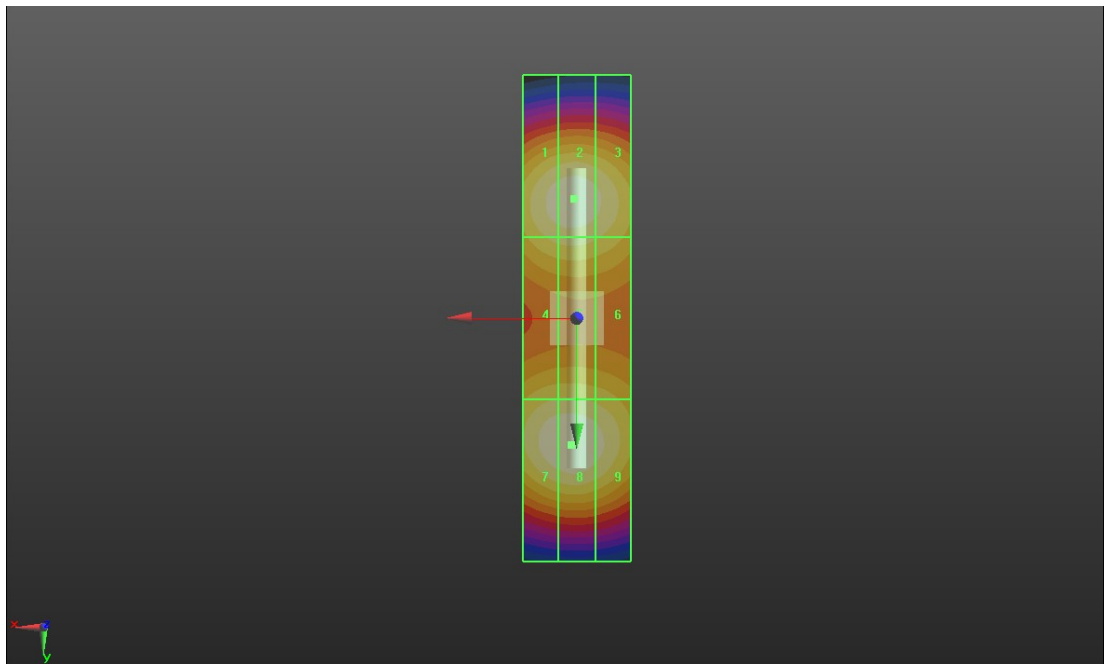
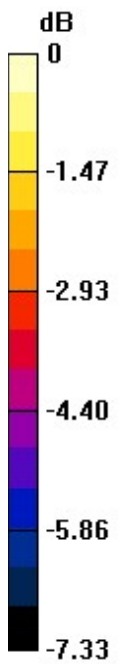

0 dB = 88.55 V/m = 38.94 dBV/m



Appendix B. Plots of RF Emission Measurement

The plots are shown as follows.

1 HAC RF GSM850_Voice_Ch128

Communication System: UID 10021 - DAC, GSM-FDD (TDMA, GMSK); Frequency: 824.2 MHz; Duty Cycle: 1:8.6896

Medium: Air Medium parameters used: $\sigma = 0$ S/m, $\epsilon_r = 1$; $\rho = 0$ kg/m³

Ambient Temperature : 23.5 °C

DASY5 Configuration:

- Probe: EF3DV3 - SN4050; ConvF(1, 1, 1); Calibrated: 2020.1.24
- Sensor-Surface: (Fix Surface)
- Electronics: DAE4 Sn690; Calibrated: 2020.3.26
- Phantom: HAC Test Arch with AMCC; Type: SD HAC P01 BA;
- Measurement SW: DASY52, Version 52.10 (4); SEMCAD X Version 14.6.14 (7483)

Ch128/Hearing Aid Compatibility Test (101x101x1): Interpolated grid: dx=0.5000 mm, dy=0.5000 mm

Device Reference Point: 0, 0, -6.3 mm

Reference Value = 72.42 V/m; Power Drift = -0.18 dB

Applied MIF = 3.63 dB

RF audio interference level = 38.59 dBV/m

Emission category: M4

MIF scaled E-field

Grid 1 M4 37.45 dBV/m	Grid 2 M4 37.61 dBV/m	Grid 3 M4 36.85 dBV/m
Grid 4 M4 37.9 dBV/m	Grid 5 M4 37.97 dBV/m	Grid 6 M4 37.16 dBV/m
Grid 7 M4 38.49 dBV/m	Grid 8 M4 38.59 dBV/m	Grid 9 M4 37.48 dBV/m

Cursor:

Total = 38.59 dBV/m

E Category: M4

Location: 5, 25, 8.7 mm

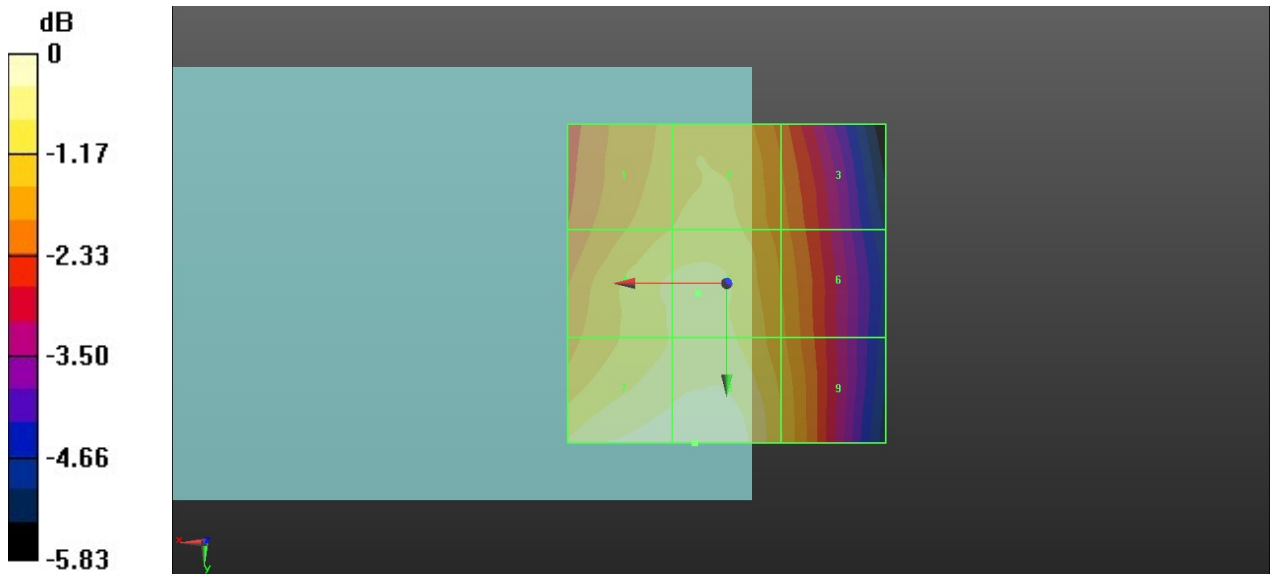

0 dB = 85.03 V/m = 38.59 dBV/m

2 HAC RF GSM850_Voice_Ch189

Communication System: UID 10021 - DAC, GSM-FDD (TDMA, GMSK); Frequency: 836.4 MHz; Duty Cycle: 1:8.6896

Medium: Air Medium parameters used: $\sigma = 0$ S/m, $\epsilon_r = 1$; $\rho = 0$ kg/m³

Ambient Temperature : 23.5 °C

DASY5 Configuration:

- Probe: EF3DV3 - SN4050; ConvF(1, 1, 1); Calibrated: 2020.1.24
- Sensor-Surface: (Fix Surface)
- Electronics: DAE4 Sn690; Calibrated: 2020.3.26
- Phantom: HAC Test Arch with AMCC; Type: SD HAC P01 BA;
- Measurement SW: DASY52, Version 52.10 (4); SEMCAD X Version 14.6.14 (7483)

Ch189/Hearing Aid Compatibility Test (101x101x1): Interpolated grid: dx=0.5000 mm, dy=0.5000 mm

Device Reference Point: 0, 0, -6.3 mm

Reference Value = 68.26 V/m; Power Drift = -0.09 dB

Applied MIF = 3.63 dB

RF audio interference level = 38.11 dBV/m

Emission category: M4

MIF scaled E-field

Grid 1 M4 36.8 dBV/m	Grid 2 M4 37 dBV/m	Grid 3 M4 36.26 dBV/m
Grid 4 M4 37.28 dBV/m	Grid 5 M4 37.4 dBV/m	Grid 6 M4 36.7 dBV/m
Grid 7 M4 38.06 dBV/m	Grid 8 M4 38.11 dBV/m	Grid 9 M4 37.16 dBV/m

Cursor:

Total = 38.11 dBV/m

E Category: M4

Location: 1.5, 25, 8.7 mm

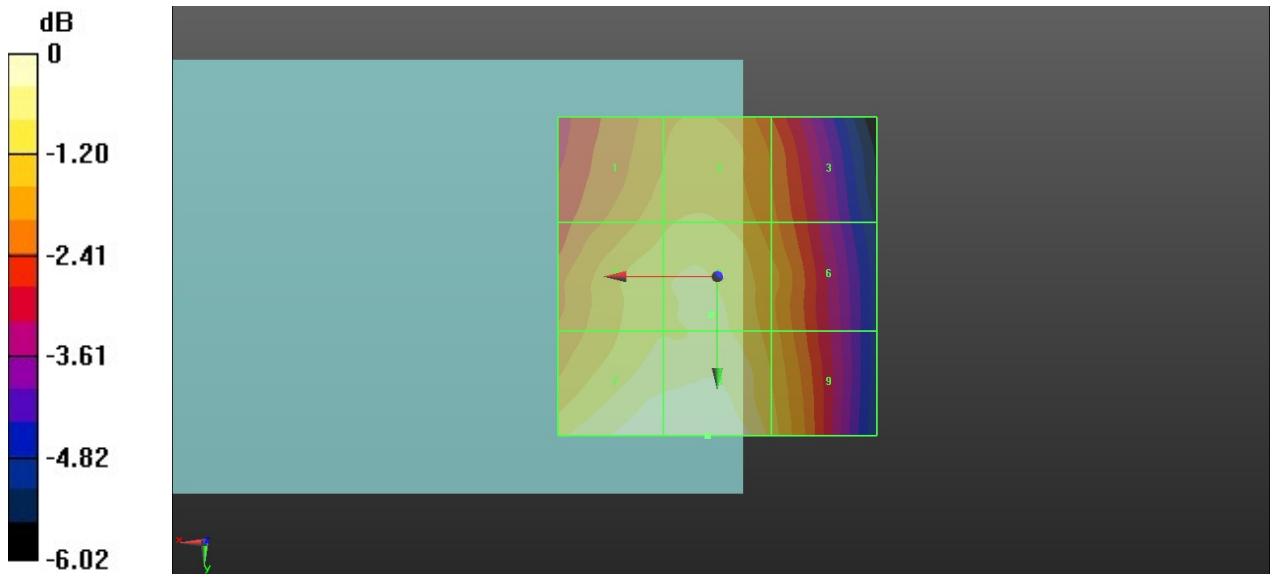

0 dB = 80.47 V/m = 38.11 dBV/m

3 HAC RF GSM850_Voice_Ch251

Communication System: UID 10021 - DAC, GSM-FDD (TDMA, GMSK); Frequency: 848.8 MHz; Duty Cycle: 1:8.6896

Medium: Air Medium parameters used: $\sigma = 0$ S/m, $\epsilon_r = 1$; $\rho = 0$ kg/m³

Ambient Temperature : 23.5 °C

DASY5 Configuration:

- Probe: EF3DV3 - SN4050; ConvF(1, 1, 1); Calibrated: 2020.1.24
- Sensor-Surface: (Fix Surface)
- Electronics: DAE4 Sn690; Calibrated: 2020.3.26
- Phantom: HAC Test Arch with AMCC; Type: SD HAC P01 BA;
- Measurement SW: DASY52, Version 52.10 (4); SEMCAD X Version 14.6.14 (7483)

Ch251/Hearing Aid Compatibility Test (101x101x1): Interpolated grid: dx=0.5000 mm, dy=0.5000 mm

Device Reference Point: 0, 0, -6.3 mm

Reference Value = 66.76 V/m; Power Drift = -0.09 dB

Applied MIF = 3.63 dB

RF audio interference level = 37.22 dBV/m

Emission category: M4

MIF scaled E-field

Grid 1 M4 36.07 dBV/m	Grid 2 M4 36.54 dBV/m	Grid 3 M4 36.23 dBV/m
Grid 4 M4 36.53 dBV/m	Grid 5 M4 36.92 dBV/m	Grid 6 M4 36.37 dBV/m
Grid 7 M4 36.92 dBV/m	Grid 8 M4 37.22 dBV/m	Grid 9 M4 36.43 dBV/m

Cursor:

Total = 37.22 dBV/m

E Category: M4

Location: 1.5, 25, 8.7 mm

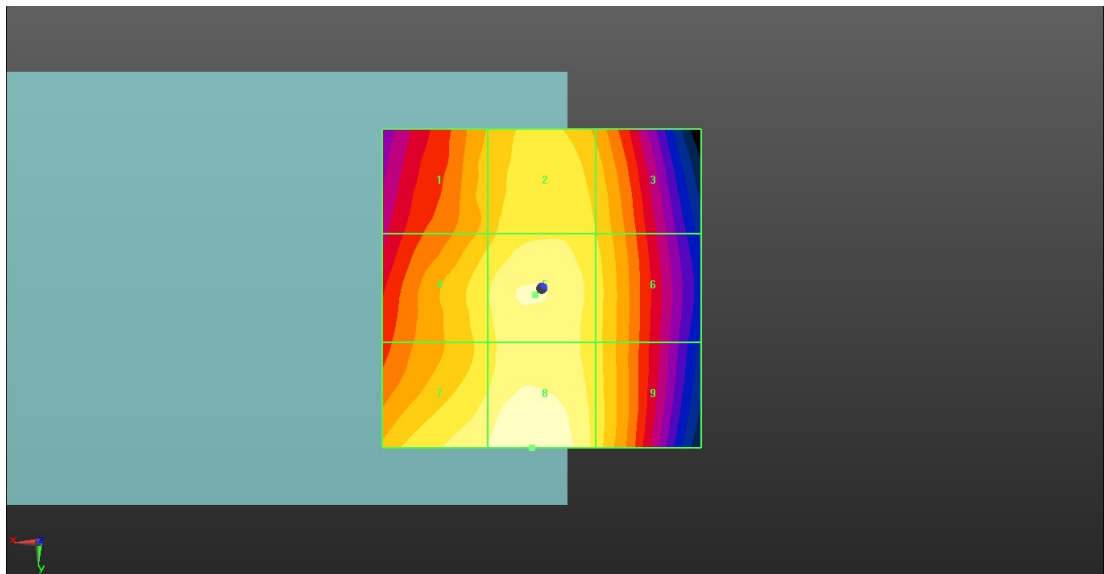
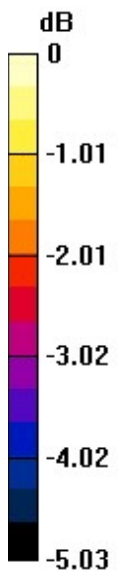

0 dB = 72.64 V/m = 37.22 dBV/m

4 HAC RF GSM1900_Voice_Ch512

Communication System: UID 10021 - DAC, GSM-FDD (TDMA, GMSK); Frequency: 1850.2 MHz; Duty Cycle: 1:8.6896

Medium: Air Medium parameters used: $\sigma = 0$ S/m, $\epsilon_r = 1$; $\rho = 0$ kg/m³

Ambient Temperature : 23.2 °C

DASY5 Configuration:

- Probe: EF3DV3 - SN4050; ConvF(1, 1, 1) @ 1850.2 MHz; Calibrated: 2020.1.24
- Sensor-Surface: (Fix Surface)
- Electronics: DAE4 Sn690; Calibrated: 2020.3.26
- Phantom: HAC Test Arch with AMCC; Type: SD HAC P01 BA;
- Measurement SW: DASY52, Version 52.10 (4); SEMCAD X Version 14.6.14 (7483)

Ch512/Hearing Aid Compatibility Test (101x101x1): Interpolated grid: dx=0.5000 mm, dy=0.5000 mm

Device Reference Point: 0, 0, -6.3 mm

Reference Value = 3.784 V/m; Power Drift = -0.01 dB

Applied MIF = 3.63 dB

RF audio interference level = 26.63 dBV/m

Emission category: M4

MIF scaled E-field

Grid 1 M4 26.21 dBV/m	Grid 2 M4 26.63 dBV/m	Grid 3 M4 25.41 dBV/m
Grid 4 M4 19.46 dBV/m	Grid 5 M4 20.34 dBV/m	Grid 6 M4 19.96 dBV/m
Grid 7 M4 25.88 dBV/m	Grid 8 M4 26.5 dBV/m	Grid 9 M4 25.88 dBV/m

Cursor:

Total = 26.63 dBV/m

E Category: M4

Location: 3, -25, 8.7 mm

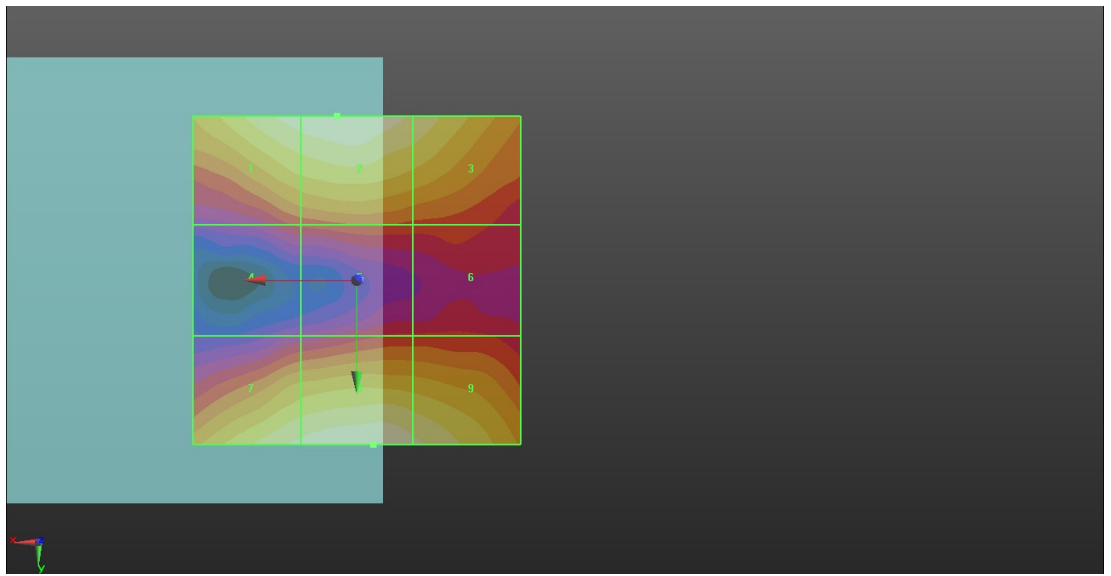
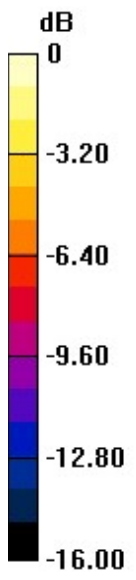

0 dB = 21.45 V/m = 26.63 dBV/m

5 HAC RF GSM1900_Voice_Ch661

Communication System: UID 10023 - DAC, GPRS-FDD (TDMA, GMSK, TN 0); Frequency: 1880 MHz; Duty Cycle: 1:8.6896

Medium: Air Medium parameters used: $\sigma = 0$ S/m, $\epsilon_r = 1$; $\rho = 0$ kg/m³

Ambient Temperature : 23.2 °C

DASY5 Configuration:

- Probe: EF3DV3 - SN4050; ConvF(1, 1, 1) @ 1880 MHz; Calibrated: 2020.1.24
- Sensor-Surface: (Fix Surface)
- Electronics: DAE4 Sn690; Calibrated: 2020.3.26
- Phantom: HAC Test Arch with AMCC; Type: SD HAC P01 BA;
- Measurement SW: DASY52, Version 52.10 (4); SEMCAD X Version 14.6.14 (7483)

Ch661/Hearing Aid Compatibility Test (101x101x1): Interpolated grid: dx=0.5000 mm, dy=0.5000 mm

Device Reference Point: 0, 0, -6.3 mm

Reference Value = 5.865 V/m; Power Drift = -0.04 dB

Applied MIF = 3.63 dB

RF audio interference level = 27.09 dBV/m

Emission category: M4

MIF scaled E-field

Grid 1 M4 21.81 dBV/m	Grid 2 M4 22.26 dBV/m	Grid 3 M4 21.02 dBV/m
Grid 4 M4 20.63 dBV/m	Grid 5 M4 21.94 dBV/m	Grid 6 M4 21.81 dBV/m
Grid 7 M4 26.54 dBV/m	Grid 8 M4 27.09 dBV/m	Grid 9 M4 26.45 dBV/m

Cursor:

Total = 27.09 dBV/m

E Category: M4

Location: -2.5, 25, 8.7 mm

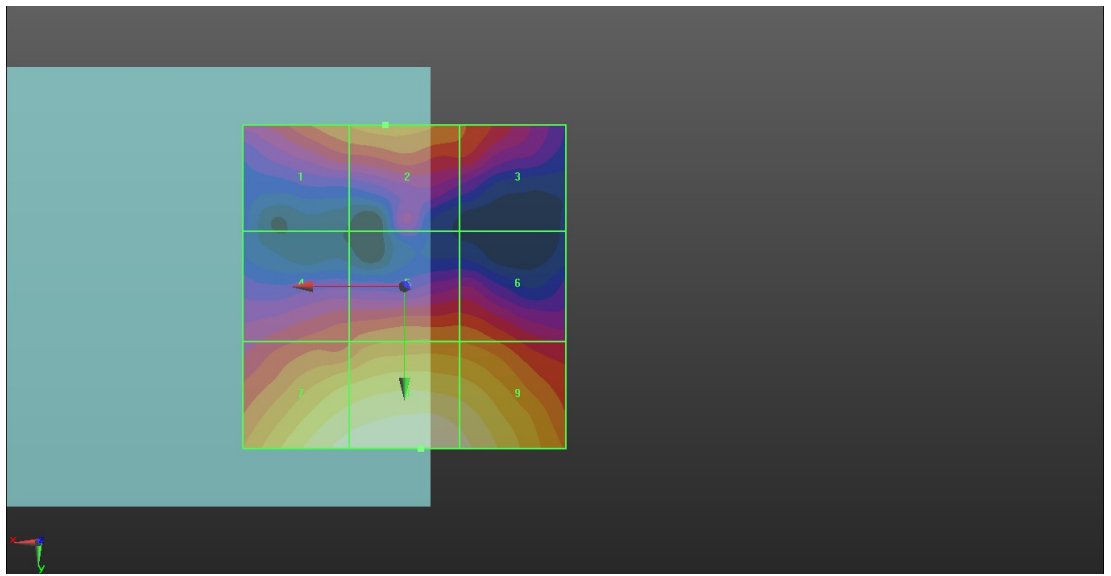
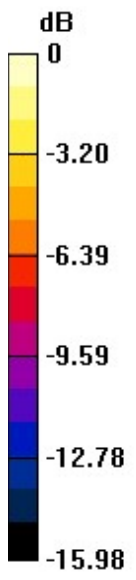

0 dB = 22.61 V/m = 27.09 dBV/m

6 HAC RF GSM1900_Voice_Ch810

Communication System: UID 10021 - DAC, GSM-FDD (TDMA, GMSK); Frequency: 1909.8 MHz; Duty Cycle: 1:8.6896

Medium: Air Medium parameters used: $\sigma = 0$ S/m, $\epsilon_r = 1$; $\rho = 0$ kg/m³

Ambient Temperature : 23.2 °C

DASY5 Configuration:

- Probe: EF3DV3 - SN4050; ConvF(1, 1, 1) @ 1909.8 MHz; Calibrated: 2020.1.24
- Sensor-Surface: (Fix Surface)
- Electronics: DAE4 Sn690; Calibrated: 2020.3.26
- Phantom: HAC Test Arch with AMCC; Type: SD HAC P01 BA;
- Measurement SW: DASY52, Version 52.10 (4); SEMCAD X Version 14.6.14 (7483)

Ch810/Hearing Aid Compatibility Test (101x101x1): Interpolated grid: dx=0.5000 mm, dy=0.5000 mm

Device Reference Point: 0, 0, -6.3 mm

Reference Value = 10.92 V/m; Power Drift = -0.08 dB

Applied MIF = 3.63 dB

RF audio interference level = 30.48 dBV/m

Emission category: M3

MIF scaled E-field

Grid 1 M3 30.48 dBV/m	Grid 2 M4 12.78 dBV/m	Grid 3 M4 11.91 dBV/m
Grid 4 M3 30.15 dBV/m	Grid 5 M4 23.15 dBV/m	Grid 6 M4 11.54 dBV/m
Grid 7 M4 29.47 dBV/m	Grid 8 M4 23.49 dBV/m	Grid 9 M4 12.54 dBV/m

Cursor:

Total = 30.48 dBV/m

E Category: M3

Location: 16.5, -10, 8.7 mm

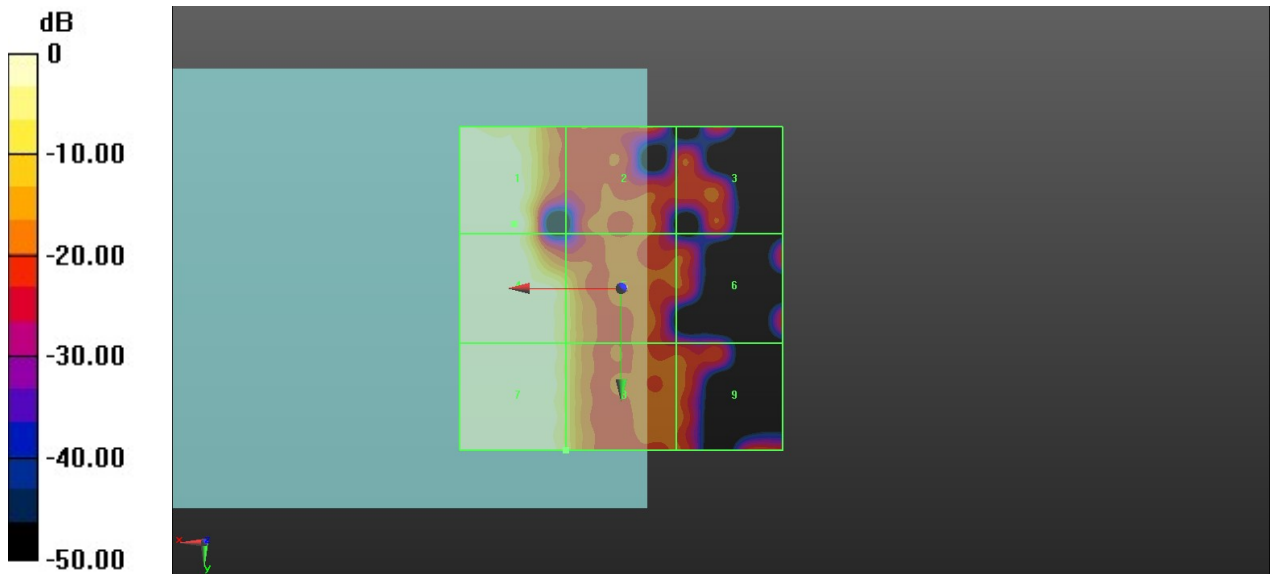

0 dB = 33.43 V/m = 30.48 dBV/m

7 HAC RF CDMA2000 BC0_RC1_SO3_Ch1013

Communication System: CDMA2000,RC1,SO3,1/8th Rate 25 fr.: 824.7 MHz;Duty Cycle: 1:17.7419

Medium: Air Medium parameters used: $\sigma = 0$ S/m, $\epsilon_r = 1$; $\rho = 0$ kg/m³

Ambient Temperature : 23.5 °C

DASY5 Configuration:

- Probe: EF3DV3 - SN4050; ConvF(1, 1, 1) @ 824.7 MHz; Calibrated: 2020.1.24
- Sensor-Surface: (Fix Surface)
- Electronics: DAE4 Sn690; Calibrated: 2020.3.26
- Phantom: HAC Test Arch with AMCC; Type: SD HAC P01 BA;
- Measurement SW: DASY52, Version 52.10 (4); SEMCAD X Version 14.6.14 (7483)

Ch1013/Hearing Aid Compatibility Test (101x101x1): Interpolated grid: dx=0.5000 mm, dy=0.5000 mm

Device Reference Point: 0, 0, -6.3 mm

Reference Value = 30.27 V/m; Power Drift = 0.10 dB

Applied MIF = 3.26 dB

RF audio interference level = 25.67 dBV/m

Emission category: M4

MIF scaled E-field

Grid 1 M4 24.12 dBV/m	Grid 2 M4 25.17 dBV/m	Grid 3 M4 25.06 dBV/m
Grid 4 M4 24.73 dBV/m	Grid 5 M4 25.32 dBV/m	Grid 6 M4 25.05 dBV/m
Grid 7 M4 25.63 dBV/m	Grid 8 M4 25.67 dBV/m	Grid 9 M4 24.68 dBV/m

Cursor:

Total = 25.67 dBV/m

E Category: M4

Location: 6, 25, 8.7 mm

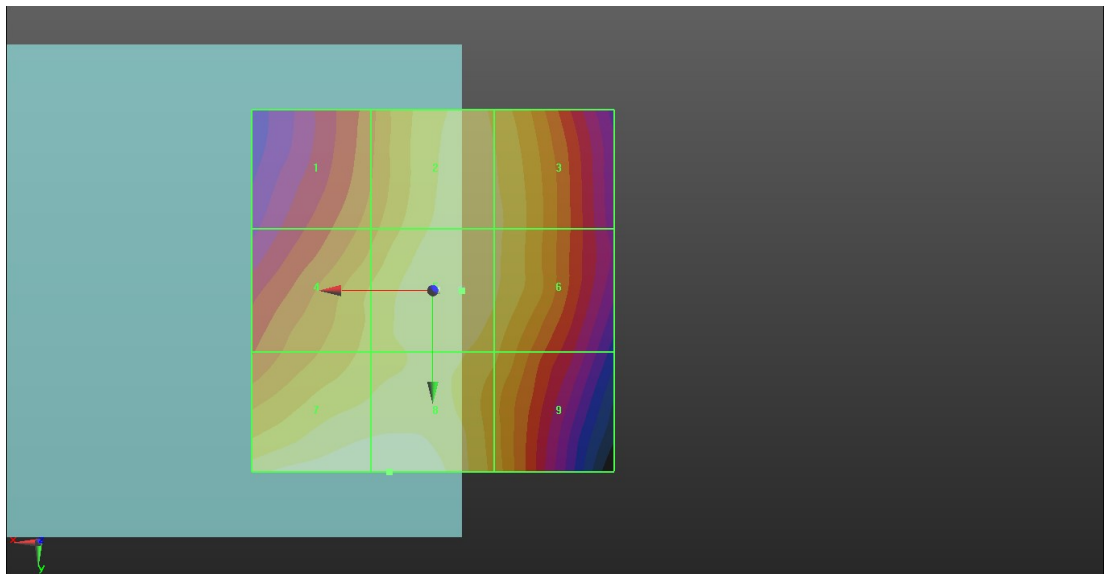
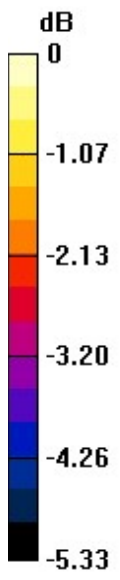

0 dB = 19.21 V/m = 25.67 dBV/m

8 HAC RF CDMA2000 BC0_RC1_SO3_Ch384

Communication System: CDMA2000,RC1,SO3,1/8th Rate 25 fr.: 836.52 MHz;Duty Cycle: 1:17.7419

Medium: Air Medium parameters used: $\sigma = 0$ S/m, $\epsilon_r = 1$; $\rho = 0$ kg/m³

Ambient Temperature : 23.5 °C

DASY5 Configuration:

- Probe: EF3DV3 - SN4050; ConvF(1, 1, 1) @ 836.52 MHz; Calibrated: 2020.1.24
- Sensor-Surface: (Fix Surface)
- Electronics: DAE4 Sn690; Calibrated: 2020.3.26
- Phantom: HAC Test Arch with AMCC; Type: SD HAC P01 BA;
- Measurement SW: DASY52, Version 52.10 (4); SEMCAD X Version 14.6.14 (7483)

Ch384/Hearing Aid Compatibility Test (101x101x1): Interpolated grid: dx=0.5000 mm, dy=0.5000 mm

Device Reference Point: 0, 0, -6.3 mm

Reference Value = 27.34 V/m; Power Drift = 0.04 dB

Applied MIF = 3.26 dB

RF audio interference level = 26.60 dBV/m

Emission category: M4

MIF scaled E-field

Grid 1 M4 24.37 dBV/m	Grid 2 M4 24.59 dBV/m	Grid 3 M4 23.26 dBV/m
Grid 4 M4 25.46 dBV/m	Grid 5 M4 25.61 dBV/m	Grid 6 M4 25.02 dBV/m
Grid 7 M4 26.58 dBV/m	Grid 8 M4 26.6 dBV/m	Grid 9 M4 25.41 dBV/m

Cursor:

Total = 26.60 dBV/m

E Category: M4

Location: 5.5, 25, 8.7 mm

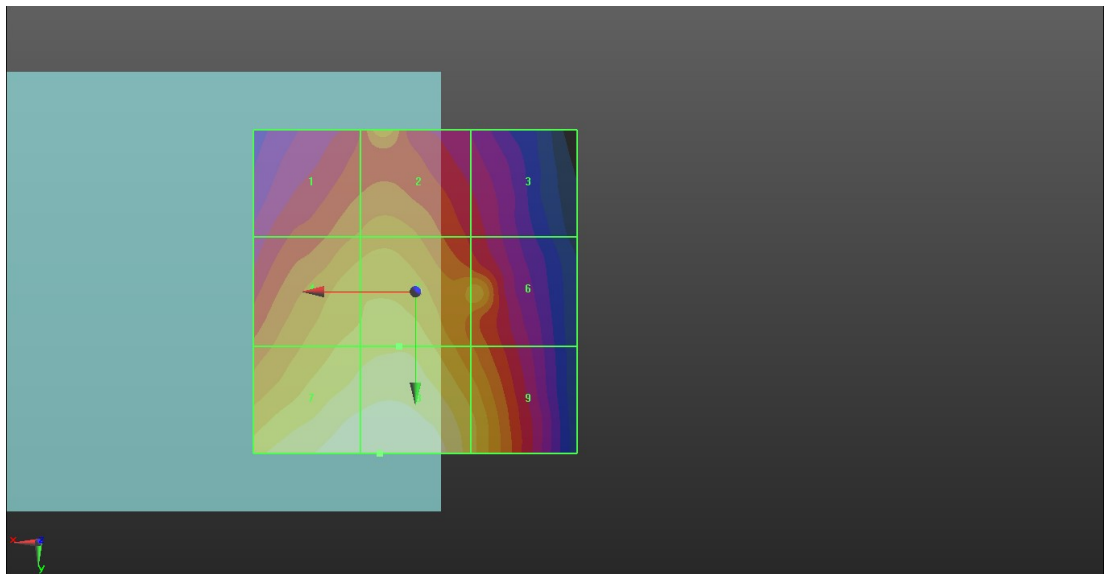
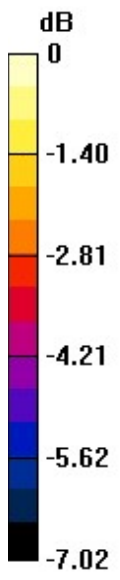

0 dB = 21.38 V/m = 26.60 dBV/m

9 HAC RF CDMA2000 BC0_RC1_SO3_Ch777

Communication System: CDMA2000,RC1,SO3,1/8th Rate 25 fr.: 848.31 MHz;Duty Cycle: 1:17.7419

Medium: Air Medium parameters used: $\sigma = 0$ S/m, $\epsilon_r = 1$; $\rho = 0$ kg/m³

Ambient Temperature : 23.5 °C

DASY5 Configuration:

- Probe: EF3DV3 - SN4050; ConvF(1, 1, 1) @ 848.31 MHz; Calibrated: 2020.1.24
- Sensor-Surface: (Fix Surface)
- Electronics: DAE4 Sn690; Calibrated: 2020.3.26
- Phantom: HAC Test Arch with AMCC; Type: SD HAC P01 BA;
- Measurement SW: DASY52, Version 52.10 (4); SEMCAD X Version 14.6.14 (7483)

Ch777/Hearing Aid Compatibility Test (101x101x1): Interpolated grid: dx=0.5000 mm, dy=0.5000 mm

Device Reference Point: 0, 0, -6.3 mm

Reference Value = 42.91 V/m; Power Drift = -0.03 dB

Applied MIF = 3.26 dB

RF audio interference level = 26.85 dBV/m

Emission category: M4

MIF scaled E-field

Grid 1 M4 25.24 dBV/m	Grid 2 M4 25.46 dBV/m	Grid 3 M4 24.25 dBV/m
Grid 4 M4 25.84 dBV/m	Grid 5 M4 26.13 dBV/m	Grid 6 M4 25.28 dBV/m
Grid 7 M4 26.52 dBV/m	Grid 8 M4 26.85 dBV/m	Grid 9 M4 26 dBV/m

Cursor:

Total = 26.85 dBV/m

E Category: M4

Location: 2.5, 25, 8.7 mm

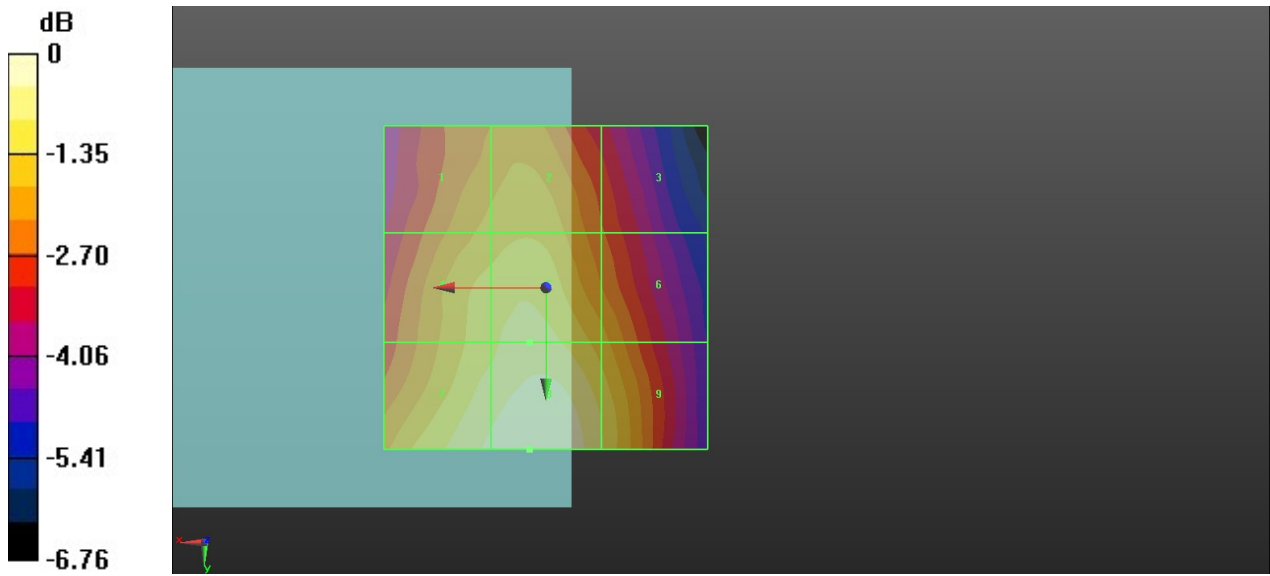

0 dB = 22.00 V/m = 26.85 dBV/m

10 HAC RF CDMA2000 BC1_RC1_SO3_Ch25

Communication System: CDMA2000,RC1,SO3,1/8th Rate 25 fr.: 1851.25 MHz;Duty Cycle: 1:17.7419

Medium: Air Medium parameters used: $\sigma = 0$ S/m, $\epsilon_r = 1$; $\rho = 0$ kg/m³

Ambient Temperature : 23.2 °C

DASY5 Configuration:

- Probe: EF3DV3 - SN4050; ConvF(1, 1, 1) @ 1851.25 MHz; Calibrated: 2020.1.24
- Sensor-Surface: (Fix Surface)
- Electronics: DAE4 Sn690; Calibrated: 2020.3.26
- Phantom: HAC Test Arch with AMCC; Type: SD HAC P01 BA;
- Measurement SW: DASY52, Version 52.10 (4); SEMCAD X Version 14.6.14 (7483)

Ch25/Hearing Aid Compatibility Test (101x101x1): Interpolated grid: dx=0.5000 mm, dy=0.5000 mm

Device Reference Point: 0, 0, -6.3 mm

Reference Value = 3.238 V/m; Power Drift = -0.09 dB

Applied MIF = 3.26 dB

RF audio interference level = 18.45 dBV/m

Emission category: M4

MIF scaled E-field

Grid 1 M4 16.75 dBV/m	Grid 2 M4 17.15 dBV/m	Grid 3 M4 16.41 dBV/m
Grid 4 M4 11.69 dBV/m	Grid 5 M4 12.45 dBV/m	Grid 6 M4 11.74 dBV/m
Grid 7 M4 18.13 dBV/m	Grid 8 M4 18.45 dBV/m	Grid 9 M4 17.51 dBV/m

Cursor:

Total = 18.45 dBV/m

E Category: M4

Location: 0.5, 25, 8.7 mm

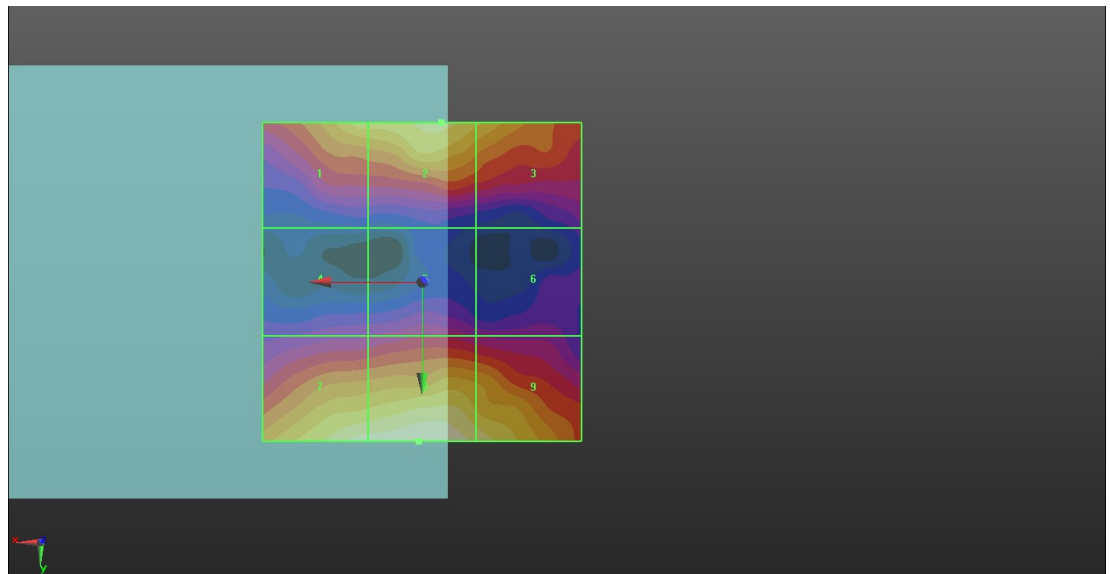
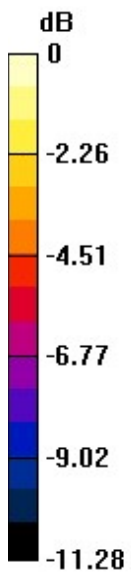

0 dB = 8.367 V/m = 18.45 dBV/m